

<b>Subject:</b>  2026 CX-5 - SERVICE CAUTIONS FOR NEW AND REVISED FEATURES	<b>Service Alert No.:</b> SA-006/26
	<b>Last Issued :</b> 02/02/2026

## BULLETIN NOTES

### APPLICABLE MODEL(S)/VINS

2026 CX-5

### DESCRIPTION

The 2026 CX-5 has new and revised features that are different from previous models and may be difficult to understand. This Service Alert provides valuable information to support potential dealer and customer concerns.



## Section Contents

---

[New Features](#)

[Google Built-In](#)

**CONSUMER NOTICE:** The information and instructions in this bulletin are intended for use by skilled technicians. Mazda technicians utilize the proper tools/ equipment and take training to correctly and safely maintain Mazda vehicles. These instructions should not be performed by "do-it-yourselfers." Customers should not assume this bulletin applies to their vehicle or that their vehicle will develop the described concern. To determine if the information applies, customers should contact their nearest authorized Mazda dealership. Mazda North American Operations reserves the right to alter the specifications and contents of this bulletin without obligation or advance notice. All rights reserved. No part of this bulletin may be reproduced in any form or by any means, electronic or mechanical---including photocopying and recording and the use of any kind of information storage and retrieval system ---without permission in writing.

- With Google built-in you can use content without operating your smartphone.
- With Google built-in, applications such as Google Assistant, Google Maps and more via Google Play are seamlessly integrated. Refer to the cars with Google built-in help center for details. (See [Google](#).)
- The navigation function can be used via Google Maps.
- Applications and vehicle functions can be controlled by voice via Google Gemini or Google Assistant.
- Additional applications can be Installed via Google Play.
- With Google built-in, connectivity is necessary via the Wi-Fi client function or the Connected Service function.

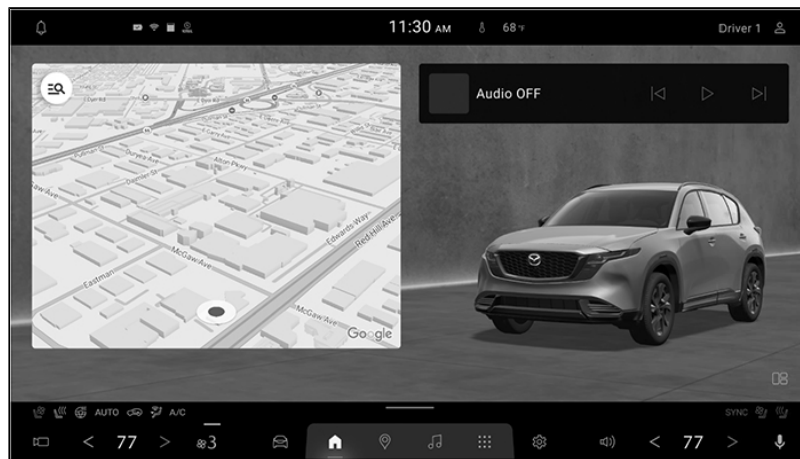









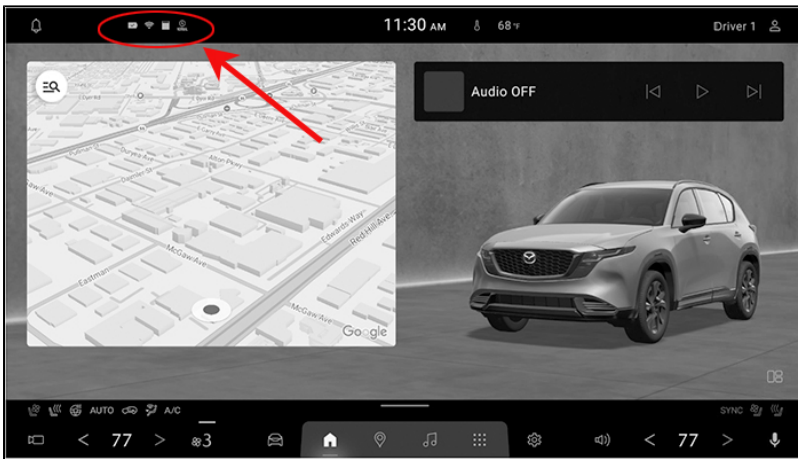

### Service Information

- Go to MGSS [Google built-in](#)
- See [Google](#)

### Google Built-In Status Bar

**CONSUMER NOTICE:** The information and instructions in this bulletin are intended for use by skilled technicians. Mazda technicians utilize the proper tools/ equipment and take training to correctly and safely maintain Mazda vehicles. These instructions should not be performed by "do-it-yourselfers." Customers should not assume this bulletin applies to their vehicle or that their vehicle will develop the described concern. To determine if the information applies, customers should contact their nearest authorized Mazda dealership. Mazda North American Operations reserves the right to alter the specifications and contents of this bulletin without obligation or advance notice. All rights reserved. No part of this bulletin may be reproduced in any form or by any means, electronic or mechanical---including photocopying and recording and the use of any kind of information storage and retrieval system ---without permission in writing.



	<p>If a Bluetooth® device is not connected or it is connected but the battery status cannot be obtained, the icon is displayed. The icon displays “ROAM” with roaming connected*1.</p>
	<p>If a Bluetooth® device is connected and the battery status can be obtained, the battery level is displayed. The icon displays “ROAM” with roaming connected*1.</p>
	<p>If you have not subscribed to the onboard communication unit, the icon is displayed.</p>
	<p>If you have already signed up for the onboard communication device, the communication status is displayed.</p>
	<p>If there is an OTA notification or while software is being downloaded or installed, the icon is displayed.</p>
	<p>If there is a service check-in notification, the icon is displayed.</p>
	<p>If there is a recall notification, the icon is displayed.</p>
	<p>The Qi*2 operation status is displayed.</p>
	<p>The Wi-Fi connection status is displayed.</p>

**CONSUMER NOTICE:** The information and instructions in this bulletin are intended for use by skilled technicians. Mazda technicians utilize the proper tools/ equipment and take training to correctly and safely maintain Mazda vehicles. These instructions should not be performed by "do-it-yourselfers." Customers should not assume this bulletin applies to their vehicle or that their vehicle will develop the described concern. To determine if the information applies, customers should contact their nearest authorized Mazda dealership. Mazda North American Operations reserves the right to alter the specifications and contents of this bulletin without obligation or advance notice. All rights reserved. No part of this bulletin may be reproduced in any form or by any means, electronic or mechanical--including photocopying and recording and the use of any kind of information storage and retrieval system ---without permission in writing.

\*1 For the roaming connection status, refer to the user instructions for your Bluetooth® device.  
\*2 For details on Qi, refer to the Owner's Manual.

### Service Information

See Owner's Manual --> Status Bar

## User Registration

### Creating a Profile

When using Mazda Connect for the first time, the initial setup flow is displayed.

Select the language you want to use in Mazda Connect and follow the instructions on the initial setup flow screen display to proceed with the setup.

### Language Selection

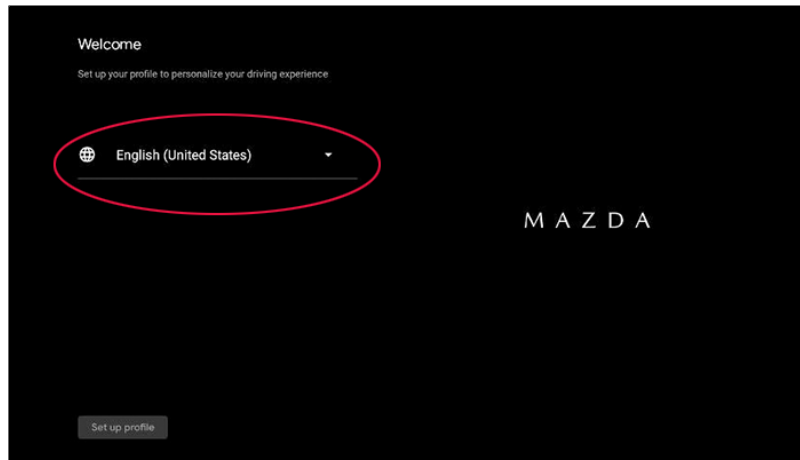

### Mazda Connected Vehicle Services Setup

There are several types of connected services available via Mazda Connect. Some services may require you to download the MyMazda app to your smartphone and subscribe to the services, while others may require you to pair your smartphone to the vehicle via Bluetooth®. In addition, on a regular basis your vehicle will automatically transmit certain geo-location, driving behavior data, and vehicle health information to Mazda for product quality, data analysis, research, and product development. Using the QR codes or URLs below, refer to the Connected Service Owner's Manual and Privacy Policy for more details and opt-out options.

**CONSUMER NOTICE:** The information and instructions in this bulletin are intended for use by skilled technicians. Mazda technicians utilize the proper tools/ equipment and take training to correctly and safely maintain Mazda vehicles. These instructions should not be performed by "do-it-yourselfers." Customers should not assume this bulletin applies to their vehicle or that their vehicle will develop the described concern. To determine if the information applies, customers should contact their nearest authorized Mazda dealership. Mazda North American Operations reserves the right to alter the specifications and contents of this bulletin without obligation or advance notice. All rights reserved. No part of this bulletin may be reproduced in any form or by any means, electronic or mechanical--including photocopying and recording and the use of any kind of information storage and retrieval system ---without permission in writing.

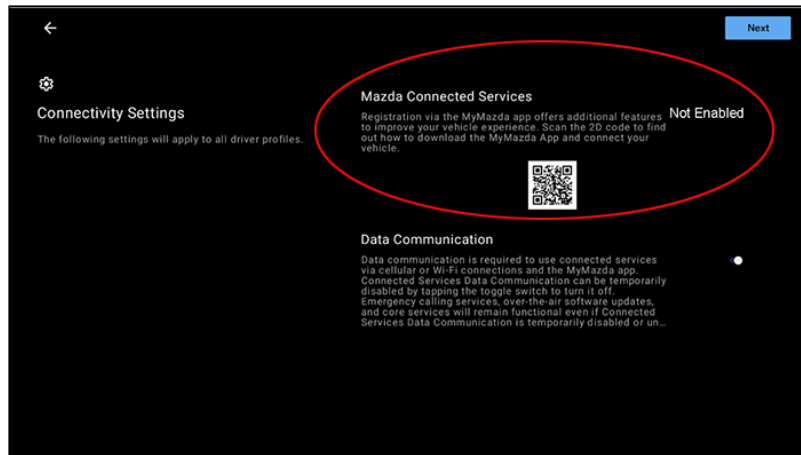

### Profile Name

Enter your Profile name, then select "Next".

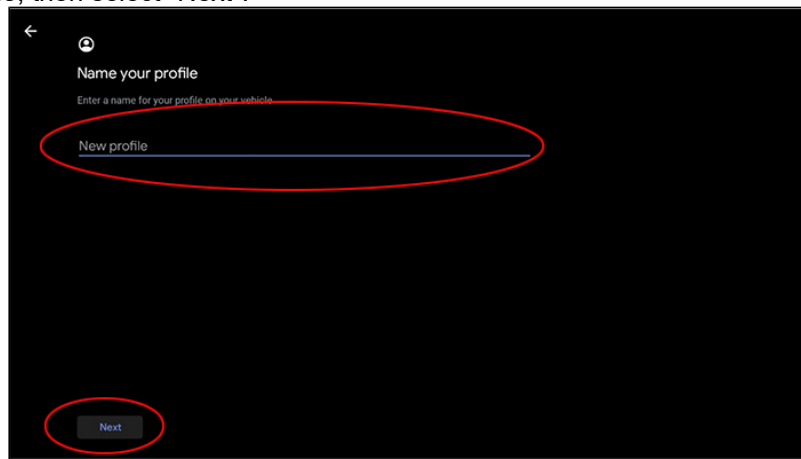

### Google Terms of Use

**CONSUMER NOTICE:** The information and instructions in this bulletin are intended for use by skilled technicians. Mazda technicians utilize the proper tools/ equipment and take training to correctly and safely maintain Mazda vehicles. These instructions should not be performed by "do-it-yourselfers." Customers should not assume this bulletin applies to their vehicle or that their vehicle will develop the described concern. To determine if the information applies, customers should contact their nearest authorized Mazda dealership. Mazda North American Operations reserves the right to alter the specifications and contents of this bulletin without obligation or advance notice. All rights reserved. No part of this bulletin may be reproduced in any form or by any means, electronic or mechanical--including photocopying and recording and the use of any kind of information storage and retrieval system ---without permission in writing.

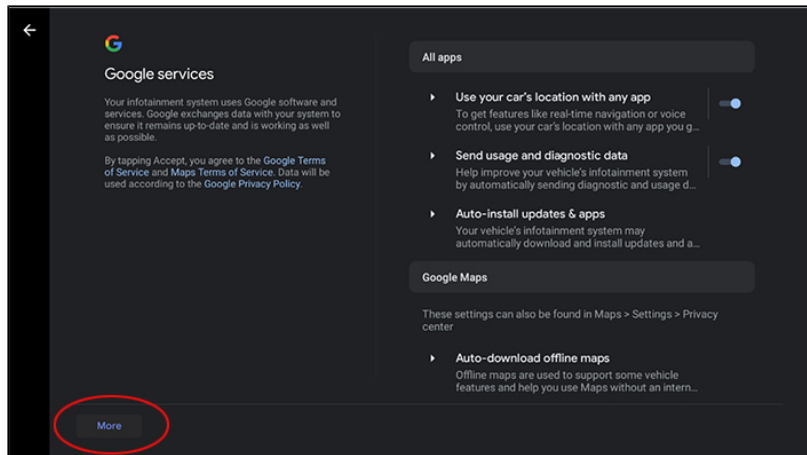

Scroll down to "Google Assistant". "Hey Google" default is off. The recommendation is to turn on "Hey Google" as shown below:

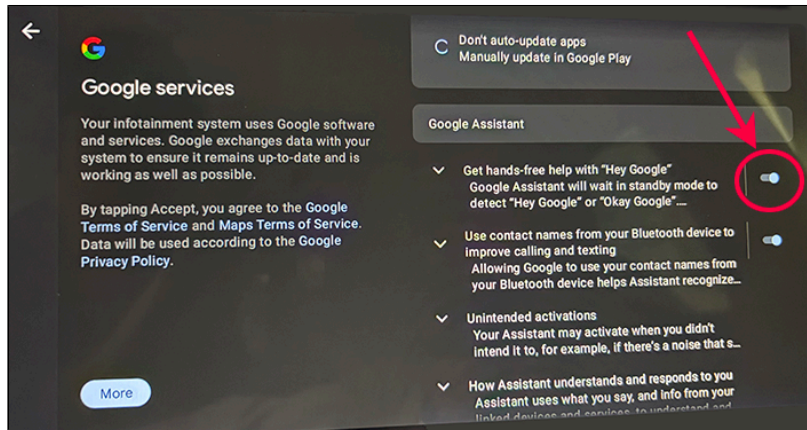

Select "Accept".

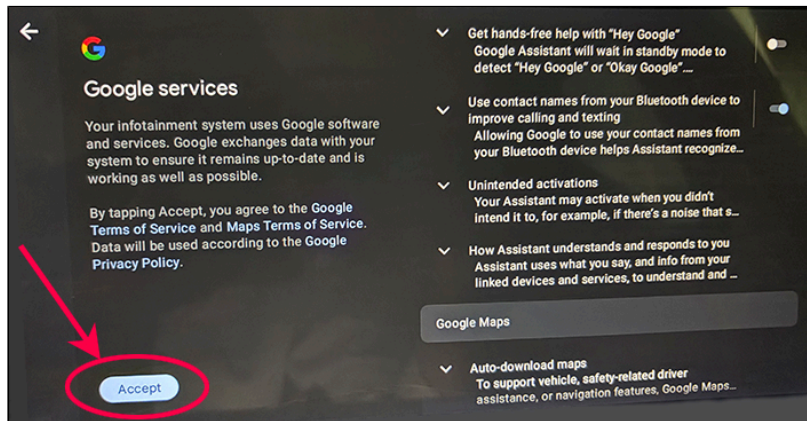

If the user did not turn on "Hey Google" after selecting "Accept", the system will notify the user that it is turned off. The recommendation is to "Turn on" as shown below:

**CONSUMER NOTICE:** The information and instructions in this bulletin are intended for use by skilled technicians. Mazda technicians utilize the proper tools/ equipment and take training to correctly and safely maintain Mazda vehicles. These instructions should not be performed by "do-it-yourselfers." Customers should not assume this bulletin applies to their vehicle or that their vehicle will develop the described concern. To determine if the information applies, customers should contact their nearest authorized Mazda dealership. Mazda North American Operations reserves the right to alter the specifications and contents of this bulletin without obligation or advance notice. All rights reserved. No part of this bulletin may be reproduced in any form or by any means, electronic or mechanical---including photocopying and recording and the use of any kind of information storage and retrieval system ---without permission in writing.

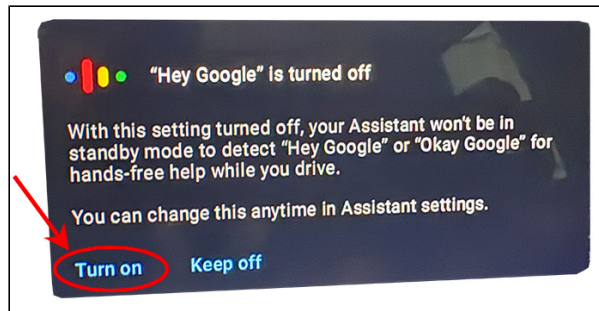

## Google Account

You may need to log in to your Google Account when using Google Gemini or Google Assistant, Google Maps, or Google Play.

If necessary, create a Google Account and log in.

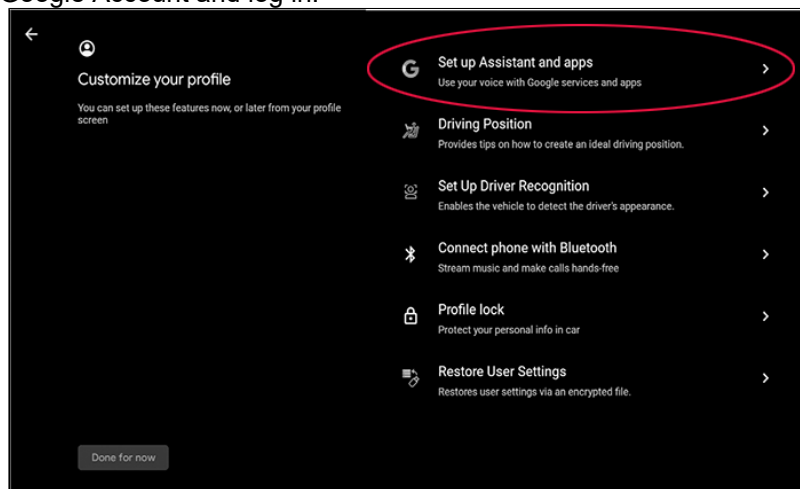

Perform the log in operation following the instructions displayed on the screen.

## Driving Position Assist

Driving Position Assist is a feature that can suggest ideal driving position settings. If you enable Driving Position Assist, you will be asked to enter your height and the camera in your vehicle will automatically detect the center of your face to determine

the position of your head. The vehicle then uses this information to adjust the position of your seat, Active Driving Display, and outer mirrors, so you are in a better position for driving. No personal information is stored related to this feature unless you choose to create a Driver Profile as detailed above; if you create a Driver Profile your ideal driving position settings will be stored with your Driver Profile. This is a convenience feature and you can adjust vehicle settings manually instead of using the camera.

**CONSUMER NOTICE:** The information and instructions in this bulletin are intended for use by skilled technicians. Mazda technicians utilize the proper tools/ equipment and take training to correctly and safely maintain Mazda vehicles. These instructions should not be performed by "do-it-yourselfers." Customers should not assume this bulletin applies to their vehicle or that their vehicle will develop the described concern. To determine if the information applies, customers should contact their nearest authorized Mazda dealership. Mazda North American Operations reserves the right to alter the specifications and contents of this bulletin without obligation or advance notice. All rights reserved. No part of this bulletin may be reproduced in any form or by any means, electronic or mechanical--including photocopying and recording and the use of any kind of information storage and retrieval system ---without permission in writing.

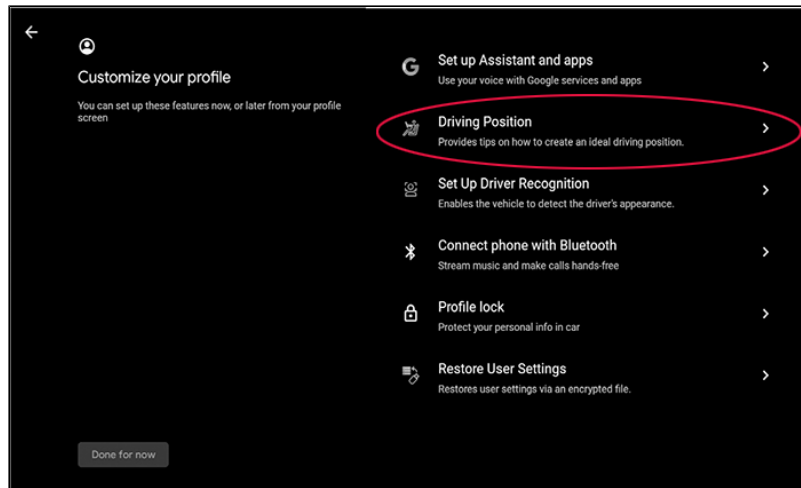

**Driver Recognition**

The Driver Personalization System uses the driver monitoring camera to convert the driver's facial features into numerical information. The driver monitoring camera does not store or share images, audio, or video.

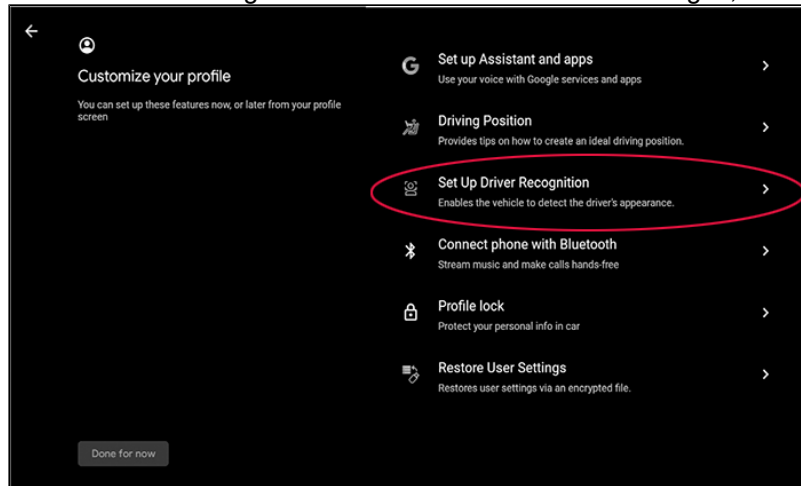

**Bluetooth® Set Up**

**CONSUMER NOTICE:** The information and instructions in this bulletin are intended for use by skilled technicians. Mazda technicians utilize the proper tools/ equipment and take training to correctly and safely maintain Mazda vehicles. These instructions should not be performed by "do-it-yourselfers." Customers should not assume this bulletin applies to their vehicle or that their vehicle will develop the described concern. To determine if the information applies, customers should contact their nearest authorized Mazda dealership. Mazda North American Operations reserves the right to alter the specifications and contents of this bulletin without obligation or advance notice. All rights reserved. No part of this bulletin may be reproduced in any form or by any means, electronic or mechanical---including photocopying and recording and the use of any kind of information storage and retrieval system ---without permission in writing.

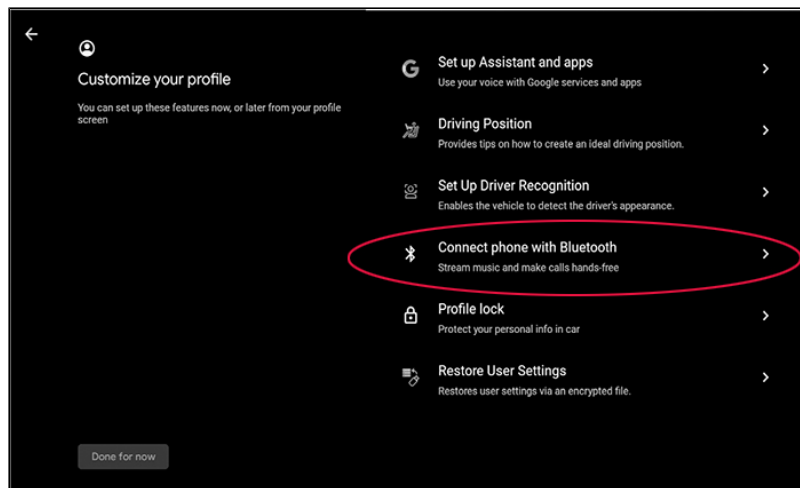

1. Tap on the navigation bar (A).
2. Tap "Bluetooth® & Phone Connectivity" (B).
3. Tap "Pair New Device" (C).

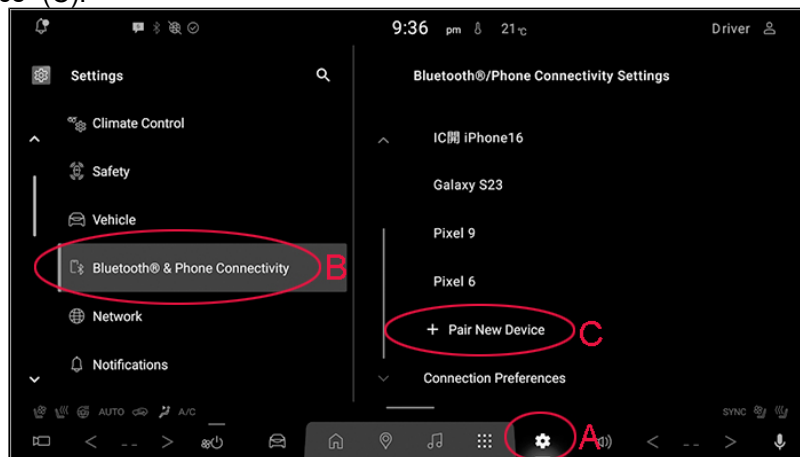

4. Follow the instructions on the screen to connect a portable audio device or mobile phone to Bluetooth®.

### Profile Lock

Lock settings for each user profile can be performed.

**CONSUMER NOTICE:** The information and instructions in this bulletin are intended for use by skilled technicians. Mazda technicians utilize the proper tools/ equipment and take training to correctly and safely maintain Mazda vehicles. These instructions should not be performed by "do-it-yourselfers." Customers should not assume this bulletin applies to their vehicle or that their vehicle will develop the described concern. To determine if the information applies, customers should contact their nearest authorized Mazda dealership. Mazda North American Operations reserves the right to alter the specifications and contents of this bulletin without obligation or advance notice. All rights reserved. No part of this bulletin may be reproduced in any form or by any means, electronic or mechanical--including photocopying and recording and the use of any kind of information storage and retrieval system ---without permission in writing.

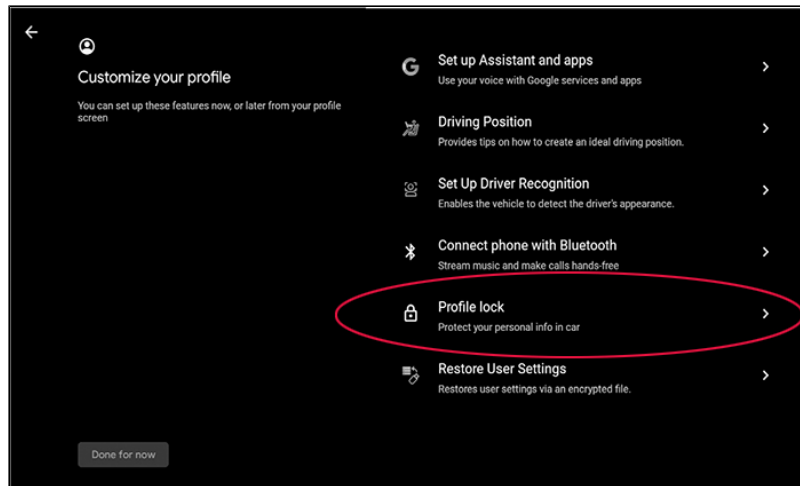

### Restore User Settings

Erases all data and restores all factory default settings.

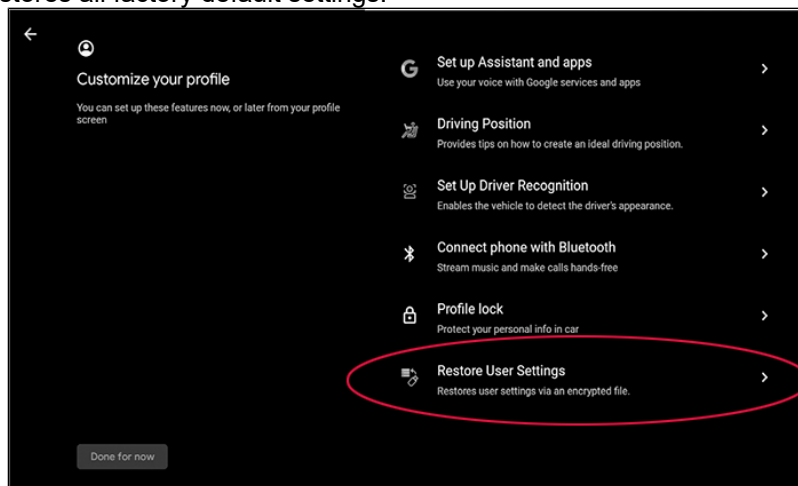

### Service Information

- Go to Mazda Connect Owner's Manual Page 1-2
- Go to [Connected Service Owner's Manual](#)

### Cockpit Domain Controller

The cockpit domain controller (CDC) (3) controls the entire system such as communication between mobile devices and Bluetooth®, and the sending/receiving of video/audio signals from units related to the entertainment system.

**CONSUMER NOTICE:** The information and instructions in this bulletin are intended for use by skilled technicians. Mazda technicians utilize the proper tools/ equipment and take training to correctly and safely maintain Mazda vehicles. These instructions should not be performed by "do-it-yourselfers." Customers should not assume this bulletin applies to their vehicle or that their vehicle will develop the described concern. To determine if the information applies, customers should contact their nearest authorized Mazda dealership. Mazda North American Operations reserves the right to alter the specifications and contents of this bulletin without obligation or advance notice. All rights reserved. No part of this bulletin may be reproduced in any form or by any means, electronic or mechanical--including photocopying and recording and the use of any kind of information storage and retrieval system ---without permission in writing.

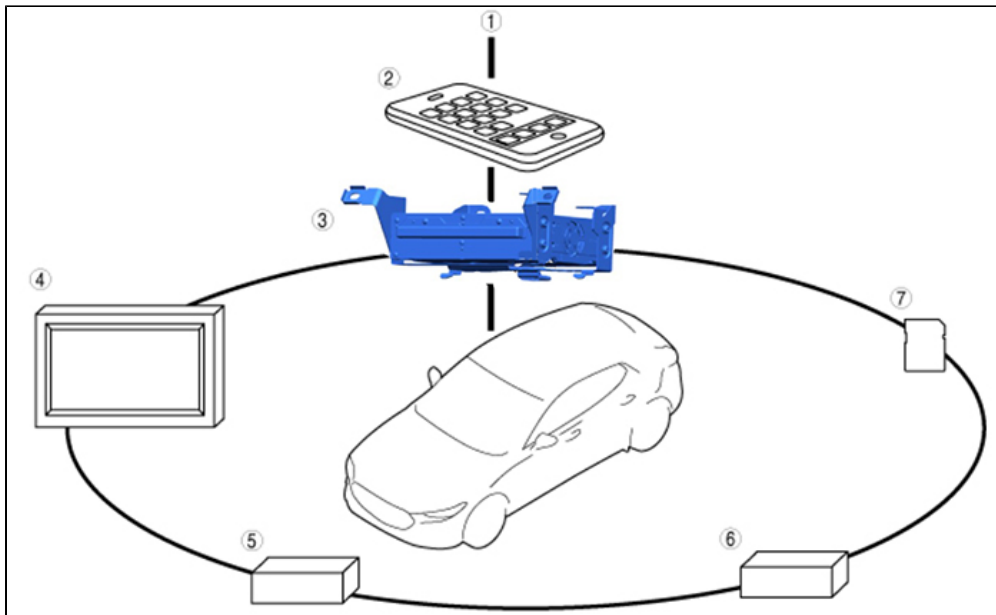

1	Internet
2	Mobile device such as smart phone or Bluetooth ®-Enabled device
3	Cockpit domain controller (CDC)
4	Center display
5	USB port/sd card slot hub *1
6	Integrated sound processing unit (ISPU)
7	SD card *1

\*1:Some models.

### Service Information

Go to MGSS [COCKPIT DOMAIN CONTROLLER \(CDC\)](#)

Related Video [Cockpit Domain Controller \(CDC\) Log Data Retrieval](#)

### Data Communication Module (DCM)

The data communication module (DCM) (1) communicates with various antennas and controls the telematics communication system.

**CONSUMER NOTICE:** The information and instructions in this bulletin are intended for use by skilled technicians. Mazda technicians utilize the proper tools/ equipment and take training to correctly and safely maintain Mazda vehicles. These instructions should not be performed by "do-it-yourselfers." Customers should not assume this bulletin applies to their vehicle or that their vehicle will develop the described concern. To determine if the information applies, customers should contact their nearest authorized Mazda dealership. Mazda North American Operations reserves the right to alter the specifications and contents of this bulletin without obligation or advance notice. All rights reserved. No part of this bulletin may be reproduced in any form or by any means, electronic or mechanical---including photocopying and recording and the use of any kind of information storage and retrieval system ---without permission in writing.

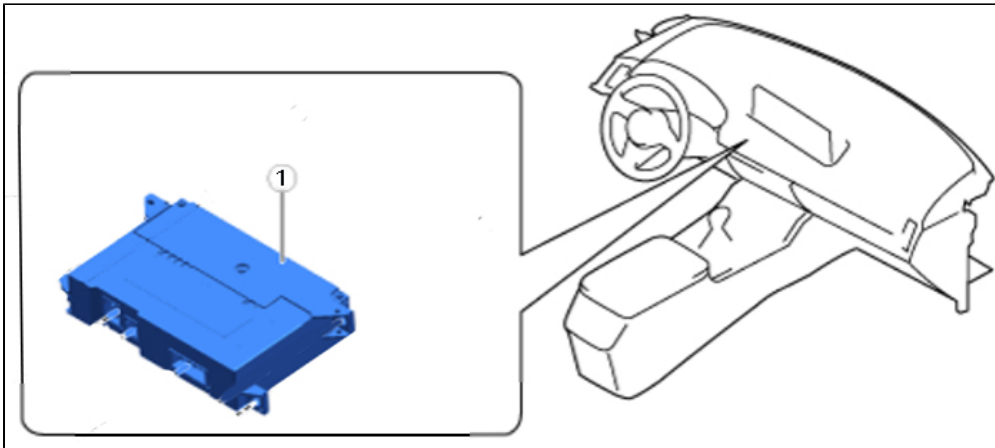

### Service Information

Go to MGSS

- [DATA COMMUNICATION MODULE \(DCM\)](#)
- [TELEMATICS COMMUNICATION SYSTEM](#)

### Data Communication Module (DCM) Backup Battery

- If the data communication module (DCM) detects an open circuit in the main battery, it switches to power supply from the built-in backup battery and continues operation.
- The data communication module (DCM) monitors the backup battery for deterioration, low charge level, and failure.
- If an automatic call is made, the built-in battery power may be depleted and emergency calls may not be possible in the event that an emergency occurs again. After an automatic emergency call has been made, replace the built-in battery.

**CONSUMER NOTICE:** The information and instructions in this bulletin are intended for use by skilled technicians. Mazda technicians utilize the proper tools/ equipment and take training to correctly and safely maintain Mazda vehicles. These instructions should not be performed by "do-it-yourselfers." Customers should not assume this bulletin applies to their vehicle or that their vehicle will develop the described concern. To determine if the information applies, customers should contact their nearest authorized Mazda dealership. Mazda North American Operations reserves the right to alter the specifications and contents of this bulletin without obligation or advance notice. All rights reserved. No part of this bulletin may be reproduced in any form or by any means, electronic or mechanical---including photocopying and recording and the use of any kind of information storage and retrieval system ---without permission in writing.

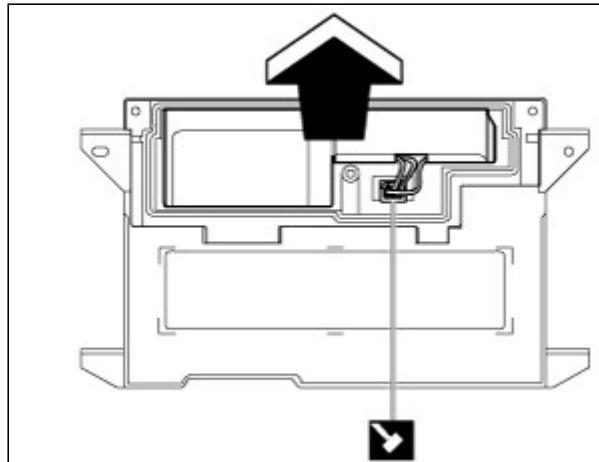

Service Information  
Go to MGSS

- [DATA COMMUNICATION MODULE \(DCM\) BATTERY REMOVAL/INSTALLATION](#)
- [EMERGENCY CALL SYSTEM](#)

## Emergency Call System

The emergency call system is a system which reports the location of an accident occurring with the vehicle and vehicle information to a call center to assist in a prompt emergency rescue in an emergency situation such as an accident or sudden illness occurring while driving.

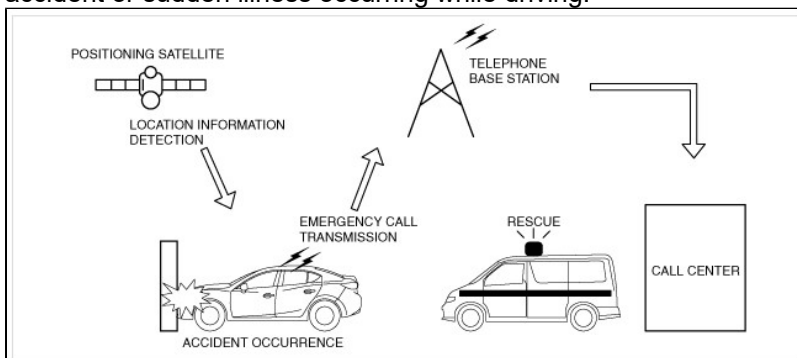

Service Information  
Go to MGSS [EMERGENCY CALL SYSTEM](#)

## Over The Air (OTA) Update

- By transmitting and receiving the information required for software update via the data communication

**CONSUMER NOTICE:** The information and instructions in this bulletin are intended for use by skilled technicians. Mazda technicians utilize the proper tools/ equipment and take training to correctly and safely maintain Mazda vehicles. These instructions should not be performed by "do-it-yourselfers." Customers should not assume this bulletin applies to their vehicle or that their vehicle will develop the described concern. To determine if the information applies, customers should contact their nearest authorized Mazda dealership. Mazda North American Operations reserves the right to alter the specifications and contents of this bulletin without obligation or advance notice. All rights reserved. No part of this bulletin may be reproduced in any form or by any means, electronic or mechanical--including photocopying and recording and the use of any kind of information storage and retrieval system ---without permission in writing.

module (DCM) between the cockpit domain controller (CDC) and the OTA center, update request notifications or update operations for the target module are carried out at the appropriate time.

### Periodic check function

- The cockpit domain controller (CDC) will automatically send vehicle information to the OTA center when main power is switched to ON if seven days have elapsed since the last transmission of vehicle information to the OTA Center.

### Campaign notification display function

- A campaign notification message will be displayed at the top of the center display screen for a set period of time when all of the following conditions are met.
  - There is a module eligible for OTA software update \*
  - Notification data download is completed
  - Vehicle speed is 0 km/h {0 mph}

\*:The target modules vary depending on the market.

- If the campaign notification has not been opened, the campaign notification display function will remind the user when the main power is switched ON 5 days after the initial notification.
- To view the message after it has finished displaying, swipe down on the top of the center display or tap the icon on the upper left of the screen to display the notification list, as shown below.
- Once the screen is tapped to view the information, it will be removed from the notification list.



### Service Information

Go to MGSS [TELEMATICS COMMUNICATION SYSTEM](#) --> OTA software update

### Over The Air (OTA) Error Message/Error Code

An error message and/or error code is displayed during software updates.

**CONSUMER NOTICE:** The information and instructions in this bulletin are intended for use by skilled technicians. Mazda technicians utilize the proper tools/ equipment and take training to correctly and safely maintain Mazda vehicles. These instructions should not be performed by "do-it-yourselfers." Customers should not assume this bulletin applies to their vehicle or that their vehicle will develop the described concern. To determine if the information applies, customers should contact their nearest authorized Mazda dealership. Mazda North American Operations reserves the right to alter the specifications and contents of this bulletin without obligation or advance notice. All rights reserved. No part of this bulletin may be reproduced in any form or by any means, electronic or mechanical---including photocopying and recording and the use of any kind of information storage and retrieval system ---without permission in writing.

**Service Information**

Go to MGSS [AN ERROR MESSAGE IS DISPLAYED DURING SOFTWARE UPDATES \[OVER THE AIR \[OTA\] REPROGRAMMING\]](#)

**Stolen Vehicle Assistance**

If your vehicle is stolen/missing, use the MyMazda APP to request assistance from a Stolen Vehicle Assistance operator. The operator will obtain the vehicle's location information and contact the police with the location information when a report is made using the MyMazda APP. The police will begin confirming and searching for the vehicle and, if found, you will receive the search results from the police.

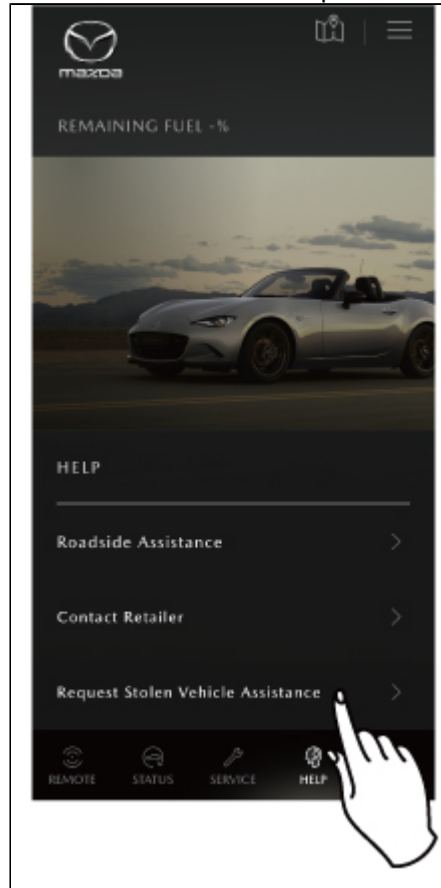
**Service Information**

Go to [Connected Service Owner's Manual](#)

**Connectivity Service Period**

Free Trial	Connected Vehicle + Emergency Call System/Stolen Vehicle Assistance + Google Built-In
------------	---

**CONSUMER NOTICE:** The information and instructions in this bulletin are intended for use by skilled technicians. Mazda technicians utilize the proper tools/ equipment and take training to correctly and safely maintain Mazda vehicles. These instructions should not be performed by "do-it-yourselfers." Customers should not assume this bulletin applies to their vehicle or that their vehicle will develop the described concern. To determine if the information applies, customers should contact their nearest authorized Mazda dealership. Mazda North American Operations reserves the right to alter the specifications and contents of this bulletin without obligation or advance notice. All rights reserved. No part of this bulletin may be reproduced in any form or by any means, electronic or mechanical---including photocopying and recording and the use of any kind of information storage and retrieval system ---without permission in writing.

	Free Trial – First Year
	Connected Vehicle - Vehicle Health Screen Only Free Trial – Following 9 Years, Only Used When there is No Paid Tier Subscription
Paid Tiers	Connected Vehicle + Emergency Call System/Stolen Vehicle Assistance Paid Tier 1 – Available After First Year
	Connected Vehicle + Emergency Call System/Stolen Vehicle Assistance + Google Built-In Paid Tier 2 – Available After First Year

### SD Map Card

The SD map card is for i-ACTIVSENSE systems such as:

- Traffic Sign Recognition System (TSR)
- Lane Change Assist
- MAZDA RADAR CRUISE CONTROL WITH STOP & GO FUNCTION (MRCC WITH STOP & GO FUNCTION)

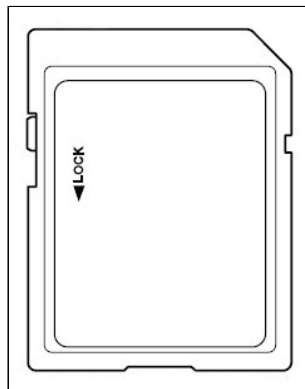

**Note:**

- The SD map card is not used for Navigation Guidance
- If the SD map card is removed, some ADAS functions will be restricted.

**Service Information**

See Owner's Manual --> USB Audio

### Steering Switch

- Operation of the entertainment system and changing of the trip computer system display are possible without a change in driving posture.

**CONSUMER NOTICE:** The information and instructions in this bulletin are intended for use by skilled technicians. Mazda technicians utilize the proper tools/ equipment and take training to correctly and safely maintain Mazda vehicles. These instructions should not be performed by "do-it-yourselfers." Customers should not assume this bulletin applies to their vehicle or that their vehicle will develop the described concern. To determine if the information applies, customers should contact their nearest authorized Mazda dealership. Mazda North American Operations reserves the right to alter the specifications and contents of this bulletin without obligation or advance notice. All rights reserved. No part of this bulletin may be reproduced in any form or by any means, electronic or mechanical--including photocopying and recording and the use of any kind of information storage and retrieval system ---without permission in writing.

- The steering switch is a button that combines capacitive type and tactile switch mechanisms.

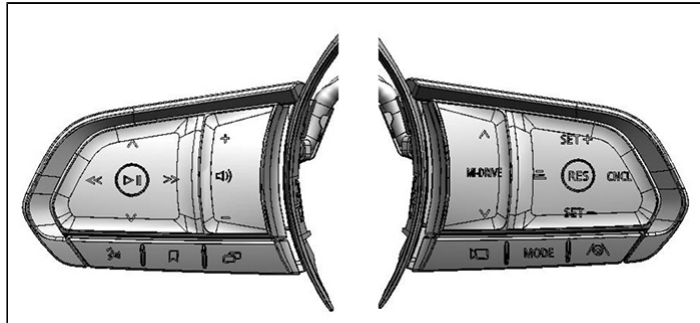

#### Service Information

Go to MGSS [Steering Switch](#)

### Driver Monitoring (DM) System

The driver monitoring (DM) detects the state of the driver (looking away, drowsiness level) by the camera inside the vehicle. If the system determines dangerous driving, it alerts the driver and promotes safety by a warning display and warning sound.

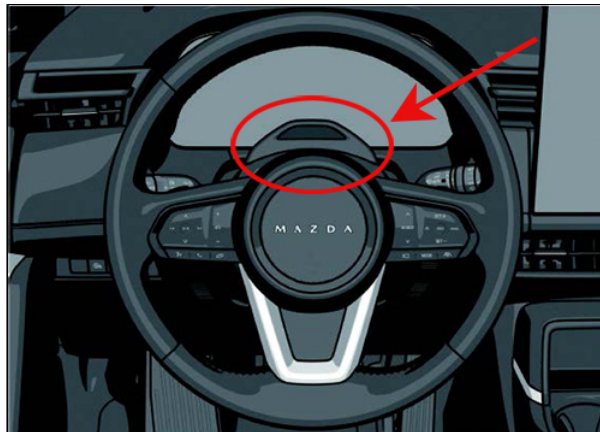

#### Service Information

Go to MGSS [DRIVER MONITORING \(DM\)](#)

### Apple CarPlay/Android Auto USB-C Wired Connection

Apple CarPlay/Android Auto USB-C wired connection is on the left side of the USB Hub as indicated below.

**CONSUMER NOTICE:** The information and instructions in this bulletin are intended for use by skilled technicians. Mazda technicians utilize the proper tools/ equipment and take training to correctly and safely maintain Mazda vehicles. These instructions should not be performed by "do-it-yourselfers." Customers should not assume this bulletin applies to their vehicle or that their vehicle will develop the described concern. To determine if the information applies, customers should contact their nearest authorized Mazda dealership. Mazda North American Operations reserves the right to alter the specifications and contents of this bulletin without obligation or advance notice. All rights reserved. No part of this bulletin may be reproduced in any form or by any means, electronic or mechanical--including photocopying and recording and the use of any kind of information storage and retrieval system ---without permission in writing.

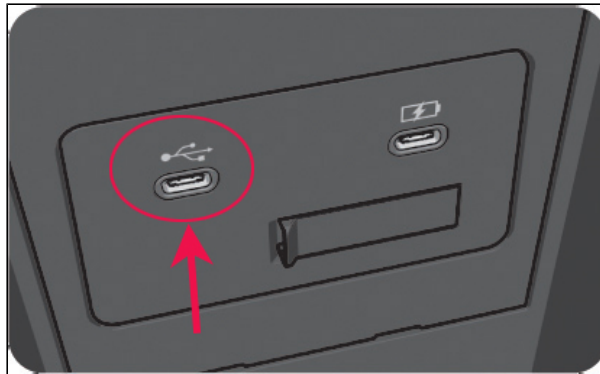

### Service Information

Go to Owner's Manual --> Mazda Connect

### Maintenance Notification

The maintenance notification function alerts drivers of maintenance needs by turning on the wrench indicator light and displaying a message in the instrument panel. The following information describes the normal operation of notification on the new 2026 CX-5 (KM).

A message appears on the instrument panel when the remaining distance to the engine oil change reaches 600 miles.

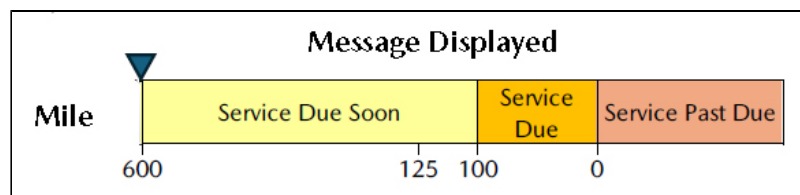

### Tripmeter Location Change

- The odometer and tripmeter are **not** displayed in the instrument cluster.
- The odometer and tripmeter are displayed in the Center Display --> "Efficiency" application. Other fuel economy information is provided.

**CONSUMER NOTICE:** The information and instructions in this bulletin are intended for use by skilled technicians. Mazda technicians utilize the proper tools/ equipment and take training to correctly and safely maintain Mazda vehicles. These instructions should not be performed by "do-it-yourselfers." Customers should not assume this bulletin applies to their vehicle or that their vehicle will develop the described concern. To determine if the information applies, customers should contact their nearest authorized Mazda dealership. Mazda North American Operations reserves the right to alter the specifications and contents of this bulletin without obligation or advance notice. All rights reserved. No part of this bulletin may be reproduced in any form or by any means, electronic or mechanical--including photocopying and recording and the use of any kind of information storage and retrieval system ---without permission in writing.

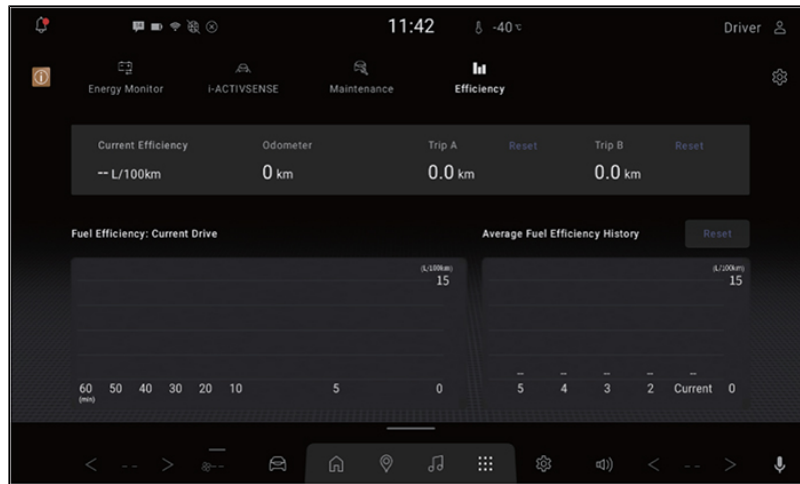

### Service Information

Go to Owner's Manual --> Efficiency

### Service Information

### PDI Fuse Location

#### Fuse to be Installed at PDI

Fuse F1 (25A) is removed from the engine compartment fuse block and is stored on the engine compartment fuse block lid.

Fuse Block (Engine Compartment)

**CONSUMER NOTICE:** The information and instructions in this bulletin are intended for use by skilled technicians. Mazda technicians utilize the proper tools/ equipment and take training to correctly and safely maintain Mazda vehicles. These instructions should not be performed by "do-it-yourselfers." Customers should not assume this bulletin applies to their vehicle or that their vehicle will develop the described concern. To determine if the information applies, customers should contact their nearest authorized Mazda dealership. Mazda North American Operations reserves the right to alter the specifications and contents of this bulletin without obligation or advance notice. All rights reserved. No part of this bulletin may be reproduced in any form or by any means, electronic or mechanical--including photocopying and recording and the use of any kind of information storage and retrieval system ---without permission in writing.

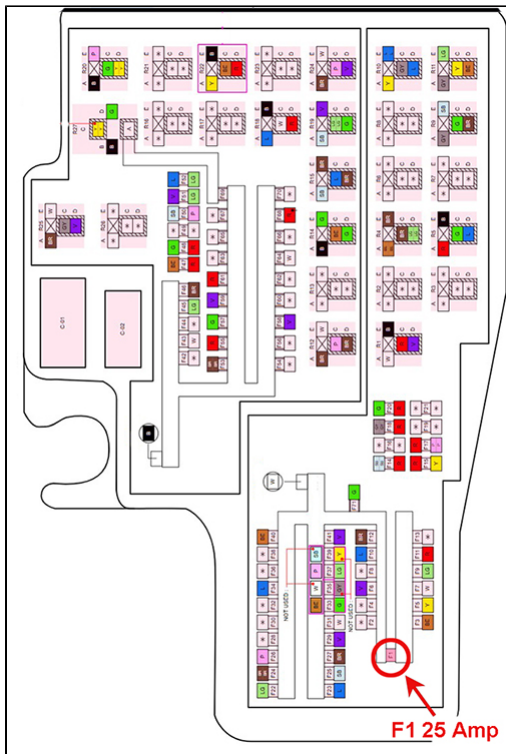

Front of vehicle

**NOTE:**

- Make sure the fuse is fully installed into position and flush with all of the other fuses.
- Check for the Connected Vehicle signal after installing fuse F1. The connectivity signal bar looks like a vertical stack bar on the top left of the screen and should be white as shown below to be working properly.

**CONSUMER NOTICE:** The information and instructions in this bulletin are intended for use by skilled technicians. Mazda technicians utilize the proper tools/ equipment and take training to correctly and safely maintain Mazda vehicles. These instructions should not be performed by "do-it-yourselfers." Customers should not assume this bulletin applies to their vehicle or that their vehicle will develop the described concern. To determine if the information applies, customers should contact their nearest authorized Mazda dealership. Mazda North American Operations reserves the right to alter the specifications and contents of this bulletin without obligation or advance notice. All rights reserved. No part of this bulletin may be reproduced in any form or by any means, electronic or mechanical---including photocopying and recording and the use of any kind of information storage and retrieval system ---without permission in writing.



## Mazda Connected Vehicle Maintenance Mode

Before servicing a customer's vehicle, always put it in connected services disable mode or connected vehicle maintenance mode.

- Connected services disable mode is a mode that temporarily stops the communication functions other than the emergency call function for the vehicle according to the GDPR (General Data Protection Regulation).
- Connected vehicle maintenance mode is a mode that restricts a part of communications such as the MyMazda App function.
- Switching to connected services disable mode or connected vehicle maintenance mode prevents the customer from being notified of the vehicle condition while it is being serviced or the customer making a remote operation while the vehicle is being serviced.

Cancel connected services disable mode after completing vehicle service.

### Service Information

Go to MGSS [SERVICE CAUTIONS FOR VEHICLES WITH TELEMATICS COMMUNICATION SYSTEM](#)

## 12V Battery Disconnect

After a 12V battery replacement, perform the following procedures:

1. OPERATION AFTER REPLACING 12 V BATTERY
2. 12 V BATTERY CONDITION INITIALIZATION SETTING (i-stop SETTING)
3. POWER LIFTGATE (PLG) SYSTEM INITIALIZATION PROCEDURE
4. POWER OUTER MIRROR SYSTEM INITIALIZATION PROCEDURE

**Note:** Google Assistant "Guest Profile" may be delayed. User will need to wait for language packet download (about 100MB).

### Service Information

Go to MGSS [12 V BATTERY REPLACEMENT \[PYU \(WITH i-stop\)\]](#)

## Mazda Diagnostic and Repair Software II (MDARS II)

- 2026 CX-5 exclusively uses MDARS II
- MDARS II can only be used with the Denso Scan Tool (DST)
- Information regarding MDARS II can be found in MGSS > M-MDS Tab

## Tutorial Videos

- [Cockpit Domain Controller \(CDC\) Log Data Retrieval](#)
- [Diagnostic Assist Function \(CDC\)](#)

**CONSUMER NOTICE:** The information and instructions in this bulletin are intended for use by skilled technicians. Mazda technicians utilize the proper tools/ equipment and take training to correctly and safely maintain Mazda vehicles. These instructions should not be performed by "do-it-yourselfers." Customers should not assume this bulletin applies to their vehicle or that their vehicle will develop the described concern. To determine if the information applies, customers should contact their nearest authorized Mazda dealership. Mazda North American Operations reserves the right to alter the specifications and contents of this bulletin without obligation or advance notice. All rights reserved. No part of this bulletin may be reproduced in any form or by any means, electronic or mechanical--including photocopying and recording and the use of any kind of information storage and retrieval system ---without permission in writing.

- [MDARS II Installation Video](#)

**CONSUMER NOTICE:** The information and instructions in this bulletin are intended for use by skilled technicians. Mazda technicians utilize the proper tools/ equipment and take training to correctly and safely maintain Mazda vehicles. These instructions should not be performed by "do-it-yourselfers." Customers should not assume this bulletin applies to their vehicle or that their vehicle will develop the described concern. To determine if the information applies, customers should contact their nearest authorized Mazda dealership. Mazda North American Operations reserves the right to alter the specifications and contents of this bulletin without obligation or advance notice. All rights reserved. No part of this bulletin may be reproduced in any form or by any means, electronic or mechanical---including photocopying and recording and the use of any kind of information storage and retrieval system ---without permission in writing.