



Volvo Car Customer Service

TJ Instruction VCC-517278-1

Title	Temperature sensor, evaporator	Page	1 (5)
Action	Product fix	Operation number:	98734-2 98733-2

Issue	Date	Reason
1	2019-06	First issue

Affected vehicles

Model year	Model
2017, 2018, 2019, 2020	S90 (17-)
2017, 2018, 2019, 2020	S90L
2017, 2018, 2019, 2020	V90 (17-)
2017, 2018, 2019, 2020	V90 Cross Country
2016, 2017, 2018, 2019, 2020	XC90 (16-)



Materials

Materials	Qty.	Part No.	Notes
Adapter cable	1.0	32241228	Adapter cable / Resistor;

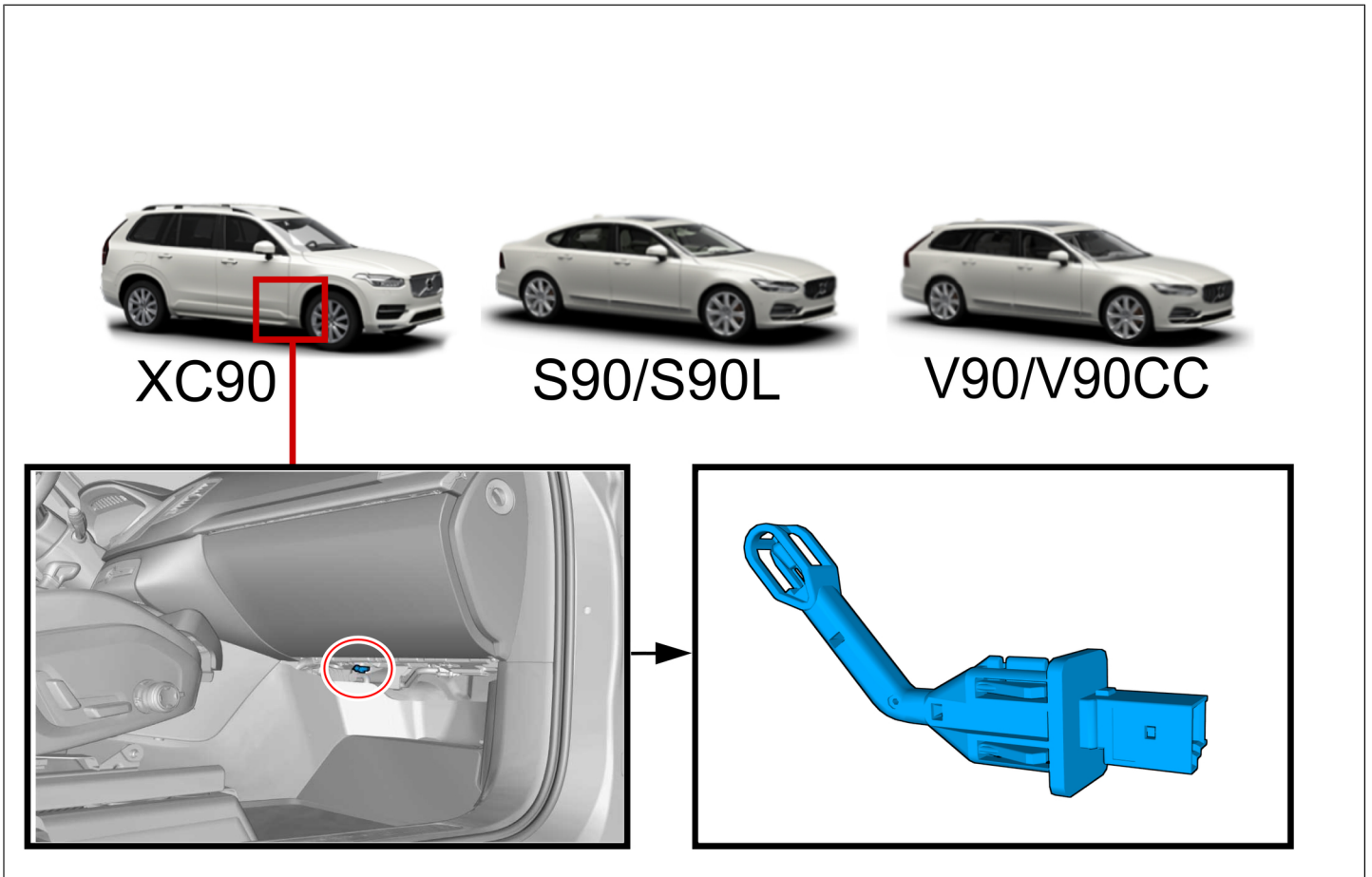
Orientation view

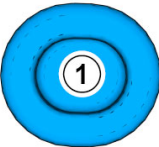
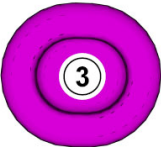
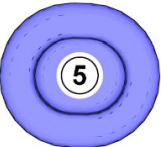
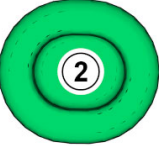
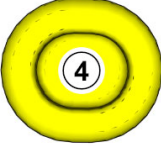

Color symbols

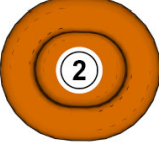
			<p>Note! This colour chart displays (in colour print and electronic version) the importance of the different colours used in the images of the method steps.</p> <ol style="list-style-type: none"> 1 . Used for focused component, the component with which you will do something. 2 . Used as extra colors when you need to show or differentiate additional parts. 3 . Used for attachments that are to be removed/installed. May be screws, clips, connectors, etc. 4 . Used when the component is not fully removed from the vehicle but only hung to the side. 5 . Used for standard tools and special tools. 6 . Used as background color for vehicle components.
			
			

Removal

Set the vehicle to Inactive mode, described in user mode , refer to:

General Information

3 - Electrical system

30 - General

300 - general

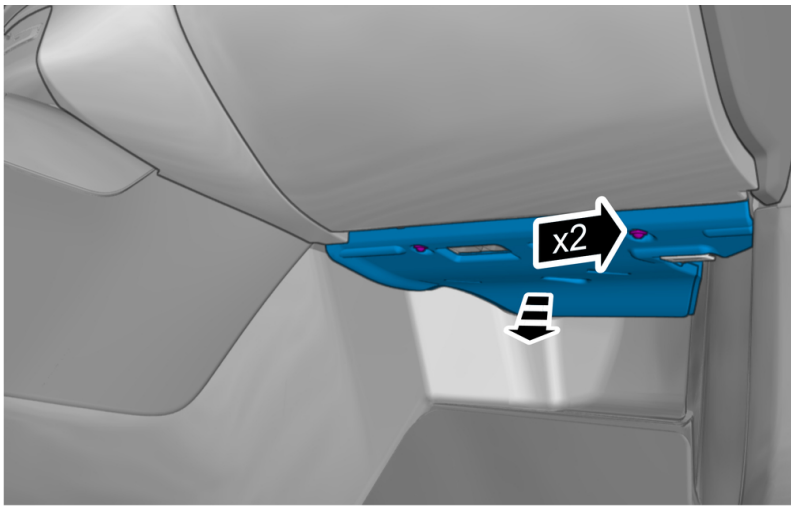

Remove the screws.
Detach the panel.

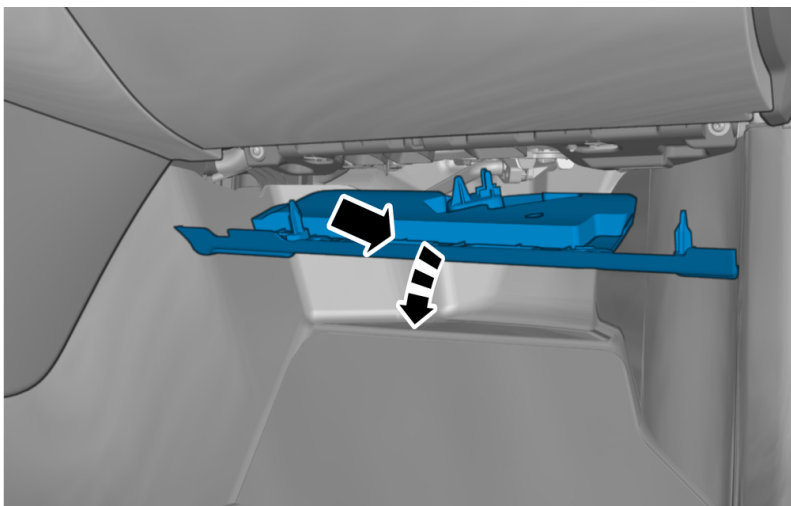

Remove the panel.

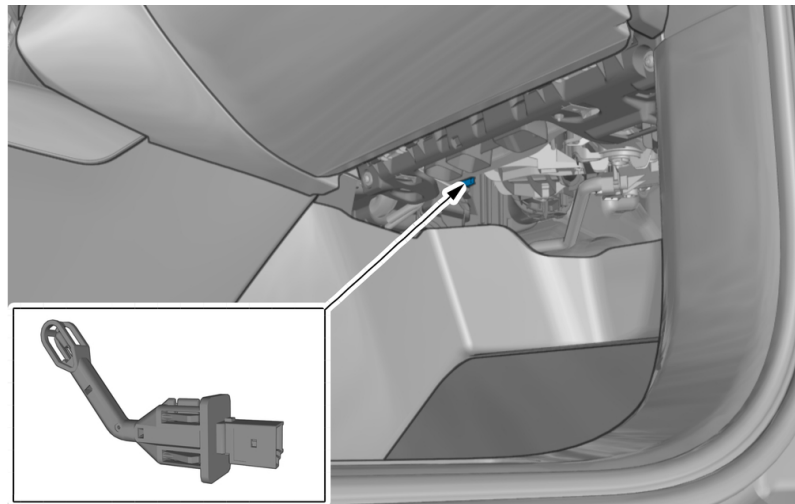

Note! Orientation view

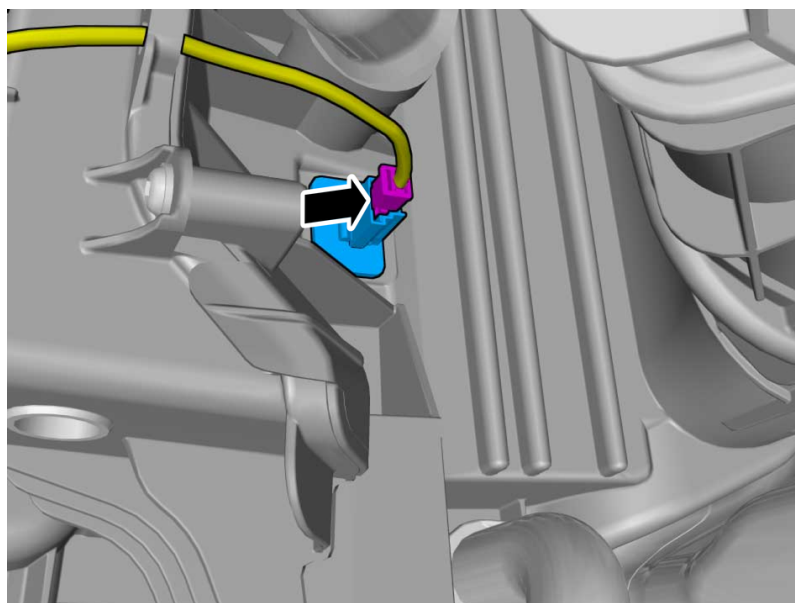

Disconnect the connector.

Modification

Install the marked component.

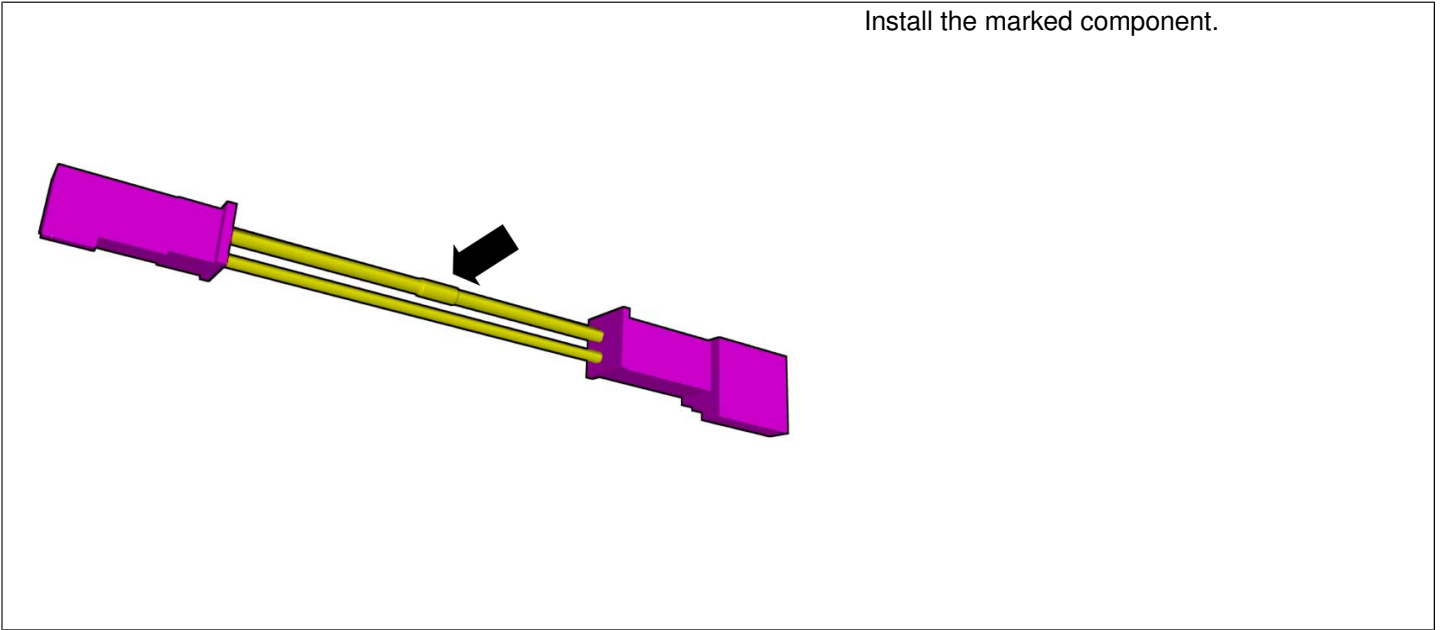

Caution! Make sure that the components are positioned correctly.

Connect the connectors.

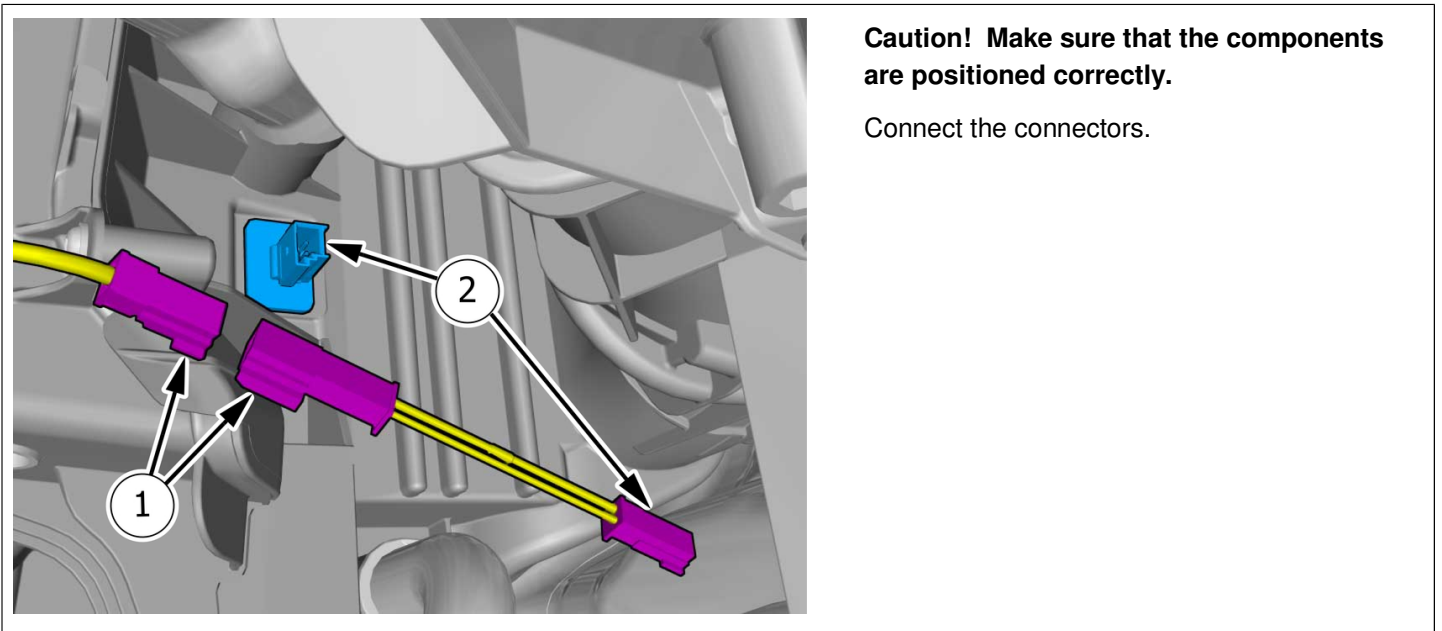

Installation

To install, reverse the removal procedure.