

MAS004850 MCL 25-48

Circular Letter

FROM: Maserati TSO

TO: Maserati Network



Maserati

PERSONAL SERVICE LAB

MASTERS OF CARE

Introduction to Maserati GranTurismo & GranCabrio Folgore



IMPORTANT NOTICE This bulletin supersedes MAS004782 MCL 25-19 released on JULY 25, 2025. It contains updated information, please ensure all previous versions are discarded.

DATE: OCTOBER 2, 2025

The new GranTurismo & GranCabrio Folgore are based on 800V technology and have been developed with innovative technical solutions derived from Formula E. They offer superb performance, combined with the comfort and elegance typical of the Trident, made possible by the three powerful permanent magnet motors. With a potential of over 1200 HP, the cars will have a maximum power of 760 HP available at all 4 wheels and will be equipped with a 92.5 kWh high voltage battery. This letter sets out some important guidelines for the technical management of the new Maserati GranTurismo & GranCabrio Folgore. For further details and general information regarding the entire Folgore range, please refer to the dedicated bulletin MAS003876 and its subsequent revisions.

This document includes in detail:

- Vehicle maintenance and periodic battery checks.
- Indications of best practices and technical notes for Service.
- Pre-delivery inspection checklist.
- Activation of the technical team.
- Unveiling tech-doc/diagnosis and special tools.

Please read and review this bulletin first before starting the procedure.

Contact your Regional AfterSales Manager (RAM) or the Technical Support Helpdesk if you have any questions.

Contents

1	Vehicle maintenance and periodic battery checks.....	2
1.1	Vehicle Receiving Inspection.....	2
2	Best practices in the workshop for service.....	4
2.1	Lifting the vehicle.....	4
2.2	Door opening.....	5
2.3	12V battery location.....	6
2.4	Emergency start - dead battery.....	6
2.5	Transmission Park Release.....	7
3	Pre-Delivery inspection checklist.....	8
4	Activation of the technical team.....	8
5	Technical Documents and Special Tools.....	9
5.1	Technical Information.....	9
5.2	Special Tools.....	9

1 Vehicle maintenance and periodic battery checks

Maintenance requirements for **Folgore (BEV)** vehicles differ significantly from those of internal combustion engine (ICE) models.

All relevant procedures are outlined in the dedicated **In-Stock Maintenance bulletin** (refer to bulletin **MAS003825 MCL 24-13 MGNT And Maintenance Of In-Stock Maserati Vehicle** and its latest revisions).

BEV Standards Compliance

Maserati dealers are required to meet **BEV service standards**, including:

- Dedicated work areas for high-voltage vehicles
- Properly trained and certified EV technicians

For complete details, refer to the **Folgore Range Introduction Bulletin (MAS003876)** and updates) as well as applicable **local safety and regulatory guidelines**.

High Voltage Battery Charge status monitoring

As indicated in the circular letter **MAS003825 MCL 24-13 MGNT And Maintenance Of In-Stock Maserati Vehicle OR NEWER**, checking the charge of the high voltage battery must be carried out at regular intervals and recorded in a specific log, as reported in the circular letter itself.

1.1 Vehicle Receiving Inspection:

Upon receiving the vehicle, perform a thorough inspection to ensure:

- No visible damage
- No fluid leaks
- No signs of burns or smoke
- No warning lights or electrical faults present on the instrument cluster

Refer to the check-in procedure outlined in bulletin **MAS003876** (and its latest revisions), as published in the **Whitebook**.

2 Best practices in the workshop for service

This chapter outlines best practices and technical notes for the GranTurismo and GrandCabrio Folgore models. Due to the unique features of these vehicles, certain precautions are necessary and may not be immediately apparent during standard workshop operations. Firstly, it is crucial to conduct a series of specific checks before driving an electric vehicle inside the shop environment.

2.1 Lifting the vehicle

The position of the lifting points is indicated by an inverted triangle stamped on the edge of the body; there are also vehicle side pads for interfacing the lift arms.



Front pad

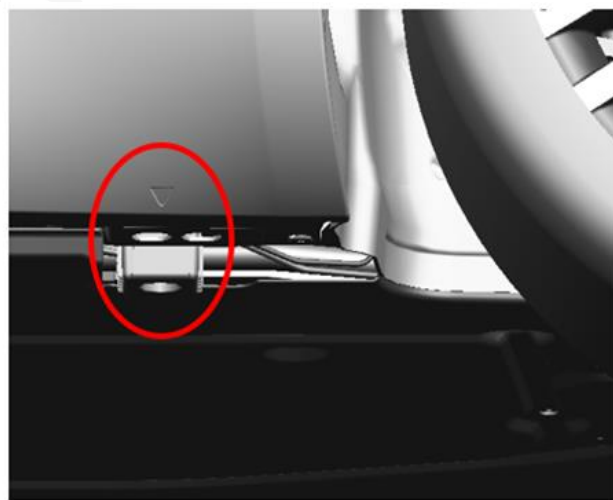

Rear pad

Be careful about the lift arms geometry to prevent damaging the vehicle during the lifting operation. We recommend removing all possible loads from the vehicle (passengers, luggage, spare tire, etc.) to increase the distance from the ground (in case there are no air springs). It is also recommended to use lift plates with a flat surface on the lifter.



2.2 Door Opening

The following diagram summarizes the instructions in the On-board Documentation concerning the door opening controls:

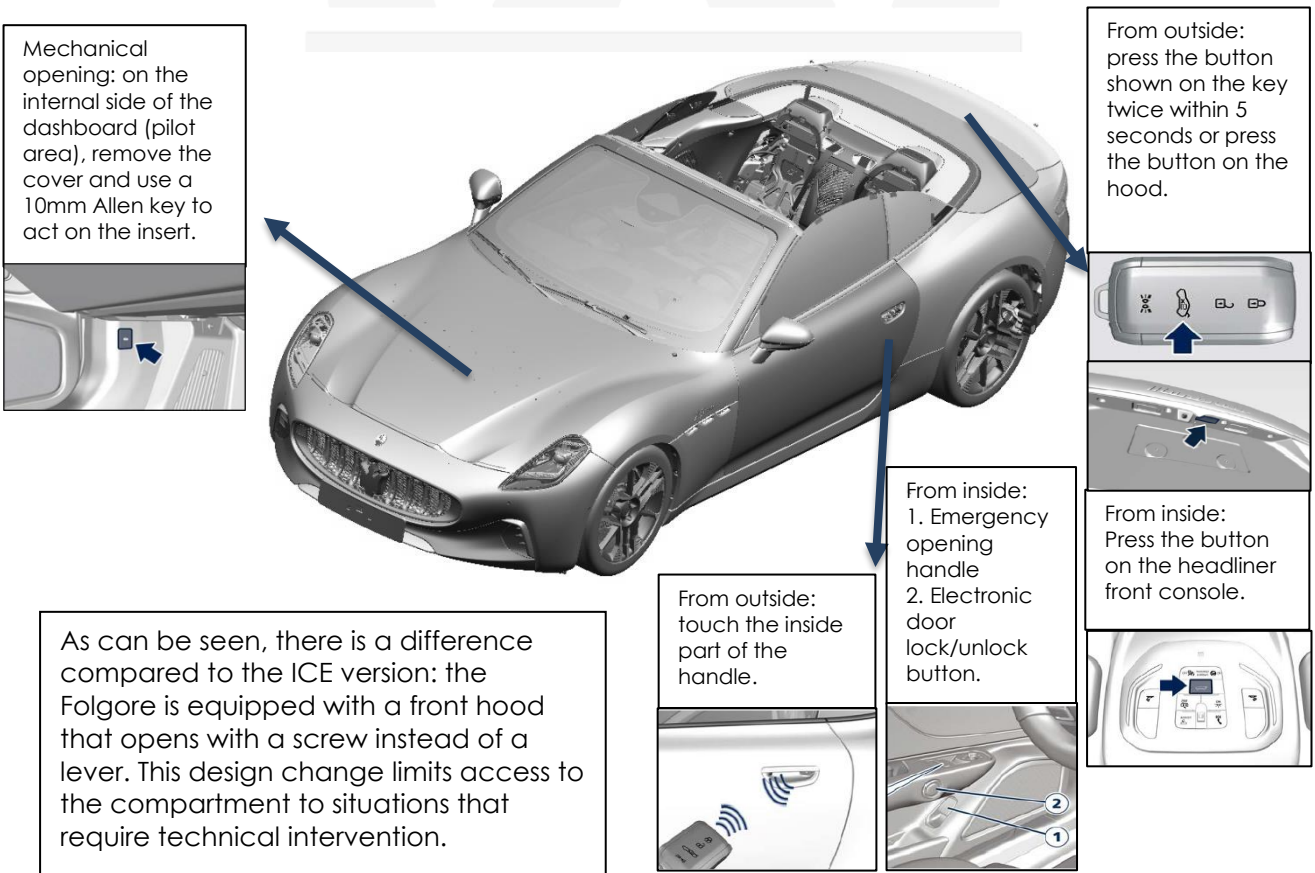
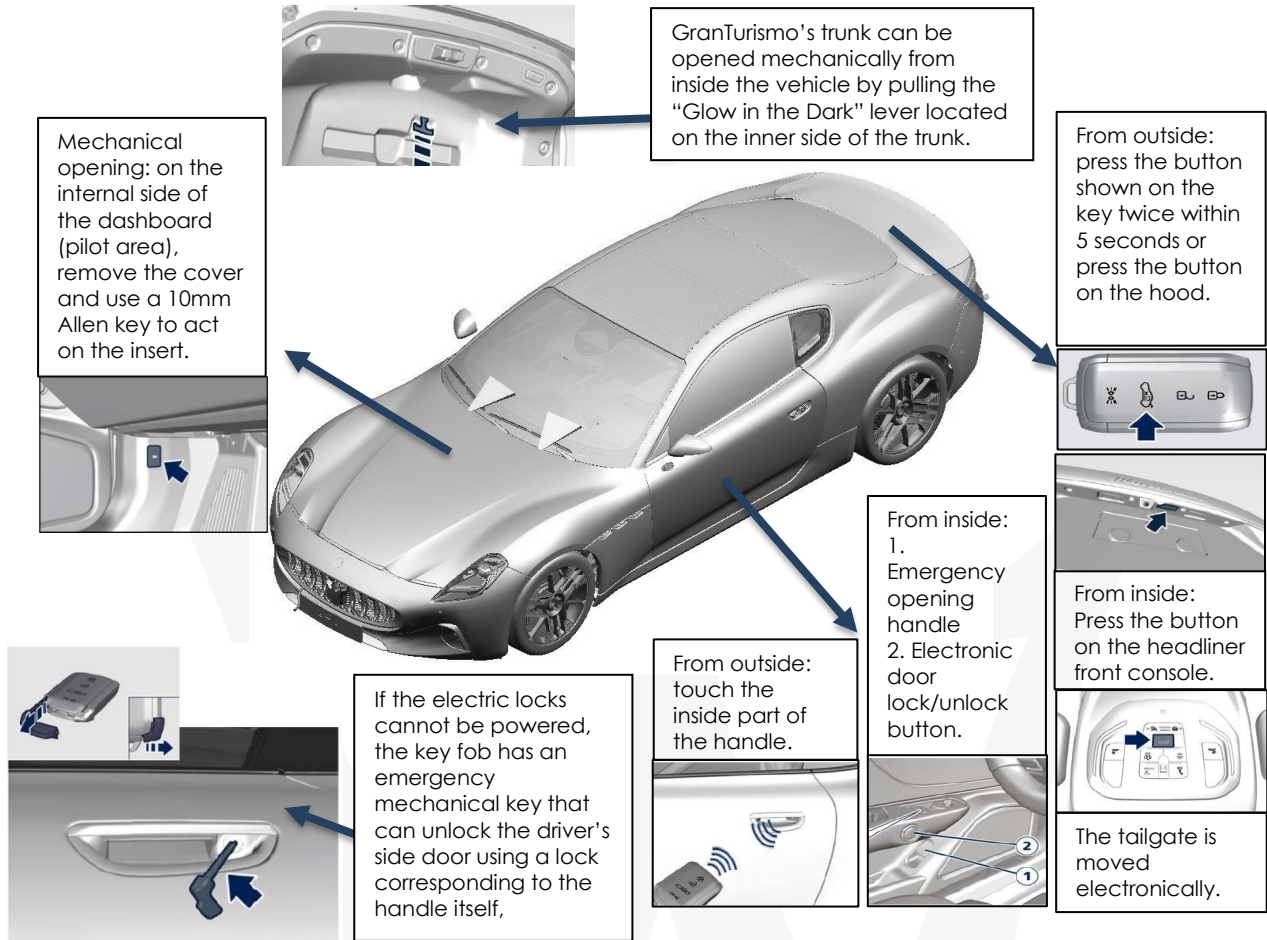

GranCabrio Folgore - soft top operation

The GranCabrio soft top is operated by an electro-hydraulic system, which can be activated using the controls on the vehicle's central display. The opening and closing movement of the soft top can be interrupted by releasing the control; however, it is recommended to always open or close it completely. Do not leave the soft top partially open or closed unless necessary for repairs or maintenance. After approximately 7 minutes, the electro-hydraulic system deactivates. Please also note that in the event of a failure of the automatic movement system, the soft top can be operated manually. For details about the emergency handling procedure, please refer to the vehicle's owner's manual.

High-voltage battery charging port door unlock.

To open the charging door, located on the left part of the rear bumper under the tail lamp, push the soft key on the bottom bar of the Comfort Display.



If you are unable to unlock the charging door with the soft key on the Comfort Display, it can be unlocked manually. Use the door emergency release located on the bottom left of the rear bumper.



NOTE: Pull the release cable moderately to avoid its possible break. It's not possible to feel or hear the unlocking of the charging door actuator. If the charging cable does not unlock at the end of the charging procedure, it must be unlocked manually by operating a special emergency unlocking device located on the left side of the trunk compartment.

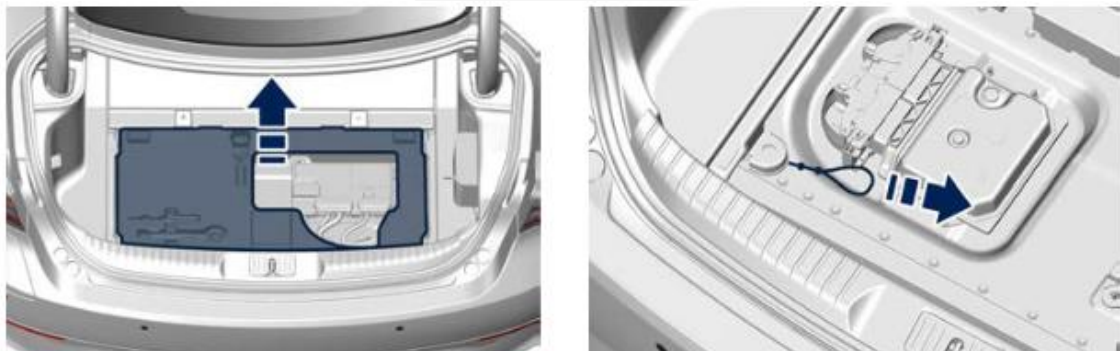

For more information about the correct procedures to carry out, consult the Owner's manual.

2.3 12V Battery Management

The state of charge of the 12V battery is periodically monitored by the VDCM. If the battery voltage falls below a certain threshold, the VDCM will recharge it, ensuring the battery remains charged. Therefore, it is not necessary to de-energize the battery during vehicle downtime. However, the negative terminal will need to be disconnected for certain repair services. Note that disconnecting the 12V battery does not disconnect all electrical systems. Please refer to the Service Manual for further details.

12V battery access

The 12V battery is located in the front hood compartment. To access it, remove the cover by loosening the four screws.

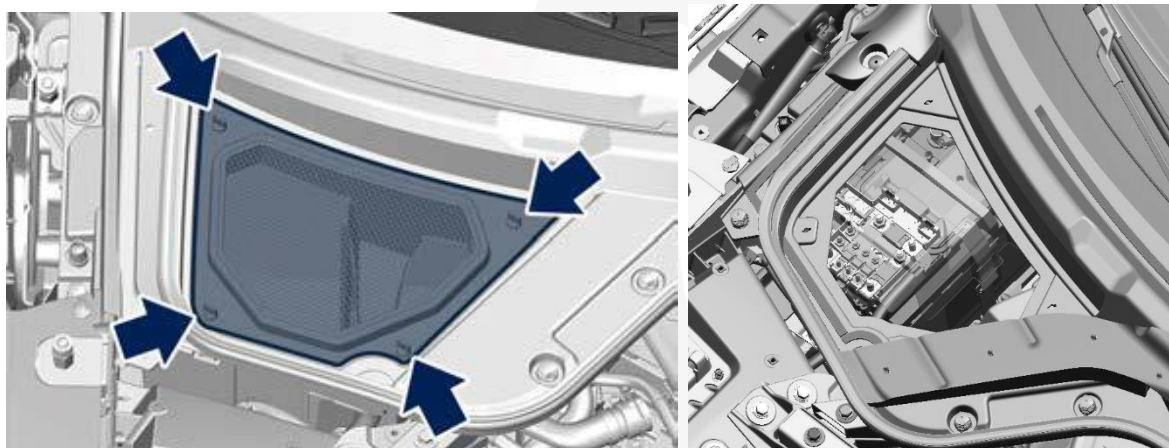

2.4 Emergency start - dead Battery

The 12V battery is periodically recharged by the HV (High Voltage) battery system; however, if the HV battery SOC falls below a certain threshold, it will not maintain charging of the Low Voltage (LV) battery. Consequently, discharge the 12V battery after a short period. Therefore, the vehicle cannot be started or recharged if the HV and LV batteries are low or dead. It will be necessary to recharge the 12V battery first with an external source or replacement, after which the HV battery can be recharged/recovered using an external source via the HV charging port. Please note that this can only be done if there are no faults related to the HV system and that the HV battery is not completely dead or below a certain threshold. Please review the training material or the workshop manual in case of a dead HV battery.

To power the 12V battery using a suitable external source, use the connecting points as shown below: the positive directly on the battery post and the negative using the ground pin located on the side:

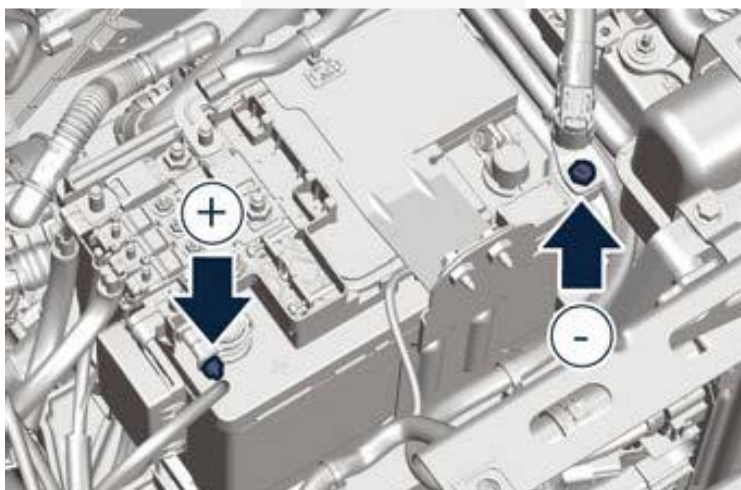

2.5 Transmission Park Release (Front e-axle unlock)

To move the vehicle with the power off, it is necessary to unlock the electric axle. To this end, it is possible to activate the "Car Wash" mode as indicated below:

- Vehicle must be on a level surface.
- Start the electric motors.
- Put the transmission in N (Neutral) by using the control on the dashboard.

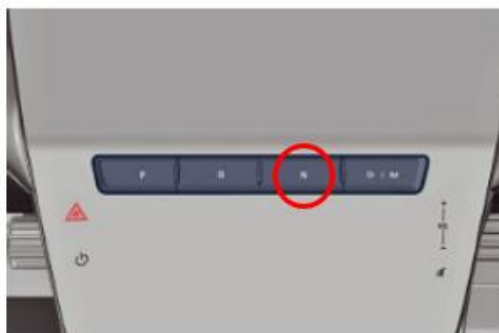

- Turn the motors off by pressing the START/STOP button.

The driver's door must be closed during these steps. This condition lasts for about 15 minutes, after which the transmission moves automatically to P (Park).

If it is not possible to start the electric motors, proceed as follows:

- Perform Key ON (12V power supply required)
- Deactivate the electric parking brake.
- With the brake pedal pressed, keep the Neutral (N) button pressed until the vehicle deactivates the Park state (the message appears on the display)

Attention: In this state, it is not possible to turn the Key OFF; put the vehicle back into Park (P) to be able to turn it off.

ATTENTION: The vehicle cannot be towed on its wheels but can only be pushed by hand or with a vehicle pusher (Maximum speed =5 km/h (3 mph)).

3 Pre-Delivery inspection checklist

To support you in delivering the new Maserati GranTurismo & GranCabrio Folgore, we have developed a specific checklist, adding new checks to test the new features and ensure that the customer can drive the car with maximum satisfaction. The checklists are attached to this communication; they apply to both models, therefore replacing those previously published. The checklist will guide you through the various stages of vehicle inspection and preparation. Each checklist includes a set of actions and procedures to be carried out on each car during the PDI. At the end of each car preparation, we ask you to keep a copy of the checklist, signed by the operator who has performed the checks, to support process traceability that could be helpful to improve the quality of the service offered, where necessary. Maserati could also request a copy of the same during the PDI or the contractual warranty period for product improvement or for warranty claims assessment purposes. The inspection time required for PDI Operation is 60-90 minutes based on the level of control required or the market's specifications.

PDI procedure to carry out with MDEVO

The warranty start date and "Customer Mode" setting to be performed during PDI are described in Circular Letter "MAS003368 MTB 22-31 New Logistics Mode removal procedure" (or Newer).

4 Activation of the technical team

A cross-functional Technical Team has been established, comprising individuals from Product Support, Engineering, Quality, Spare Parts, Customer Care, and RAM departments. In addition to introducing innovative technical content, the team is dedicated to offering comprehensive support for accurate diagnosis and resolution during initial interventions within the network. Furthermore, they aim to conduct swift and effective investigations into all reported anomalies. **For details on submitting BOLs to report anomalies, please consult the latest "Blue On-Line Policy Update" Bulletin located in Modis and the Aftersales WhiteBook.**

To monitor the correct progress of the vehicle repair on new models and ensure corrective action for anomalies found during PDI. Maximum care is required in manually setting the Service Entry status. Please also remember that the Service Entry status is automatically set up in "Awaiting Spare Parts" when the parts to be replaced are related to interventions covered by the contractual warranty and ordered in VOR mode. With a view to product improvement and to allow Maserati to improve the diagnostic effectiveness, you will also need to promptly analyze the defective components that have been replaced. For this purpose, applying the following indications for the entire duration of the Technical Team is required:

1. A warranty claim must be entered within two working days of closing the Service Entry.
2. Components replaced and requested for urgent return must be sent within two working days of receiving the request. Please refer to the Maserati warrant urgent parts return bulletin in Modis for details.

5 Technical Documents and Special Tools

5.1 Technical Information

TechDocs has been updated to include technical documentation for the new GranTurismo and GranCabrio:

- Parts catalog
- Labor Times
- Workshop Manual
- Wiring Diagrams
- Diagnostic Help

5.2 Special Tools

Maserati has created a set of special tools specifically for the new GranTurismo and GranCabrio Folgore to ensure the highest levels of quality in driving assistance and safety. Such mandatory tools will be supplied automatically and will also be present on the ModisCS+ Special Tool Catalog. The tools created are listed below in the table:

Part Numbers	Description
900001694	HVB handling spider
900001695	HVB Ground support tray
900001693	HVB lifter tray interface
900030836	Rear axle removal equipment
900030918	Front axle removal equipment
900031018	Front axle bench support bracket
900031017	Rear axle bench support bracket.
900031014	Front motor centering brackets
900031015	Front axle lifting equipment
900031016	Rear axle lifting equipment
900030922	Adapters for the coolant circuits drain
900031097	Insertion guide for front/rear axle seal
900100007	Breakout box for high-voltage system voltage and insulation measurements
900031020	Battery pack and battery cooling circuit leak tester
900031127	Plug kits for the leak tester
900030810	Cable for HV battery off-board diagnosis
900100011	Driving tool for the front subframe
900030923	BEV centering columns

Furthermore, how to use each tool will be detailed in the relevant procedure in ModisCS+.