

ATTENTION:
 GENERAL MANAGER
 PARTS MANAGER
 CLAIMS PERSONNEL
 SERVICE MANAGER

IMPORTANT - All Service Personnel Should Read and Initial in the boxes provided, right.

© 2023 Subaru of America, Inc. All rights reserved.



QUALITY DRIVEN® SERVICE

PRODUCT ENHANCEMENT PROGRAM

APPLICABILITY: 2023MY Solterra

NUMBER: EEA-23R

SUBJECT: 2.5 Product Enhancement Reprogramming File Availability

DATE: 10/02/23

REVISED: 09/09/25

INTRODUCTION:

This Product Enhancement Program announces the availability of a new reprogramming file package for the EV, EV Battery, Motor Generator, Rear Motor Generator, Plug-in Control, Air Conditioner, Combination Meter control modules. This software update package has been developed to:

- Enhance DC Fast-charging performance, reducing DC charging time.
- Enhance the displayed driving range accuracy.
- Display the State-of-Charge (SOC) during driving and when charging.

CAUTION: VEHICLE SERVICING PERFORMED BY UNTRAINED PERSONS COULD RESULT IN SERIOUS INJURY TO THOSE PERSONS OR TO OTHERS.

Subaru Service Bulletins are intended for use by professional technicians ONLY. They are written to inform those technicians of conditions that may occur in some vehicles, or to provide information that could assist in the proper servicing of the vehicle. Properly trained technicians have the equipment, tools, safety instructions, and know-how to do the job correctly and safely. If a condition is described, DO NOT assume that this Service Bulletin applies to your vehicle, or that your vehicle will have that condition.

Subaru of America, Inc. is ISO 14001 Compliant

ISO 14001 is the international standard for excellence in Environmental Management Systems. Please recycle or dispose of automotive products in a manner that is friendly to our environment and in accordance with all local, state and federal laws and regulations.

Continued...

CUW FILE INFORMATION:

System	Current Calibration ID		NEW Calibration ID	
EV-ECU	8A2524230200	SOP	8A2524230400	SU#2.5
	8A2524219100	Parts		
	8A2524230300	SU#1		
	8A2524230300	R/C		
	8A2524219200	Parts		
Motor Generator MG-F-ECU	8A2814202200	SOP	898844240000	SU#1
	8A2814208100	Parts		
	898844240000	SU#1	No Change	-
	8A2814202300	R/C		
	8A2814208200	Parts		
Rear Motor Generator MG-R-ECU	8A2914201200	SOP	898844241000	SU#1
	8A2914204100	Parts		
	898844241000	SU#1	No Change	-
	8A2914201300	R/C		
	8A2914204200	Parts		
EV Battery BAT-ECU	8989F4210100	SOP	8989F4210300	SU#2.5
	8989F4210200	SU#1		
Plug-in Control PWC-ECU	892634212000	SOP	892634233100	SU#2.5
	892634218000	SU#1		
	892634218000	R/C		
	892634233000	R/C		
A/C-ECU	8865F4213002	SOP	8865F4213100	SU#1
	8865F4213100	SU#1	No Change	-
	8865F4213100	R/C	No Change	-
Meter-ECU	8380042V410F	SOP	8380042V4113	SU#2.5
	8380042V4110	R/C		
	8380042V4111	R/C		
	8380042V4112	R/C		

Continued...

COMPONENT CONFIGURATION:

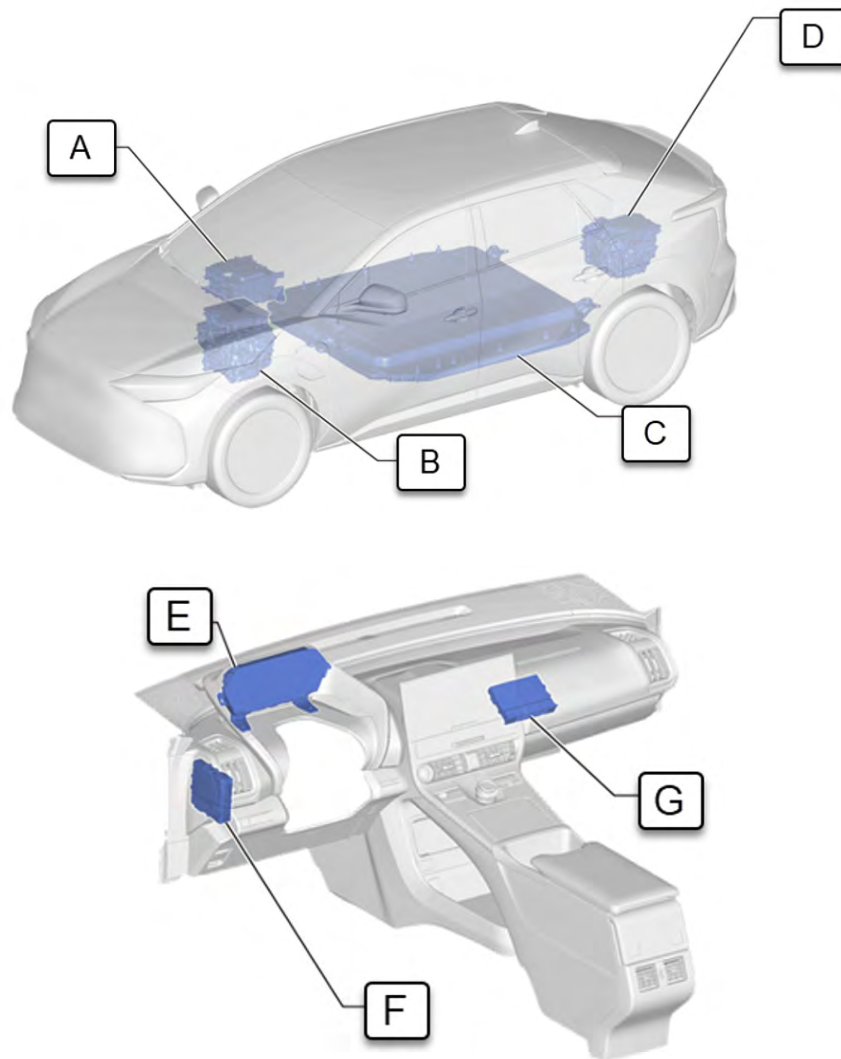

A	PWC ECU (ELECTRIC CONVERTER UNIT ASSEMBLY)	B	MG ECU (FR E-AXLE ASSEMBLY)
C	BAT ECU (EV SUPPLY BATTERY ASSEMBLY)	D	MG ECU (RR E-AXLE ASSEMBLY)
E	METER ECU (COMBINATION METER ASSEMBLY)	F	EV ECU (EV CONTROL ECU)
G	A/C ECU (AIR CONDITIONING AMPLIFIER ASSEMBLY)		

Continued...

SERVICE PROCEDURE FLOWCHART:

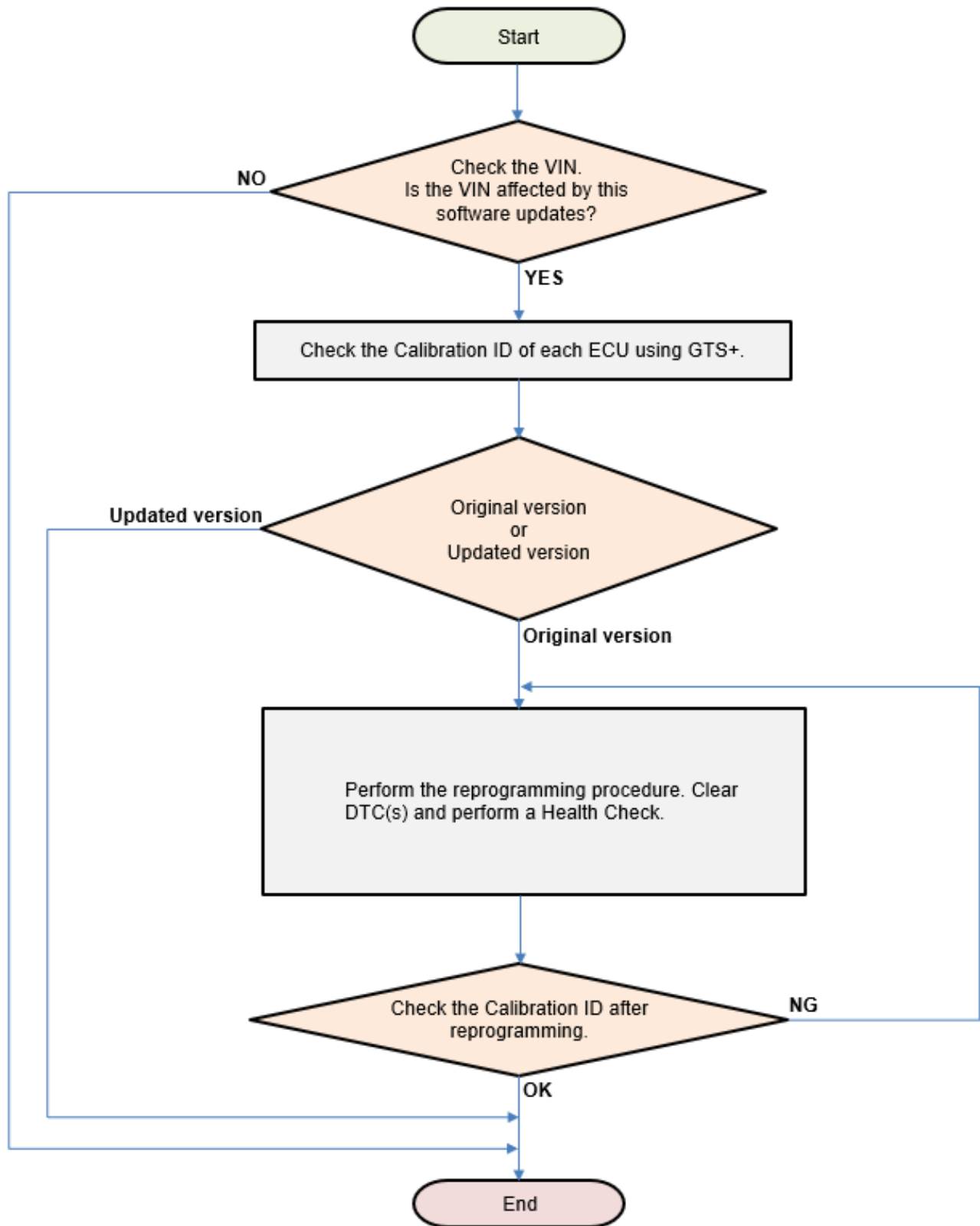

Continued...

SERVICE PROCEDURE INFORMATION:

STEP 1: Turn off vehicle electrical systems to reduce electrical load.

- Turn off all electrical accessories (i.e., climate control, audio-navigation system, etc.).
- Set headlight switch to DRL OFF position.
- Set windshield wiper switch to OFF position.
- Set driver easy exit seat slide function to OFF position.
- Confirm all exterior lighting systems are off.
- Turn off interior lighting systems (confirm that no light comes on even if a door is opened)
- Disable the seat belt warning system (this can be turned off via the buckle switch).
- Turn off the seat heaters and/or ventilation system (only for the vehicle to which it is equipped).
- Disable the rain sensing function (only for the vehicle to which it is equipped).
- Confirm the rear defogger system is off.
- Confirm the steering wheel heater is off (only for the vehicle to which it is equipped).
- Disable any additional/aftermarket accessories (security system, etc.).

STEP 2: 12 Volt auxiliary batter power supply.

- A. Inspect vehicle 12 Volt auxiliary battery. Confirm the battery is in good condition. Connect and turn on the power supply.
- B. Push the power switch  **without** pressing brake pedal (Power-ON), wait for 1 minute, then check if battery voltage is at least 12.0 Volts. If the battery is below 12.0 Volts, charge the battery before performing reprogramming. Subaru of America, Inc. (SOA) highly recommends utilizing the Subaru Midtronics DCA8000 Dynamic Diagnostic Charging System to the vehicle in the Power Supply Mode feature anytime a vehicle control module is being reprogrammed. Once the Midtronics charger is connected to the vehicle, if the battery is fully charged, it will take less than three (3) minutes to boot-up the charger, select the Power Supply Mode, and have the battery voltage stabilized and ready for reprogramming.

Continued...

BATTERY CHARGER NOTES:

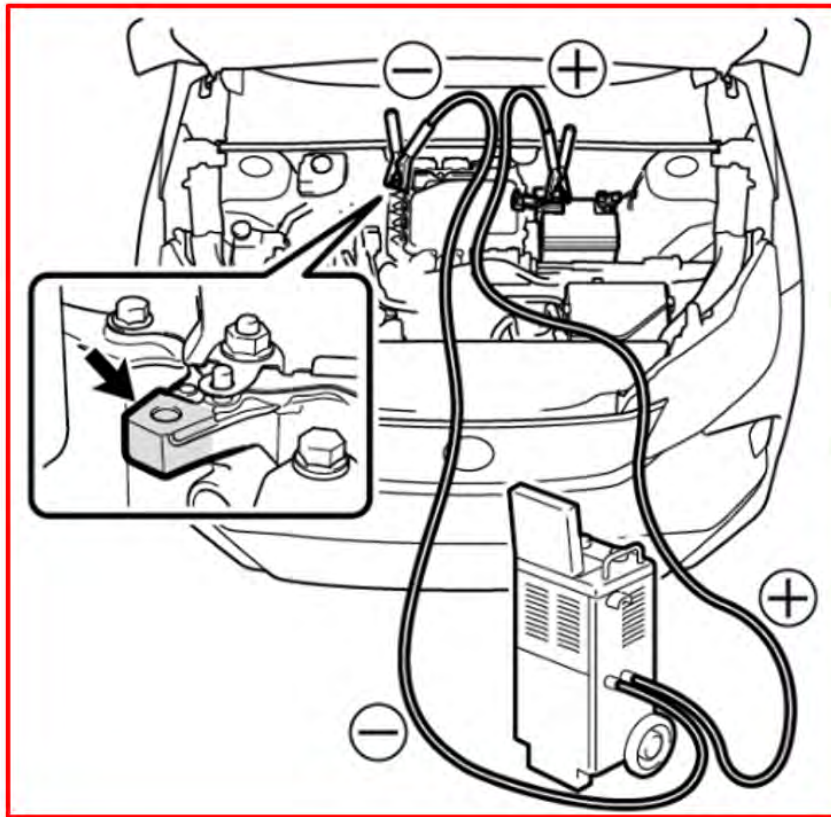

- For instructions on using the Power Supply Mode, reference the applicable User Manual for the Midtronics DCA-8000 Dynamic Diagnostic Charging on STIS.
- Select the correct battery type (Enhanced Flooded, Flooded, Gel, AGM or AGM Spiral).
- Input the CCA which matches the vehicle's battery.
- If using a DCA-8000 Dynamic Diagnostic Charging System, set the power supply voltage to 13.5 Volts.
- DO NOT connect the GTS+ until the Power Supply mode function has completed its battery test mode and the Charging Voltage has dropped to and shows a steady 13.5 Volts on the display.
- Once Power Supply Mode reaches a steady 13.5 Volts, connect the GTS+ to the OBD connector and proceed with initiating the normal reprogramming process.
- Amperage will fluctuate based upon the vehicle's demand for power. NOTE: If the voltage rises beyond 14 Volts while programming is in process, the procedure will abort. This can indicate a need to test or charge the vehicle battery before any further attempt at programming is made.
- ALWAYS set the power supply voltage to 13.5 Volts when using Power Supply Mode. NEVER turn the ignition switch on when charging at voltages 15 Volts or higher.
- Control module failures resulting from battery discharge during reprogramming are not a matter for warranty. Should any DTCs reset after the reprogramming update is performed, diagnose per the procedure outlined in the applicable Service Manual.

Continued...

REMINDER: If the DCA-8000 indicates the vehicle's battery must be charged, charge the battery fully before proceeding to reprogram the vehicle while using the Power Supply Mode.

STEP 3: Stabilize the power supply to Global TechStream Plus (GTS+).

- A. **ALWAYS** connect the GTS+ laptop to an external AC power supply.
- B. Turn off the screen saver and power saving mode of the laptop for continuous power supply to the HDD/SSD.

CAUTIONS:

- If the screen saver or power saving mode starts while reprogramming, the communication may be disconnected, resulting in the damage of the ECU.
- The ECU may be damaged if the battery voltage of the laptop drops while reprogramming.

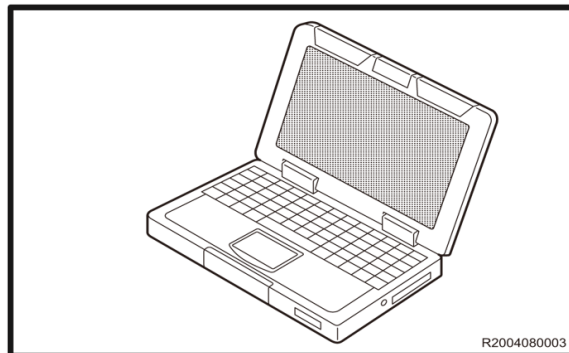
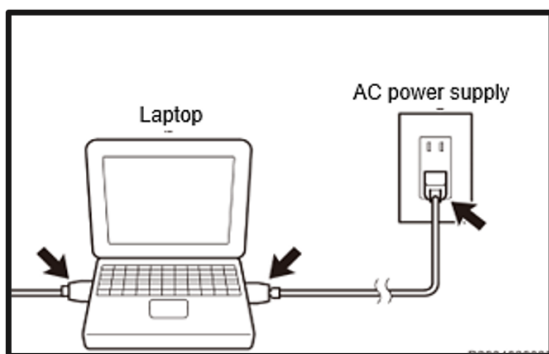

- **DO NOT** block the ventilation opening for the fan of the laptop. If the ventilation opening for the fan is blocked, the laptop may overheat, causing the laptop to stop and may damage the ECU as a result.



STEP 4: Secure the connection the of cables.

Confirm the power switch  is in the OFF position and connect the laptop to the vehicle.

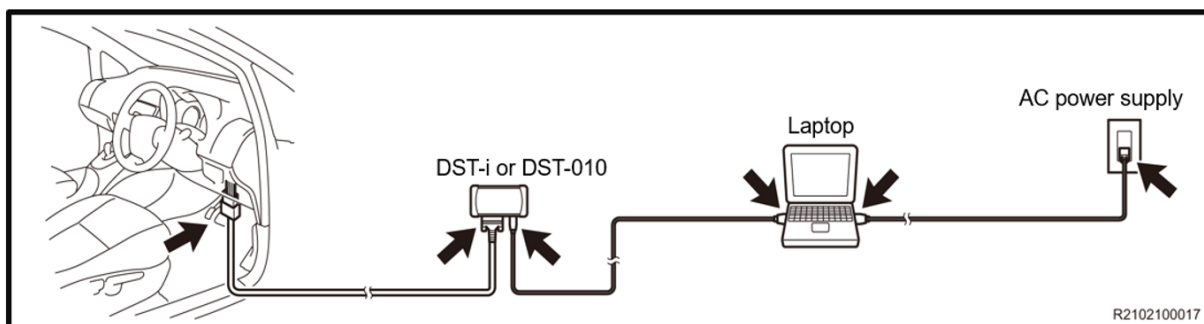

Continued...

STEP 5: Starting the GTS+ application.

- A. Click the GTS+ icon to start the GTS+ application.



- B. SSM will automatically close and the GTS+ browser will open. Set the GTS+ application region to “United States” and set the lower box to “USA” then click the Server Login link.



NOTE: In some instances, a user may have logged in previously. In these cases, if the PC has not been restarted, the screen below may appear when clicking on the GTS+ icon (Step 5-A). This is normal operation. Click the “GuestUser” link to directly login to GTS+.

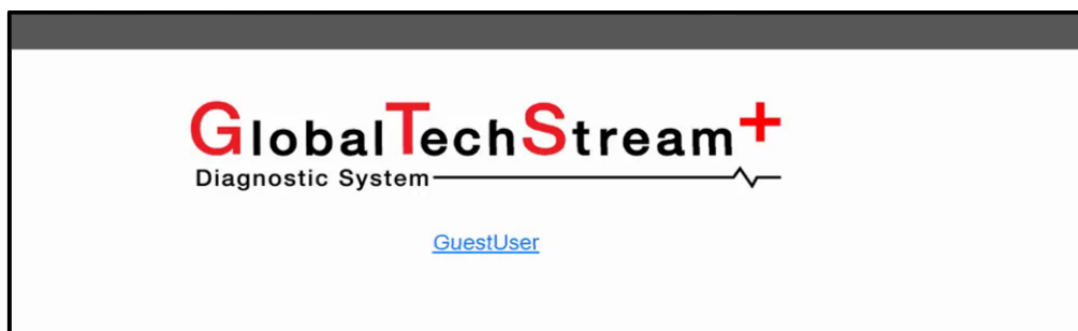

Continued...

- C. A second window will open to the Subaru Single Sign On (SSO) page. Enter your Subaru username and password (Hint: Same as SubaruNet credentials). Click the “Login” button to continue.



- D. Turn the power switch  to the ON position **WITHOUT** depressing the brake pedal. Click the “GTS+ Settings” button.

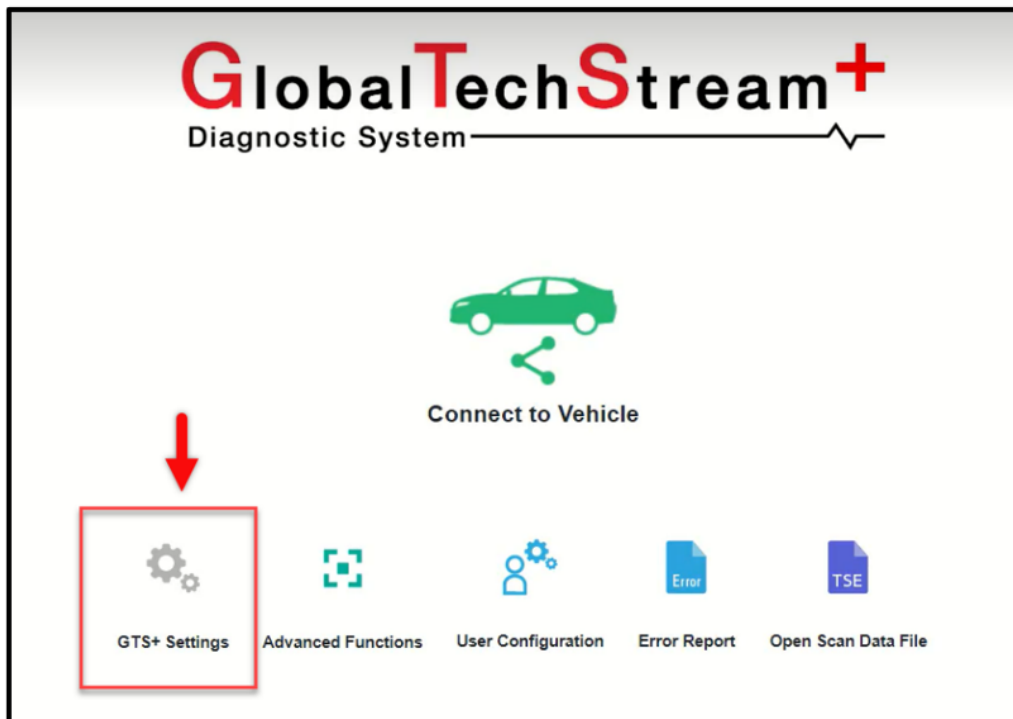

Continued...

- E. In the lower portion of the GTS+ Settings page, select the appropriate Vehicle Interface Module (VIM) such as DTS-i or DST-010. Set the “Vehicle Area” selection to North America. Click the arrow in the right corner when complete.

Optional Information

Dealer Address

Dealer Email

Dealer Website

VIM Select

Interface setup:

Vehicle Area Selection

Vehicle Configuration

Import Custom List

Import for stored custom list:

- F. Click the “Connect to Vehicle” button. Confirm the target VIN information and continue by clicking the “Next” button.

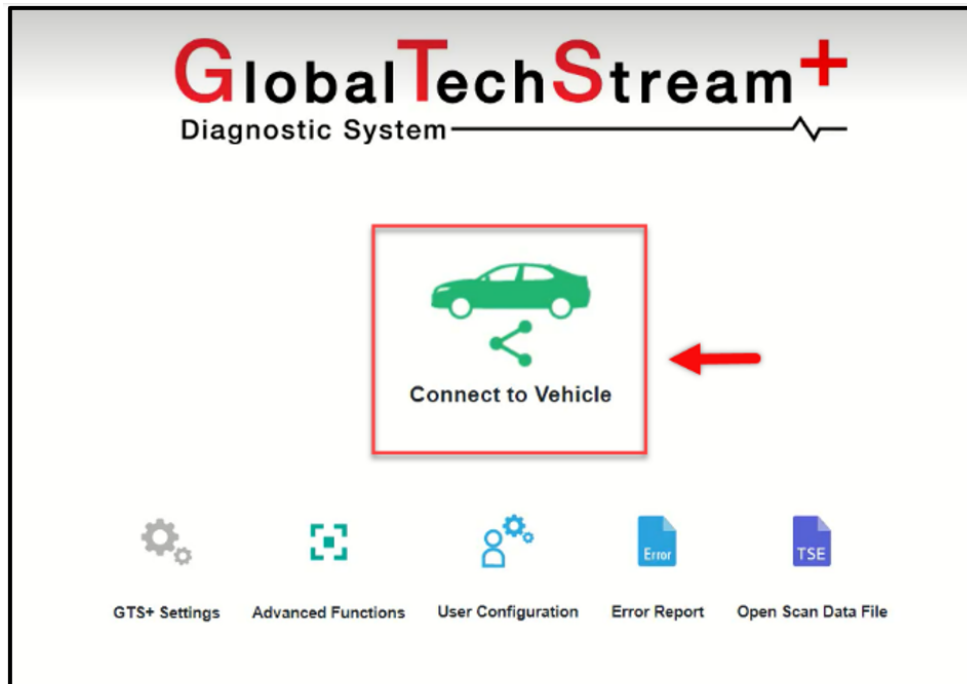

Continued...

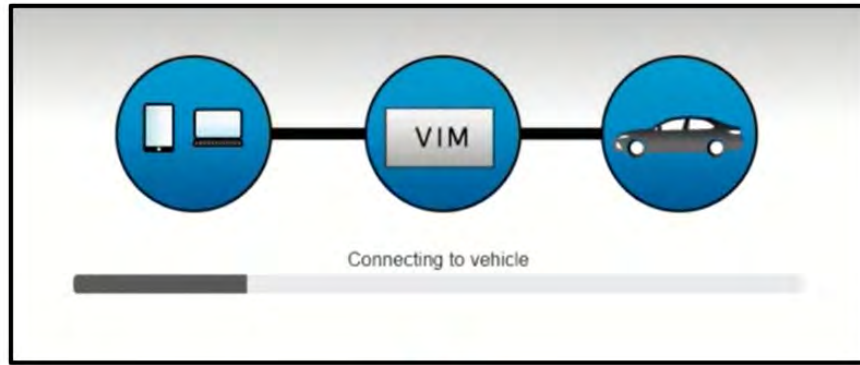

Vehicle Connection

Confirm the information and press Next

Required information

VIN: VIN reacquisition VIN manual input

Division:

Model:

Model Year:

Engine:

STEP 6: Click “Health Check” button located in the Main Menu.



STEP 7: Allow time for the Health Check to start.

2023 Solterra EV JTMABABA4PA000999 5344.63km Battery 12.1V

Health Check Result

STATUS

07/26/2023 13:58:47 Compensation Pressure [kPa(abs)]

Front:

Rear:

Caution

Enhanced Generic Checking - System 25 of 38

System	Monitor Status	Configure	Ret	DTC
EV	-	No	16	0
Motor Generator	-	No	-	0
Rear Motor Generator	-	No	-	0
EV Battery	-	No	0	0
Plug-in Control	-	No	1	0
Brake/EPB	-	No	6	0
Brake Booster	-	No	1	0
Tire Pressure Monitor	-	No	2	0
EMPS	-	No	1	0
Front Recognition Camera	-	No	16	0
Circumference Monitoring Camera Control Module	-	No	11	0
Steering Angle Sensor	-	No	0	0
Rear Camera	-	No	-	0
Air Conditioner	-	No	0	0
SRS Airbag	-	No	2	0
Main Body	-	No	12	0
Central Gateway	-	No	0	0
Back Door	-	No	2	0
Driver Seat	-	No	-	0
Master Switch	-	No	-	0
Sliding Roof	-	No	-	0

Continued...

STEP 8: While the Health Check is being performed, a pop-up will be displayed asking if you would like additional information retrieved. Click the “Yes” button to continue.

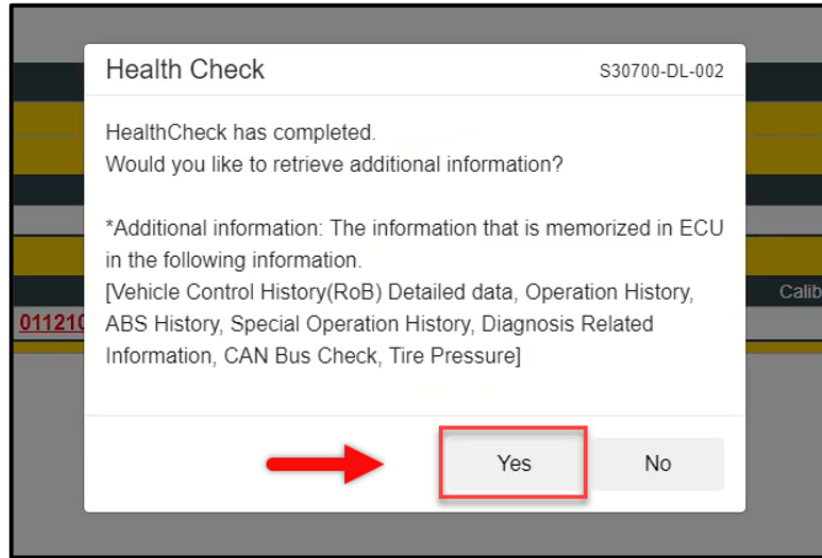

NOTE: Allow time for the Health Check retrieve the stored data. This may take up to five minutes.

STEP 9: Once the Health Check is completed, check the results for any stored DTC(s).

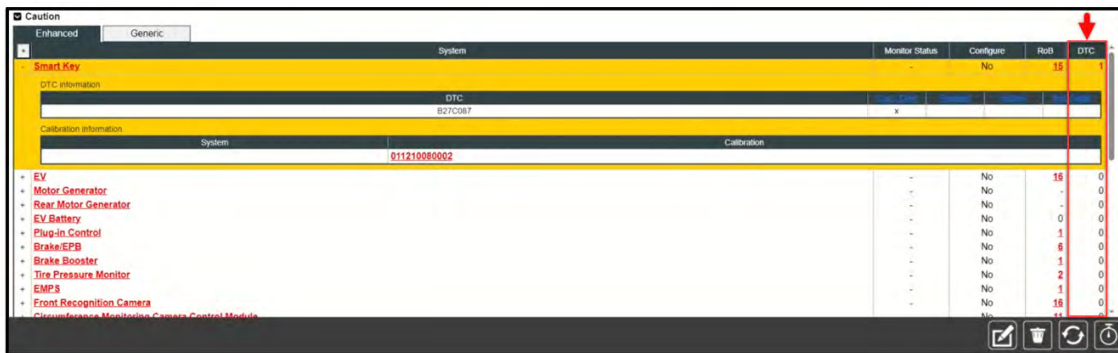

Are any DTC(s) stored?

YES: Proceed to Step 10.

NO: Proceed to Step 11.

STEP 10: Clear all DTC(s) by clicking the “Erase” button.

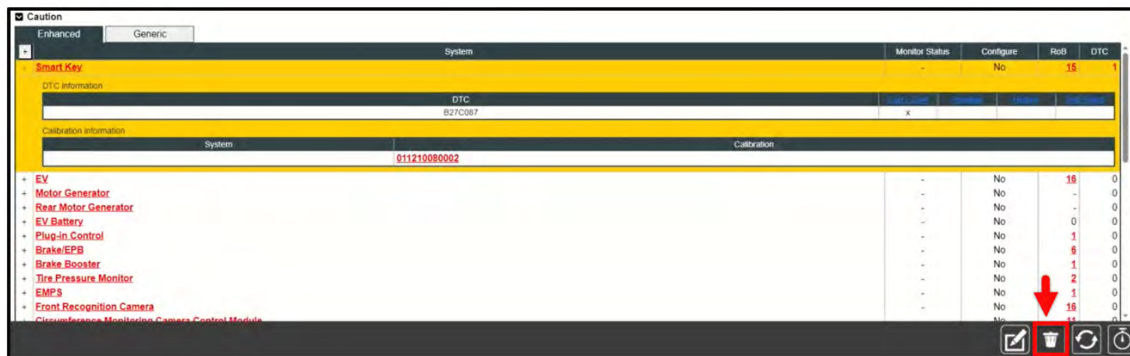

Continued...

A pop-up will display reminding all Freeze Frame and Monitor Data will be cleared. Click the “Yes” button to continue.

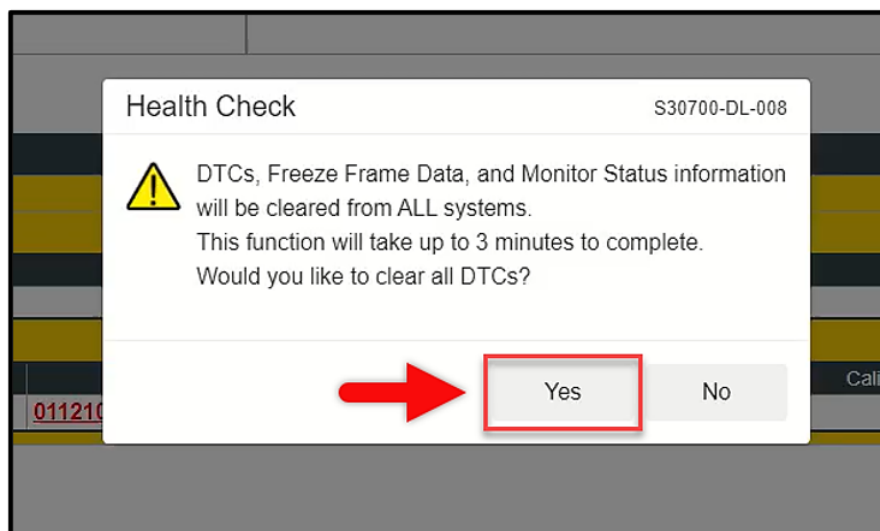

Once the clearing is complete, a second pop-up will display asking to refresh the Health Check to the updated status. Click the “Yes” button to continue. Proceed to Step 11 when no DTC(s) are detected.

IMPORTANT: If any DTC(s) continue to be stored, diagnose and repair as per the applicable Service Manual. Confirm the faults can be cleared prior to proceeding. If the DTC(s) are not cleared, the GTS+ cannot enter the reprogramming mode.

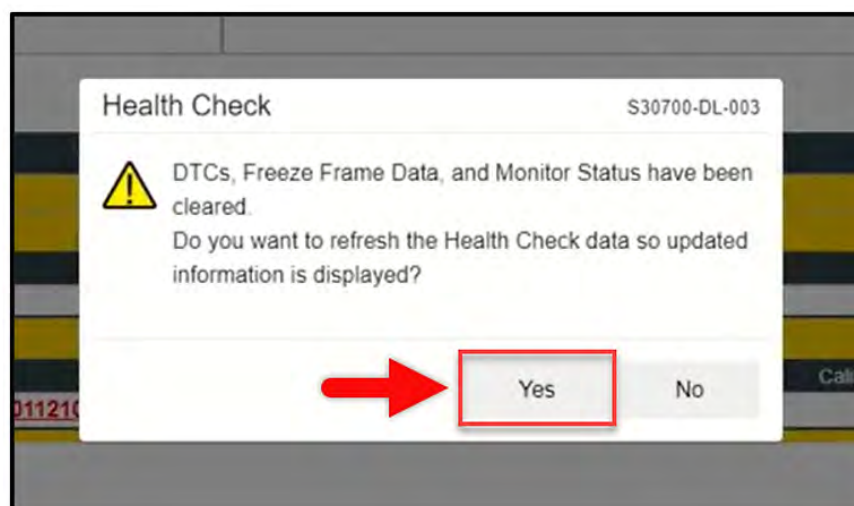

STEP 11: Click on the “Plus” symbol next to to the following control modules:

- EV
- EV Battery
- Motor Generator
- Rear Motor Generator
- Plug-in Control
- Air Conditioner
- Combination Meter

Continued...

This will expand the system information. Confirm the calibration IDs displayed match the current calibration IDs listed on page 2.

+ EV	+ Rear Camera
+ Motor Generator	+ Air Conditioner
+ Rear Motor Generator	+ SRS Airbag
+ EV Battery	+ Main Body
+ Plug-in Control	+ Central Gateway
+ Brake/EPB	+ Back Door
+ Brake Booster	+ Driver Seat
+ Tire Pressure Monitor	+ Master Switch
+ EMPS	+ Sliding Roof
+ Front Recognition Camera	+ Combination Meter
+ Circumference Monitoring Camera Control Module	+ Mirror L

STEP 12: Prepare the 2.5 Reprogramming CUW file. Select the Subaru Desktop from the lower taskbar. Select The TechStream Files icon. Open the ECU Data folder. Locate the CUW file named:

11_8A2524230400_898844240000_898844241000_8989F4210300_892634233100_8865F4213100_8380042V4113_8380042V420D.cuw



CAUTIONS:

- **ALWAYS** stay near the vehicle and **DO NOT** allow any others to operate the vehicle or GTS+.
- Never change the power switch position other than when instructed by GTS+. Unauthorized cycles of the power switch during reprogramming may cause control module failure.
- Pressing the “Cancel” button or the “X” button on the top will cancel reprogramming and could damage the ECU while reprogramming.
- Be sure to press “Retry” to continue reprogramming if the event of an error.

Continued...

STEP 13: Double-click the applicable CUW file icon. A pop-up will display requesting a manufacturer to be selected. Select “Subaru” and click the “OK” button to continue.

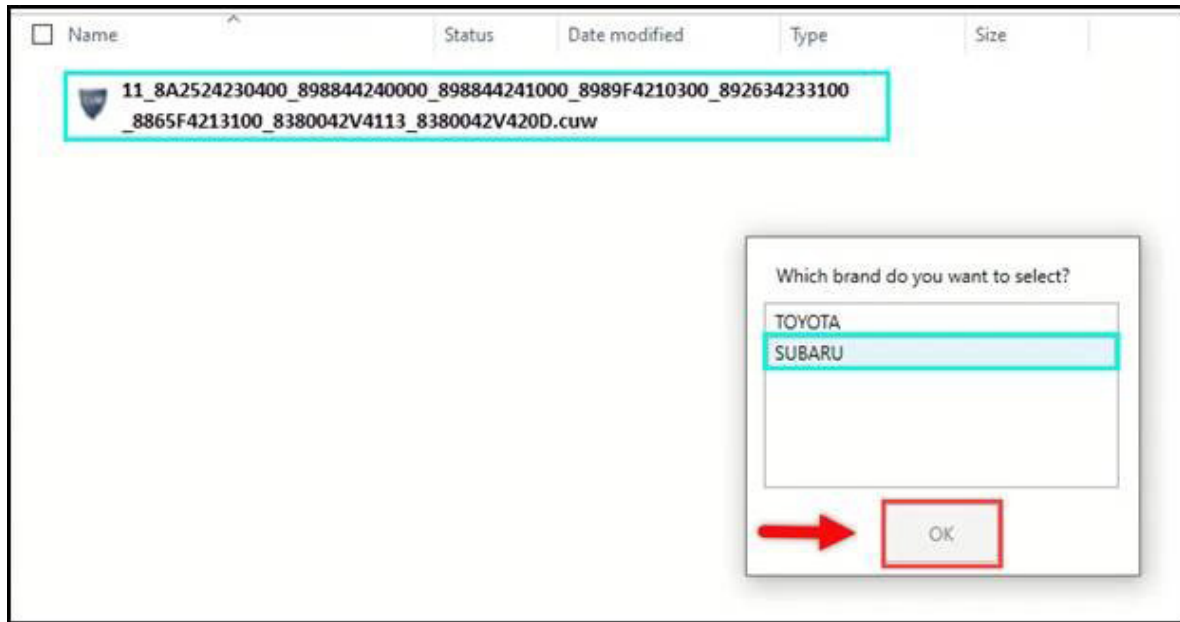

STEP 14: After double-clicking the file icon, the Calibration Update Wizard program is launched, and a new window will appear. Select the “Next” button to continue.

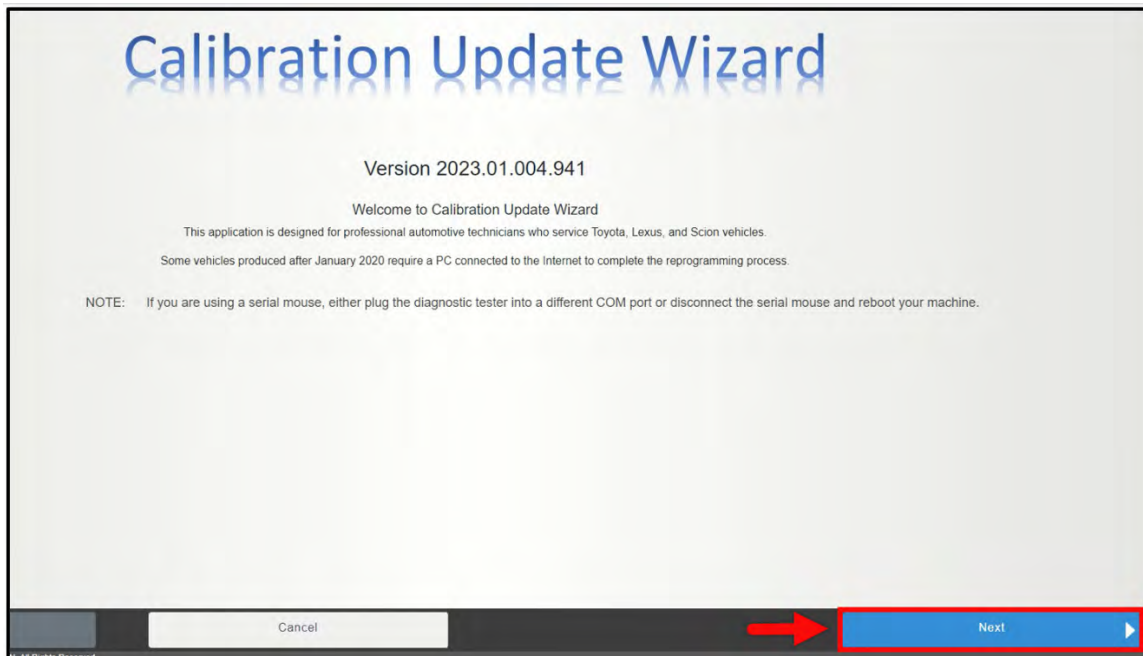

Continued...

STEP 15: Confirm the pass-through device currently being used. Select the “Next” button to continue.

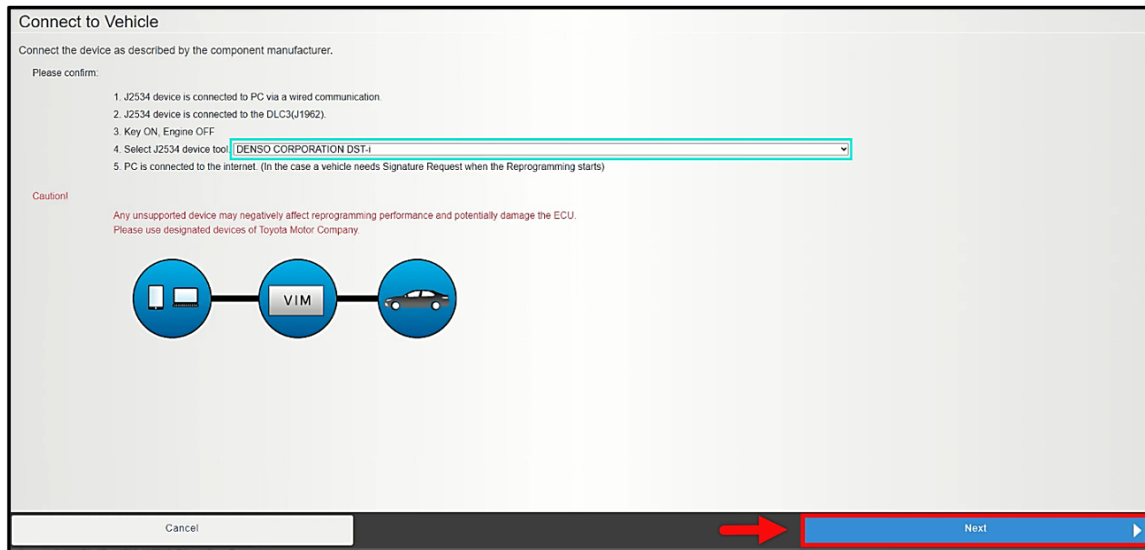

NOTE: A Progress bar will be displayed. **DO NOT** operate the power switch while the bar is shown.

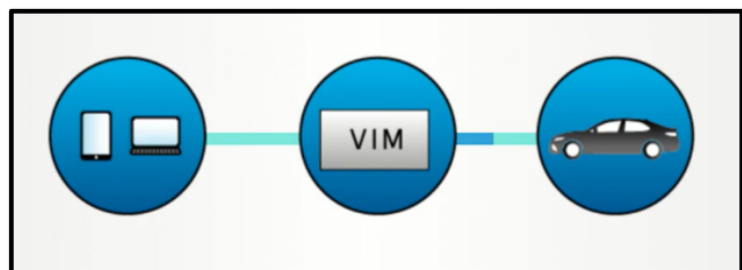

STEP 16: The Calibration Selection Confirmation window will appear. Confirm the applicable Current Cal ID and the New Cal ID. Click the “Next” button to continue.

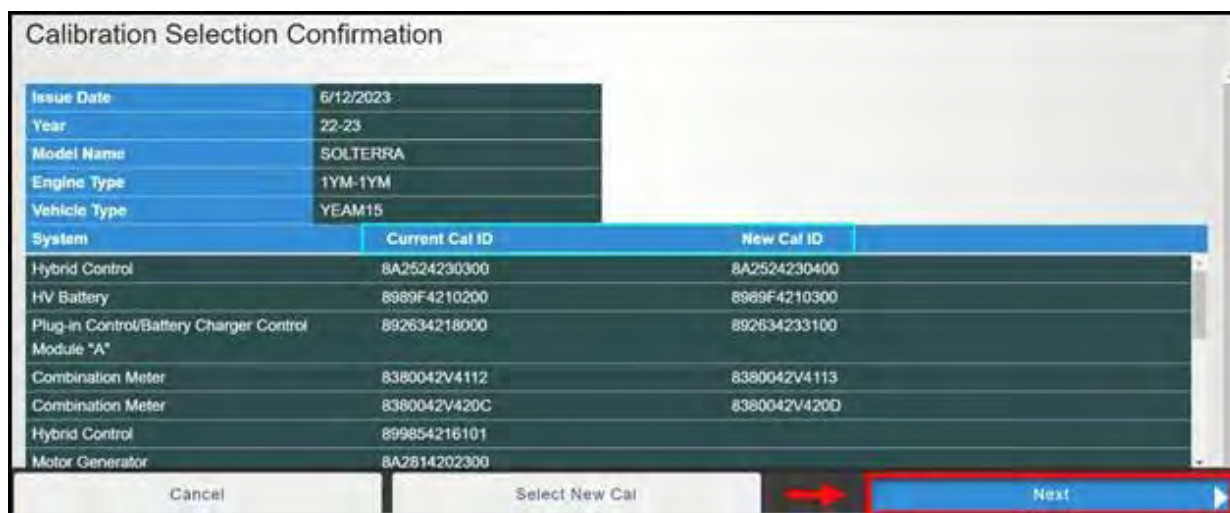

Continued...

STEP 17: Review the CAUTIONS listed. Follow the on-screen instruction, turn the power switch to the OFF position. Select the “Start” to continue.



NOTE: A Progress bar will be displayed. **DO NOT** operate the power switch while the bar is shown.

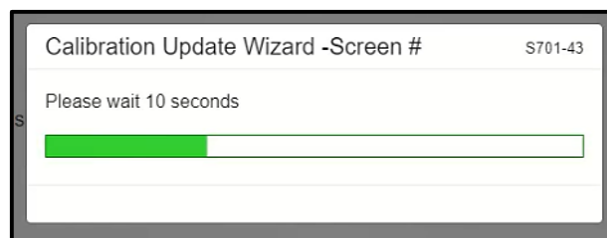

STEP 18: Review the CAUTIONS listed. Follow the on-screen instruction, turn the power switch to the ON position **WITHOUT** depressing the brake pedal. Confirm the 12 Volt auxiliary battery voltage is more than 12.5 Volts. Select the “Start” to begin the reprogramming process.

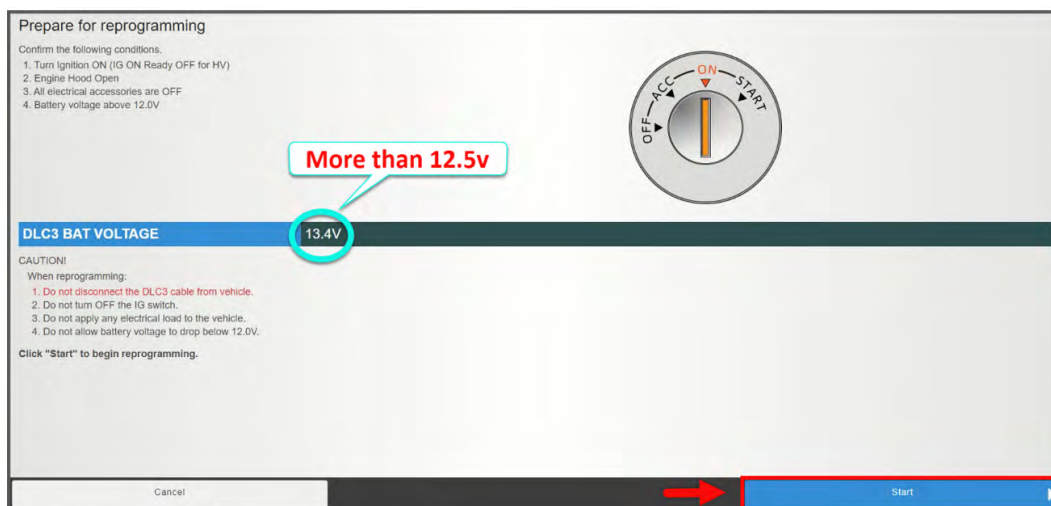

Continued...

STEP 19: Once the “Flash Calibration Update” window is shown, allow the “Toyota Service Information” browser to be displayed. Select the “Next” button to continue.

NOTE: The signature is acquired in future steps, once acquired, the signature is to be pasted into the “Signature” box.

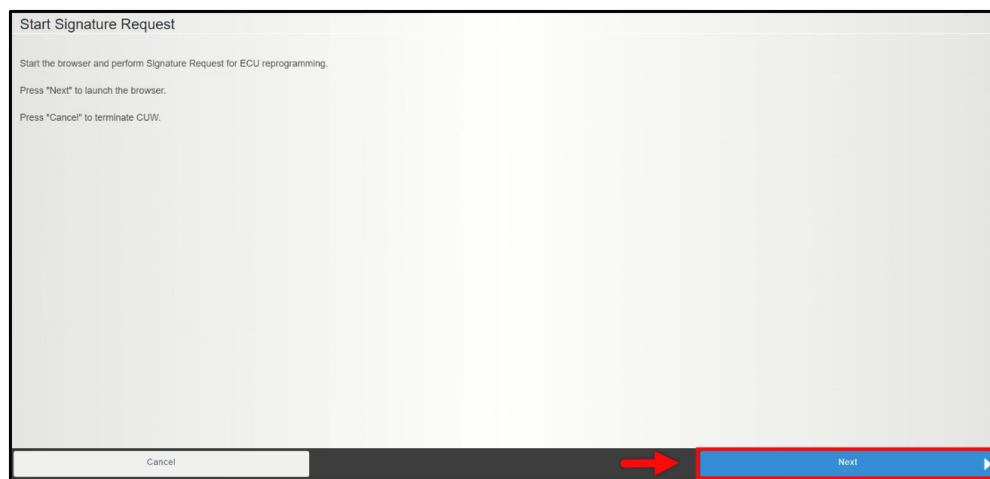
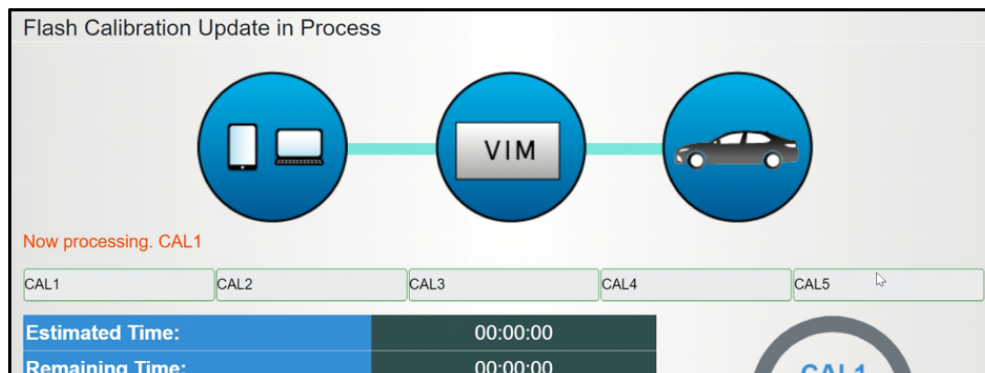

STEP 20: Once the browser is started, a pop-up will display. Click the “OK” button to continue.

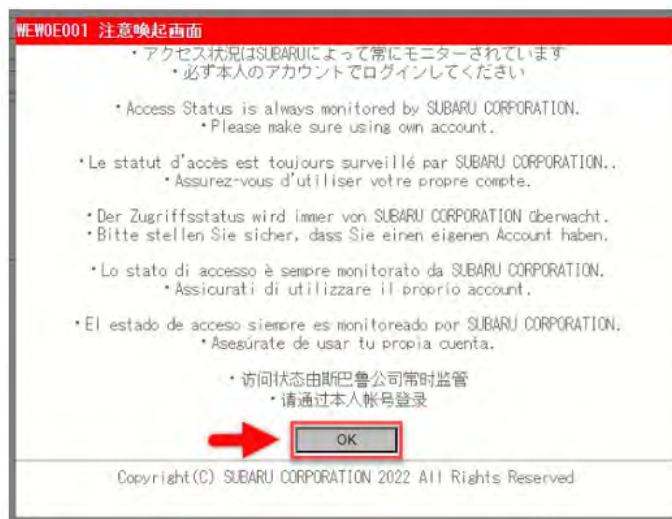

Continued...

STEP 21: Select the “Request Signature” button. This will populate in the lower window.

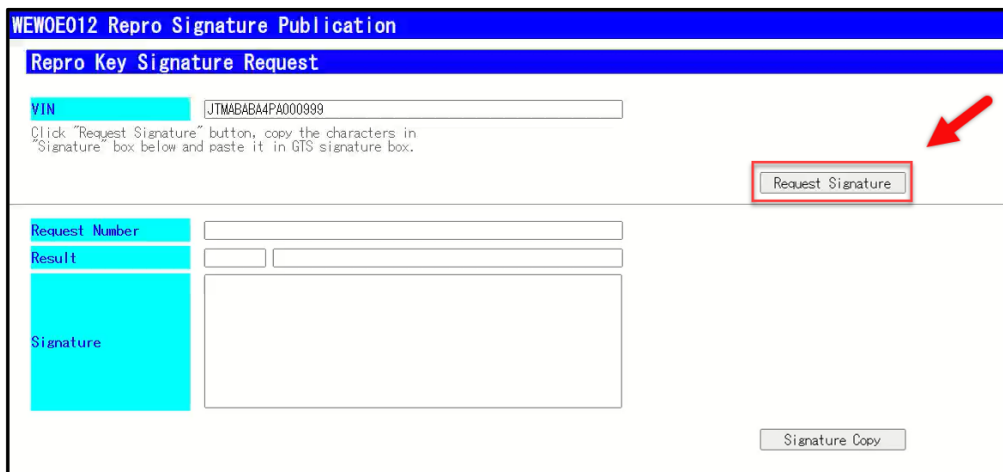

STEP 22: Select the “Copy Signature” button then minimize the window.

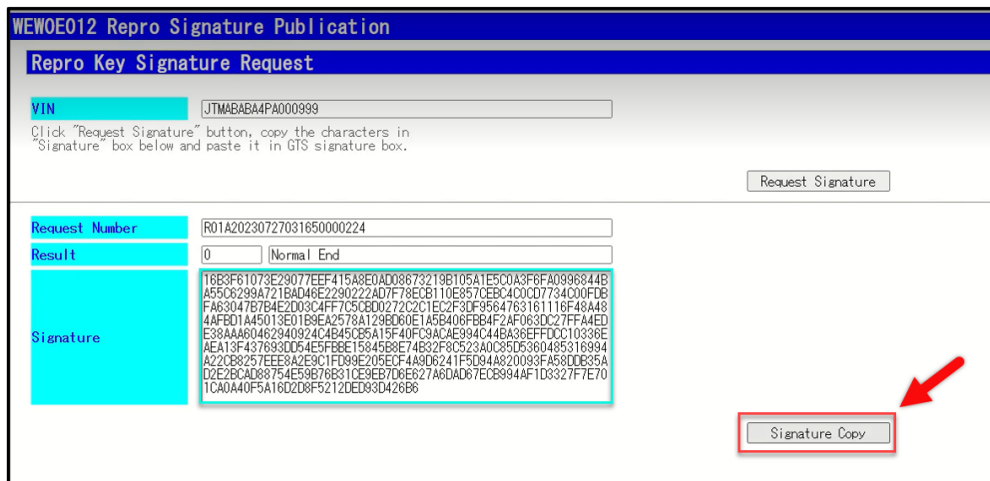

STEP 23: Return to “Calibration Update Wizard” display. Paste the signature using the right click method or using Ctrl+V on the keyboard. Once the signature is successfully pasted, click the “Next” button to continue.

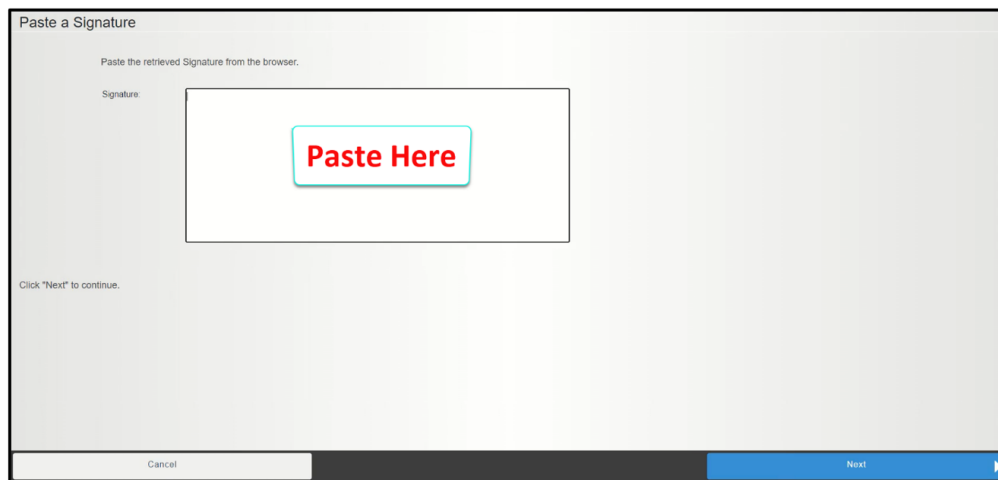

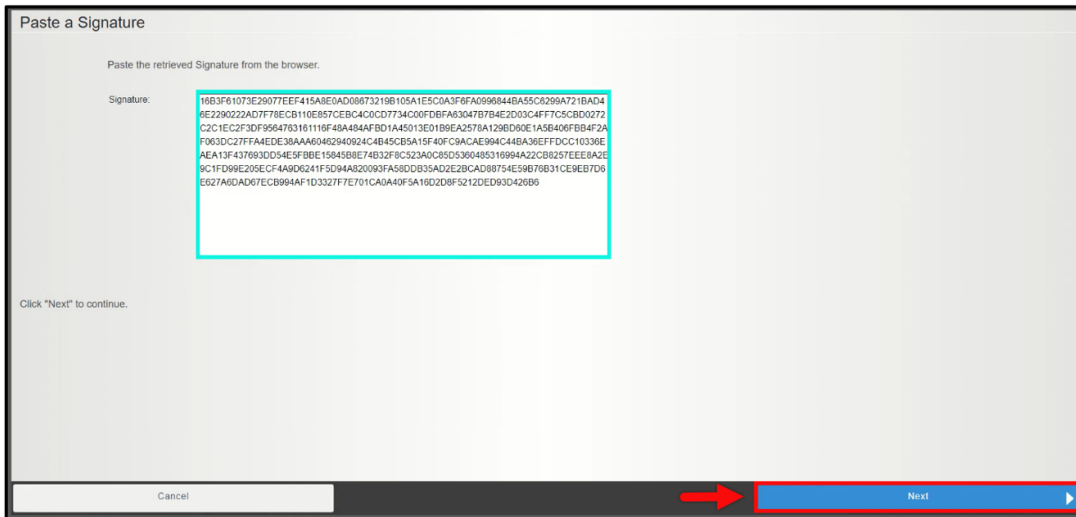

Continued...

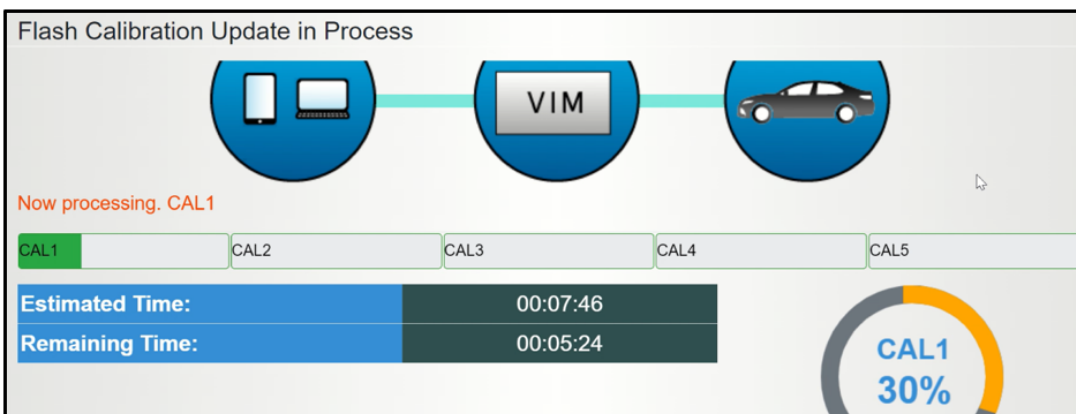

STEP 24: While the vehicle is reprogramming, the progress window is displayed. **ALWAYS** remain near the vehicle during reprogramming in order to monitor the progress.

NOTE: The headlamps may operate during this procedure.



STEP 25: Follow the on-screen instructions. turn the power switch  to the OFF position. The first calibration is complete. Click the “Next” button to continue.

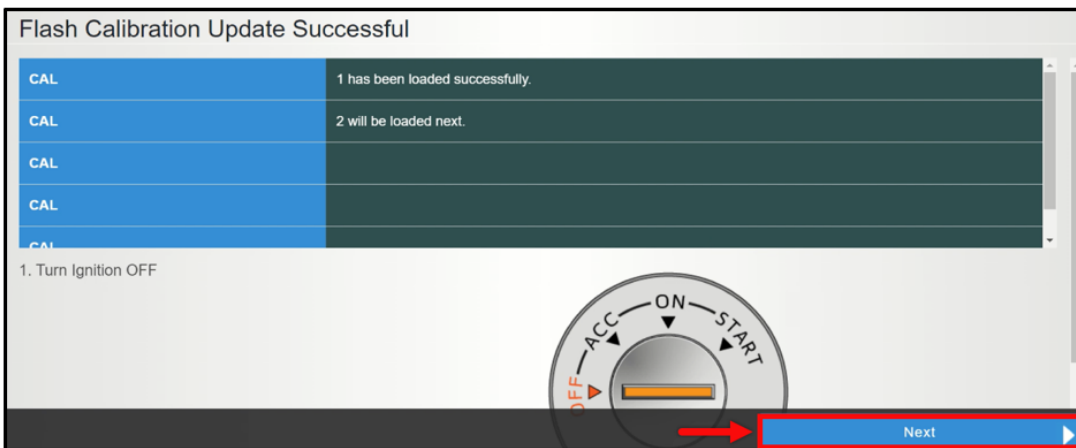

Continued...

STEP 26: Follow the on-screen instructions. turn the power switch  to the ON position. The second calibration will automatically prepare. Click the “Next” button to continue to start the signature request for the second calibration.

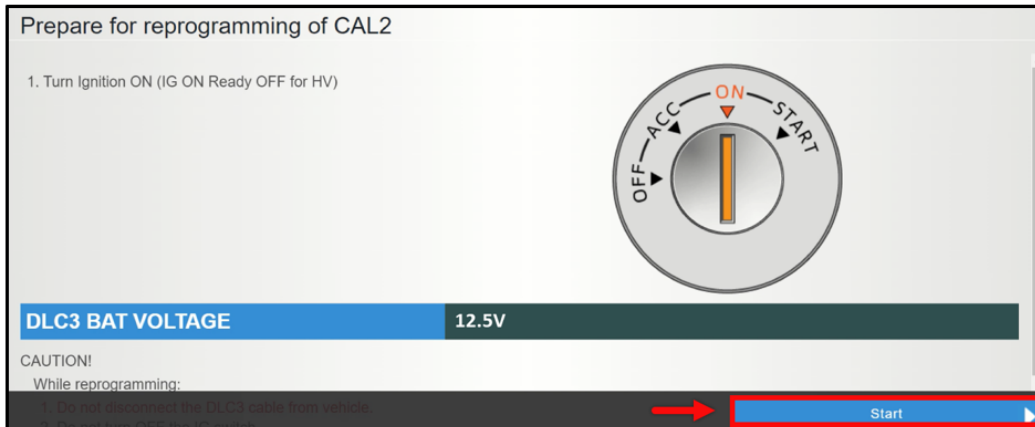

Click the “Next” button to continue.

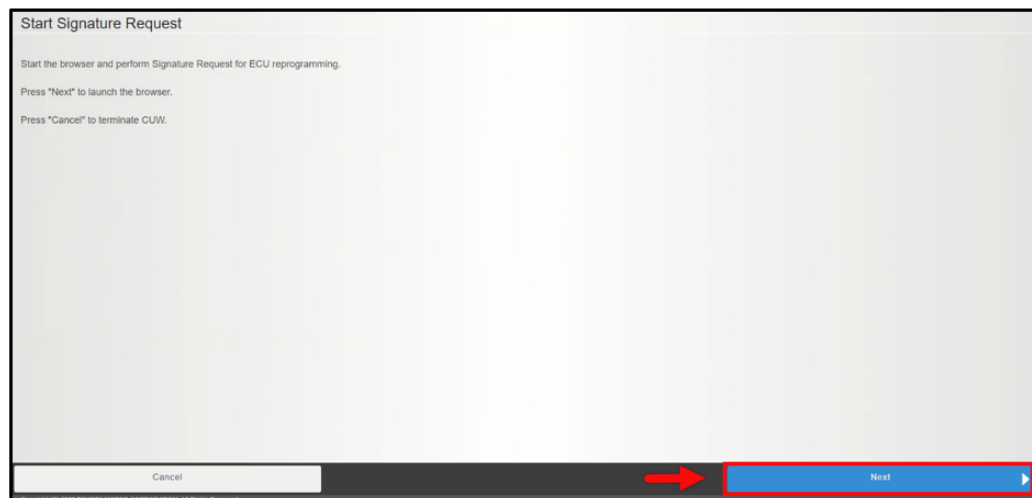

STEP 27: Select the “Request Signature” button. This will populate in the lower window.

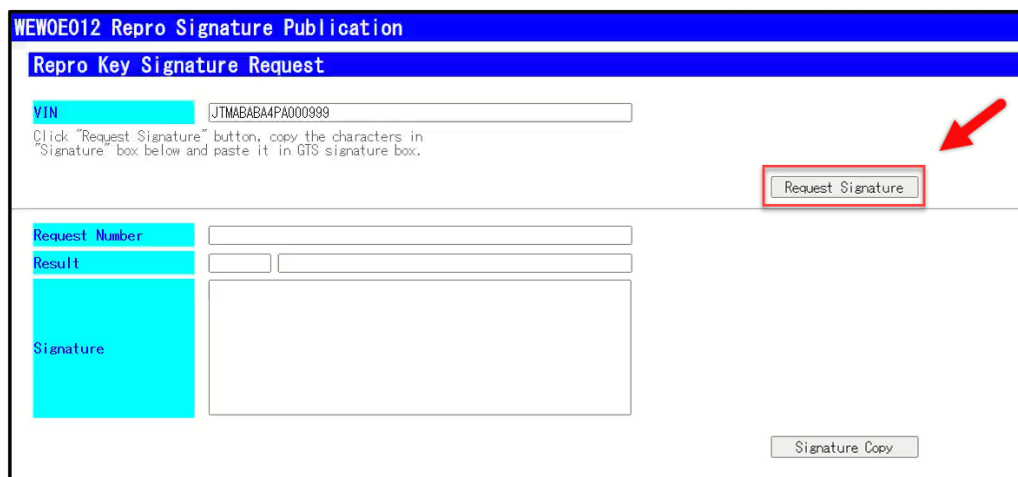

Continued...

STEP 28: Select the “Copy Signature” button then minimize the window.

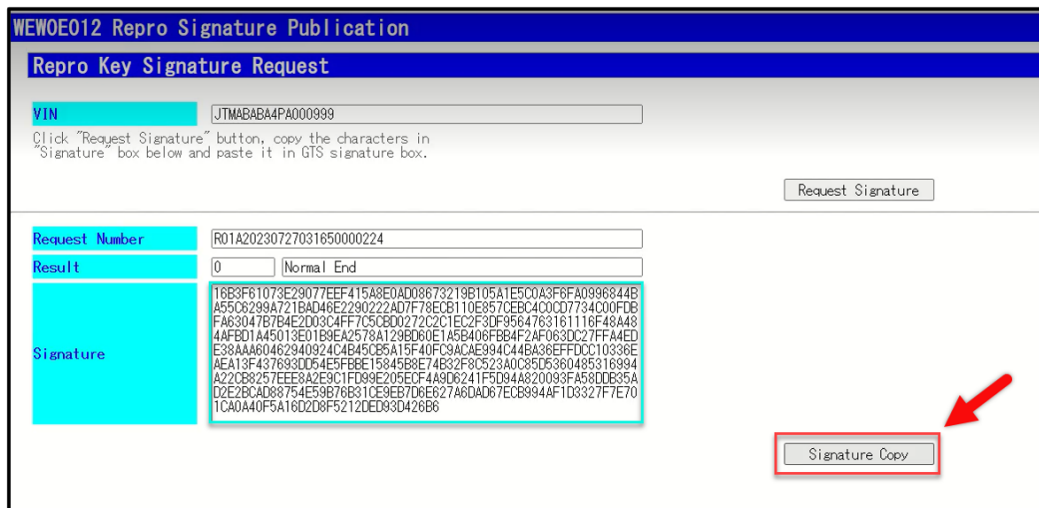

STEP 29: While the second calibration is reprogramming, the progress window is displayed. **ALWAYS** remain near the vehicle during reprogramming in order to monitor the progress.

NOTE: The headlamps may operate during this procedure.

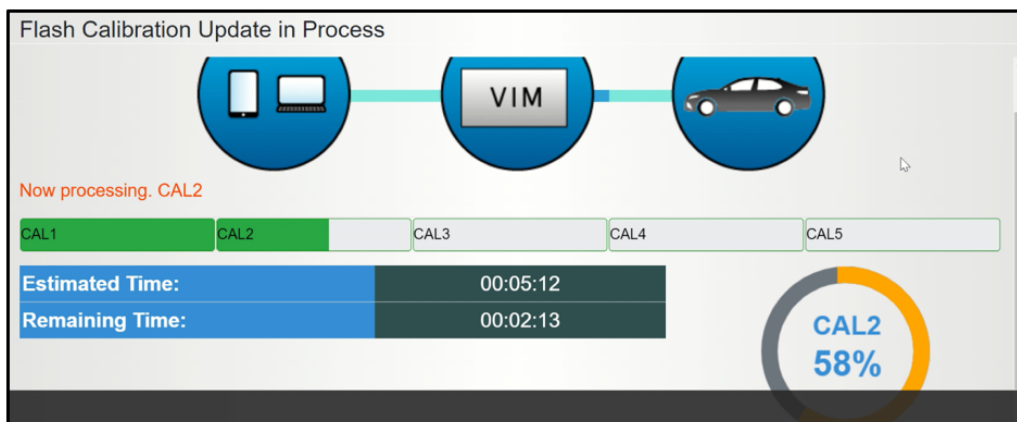

STEP 30: Follow the on-screen instructions. turn the power switch  to the OFF position. The second calibration is complete. Click the “Next” button to continue.

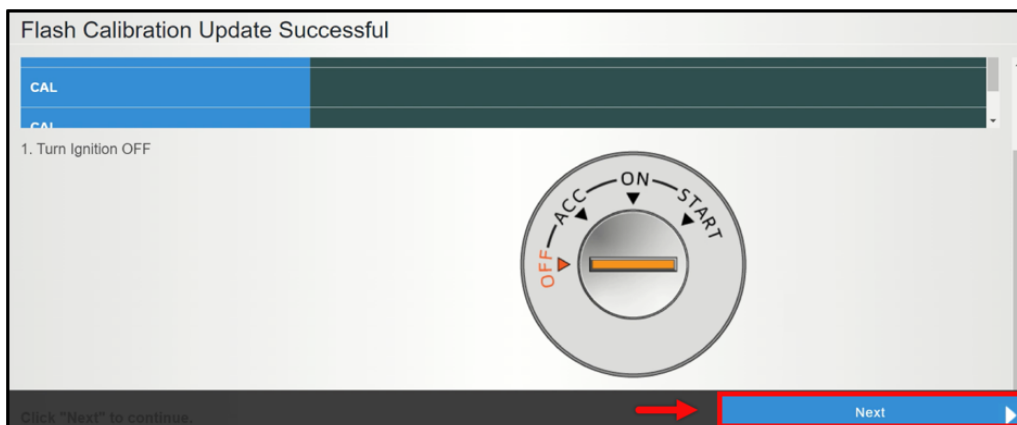

Continued...

STEP 31: Follow the on-screen instructions. turn the power switch to the ON position. The third calibration will automatically prepare. Click the “Next” button to continue to start the signature request for the third calibration.

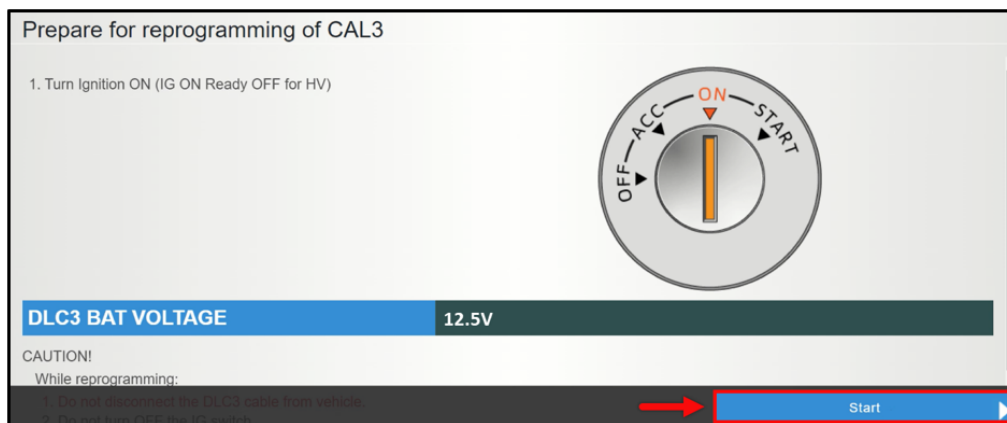

Click the “Next” button to continue.

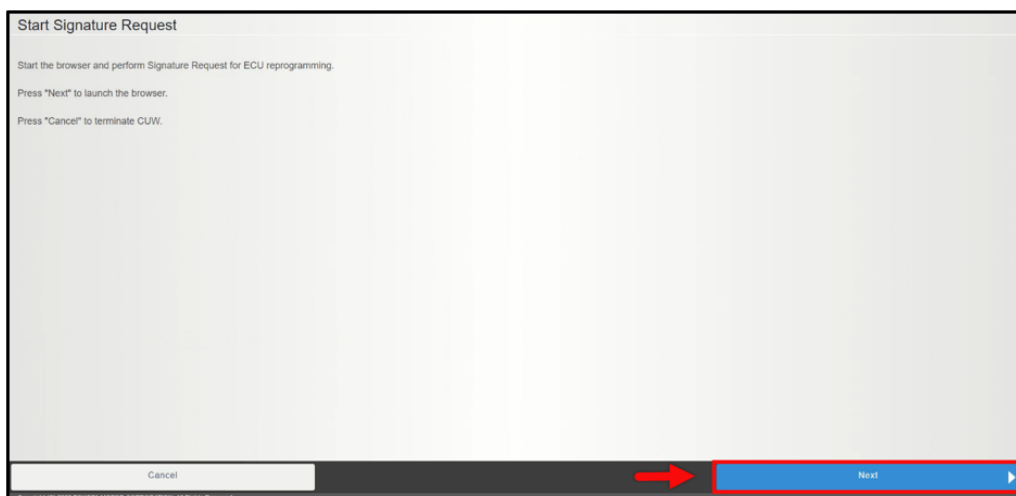

STEP 32: Select the “Request Signature” button. This will populate in the lower window.

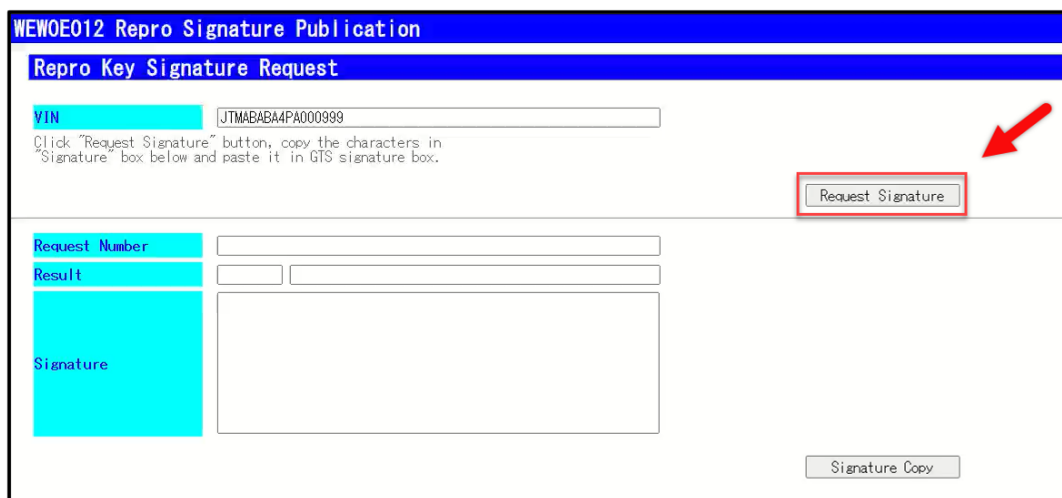

Continued...

STEP 33: Select the “Copy Signature” button then minimize the window.

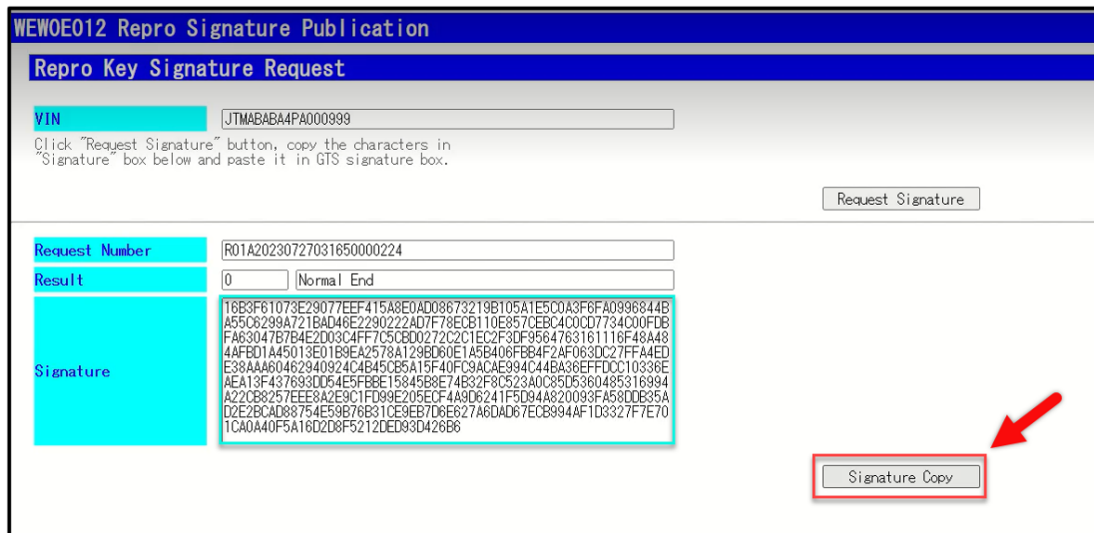

STEP 34: While the third calibration is reprogramming, the progress window is displayed. **ALWAYS** remain near the vehicle during reprogramming in order to monitor the progress.

NOTE: The headlamps may operate during this procedure.

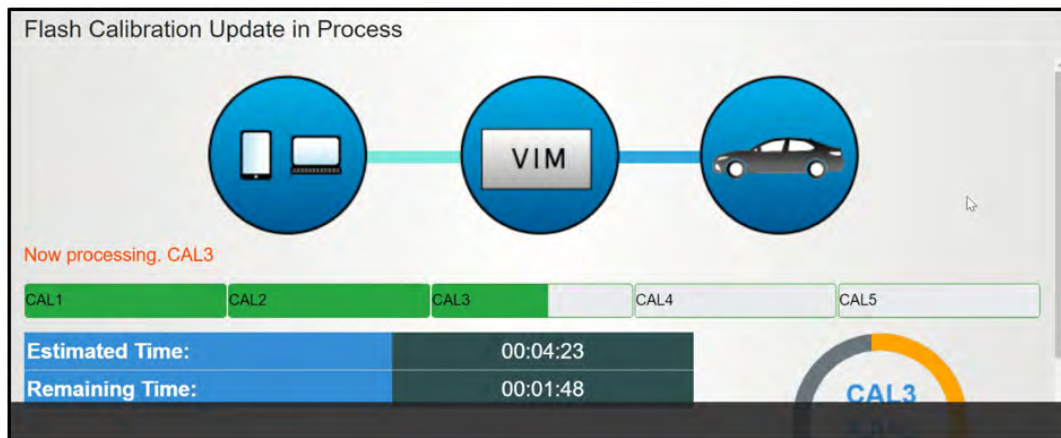

STEP 35: Follow the on-screen instructions. turn the power switch  to the OFF position. The third calibration is complete. Click the “Next” button to continue.

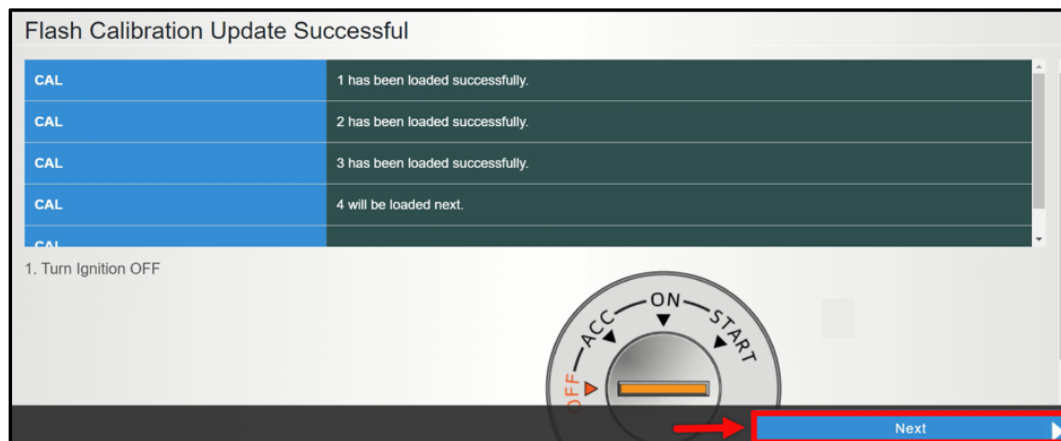

Continued...

STEP 36: Follow the on-screen instructions. turn the power switch to the ON position. The fourth and fifth calibration will automatically prepare. Click the “Next” button to continue to start the signature request for the fourth and fifth calibration.

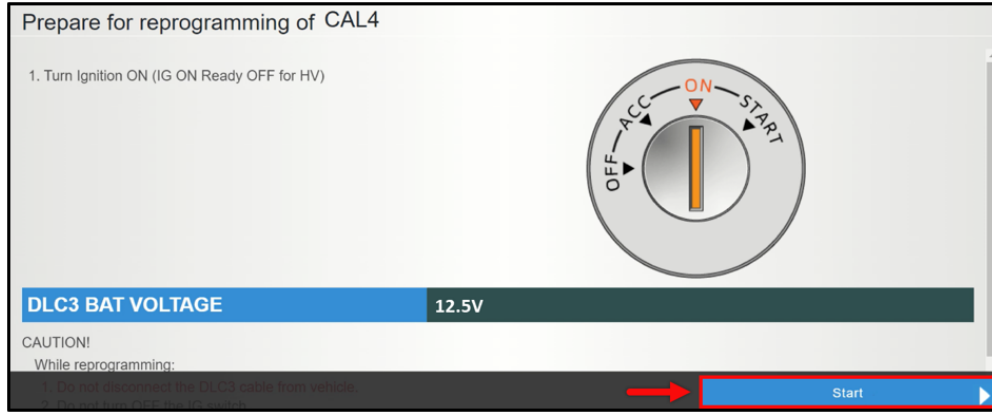

Click the “Next” button to continue.

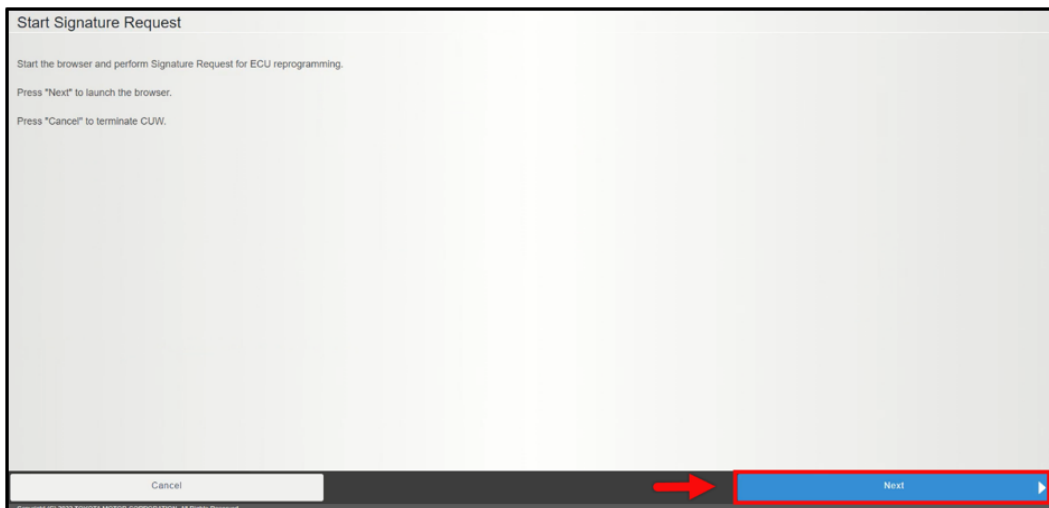

STEP 37: Select the “Request Signature” button. This will populate in the lower window.

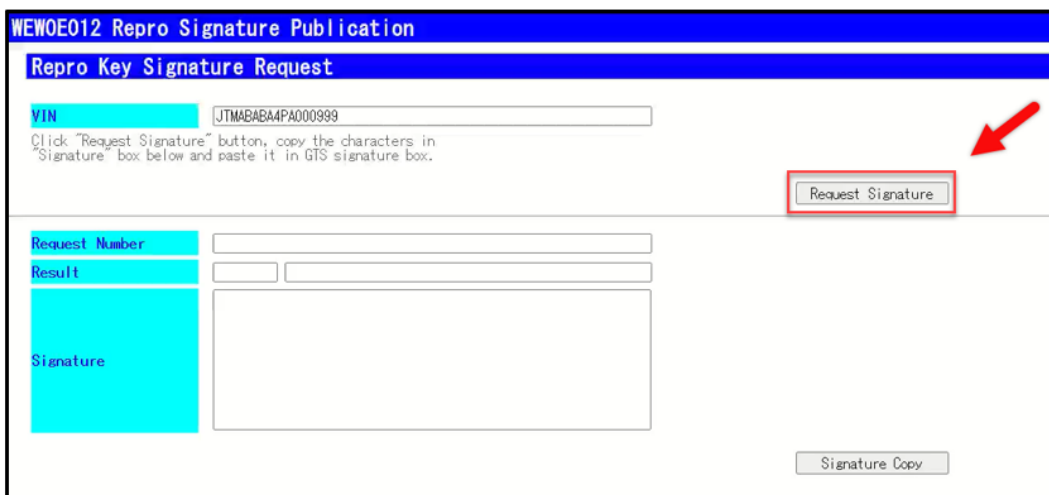

Continued...

STEP 38: Select the “Copy Signature” button then minimize the window.

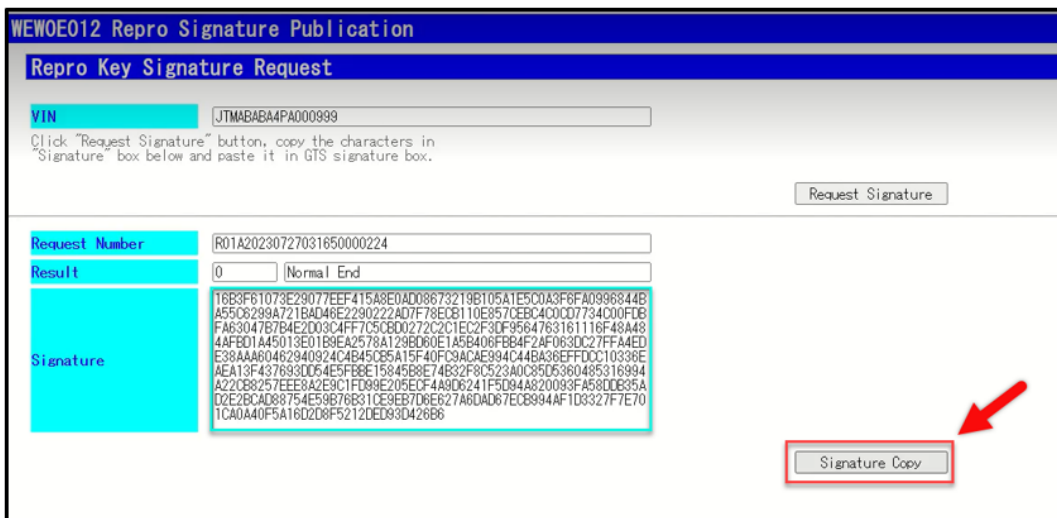

STEP 39: The fourth and fifth calibrations are performed together. While the fourth and fifth calibration is reprogramming, the progress window is displayed. **ALWAYS** remain near the vehicle during reprogramming in order to monitor the progress.

NOTE: The headlamps may operate during this procedure.

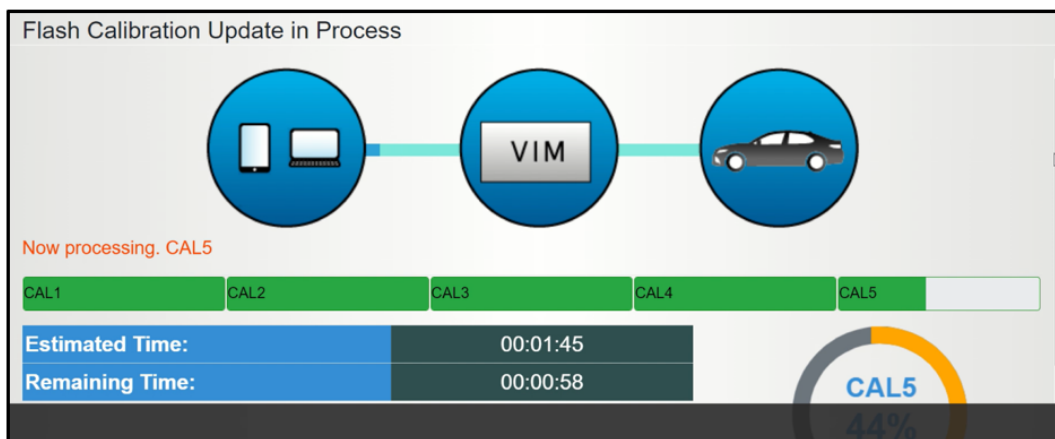
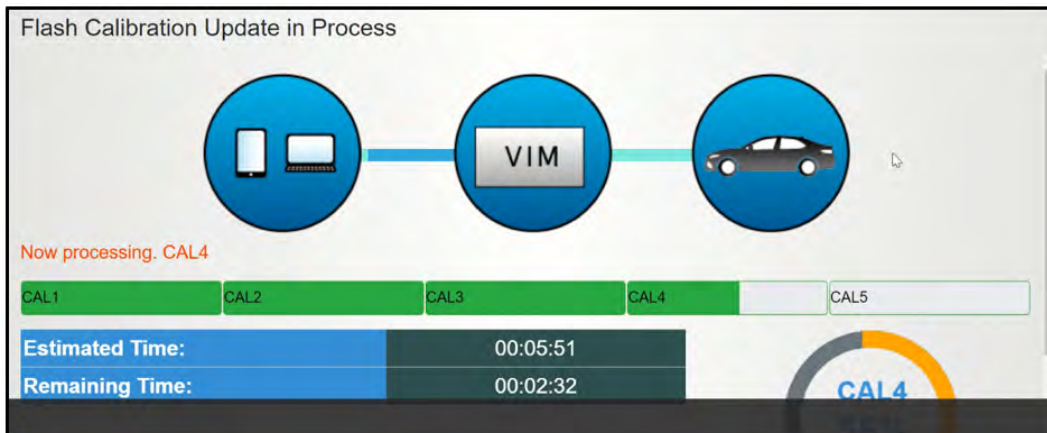

Continued...

STEP 40: When the reprogramming procedure is successfully completed, the “Finish” window will be displayed. Press any key to continue.



IMPORTANT NOTE: If the reprogramming procedure is unsuccessful, an error window is displayed. If no error window is displayed, proceed to Step 41.

- DO NOT press the cancel button.
- DO NOT close the CUW+ window.

Attempt to restart the reprogramming procedure by clicking the “Retry” button **AFTER** the following prerequisites are met:

- Inspect the USB cables and connections and confirm they are in working condition.
- Confirm the 12 Volt battery has sufficient charge.
- Confirm the battery charger is operating as desired.
- Confirm the battery cables are securely connected.

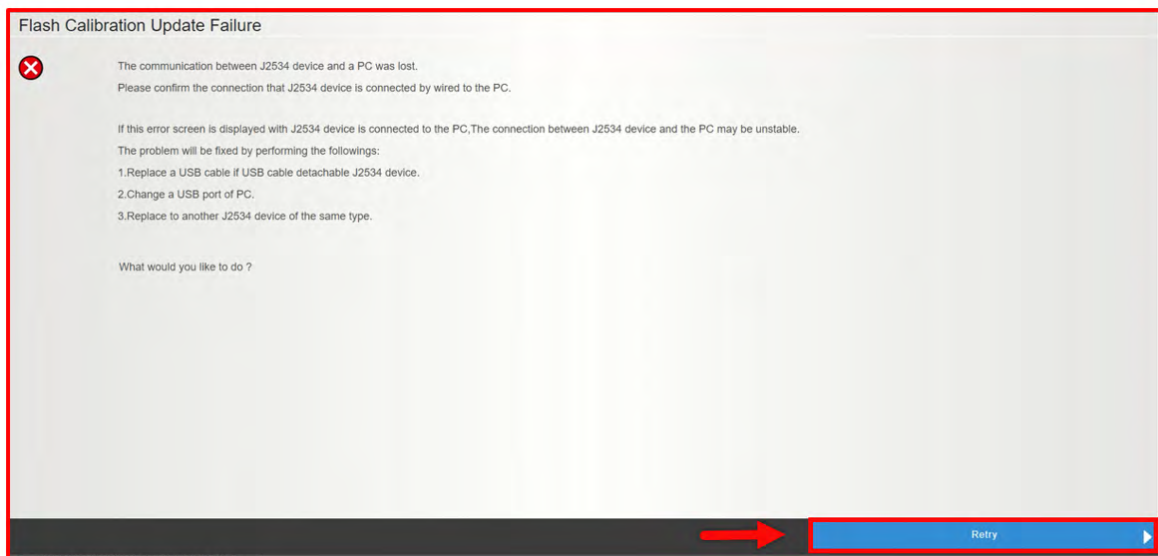

Continued...

Cycle the power switch  as per the GTS+ and click the “Retry” button to continue.

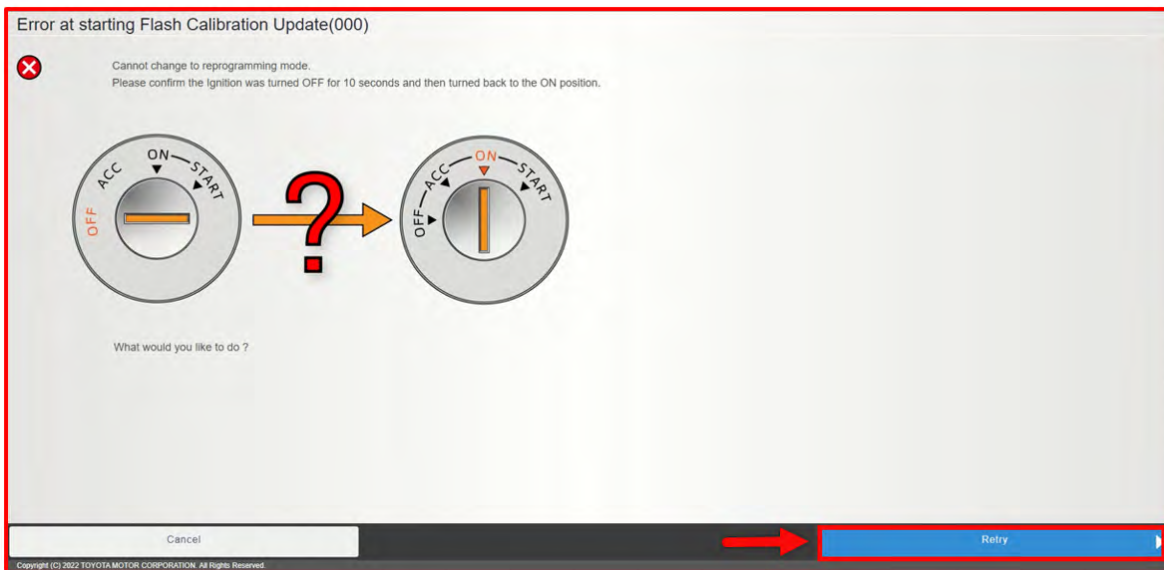

STEP 41: The “Flash Calibration Update Successful” window will display. Turn the power switch  to the OFF position. Click the “Next” button to continue.

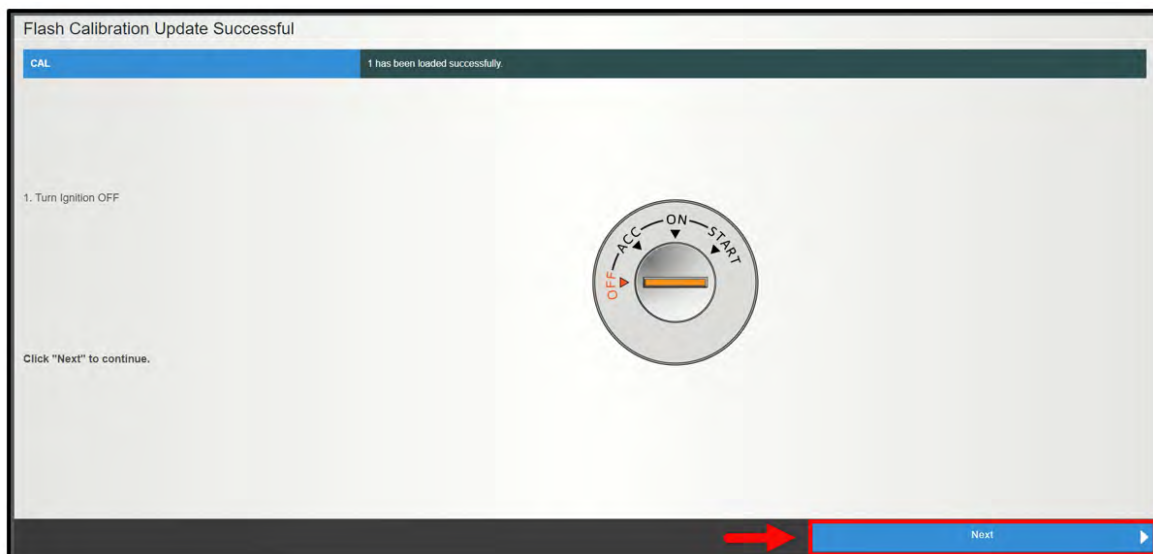

NOTE: A Progress bar will be displayed. **DO NOT** operate the power switch while the bar is shown.

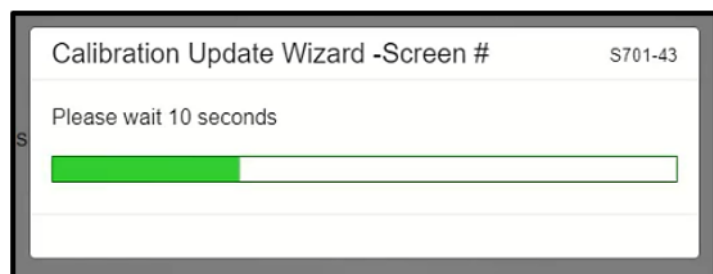

Continued...

STEP 42: Follow the on-screen instruction. Turn the power switch  to the ON position. Select the “Next” button to continue.



NOTE: A Progress bar will be displayed. **DO NOT** operate the power switch while the bar is shown.

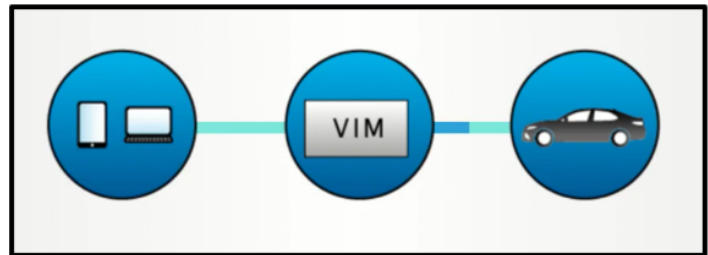

STEP 43: Confirm the “AFTER UPDATE” calibration ID matches the NEW calibration ID numbers listed on page 2. Click the “Finish” button.

Reprogramming successful !

Please turn IG off.

Please confirm that calibration ID has been updated as outlined in the specific Service Bulletin.

System	Before Update	After Update
Plug-in Control/Battery Charger Control Module "A"	G911G4203001	G911G4203001
Plug-in Control/Battery Charger Control Module "A"	892DF4201200	892DF4201200
Air Conditioner	8865F4213100	8865F4213100
Air Conditioner	886BF4201001	886BF4201001
Combination Meter	8380042V430A	8380042V430A

Print Finish

Continued...

STEP 44: Return to the GTS+ window. Perform the “Health Check” a second time by selecting the button in the lower right corner of the Stared Data tab window.

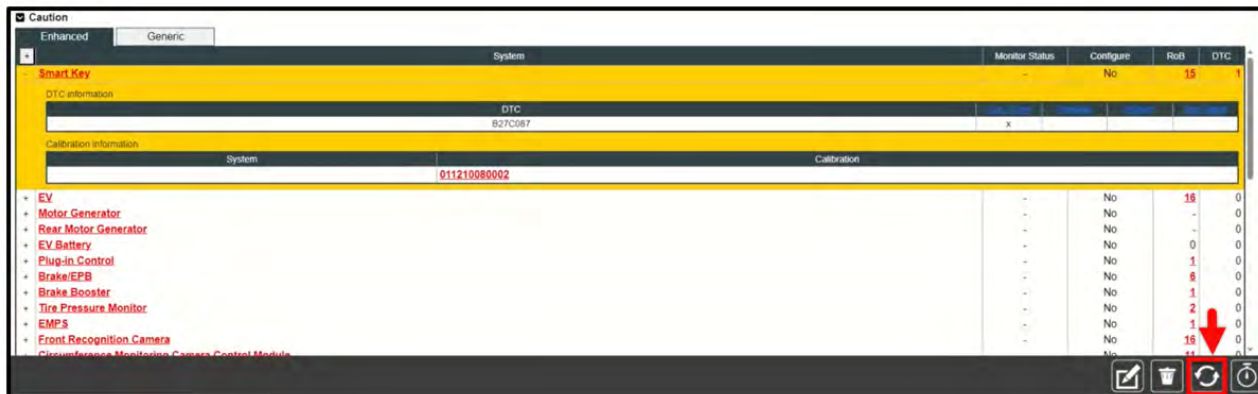

While the Health Check is being performed, a pop-up will be displayed asking if you would like additional information retrieved. Click the “No” button to continue.

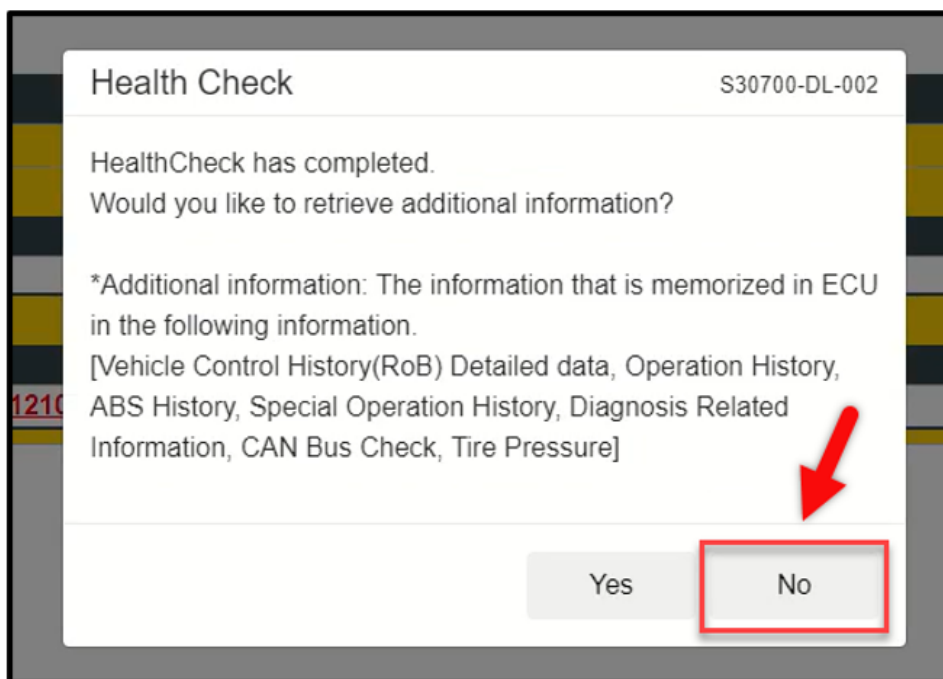

STEP 45: Clear any DTC(s) that may have been detected during reprogramming. If no DTC(s) are detected, the procedure is complete.

Continued...

SERVICE PROGRAM IDENTIFICATION LABEL:

Type or print the necessary information on a Campaign Identification Label. The completed label should be attached to the vehicle left side radiator support bracket located behind the driver side headlamp. Additional labels are available through normal parts ordering channels. The part number **MAS6P1302**, which comes as one sheet of 20 labels.

Part Number	Applicability	Description	Order Quantity
MSA6P1302	All Models	Campaign Completion Labels (contains one sheet of 20 labels)	1

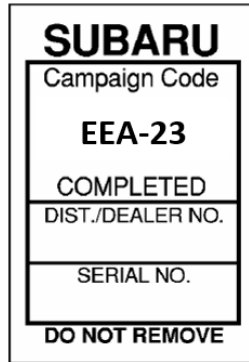

CLAIM REIMBURSEMENT AND ENTRY PROCEDURES:

Credit to perform this Product Enhancement Service Program will be based on properly completed repair order information. Retailers may submit claims through Subarunet.com.

Labor Description	Labor Operation #	Labor Time	Fail Code
REPROGRAMMING, ALL ECU ENHANCEMENT	A455-588	2.3H	EEA-23

NOTE: This claim **MUST** be submitted as an RC type.

IMPORTANT REMINDERS:

- SOA strongly discourages the printing and/or local storage of service information as previously released information and electronic publications may be updated at any time.
- Always check for any open recalls or campaigns anytime a vehicle is in for servicing.
- Always refer to STIS for the latest service information before performing any repairs.

Continued...



SUBARU

Subaru of America, Inc
PO Box 9103
Camden, NJ 08101-9877
844-373-6614
www.subaru.com

VIN XXXXXXXXXXXXXXXXXXXX
Software Update EEA23
October 2023

Dear Subaru Owner:

At Subaru, we are dedicated to providing vehicles of outstanding quality and value. As part of our continuing efforts to provide superior customer satisfaction, Subaru is announcing a product enhancement software update, available for your vehicle.

What will the software update do?

A software update has been developed for certain 2023 model year Solterra models. It is designed to improve DC-charging performance, and enhance visualization of the remaining range, current state of charge (SOC), and real-life energy consumption.

What will Subaru do?

Any authorized Subaru retailer (dealer) will perform the software update on your vehicle, at no cost to you.

What should you do?

Please contact your Subaru retailer for an appointment to have the update performed on your vehicle.

How long will the update take?

The software update will take approximately two and a half hours to complete. However, depending on the retailer's work schedule, it may be necessary for you to make the vehicle available for a longer period of time.

If you need further assistance

To locate the nearest Subaru retailer, you can access our website at www.subaru.com and select 'Find a Retailer.' If you have any questions, you may email us directly through www.subaru.com Customer Support. You may also call us at 1-800-782-2783 during our normal business hours listed below:

- Monday through Thursday, 8:00 a.m. to 8:00 p.m. (EST)
- Friday, 10:30 a.m. to 5:00 p.m. (EST)
- Saturday, 8:30 a.m. to 5:00 p.m. (EST)

Your continued satisfaction with your Subaru is important to us, and we thank you for choosing the 2023 model year Subaru Solterra.

Sincerely,

Subaru of America, Inc.

A subsidiary of SUBARU CORPORATION