

# Service Alert

Mazda North American Operations  
Irvine, CA 92618-2922



<b>Subject:</b>  CONNECTED VEHICLE SYMPTOM TROUBLESHOOTING	<b>Service Alert No.:</b> SA-023/25
	<b>Last Issued :</b> 08/22/2025

## BULLETIN NOTES

This Service Alert supersedes the previously issued service alert listed below. The changes are noted in Red text.

Previous SAs:	Date(s) Issued:
SA-023/25	07/14/25 and 05/15/25
SA-017/24	11/14/24, 09/10/24, 04/11/24 and 03/14/24
SA-009/23	10/23/23, 08/28/23, 08/15/23, 07/05/23, 06/12/23, 05/24/23, 04/25/23, 03/28/23, 03/01/23 and 02/06/23
SA-017/22	12/13/22, 10/10/22, 08/25/22, 05/06/22, 04/04/22
SA-013/21	12/22/21, 10/13/21, 09/14/21, 05/11/21, 04/27/21, 03/15/21, 02/22/21, 02/08/21 and 02/02/2021
SA-031/20	12/09/20, 11/30/20, 11/06/20, 10/28/20, 06/16/20, 06/05/20, 06/01/20, 05/18/20, 04/14/2020, 04/02/20, 03/11/20 and 02/27/20

## APPLICABLE MODEL(S)/VINS:

2019-2026 Mazda3	2021-2023 CX-9	2024-2026 CX-90 (All)
2020-2026 CX-30	2022-2023 MX-30	2024-2026 MX-5
2021-2025 CX-5	2023-2026 CX-50 (All)	2025-2026 CX-70 (All)

## DESCRIPTION

Some customers may complain about any of the following:

1. Infotainment Center Display does not provide the Authorization Code (OTP) during the MyMazda App Connected Vehicle enrollment.
2. Remote function(s) inoperative.
  - Engine Start / Stop
  - Door Lock / Unlock
  - Lights ON / OFF
  - Climate Control
3. MAZDA CONNECT connected vehicle reception strength icon shows "X" or "!".







**CONSUMER NOTICE:** The information and instructions in this bulletin are intended for use by skilled technicians. Mazda technicians utilize the proper tools/ equipment and take training to correctly and safely maintain Mazda vehicles. These instructions should not be performed by "do-it-yourselfers." Customers should not assume this bulletin applies to their vehicle or that their vehicle will develop the described concern. To determine if the information applies, customers should contact their nearest authorized Mazda dealership. Mazda North American Operations reserves the right to alter the specifications and contents of this bulletin without obligation or advance notice. All rights reserved. No part of this bulletin may be reproduced in any form or by any means, electronic or mechanical--including photocopying and recording and the use of any kind of information storage and retrieval system ---without permission in writing.

Index

- MAZDA CONNECT Indication
- Remote Engine Start Will Not Function
- Remote Engine Start Function Will turn engine OFF
- Customer Subscription Status
- TCU Communication Line Status

MAZDA CONNECT Indication



Indication	Explanation
	<ul style="list-style-type: none"> <li>• Radio waves are not being received.                             <ul style="list-style-type: none"> <li>◦ Move to a location with good reception.</li> </ul> </li> <li>• Data line has been closed due to Opt-Out (Deactivation) request.                             <ul style="list-style-type: none"> <li>◦ To open data line, accept T&amp;C in CV enrollment</li> </ul> </li> </ul>
	Weak reception.
	Good Reception
	Strong reception.
	Currently conducting an operation check of the communication unit. If this condition continues, consult an Authorized Mazda Dealer.
	Currently conducting an operation check of the onboard communication unit. <b>NOTE:</b> Communication is not possible during this display.
	The communication function is temporarily disabled due to infotainment system setting.

**CONSUMER NOTICE:** The information and instructions in this bulletin are intended for use by skilled technicians. Mazda technicians utilize the proper tools/ equipment and take training to correctly and safely maintain Mazda vehicles. These instructions should not be performed by "do-it-yourselfers." Customers should not assume this bulletin applies to their vehicle or that their vehicle will develop the described concern. To determine if the information applies, customers should contact their nearest authorized Mazda dealership. Mazda North American Operations reserves the right to alter the specifications and contents of this bulletin without obligation or advance notice. All rights reserved. No part of this bulletin may be reproduced in any form or by any means, electronic or mechanical---including photocopying and recording and the use of any kind of information storage and retrieval system ---without permission in writing.

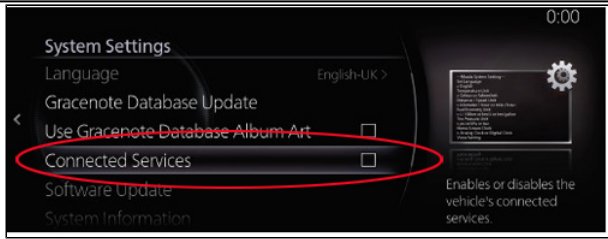

- **TCU Communication Line Status** is Closed
- No CV Contract
- Connected Service contract has ended (Subscription expired)
- TCU has not been initialized, go to [SA-004/21](#)



Customer deactivated Connected Services (Opt-Out)

- eMDCS Warranty Vehicle Inquiry will show Campaign **CSP04** Status Open

Connected Services Disabled message appears at engine start up

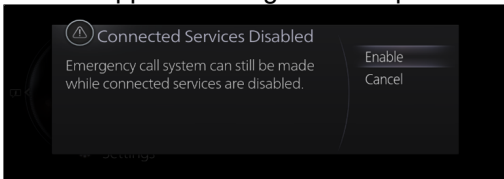

Connected Services disabled (box unchecked)

Enable Connected Services (box checked) to prevent message appearing at engine start up.

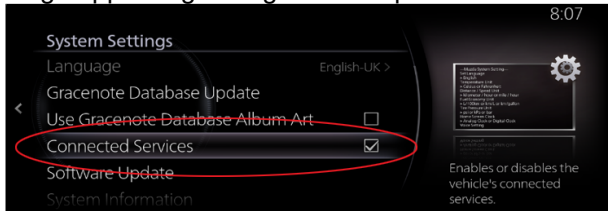

**Note:** If customer Opted-Out ( **CSP04**), advise customer to keep Connected Services box checked. The vehicle will not transmit data.

Connected Vehicle Maintenance Mode

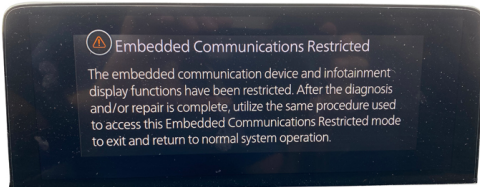



Connected Vehicle Maintenance Mode enabled. Go to **MGSS SERVICE CAUTIONS FOR VEHICLES WITH TELEMATICS COMMUNICATION SYSTEM** to disable Maintenance Mode.

**NOTE:** Connected Vehicle Maintenance Mode is unnecessary if the customers vehicle **TCU Communication Line Status** is Closed .

**CONSUMER NOTICE:** The information and instructions in this bulletin are intended for use by skilled technicians. Mazda technicians utilize the proper tools/ equipment and take training to correctly and safely maintain Mazda vehicles. These instructions should not be performed by "do-it-yourselfers." Customers should not assume this bulletin applies to their vehicle or that their vehicle will develop the described concern. To determine if the information applies, customers should contact their nearest authorized Mazda dealership. Mazda North American Operations reserves the right to alter the specifications and contents of this bulletin without obligation or advance notice. All rights reserved. No part of this bulletin may be reproduced in any form or by any means, electronic or mechanical--including photocopying and recording and the use of any kind of information storage and retrieval system ---without permission in writing.

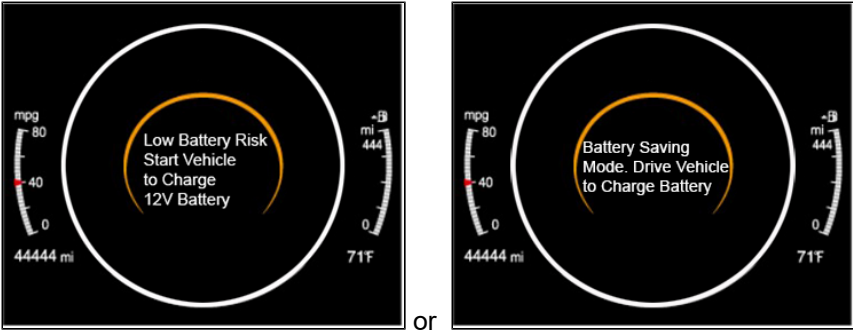
**Remote Engine Start Will Not Function under the following conditions**

Item	Condition
1	Remote Engine Start function is not available on EV and PHEV (inline 4) models. See <a href="#">SA-038/23</a>
2	Vehicle battery voltage low
3	Automatic Transmission shift position except "P"
4	Vehicles equipped with manual transmission
5	Vehicle speed above 3 mi/h (5 km/h)
6	Brake pedal switch malfunction
7	Engine has been running by remote engine start function
8	Engine started by remote engine start more than 2 consecutive times while the vehicle is not driven. The vehicle must be driven 1-mile or 24-hours must pass from the last successful Remote Engine Start for the use count to reset.
9	2021 Mazda3, 2021 CX-30, CX-50, MX-30: Vehicle's electrical control area network (CAN) is in "Sleep Mode" 
10	A registered key is detected in the vehicle
11	Brake pedal switch detects brake application
12	Low fuel warning 
13	Engine starts, then turns OFF due to abnormal high engine rpm detected. (Engine rotation over 3000 rpm continued for more than 0.2[s])
14	No engine rpm detected after sending engine start request. (Engine rotation 0 rpm continued for more than 0.2[s])
15	When the CAN data signal for engine shut off is present (e.g.: door ajar signal)
16	After 10 second maximum cranking time
17	Burglar alarm status is "Alarm" and "Alarm stand by" (CAUTION - DO NOT enable, see Theft-Deterrent System section in <a href="#">SA-012/20</a> )
18	Room fuse blown/missing
19	Connected Services Disabled

**CONSUMER NOTICE:** The information and instructions in this bulletin are intended for use by skilled technicians. Mazda technicians utilize the proper tools/ equipment and take training to correctly and safely maintain Mazda vehicles. These instructions should not be performed by "do-it-yourselfers." Customers should not assume this bulletin applies to their vehicle or that their vehicle will develop the described concern. To determine if the information applies, customers should contact their nearest authorized Mazda dealership. Mazda North American Operations reserves the right to alter the specifications and contents of this bulletin without obligation or advance notice. All rights reserved. No part of this bulletin may be reproduced in any form or by any means, electronic or mechanical--including photocopying and recording and the use of any kind of information storage and retrieval system ---without permission in writing.

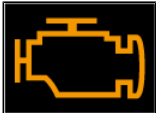
	
20	<p>Connected Vehicle Maintenance Mode enabled (Restricted Transmitting Mode in MDARS)</p> 
21	<p>Vehicle is parked (stored) for approximately 1 week or longer or in deep sleep mode. Drive the vehicle for a few miles to recover.</p>
22	<p>DTC Stored</p> 
23	<p>Aftermarket Remote Engine Start accessory installed.</p>
24	<p>Mazda Remote Engine Start (BCKA-V7-620) accessory installed (No MyMazda app remote engine start function).</p> <p><b>Mazda Remote Engine Start (RES) Removal</b></p> <ol style="list-style-type: none"> <li>Remove the Mazda Remote Engine Start (RES) accessory module.</li> <li>Deactivate and activate Advanced Key(s). Refer to MGSS <a href="#">IMMOBILIZER SYSTEM-RELATED PARTS PROGRAMMING [(US)]</a></li> </ol>
25	<p>First remote control attempt fails, second attempt works fine. Go to TSB <a href="#">16-002/20</a>.</p>
26	<p><a href="#">CSP04</a> Status Open</p>

**Remote Engine Start Function Will turn engine OFF under the following conditions**

Item	Condition
1	Vehicle door(s) opened
2	Vehicle trunk opened
3	Vehicle hood opened
4	Ignition switch push button "ON" detected
5	Remote engine STOP request



**CONSUMER NOTICE:** The information and instructions in this bulletin are intended for use by skilled technicians. Mazda technicians utilize the proper tools/ equipment and take training to correctly and safely maintain Mazda vehicles. These instructions should not be performed by "do-it-yourselfers." Customers should not assume this bulletin applies to their vehicle or that their vehicle will develop the described concern. To determine if the information applies, customers should contact their nearest authorized Mazda dealership. Mazda North American Operations reserves the right to alter the specifications and contents of this bulletin without obligation or advance notice. All rights reserved. No part of this bulletin may be reproduced in any form or by any means, electronic or mechanical--including photocopying and recording and the use of any kind of information storage and retrieval system ---without permission in writing.

6	Brake pedal switch detects brake application
7	DTC Stored
8	Engine will stop running automatically after 15 minutes for safety, security and emissions.

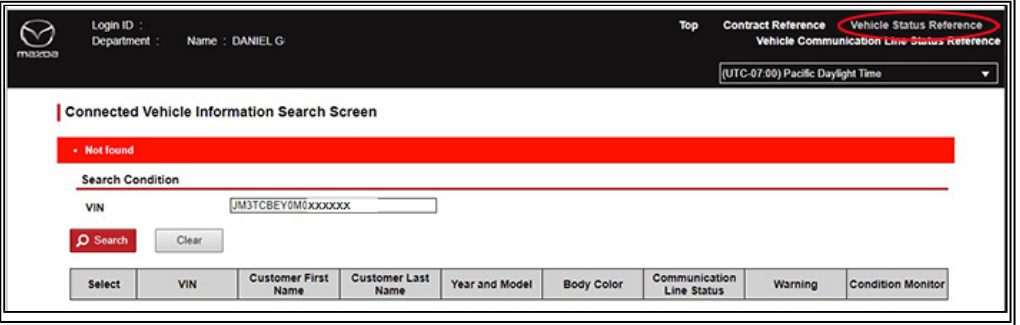
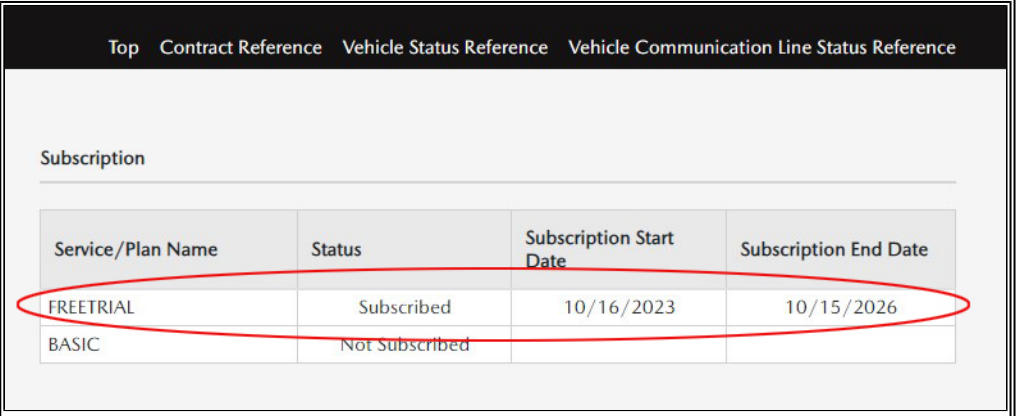
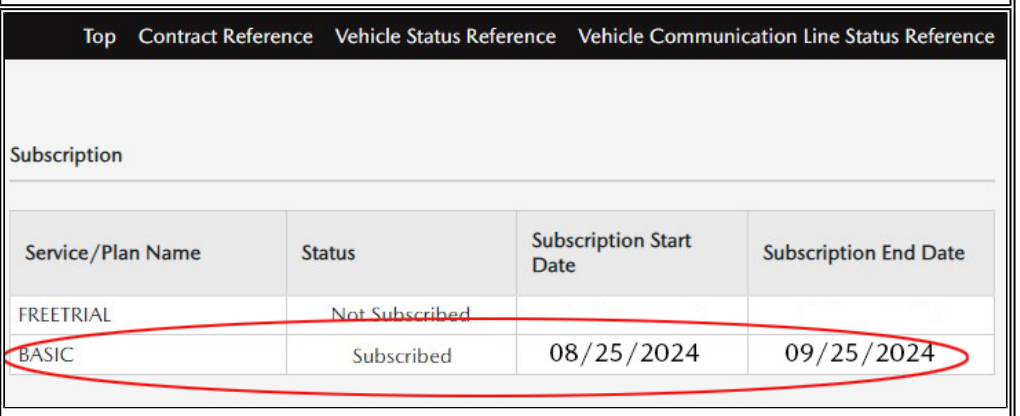
**Customer Subscription Status**

Mazda Connected Vehicle Viewer (MCVV)	No Subscription	
	Free Trial Subscription	
	Paid Subscription	
eMDCS	No Subscription <ul style="list-style-type: none"> <li>• Communication Line Closed</li> <li>• No CV</li> </ul>	Mazda Connected Vehicle Viewer (MCVV) link will be in <b>red</b> text

**CONSUMER NOTICE:** The information and instructions in this bulletin are intended for use by skilled technicians. Mazda technicians utilize the proper tools/ equipment and take training to correctly and safely maintain Mazda vehicles. These instructions should not be performed by "do-it-yourselfers." Customers should not assume this bulletin applies to their vehicle or that their vehicle will develop the described concern. To determine if the information applies, customers should contact their nearest authorized Mazda dealership. Mazda North American Operations reserves the right to alter the specifications and contents of this bulletin without obligation or advance notice. All rights reserved. No part of this bulletin may be reproduced in any form or by any means, electronic or mechanical--including photocopying and recording and the use of any kind of information storage and retrieval system ---without permission in writing.

<p>Contract</p>	<p style="text-align: center;"><b>WARRANTY TERM INFORMATION</b></p> <table border="1"> <thead> <tr> <th></th> <th>MONTHS</th> <th>ODO</th> <th>END DATE</th> <th>END ODO</th> <th></th> <th>MONTHS</th> <th>ODO</th> </tr> </thead> <tbody> <tr> <td>Basic</td> <td>36</td> <td>36000</td> <td>07-16-2026</td> <td>36000</td> <td></td> <td></td> <td></td> </tr> <tr> <td>Powertrain</td> <td>60</td> <td>60000</td> <td>07-16-2028</td> <td>60000</td> <td>FED Emissions</td> <td>96</td> <td>80000</td> </tr> <tr> <td>Safety</td> <td>60</td> <td>60000</td> <td>07-16-2028</td> <td>60000</td> <td>GHG Emissions</td> <td>120</td> <td>120000</td> </tr> <tr> <td>Perforation</td> <td>60</td> <td>Unlimited</td> <td>07-16-2028</td> <td>Unlimited</td> <td></td> <td></td> <td></td> </tr> <tr> <td>Adjustments</td> <td>12</td> <td>12000</td> <td>07-16-2024</td> <td>12000</td> <td></td> <td></td> <td></td> </tr> <tr> <td>Replacement Parts</td> <td>12</td> <td>12000</td> <td></td> <td></td> <td></td> <td></td> <td></td> </tr> </tbody> </table> <p style="text-align: center;">Refer to eMDSG Warranty Term Inquiry for specific repair coverage.</p> <p style="text-align: center;">  <a href="#">Mazda Connected Vehicle Viewer (MCVV)</a> <a href="#">Warranty Term Inquiry</a> <a href="#">Warranty Wizard</a> </p>		MONTHS	ODO	END DATE	END ODO		MONTHS	ODO	Basic	36	36000	07-16-2026	36000				Powertrain	60	60000	07-16-2028	60000	FED Emissions	96	80000	Safety	60	60000	07-16-2028	60000	GHG Emissions	120	120000	Perforation	60	Unlimited	07-16-2028	Unlimited				Adjustments	12	12000	07-16-2024	12000				Replacement Parts	12	12000					
	MONTHS	ODO	END DATE	END ODO		MONTHS	ODO																																																		
Basic	36	36000	07-16-2026	36000																																																					
Powertrain	60	60000	07-16-2028	60000	FED Emissions	96	80000																																																		
Safety	60	60000	07-16-2028	60000	GHG Emissions	120	120000																																																		
Perforation	60	Unlimited	07-16-2028	Unlimited																																																					
Adjustments	12	12000	07-16-2024	12000																																																					
Replacement Parts	12	12000																																																							
<p>Subscription</p> <ul style="list-style-type: none"> <li>• Communication Line Open</li> <li>• CV Contract</li> </ul>	<p style="text-align: center;">Mazda Connected Vehicle Viewer (MCVV) link will be in <b>green</b> text</p> <p style="text-align: center;"><b>WARRANTY TERM INFORMATION</b></p> <table border="1"> <thead> <tr> <th></th> <th>MONTHS</th> <th>ODO</th> <th>END DATE</th> <th>END ODO</th> <th></th> <th>MONTHS</th> <th>ODO</th> </tr> </thead> <tbody> <tr> <td>Basic</td> <td>36</td> <td>36000</td> <td>07-16-2026</td> <td>36000</td> <td></td> <td></td> <td></td> </tr> <tr> <td>Powertrain</td> <td>60</td> <td>60000</td> <td>07-16-2028</td> <td>60000</td> <td>FED Emissions</td> <td>96</td> <td>80000</td> </tr> <tr> <td>Safety</td> <td>60</td> <td>60000</td> <td>07-16-2028</td> <td>60000</td> <td>GHG Emissions</td> <td>120</td> <td>120000</td> </tr> <tr> <td>Perforation</td> <td>60</td> <td>Unlimited</td> <td>07-16-2028</td> <td>Unlimited</td> <td></td> <td></td> <td></td> </tr> <tr> <td>Adjustments</td> <td>12</td> <td>12000</td> <td>07-16-2024</td> <td>12000</td> <td></td> <td></td> <td></td> </tr> <tr> <td>Replacement Parts</td> <td>12</td> <td>12000</td> <td></td> <td></td> <td></td> <td></td> <td></td> </tr> </tbody> </table> <p style="text-align: center;">Refer to eMDSG Warranty Term Inquiry for specific repair coverage.</p> <p style="text-align: center;">  <a href="#">Mazda Connected Vehicle Viewer (MCVV)</a> <a href="#">Warranty Term Inquiry</a> <a href="#">Warranty Wizard</a> </p>		MONTHS	ODO	END DATE	END ODO		MONTHS	ODO	Basic	36	36000	07-16-2026	36000				Powertrain	60	60000	07-16-2028	60000	FED Emissions	96	80000	Safety	60	60000	07-16-2028	60000	GHG Emissions	120	120000	Perforation	60	Unlimited	07-16-2028	Unlimited				Adjustments	12	12000	07-16-2024	12000				Replacement Parts	12	12000					
	MONTHS	ODO	END DATE	END ODO		MONTHS	ODO																																																		
Basic	36	36000	07-16-2026	36000																																																					
Powertrain	60	60000	07-16-2028	60000	FED Emissions	96	80000																																																		
Safety	60	60000	07-16-2028	60000	GHG Emissions	120	120000																																																		
Perforation	60	Unlimited	07-16-2028	Unlimited																																																					
Adjustments	12	12000	07-16-2024	12000																																																					
Replacement Parts	12	12000																																																							
<p>Free Trial Subscription Period</p>	<p>3-year, unlimited mileage, complementary free trial</p> <ul style="list-style-type: none"> <li>• 2019-2024 Mazda3</li> <li>• 2020-2024 CX-30</li> <li>• 2021-2024 CX-5</li> <li>• 2023-2024 CX-50</li> <li>• 2025 CX-70</li> <li>• 2021-2023 CX-9</li> <li>• 2024 CX-90</li> <li>• 2022-2023 MX-30</li> <li>• 2024 MX-5</li> </ul> <p>1-year, unlimited mileage, complementary free trial</p>																																																								

**CONSUMER NOTICE:** The information and instructions in this bulletin are intended for use by skilled technicians. Mazda technicians utilize the proper tools/ equipment and take training to correctly and safely maintain Mazda vehicles. These instructions should not be performed by "do-it-yourselfers." Customers should not assume this bulletin applies to their vehicle or that their vehicle will develop the described concern. To determine if the information applies, customers should contact their nearest authorized Mazda dealership. Mazda North American Operations reserves the right to alter the specifications and contents of this bulletin without obligation or advance notice. All rights reserved. No part of this bulletin may be reproduced in any form or by any means, electronic or mechanical--including photocopying and recording and the use of any kind of information storage and retrieval system ---without permission in writing.

- 2025 - Current Mazda3
- 2025 - Current CX-30
- 2025 - Current CX-5
- 2025 - Current CX-50
- 2026 - Current CX-70
- 2025 - Current CX-90
- 2025 - Current MX-5

**NOTE:**

- MCVV FREETRIAL Subscription End Date is currently showing incorrect information of 3 years instead of 1 year for the vehicles listed above. MCVV will be corrected soon to show the correct 1 year Subscription End Date.
- All customer communications say 1-year free trial period information.



**CONSUMER NOTICE:** The information and instructions in this bulletin are intended for use by skilled technicians. Mazda technicians utilize the proper tools/ equipment and take training to correctly and safely maintain Mazda vehicles. These instructions should not be performed by "do-it-yourselfers." Customers should not assume this bulletin applies to their vehicle or that their vehicle will develop the described concern. To determine if the information applies, customers should contact their nearest authorized Mazda dealership. Mazda North American Operations reserves the right to alter the specifications and contents of this bulletin without obligation or advance notice. All rights reserved. No part of this bulletin may be reproduced in any form or by any means, electronic or mechanical---including photocopying and recording and the use of any kind of information storage and retrieval system ---without permission in writing.

**TCU Communication Line Status**

**NOTE:**

- Customer/Dealer can activate CV services anytime via MyMazda app
  - Note: There might be a slight delay in making the backend connection since it was temporarily deactivated.
    - Go to Repair Procedure -> Enrollment / Take-Over.
- When the TCU communication line is closed, infotainment Over-the-Air (OTA) Connectivity Master Unit (CMU) software update is not possible (disabled).

**TCU Communication Line Status Check:**

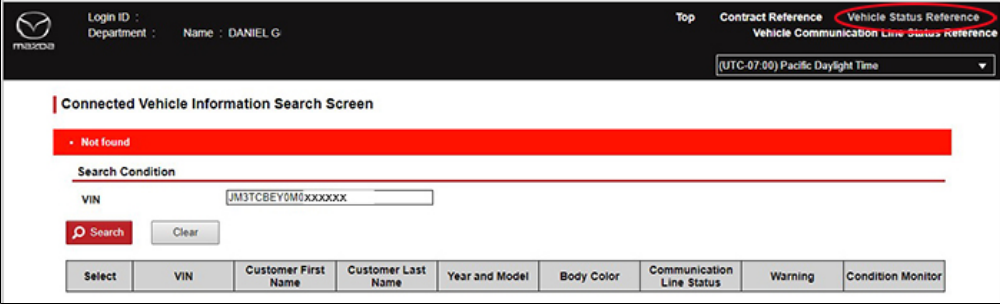
Infotainment Center Display	<p><b>Communication Line is Open</b></p>	<p><b>Reception Icon Shows normal strength</b></p> 
Infotainment Center Display	<p><b>Communication Line is Closed</b></p> <ul style="list-style-type: none"> <li>• <b>No CV Contract</b></li> <li>• <b>One Time Passcode (OTP) is processing</b></li> </ul>	<p><b>Reception Icon Shows "X"</b></p> 
Mazda Connected Vehicle Viewer (MCVV)	<p><b>Vehicle Status Reference</b></p> <p>Enter VIN and then select "Search"</p>	<p><b>Communication Line is Closed</b></p>  <p><b>Communication Line is Open and CV Contract is active</b></p>

**CONSUMER NOTICE:** The information and instructions in this bulletin are intended for use by skilled technicians. Mazda technicians utilize the proper tools/ equipment and take training to correctly and safely maintain Mazda vehicles. These instructions should not be performed by "do-it-yourselfers." Customers should not assume this bulletin applies to their vehicle or that their vehicle will develop the described concern. To determine if the information applies, customers should contact their nearest authorized Mazda dealership. Mazda North American Operations reserves the right to alter the specifications and contents of this bulletin without obligation or advance notice. All rights reserved. No part of this bulletin may be reproduced in any form or by any means, electronic or mechanical--including photocopying and recording and the use of any kind of information storage and retrieval system ---without permission in writing.

Vehicle Communication Line Status Reference  
Enter VIN and then select "Search"

Connected Vehicle Information Search Screen

Search Condition

VIN: 7MMVABXY9PN1

Search Clear

Select	VIN	Customer First Name	Customer Last Name	Year and Model	Body Color	Communication Line Status	Warning	Condition Monitor
Select	7MMVABXY9PN1	DANIEL	G	2023 2.5 TURBO MERIDIAN EDITION AWD	ZIRCON SAND METALLIC	Opened		✓

TCU Communication Line is Closed

Vehicle Communication Line Status Search Screen

Search Condition

VIN: JM1DRADB4P0

Search Clear

VIN	Vehicle Communication Line Status			Year and Model	Body Color
	Status	Request Date	Status Detail		
JM1DRADB4P0	Closed	02/05/2023 18:25	Close Completed 02/05/2023 18:25	2023 EV FWD W/ PREMIUM PLUS PKG	MACHINE GRAY METALLIC

TCU Communication Line is in the process of opening  
One Time Passcode (OTP) is processing (Status -> Open Requested)

Vehicle Communication Line Status Search Screen

Search Condition

VIN: 7mmvaby9

Search Clear

VIN	Vehicle Communication Line Status			Year and Model	Body Color
	Status	Request Date	Status Detail		
7MMVABXY9	Open Requested	04/27/2023 11:14	Processing	2023 2.5 TURBO MERIDIAN EDITION AWD	ZIRCON SAND METALLIC

TCU Communication Line is Open

Vehicle Communication Line Status Search Screen

Search Condition

VIN: JM1DRADB4P0

Search Clear

VIN	Vehicle Communication Line Status			Year and Model	Body Color
	Status	Request Date	Status Detail		
JM1DRADB4P0	Opened	02/05/2023 18:25	Open Completed 02/05/2023 18:25	2023 EV FWD W/ PREMIUM PLUS PKG	MACHINE GRAY METALLIC

**CONSUMER NOTICE:** The information and instructions in this bulletin are intended for use by skilled technicians. Mazda technicians utilize the proper tools/ equipment and take training to correctly and safely maintain Mazda vehicles. These instructions should not be performed by "do-it-yourselfers." Customers should not assume this bulletin applies to their vehicle or that their vehicle will develop the described concern. To determine if the information applies, customers should contact their nearest authorized Mazda dealership. Mazda North American Operations reserves the right to alter the specifications and contents of this bulletin without obligation or advance notice. All rights reserved. No part of this bulletin may be reproduced in any form or by any means, electronic or mechanical--including photocopying and recording and the use of any kind of information storage and retrieval system ---without permission in writing.

**REPAIR PROCEDURE**

**CAUTION:** DO NOT swap TCU with another vehicle as the TCU is VIN locked after activation. A TCU swap with another vehicle will disable Connected Services on both vehicles.

**Repair Flowchart**

<b>Start</b>				
↓				
<b>Preparation</b>				
↓	↓	↓	↓	↓
MyMazda App Paid Subscription Concern	MyMazda App Error Code	Remote function(s) inoperative <ul style="list-style-type: none"> <li>• Engine Start / Stop</li> <li>• Door Lock / Unlock</li> <li>• Lights ON / OFF</li> <li>• Climate Control</li> </ul>	No One Time Pass Code (OTP)	Connected vehicle reception strength icon shows "X" or "I"
↓	↓	↓	↓	↓
If the customer is having difficulty with the MyMazda App paid subscription using the Mazda Connected Services Owner Portal, refer the customer to CEC at (800) 222-5500.	Go to SA-064/24	Go to the MyMazda App to view the reason for remote function failure.	MyMazda App Enrollment Preparation	Communication Line
		↓	↓	↓
		Check Campaign Status	Enrollment / Take-Over	Check Campaign Status
		↓	↓	↓
		Remote Function Troubleshooting	OTP Troubleshooting	Customer deactivate Connected Services (Opt-Out) ↓ No reception

**PREPARATION:**

1. Confirm that the Telematics Communication Unit (TCU) is at the latest software level. Go to [Telematics Communication Unit \(TCU\) Updates](#)

**CONSUMER NOTICE:** The information and instructions in this bulletin are intended for use by skilled technicians. Mazda technicians utilize the proper tools/ equipment and take training to correctly and safely maintain Mazda vehicles. These instructions should not be performed by "do-it-yourselfers." Customers should not assume this bulletin applies to their vehicle or that their vehicle will develop the described concern. To determine if the information applies, customers should contact their nearest authorized Mazda dealership. Mazda North American Operations reserves the right to alter the specifications and contents of this bulletin without obligation or advance notice. All rights reserved. No part of this bulletin may be reproduced in any form or by any means, electronic or mechanical--including photocopying and recording and the use of any kind of information storage and retrieval system ---without permission in writing.

2. Go to [eMDCS Vehicle Inquiry](#) and confirm the following campaigns are not shown or closed:

- CSP06
- CSP07
- SSPC7
- DRW41

3. Go to [eMDCS Vehicle Inquiry](#) and confirm CSP04 is not shown.

4. Telematics Communication Unit (TCU) related DTC's must be diagnosed/repared prior to going to next step.

5. If Hotline assistance is needed, please fill out the [Dealer Connected Vehicle Questionnaire](#) before contacting Hotline. The questionnaire collects data needed by Hotline agent.

**NOTE:** Hotline is only able to support vehicle side issues. If the customer is having difficulty with the MyMazda App paid subscription using the [Mazda Connected Services Owner Portal](#), refer the customer to CEC at (800) 222-5500.

6. In most cases, the customer will not leave their device with you for troubleshooting, therefore a connected vehicle Take-Over is necessary. Use your personal device or dealer supplied device for troubleshooting. Go to [Enrollment / Take-Over](#).

- At customer pick-up, inform customer to re-enroll into Connected Services as a new primary user.

7. Confirm the customer's phone and vehicle have good to strong reception during the concern as shown below.



- If the reception icon shows "X", the TCU Communication Line is Closed. Enrollment is not possible.
  - Open the TCU Communication Line:
    - Dealer - Go to [Opening the TCU Communication Line](#)
    - Customer - Go to [Registering Vehicle Information](#) -> [Registering Connected Service](#).



- If the reception icon shows "\", move the vehicle to an area with a clear view of the sky.



**CONSUMER NOTICE:** The information and instructions in this bulletin are intended for use by skilled technicians. Mazda technicians utilize the proper tools/ equipment and take training to correctly and safely maintain Mazda vehicles. These instructions should not be performed by "do-it-yourselfers." Customers should not assume this bulletin applies to their vehicle or that their vehicle will develop the described concern. To determine if the information applies, customers should contact their nearest authorized Mazda dealership. Mazda North American Operations reserves the right to alter the specifications and contents of this bulletin without obligation or advance notice. All rights reserved. No part of this bulletin may be reproduced in any form or by any means, electronic or mechanical--including photocopying and recording and the use of any kind of information storage and retrieval system ---without permission in writing.

- If the reception is weak, move the vehicle to a location where the reception is good to strong as shown in the table, then try to get the Authorization Code and/or operate the remote functions before proceeding to the Repair Procedure if there is still an issue.
- If the reception is good to strong, proceed to Connected Vehicle Troubleshooting below.

**NOTE:** Vehicles stored for long periods may lose GPS clock synchronization. If the vehicle is stored for a long period, test drive the vehicle to give the GPS clock time to synchronize before enrolling or testing connected vehicle functions.

## Index

1. [Connected Vehicle Remote Engine Start Inoperative and DTC U3000:96](#)
2. [MyMazda App displays "Subscription Required"](#)
3. [Unable to create a MyMazda account](#)
4. [Remote function\(s\) inoperative](#)
5. [No One Time Pass Code \(OTP\)](#)
6. [Connected vehicle reception strength icon shows "X" or "\"](#)
7. [Instrument Cluster Error Message and DTC U3000:04](#)
8. [MyMazda App displays incorrect tire pressures \(Except CX-5, CX-9, MX-5\)](#)
9. [Unable to activate Connected Services \(2019 Mazda3\)](#)
10. [Software Update Error \(2020 Mazda3\)](#)
11. [Functions inoperative \(2021-> CX-30, CX-50, Mazda3 and MX-30\)](#)
12. [First remote control attempt fails, second attempt works fine](#)
13. [Engine turns off when opening door](#)
14. [Low Tire pressure will not clear after correcting tire pressure](#)
15. [MyMazda App does not display tire air pressures \(CX-5, CX-9, MX-5\)](#)
  - [MCVV One Time Passcode \(OTP\) Troubleshooting](#)
  - [Opening the TCU Communication Line](#)
  - [Diagnostic Information \(ODR\) Data Collection Procedure](#)
  - [TCU / CMU Communication Connectivity Test](#)
  - [TCU Software Version Check](#)
  - [TCU MEID Number Check](#)
  - [TCU Remote Service Flag Information Check](#)
  - [Customer Opt-Out](#)
  - [2nd Owner Take-Over](#)
  - [Educational Videos](#)
  - [Resources](#)

Connected Vehicle Troubleshooting			
	Symptom	Cause	Action
1.	Connected Vehicle Remote Engine Start Inoperative and DTC U3000:96 (Body Control Module (BCM) Malfunction) is stored.	Unknown	Do not erase DTC's Contact Hotline
2.	MyMazda App displays "Subscription Required"	Connected Vehicle Services free trial period has ended, pop-up notification, "Subscription	<b>Customer</b> - Go to <a href="#">Mazda Connected Services Owner Portal</a>

**CONSUMER NOTICE:** The information and instructions in this bulletin are intended for use by skilled technicians. Mazda technicians utilize the proper tools/ equipment and take training to correctly and safely maintain Mazda vehicles. These instructions should not be performed by "do-it-yourselfers." Customers should not assume this bulletin applies to their vehicle or that their vehicle will develop the described concern. To determine if the information applies, customers should contact their nearest authorized Mazda dealership. Mazda North American Operations reserves the right to alter the specifications and contents of this bulletin without obligation or advance notice. All rights reserved. No part of this bulletin may be reproduced in any form or by any means, electronic or mechanical--including photocopying and recording and the use of any kind of information storage and retrieval system ---without permission in writing.

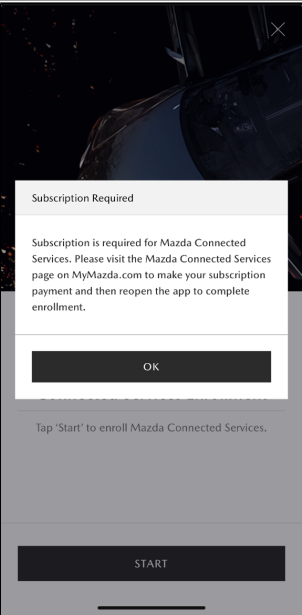
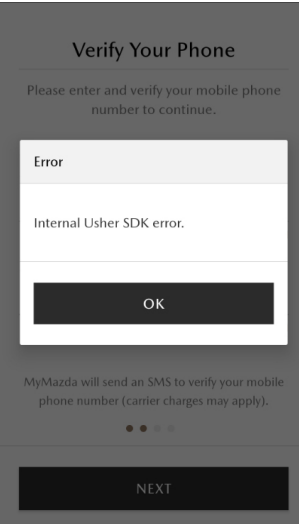
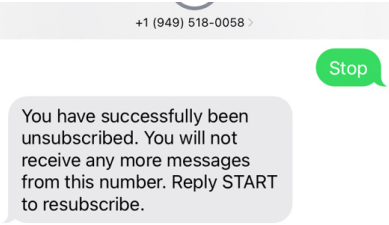
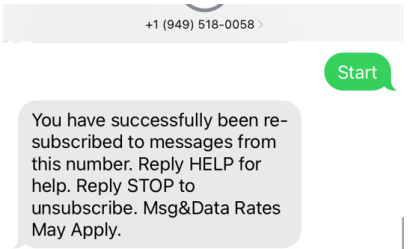
	<p>Required", requests the customer to sign up for a paid subscription plan.</p> <p>This pop-up notification will not disappear until customer has paid for subscription plan through the <a href="#">Mazda Connected Services Owner Portal</a>.</p> <p>Once customer has purchased a subscription plan, it is recommended to close the app &amp; re-login back into MyMazda app to refresh the connected services status.</p> <p>Once the system recognizes customer's subscription status (this could take up to 12 hours), the "subscription required" pop-up will disappear.</p>	<p><b>Dealer</b> - No Action needed; however, if the customer is having difficulty with the <a href="#">Mazda Connected Services Owner Portal</a>, refer the customer to CEC at (800) 222-5500</p>
<p>The customer is not able to create a MyMazda account. The customer receives the following error: <b>MyMazda App</b> - Internal Usher SDK error.</p>  <p><b>MyMazda Website</b> - ERROR! Unable to send one-time password.</p>	<p>Customer inadvertently texted "Stop" to 1-949 518-0058 (Twilio SMS for Mazda)</p> 	<ol style="list-style-type: none"> <li>1. Text "Start" to 1-949 518-0058 (Twilio SMS for Mazda)</li> <li>2. Retry to create a MyMazda account.</li> </ol> <p><b>NOTE:</b> USA and Canada only</p> 

**CONSUMER NOTICE:** The information and instructions in this bulletin are intended for use by skilled technicians. Mazda technicians utilize the proper tools/ equipment and take training to correctly and safely maintain Mazda vehicles. These instructions should not be performed by "do-it-yourselfers." Customers should not assume this bulletin applies to their vehicle or that their vehicle will develop the described concern. To determine if the information applies, customers should contact their nearest authorized Mazda dealership. Mazda North American Operations reserves the right to alter the specifications and contents of this bulletin without obligation or advance notice. All rights reserved. No part of this bulletin may be reproduced in any form or by any means, electronic or mechanical--including photocopying and recording and the use of any kind of information storage and retrieval system ---without permission in writing.

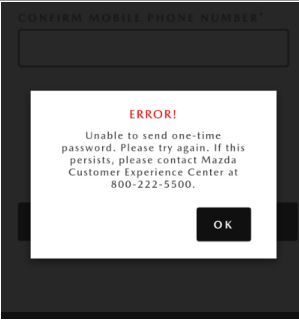
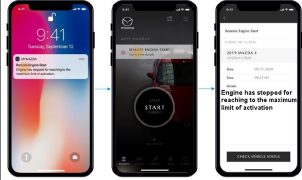
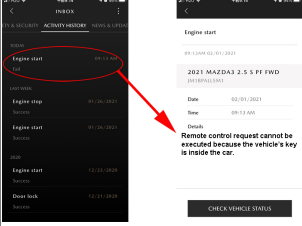
		
<p>4 Remote function(s) inoperative.</p> <ul style="list-style-type: none"> <li>• Engine Start / Stop</li> <li>• Door Lock / Unlock</li> <li>• Lights ON / OFF</li> <li>• Climate Control</li> </ul>	<p>Go to the MyMazda App to view the reason for remote function failure.</p>	<div data-bbox="1189 555 1492 734">  </div> <p><b>Push Notification</b></p> <p><b>OS Lock Screen</b> Tap the push notification</p> <p><b>Home</b> Tap the alert card</p> <p><b>Inbox Detail</b> Tap "check vehicle status"</p> <p><b>Activity History</b></p> <p>Go to the MyMazda App INBOX -&gt; ACTIVITY HISTORY -&gt; to view reason for remote function failure.</p> 

**CONSUMER NOTICE:** The information and instructions in this bulletin are intended for use by skilled technicians. Mazda technicians utilize the proper tools/ equipment and take training to correctly and safely maintain Mazda vehicles. These instructions should not be performed by "do-it-yourselfers." Customers should not assume this bulletin applies to their vehicle or that their vehicle will develop the described concern. To determine if the information applies, customers should contact their nearest authorized Mazda dealership. Mazda North American Operations reserves the right to alter the specifications and contents of this bulletin without obligation or advance notice. All rights reserved. No part of this bulletin may be reproduced in any form or by any means, electronic or mechanical--including photocopying and recording and the use of any kind of information storage and retrieval system ---without permission in writing.

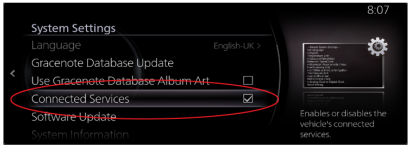
	Check Campaign Status	<p>Go to <a href="#">eMDCS</a> Vehicle Inquiry and confirm the following campaigns are not shown or closed:</p> <ul style="list-style-type: none"> <li>• CSP06</li> <li>• CSP07</li> <li>• SSPC7</li> <li>• DRW41</li> </ul>
	Remote Function Troubleshooting	<p>1. Confirm CV reception strength is good.</p>  <p>2. Confirm Connected Services is enabled (box checked). Go to Settings -&gt; System Settings -&gt; Connected Services.</p>  <p>3. Use MDARS to ID the vehicle and check for DTC's stored. Are DTC(s) stored?</p> <ul style="list-style-type: none"> <li>• Yes - Go to MGSS and perform normal DTC diagnostics.</li> <li>• No - Go to next step.</li> </ul> <p>4. Confirm TCU software version. Go to <a href="#">Telematics Communication Unit (TCU) Updates</a></p> <p>5. Disconnect battery for 30 seconds and then reconnect (KAM reset).</p> <p>6. Close the MyMazda App and then reopen. Did this resolve issue?</p> <ul style="list-style-type: none"> <li>• Yes - Repair complete</li> <li>• No - Go to next step</li> </ul> <p>7. Fill out <a href="#">Dealer Connected Vehicle Questionnaire</a></p> <p>8. Contact Hotline for additional technical support if needed.</p>
	Remote Climate Control only available on EV and PHEV	No action needed. See <a href="#">SA-066/24</a>
	Only a single remote request can	Customer needs to wait 60 seconds

**CONSUMER NOTICE:** The information and instructions in this bulletin are intended for use by skilled technicians. Mazda technicians utilize the proper tools/ equipment and take training to correctly and safely maintain Mazda vehicles. These instructions should not be performed by "do-it-yourselfers." Customers should not assume this bulletin applies to their vehicle or that their vehicle will develop the described concern. To determine if the information applies, customers should contact their nearest authorized Mazda dealership. Mazda North American Operations reserves the right to alter the specifications and contents of this bulletin without obligation or advance notice. All rights reserved. No part of this bulletin may be reproduced in any form or by any means, electronic or mechanical---including photocopying and recording and the use of any kind of information storage and retrieval system ---without permission in writing.

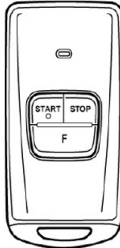
	be made per 60-second period	for the initial request cycle to be completed to make the second request.
	Remote Transmitter Key(s) in the vehicle	Do not leave keys in vehicle.
	<p>1. Aftermarket Remote Engine Start accessory installed.                  2. Mazda Remote Engine Start (BCKA-V7-620) accessory installed.</p> 	<p>1. Remove the aftermarket accessory.                  2. The customer can use either the Mazda Remote Engine Start accessory or the MyMazda app function. Cannot use both.</p> <p><b>Mazda Remote Engine Start (RES) Removal</b></p> <p>a. Remove the Mazda Remote Engine Start (RES) accessory module.                  b. Deactivate and activate Advanced Key(s). Refer to MGSS <a href="#">IMMOBILIZER SYSTEM-RELATED PARTS PROGRAMMING [(US)]</a>.</p>
	TCU in “deep sleep” mode due to vehicle being parked for a long period.	Advise customer to drive the vehicle as normal (at least several miles) and the Connected Services should start working again.
	Low fuel	Advise customer that Remote Engine Start may start vehicle temporarily, but vehicle will turn off automatically when the fuel level is low to conserve the remaining fuel.
	Vehicle is equipped with Manual Transmission	Advise customer that vehicles with a manual transmission do not have the Remote Engine Start/Stop function capability.
	Engine started with key transmitter instead of MyMazda App.	Advise customer they will see an error message when attempting to make a Remote Engine Off request if they initially turned on vehicle with a physical key (instead of through their MyMazda app).
5	No One Time Passcode (OTP) (Vehicle infotainment center display does not provide the Authorization Code during the MyMazda App enrollment)	<p><b>MyMazda App Enrollment Preparation</b></p> <p>1. Create a MyMazda account. See <a href="#">Resources</a>                  2. Complete any "OPEN" Recalls / Special Service Programs. Go to MGSS -&gt; <a href="#">warranty Veh. Inq.</a>                  3. Update the Telematics Communication Unit (TCU) to the latest software version. Go to <a href="#">Telematics Communication Unit (TCU) Updates</a>.                  4. <b>2019 Mazda3 only</b> - Update the Connectivity Master Unit (CMU) to the latest software version. Go to MGSS -&gt; <a href="#">MAZDA CONNECT Updates</a>.                  5. Check TCU Communication Line Status.</p>

**CONSUMER NOTICE:** The information and instructions in this bulletin are intended for use by skilled technicians. Mazda technicians utilize the proper tools/ equipment and take training to correctly and safely maintain Mazda vehicles. These instructions should not be performed by "do-it-yourselfers." Customers should not assume this bulletin applies to their vehicle or that their vehicle will develop the described concern. To determine if the information applies, customers should contact their nearest authorized Mazda dealership. Mazda North American Operations reserves the right to alter the specifications and contents of this bulletin without obligation or advance notice. All rights reserved. No part of this bulletin may be reproduced in any form or by any means, electronic or mechanical--including photocopying and recording and the use of any kind of information storage and retrieval system ---without permission in writing.

- a. Go to MAZDA CONNECT home screen.
- b. Select Entertainment
- c. Select Source List and then select any of the following:
  - FM
  - AM
  - SiriusXM
- d. Check the Connected Vehicle reception strength icon:
  - Reception strength icon shows normal strength. The TCU communication line is Open and ready for enrollment. Go to [Enrollment / Take-Over](#).

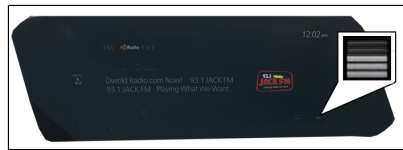

- Reception strength icon shows "X". The TCU Communication Line is Closed. Enrollment is not possible.
- Open the TCU Communication Line:
  - Dealer - Go to [Opening the TCU Communication Line](#)
  - Customer - Go to [Registering Vehicle Information](#) -> [Registering Connected Service](#).

**NOTE:** Use MCVV to check OTP status. Go to [Mazda Connected Vehicle Viewer \(MCVV\) One Time Passcode \(OTP\) Troubleshooting](#)

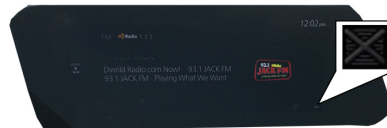

- Reception strength icon shows "\". Move the vehicle to an area with a clear view of the sky.

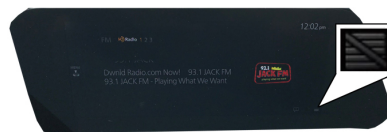

### Enrollment / Take-Over

1. [Install the MyMazda APP](#)

**NOTE:** If 2nd owner, follow this same Enrollment procedure to

**CONSUMER NOTICE:** The information and instructions in this bulletin are intended for use by skilled technicians. Mazda technicians utilize the proper tools/ equipment and take training to correctly and safely maintain Mazda vehicles. These instructions should not be performed by "do-it-yourselfers." Customers should not assume this bulletin applies to their vehicle or that their vehicle will develop the described concern. To determine if the information applies, customers should contact their nearest authorized Mazda dealership. Mazda North American Operations reserves the right to alter the specifications and contents of this bulletin without obligation or advance notice. All rights reserved. No part of this bulletin may be reproduced in any form or by any means, electronic or mechanical--including photocopying and recording and the use of any kind of information storage and retrieval system ---without permission in writing.

perform a Take-Over. Previous owner will receive email notification of Take-Over.

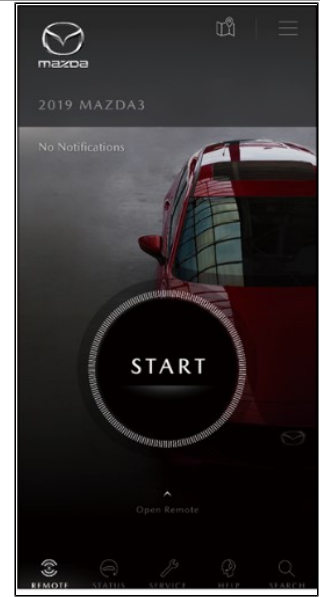

2. Register your user information

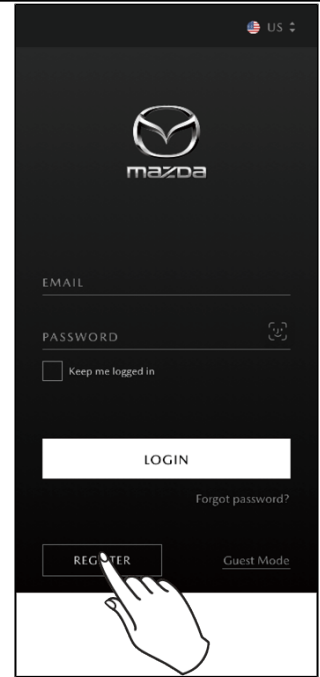

**CONSUMER NOTICE:** The information and instructions in this bulletin are intended for use by skilled technicians. Mazda technicians utilize the proper tools/ equipment and take training to correctly and safely maintain Mazda vehicles. These instructions should not be performed by "do-it-yourselfers." Customers should not assume this bulletin applies to their vehicle or that their vehicle will develop the described concern. To determine if the information applies, customers should contact their nearest authorized Mazda dealership. Mazda North American Operations reserves the right to alter the specifications and contents of this bulletin without obligation or advance notice. All rights reserved. No part of this bulletin may be reproduced in any form or by any means, electronic or mechanical---including photocopying and recording and the use of any kind of information storage and retrieval system ---without permission in writing.

3. Register vehicle information

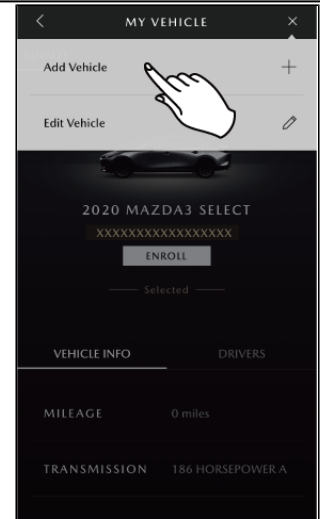

4. Register Connected Service

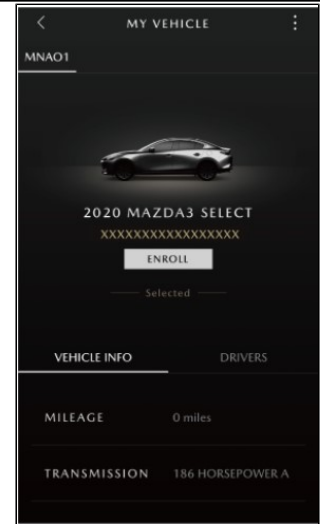

**NOTE 1:**  
If the communication line is closed, this message will appear advising the customer to wait for the communication line to re-open.

Error

Authorization Code request is processing.  
This may take up to 12 hours to complete.  
You will be notified when the process is completed. (400S25)

OK

**CONSUMER NOTICE:** The information and instructions in this bulletin are intended for use by skilled technicians. Mazda technicians utilize the proper tools/ equipment and take training to correctly and safely maintain Mazda vehicles. These instructions should not be performed by "do-it-yourselfers." Customers should not assume this bulletin applies to their vehicle or that their vehicle will develop the described concern. To determine if the information applies, customers should contact their nearest authorized Mazda dealership. Mazda North American Operations reserves the right to alter the specifications and contents of this bulletin without obligation or advance notice. All rights reserved. No part of this bulletin may be reproduced in any form or by any means, electronic or mechanical---including photocopying and recording and the use of any kind of information storage and retrieval system ---without permission in writing.

When the communication line re-opens, this message will appear.

"Connectivity is Complete"

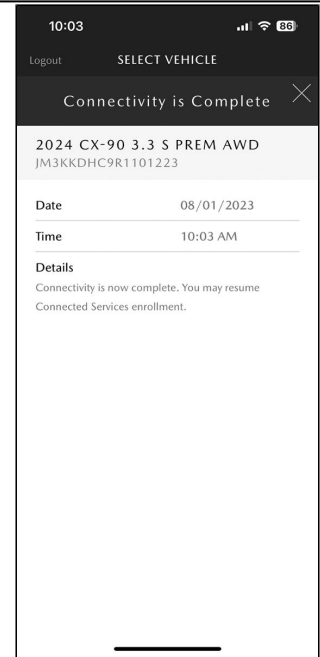

**NOTE 2:**

If the Connected Vehicle Services free trial period has ended, a pop-up notification, "Subscription Required", requests the customer to sign up for a paid subscription plan.

This pop-up notification will not disappear until customer has paid for subscription plan through the [Mazda Connected Services Owner Portal](#).

Once customer has purchased a subscription plan, it is recommended to close the app & re-login back into MyMazda app to refresh the connected services status.

**Subscription Required**

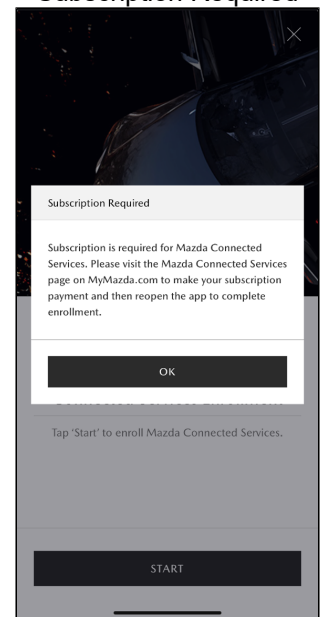

4b. Once system recognizes customer's subscription status (this could take up to 12 hours), the "subscription required" pop-up will disappear and "Connected Services Enrollment" screen will

**CONSUMER NOTICE:** The information and instructions in this bulletin are intended for use by skilled technicians. Mazda technicians utilize the proper tools/ equipment and take training to correctly and safely maintain Mazda vehicles. These instructions should not be performed by "do-it-yourselfers." Customers should not assume this bulletin applies to their vehicle or that their vehicle will develop the described concern. To determine if the information applies, customers should contact their nearest authorized Mazda dealership. Mazda North American Operations reserves the right to alter the specifications and contents of this bulletin without obligation or advance notice. All rights reserved. No part of this bulletin may be reproduced in any form or by any means, electronic or mechanical--including photocopying and recording and the use of any kind of information storage and retrieval system ---without permission in writing.

appear.

**NOTE:** If the customer is having difficulty with the [Mazda Connected Services Owner Portal](#), refer the customer to CEC at (800) 222-5500

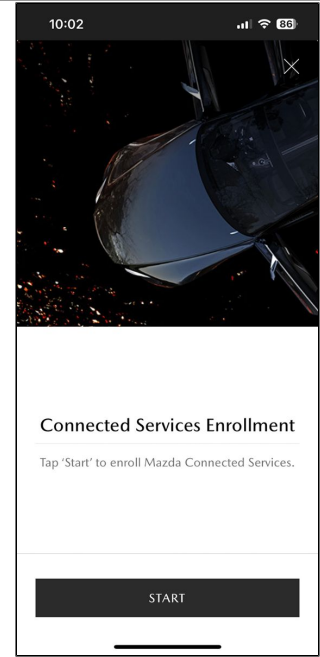

5. Switch the ignition ON in your Mazda vehicle.
6. Wait 30 seconds.
7. Tap Next.

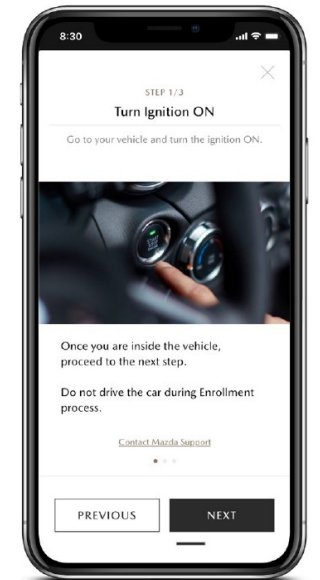

**CONSUMER NOTICE:** The information and instructions in this bulletin are intended for use by skilled technicians. Mazda technicians utilize the proper tools/ equipment and take training to correctly and safely maintain Mazda vehicles. These instructions should not be performed by "do-it-yourselfers." Customers should not assume this bulletin applies to their vehicle or that their vehicle will develop the described concern. To determine if the information applies, customers should contact their nearest authorized Mazda dealership. Mazda North American Operations reserves the right to alter the specifications and contents of this bulletin without obligation or advance notice. All rights reserved. No part of this bulletin may be reproduced in any form or by any means, electronic or mechanical---including photocopying and recording and the use of any kind of information storage and retrieval system ---without permission in writing.

8. Tap Request to receive authorization code on your vehicle's Mazda Connect center display.

Wait a few minutes for the infotainment center display to show the Authorization Code.

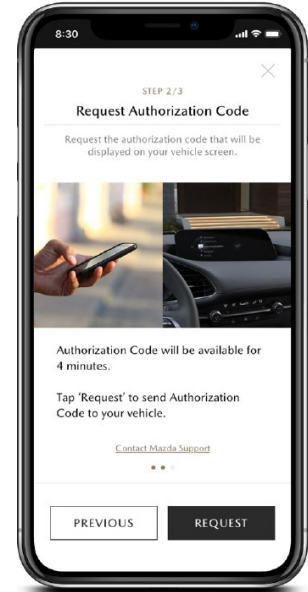

9. After a few minutes, the infotainment center display will show the Authorization Code. Enter the authorization code in the MyMazda app, then tap Submit.

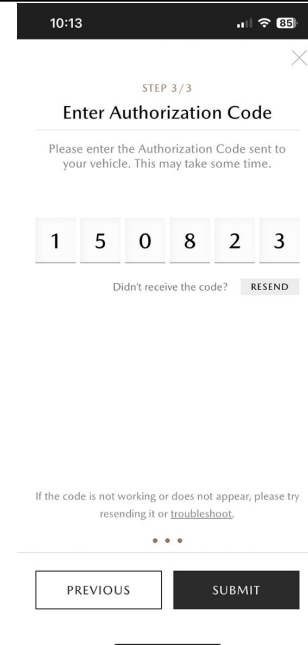

**CONSUMER NOTICE:** The information and instructions in this bulletin are intended for use by skilled technicians. Mazda technicians utilize the proper tools/ equipment and take training to correctly and safely maintain Mazda vehicles. These instructions should not be performed by "do-it-yourselfers." Customers should not assume this bulletin applies to their vehicle or that their vehicle will develop the described concern. To determine if the information applies, customers should contact their nearest authorized Mazda dealership. Mazda North American Operations reserves the right to alter the specifications and contents of this bulletin without obligation or advance notice. All rights reserved. No part of this bulletin may be reproduced in any form or by any means, electronic or mechanical---including photocopying and recording and the use of any kind of information storage and retrieval system ---without permission in writing.

10. After enrollment is successfully processed and the vehicle is connected, you will receive a push notification.

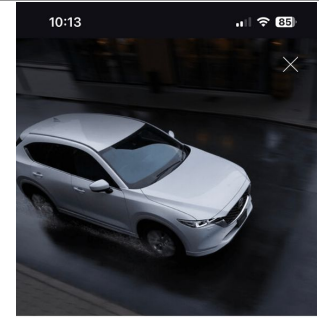

Your car is now connected

Connected Services will be available once the vehicle is off.



Tap any of the remote commands and learn about long press from the tutorial.

Tap the button below to set your notification preference.

SET NOTIFICATION PREFERENCE

OTP Troubleshooting

1. Check reception strength icon:

-  - Go to Step 2.
-  - Go to [MCVV OTP Troubleshooting](#)

2. Use MDARS to ID the vehicle and check for DTC's stored. Are DTC(s) stored?

- Yes - Go to MGSS and perform normal DTC diagnostics.
- No - Perform [Diagnostic Information \(ODR\) Data Collection](#) Procedure, then go to step 3.

3. Confirm TCU software version. Go to [Telematics Communication Unit \(TCU\) Updates](#)

4. 2019 Mazda3 Only - Confirm [CMU software version](#) is at 11012 or later.

5. Clear DTC(s).

**NOTE:** If DTC 2050:55 is stored, go to [SA-038/21](#) to clear DTC.

**CONSUMER NOTICE:** The information and instructions in this bulletin are intended for use by skilled technicians. Mazda technicians utilize the proper tools/ equipment and take training to correctly and safely maintain Mazda vehicles. These instructions should not be performed by "do-it-yourselfers." Customers should not assume this bulletin applies to their vehicle or that their vehicle will develop the described concern. To determine if the information applies, customers should contact their nearest authorized Mazda dealership. Mazda North American Operations reserves the right to alter the specifications and contents of this bulletin without obligation or advance notice. All rights reserved. No part of this bulletin may be reproduced in any form or by any means, electronic or mechanical--including photocopying and recording and the use of any kind of information storage and retrieval system ---without permission in writing.

			<p>6. Check <a href="#">TCU Remote Service Flag Information</a></p> <ul style="list-style-type: none"> <li>Flag Information 1101... - go to step 9.</li> <li>Flag Information 0000... - go to step 10.</li> </ul> <p>7. Perform <a href="#">TCU / CMU Communication Connectivity Test</a></p> <p>8. Disconnect 12V battery for 5-10 minutes, then retry connected vehicle enrollment.</p> <p><b>NOTE:</b> Test drive vehicle after battery disconnect to allow the GPS clock to synchronize before retrying Authorization Code.</p> <p>9. Fill out <a href="#">Dealer Connected Vehicle Questionnaire</a></p> <p>10. Contact Hotline for additional technical support if needed.</p>
6	<p>MAZDA CONNECT connected vehicle reception strength icon shows "X"</p>  <p>This is a normal condition if the customer has not enrolled into connected vehicle services.</p>	<p>Communication Line is Closed</p>	<p>Customer/Dealer can Open the Communication Line anytime via MyMazda app</p> <ul style="list-style-type: none"> <li><b>Note:</b> There might be a slight delay in making the backend connection since it was temporarily deactivated.</li> <li>Open the TCU Communication Line:             <ul style="list-style-type: none"> <li>Dealer - Go to <a href="#">Opening the TCU Communication Line</a></li> <li>Customer - Go to <a href="#">Registering Vehicle Information</a> -&gt; <a href="#">Registering Connected Service</a>.</li> </ul> </li> </ul>
		<p>Customer deactivate Connected Services (Opt-Out)</p>	<p>Go to <a href="#">eMDCS Vehicle Inquiry</a>. Does eMDCS show <a href="#">CSP04</a> status closed?</p> <ul style="list-style-type: none"> <li>Yes - Customer opt-out. No action needed.</li> <li>No - CSP04 is not shown. Go to next Action below.</li> </ul>
		<p>No reception</p>	<p>1. Confirm vehicle has a clear view of</p>

**CONSUMER NOTICE:** The information and instructions in this bulletin are intended for use by skilled technicians. Mazda technicians utilize the proper tools/ equipment and take training to correctly and safely maintain Mazda vehicles. These instructions should not be performed by "do-it-yourselfers." Customers should not assume this bulletin applies to their vehicle or that their vehicle will develop the described concern. To determine if the information applies, customers should contact their nearest authorized Mazda dealership. Mazda North American Operations reserves the right to alter the specifications and contents of this bulletin without obligation or advance notice. All rights reserved. No part of this bulletin may be reproduced in any form or by any means, electronic or mechanical--including photocopying and recording and the use of any kind of information storage and retrieval system ---without permission in writing.

the sky.

**Note:** Authorization Code (OTP) may be processing. This may take up to 12 hours to complete.

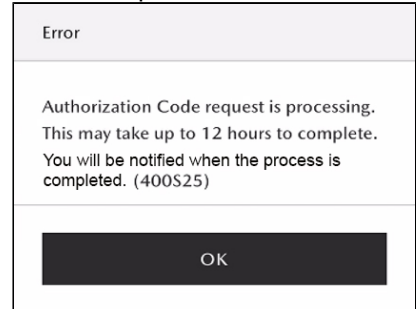

2. Check for DTCs. Are there any DTC's stored?

- Yes: Go to MGSS for normal DTC diagnosis.
- No: Go to next step.

3. Confirm TCU software version. Go to [Telematics Communication Unit \(TCU\) Updates](#)

4. 2019 Mazda3 Only - Confirm [CMU software](#) version is at 11012 or later.

5. Disconnect battery terminal for 5-10 minutes, then test drive the vehicle. Is the reception strength signal normal?

- Yes: Repair complete.
- No: Go to next step.

6. Compare Tel antenna No. 1 signal strength with good known vehicle near by. Go to DIAGNOSTIC ASSIST FUNCTION [CONNECTIVITY MASTER UNIT (US)]  
Functional Inspection / Adjustment -> Navigation System Inspection

**Good** - Contact Hotline for technical support

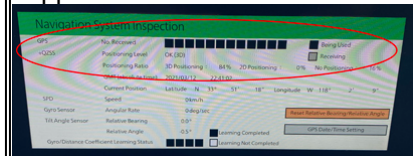



**No Good** - Swap Tel antenna No. 1 with known good vehicle

**CONSUMER NOTICE:** The information and instructions in this bulletin are intended for use by skilled technicians. Mazda technicians utilize the proper tools/ equipment and take training to correctly and safely maintain Mazda vehicles. These instructions should not be performed by "do-it-yourselfers." Customers should not assume this bulletin applies to their vehicle or that their vehicle will develop the described concern. To determine if the information applies, customers should contact their nearest authorized Mazda dealership. Mazda North American Operations reserves the right to alter the specifications and contents of this bulletin without obligation or advance notice. All rights reserved. No part of this bulletin may be reproduced in any form or by any means, electronic or mechanical---including photocopying and recording and the use of any kind of information storage and retrieval system ---without permission in writing.

			
7	<p>Instrument Cluster Error Message "In Vehicle Network Malfunction"</p>  <p>or</p> <p>"Telematics Malfunction"</p>  <p>and DTC U3000:04 TCU stored</p>	TCU software	Go to <a href="#">09-001/24</a>
8	<p>Except CX-5, CX-9 and <b>MX-5</b></p> <p>MAZDA CONNECT and/or MyMazda App displays incorrect tire pressures after battery disconnect and/or infotainment CMU software update.</p> 	Incorrect calendar entry (month/day/year) after a battery disconnect or infotainment system software update.	Go to <a href="#">SA-002/21</a>
9	2019 Mazda3 only	Improper telematics	Go to <a href="#">CSP07</a> Repair instructions.

**CONSUMER NOTICE:** The information and instructions in this bulletin are intended for use by skilled technicians. Mazda technicians utilize the proper tools/ equipment and take training to correctly and safely maintain Mazda vehicles. These instructions should not be performed by "do-it-yourselfers." Customers should not assume this bulletin applies to their vehicle or that their vehicle will develop the described concern. To determine if the information applies, customers should contact their nearest authorized Mazda dealership. Mazda North American Operations reserves the right to alter the specifications and contents of this bulletin without obligation or advance notice. All rights reserved. No part of this bulletin may be reproduced in any form or by any means, electronic or mechanical--including photocopying and recording and the use of any kind of information storage and retrieval system ---without permission in writing.

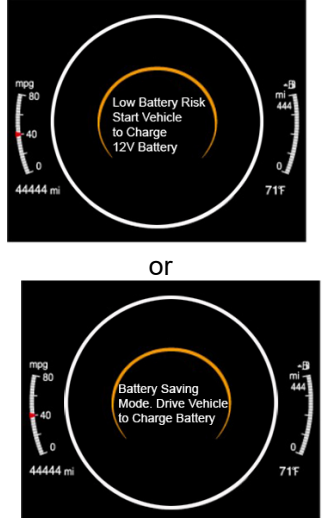
	<ul style="list-style-type: none"> <li>The customer is not able to activate Connected Services via the MyMazda app after CSP06 completion.</li> <li>MAZDA CONNECT connected vehicle reception strength icon is missing or shows unsubscribed after CSP06 completion.</li> </ul> 	<p>communication unit (TCU) software.</p>	
<p>10</p>	<p>2020 Mazda3 only</p> <ul style="list-style-type: none"> <li>Infotainment center display does not provide the Authorization Code</li> <li>Infotainment center display "Software Update Error" message</li> </ul> 	<p>Enrollment error</p>	<p>Go to <a href="#">SSPC1</a></p>
<p>11</p>	<p>2021 Mazda3, CX-30, CX-50, and MX-30 functions inoperative</p> <ul style="list-style-type: none"> <li>Vehicle Status Alert</li> <li>Remote Engine Start / Stop</li> <li>Remote Door Lock / Unlock</li> <li>Remote Hazard Lights ON / OFF</li> <li>Vehicle Finder (vehicle location mapping function is available)</li> </ul>	<p>Vehicle's electrical control area network (CAN) is in "Sleep Mode"</p>	 <p>No dealer visit is required. Sleep Mode can be reset by starting the engine and idling or driving for 5 minutes or longer.</p>

**CONSUMER NOTICE:** The information and instructions in this bulletin are intended for use by skilled technicians. Mazda technicians utilize the proper tools/ equipment and take training to correctly and safely maintain Mazda vehicles. These instructions should not be performed by "do-it-yourselfers." Customers should not assume this bulletin applies to their vehicle or that their vehicle will develop the described concern. To determine if the information applies, customers should contact their nearest authorized Mazda dealership. Mazda North American Operations reserves the right to alter the specifications and contents of this bulletin without obligation or advance notice. All rights reserved. No part of this bulletin may be reproduced in any form or by any means, electronic or mechanical--including photocopying and recording and the use of any kind of information storage and retrieval system ---without permission in writing.

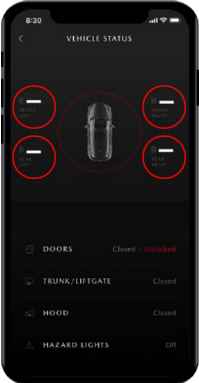
			Go to <a href="#">09-010/22</a> .
12	<p>First remote control attempt fails, second attempt works fine.</p> <ul style="list-style-type: none"> <li>• Engine Start / Stop</li> <li>• Door Lock / Unlock</li> <li>• Lights ON / OFF</li> </ul>	Improper telematics communication unit (TCU) software.	Go to TSB <a href="#">16-002/20</a> .
13	Engine turns off when customer opens vehicle door.	Normal Operation	Advise that, for customer's safety and security, vehicle is designed to shut-off automatically when the vehicle door is opened.
14	<ul style="list-style-type: none"> <li>• Low Tire pressure will not clear after correcting tire pressure.</li> <li>• Vehicle status is inaccurate.</li> </ul>	MyMazda App is not real time.	<ul style="list-style-type: none"> <li>• Customer must go to MyMazda app's Inbox and read/open all the messages related to the low tire pressure alert, then the "Low tire pressure" alert will clear from MyMazda app's Health Report</li> <li>• Message will clear after next drive cycle.</li> </ul>
15	<p>CX-5, CX-9 and <b>MX-5</b> The MyMazda App does not display tire air pressures</p> 	CX-5, CX-9 and <b>MX-5</b> Normal Operation	No action Needed

**Mazda Connected Vehicle Viewer (MCVV) One Time Passcode (OTP) Troubleshooting (Vehicles built after July 1, 2021 (20 TCU, AT&T))**

OTP Request	MCVV Vehicle Communication Line Status Reference Status	Next Step
	<p>1 New Vehicle Inventory (TCU no enrollment ever) Status: Opened Status Detail: Open Completed (with no date)</p> 	<p>OTP request successful. If not, go to <a href="#">No One Time</a></p>

**CONSUMER NOTICE:** The information and instructions in this bulletin are intended for use by skilled technicians. Mazda technicians utilize the proper tools/ equipment and take training to correctly and safely maintain Mazda vehicles. These instructions should not be performed by "do-it-yourselfers." Customers should not assume this bulletin applies to their vehicle or that their vehicle will develop the described concern. To determine if the information applies, customers should contact their nearest authorized Mazda dealership. Mazda North American Operations reserves the right to alter the specifications and contents of this bulletin without obligation or advance notice. All rights reserved. No part of this bulletin may be reproduced in any form or by any means, electronic or mechanical---including photocopying and recording and the use of any kind of information storage and retrieval system ---without permission in writing.

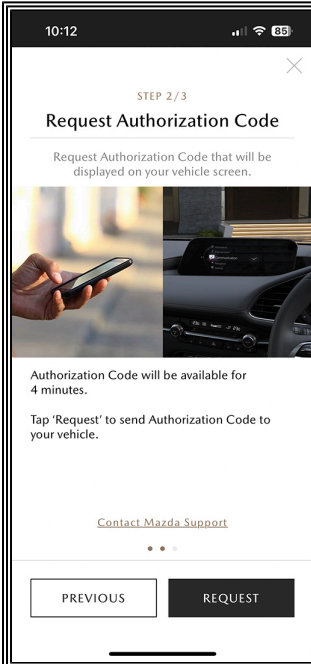

Vehicle Communication Line Atatus		
Status	Request Date	Status Detail
Opened		Open Completed



Passcode (OTP) -> OTP Troubleshooting -> Step 2.

2 Status: Open Requested  
Status Detail: Processing

Vehicle Communication Line Atatus		
Status	Request Date	Status Detail
Open Requested	10/12/2022 23:41	Processing



400S19  
Error  
The Authorization Code could not be sent because vehicle connectivity has not been established yet. Please try again after connectivity is established. (400S19)  
OK

3 Status: Open Requested  
Status Detail: Request Failed

Vehicle Communication Line Atatus		
Status	Request Date	Status Detail
Open Requested	10/12/2022 23:41	Request Failed 10/12/2022 23:11



400S25  
With new App  
Error  
Authorization Code request is processing. This may take up to 12 hours to complete. Please try again later. (400S25)  
OK

4 Status: Open Requested  
Status Detail: Open Failed

Vehicle Communication Line Atatus		
Status	Request Date	Status Detail
Open Requested	10/12/2022 23:41	Open Failed 10/12/2022 23:11



400S25  
With old App  
Error  
Server Error.Please try again later.  
OK

Phone carrier connection is processing.



The customer needs to wait for the completion of the activation.

If no change after waiting 12 hours, go to [No One Time Passcode \(OTP\)](#) -> OTP Troubleshooting -> Step 2.

5 Status: Open Flag Setting Requested  
Status Detail: Processing

Phone carrier connection is complete.

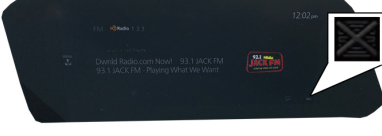
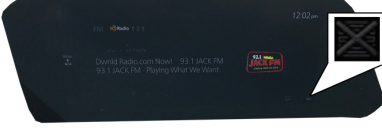
**CONSUMER NOTICE:** The information and instructions in this bulletin are intended for use by skilled technicians. Mazda technicians utilize the proper tools/ equipment and take training to correctly and safely maintain Mazda vehicles. These instructions should not be performed by "do-it-yourselfers." Customers should not assume this bulletin applies to their vehicle or that their vehicle will develop the described concern. To determine if the information applies, customers should contact their nearest authorized Mazda dealership. Mazda North American Operations reserves the right to alter the specifications and contents of this bulletin without obligation or advance notice. All rights reserved. No part of this bulletin may be reproduced in any form or by any means, electronic or mechanical--including photocopying and recording and the use of any kind of information storage and retrieval system ---without permission in writing.

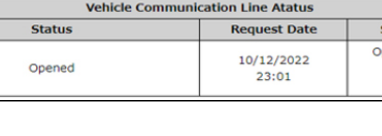
		<p>6</p> <table border="1"> <thead> <tr> <th colspan="3">Vehicle Communication Line Atatus</th> </tr> <tr> <th>Status</th> <th>Request Date</th> <th>Status Detail</th> </tr> </thead> <tbody> <tr> <td>Open Flag Setting Requested</td> <td>10/12/2022 23:01</td> <td>Processing 10/12/2022 23:11</td> </tr> </tbody> </table>  <p>Status: Open Flag Setting Requested Status Detail: Request Failed</p> <table border="1"> <thead> <tr> <th colspan="3">Vehicle Communication Line Atatus</th> </tr> <tr> <th>Status</th> <th>Request Date</th> <th>Status Detail</th> </tr> </thead> <tbody> <tr> <td>Open Flag Setting Requested</td> <td>10/12/2022 23:01</td> <td>Request Failed 10/12/2022 23:51</td> </tr> </tbody> </table>  <p>Status: Open Flag Setting Requested Status Detail: Flag Setting Failed</p> <table border="1"> <thead> <tr> <th colspan="3">Vehicle Communication Line Atatus</th> </tr> <tr> <th>Status</th> <th>Request Date</th> <th>Status Detail</th> </tr> </thead> <tbody> <tr> <td>Open Flag Setting Requested</td> <td>10/12/2022 23:01</td> <td>Flag Setting Failed 10/12/2022 23:51</td> </tr> </tbody> </table> 	Vehicle Communication Line Atatus			Status	Request Date	Status Detail	Open Flag Setting Requested	10/12/2022 23:01	Processing 10/12/2022 23:11	Vehicle Communication Line Atatus			Status	Request Date	Status Detail	Open Flag Setting Requested	10/12/2022 23:01	Request Failed 10/12/2022 23:51	Vehicle Communication Line Atatus			Status	Request Date	Status Detail	Open Flag Setting Requested	10/12/2022 23:01	Flag Setting Failed 10/12/2022 23:51	<p>System waiting for:</p> <ol style="list-style-type: none"> <li>Ignition ON.</li> <li>Flag Setting</li> </ol> <p>The customer needs to wait for the completion of the <b>flag download</b> and IG-ON.</p> <p>If not:</p> <ol style="list-style-type: none"> <li>Disconnect 12V battery 5-10 minutes, then retry OTP request.</li> <li>go to <b>No One Time Passcode (OTP)</b> -&gt; OTP Troubleshooting -&gt; Step 2.</li> </ol>
Vehicle Communication Line Atatus																														
Status	Request Date	Status Detail																												
Open Flag Setting Requested	10/12/2022 23:01	Processing 10/12/2022 23:11																												
Vehicle Communication Line Atatus																														
Status	Request Date	Status Detail																												
Open Flag Setting Requested	10/12/2022 23:01	Request Failed 10/12/2022 23:51																												
Vehicle Communication Line Atatus																														
Status	Request Date	Status Detail																												
Open Flag Setting Requested	10/12/2022 23:01	Flag Setting Failed 10/12/2022 23:51																												
	<p>8</p>	<table border="1"> <thead> <tr> <th colspan="3">Vehicle Communication Line Atatus</th> </tr> <tr> <th>Status</th> <th>Request Date</th> <th>Status Detail</th> </tr> </thead> <tbody> <tr> <td>Close Requested</td> <td>10/12/2022 23:01</td> <td>Close Failed 10/12/2022 23:51</td> </tr> </tbody> </table>  <p>Status: Close Requested Status Detail: Close Failed</p>	Vehicle Communication Line Atatus			Status	Request Date	Status Detail	Close Requested	10/12/2022 23:01	Close Failed 10/12/2022 23:51	<p>Possible customer has WiFi Contract. The customer must cancel WiFi contract.</p>																		
Vehicle Communication Line Atatus																														
Status	Request Date	Status Detail																												
Close Requested	10/12/2022 23:01	Close Failed 10/12/2022 23:51																												
	<p>9</p>	<p>TCU has history of enrollment Status: Opened Status Detail: Open Completed (with date)</p> <table border="1"> <thead> <tr> <th colspan="3">Vehicle Communication Line Atatus</th> </tr> <tr> <th>Status</th> <th>Request Date</th> <th>Status Detail</th> </tr> </thead> <tbody> <tr> <td>Opened</td> <td>10/12/2022 23:01</td> <td>Open Completed 10/12/2022 23:51</td> </tr> </tbody> </table> 	Vehicle Communication Line Atatus			Status	Request Date	Status Detail	Opened	10/12/2022 23:01	Open Completed 10/12/2022 23:51	<p>OTP request successful.</p> <p>If not, go to <b>No One Time Passcode (OTP)</b> -&gt; OTP Troubleshooting -&gt; Step 2.</p>																		
Vehicle Communication Line Atatus																														
Status	Request Date	Status Detail																												
Opened	10/12/2022 23:01	Open Completed 10/12/2022 23:51																												

**CONSUMER NOTICE:** The information and instructions in this bulletin are intended for use by skilled technicians. Mazda technicians utilize the proper tools/ equipment and take training to correctly and safely maintain Mazda vehicles. These instructions should not be performed by "do-it-yourselfers." Customers should not assume this bulletin applies to their vehicle or that their vehicle will develop the described concern. To determine if the information applies, customers should contact their nearest authorized Mazda dealership. Mazda North American Operations reserves the right to alter the specifications and contents of this bulletin without obligation or advance notice. All rights reserved. No part of this bulletin may be reproduced in any form or by any means, electronic or mechanical--including photocopying and recording and the use of any kind of information storage and retrieval system ---without permission in writing.



**CONSUMER NOTICE:** The information and instructions in this bulletin are intended for use by skilled technicians. Mazda technicians utilize the proper tools/ equipment and take training to correctly and safely maintain Mazda vehicles. These instructions should not be performed by "do-it-yourselfers." Customers should not assume this bulletin applies to their vehicle or that their vehicle will develop the described concern. To determine if the information applies, customers should contact their nearest authorized Mazda dealership. Mazda North American Operations reserves the right to alter the specifications and contents of this bulletin without obligation or advance notice. All rights reserved. No part of this bulletin may be reproduced in any form or by any means, electronic or mechanical---including photocopying and recording and the use of any kind of information storage and retrieval system ---without permission in writing.

Opening the TCU Communication Line

**Register Vehicle Information**

1. Select "hamburger menu" on top right of screen

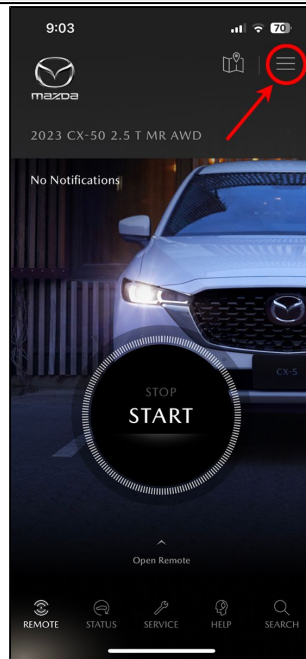

2. From the MYMAZDA dropdown, select My Vehicles

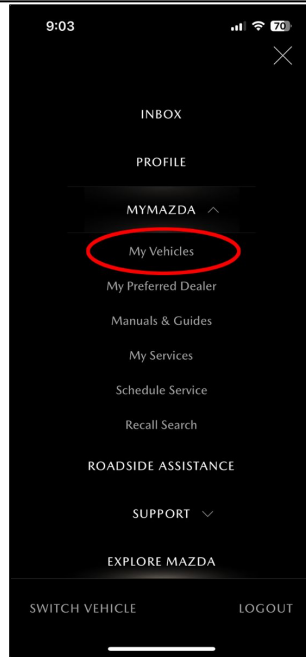

**CONSUMER NOTICE:** The information and instructions in this bulletin are intended for use by skilled technicians. Mazda technicians utilize the proper tools/ equipment and take training to correctly and safely maintain Mazda vehicles. These instructions should not be performed by "do-it-yourselfers." Customers should not assume this bulletin applies to their vehicle or that their vehicle will develop the described concern. To determine if the information applies, customers should contact their nearest authorized Mazda dealership. Mazda North American Operations reserves the right to alter the specifications and contents of this bulletin without obligation or advance notice. All rights reserved. No part of this bulletin may be reproduced in any form or by any means, electronic or mechanical---including photocopying and recording and the use of any kind of information storage and retrieval system ---without permission in writing.

3. Select "menu" on top right of screen

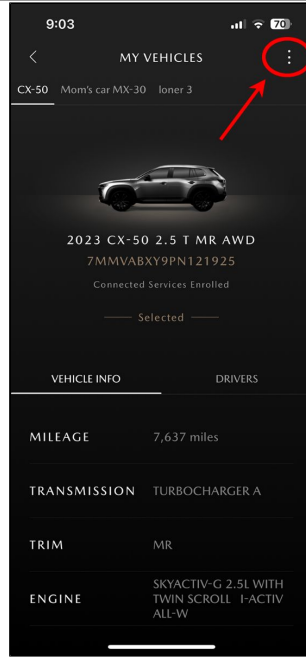

4. Select "Add Vehicle"

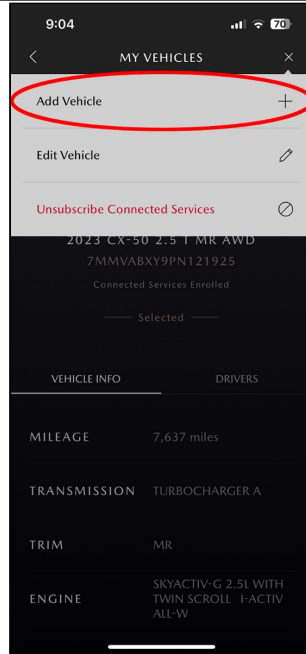

**CONSUMER NOTICE:** The information and instructions in this bulletin are intended for use by skilled technicians. Mazda technicians utilize the proper tools/ equipment and take training to correctly and safely maintain Mazda vehicles. These instructions should not be performed by "do-it-yourselfers." Customers should not assume this bulletin applies to their vehicle or that their vehicle will develop the described concern. To determine if the information applies, customers should contact their nearest authorized Mazda dealership. Mazda North American Operations reserves the right to alter the specifications and contents of this bulletin without obligation or advance notice. All rights reserved. No part of this bulletin may be reproduced in any form or by any means, electronic or mechanical--including photocopying and recording and the use of any kind of information storage and retrieval system ---without permission in writing.

5. Select "SCAN VIN"

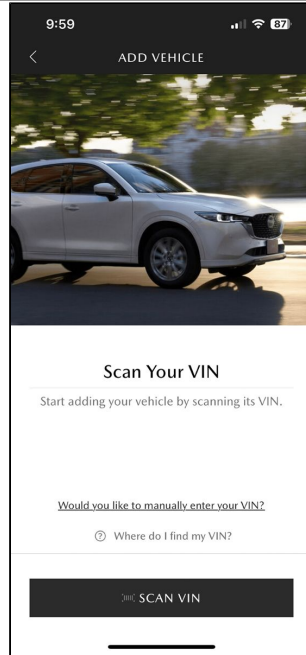

6. Select "SCAN"

**NOTE:** You can also manually enter the VIN if preferred. Select "ENTER VIN"

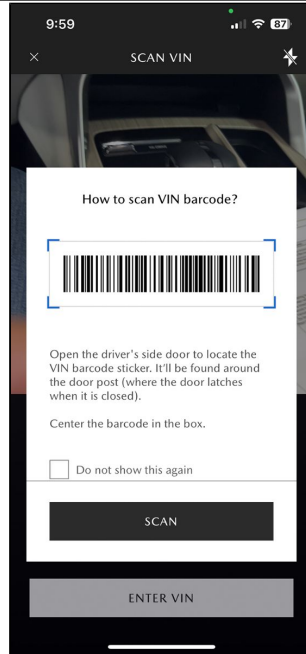

**CONSUMER NOTICE:** The information and instructions in this bulletin are intended for use by skilled technicians. Mazda technicians utilize the proper tools/ equipment and take training to correctly and safely maintain Mazda vehicles. These instructions should not be performed by "do-it-yourselfers." Customers should not assume this bulletin applies to their vehicle or that their vehicle will develop the described concern. To determine if the information applies, customers should contact their nearest authorized Mazda dealership. Mazda North American Operations reserves the right to alter the specifications and contents of this bulletin without obligation or advance notice. All rights reserved. No part of this bulletin may be reproduced in any form or by any means, electronic or mechanical--including photocopying and recording and the use of any kind of information storage and retrieval system ---without permission in writing.

7. Select "NEXT"

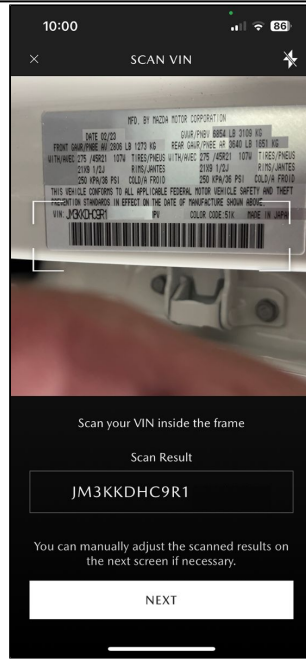

8. Select "VALIDATE"

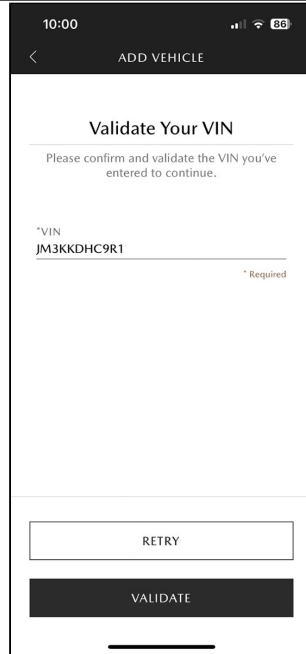

**CONSUMER NOTICE:** The information and instructions in this bulletin are intended for use by skilled technicians. Mazda technicians utilize the proper tools/ equipment and take training to correctly and safely maintain Mazda vehicles. These instructions should not be performed by "do-it-yourselfers." Customers should not assume this bulletin applies to their vehicle or that their vehicle will develop the described concern. To determine if the information applies, customers should contact their nearest authorized Mazda dealership. Mazda North American Operations reserves the right to alter the specifications and contents of this bulletin without obligation or advance notice. All rights reserved. No part of this bulletin may be reproduced in any form or by any means, electronic or mechanical---including photocopying and recording and the use of any kind of information storage and retrieval system ---without permission in writing.

9. Select "NEXT"

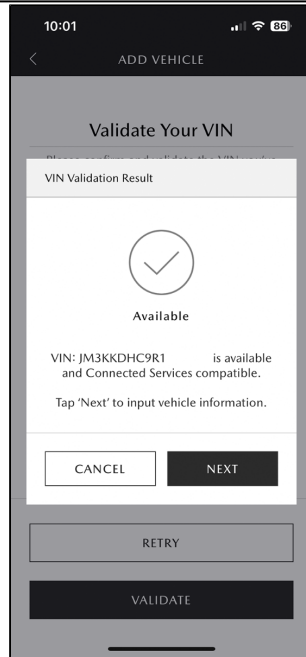

10. Enter Vehicle Name and select local dealer. Then select "SUBMIT"

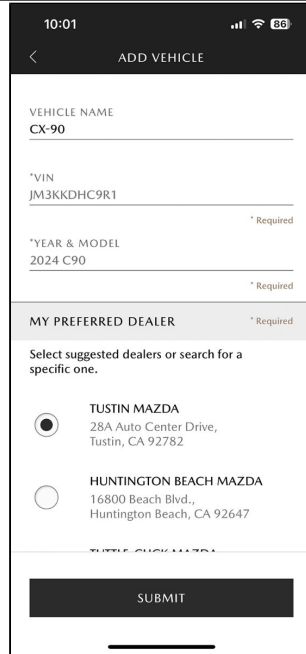

**CONSUMER NOTICE:** The information and instructions in this bulletin are intended for use by skilled technicians. Mazda technicians utilize the proper tools/ equipment and take training to correctly and safely maintain Mazda vehicles. These instructions should not be performed by "do-it-yourselfers." Customers should not assume this bulletin applies to their vehicle or that their vehicle will develop the described concern. To determine if the information applies, customers should contact their nearest authorized Mazda dealership. Mazda North American Operations reserves the right to alter the specifications and contents of this bulletin without obligation or advance notice. All rights reserved. No part of this bulletin may be reproduced in any form or by any means, electronic or mechanical--including photocopying and recording and the use of any kind of information storage and retrieval system ---without permission in writing.

11. Select "ENROLL"

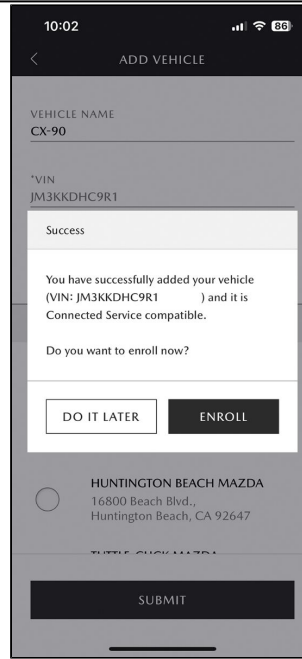

12a. If the communication line is closed, this message will appear advising the customer to wait for the communication line to re-open

Authorization Code (OTP) is processing. This may take up to 12 hours to complete.

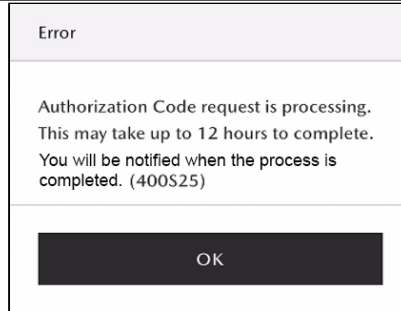

**CONSUMER NOTICE:** The information and instructions in this bulletin are intended for use by skilled technicians. Mazda technicians utilize the proper tools/ equipment and take training to correctly and safely maintain Mazda vehicles. These instructions should not be performed by "do-it-yourselfers." Customers should not assume this bulletin applies to their vehicle or that their vehicle will develop the described concern. To determine if the information applies, customers should contact their nearest authorized Mazda dealership. Mazda North American Operations reserves the right to alter the specifications and contents of this bulletin without obligation or advance notice. All rights reserved. No part of this bulletin may be reproduced in any form or by any means, electronic or mechanical--including photocopying and recording and the use of any kind of information storage and retrieval system ---without permission in writing.

When the communication line re-opens, this message will appear.  
 "Connectivity is Complete"

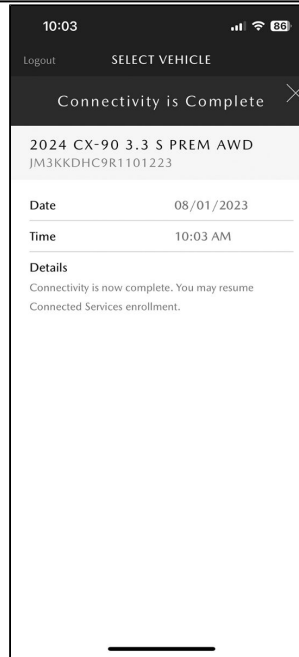

12.b  
**NOTE 1:** If the Connected Vehicle Services free trial period has ended, there will be a pop-up notification, "Subscription Required", requesting the customer to sign up for a paid subscription plan.

This pop-up notification will not disappear until customer has paid for subscription plan through the [Mazda Connected Services Owner Portal](#).

Once customer has purchased a subscription plan, it is recommended to close the app & re-login back into MyMazda app to refresh the connected services status.

Once system recognizes customer's subscription status (this could take up to 12 hours), the "subscription required" pop-up will disappear.

**NOTE 2:** If the customer is having difficulty with the [Mazda Connected Services Owner Portal](#), refer the customer to CEC at (800) 222-5500

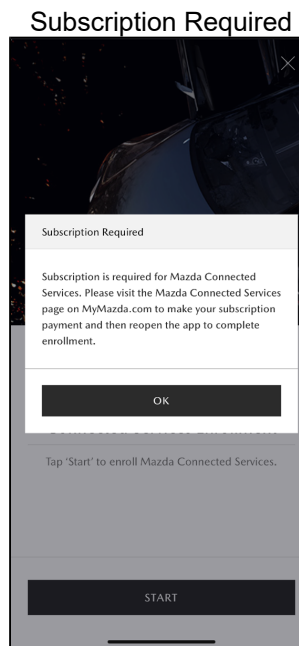

**CONSUMER NOTICE:** The information and instructions in this bulletin are intended for use by skilled technicians. Mazda technicians utilize the proper tools/ equipment and take training to correctly and safely maintain Mazda vehicles. These instructions should not be performed by "do-it-yourselfers." Customers should not assume this bulletin applies to their vehicle or that their vehicle will develop the described concern. To determine if the information applies, customers should contact their nearest authorized Mazda dealership. Mazda North American Operations reserves the right to alter the specifications and contents of this bulletin without obligation or advance notice. All rights reserved. No part of this bulletin may be reproduced in any form or by any means, electronic or mechanical--including photocopying and recording and the use of any kind of information storage and retrieval system ---without permission in writing.

**Registering Connected Service**

13. Select "START"

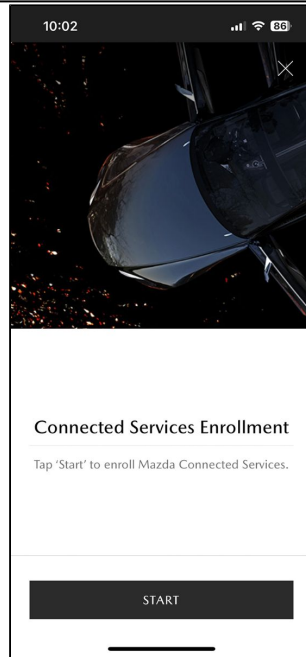

14. Agree to the Terms & Conditions, then select "AGREE"

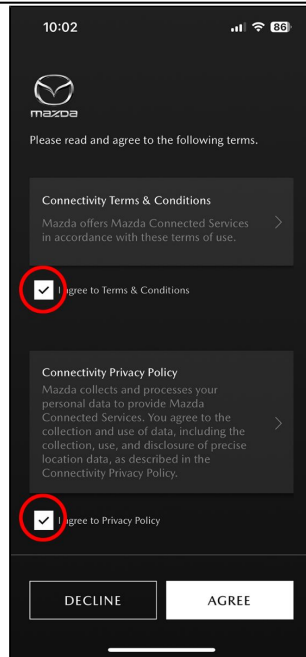

**CONSUMER NOTICE:** The information and instructions in this bulletin are intended for use by skilled technicians. Mazda technicians utilize the proper tools/ equipment and take training to correctly and safely maintain Mazda vehicles. These instructions should not be performed by "do-it-yourselfers." Customers should not assume this bulletin applies to their vehicle or that their vehicle will develop the described concern. To determine if the information applies, customers should contact their nearest authorized Mazda dealership. Mazda North American Operations reserves the right to alter the specifications and contents of this bulletin without obligation or advance notice. All rights reserved. No part of this bulletin may be reproduced in any form or by any means, electronic or mechanical--including photocopying and recording and the use of any kind of information storage and retrieval system ---without permission in writing.



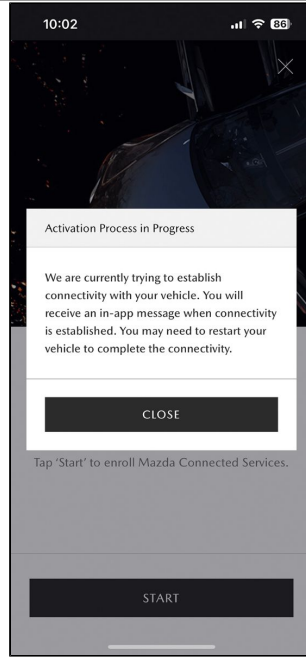

15. You will see a message stating "Activation Process in Progress", Select "CLOSE"

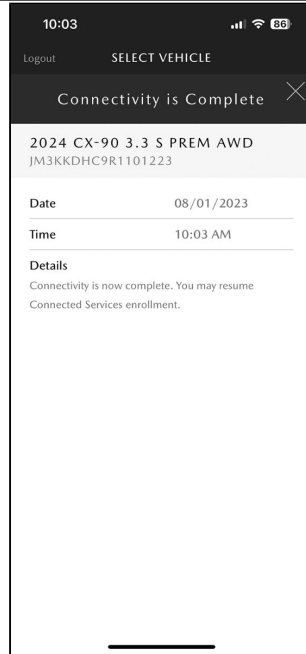

16. You will receive a message saying "Connectivity is Complete". OK to close this window. Go to next step.



**CONSUMER NOTICE:** The information and instructions in this bulletin are intended for use by skilled technicians. Mazda technicians utilize the proper tools/ equipment and take training to correctly and safely maintain Mazda vehicles. These instructions should not be performed by "do-it-yourselfers." Customers should not assume this bulletin applies to their vehicle or that their vehicle will develop the described concern. To determine if the information applies, customers should contact their nearest authorized Mazda dealership. Mazda North American Operations reserves the right to alter the specifications and contents of this bulletin without obligation or advance notice. All rights reserved. No part of this bulletin may be reproduced in any form or by any means, electronic or mechanical---including photocopying and recording and the use of any kind of information storage and retrieval system ---without permission in writing.

<p>17. Turn the ignition OFF for 10 minutes or longer.</p>	
<p>18. Turn the ignition ON.</p>	
<p>19. Check the Connected Vehicle reception strength icon:</p>	
<ul style="list-style-type: none"> <li>Reception strength icon shows normal strength. TCU is now active. Proceed to <a href="#">Enrollment / Take-Over</a>.</li> </ul>	
<ul style="list-style-type: none"> <li>Reception strength icon shows "X". TCU activation is still processing. Repeat steps 17-19.</li> </ul> <p><b>NOTE:</b></p> <ul style="list-style-type: none"> <li>This step may need to be repeated a few times until normal strength is shown.</li> <li>If steps 17-19 was repeated several times with no change, disconnect 12V battery for 5-10 minutes, then recheck reception strength icon.</li> </ul>	

**Diagnostic Information (ODR) Data Collection Procedure**

<p>1. ID the vehicle using MDARS</p>	<p>---</p>
--------------------------------------	------------

**CONSUMER NOTICE:** The information and instructions in this bulletin are intended for use by skilled technicians. Mazda technicians utilize the proper tools/ equipment and take training to correctly and safely maintain Mazda vehicles. These instructions should not be performed by "do-it-yourselfers." Customers should not assume this bulletin applies to their vehicle or that their vehicle will develop the described concern. To determine if the information applies, customers should contact their nearest authorized Mazda dealership. Mazda North American Operations reserves the right to alter the specifications and contents of this bulletin without obligation or advance notice. All rights reserved. No part of this bulletin may be reproduced in any form or by any means, electronic or mechanical--including photocopying and recording and the use of any kind of information storage and retrieval system ---without permission in writing.

2. Select "Toolbox"

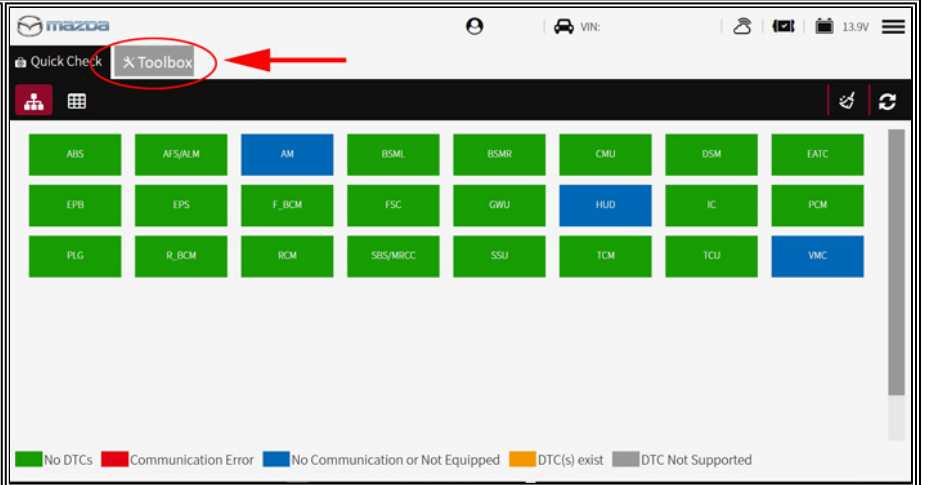

3. Select Vehicle Icon

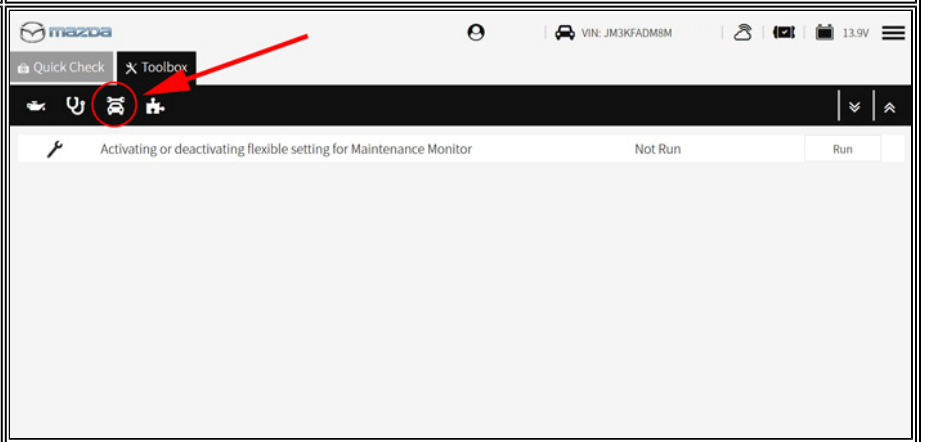

4. Expand "Collect Diagnostic Information"

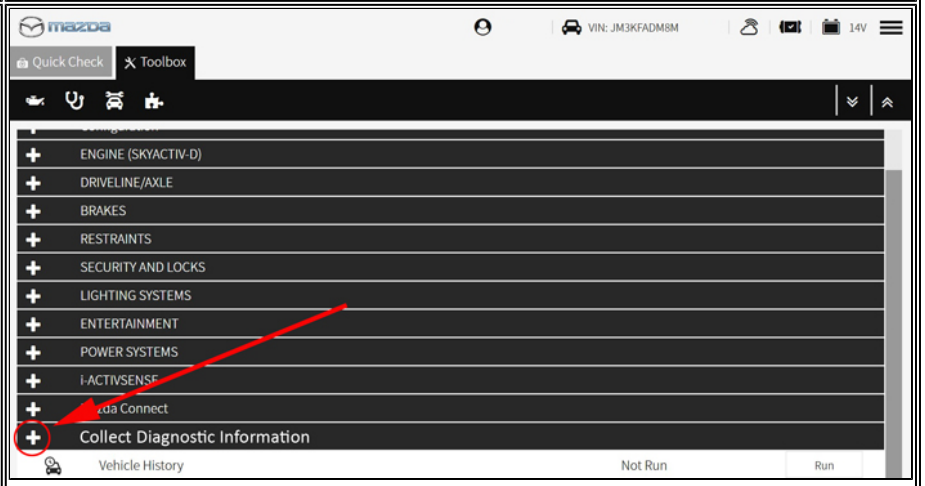

**CONSUMER NOTICE:** The information and instructions in this bulletin are intended for use by skilled technicians. Mazda technicians utilize the proper tools/ equipment and take training to correctly and safely maintain Mazda vehicles. These instructions should not be performed by "do-it-yourselfers." Customers should not assume this bulletin applies to their vehicle or that their vehicle will develop the described concern. To determine if the information applies, customers should contact their nearest authorized Mazda dealership. Mazda North American Operations reserves the right to alter the specifications and contents of this bulletin without obligation or advance notice. All rights reserved. No part of this bulletin may be reproduced in any form or by any means, electronic or mechanical---including photocopying and recording and the use of any kind of information storage and retrieval system ---without permission in writing.

5. Select Collecting diagnostic information "Run".

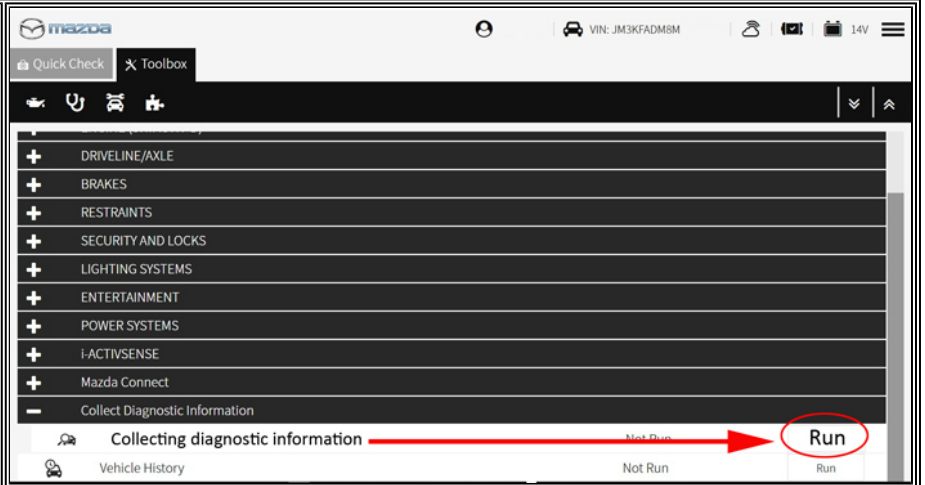

6. Turn the ignition ON, then select "Next"

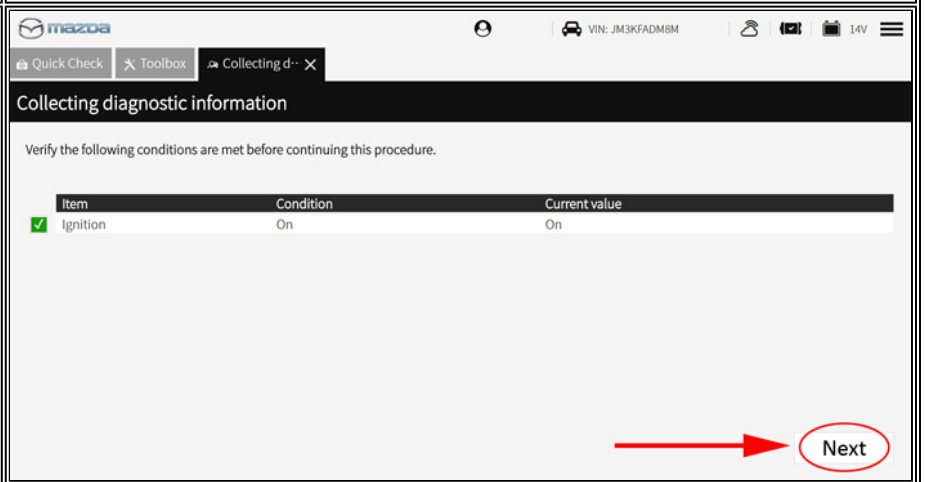

7. Wait for collection to complete.

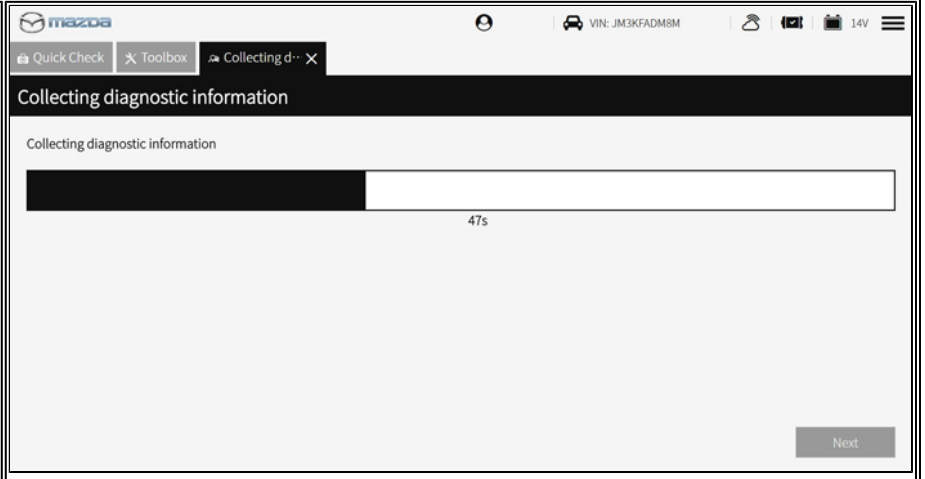

**CONSUMER NOTICE:** The information and instructions in this bulletin are intended for use by skilled technicians. Mazda technicians utilize the proper tools/ equipment and take training to correctly and safely maintain Mazda vehicles. These instructions should not be performed by "do-it-yourselfers." Customers should not assume this bulletin applies to their vehicle or that their vehicle will develop the described concern. To determine if the information applies, customers should contact their nearest authorized Mazda dealership. Mazda North American Operations reserves the right to alter the specifications and contents of this bulletin without obligation or advance notice. All rights reserved. No part of this bulletin may be reproduced in any form or by any means, electronic or mechanical---including photocopying and recording and the use of any kind of information storage and retrieval system ---without permission in writing.

8. Confirm that the Diagnostic Information (ODR) collection has been successful. Select "Next" to exit.

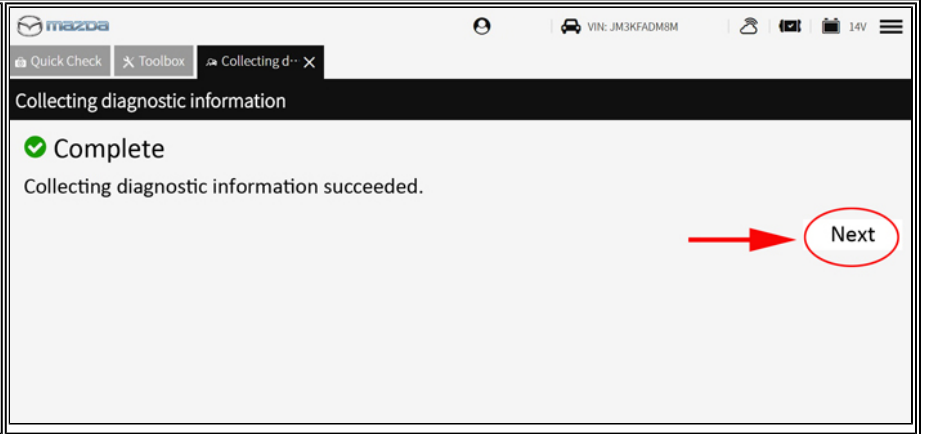

**CONSUMER NOTICE:** The information and instructions in this bulletin are intended for use by skilled technicians. Mazda technicians utilize the proper tools/ equipment and take training to correctly and safely maintain Mazda vehicles. These instructions should not be performed by "do-it-yourselfers." Customers should not assume this bulletin applies to their vehicle or that their vehicle will develop the described concern. To determine if the information applies, customers should contact their nearest authorized Mazda dealership. Mazda North American Operations reserves the right to alter the specifications and contents of this bulletin without obligation or advance notice. All rights reserved. No part of this bulletin may be reproduced in any form or by any means, electronic or mechanical---including photocopying and recording and the use of any kind of information storage and retrieval system ---without permission in writing.

**TCU / CMU Communication Connectivity Test**

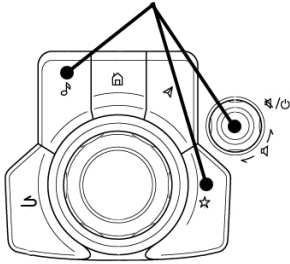
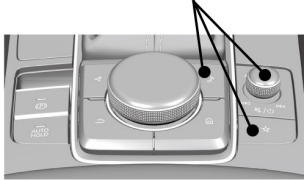
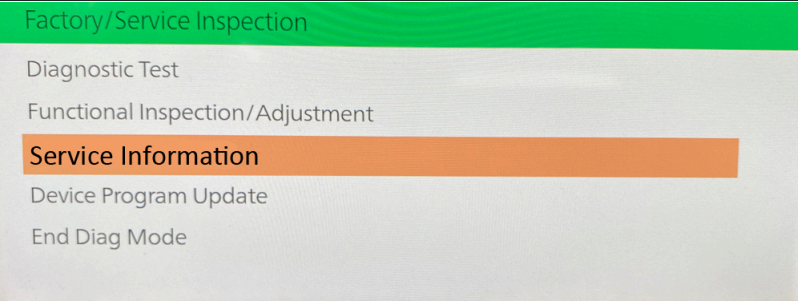
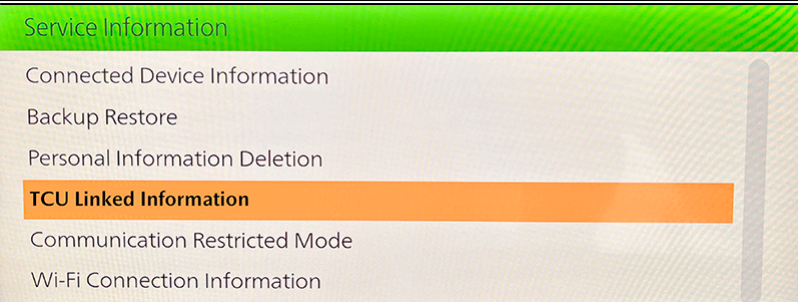
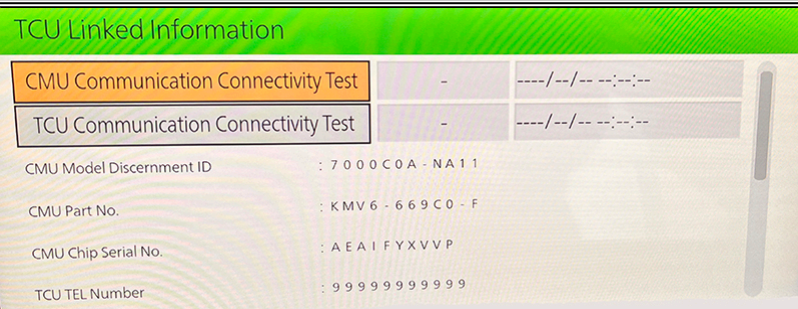
<p>1. Press and hold the Volume knob, then press and hold the Entertainment and Favorite buttons at the same time for 3-5 seconds and the Factory/Service Inspection screen will appear.</p>	<p align="center"><b>CX-5 and CX-9</b></p> 	<p align="center"><b>Except CX-5 and CX-9</b></p> 														
<p>2. Select Service Information.</p>																
<p>3. Select TCU Linked information.</p>																
<p>4. Select CMU Communication Connectivity Test</p>	 <table border="1" style="width: 100%; border-collapse: collapse;"> <tr> <td colspan="2" style="background-color: #00b050; color: white; text-align: center;">TCU Linked Information</td> </tr> <tr> <td style="background-color: #f4a460;">CMU Communication Connectivity Test</td> <td align="center">-    ---/--/--:--:--</td> </tr> <tr> <td style="background-color: #f4a460;">TCU Communication Connectivity Test</td> <td align="center">-    ---/--/--:--:--</td> </tr> <tr> <td>CMU Model Discernment ID</td> <td align="right">: 7 0 0 0 C 0 A - N A 1 1</td> </tr> <tr> <td>CMU Part No.</td> <td align="right">: K M V 6 - 6 6 9 C 0 - F</td> </tr> <tr> <td>CMU Chip Serial No.</td> <td align="right">: A E A I F Y X V V P</td> </tr> <tr> <td>TCU TEL Number</td> <td align="right">: 9 9 9 9 9 9 9 9 9 9</td> </tr> </table>		TCU Linked Information		CMU Communication Connectivity Test	-    ---/--/--:--:--	TCU Communication Connectivity Test	-    ---/--/--:--:--	CMU Model Discernment ID	: 7 0 0 0 C 0 A - N A 1 1	CMU Part No.	: K M V 6 - 6 6 9 C 0 - F	CMU Chip Serial No.	: A E A I F Y X V V P	TCU TEL Number	: 9 9 9 9 9 9 9 9 9 9
TCU Linked Information																
CMU Communication Connectivity Test	-    ---/--/--:--:--															
TCU Communication Connectivity Test	-    ---/--/--:--:--															
CMU Model Discernment ID	: 7 0 0 0 C 0 A - N A 1 1															
CMU Part No.	: K M V 6 - 6 6 9 C 0 - F															
CMU Chip Serial No.	: A E A I F Y X V V P															
TCU TEL Number	: 9 9 9 9 9 9 9 9 9 9															

**CONSUMER NOTICE:** The information and instructions in this bulletin are intended for use by skilled technicians. Mazda technicians utilize the proper tools/ equipment and take training to correctly and safely maintain Mazda vehicles. These instructions should not be performed by "do-it-yourselfers." Customers should not assume this bulletin applies to their vehicle or that their vehicle will develop the described concern. To determine if the information applies, customers should contact their nearest authorized Mazda dealership. Mazda North American Operations reserves the right to alter the specifications and contents of this bulletin without obligation or advance notice. All rights reserved. No part of this bulletin may be reproduced in any form or by any means, electronic or mechanical--including photocopying and recording and the use of any kind of information storage and retrieval system ---without permission in writing.

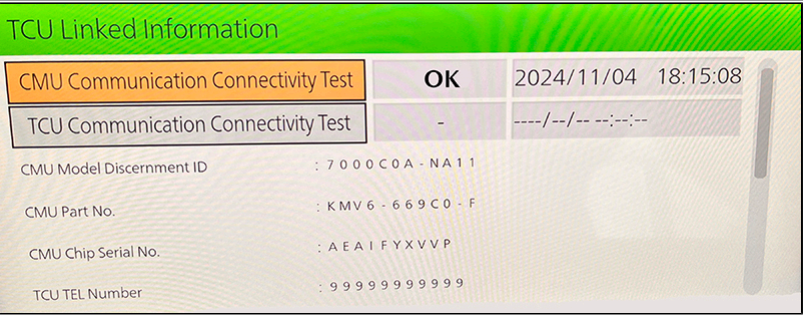
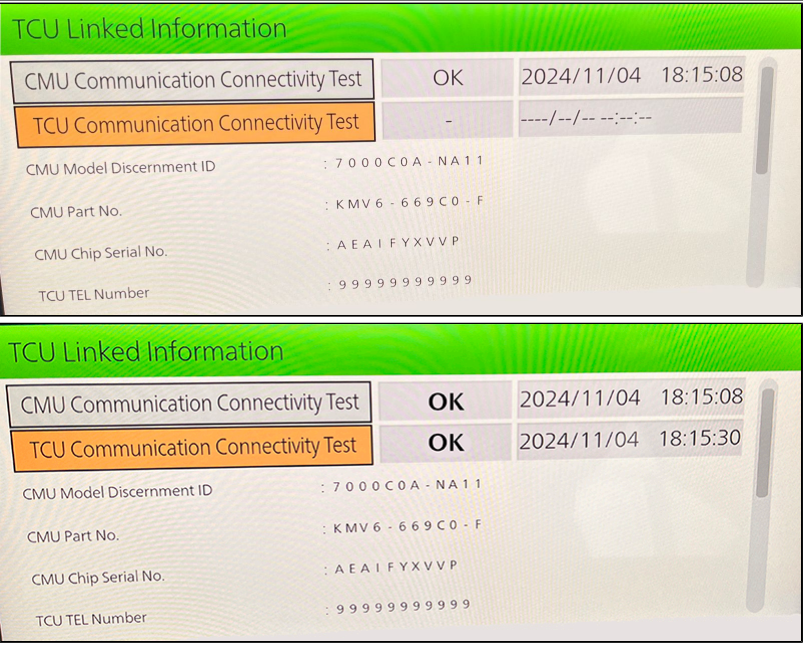
	
<p>5. Select TCU Communication Connectivity Test Is CMU and TCU Communication Connectivity Test OK or NG?</p> <ul style="list-style-type: none"> <li>• <b>OK</b> - Test complete. TCU communication to server is good</li> <li>• <b>NG</b> - Go to <a href="#">Mazda Connected Vehicle Viewer (MCVV) One Time Passcode (OTP) Troubleshooting</a></li> </ul>	

**TCU Software Version Check**

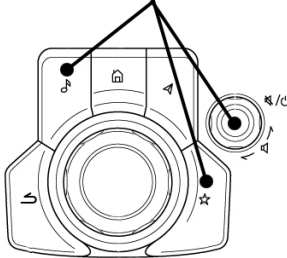
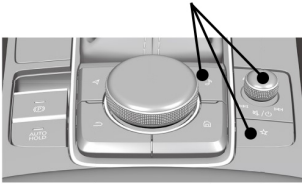
<p>1. Press and hold the Volume knob, then press and hold the Entertainment and Favorite buttons at the same time for 3-5 seconds and the Factory/Service Inspection screen will appear.</p>	<p style="text-align: center;"><b>CX-5 and CX-9</b></p> 	<p style="text-align: center;"><b>Except CX-5 and CX-9</b></p> 
----------------------------------------------------------------------------------------------------------------------------------------------------------------------------------------------	----------------------------------------------------------------------------------------------------------------------------------------------	------------------------------------------------------------------------------------------------------------------------------------------------------

**CONSUMER NOTICE:** The information and instructions in this bulletin are intended for use by skilled technicians. Mazda technicians utilize the proper tools/ equipment and take training to correctly and safely maintain Mazda vehicles. These instructions should not be performed by "do-it-yourselfers." Customers should not assume this bulletin applies to their vehicle or that their vehicle will develop the described concern. To determine if the information applies, customers should contact their nearest authorized Mazda dealership. Mazda North American Operations reserves the right to alter the specifications and contents of this bulletin without obligation or advance notice. All rights reserved. No part of this bulletin may be reproduced in any form or by any means, electronic or mechanical---including photocopying and recording and the use of any kind of information storage and retrieval system ---without permission in writing.

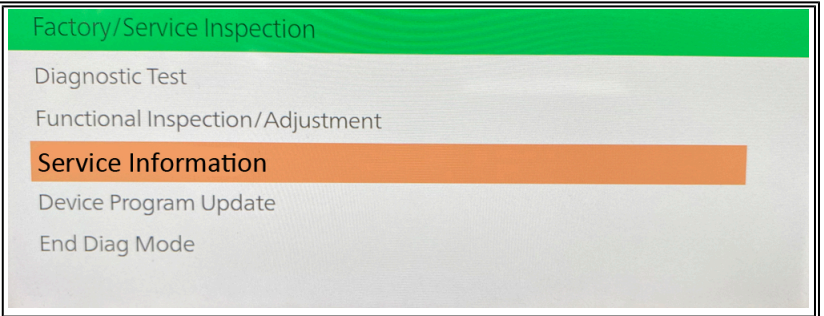
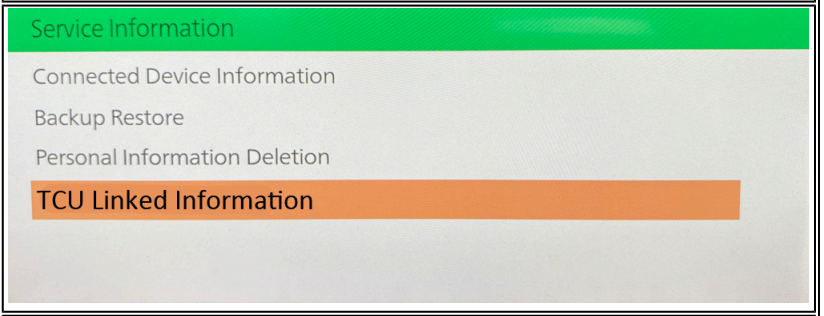
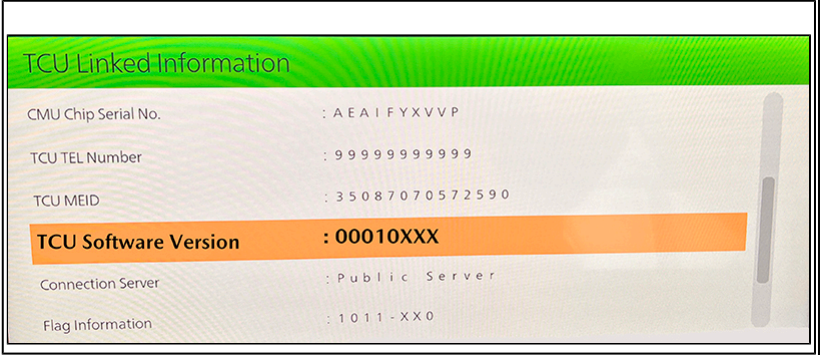
<p>2. Select Service Information.</p>	 <p>Factory/Service Inspection</p> <ul style="list-style-type: none"> <li>Diagnostic Test</li> <li>Functional Inspection/Adjustment</li> <li><b>Service Information</b></li> <li>Device Program Update</li> <li>End Diag Mode</li> </ul>
<p>3. Select TCU Linked information.</p>	 <p>Service Information</p> <ul style="list-style-type: none"> <li>Connected Device Information</li> <li>Backup Restore</li> <li>Personal Information Deletion</li> <li><b>TCU Linked Information</b></li> </ul>
<p>4. Scroll down to TCU Software Version and confirm the software version is up to date. Go to <a href="#">Telematics Communication Unit (TCU) Updates</a> <b>Is the TCU software version correct?</b></p> <ul style="list-style-type: none"> <li>• <b>Yes:</b> TCU Software Version Check is complete.</li> <li>• <b>No:</b> Go to <a href="#">Telematics Communication Unit (TCU) Updates</a> to update the TCU software version.</li> </ul>	 <p>TCU Linked Information</p> <ul style="list-style-type: none"> <li>CMU Chip Serial No. : AEA1FYXVVP</li> <li>TCU TEL Number : 999999999999</li> <li>TCU MEID : 35087070572590</li> <li><b>TCU Software Version : 00010XXX</b></li> <li>Connection Server : Public Server</li> <li>Flag Information : 1011-XX0</li> </ul>

**TCU MEID Number Check**

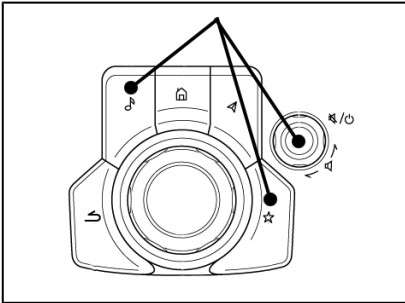
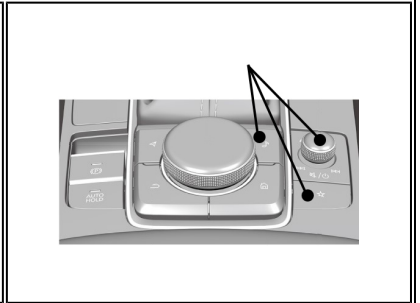
<p>1. Press and hold the Volume knob, then press and hold the Entertainment and Favorite buttons at the same time for 3-5 seconds and the Factory/Service Inspection screen will appear.</p>	<p><b>CX-5 and CX-9</b></p>	<p><b>Except CX-5 and CX-9</b></p>
		

**CONSUMER NOTICE:** The information and instructions in this bulletin are intended for use by skilled technicians. Mazda technicians utilize the proper tools/ equipment and take training to correctly and safely maintain Mazda vehicles. These instructions should not be performed by "do-it-yourselfers." Customers should not assume this bulletin applies to their vehicle or that their vehicle will develop the described concern. To determine if the information applies, customers should contact their nearest authorized Mazda dealership. Mazda North American Operations reserves the right to alter the specifications and contents of this bulletin without obligation or advance notice. All rights reserved. No part of this bulletin may be reproduced in any form or by any means, electronic or mechanical---including photocopying and recording and the use of any kind of information storage and retrieval system ---without permission in writing.

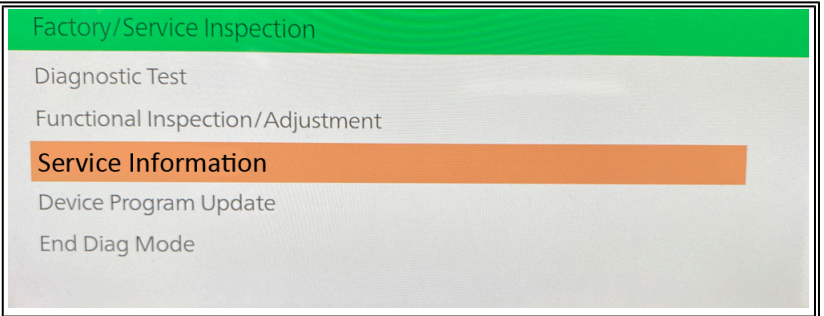
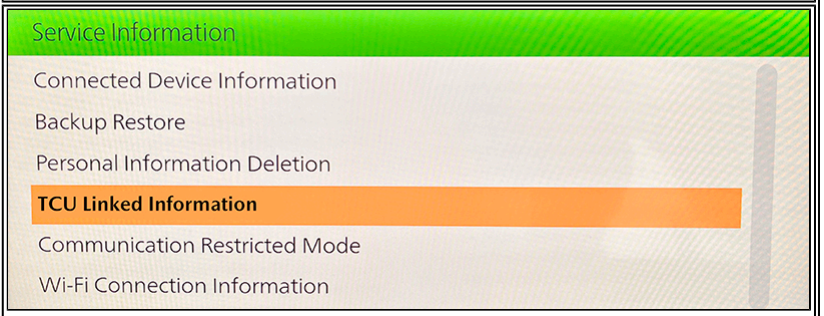
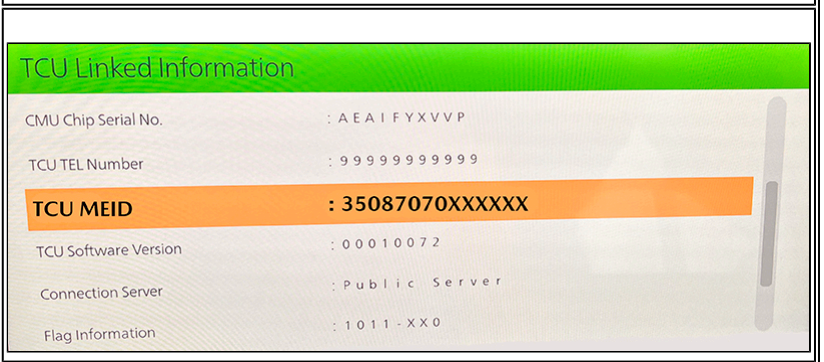
<p>2. Select Service Information.</p>	 <p>Factory/Service Inspection</p> <ul style="list-style-type: none"> <li>Diagnostic Test</li> <li>Functional Inspection/Adjustment</li> <li><b>Service Information</b></li> <li>Device Program Update</li> <li>End Diag Mode</li> </ul>
<p>3. Select TCU Linked information.</p>	 <p>Service Information</p> <ul style="list-style-type: none"> <li>Connected Device Information</li> <li>Backup Restore</li> <li>Personal Information Deletion</li> <li><b>TCU Linked Information</b></li> <li>Communication Restricted Mode</li> <li>Wi-Fi Connection Information</li> </ul>
<p>4. Document MEID Number</p>	 <p>TCU Linked Information</p> <ul style="list-style-type: none"> <li>CMU Chip Serial No. : A E A I F Y X V V P</li> <li>TCU TEL Number : 9 9 9 9 9 9 9 9 9 9 9</li> <li><b>TCU MEID : 35087070XXXXXX</b></li> <li>TCU Software Version : 0 0 0 1 0 0 7 2</li> <li>Connection Server : P u b l i c S e r v e r</li> <li>Flag Information : 1 0 1 1 - X X 0</li> </ul>

**TCU Remote Service Flag Information Check**

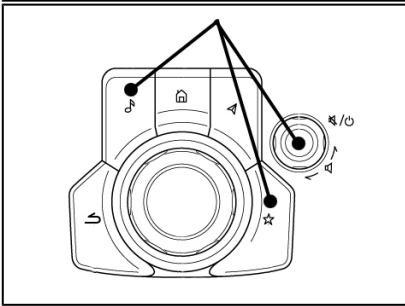
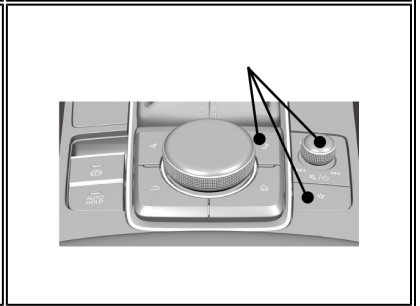
<p>1. Press and hold the Volume knob, then press and hold the Entertainment and Favorite buttons at the same time for 3-5 seconds and the Factory/Service Inspection screen will appear.</p>	<p><b>CX-5 and CX-9</b></p>	<p><b>Except CX-5 and CX-9</b></p>
		

**CONSUMER NOTICE:** The information and instructions in this bulletin are intended for use by skilled technicians. Mazda technicians utilize the proper tools/ equipment and take training to correctly and safely maintain Mazda vehicles. These instructions should not be performed by "do-it-yourselfers." Customers should not assume this bulletin applies to their vehicle or that their vehicle will develop the described concern. To determine if the information applies, customers should contact their nearest authorized Mazda dealership. Mazda North American Operations reserves the right to alter the specifications and contents of this bulletin without obligation or advance notice. All rights reserved. No part of this bulletin may be reproduced in any form or by any means, electronic or mechanical---including photocopying and recording and the use of any kind of information storage and retrieval system ---without permission in writing.

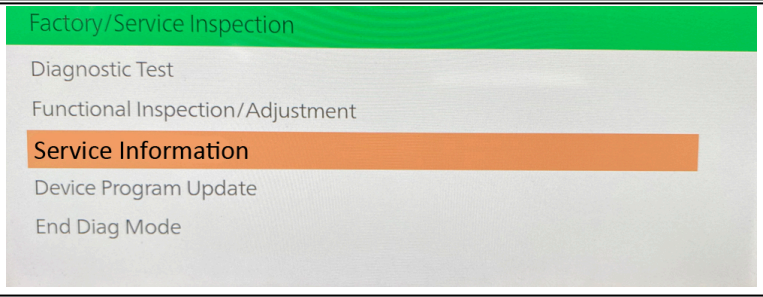
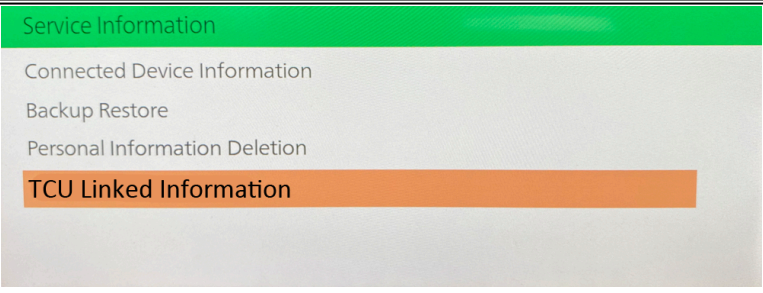
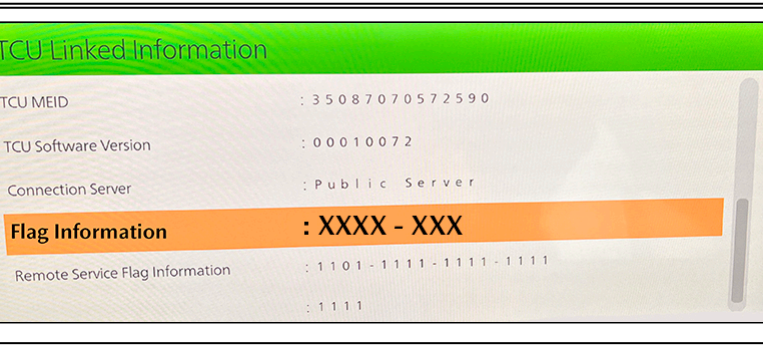
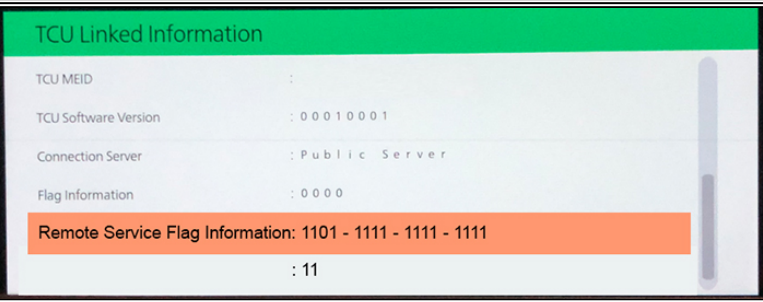
<p>2. Select Service Information.</p>	
<p>3. Select TCU Linked information.</p>	
<p>4. Scroll down to Flag Information.</p> <p><b>Is the Flag Information 1101 - XXX or 0000 - XXX?</b></p> <ul style="list-style-type: none"> <li>• <b>1101...</b> - Disconnect 12V battery for 1 hour, then retry connected vehicle enrollment.</li> <li>• <b>0000...</b> - Contact Hotline for technical support.</li> </ul>	
<p>5. Scroll down to Remote Service Flag Information.</p> <p><b>Is the Remote Service Flag Information 1101... or 0000...?</b></p> <ul style="list-style-type: none"> <li>• <b>1101...</b> - Disconnect 12V battery for 1 hour, then retry connected vehicle enrollment.</li> <li>• <b>0000...</b> - Contact Hotline for technical support.</li> </ul>	 <p style="text-align: center;">or</p>

**CONSUMER NOTICE:** The information and instructions in this bulletin are intended for use by skilled technicians. Mazda technicians utilize the proper tools/ equipment and take training to correctly and safely maintain Mazda vehicles. These instructions should not be performed by "do-it-yourselfers." Customers should not assume this bulletin applies to their vehicle or that their vehicle will develop the described concern. To determine if the information applies, customers should contact their nearest authorized Mazda dealership. Mazda North American Operations reserves the right to alter the specifications and contents of this bulletin without obligation or advance notice. All rights reserved. No part of this bulletin may be reproduced in any form or by any means, electronic or mechanical--including photocopying and recording and the use of any kind of information storage and retrieval system ---without permission in writing.

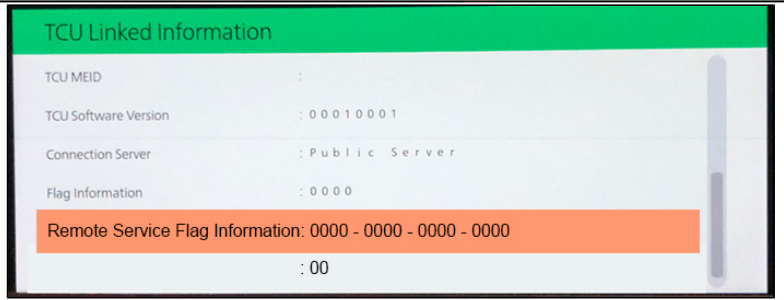

**Customer Opt-Out**

Some customers may request to stop data communication from their vehicle. Use this procedure to manually deactivate the TCU.

1. Check Connected vehicle reception strength icon

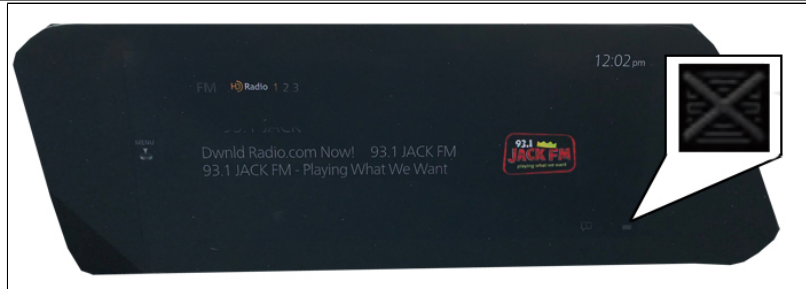

Infotainment Center displays "X"  
No action needed.

Inform the customer that TCU is already deactivated. Data communication is not being transmitted from the vehicle

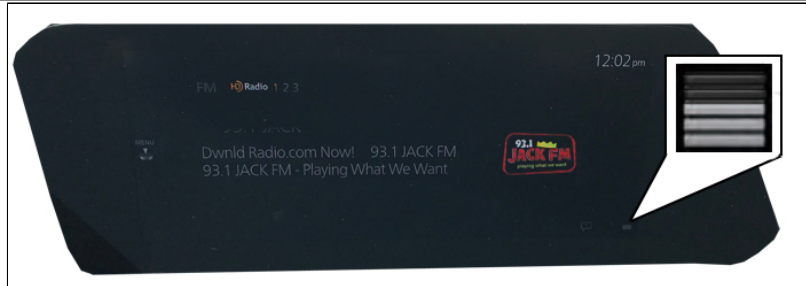

Infotainment Center displays normal reception.  
Go to next step

2. Is the customer currently enrolled into Connected Vehicle services?

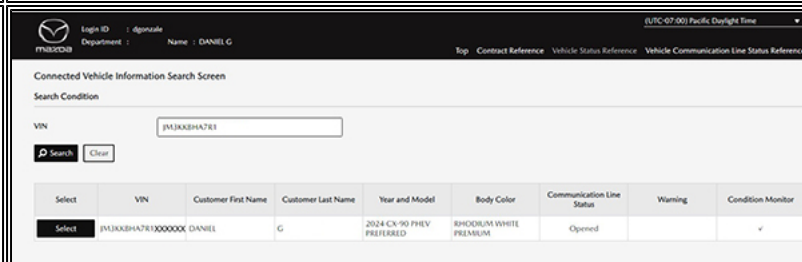

**Yes** - MCVV shows customer enrollment

**CONSUMER NOTICE:** The information and instructions in this bulletin are intended for use by skilled technicians. Mazda technicians utilize the proper tools/ equipment and take training to correctly and safely maintain Mazda vehicles. These instructions should not be performed by "do-it-yourselfers." Customers should not assume this bulletin applies to their vehicle or that their vehicle will develop the described concern. To determine if the information applies, customers should contact their nearest authorized Mazda dealership. Mazda North American Operations reserves the right to alter the specifications and contents of this bulletin without obligation or advance notice. All rights reserved. No part of this bulletin may be reproduced in any form or by any means, electronic or mechanical---including photocopying and recording and the use of any kind of information storage and retrieval system ---without permission in writing.

Go to step 4.

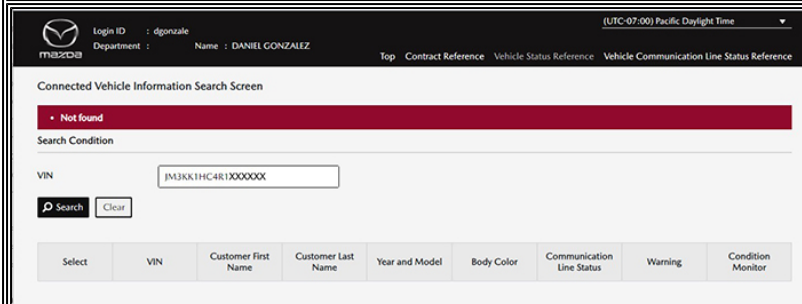

**No - MCVV** shows no customer enrollment  
Go to next step 3.

3. Enroll into Connected Vehicle services.  
**NOTE:** This step can be performed by dealer or customer.

Connected Vehicle Online Enrollment Information

1. [Installing the MyMazda APP](#)
2. [Registering Your User Information](#)
3. [Registering Vehicle Information](#)
4. [Registering Connected Service](#)

4. After enrollment, using the MyMazda App, delete VIN.

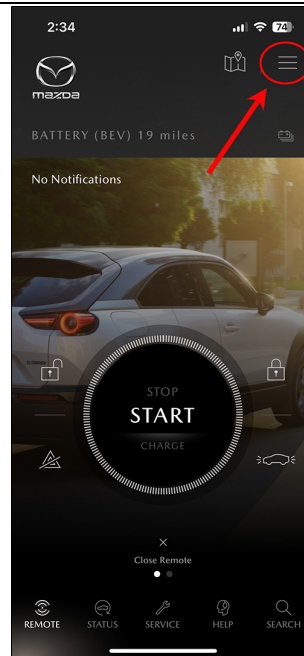

a. From the main screen, select menu.

**CONSUMER NOTICE:** The information and instructions in this bulletin are intended for use by skilled technicians. Mazda technicians utilize the proper tools/ equipment and take training to correctly and safely maintain Mazda vehicles. These instructions should not be performed by "do-it-yourselfers." Customers should not assume this bulletin applies to their vehicle or that their vehicle will develop the described concern. To determine if the information applies, customers should contact their nearest authorized Mazda dealership. Mazda North American Operations reserves the right to alter the specifications and contents of this bulletin without obligation or advance notice. All rights reserved. No part of this bulletin may be reproduced in any form or by any means, electronic or mechanical--including photocopying and recording and the use of any kind of information storage and retrieval system ---without permission in writing.

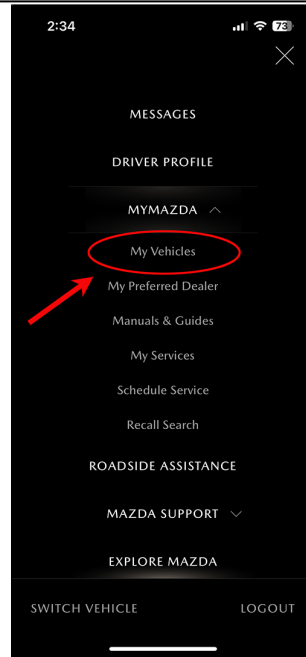

b. From the MYMAZDA drop down, select My Vehicles

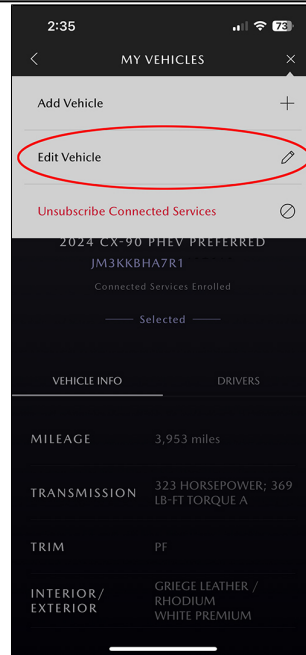

c. Select Edit Vehicle

**CONSUMER NOTICE:** The information and instructions in this bulletin are intended for use by skilled technicians. Mazda technicians utilize the proper tools/ equipment and take training to correctly and safely maintain Mazda vehicles. These instructions should not be performed by "do-it-yourselfers." Customers should not assume this bulletin applies to their vehicle or that their vehicle will develop the described concern. To determine if the information applies, customers should contact their nearest authorized Mazda dealership. Mazda North American Operations reserves the right to alter the specifications and contents of this bulletin without obligation or advance notice. All rights reserved. No part of this bulletin may be reproduced in any form or by any means, electronic or mechanical--including photocopying and recording and the use of any kind of information storage and retrieval system ---without permission in writing.

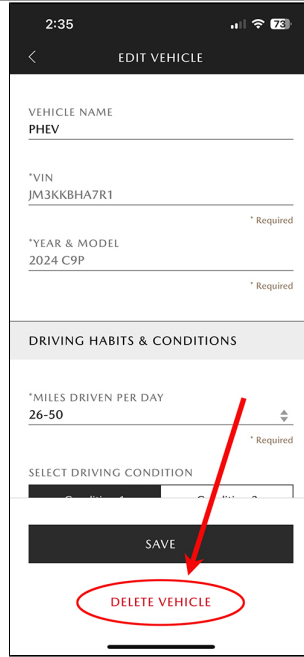

d. Select Delete Vehicle

5. Turn the ignition OFF and wait 5-10 minutes

6. Turn the ignition on and confirm that the connected vehicle reception strength icon shows "X"

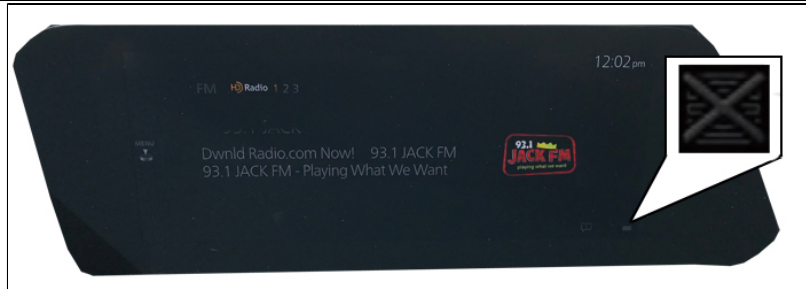

Inform the customer that TCU is deactivated. Data communication is not being transmitted from the vehicle

**Note:** The following functions have been disabled

- Connected Vehicle Services (Remote Functions, Find My Car....etc)
- In-car WiFi
- Recall Notifications
- Over the Air (OTA) software updates\*
- Alexa\*
- Hybrid Navigation\*

**CAUTION:**

- If the customer has a Paid Subscription plan, the customer must go to [owners.mymazda.com](http://owners.mymazda.com) and select **Manage Billing > Cancel plan**. The

**CONSUMER NOTICE:** The information and instructions in this bulletin are intended for use by skilled technicians. Mazda technicians utilize the proper tools/ equipment and take training to correctly and safely maintain Mazda vehicles. These instructions should not be performed by "do-it-yourselfers." Customers should not assume this bulletin applies to their vehicle or that their vehicle will develop the described concern. To determine if the information applies, customers should contact their nearest authorized Mazda dealership. Mazda North American Operations reserves the right to alter the specifications and contents of this bulletin without obligation or advance notice. All rights reserved. No part of this bulletin may be reproduced in any form or by any means, electronic or mechanical---including photocopying and recording and the use of any kind of information storage and retrieval system ---without permission in writing.

subscription will finish at the end of the current billing cycle, and you won't be charged again.

- If a customer has an active In-Car Wi-Fi contract, the customer must contact the carrier and cancel In-Car Wi-Fi service.

\*Some Models

**CONSUMER NOTICE:** The information and instructions in this bulletin are intended for use by skilled technicians. Mazda technicians utilize the proper tools/ equipment and take training to correctly and safely maintain Mazda vehicles. These instructions should not be performed by "do-it-yourselfers." Customers should not assume this bulletin applies to their vehicle or that their vehicle will develop the described concern. To determine if the information applies, customers should contact their nearest authorized Mazda dealership. Mazda North American Operations reserves the right to alter the specifications and contents of this bulletin without obligation or advance notice. All rights reserved. No part of this bulletin may be reproduced in any form or by any means, electronic or mechanical---including photocopying and recording and the use of any kind of information storage and retrieval system ---without permission in writing.

**Educational Videos**[Overview](#)[Using MyMazda App](#)[In-car Wi-Fi hotspot](#)[MyMazda remote](#)[Notifications](#)[Saftey features](#)**Resources**[Connected Vehicle Online Enrollment Information](#)

- [1. Installing the MyMazda APP](#)
- [2. Registering Your User Information](#)
- [3. Registering Vehicle Information](#)
- [4. Registering Connected Service](#)

[SA-017/25 - MAZDA CONNECTED SERVICES - FREQUENTLY ASKED QUESTIONS \(FAQ\)](#)[SA-009/25 - MYMAZDA APP CONNECTED VEHICLE ERROR CODE DESCRIPTION AND RECOVERY INFORMATION](#)[Dealer Connected Vehicle Questionnaire](#)[Connected Services Owner's Manual](#)[MAZDA CONNECT and MAZDA CONNECTED SERVICES USER GUIDE](#)[MAZDA CONNECTED VEHICLE VIEWER \(MCVV\) USER GUIDE](#)[MAZDA CONNECT ESSENTIALS \(30076WBT\)](#)[MAZDA CONNECT & CONNECTED SERVICES FOCAL POINT \(30093FOC\)](#)[MAZDA CONNECTED SERVICES SMART CARDS](#)[MAZDA CONNECTED SERVICES: CUSTOMER OUTREACH](#)

**CONSUMER NOTICE:** The information and instructions in this bulletin are intended for use by skilled technicians. Mazda technicians utilize the proper tools/ equipment and take training to correctly and safely maintain Mazda vehicles. These instructions should not be performed by "do-it-yourselfers." Customers should not assume this bulletin applies to their vehicle or that their vehicle will develop the described concern. To determine if the information applies, customers should contact their nearest authorized Mazda dealership. Mazda North American Operations reserves the right to alter the specifications and contents of this bulletin without obligation or advance notice. All rights reserved. No part of this bulletin may be reproduced in any form or by any means, electronic or mechanical---including photocopying and recording and the use of any kind of information storage and retrieval system ---without permission in writing.