

Trailer hitch (1D6)



Information

ONLY for additional parts to be ordered separately:

If necessary, check the additional scopes of the vehicle to be converted with the respective vehicle identification number (VIN) in the Porsche Electronic Parts Catalogue = PET before ordering.

Check model year, vehicle equipment (I-no.), body and country versions in the standard catalogue!



Information

Further information/technical values, instructions for using the trailer hitch and "Driving with a trailer" can be found in the:

- Vehicle Owner's Manual Cayenne, topics: "Trailer Hitch", "More Safety and More Driving Pleasure" and "Weights"
- Vehicle registration documents



Information

Please pass all this information on to the customer.

Also give the customer a copy of the first pages of these Installation and Conversion Instructions, including the legal regulations.

Change overview:

Revision	Date	Modification
0	08/11/2023	▪ Original publication
1	07/17/2025	▪ Update to Labor Operations

Model Year: **As of 2024**

Cause: **Retrofitting**

Notes: The new Cayenne can be retrofitted with a trailer hitch. Note the following special features:

- Permissible tongue weight (vehicle) for E-Hybrid vehicles with 8-cylinder engine: max. 120 kg/ 264 lbs
- Permissible tongue weight (vehicle) of max. 140 kg/ 308 lbs
- Totally versatile wading depth
- Convenient loading and safe parking is assured by removing the ball hitch/bar (mechanical trailer hitch – 1D6)
- Socket preparation for USA version

- Payload following installation, restricted by higher vehicle kerb weight!
- Permissible total weight and axle load must not be exceeded!
- Vehicles with painted wheel arch extensions (6GK) or CarbonDesign package (2D3) or SportDesign package (2D5) require **NEW** wheel arch extensions (rear), which must be ordered separately!
- Vehicles with CarbonDesign package (2D3 – Basis or PD1 / PD2 / PD3 – Coupé) require a **NEW** rear panel, which must be ordered separately!

The trailer hitches for the respective market are also available straight from the factory for new vehicles by requesting optional equipment "1D6" = mechanical trailer hitch .

Parts Info: **9Y0.044.840.08** ⇒ Trailer hitch, mechanical – USA (1D6)

ONLY for vehicles with SportDesign package Carbon (2D3 - Basic or PD1 / PD2 / PD3 - Coupé): Also order the following, depending on country/market:

9Y0.807.834.H.03G 1x ⇒ Rear panel – open, carbon gloss, black – 1D6

ONLY for vehicles with painted wheel arch extensions (6GK) or Carbon Design package (2D3) or SportDesign package (2D5), also order the following:

9Y3.854.731.C.G2X 1x ⇒ Coupé wheel cover, rear left; ready-primed – AUS (6GK)

9Y3.854.732.C.G2X 1x ⇒ Coupé wheel cover, rear right; ready-primed – AUS (6GK)

9Y0.854.731.D.G2X 1x ⇒ Wheel cover, rear left; ready-primed - AUS (6GK)

9Y0.854.732.D.G2X 1x ⇒ Wheel cover, rear right; ready-primed - AUS (6GK)

Parts List:

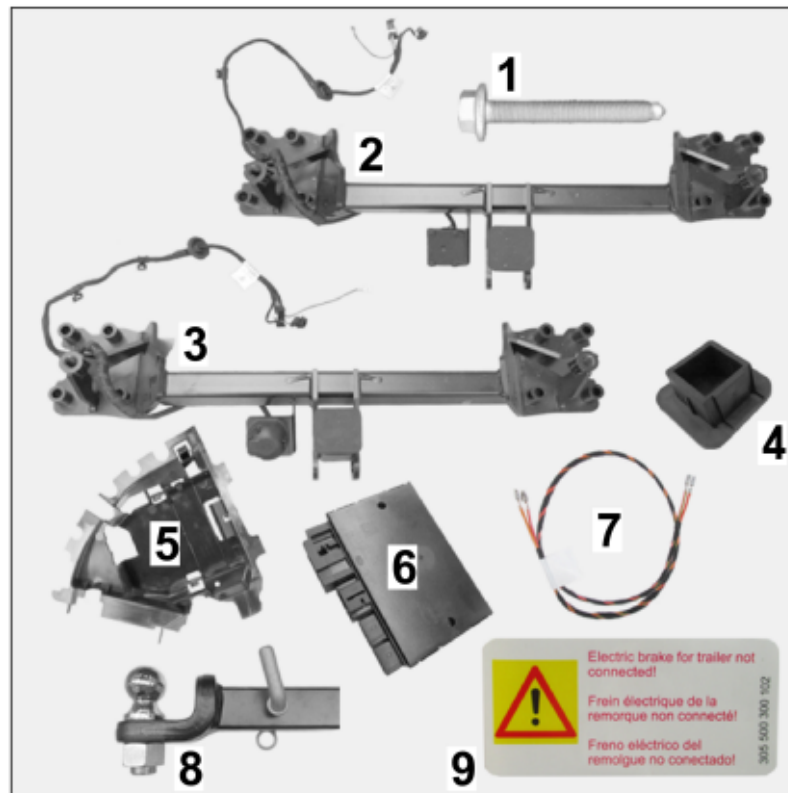

Figure 3

Parts included with trailer hitch – mechanical – USA/Canada (1D6 ⇒ Figure 3):

PAF.910.398.02	8 x	Hexagon-head bolt, M12 x 1.5 x 90 ⇒ Figure 3 -1-
9Y0.803.881.A ¹	1x	Trailer hitch incl. wire harness – USA/Canada (1D6) ⇒ Figure 3 -2-
955.722.030.00 ²	1x	Plug Trailer hitch ⇒ Figure 3 -4-
9Y0.907.297	1x	Trailer hitch control unit connector ⇒ Figure 3 -5-
PAB.907.383.C	1x	Trailer hitch control unit ⇒ Figure 3 -6-
— — —	1x	Wiring harness for power supply (terminal 30) ⇒ Figure 3 -7-
955.044.000.28	1x	Ball hitch –removable– USA/Canada ⇒ Figure 3 -8-
— — —	1x	“Electric Brake” sticker – identification ⇒ Figure 3 -9-
— — —	10 x	Tie-wrap, 150 mm (not shown)

1 **ONLY** contained in respective set.

2 Already installed on the trailer hitch.

Tools:

Nr.88 - Torque angle torque wrench
P90999 - P90999 - PIWIS Tester 4

Disassembly tool

Saw or vibrating knife
 Steel drill bit, Ø up to 8.0 mm
 Tap, M12 x 1.5
 Round/flat file
 Side cutters
 Drill
 Flat scraper
 Knife

Assembly:

1 Preliminary work

- 1.1 Connect the battery charger. ⇒ *Workshop Manual '2X00IN Battery trickle charge'*
- 1.2 Raise the vehicle. ⇒ *Workshop Manual '4X00IN Raising the vehicle'*
- 1.3 Remove bumper rear. ⇒ *Workshop Manual '635019 Removing and installing bumper rear'*
- 1.4 Expose connector B (6-pin)/connector C (10-pin) on trailer hitch preparation near the fuse box in the luggage compartment (⇒ *Figure 4*).

- 1 – Connector B (6-pin)/connector C (10-pin)
- 2 – Ground pin MB25
- 3 – Fuse box in luggage compartment, left

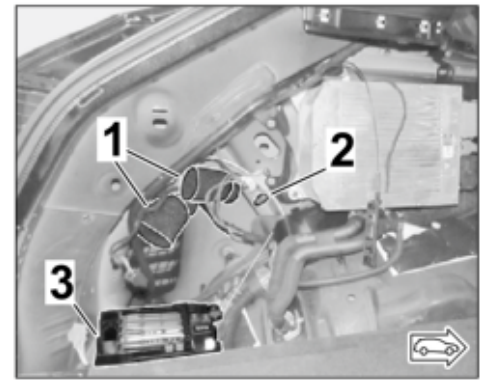

Figure 4

- 1.5 **ONLY** for Trailer hitch – mechanical - (1D6):
Expose connection point (connector, 2-pin) for brake booster preparation in the luggage compartment area at the left.
- 1.6 Check that the bolt threads and contact surfaces for securing the trailer hitch are not dirty. Clean them and re-cut the threads using an M12 x 1.5 tap if necessary.
- 1.7 **ONLY** for vehicles **WITH** Carbon Design package (2D3 or PD1 / PD2 / PD3):
Replace the rear panel – closed (shiny carbon, black) with the new rear panel – open (shiny carbon, black). ⇒ *Workshop Manual '63561940 Removing and installing rear panel (trim strip)'*
- 1.8 **ONLY** for vehicles **WITHOUT** Carbon Design package (2D3 or PD1 / PD2):
Make a cut-out for the (removable/pivoting) ball hitch in the rear apron
 - 1.8.1 Remove the rear panel (moulding) in black matt (2JB) or stainless steel (2JX) on the bottom of the rear apron. ⇒ *Workshop Manual '63561940 Removing and installing rear panel (trim strip)'*

1.8.2 Mark the cut-out for the ball hitch (removable – USA) at the impression on the inside of the rear apron (⇒ *Figure 5 -A-*).

- 1 – Yellow = Marking for cut-out for removable ball hitch (1D6)
- 2 – White = Marking for cut-out for electrically extendable ball hitch (1D3) – Not applicable for NAR
- 3 – “Virtual pedal” antenna lines



Information

Mask the sawing area to prevent damage.

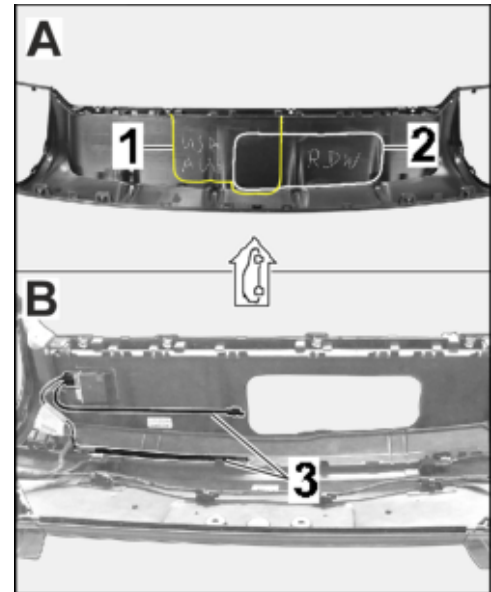

Figure 5

1.8.3 Carefully make the cut-out along the marking (example for 1D3: ⇒ *Figure 5 -B-*, 1D6 accordingly).

1.8.4 De-burr cut edges with a knife or file.

1.8.5 Install the rear panel (moulding) in black matt (2JB) or stainless steel (2JX) on the bottom of the rear apron. ⇒ *Workshop Manual '6356 1940 Removing and installing rear panel (trim strip)*

2 Installing the trailer hitch

2.1 Secure trailer hitch to the vehicle

2.1.1 Install the trailer hitch using 8 new bolts (M12 x 1.5 x 90) at the left and right and tighten hand-tight. ⇒ *Figure 6*

- 1 – Trailer hitch (electric)
- 2 – Screw M12 x 1.5 x 90

2.1.2 Align bolt guides for the trailer hitch (8 x) symmetrically with respect to the 8 bolt heads M12 x 1.5 x 90. ⇒ *Figure 6 -Magnifier-*

2.1.3 Tighten trailer hitch fully.
Tightening torque 110 Nm (81.1 ftlb.)

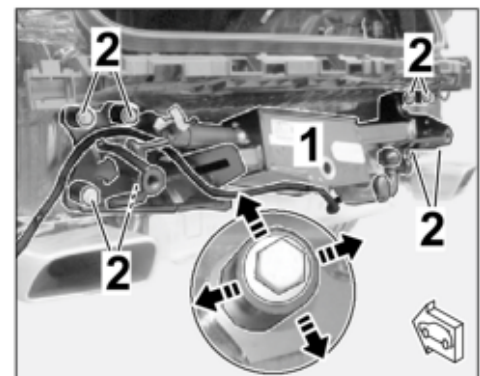

Figure 6

NOTICE**Incorrect line routing**

- **Risk of damage to lines and hoses**
 - **Malfunction and fault memory entry on control unit**
- ⇒ **Avoid small bending radii when routing lines.**
- ⇒ **File down edges and burrs in the routing area or mask them with adhesive tape.**
- ⇒ **Maintain a sufficient distance from components exposed to high temperatures while driving.**

2.2 Route the electric wiring harness for the trailer hitch in the passenger compartment. See also:
⇒ *Workshop Manual '972419 Removing and installing wire harness for trailer hitch'*

2.2.1 Remove dummy plug (Ø 40 mm) from side panel on the vehicle at the left and guide wire harness for trailer hitch into the luggage compartment.

- 1 – Wire harness for trailer hitch
- 2 – Rubber sleeve (wire harness)
- 3 – Cable tie

2.2.2 Insert rubber sleeve (wire harness) into the bore (Ø 40 mm) on the body.

2.2.3 Install tie-wraps for wire harness (2 x) on threaded bolts on the outside of the vehicle. ⇒ *Figure 7*

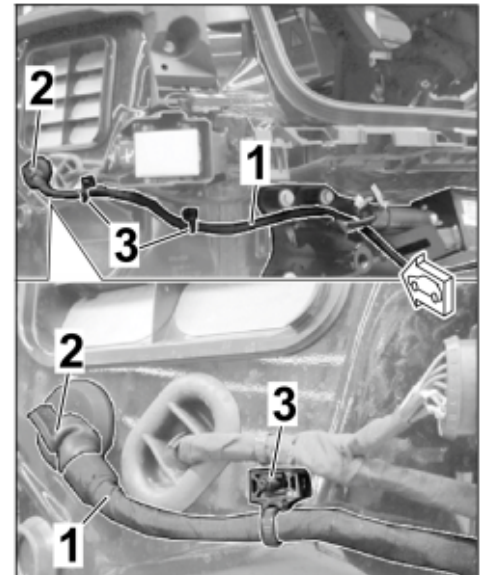

Figure 7

2.3 Check pin assignment in connector B on the vehicle side (6-pin; trailer hitch preparation).
⇒ *Figure 8*

- 1 – Connector B (6-pin; trailer hitch preparation)
- 2 – Connector B, chamber 1
- 3 – Connector B, chamber 6
- 4 – Fuse holder H (strip B – white)

Are chambers 1 (swivel motor) and 6 (charge line) - both on terminal 30 - used?

- Yes: ⇒ Continue with Step 2.4
- No: Carry out the following work.

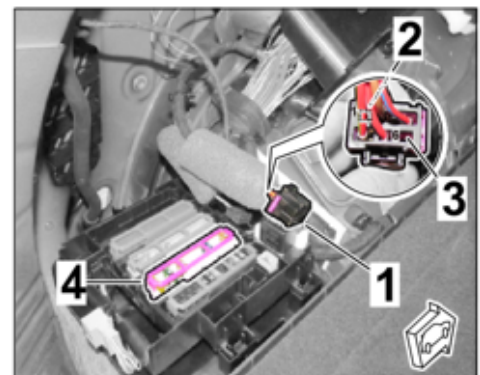

Figure 8

2.3.1 Remove fuse holder H (strip B – white) from the fuse box in the luggage compartment. ⇒ *Figure 9 -top-*, ⇒ *Workshop Manual '978409 Loosening and securing fuse box in the luggage compartment'*

- 1 – Fuse holder H (strip B – white)
- 2 – Cover on underside
- 3 – Latch on fuse holder
- 4 – RD/GN line 2,5²

2.3.2 Release fuse holder H (strip B – white) and connect the lines (RD/GN and RD/YE) as follows (⇒ *Figure 9 -Bottom-*):

- Chamber 6: RD/GN line 2.5² ⇒ Preparation for connector B, chamber 1 (swivel motor)
- Chamber 7: RD/YE line 2.5² ⇒ Preparation for connector B, chamber 6 (charge line)

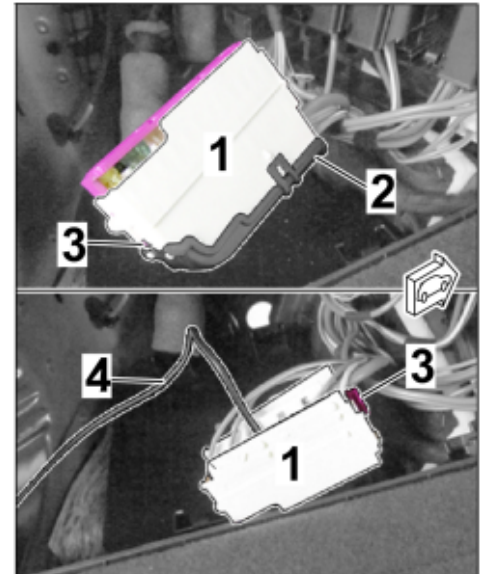

Figure 9

2.3.3 Lock connector housing strip B (color: white) and install it into the fuse holder.

2.3.4 Install fuse holder H (strip B – white) in the fuse box in the luggage compartment. ⇒ *Workshop Manual '978409 Loosening and securing fuse box in the luggage compartment'*

2.3.5 Route RD/GN and RD/YE lines to connector B (preparation). ⇒ *Figure 10*

- 1 – RD/GN and RD/YE lines
- 2 – Connector B (preparation)
- 3 – Fuse box in luggage compartment

Release connector B, connect lines RD/GN and RD/YE as described in Step 2.3.2. ⇒ *Figure 10 -Magnifier-*

Lock connector B.

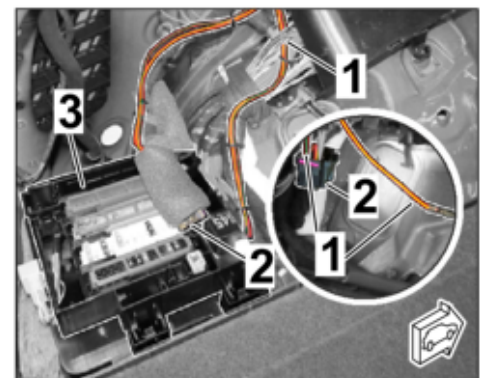

Figure 10

2.4 Install trailer hitch control unit in the luggage compartment area (left side panel). ⇒ *Figure 11*

- 1 – Trailer hitch control unit bracket
- 2 – Connector A - Wire harness for trailer hitch
- 3 – Ground line 2.5² – BN
- 4 – Ground pin MB25

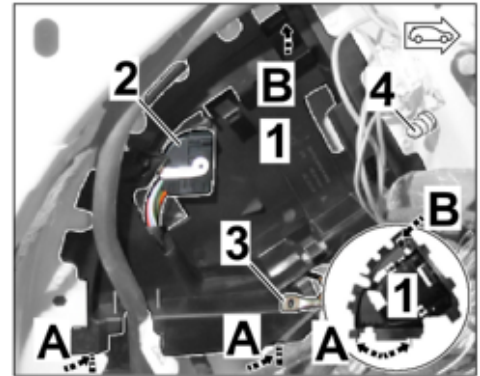

Figure 11

2.4.1 Disconnect any lines and hoses in the installation area.

2.4.2 Insert pins (2 x on underside of control unit bracket) into the body. ⇒ *Figure 11 -A-*

2.4.3 Clip trailer hitch control unit bracket at the top into the web plate on the body. ⇒ *Figure 11 -B-*

2.4.4 Guide connector A (wire harness for trailer hitch) and connector B/C (trailer hitch preparation) into the control unit bracket.

2.4.5 Install the trailer hitch control unit in the bracket (⇒ *Figure 12*).

- 1 – Trailer hitch control unit
- 2 – Holder

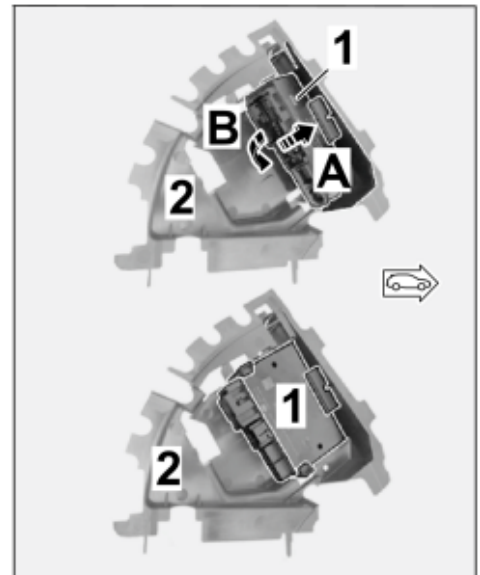

Figure 12

2.5 Install cable ring eyelet A6 at the ground pin MB25. ⇒ *Figure 13 -2-*

- 1 – Ground line BN 2,5²
- 2 – Ground pin MB25
- 3 – Connector A (Wire harness for trailer hitch)
- 4 – Connector B (preparation)
- 5 – Connector C (preparation)
- 6 – Trailer hitch control unit

Tightening torque 9 Nm (6.6 ftlb.)

2.6 Connect plug connections for connector A / B / C to the trailer hitch control unit (⇒ *Figure 13*).

2.7 **ONLY** for Trailer hitch – mechanical (1D6):

2.7.1 Connect plug connection (2-pin ⇒ *Figure 14*) for brake booster preparation in the luggage compartment area at the left.

- 1 – Connector (2-pin) – brake booster preparation
- 2 – Connector A
- 3 – Ground line BN 2,5²

Install connection point at a suitable location using a scraper clip.

2.7.2 Affix sticker showing the warning “Electric Brake for Trailer not connected” on a clean surface at a clearly visible position next to the “Ball Position” sticker or the dashboard (⇒ *Figure 15*).

- 1 – “Electric Brake for Trailer not connected” warning sticker
- 2 – “Ball Position” sticker

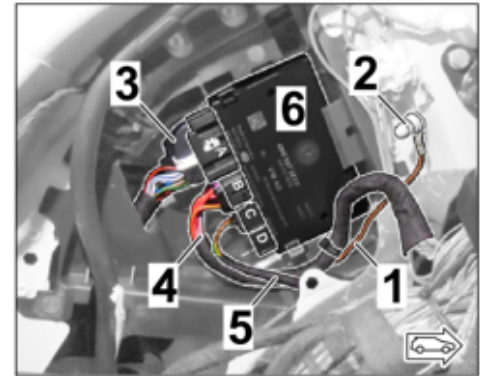

Figure 13

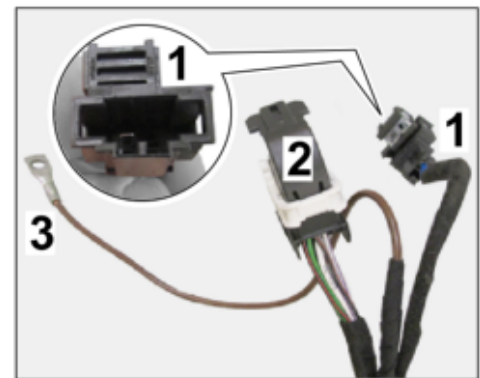

Figure 14

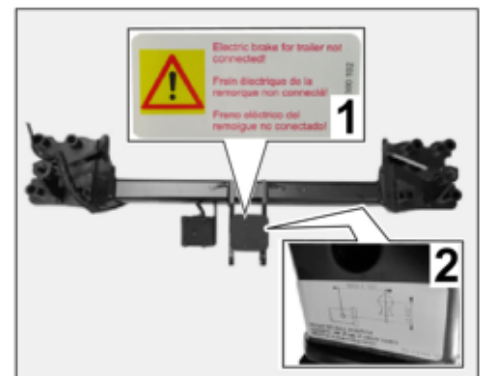

Figure 15

2.8 Check fuse assignment in fuse holder H (strip B – white ⇒ *Figure 16*) and insert missing fuses if necessary:

- Fuse slot 5 = 25 A – trailer hitch (control unit, right lighting)
- Fuse slot 6 = 30 A – trailer hitch (pivot motor)
- Fuse slot 7 = 20 A – trailer hitch (attaching trailer & electric release)
- Fuse slot 9 = 20 A – trailer hitch (plug socket)

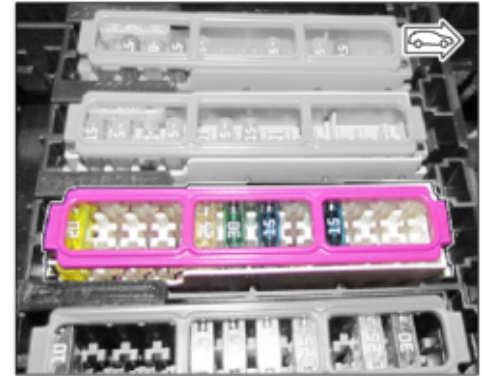

Figure 16

3 Follow-up actions

- 3.1 Install side trim panel for luggage compartment. ⇒ *Workshop Manual '700319 Removing and installing boot side trim panel rear'*
- 3.2 Install the rear bumper. ⇒ *Workshop Manual '635519 Remove and install rear bumper'*
- 3.3 Lower the vehicle. ⇒ *Workshop Manual '4X00IN Raising the vehicle'*

Coding:

4 Coding/programming trailer hitch (1D6 or 1D3 / 1D9)

4.1 Preliminary work – Coding

NOTICE

Voltage drop

- **Risk of irreparable damage to control unit**
 - **Risk of damage to control unit**
 - **Fault entries in the control unit**
 - **Coding in the control unit is aborted**
 - **Malfunctions in control unit, even during programming**
- ⇒ **Prior to disconnecting the control unit, switch off ignition and remove ignition key.**
- ⇒ **Ensure that the power supply is not interrupted during programming.**
- ⇒ **Connect a battery charger with a current rating of at least 90 A to the vehicle battery.**

NOTICE

Control unit programming will be aborted if the WLAN connection is unstable.

- **An unstable WiFi connection can interrupt communication between the PIWIS Tester and the vehicle communication module (VCI). As a result, control unit programming may be aborted.**

⇒ **During control unit programming, always connect the PIWIS Tester to the vehicle communication module (VCI) via the USB cable.**

4.1.1 Connect **P90999 - P90999 - PIWIS Tester 4** to the vehicle and switch it on.

4.1.2 Switch on ignition **AND** hazard warning lights on the vehicle.



Information

The **PIWIS Tester** instructions take precedence since the description may be different with later Tester releases.

The procedure described here has been structured in general terms. Different text or additional information may appear on the **PIWIS Tester**.

4.1.3 Select the "Diagnostics" menu item on the PIWIS Tester.

4.1.4 If **P90999 - P90999 - PIWIS Tester 4** is connected correctly, a connection to the vehicle will be established: "Cayenne" model line is detected.

4.1.5 Press **F12** to go to the control unit search screen.

4.1.6 Question: "Should an FAP be created?" If "Yes", press **F12** to confirm.



Information

The function is **ONLY** available when the Tester is online!

4.2 Enter the new vehicle equipment in the vehicle data using "PIWIS Online"

4.2.1 Press **F7** in the control unit overview to switch to the "Additional menu".

4.2.2 Select the "Maintain vehicle data with PIWIS-ONLINE" function.

A message appears informing you that the "Actual" (vehicle) data and "Required" (PIWIS Online) data will be compared.

Press **F12** to continue.

4.2.3 Confirm the message "The vehicle data was compared with PIWIS Online. Significant differences were found" with **F12**.

4.2.4 Look for the option "HITCH DEVICE" in the "Family" column.

Select the available option from the drop-down menu in the "Value" column, depending on the option installed:

- 1D6 – TRAILER HITCH W/O BALL JOINT (USA)

Press **F12** to continue.

4.2.5 A table containing the coding value and the columns "new value" and "old value" is displayed in the overview. Press **F8** to continue.

- 4.2.6 Data is then written/stored. The following messages appear one after the other:
- Transferring vehicle data to PIWIS Online.
 - Writing and transferring vehicle data to the vehicle.
 - Vehicle order was written successfully.
 - A check was performed in order to check whether control units have to be coded or programmed as a result of the changes that were made.
- 4.3 Code/program the new vehicle equipment.
- 4.3.1 Confirm the table containing a list of control units that must be coded/programmed, by pressing **F12** .
- 4.3.2 Individual data records will be loaded, depending on the number of control units to be coded/programmed.
- Wait until messages "Creating backup documentation." Please wait ... and "Coding was completed successfully". Press **F12** to continue.
- Repeat the process for other control units if necessary.
- 4.3.3 Wait for the "Adaptation of the control units is complete." message and check the coding status of the control units in the displayed table.
- Continue by pressing **F12** to return to the control unit overview.
- 4.4 **Only** for vehicles with Lane Change Assist (6I2 / 6I5 / 6I6 / 7Y1):
Calibrate Lane Change Assist control unit. ⇒ *Workshop Manual '917025 Calibrating Lane Change Assist'*
- 4.5 Read out the fault memory of all systems, work through any existing faults and erase the fault memory. ⇒ *Workshop Manual '0335IN Diagnostic maintenance: diagnostic system and maintenance inter...'*
- 4.6 Create another vehicle analysis log (VAL) in the "Overview" menu item.
- 4.7 Switch off ignition and disconnect **P90999 - P90999 - PIWIS Tester 4**.
- 4.8 Drive the vehicle off the lifting platform.

66 90 23 00: –Retrofitted - mechanical - trailer hitch– Labor time: **294 TU**
Includes: Removing and installing side trim panel for rear luggage compartment;
Removing rear bumper and installing trailer hitch;
Make a cut-out for the removable ball hitch in the rear apron;
Code/program the new vehicle equipment(s).

ONLY for vehicles with Lane Change Assist / Lane Keep Assist (6I2 / 6I5 / 6I6 / 7Y1):

91 70 25 53: Program Lane Change Assist control unit; Labor time: **47 TU**
Includes: Measure calibration plate on the vehicle.

ONLY for vehicles with painted wheel arch extensions (6GK) or Carbon Design package (2D3) or SportDesign package (2D5):

51 01 71 05: Body paint finish prepared Labor time: **130 TU**
Includes: Order-related
Painting of new parts, step 1
Plastic part

66 45 61 51: Rear wheel cover (1x) Painting new part Labor time: **40 TU**

66 45 61 51: Rear wheel cover (1x) Painting new part Labor time: **40 TU**

Important Notice: Technical Bulletins issued by Porsche Cars North America, Inc. are intended only for use by professional automotive technicians who have attended Porsche service training courses. They are written to inform those technicians of conditions that may occur on some Porsche vehicles, or to provide information that could assist in the proper servicing of a vehicle. Porsche special tools may be necessary in order to perform certain operations identified in these bulletins. Use of tools and procedures other than those Porsche recommends in these bulletins may be detrimental to the safe operation of your vehicle, and may endanger the people working on it. Properly trained Porsche technicians have the equipment, tools, safety instructions, and know-how to do the job properly and safely. Part numbers listed in these bulletins are for reference only. The work procedures updated electronically in the Porsche PIWIS diagnostic and testing device take precedence and, in the event of a discrepancy, the work procedures in the PIWIS Tester are the ones that must be followed.

© 2025 Porsche Cars North America, Inc.