

**ATTENTION:**

- GENERAL MANAGER
- PARTS MANAGER
- CLAIMS PERSONNEL
- SERVICE MANAGER

IMPORTANT - All Service Personnel Should Read and Initial in the boxes provided, right.

© 2025 Subaru of America, Inc. All rights reserved.



QUALITY DRIVEN® SERVICE

## PRODUCT CAMPAIGN BULLETIN

**APPLICABILITY:** 2020-2022 MY Legacy  
2020-2022 MY Outback

**NUMBER:** WRA-24R

**DATE:** 02/03/25

**SUBJECT:** Safety Recall – ODS Sensor Replacement

**REVISED:** 06/23/25

Subaru of America, Inc. (Subaru) has initiated a safety recall for certain 2020-2022 model year Legacy and Outback vehicles to replace all (four) of the Occupant Detection System (ODS) sensors on the front passenger seat.

### *Description of the Defect and Safety Risk*

The affected vehicles may be equipped with defective ODS sensors on the front passenger seat, which over time may result in a short circuit. If the short circuit occurs, the SRS airbag system warning lamp will illuminate, the front passenger's frontal airbag OFF indicator will illuminate, and the front passenger airbag may not deploy in certain crashes as designed, increasing the risk of injury to an occupant in the seat.

### *Remedy*

Subaru retailers will replace all (four) of the ODS sensors on the front passenger seat with new ones at no cost to the customer

### *Affected Vehicles*

A total of 118,723 U.S. vehicles are affected by this recall, as listed below. Not all vehicles in the production range listed below are affected by this recall. Coverage must be confirmed by using the Vehicle Coverage Inquiry function on subarunet.com prior to repair.

Model Year	Carline	Production Date Range	Vehicle Count
2020-2022	Outback	June 16, 2020 – July 13, 2021	103,114
2020-2022	Legacy	June 16, 2020 – July 12, 2021	15,609

As Subaru obtains the remedy parts supply for this repair, the WRA-24 recall coverage for the affected VINs not yet included in the phased final owner notifications will remain in an 'Open-Remedy not yet available' status in the system.

As phased final owner notification letters are released, the status of the VINs included in each mailing will be updated to 'Open' in the system to allow for repairs to be performed on those vehicles. This status change will trigger system 'push' notifications, such as in-vehicle notifications, MySubaru alerts, and CareConnect messaging.

**CAUTION: VEHICLE SERVICING PERFORMED BY UNTRAINED PERSONS COULD RESULT IN SERIOUS INJURY TO THOSE PERSONS OR TO OTHERS.**

Subaru Service Bulletins are intended for use by professional technicians ONLY. They are written to inform those technicians of conditions that may occur in some vehicles, or to provide information that could assist in the proper servicing of the vehicle. Properly trained technicians have the equipment, tools, safety instructions, and know-how to do the job correctly and safely. If a condition is described, DO NOT assume that this Service Bulletin applies to your vehicle, or that your vehicle will have that condition.

**Subaru of America, Inc. is ISO 14001 Compliant**

ISO 14001 is the international standard for excellence in Environmental Management Systems. Please recycle or dispose of automotive products in a manner that is friendly to our environment and in accordance with all local, state and federal laws and regulations.

*Continued...*

## ***Retailer Responsibility***

***Please be advised that it is a violation of Federal law for a dealer to deliver a new motor vehicle covered by a recall under a sale or lease until the defect is remedied. Therefore, any Authorized Subaru Retailer failing to perform the applicable service procedures to correct all affected vehicles in their inventory prior to the vehicle being placed in service may be subject to civil penalties of up to \$27,168 per violation (i.e., for each vehicle), as provided in 49 CFR §578.6 and will also be in breach of the Subaru Dealer Agreement.***

Any vehicles listed in any recall/campaign that are in retailer stock must be:

- Immediately identified
- Tagged or otherwise marked to prevent their delivery or use prior to repair
- Repaired in accordance with the repair procedures outlined in the Product Campaign Bulletin once the parts become available.

## ***Phased Final Owner Notification***

Subaru previously notified all affected vehicle owners of this recall with an interim letter on May 17, 2024 advising owners they would be re-notified with a follow up letter to schedule an appointment once parts are available.

As the parts supply arrives to support this recall, we will begin renotifying affected vehicle owners in phases to schedule an appointment to complete this repair. The first phased mailing will be released today, February 3, 2025, to the owners of all affected Legacy model vehicles.

Listed below is the current phased final owner notification plan. Subaru retailers will be advised as each phased mailing is scheduled.

<b>Mailing Date</b>	<b>Mailing Group</b>	<b>Current VIN status</b>
February 3, 2025	All Legacy models	Open
<b>May 19, 2025</b>	<b>2020 MY Outback (manual passenger seat)</b>	<b>Open</b>
Q3 2025 (estimate)	2020 MY Outback (power passenger seat)	Open-Remedy not yet available
Q1 2026 (estimate)	2021-2022 MY Outback (manual passenger seat)	Open-Remedy not yet available
Q3 2026 (estimate)	2021-2022 MY Outback (power passenger seat)	Open-Remedy not yet available
Q4 2026 (estimate)	2021-2022 MY Outback (power passenger seat)	Open-Remedy not yet available









## ***VIN status***

As phased final owner notification letters are released, the status of the VINs included in the mailing will be updated to ‘Open’ in the system. This status change will trigger system ‘push’ notifications, such as in-vehicle notifications, MySubaru alerts, and CareConnect messaging.

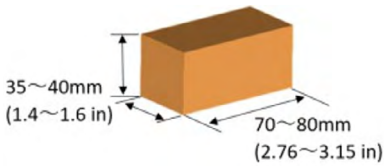
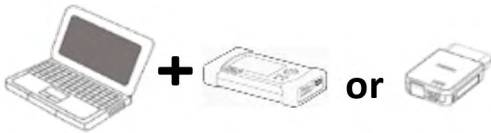
The WRA-24 recall coverage for the affected VINs not yet included in a phased final owner notification mailing will remain in an ‘Open-Remedy not yet available’ status until the final owner notification letters are mailed for those VINs.

***Continued...***

## REQUIRED TOOLS:

Part Description	Part Number	Qty	Image	Details
WRA-24	99804AN080	1		Will be forced ship to retailers at no cost.
WRA-24 Socket Tool	99804AN090	1		Will be forced ship to retailers at no cost.
WRA-24 JIG Tool	99804AN100	4		For Power Seat ONLY. Will be forced ship to retailers at no cost.
Block (Wood or Rubber)	N/A	2	 35~40mm (1.4~1.6 in) 70~80mm (2.76~3.15 in)	<ul style="list-style-type: none"> <li>Power Seat: use 2pcs</li> <li>Manual Seat: use 1pcs</li> <li>Retailers are to supply and cut to the dimensions shown on the left.</li> </ul>
Part Description	Image		Details	
SSM4 Equipped Laptop DST-i or DST-010			Required for DTC check & Rezeroing/Calibration	
DCA-8000 SUB Battery Diagnostic Charger			Required for battery charging	
General Hand Tools			Required for ODS sensor R&R	
Wobble Extension Bar example: Snap-on FXWK8			For Manual Seat <b>ONLY</b> .	
Weight Tool, Passenger <b>J-47673</b>			J-47673 is an Essential Tool	
String			<ul style="list-style-type: none"> <li>Thickness: 2mm-3mm</li> <li>Lenth: 40 meters (0.00in)</li> </ul>	
Ruler			Basic 12 inch	

*Continued...*

**PART CONFIGURATION:**

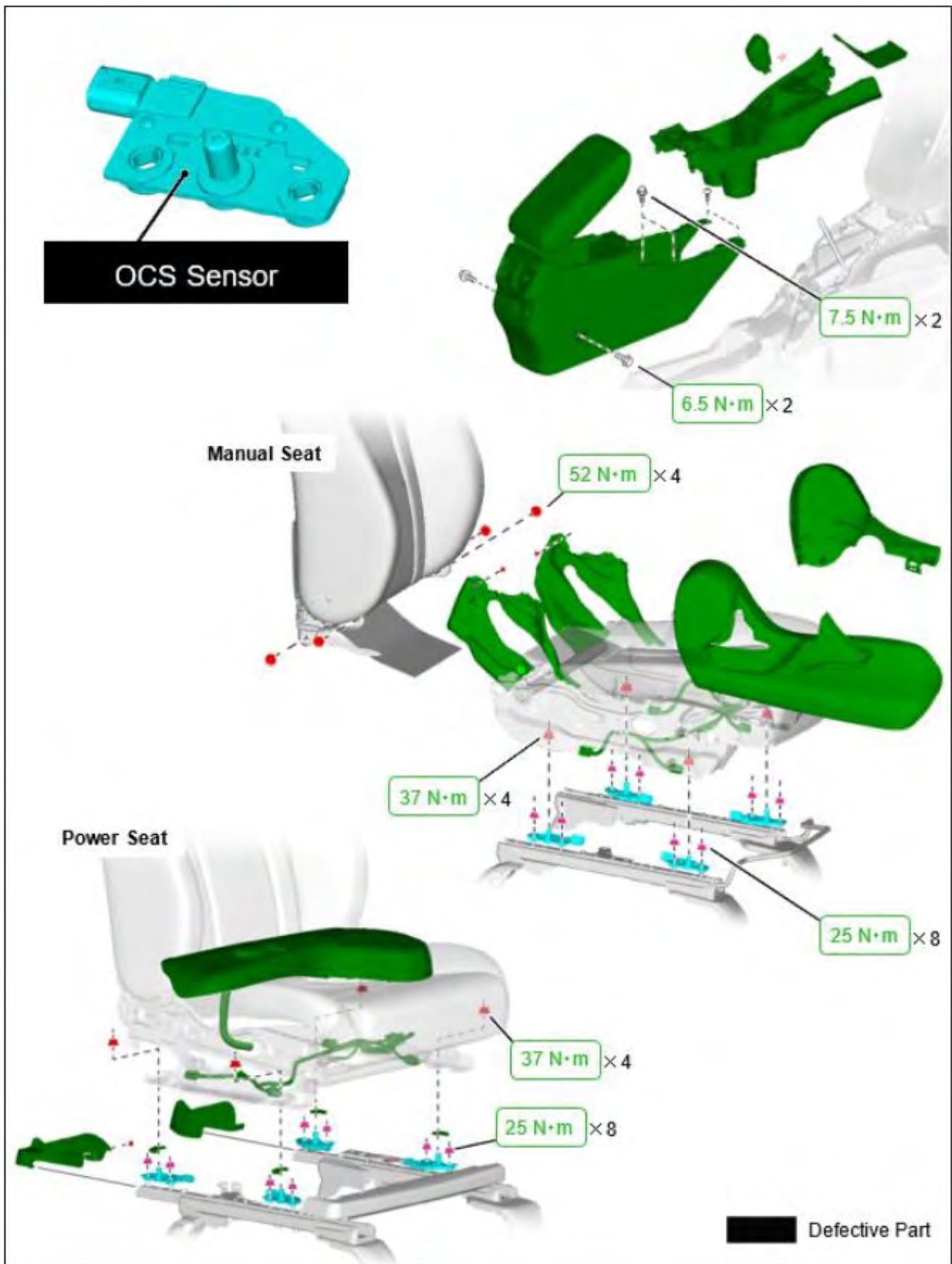





*Continued...*

**PART INFORMATION:**

There are two hardware kits created for this campaign. One kit for manual seats and another kit for power seats. The ODS sensors are ordered separately. All parts **MUST** be ordered through **PRIME**.

Please be mindful that the PIC team cannot increase **PRIME** limits or create supplemental orders for kits or tools.

Manual Seat Parts Kit SOA635182		
Part Description	Quantity	Image
RAIL NUT M10	4	
RAIL NUT M8	8	
HINGE BOLT	4	

Power Seat Parts Kit SOA635183		
Part Description	Quantity	Image
RAIL NUT M10	4	
RAIL NUT M8	8	

ODS Sensor Parts Kit 98329AN00A		
Part Description	Quantity	Image
ODS SENSOR REPAIR (4 per repair)	1	

**SERVICE PROCEDURE INFORMATION:**

There are two different Service Procedures for each seat configuration. Use the table below to confirm the next course of action.

Seat Configuration	Service Procedure Page Number
Manual Seat	Page 6
Power Seat	Page 29

*Continued...*

## MANUAL SEAT SERVICE PROCEDURE

Warning: The lower seat frame (Power or manual) must remain installed in the vehicle as instructed to keep various components properly aligned. Disassembling and reassembling the lower seat frame outside the vehicle will cause various misalignment concerns. If this occurs, replacement of the lower seat frame will be required.

### USE CAUTION WHEN HANDLING THE OCS SENSORS:

- **DO NOT** use any sensor if dropped or experienced any type of impact.
- **DO NOT** allow water, oil, etc. to adhere to the sensors.
- **DO NOT** touch the portions of the sensor outlined in **RED** below.

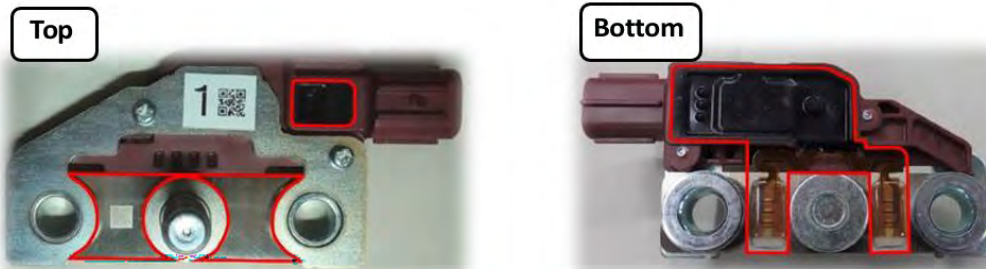

### EXAMPLES OF PROPER SENSOR HANDLING:



**STEP 1:** Using a DCA-8000, input the battery information and set the charger to Power Supply Mode.

**STEP 2:** Apply the parking brake. This is required because the gear selector will be placed in the Neutral (N) position in a future step.

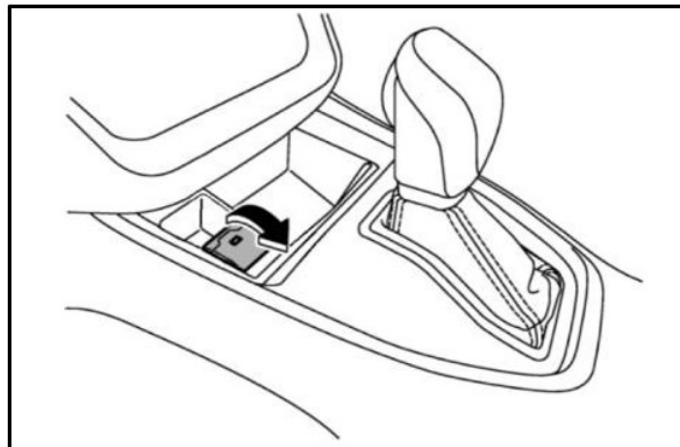

*Continued...*

**STEP 3:** Confirm at least one minute has surpassed since the ignition was switched off. Remove the cover from the main fuse box. Using a small flat blade screwdriver, remove Fuse # 30, SBF-3, SBF-12.

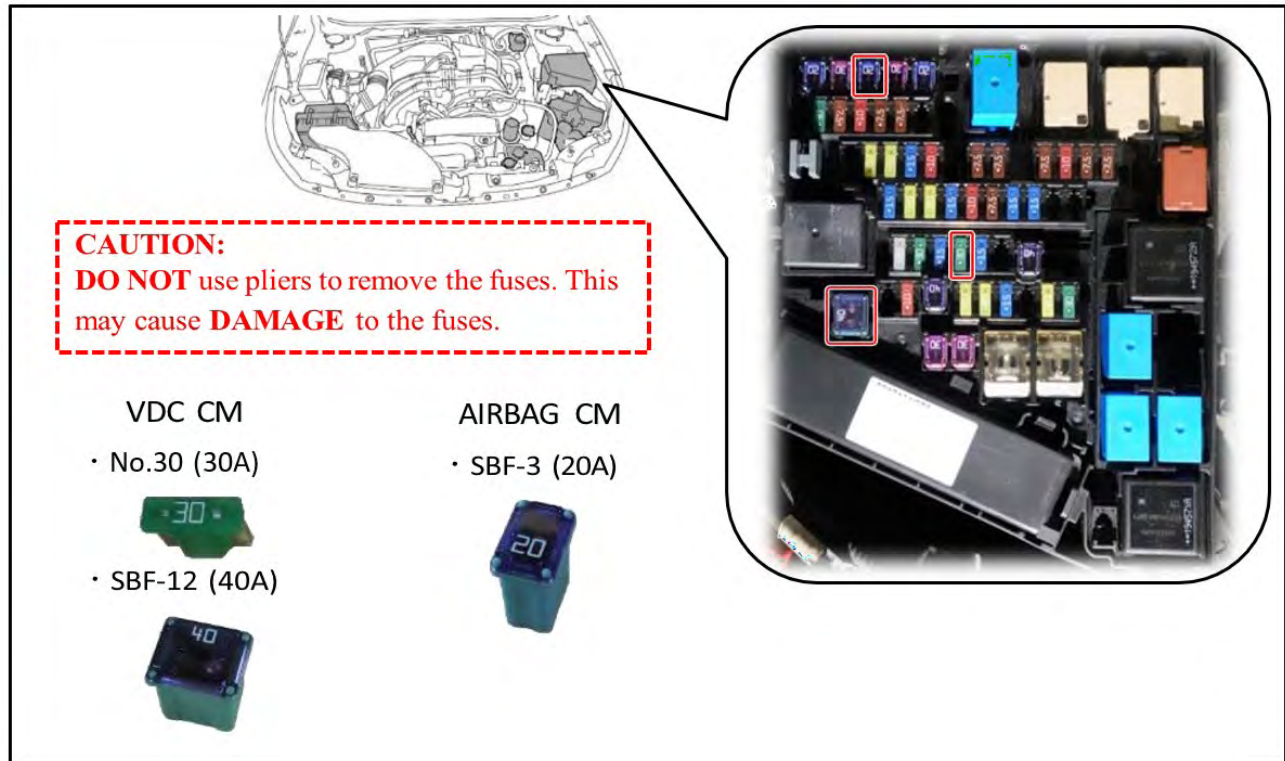

**STEP 4:** Remove the center tray mat. With the mat removed the access hole to the shift lock release will be exposed. Using a suitable screwdriver, release the shift lock and move the gear selector to the Neutral (N) position.

**STEP 5:** Release and lower the portion (A) of the shift boot. This will expose the holding clip. **CAREFULLY** remove the holding clip. The gear selector knob can then be removed.

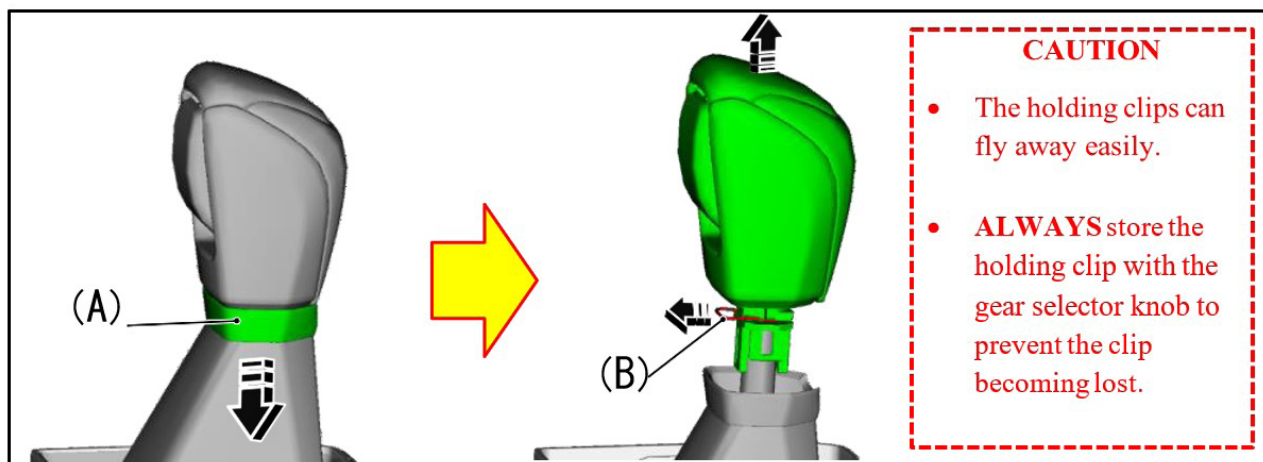

*Continued...*

**STEP 6:** Release the holding clips for the front cover assembly. Disconnect the electrical connection and lift in the upward direction the remove the cover.

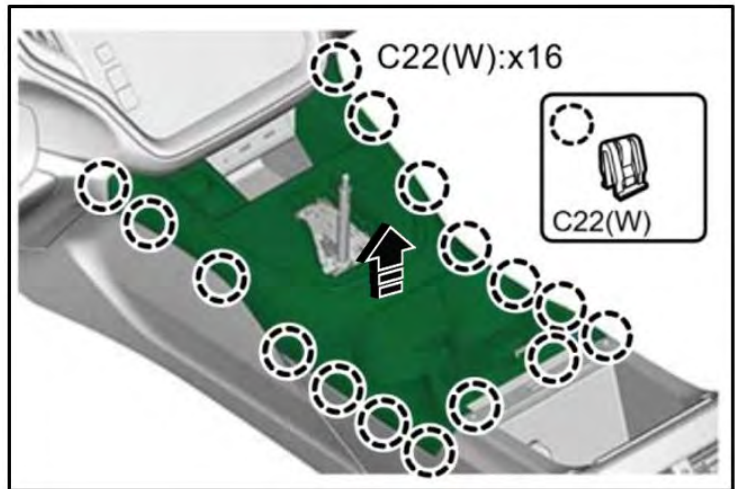

**STEP 7:** Remove the two phillips head mounting screws located at the front of the center console. Adjust both seats forward and remove the two center console mounting bolts. Disconnect the electrical connections and remove the center console from the vehicle.

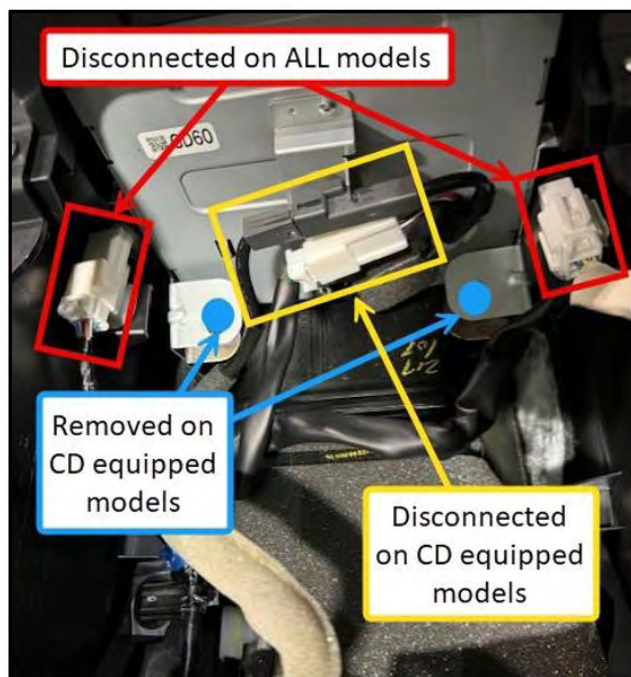
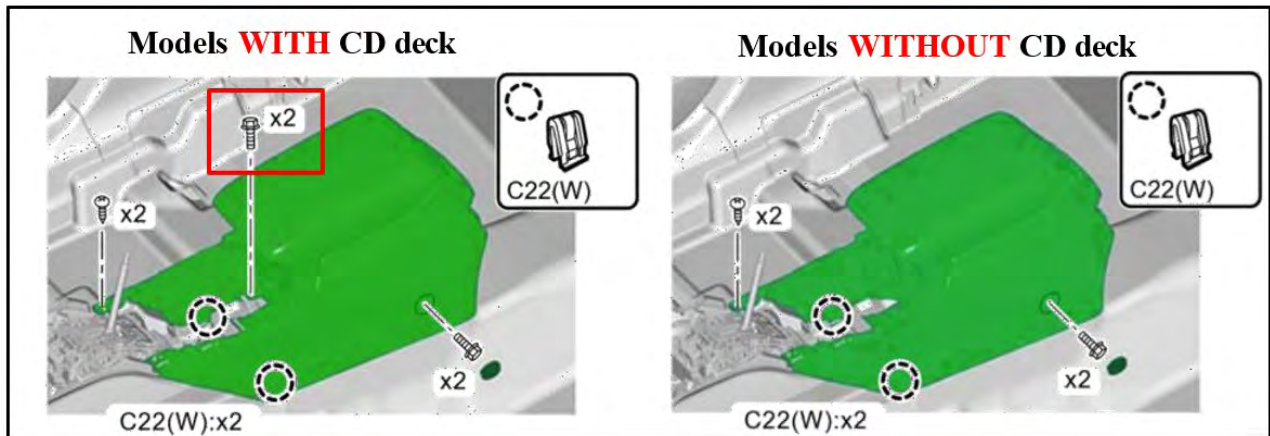

**IMPORTANT:** Models equipped with the center console mounted CD deck will require the removal of two additional mounting bolts and the disconnection of two additional connectors. BE CAREFUL not to bend the CD deck mounting brackets.

*Continued...*

**STEP 8:** Pull up on the backrest adjustment handle and insert a small screwdriver or plastic trim tool into the handle cover locking tab. Once the tab is released pull the handle cover toward the front of the vehicle to remove. Once the handle cover is removed, release the rear section of the seat side cover. With all the holding clips released, the cover can then be removed by pulling towards the front of the vehicle.



**STEP 9:** Adjust the seat backrest to the full down position. Release the rear then front inner hinge cover mounting clips. Remove the inner hinge cover in the upward direction. The backrest can then be returned to the upright position.

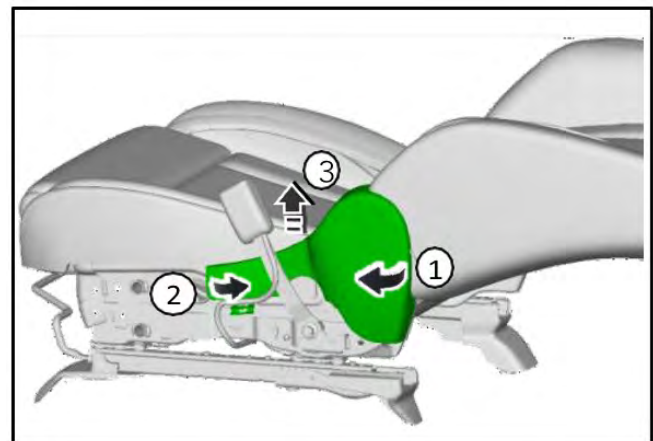

**STEP 10:** Adjust the seat position so the end of the outer rail is approximately 15mm (0.6 inches) from the end of the inner rail.

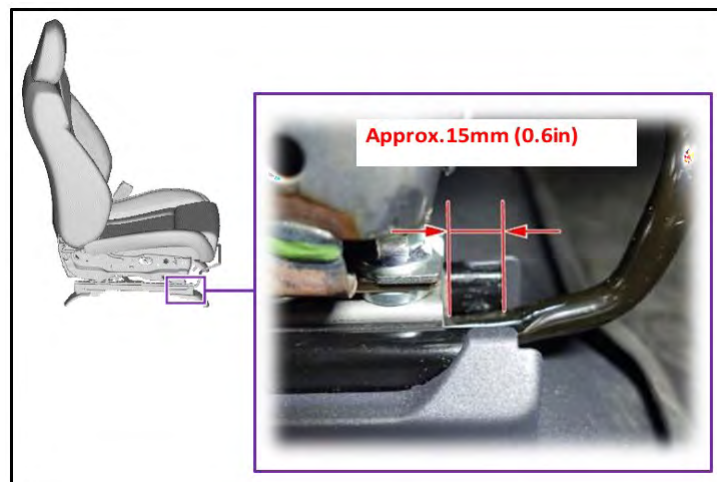

*Continued...*

**STEP 11:** Remove the two straps securing the rear portion of the backrest cover.

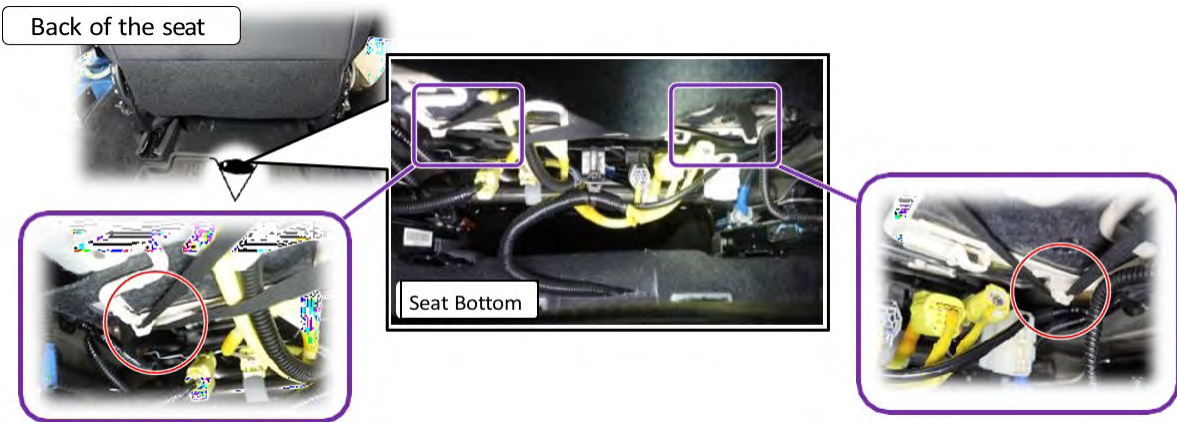

**STEP 12:** Tuck the hanging section of the cover into the rear pocket of the seat. Release the two Velcro straps and free the two harness sections.



**STEP 13:** Unbolt and discard the four bolts mounting the seat backrest to the bracket. Place the backrest into the rear seat footwell area.

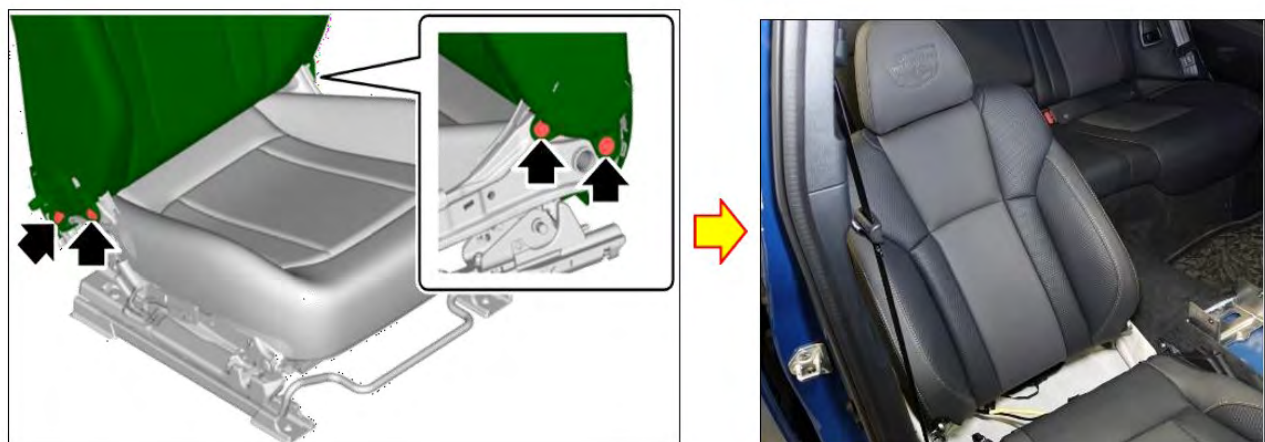

*Continued...*

**CAUTION:** Confirm the harness section does not have any excessive tension and is free from pinching of any kind.



**STEP 14:** Remove both mounting screws for the inner cushion covers.



**STEP 15:** Starting with the outside cover, release the mounting clip using a large flat blade screwdriver or suitable plastic trim tool.

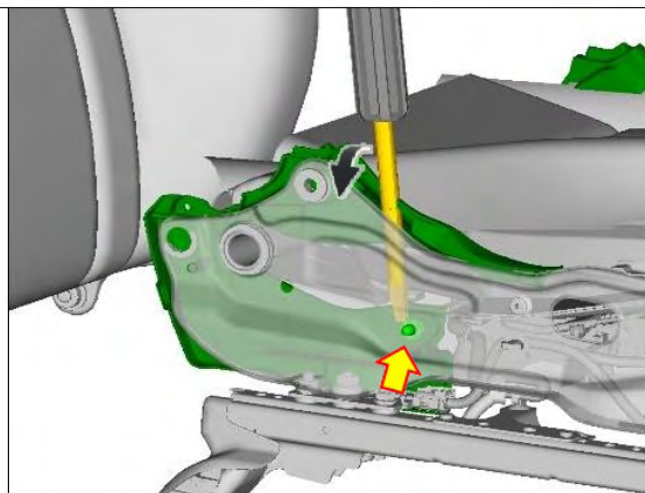

*Continued...*

**STEP 16:** Pull the cover back and then CAREFULLY rotate the cover to remove. Using the same method, remove the opposing side inner cover as well.



**CAUTION:** Make sure there is sufficient room between the covers and the seat backrest. DO NOT damage the seat cover. If needed, cover the seat material with a clean protective cloth.

**STEP 17:** Disconnect all four Occupant Detection connectors under the seat. The connectors can be accessed from the rear footwell.

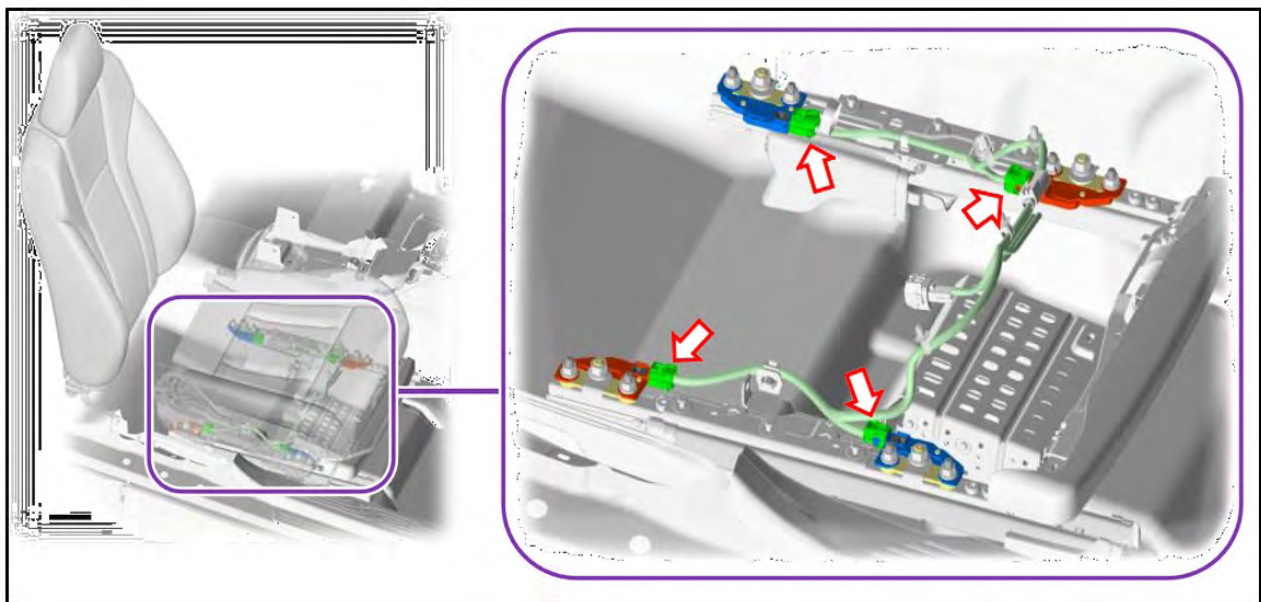

**STEP 18:** Remove the four 14mm (M10) nuts securing the cushion frame. The front nuts can be removed using an offset boxed wrench. The rear nuts can be removed with a 14mm socket, 3/8 in drive ratchet, and 3/8 in drive wobble extension. The nuts can be discarded after removal.

**CAUTION:** Avoid touching the seat adjustment lever with mounting nuts removed. This may cause the left and right rails to become misaligned and difficult to reassemble.

*Continued...*

**NOTE:** Snap-on® tool # [FXWK8](#) is an example of a wobble extension suitable for usage.

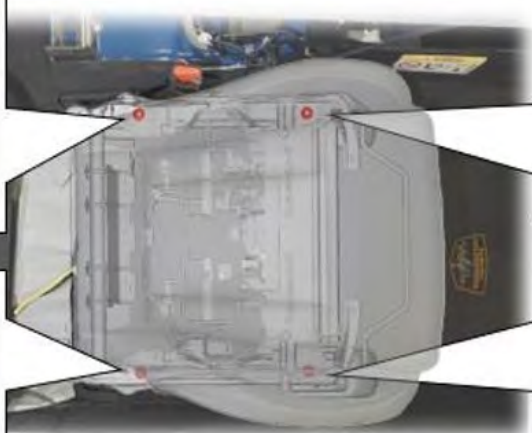
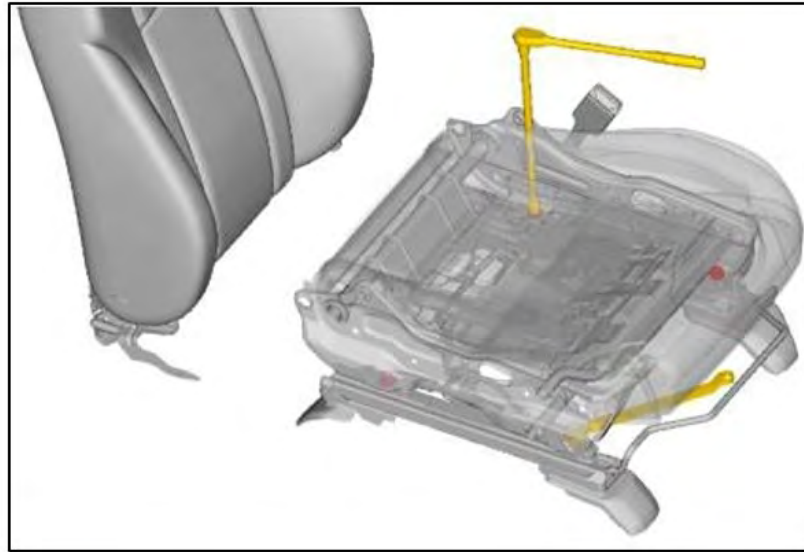

Front →



*Continued...*

NOTE: In rare instances, the stud attached to the ODS sensor may spin when attempting to remove the nut. If this occurs, remove the 8mm nuts (shown in red in the image below) securing the ODS sensors to the seat frame.

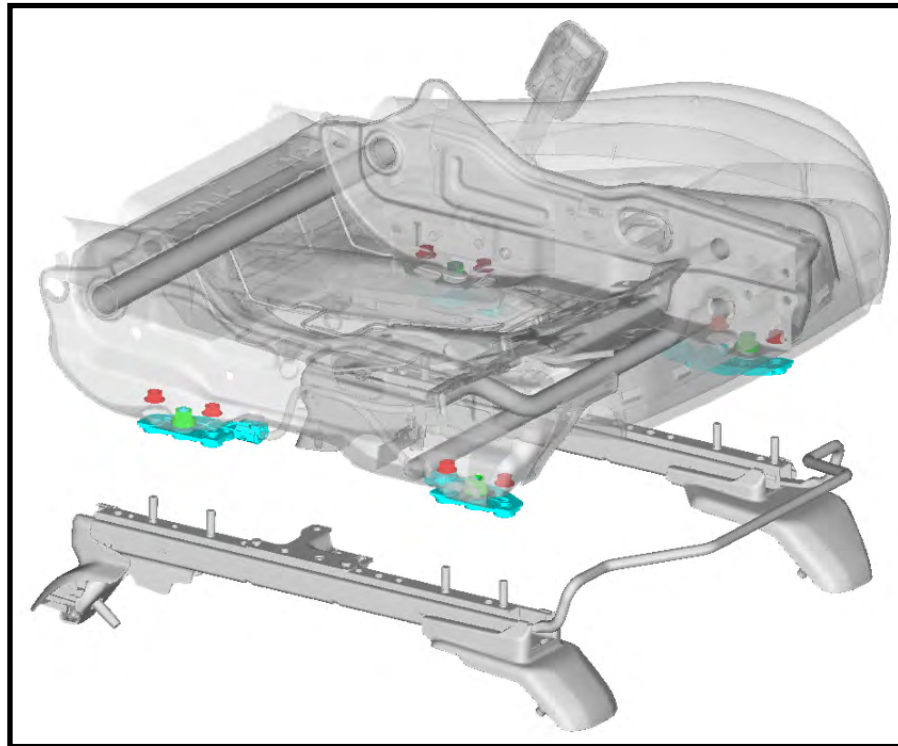

Attach a 19mm twist socket and ratchet to the bottom portion of the stud to prevent it from spinning, then remove the nut securing the ODS sensor to the seat bottom.

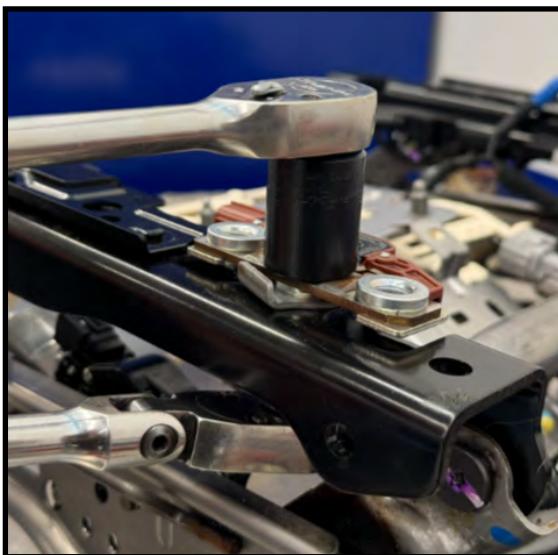

*Continued...*

**STEP 19:** Raise the outer side of the cushion frame 70 to 80 mm (2.76 to 3.15 in) by installing one of the pre-prepared blocks between the cushion frame and the seat rail.

**CAUTION:** Pay close attention to the seat harness when lifting the cushion frame. Excessive tension may cause damage to the harness.

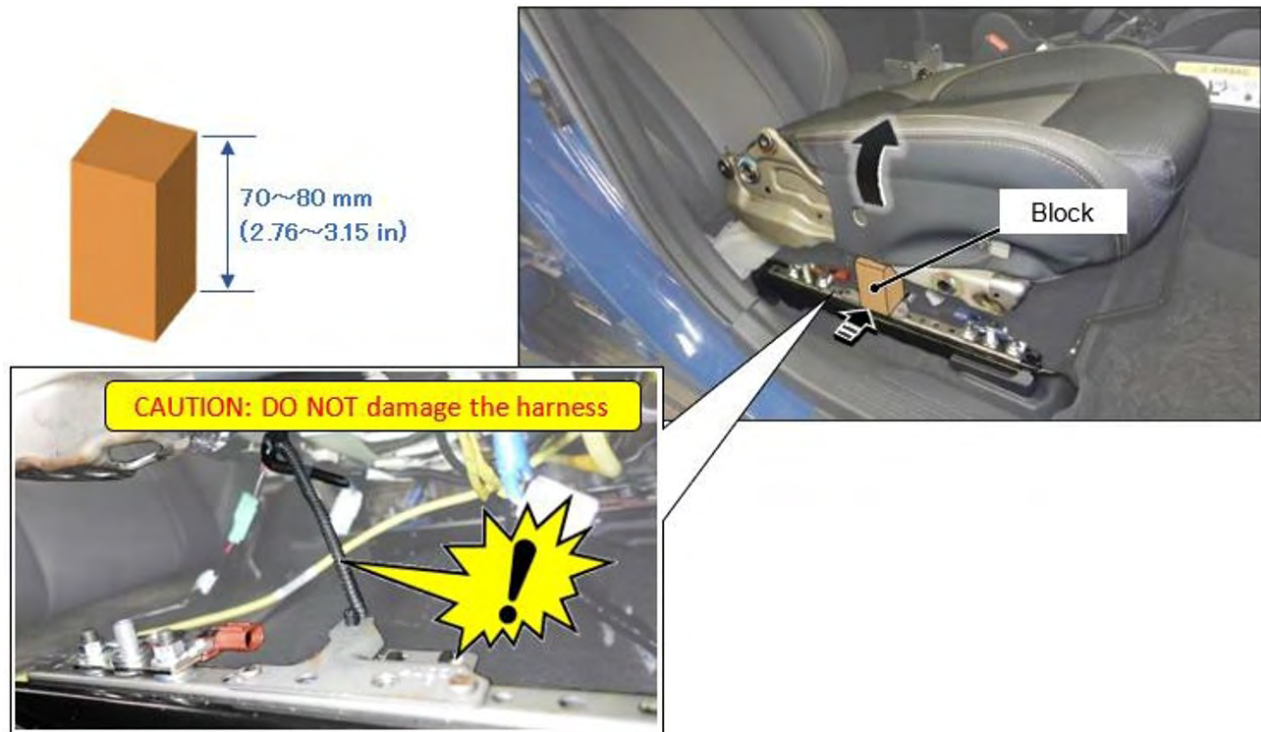

**STEP 20:** Remove and discard the four 12mm (M8) sensor mounting nuts. The two sensors can then be removed and discarded.



*Continued...*

**STEP 21:** Confirm the identification numbers of the NEW Occupant Detection Sensors are #2 and #3. Mount the #2 (**Blue**) sensor to the outer front position and the #3 (**Brown**) sensor to the outer rear position. Torque the NEW sensor mounting nuts (p.n. 64157AN03A) to 25Nm (18.5ft-lbs).

**NOTE:** Take special care in handling the new sensors.

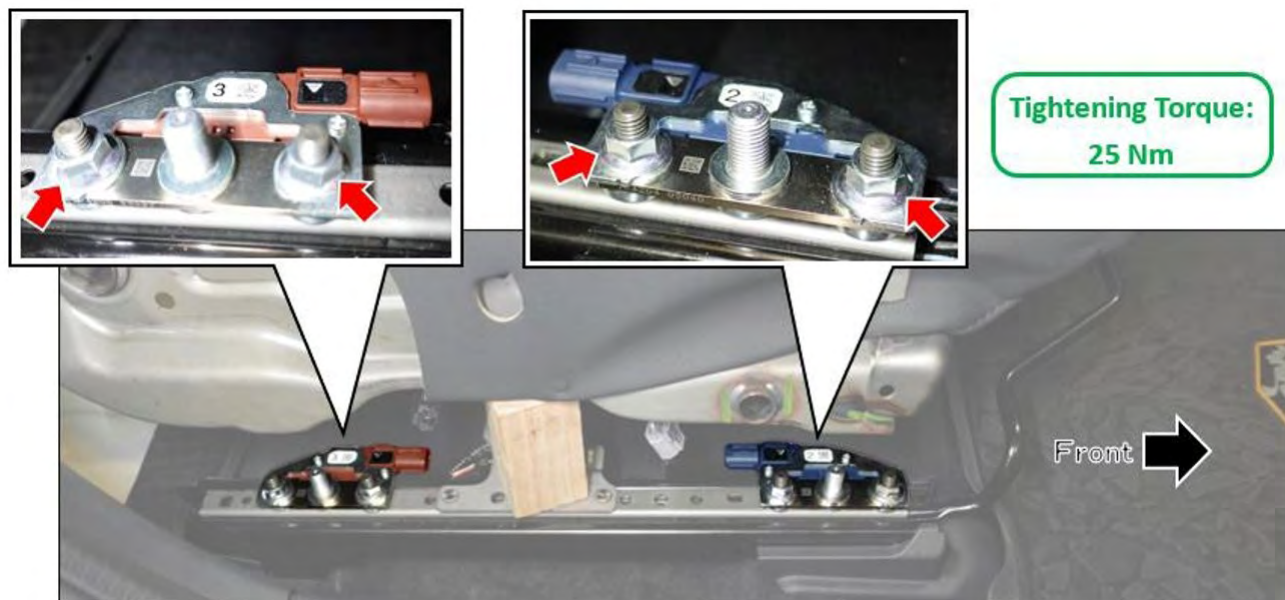

**STEP 22:** Remove the block and CAREFULLY lower the cushion frame.



**NOTES:**

- Slowly lower the cushion while monitoring the bolt of the sensor and the insertion hole of the cushion frame.
- Do not secure the seat until the inner sensor has been replaced.

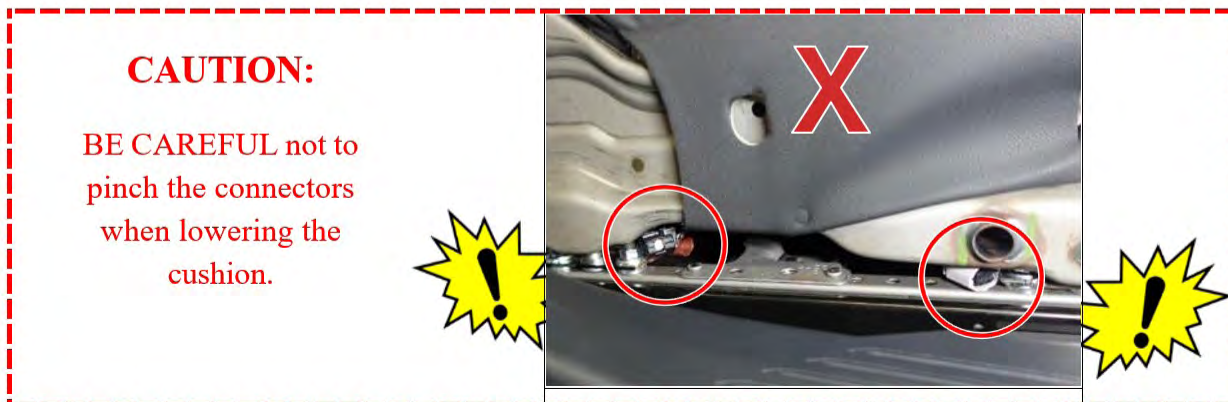

*Continued...*

**STEP 23:** Raise the inner side of the cushion frame 70 to 80 mm (2.76 to 3.15 in) by installing one of the pre-prepared blocks between the cushion frame and the seat rail.

**CAUTION:** Pay close attention to the seat harness when lifting the cushion frame. Excessive tension may cause damage to the harness.

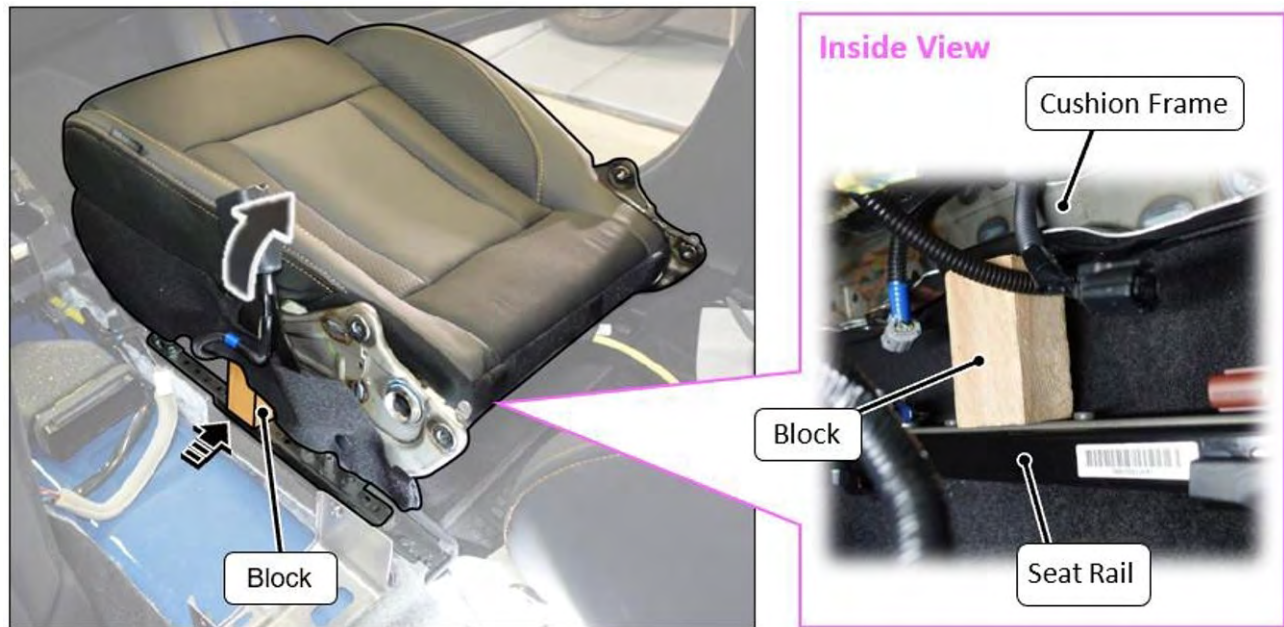

**STEP 24:** Remove and discard the four 12mm (M8) sensor mounting nuts. The two sensors can then be removed and discarded.

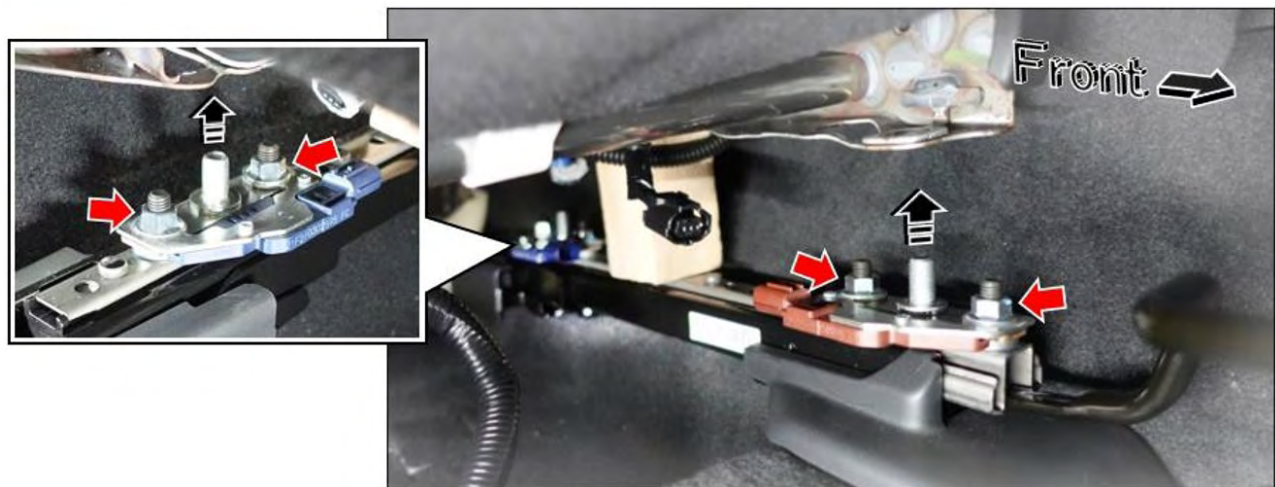

*Continued...*

**STEP 25:** Confirm the identification numbers of the NEW Occupant Detection Sensors are #1 and #4. Mount the #1 (**Brown**) sensor to the inner front position and the #4 (**Blue**) sensor to the inner rear position. Torque the NEW sensor mounting nuts (p.n. 64157AN03A) to 25Nm (18.5ft-lbs).

**NOTE:** Take special care in handling the new sensors.



**STEP 26:** Tuck the connector of sensor #4 into the cushion frame. Remove the block and CAREFULLY lower the cushion frame.

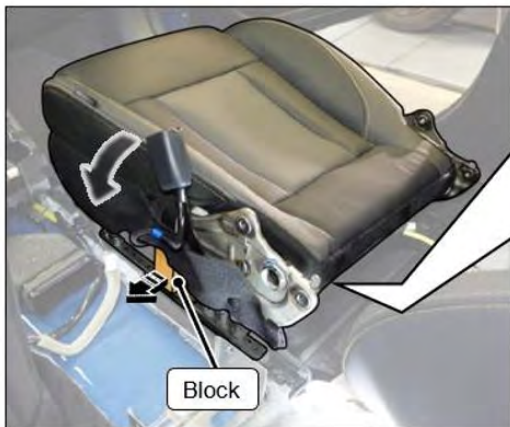
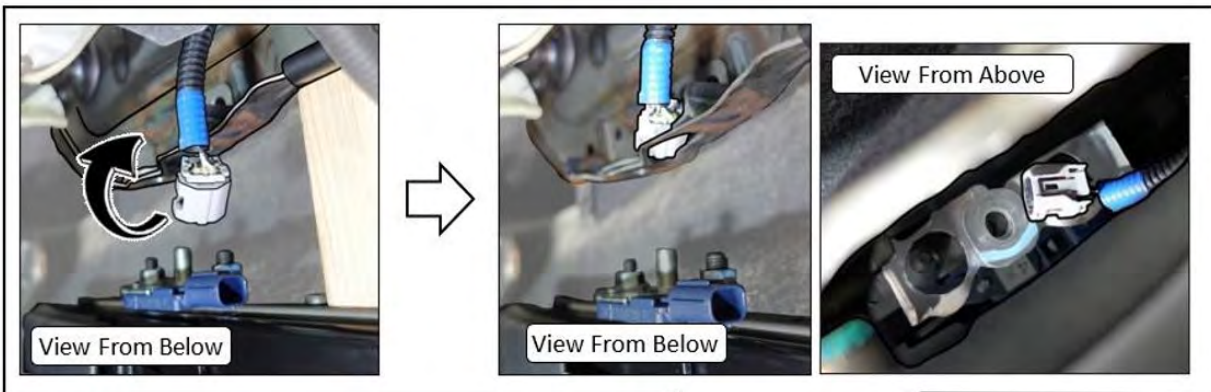

**NOTES:**

- Tuck the connector of sensor #4 into the cushion frame to prevent it from getting crushed.
- Slowly lower the cushion while monitoring the bolt of the sensor and the insertion hole of the cushion frame.

*Continued...*

**CAUTION:** It is possible for the connector to be caught between the cushion frame and the rail/sensor. Confirm the connector is not pinched in any way.

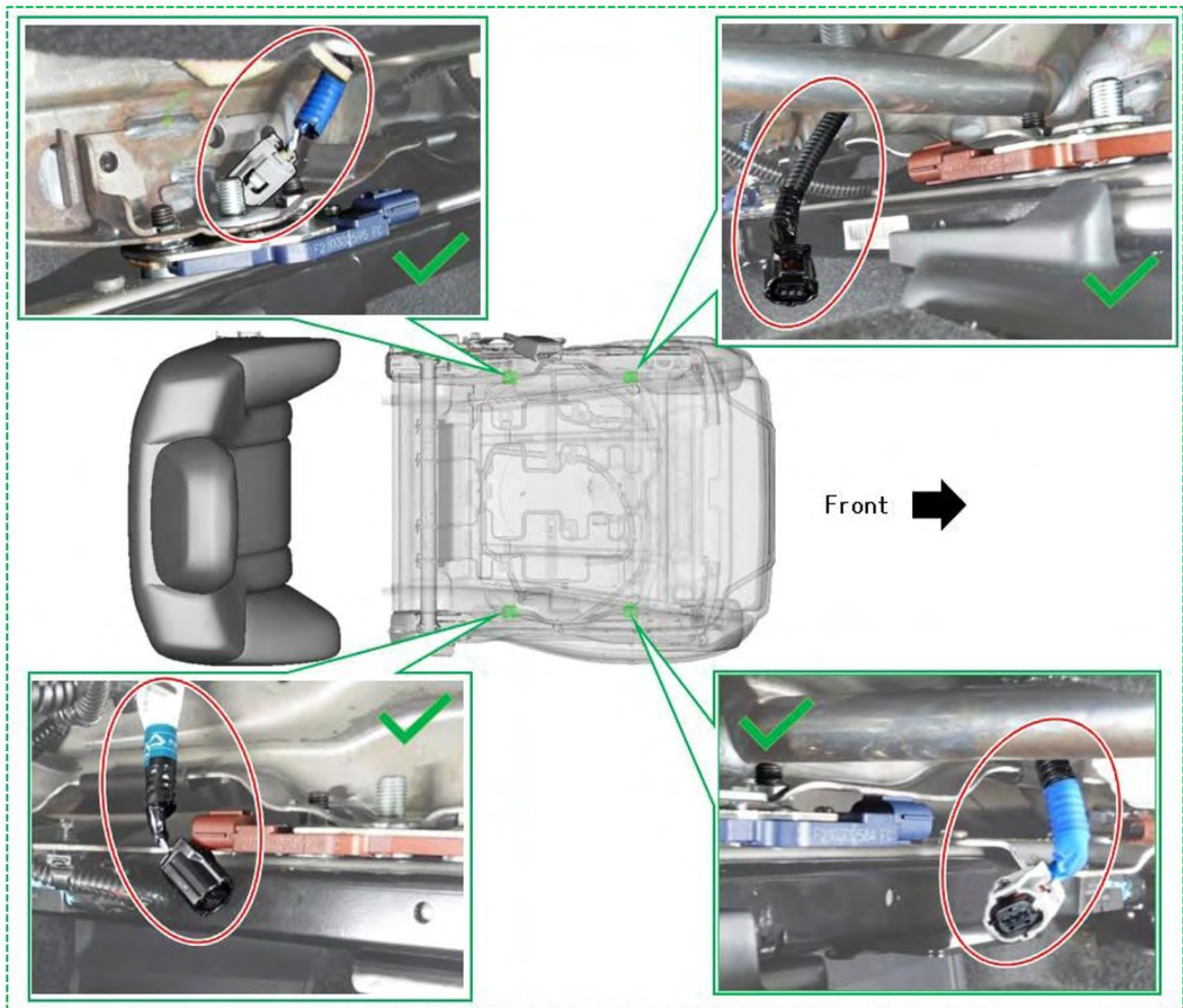
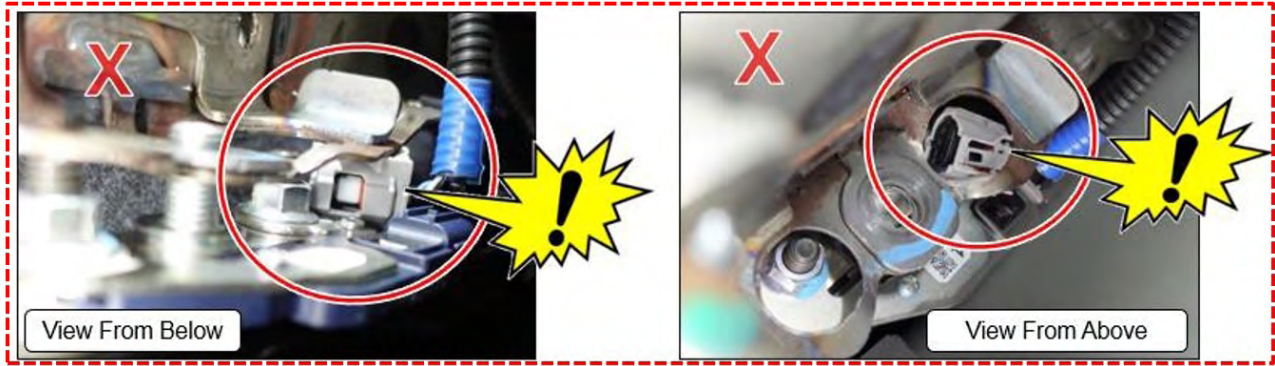

*Continued...*

**STEP 27:** Secure the cushion frame with the four new mounting nuts (p.n. 64157AN01A). Torque the mounting nuts to 37Nm (27ft-lbs).

**NOTE:** The wobble extension is to be used for the rear nuts and the special socket (p.n. 99804AN090) along with the adapter (p.n. 99804AN080) is use for the outer front nut.

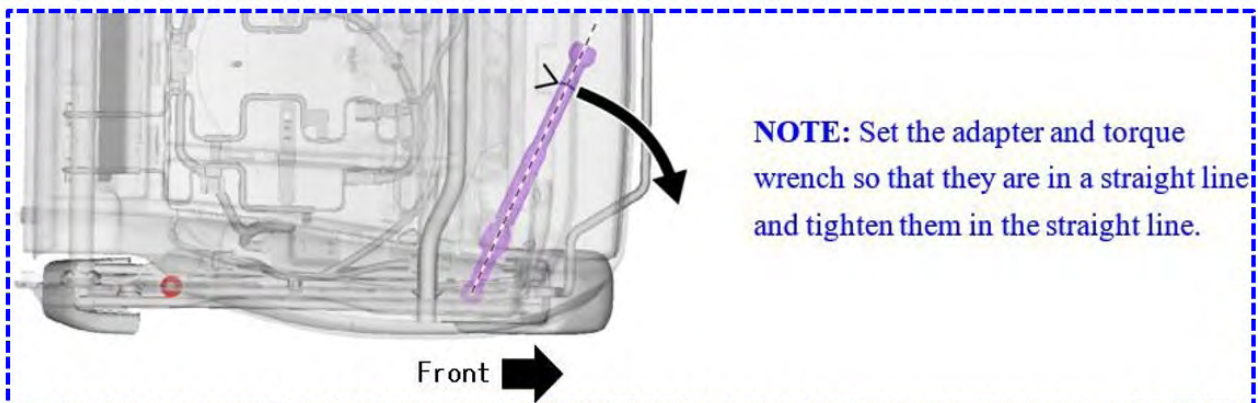
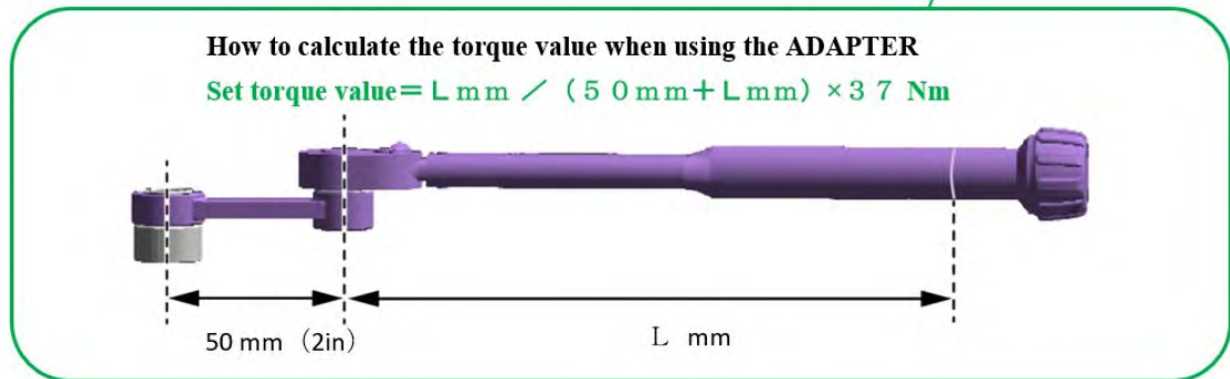
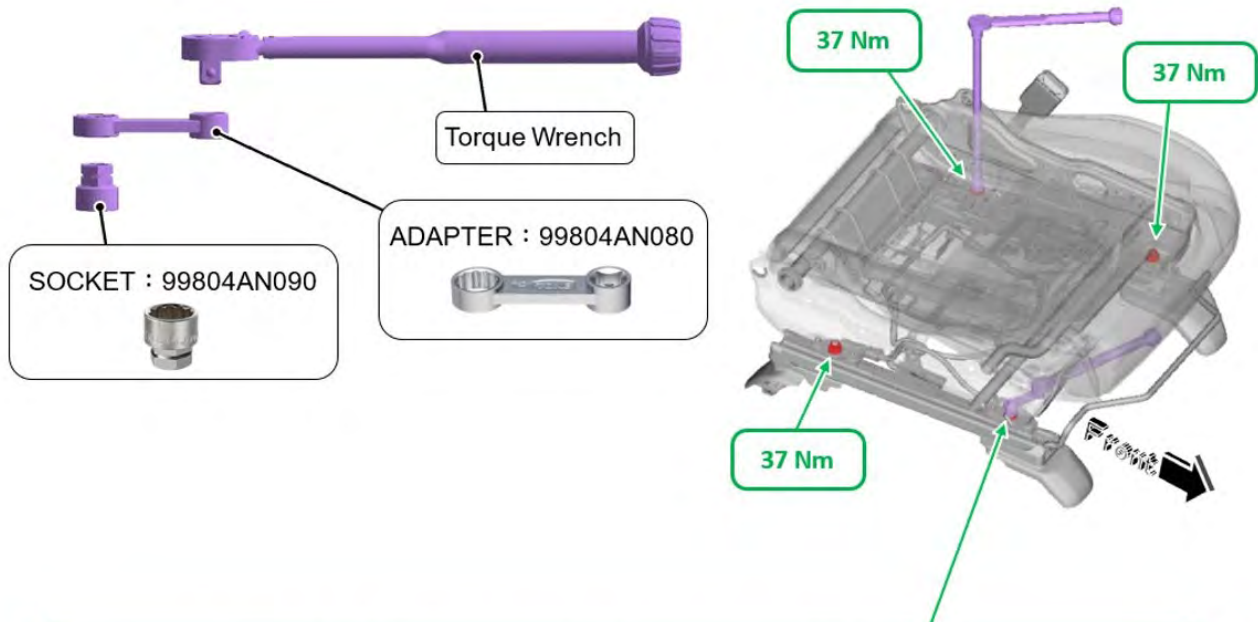

*Continued...*



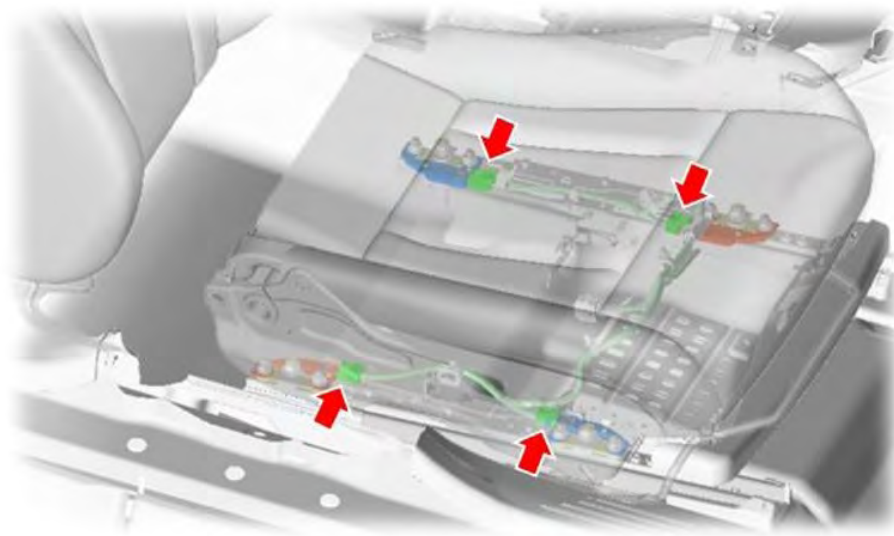
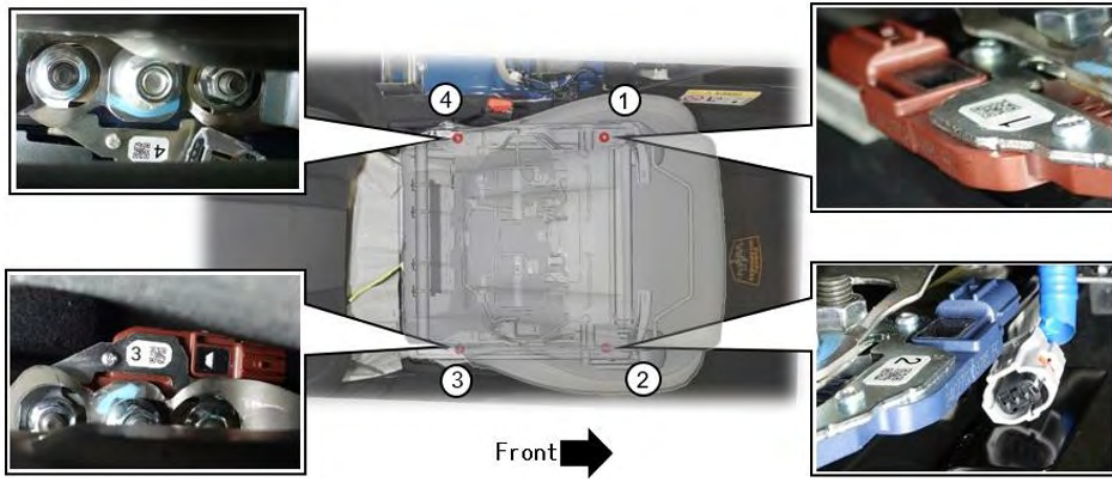

**STEP 28:** Confirm all the sensors are in the associated positions and install all the connections.

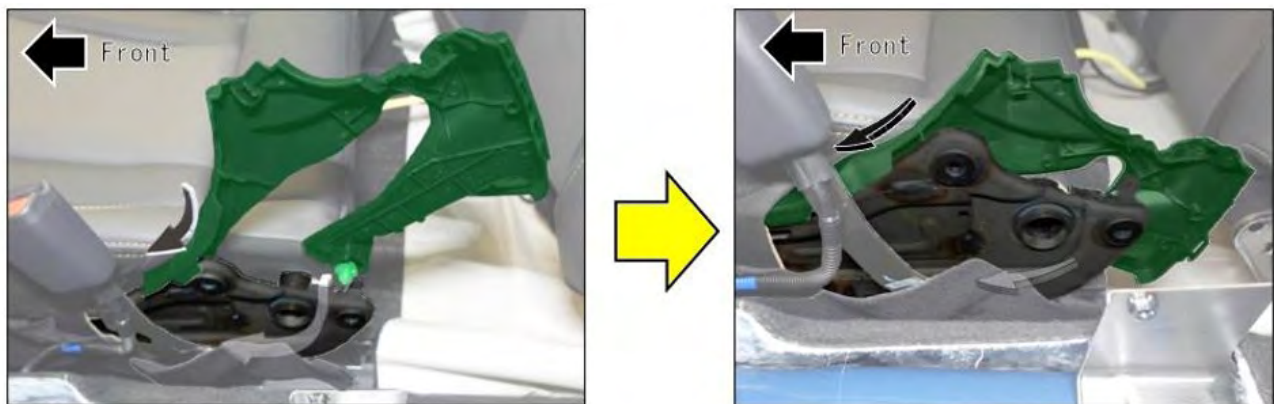

**STEP 29:** Install the inner cushion cover by inserting the grooved section at the tip of the cover along the metal frame. Once in the correct alignment, insert the mounting clip. Confirm the mounting clip positioning when complete.



*Continued...*

	Mounting condition of the cover	Clip Position
✓	 <p>A close-up photograph showing a green plastic cover being correctly mounted onto a metal component. A red oval highlights the green clip on the cover, which is properly seated and flush against the metal surface.</p>	 <p>A close-up photograph of the green clip from the previous image, showing it is correctly positioned and fully engaged with the metal component.</p>
✗	 <p>A close-up photograph showing the green plastic cover incorrectly mounted. A red oval highlights the green clip, which is not properly seated and is protruding from the metal surface.</p>	 <p>A close-up photograph of the green clip, showing it is incorrectly positioned and not fully engaged with the metal component.</p>

**STEP 30:** Using the same method, install the outer cover.

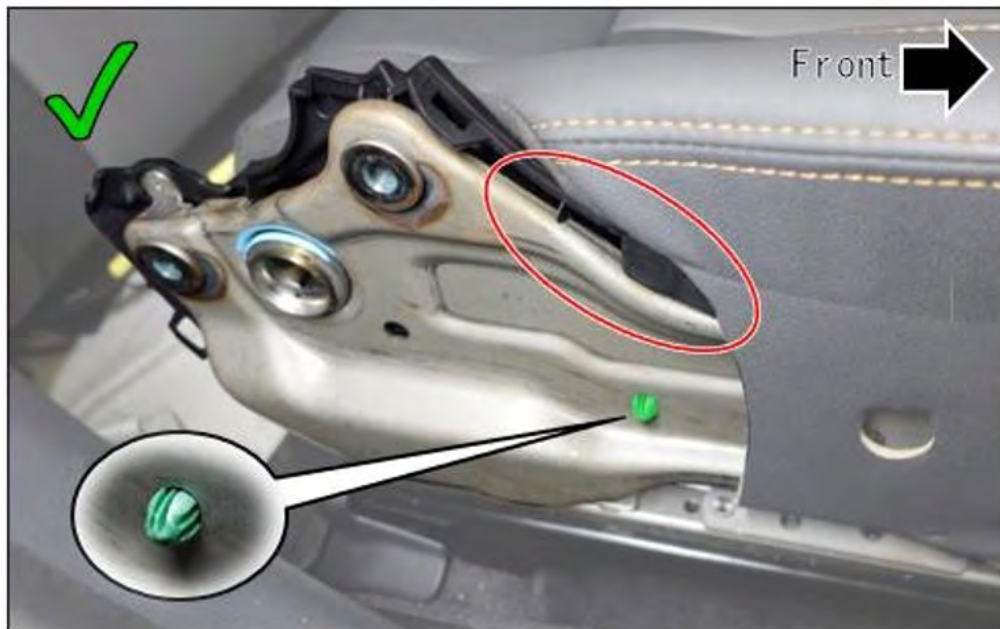

*Continued...*

**STEP 31:** Reinstall the two mounting screws for the inner cushion covers.



**STEP 32:** Reinstall the backrest using the new mounting bolts (p.n. 64127FL00A). Torque the new mounting bolts to 52Nm (38 ft-lbs).

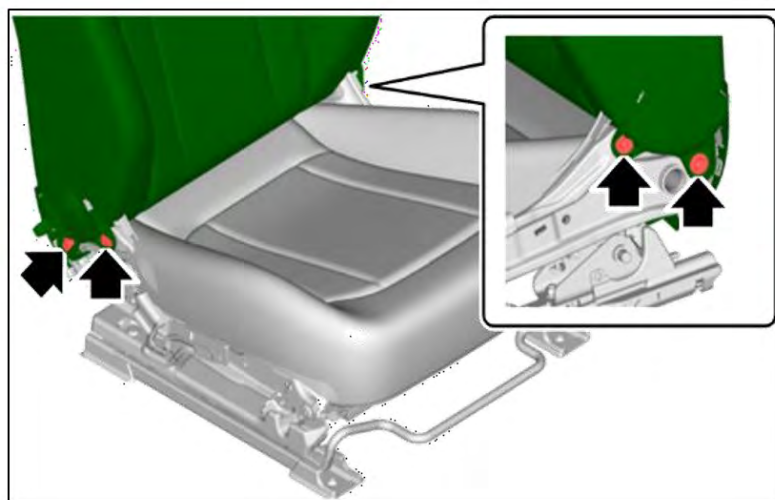

**Tightening Torque: 52 Nm**

*Continued...*

**STEP 33:** Secure the two Velcro straps and harness sections. Untuck the hanging section of the cover from the rear pocket of the seat.



**STEP 34:** Resecure the two straps of the seat backrest cover to the hooks.

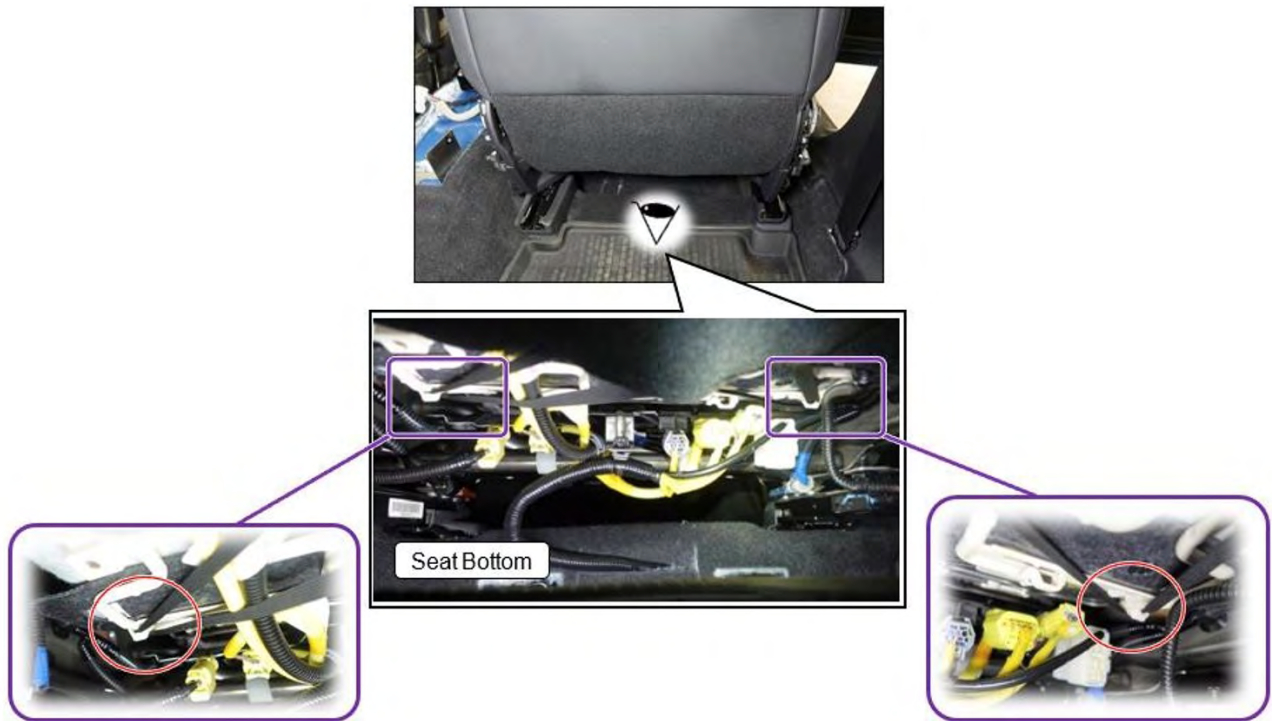

**STEP 35:** Reinstall the inner and outer hinge covers and handle.



*Continued...*

**STEP 36:** Reinstall the center console and gear selector cover.

**STEP 37:** Reinstall the fuses.



**STEP 38:** Sit on the front passenger seat and slightly move around while adjusting the positions.



**STEP 39:** Using the SSM4, perform the “Rezeroing” procedure as per the applicable Service Manual.

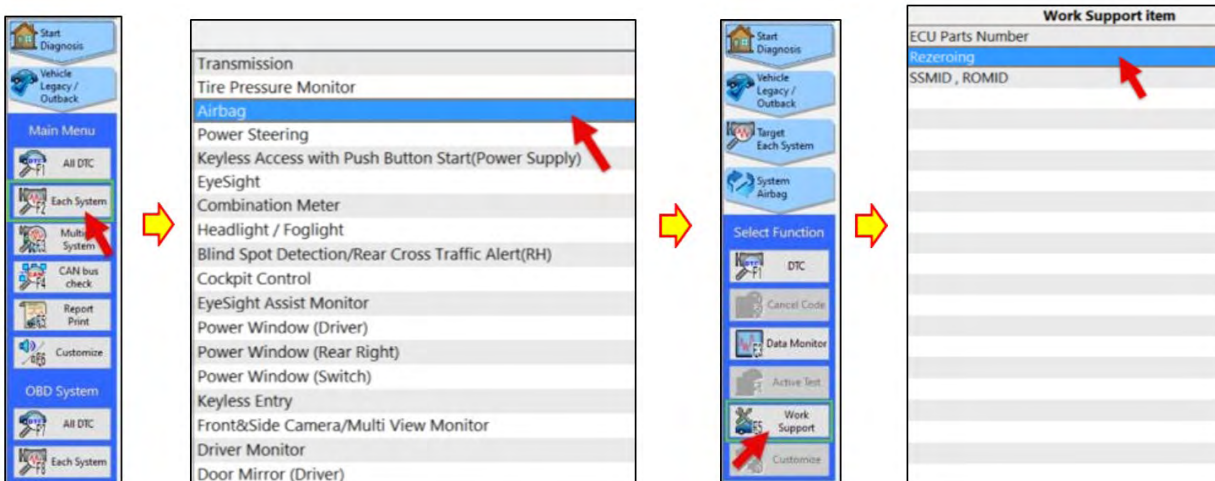

*Continued...*

**STEP 40:** Once the “Rezeroing” procedure is successfully completed, you will be prompted to start a “Sensitivity Check”. Click the “OK” button to continue.

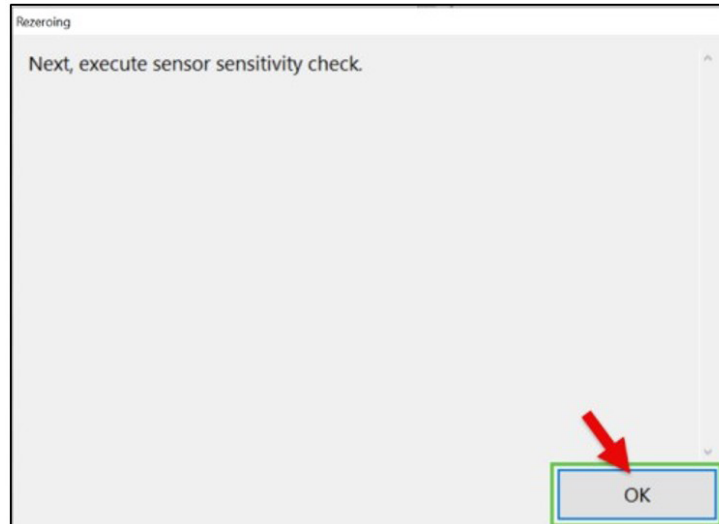

**STEP 41:** Confirm the seat and backrest are adjusted fully forward. Install both components of special tool #J-47673.



**STEP 42:** Input 80.0 lbs. Click the “OK” button to continue.

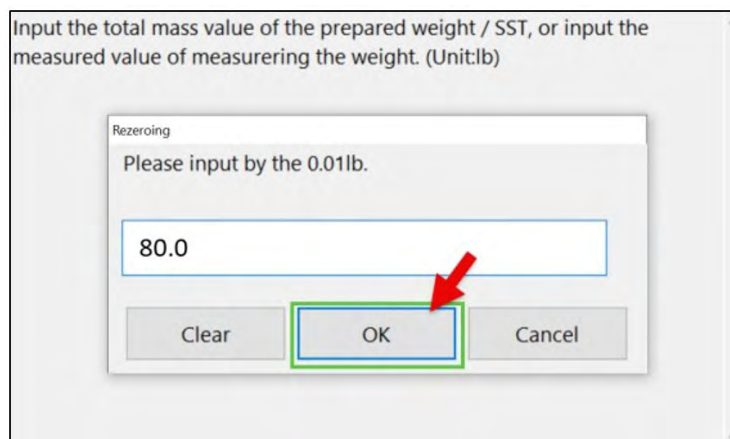

*Continued...*

**STEP 43:** Once the “Sensitivity Check” is successfully completed, check the following data monitors: Front-Left Sensor Load Value, Front-Right Sensor Load Value, Rear-Left Sensor Load Value, Rear-Right Sensor Load Value.

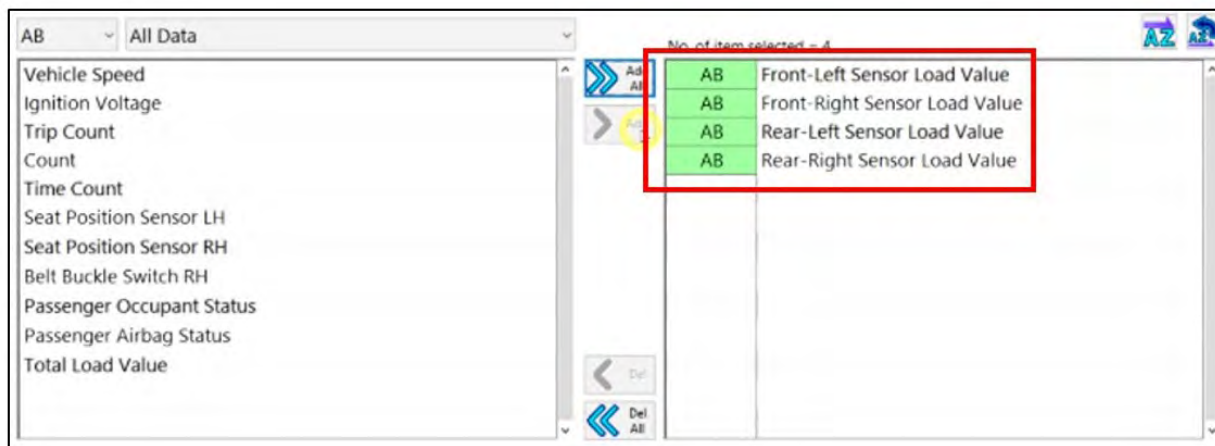

**STEP 44:** While sitting in the passenger rear seat, pull the backrest toward the rear of the vehicle and monitor the values. The front sensors should have a negative (-) value and the rear sensors should have a positive (+) value.

**CAUTION:** DO NOT push the backrest toward the front of the vehicle at any point. This will cause an inaccurate reading.

	Item	Value	Unit	Maximum	Minimum	Average
<input checked="" type="checkbox"/>	AB Front-Left Sensor Load Value	-37.75	kg	-0.13	-37.75	-4.97
<input checked="" type="checkbox"/>	AB Front-Right Sensor Load Value	-35.90	kg	0.22	-35.90	-4.60
<input checked="" type="checkbox"/>	AB Rear-Left Sensor Load Value	45.33	kg	45.33	0.09	6.39
<input checked="" type="checkbox"/>	AB Rear-Right Sensor Load Value	35.23	kg	35.23	-0.31	4.53



Item	✓	✗		
	Case1	Case2	Case3	Case4
	Value	Value	Value	Value
Front-Left Sensor Load Value	- 37.75	45.33	- 37.75	45.33
Front-Right Sensor Load Value	- 35.90	35.23	45.33	- 37.75
Rear-Left Sensor Load Value	45.33	- 37.75	- 35.90	35.23
Rear - Right Sensor Load Value	35.23	- 35.90	35.23	- 35.90

**IMPORTANT:** In a case when the values do not match the desired specification, it possible the sensor mounting position is incorrect.

**STEP 45:** Once the values are confirmed. Save the data. Perform a DTC check and clear all fault codes. Confirm there are no current fault codes.

**NOTE:** DTC B14A1 (Sunload Sensor Circuit Low/Open) may be read as a current DTC but this is a normal condition.

*Continued...*

**STEP 46:** Disconnect all battery charging equipment.



**IMPORTANT:** A detailed video of this Service Procedure can be viewed by accessing the following link:



**END OF MANUAL SEAT SERVICE PROCEDURE/INFORMATION**

*Continued...*

## POWER SEAT SERVICE PROCEDURE:

**Warning:** The lower seat frame (Power or manual) must remain installed in the vehicle as instructed to keep various components properly aligned. Disassembling and reassembling the lower seat frame outside the vehicle will cause various misalignment concerns. If this occurs, replacement of the lower seat frame will be required.

**STEP 1:** Prepare two pieces of string approximately 3.2 feet (1 meter) in length. Tie two of the pieces of the WRA-24 JIG tool (p.n. 99804AN100) together by the outer holes. Repeat the process for the remaining two pieces. This will help provide ease of removal after the tool is used. Refer to the image below.

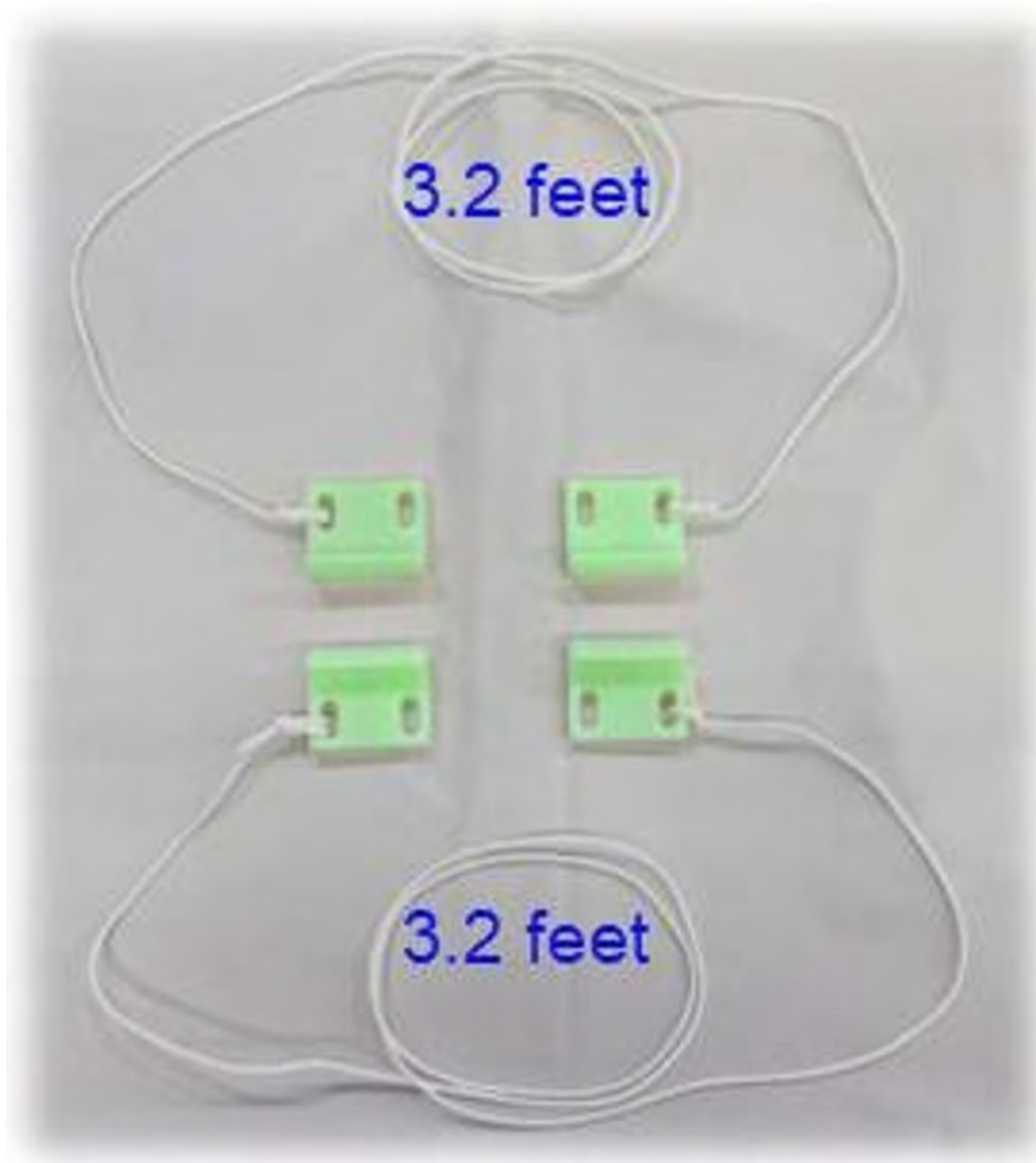

*Continued...*

**USE CAUTION WHEN HANDLING THE OCS SENSORS:**

- **DO NOT** use any sensor if dropped or experienced any type of impact.
- **DO NOT** allow water, oil, etc. to adhere to the sensors.
- **DO NOT** touch the portions of the sensor outlined in **RED** below.

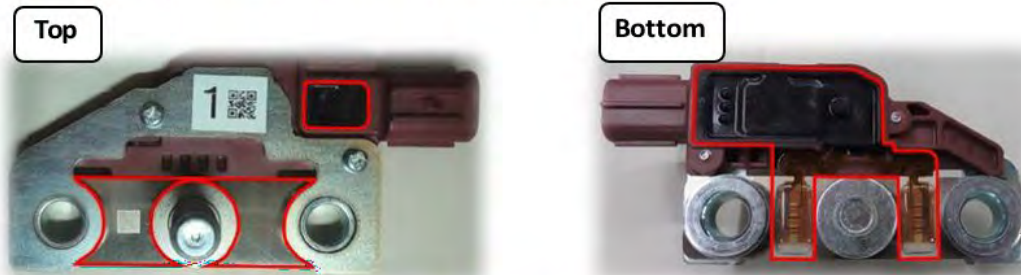

**EXAMPLES OF PROPER SENSOR HANDLING:**



**STEP 2:** Using a DCA-8000, input the battery information and set the charger to Power Supply Mode.

**STEP 3:** Apply the parking brake. This is required because the gear selector will be placed in the Neutral (N) position in a future step.

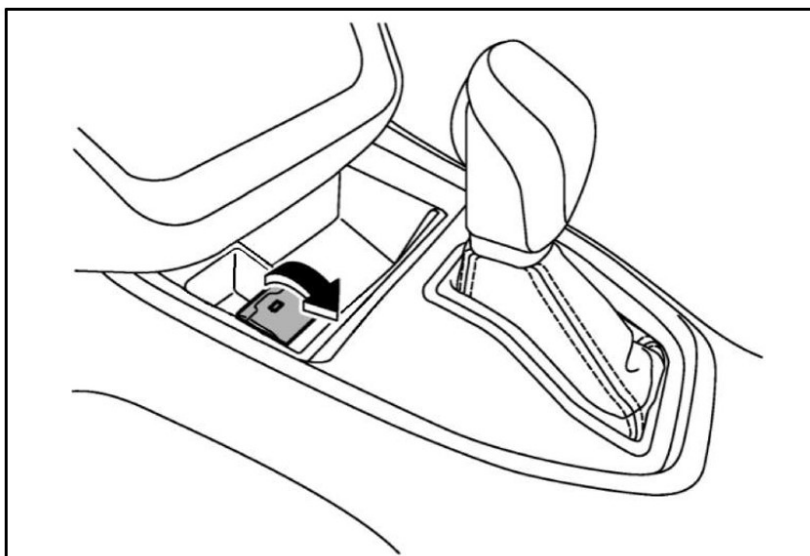

*Continued...*

**STEP 4:** Confirm at least one minute has surpassed since the ignition was switched off. Remove the cover from the main fuse box. Using a small flat blade screwdriver, remove Fuse # 30, SBF-3, SBF-12.

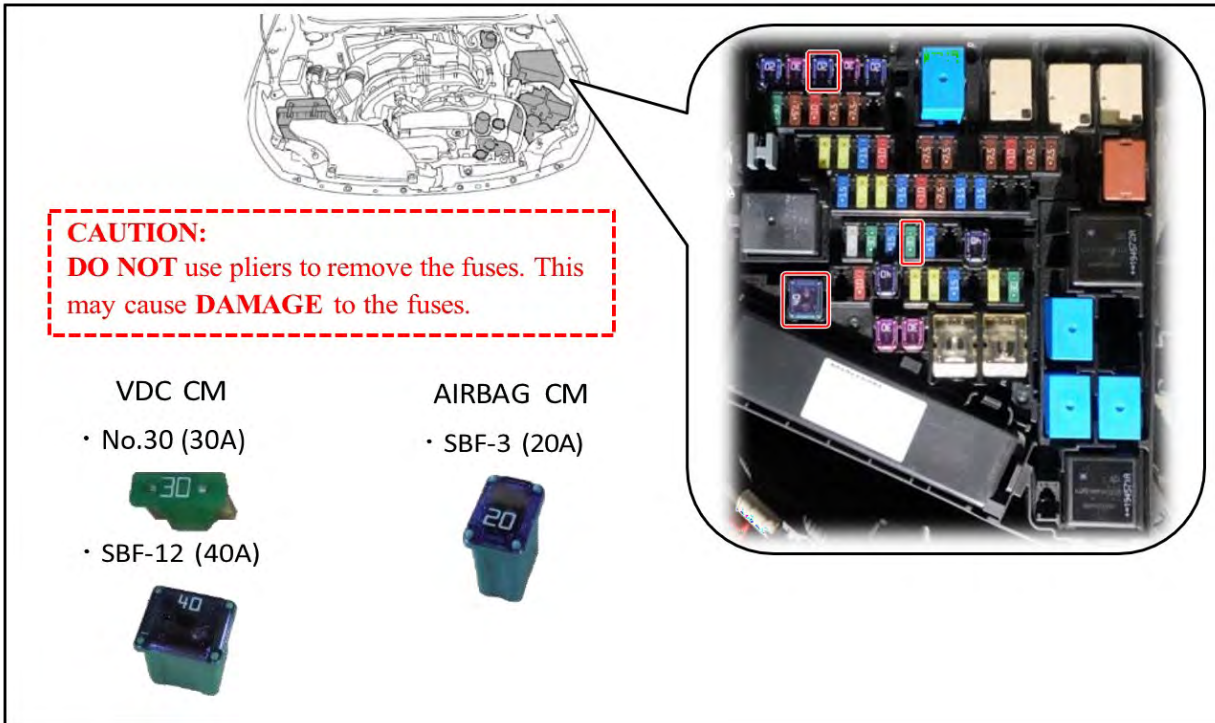

**STEP 5:** Remove the center tray mat. With the mat removed the access hole to the shift lock release will be exposed. Using a suitable screwdriver, release the shift lock and move the gear selector to the Neutral (N) position.

**STEP 6:** Release and lower the portion (A) of the shift boot. This will expose the holding clip. **CAREFULLY** remove the holding clip. The gear selector knob can then be removed.

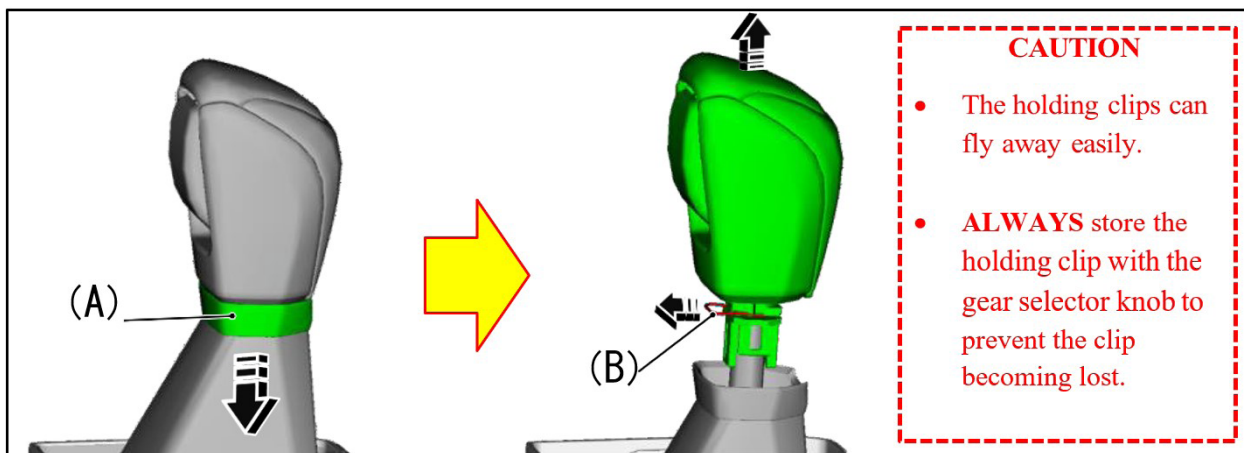

*Continued...*

**STEP 7:** Release the holding clips for the front cover assembly. Disconnect the electrical connection and lift in the upward direction the remove the cover.

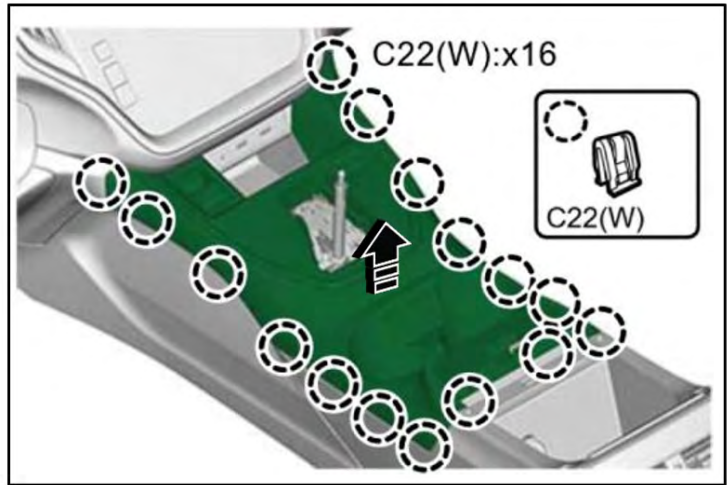

**STEP 8:** Remove the two phillips head mounting screws located at the front of the center console. Adjust both seats forward and remove the two center console mounting bolts. Disconnect the electrical connections and remove the center console from the vehicle.

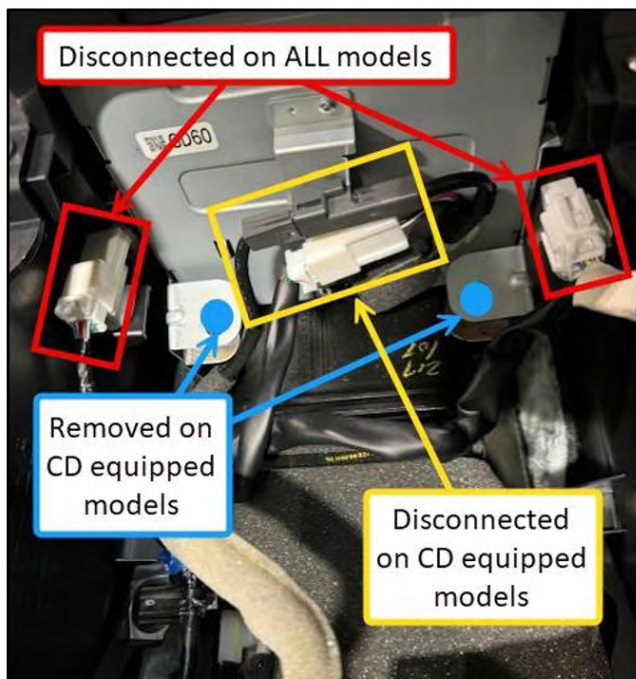
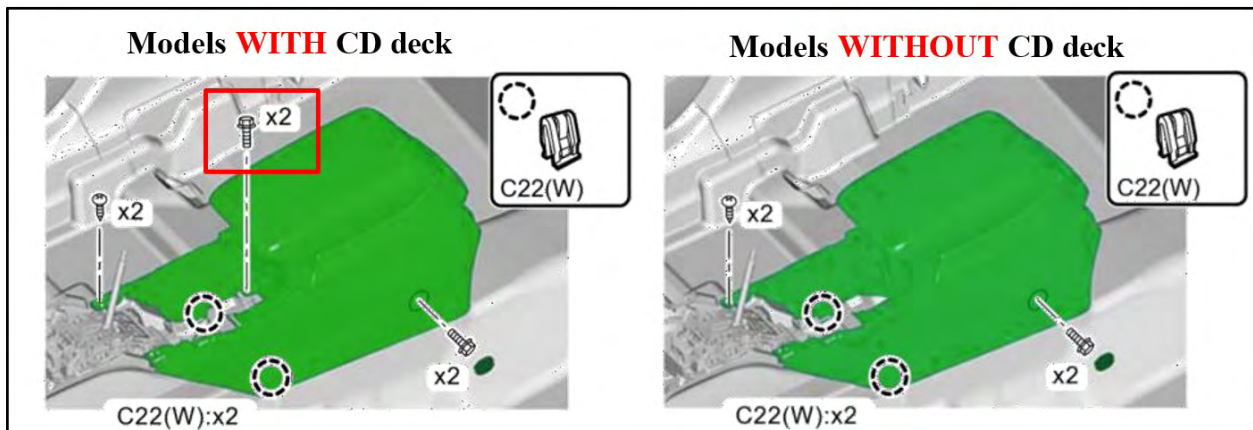

**IMPORTANT:** Models equipped with the center console mounted CD deck will require the removal of two additional mounting bolts and the disconnection of two additional connectors. BE CAREFUL not to bend the CD deck mounting brackets.

*Continued...*

**STEP 9:** Tilt the seat backrest fully forward and raise the seat bottom to the maximum height.

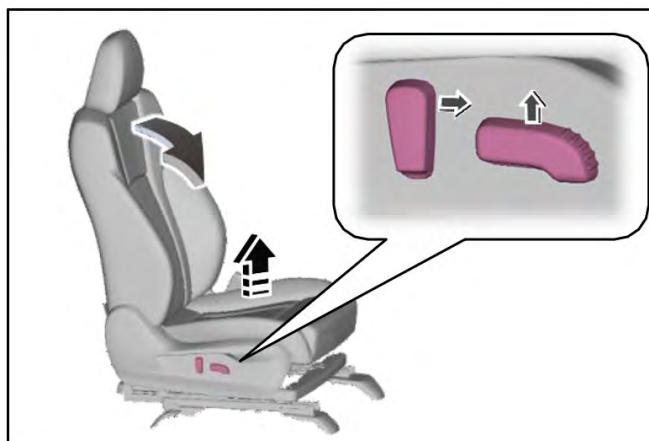

**STEP 10:** Release the rear section of the seat side cover. With all the holding clips released, the cover can then be removed by pulling towards the front of the vehicle. There is no need to disconnect the switch/harness. The cover can be placed on top of the seat. A clean fender cover or cloth can be used for seat protection.

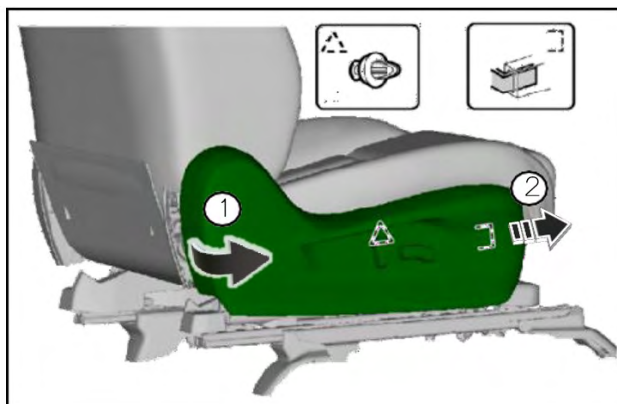

**STEP 11:** Remove the outer slide rail cover by removing the mounting screw and sliding the cover toward the rear of the vehicle.

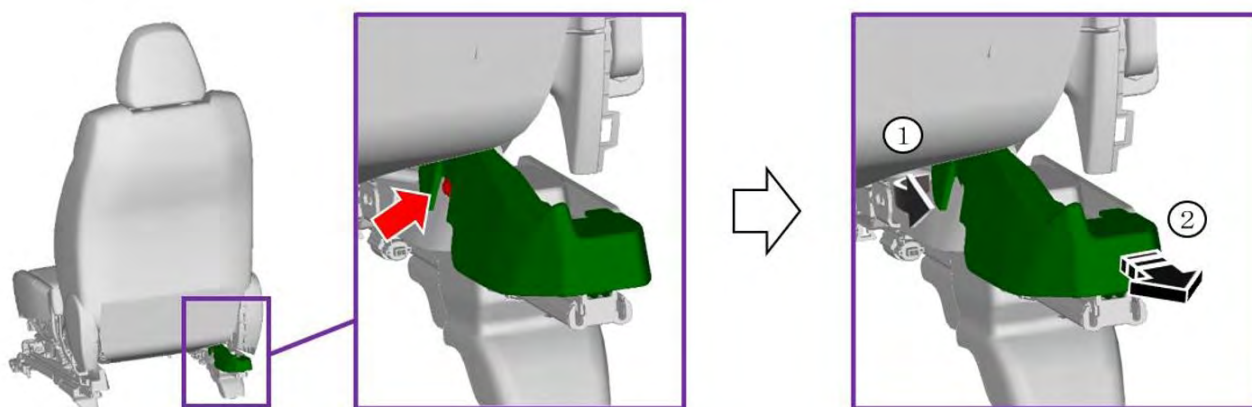

*Continued...*

Remove the inner slide rail cover by releasing the front tab and sliding the cover toward the rear of the vehicle.

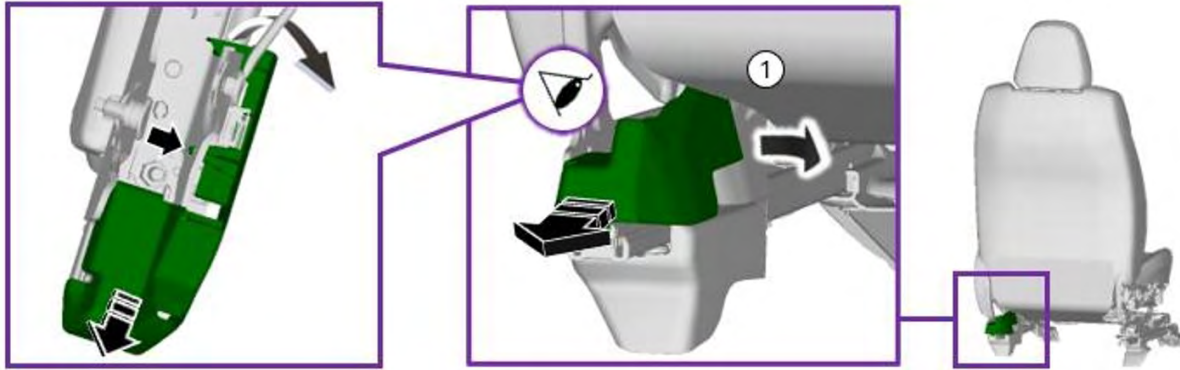

**STEP 12:** Adjust the seat position so the end of the lower cover is approximately 40mm (1.6 inches) from the end of the inner rail.

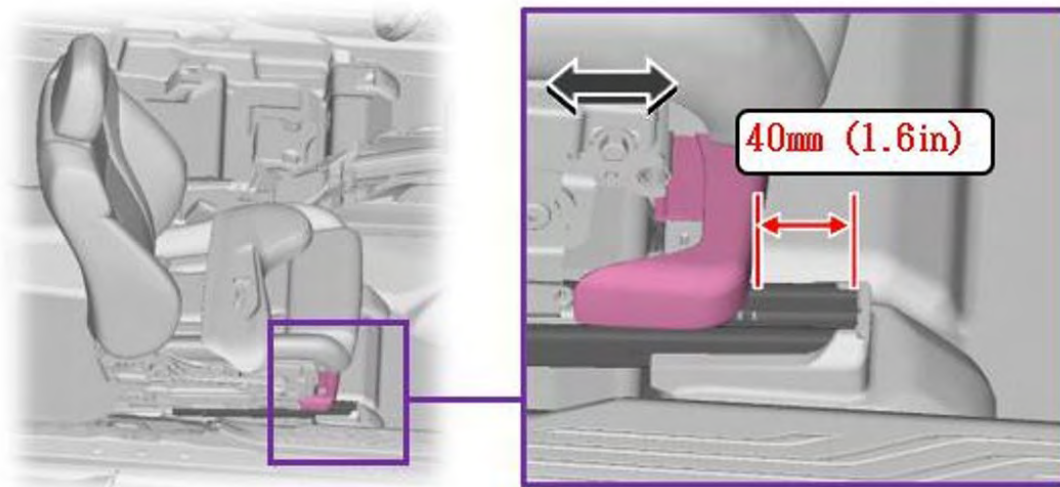

**STEP 13:** Disconnect all four Occupant Detection connectors under the seat. The connectors can be accessed from the rear footwell.

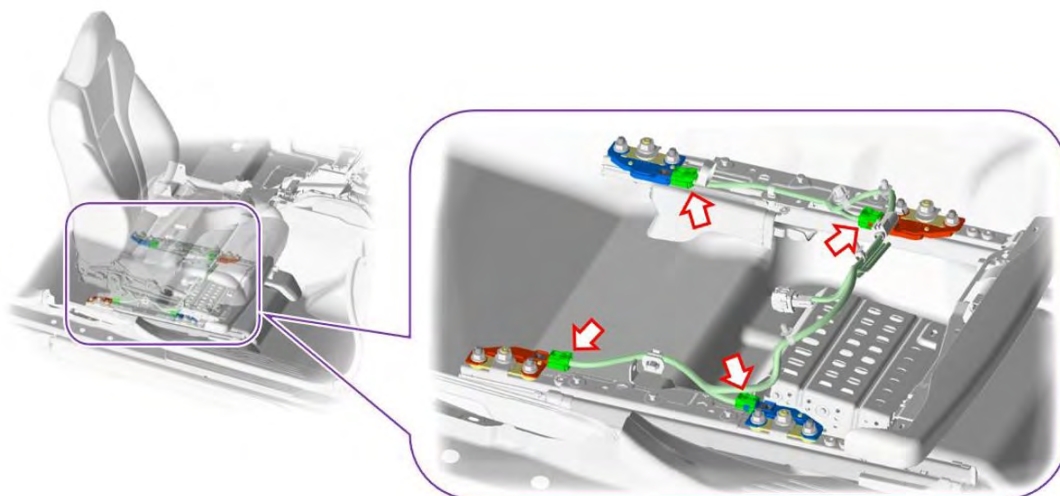

*Continued...*

**STEP 14:** Remove the four 14mm (M10) nuts securing the cushion frame. The front inside nut can be removed using the special socket (p.n. 99804AN090) and adapter (p.n. 99804AN080). The nuts can be discarded after removal.

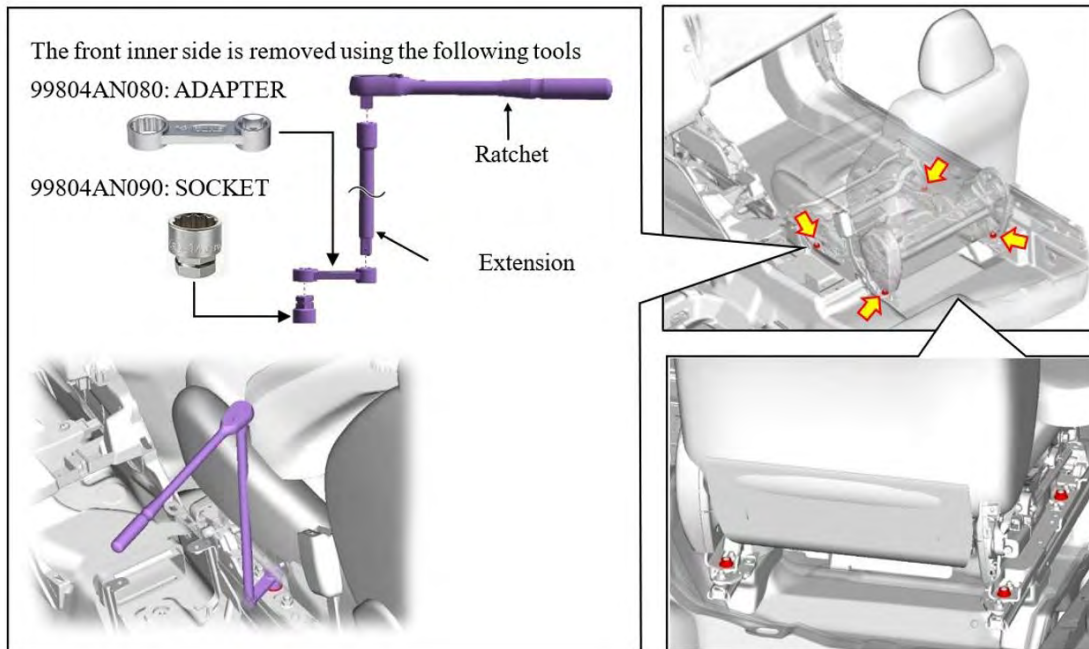

**NOTE:** In rare instances, the stud attached to the ODS sensor may spin when attempting to remove the nut. If this occurs, remove the 8mm nuts (shown in red in the image below) securing the ODS sensors to the seat frame.

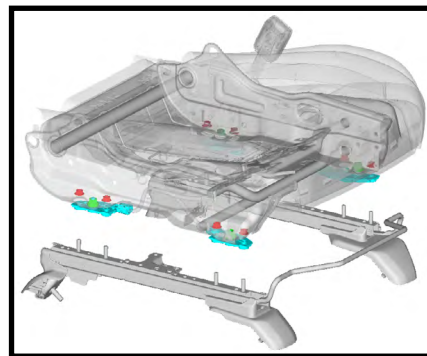

Attach a 19mm twist socket and ratchet to the bottom portion of the stud to prevent it from spinning, then remove the nut securing the ODS sensor to the seat bottom.

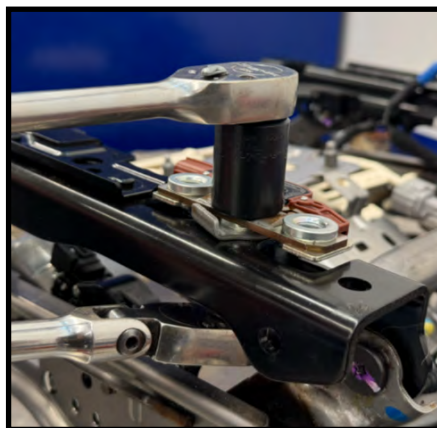

*Continued...*

Caution: On power seats, it is not possible to access the back side of the stud on the front inner ODS sensor. If this stud begins to spin, the seat bottom assembly will need to be replaced.

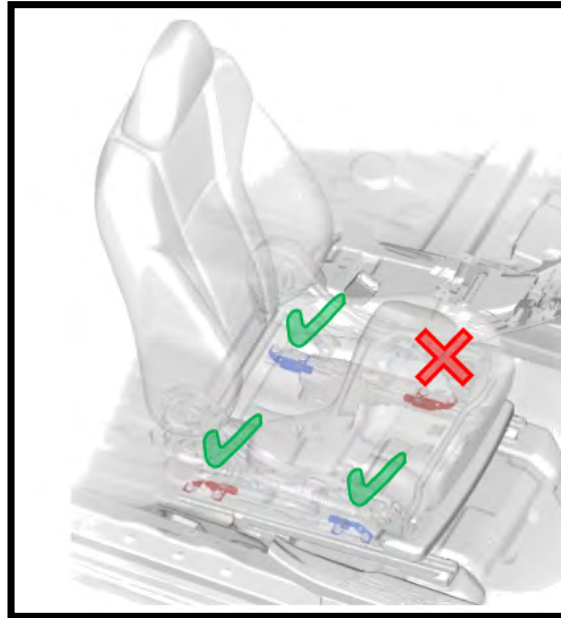

**STEP 15:** CAREFULLY raise the front of the seat assembly 35-40mm (1.4 to 1.6 inch). Insert both of the pre-prepared blocks between the cushion frame and the seat rail.

**CAUTION**

- DO NOT damage the slide sensor when inserting the block into the outer rail.
- Pay close attention to the seat harness when lifting the cushion frame. Excessive tension may cause damage to the harness.

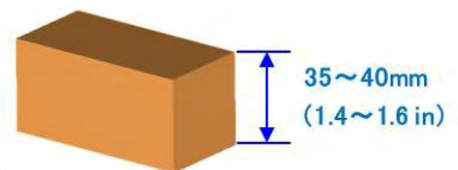
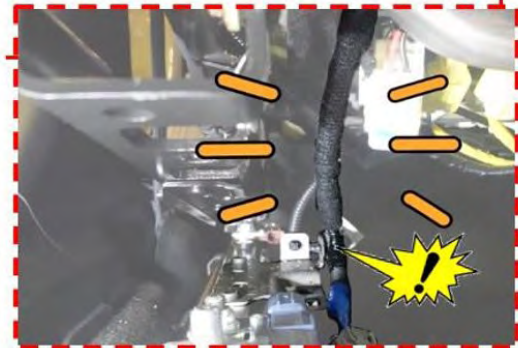
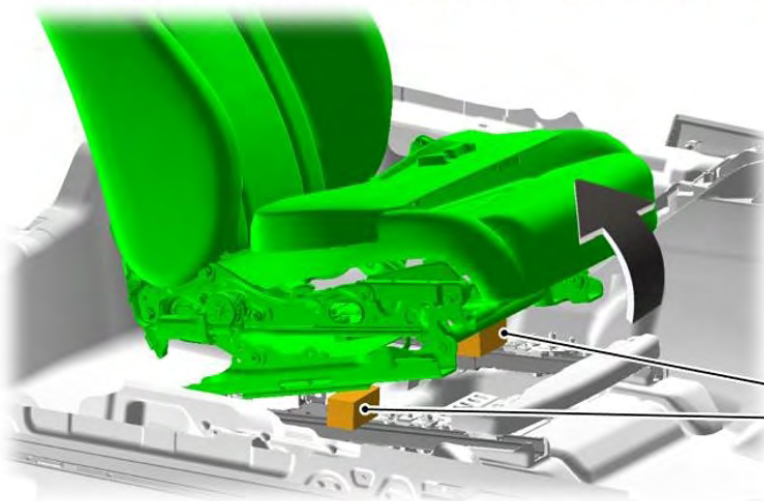

*Continued...*

**STEP 16:** Remove and discard the four 12mm (M8) sensor mounting nuts. Remove the protective washers and set aside. The two sensors can then be removed and discarded.

**IMPORTANT: DO NOT** discard the protective washers. These are to be re-used.

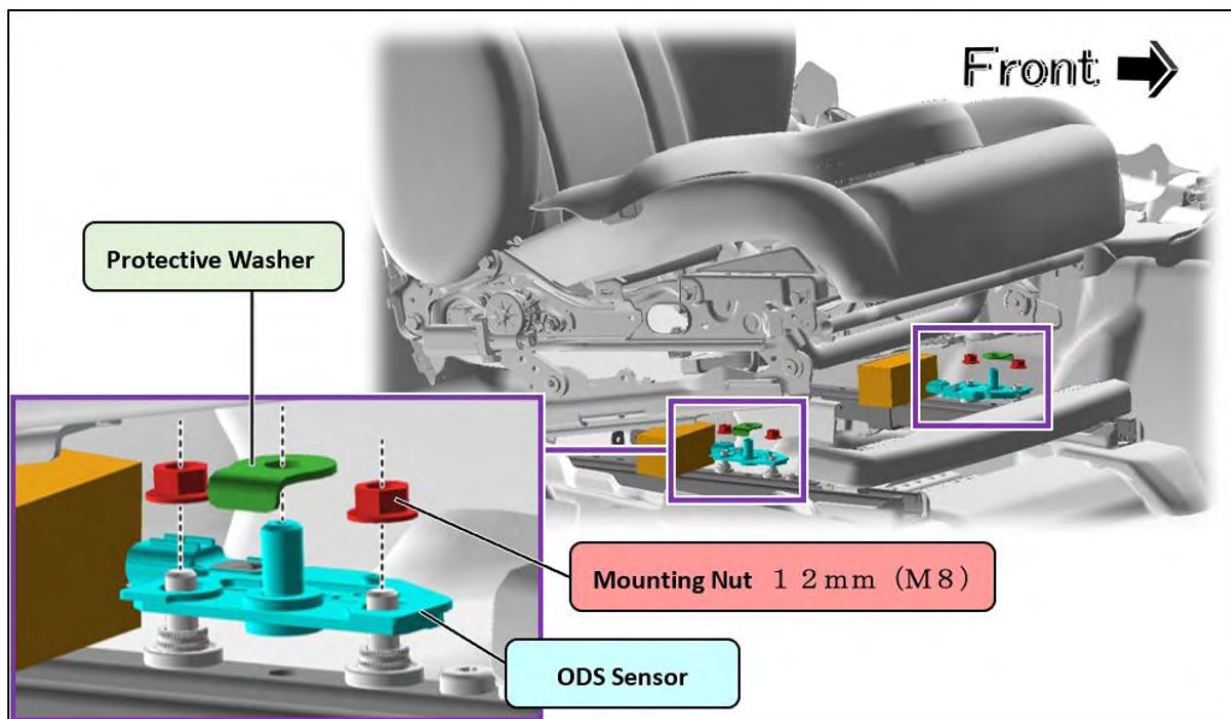

**STEP 17:** Confirm the identification numbers of the NEW Occupant Detection Sensors are #1 and #2. Mount the #1 (**Brown**) sensor to the inner front position and the #2 (**Blue**) sensor to the outer front position. Torque the NEW sensor mounting nuts (p.n. 64157AN02A) to 25Nm (18.5ft-lbs).

**NOTE:** Take special care in handling the new sensors.

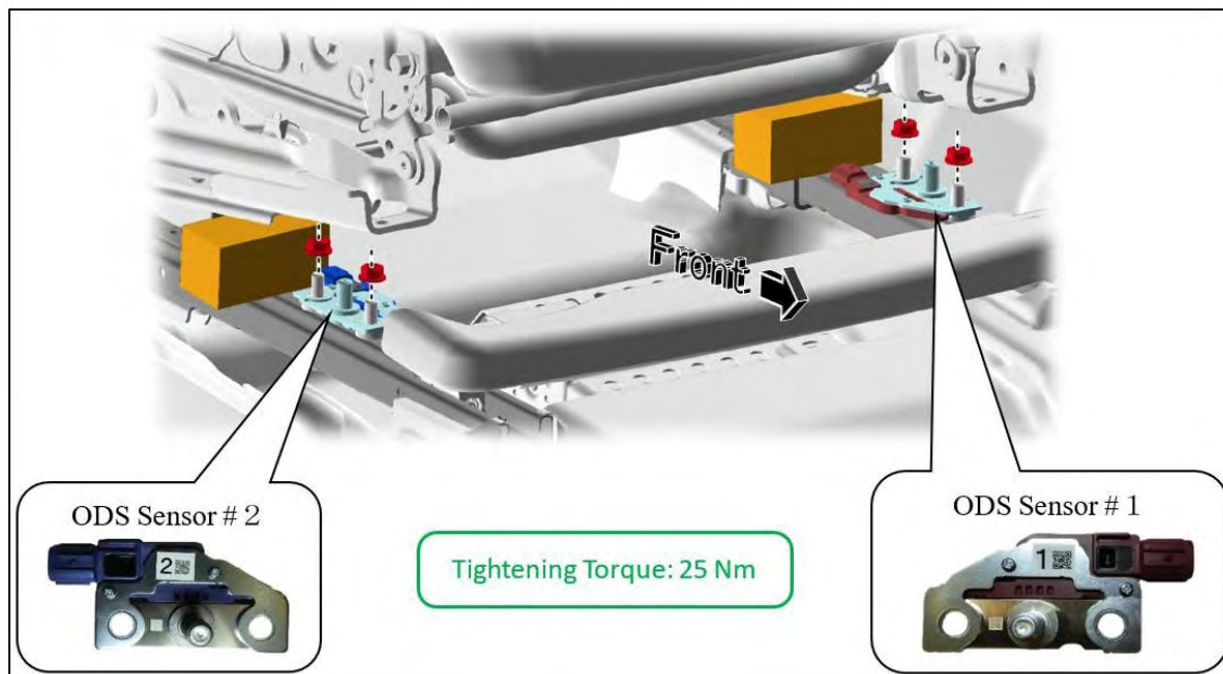

*Continued...*

**STEP 18:** Install the protector washers with the WRA-24 JIG tool (p.n. 99804AN100) along the rail side. See the images below.

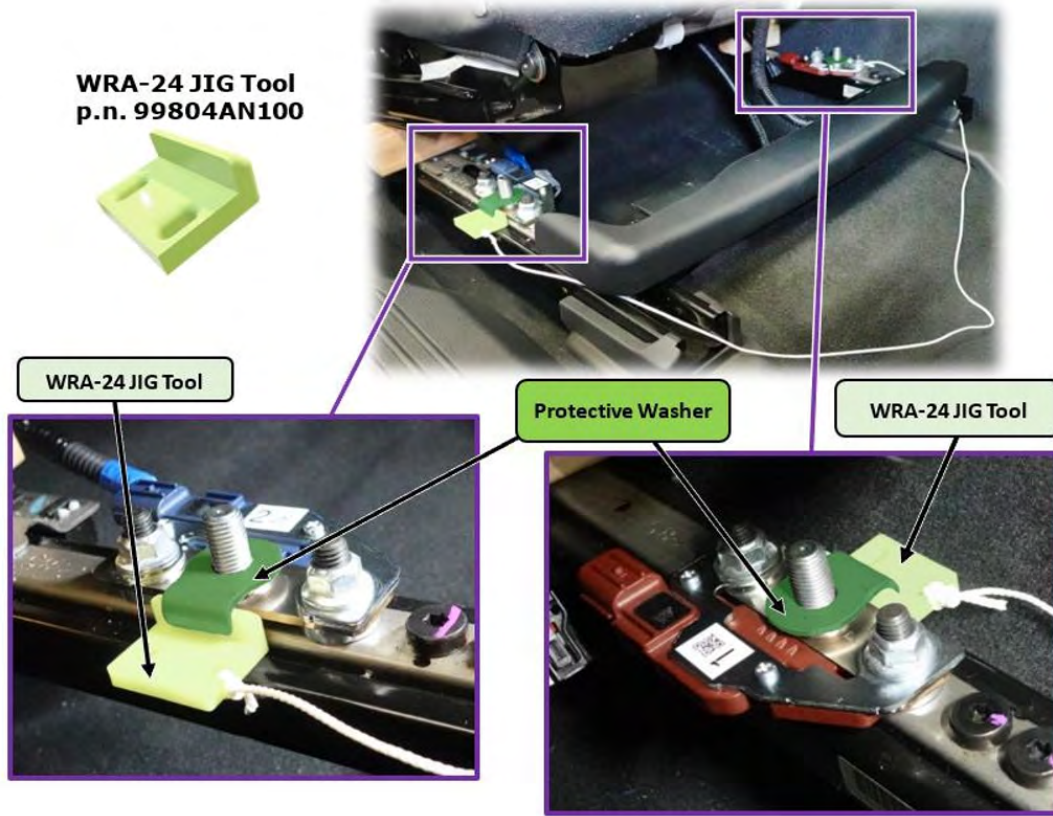

**STEP 19:** Tuck the connector of sensor sensors into the cushion frame. Remove the blocks and CAREFULLY lower the cushion frame.



**CAUTION:** It is possible for the connector to be caught between the cushion frame and the rail/sensor. Confirm the connector is not pinched in any way.

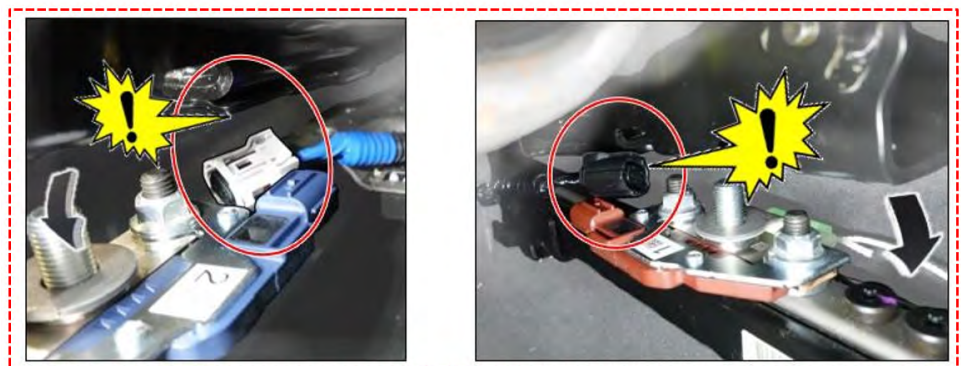

*Continued...*

**STEP 20:** Remove the four 12mm (M8) rear sensor mounting nuts. Discard the nuts after removal.

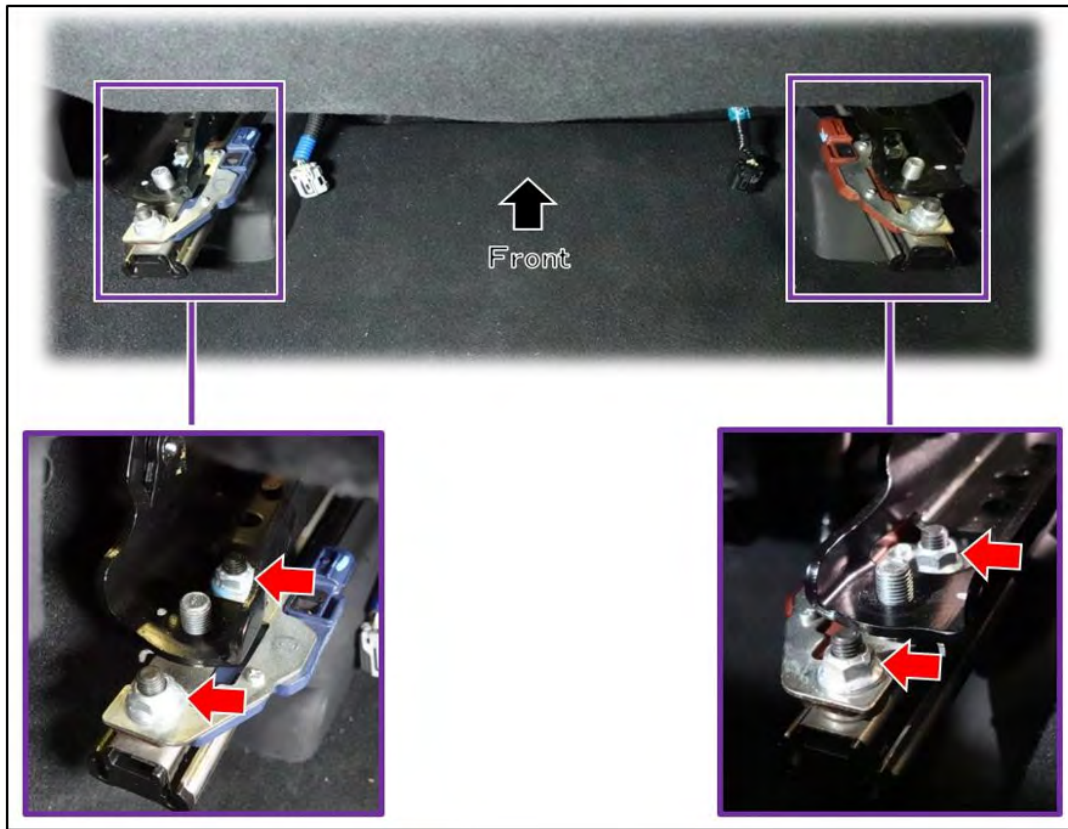

**STEP 21:** CAREFULLY raise the rear of the seat assembly 35-40mm (1.4 to 1.6 inch). Insert both of the pre-prepared blocks between the cushion frame and the seat rail.

**CAUTION**

- DO NOT damage the slide sensor when inserting the block into the outer rail.
- Pay close attention to the seat harness when lifting the cushion frame. Excessive tension may cause damage to the harness.

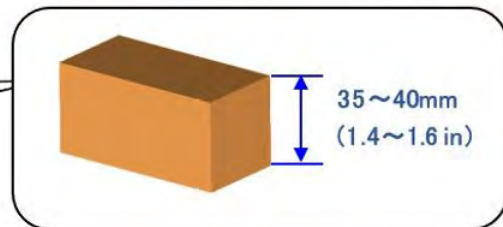
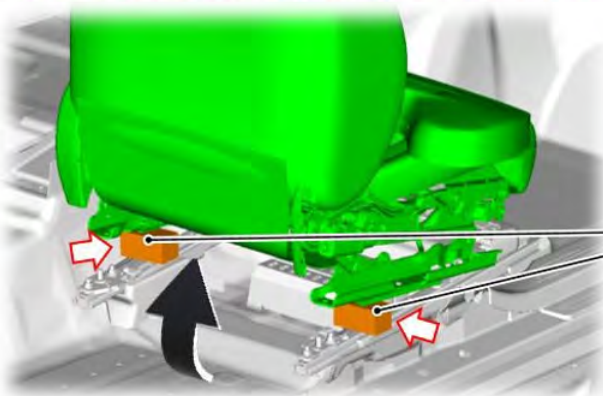

*Continued...*

**STEP 22:** Remove and discard the four 12mm (M8) sensor mounting nuts. Remove the protective washers and set aside. The two sensors can then be removed and discarded.

**IMPORTANT:** DO NOT discard the protective washers. These are to be re-used.

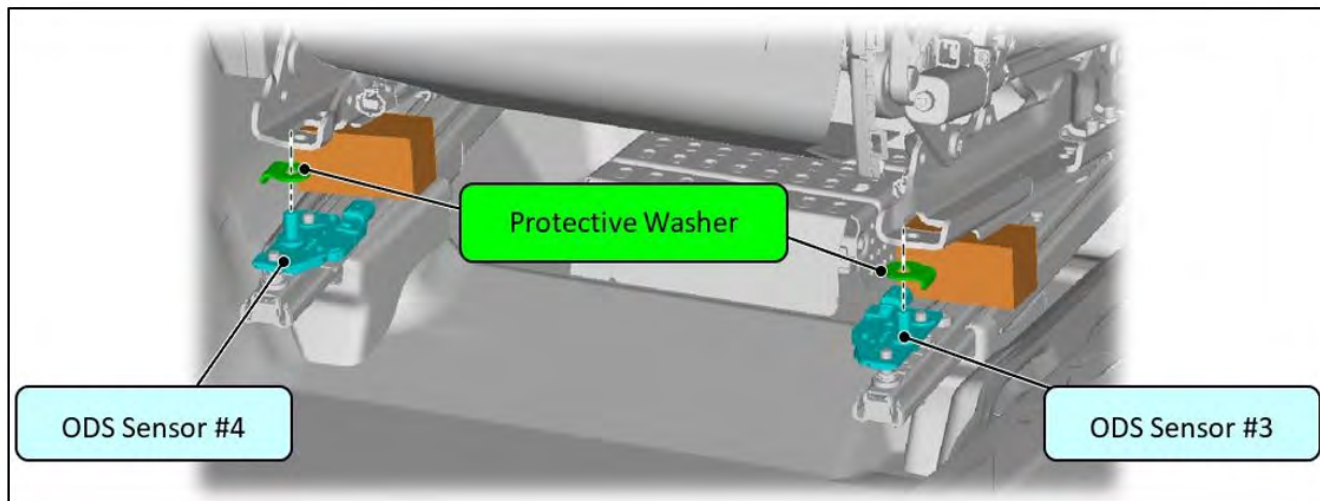

**STEP 23:** Confirm the identification numbers of the NEW Occupant Detection Sensors are #4 and #3. Set the #4 (Blue) sensor to the inner rear position and the #3 (Brown) sensor to the outer rear position. **DO NOT** install the mounting nuts at this time.

**NOTE:** Take special care in handling the new sensors.

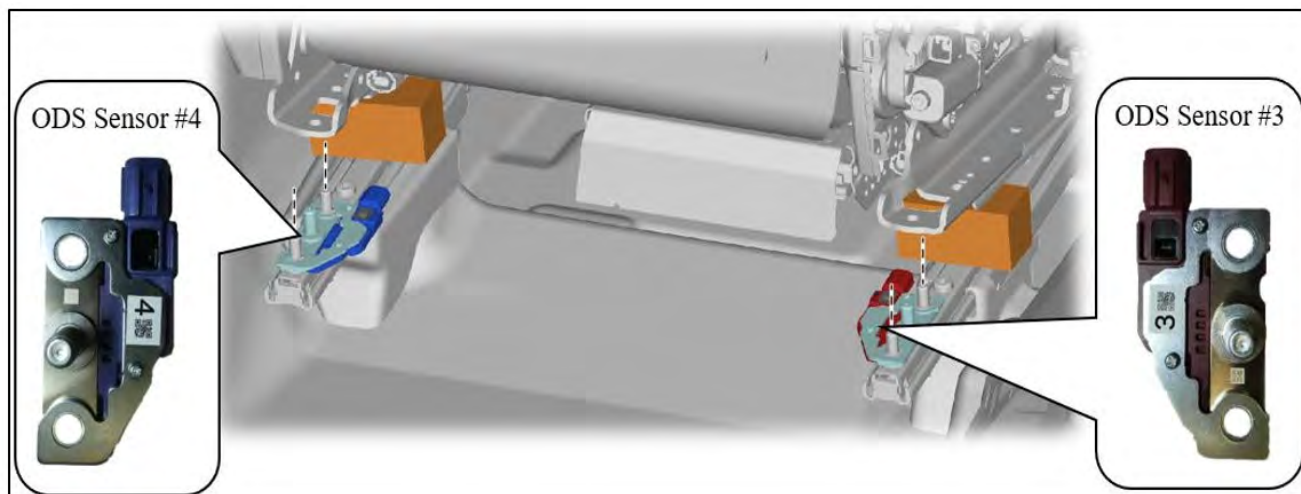

*Continued...*

**STEP 24:** Install the protector washers with the WRA-24 JIG Tool (p.n. 99804AN100) along the rail side. See the images below.

**CAUTION:** Avoid contact with the WRA-24 JIG Tool and the bolt cover.

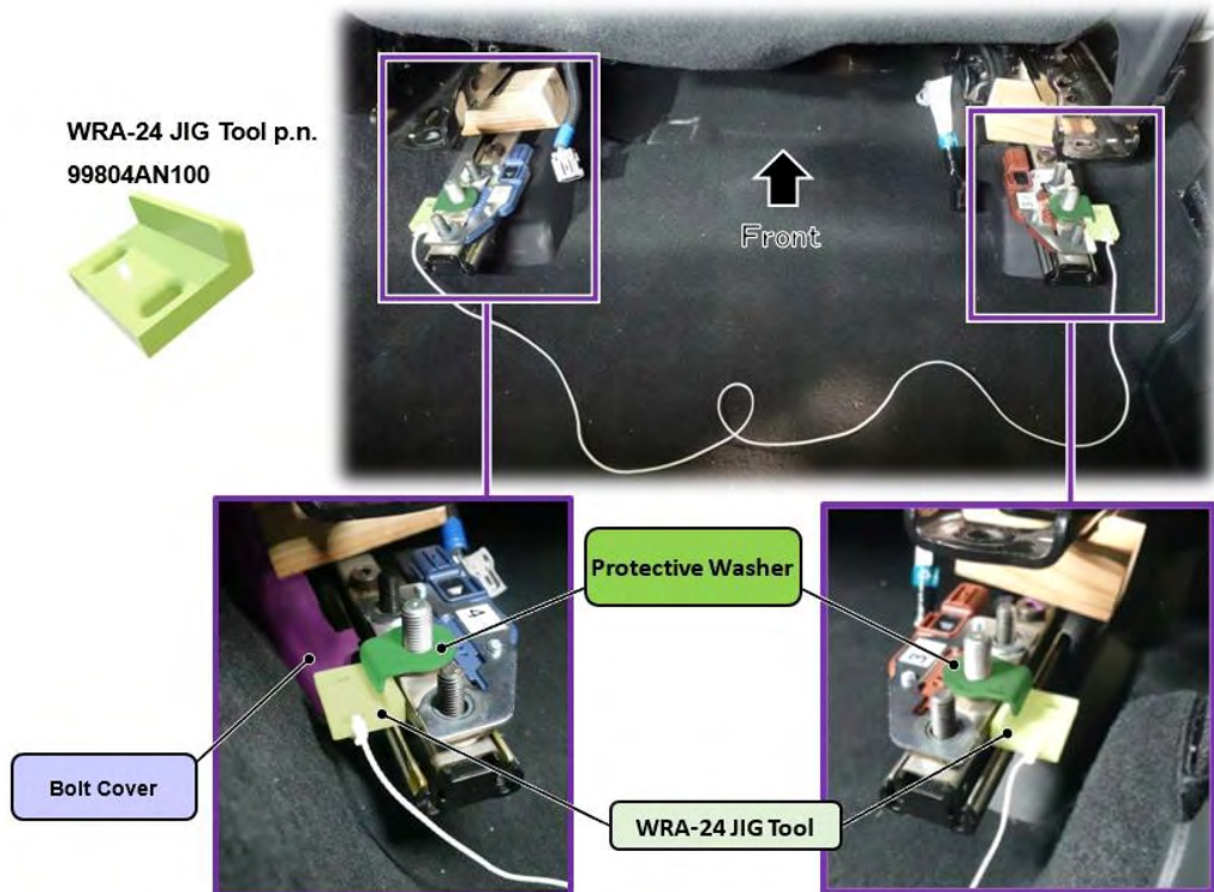

**STEP 25:** Remove the blocks and CAREFULLY lower the cushion frame.

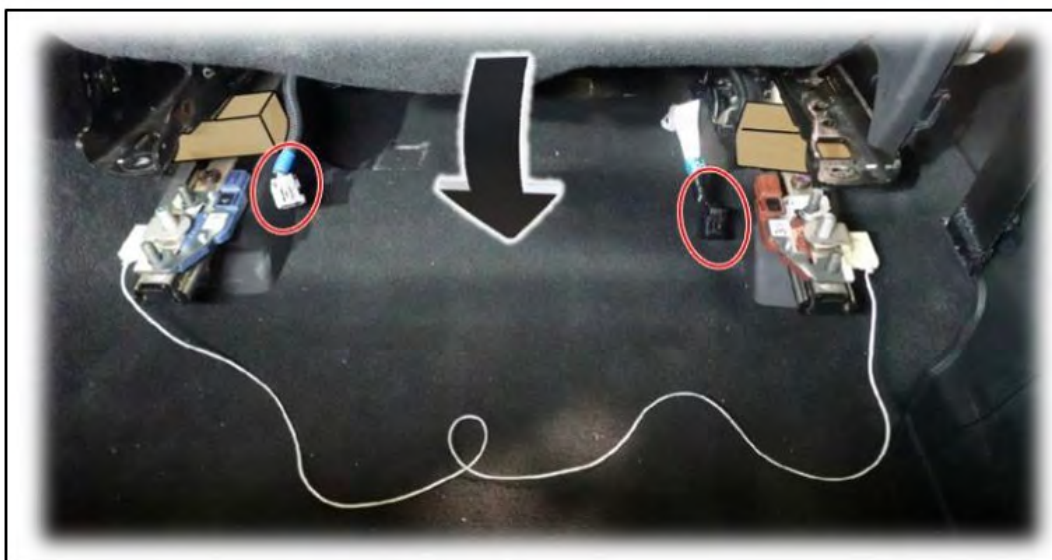

*Continued...*

**CAUTION:** It is possible for the connector to be caught between the cushion frame and the rail/sensor. Confirm the connector is not pinched in any way.

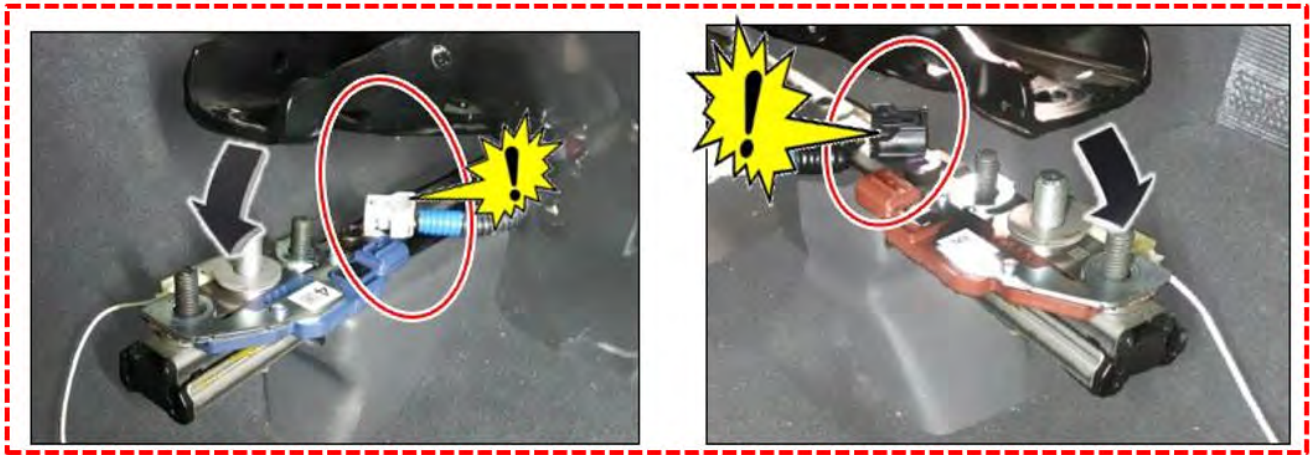

**STEP 26:** Install and torque the NEW sensor mounting nuts (p.n. 64157AN02A) to 25Nm (18.5ft-lbs).

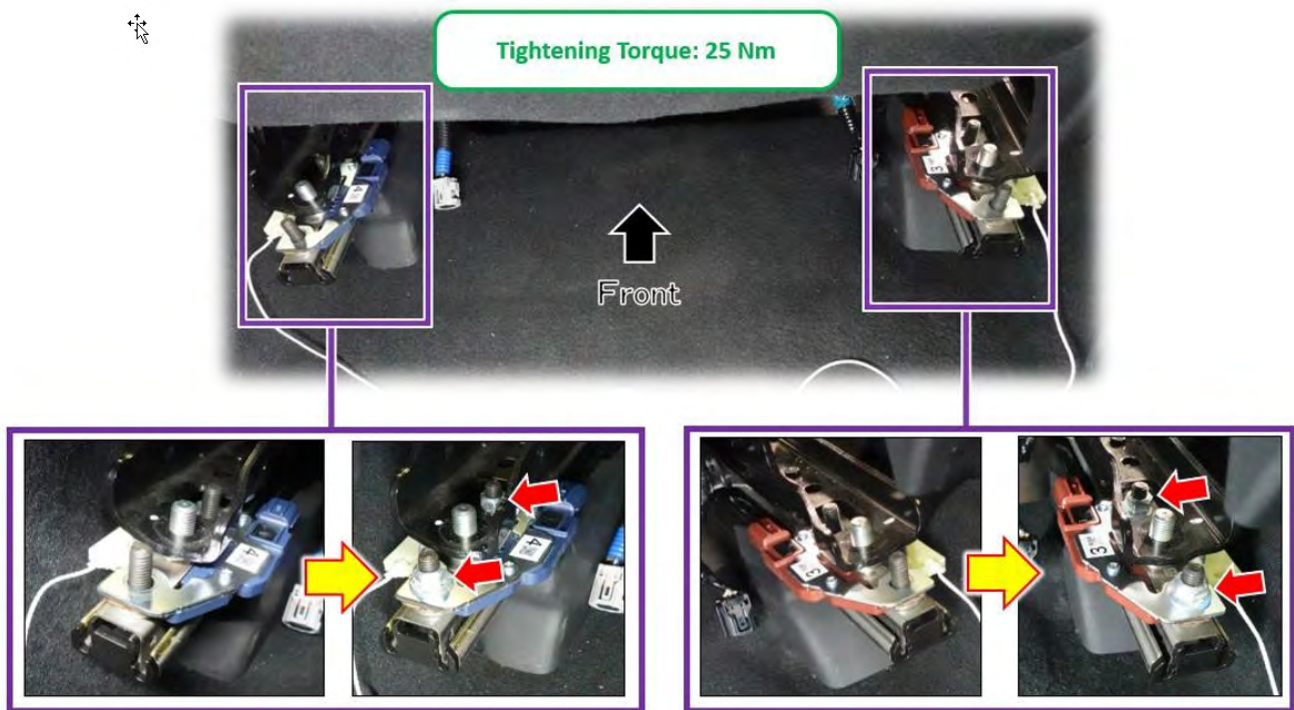

*Continued...*

**STEP 27:** Secure the cushion frame with the four new mounting nuts (p.n. 64157AN00A). Torque the mounting nuts to 37Nm (27ft-lbs).

**NOTE:** An extension, special socket (p.n. 99804AN090), and the adapter (p.n. 99804AN080) is to be used when torquing the inner front mounting nut.

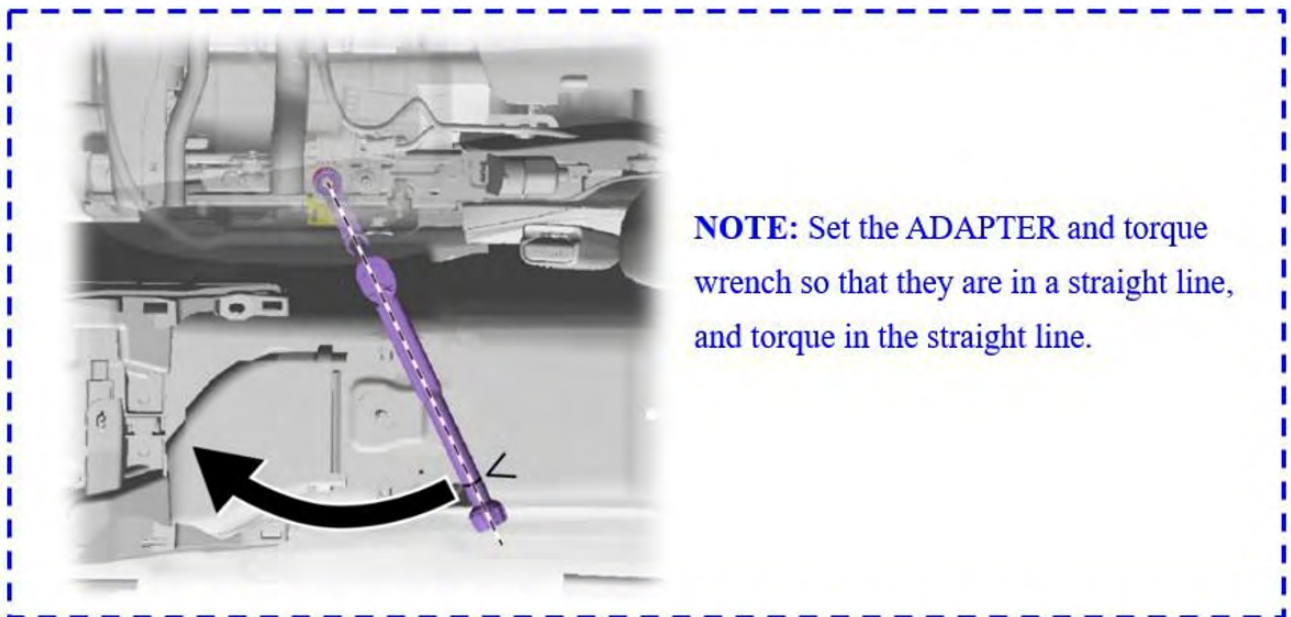
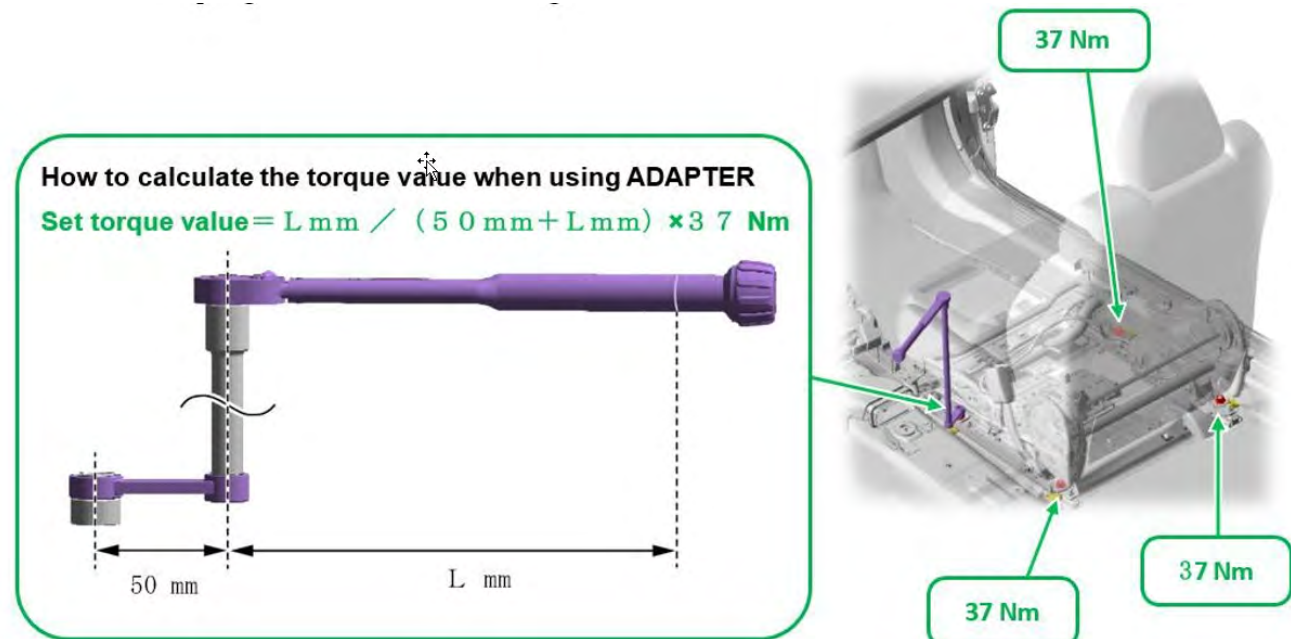

*Continued...*

**STEP 28:** Remove both sets of the WRA-24 JIG Tool by pulling the attached strings away from the seat. This will cause the pieces to slide off the rails.

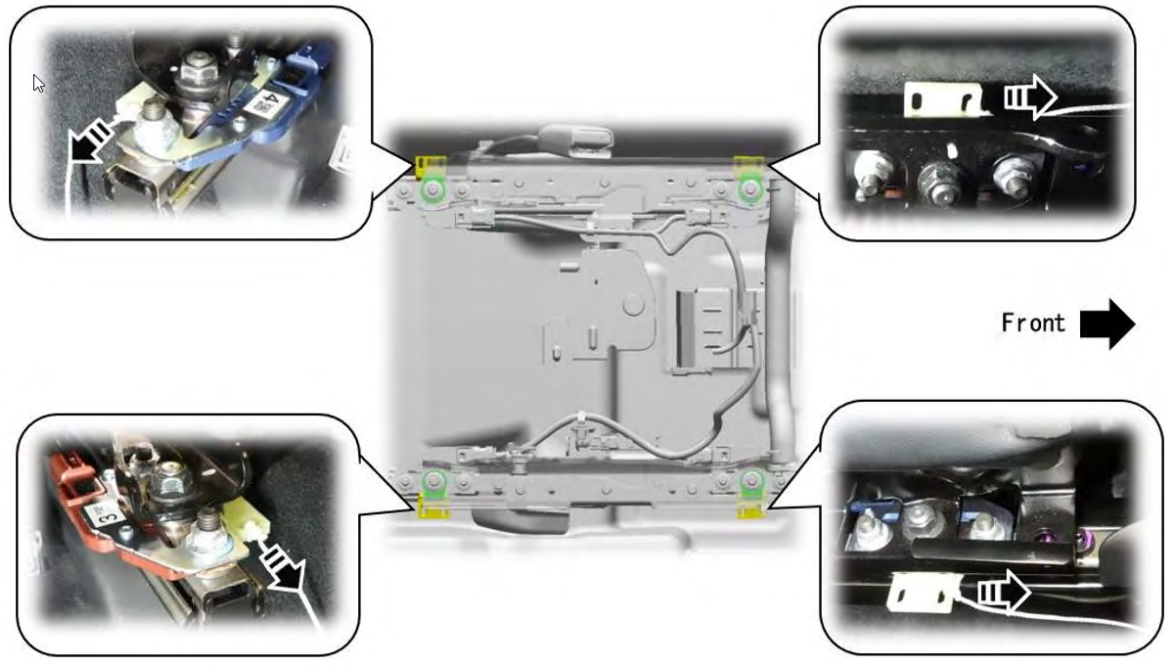

**STEP 29:** Confirm all the sensors are in the associated positions.

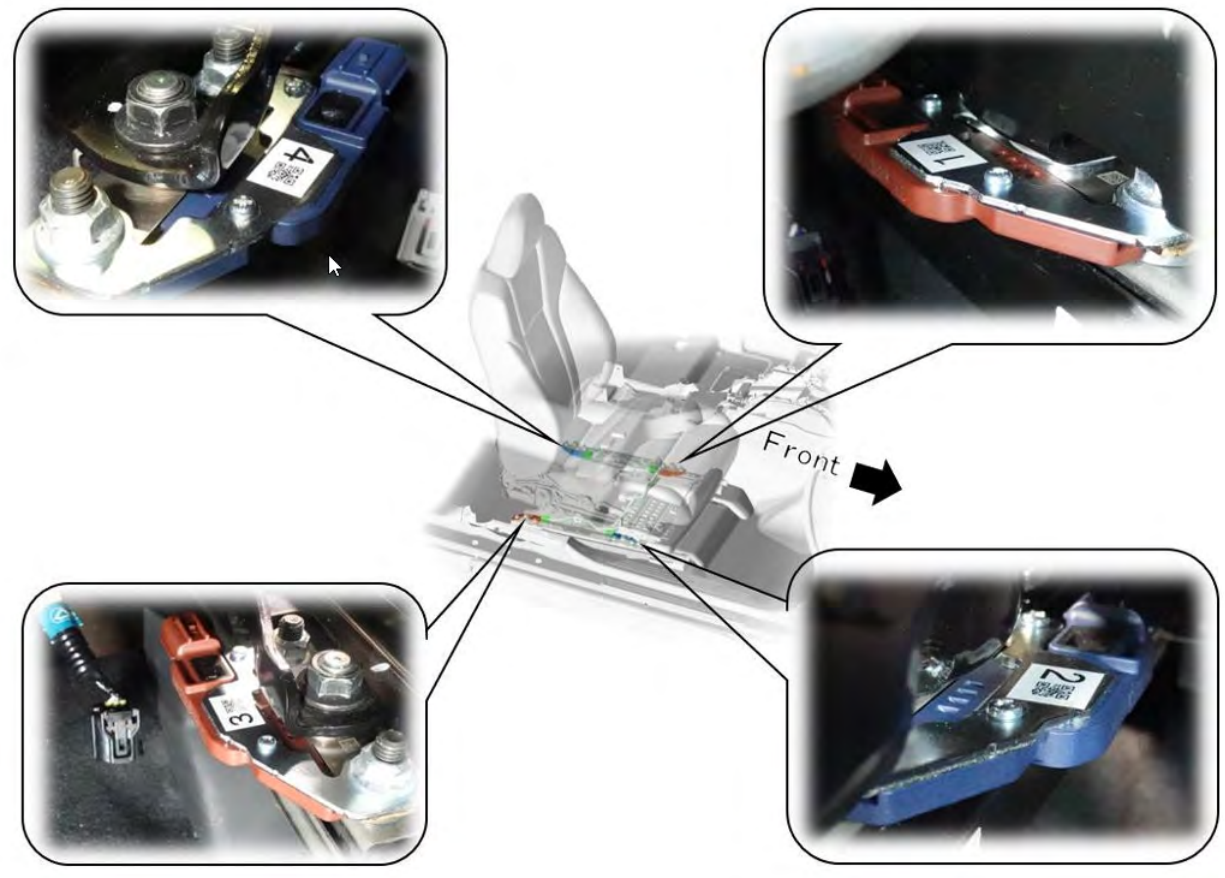

*Continued...*

**STEP 30:** Reconnect all four ODS sensor connections.

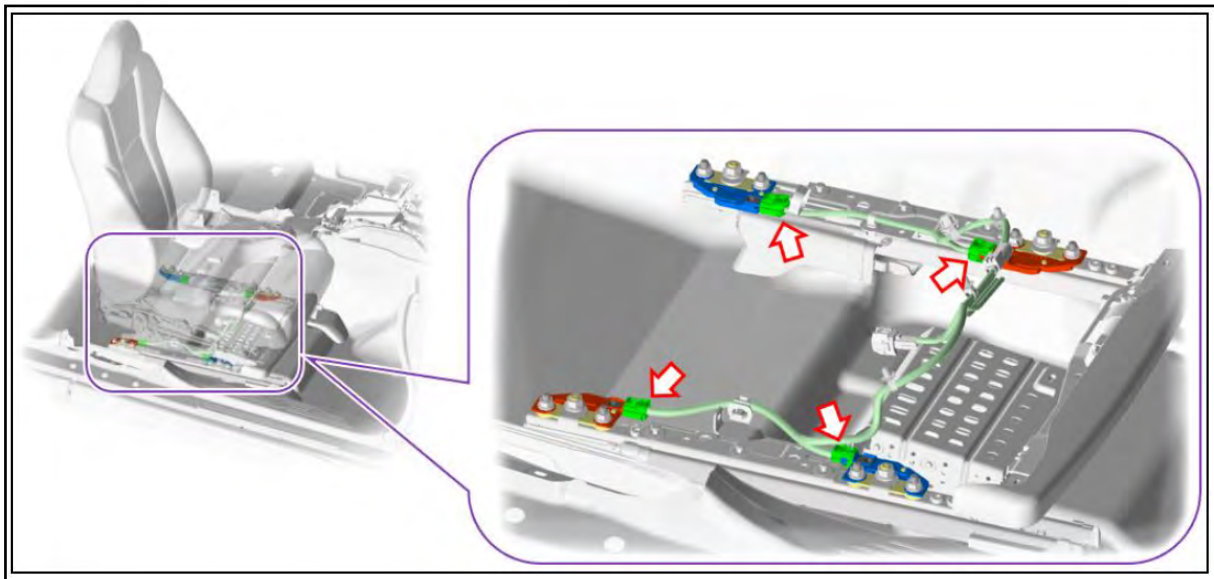

**STEP 31:** Reinstall the outside hinge cover.

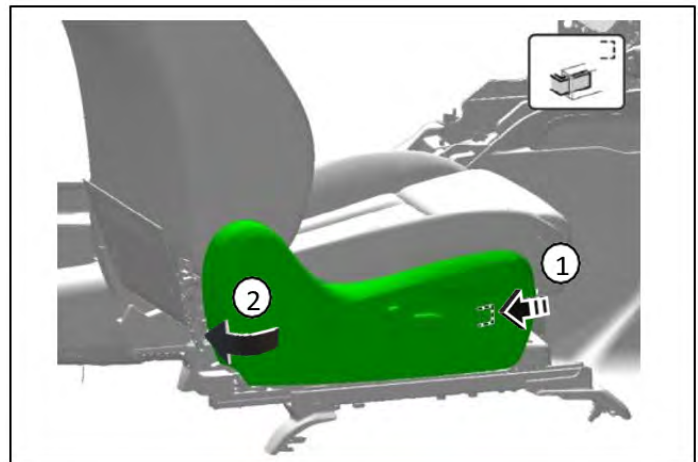

**STEP 32:** Reinstall the inner and outer rear hinge cover.

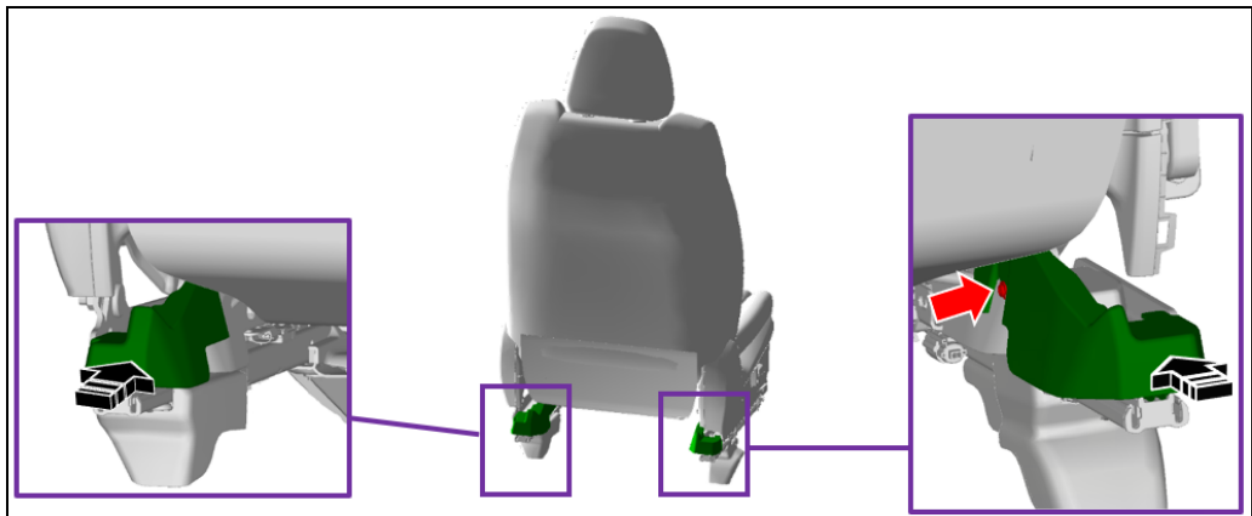

**STEP 33:** Reinstall the center console and gear selector cover.

*Continued...*

**STEP 34:** Reinstall the fuses.



**STEP 35:** Sit on the front passenger seat and slightly move around while adjusting the positions.



**STEP 36:** Using the SSM4, perform the “Rezeroing” procedure as per the applicable Service Manual.

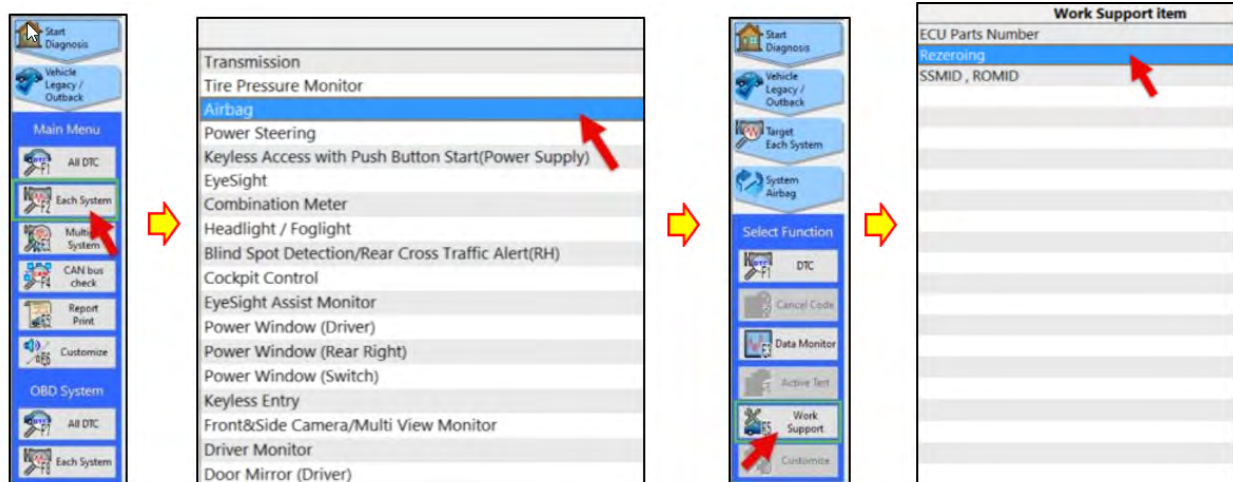

*Continued...*

**STEP 37:** Once the “Rezeroing” procedure is successfully completed, you will be prompted to start a “Sensitivity Check”. Click the “OK” button to continue.

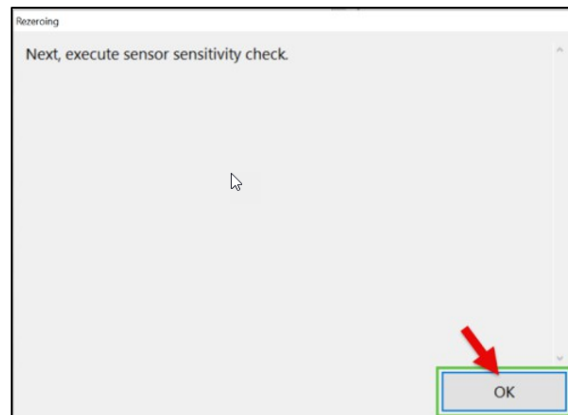

**STEP 38:** Confirm the seat and backrest are adjusted fully forward. Install both components of special tool #J-47673.



**STEP 39:** Input 80.0 lbs. Click the “OK” button to continue.

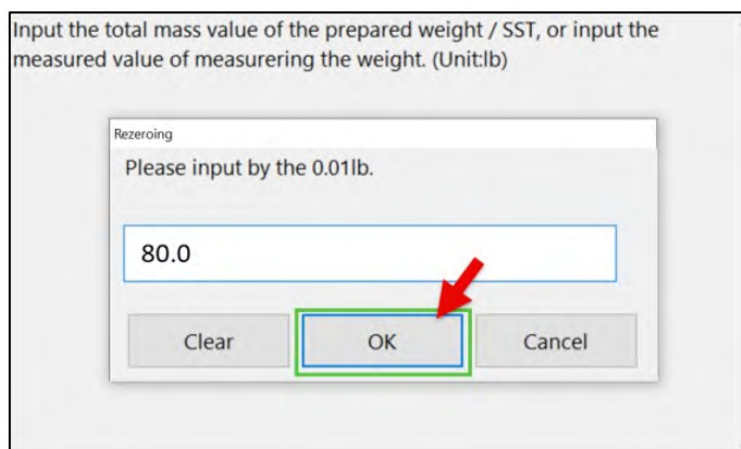

*Continued...*

**STEP 40:** Once the “Sensitivity Check” is successfully completed, check the following data monitors: Front-Left Sensor Load Value, Front-Right Sensor Load Value, Rear-Left Sensor Load Value, Rear-Right Sensor Load Value.

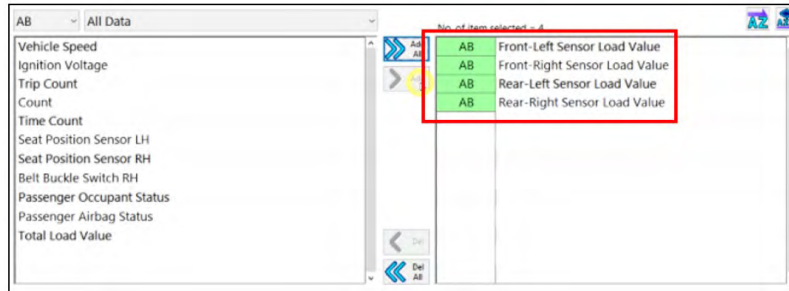

**STEP 41:** While sitting in the passenger rear seat, pull the backrest toward the rear of the vehicle and monitor the values. The front sensors should have a negative (-) value and the rear sensors should have a positive (+) value.

**CAUTION: DO NOT** push the backrest toward the front of the vehicle at any point. This will cause an inaccurate reading.

Item	Value	Unit	Maximum	Minimum	Average
AB Front-Left Sensor Load Value	-37.75	kg	-0.13	-37.75	-4.97
AB Front-Right Sensor Load Value	-35.90	kg	0.22	-35.90	-4.60
AB Rear-Left Sensor Load Value	45.33	kg	45.33	0.09	6.39
AB Rear-Right Sensor Load Value	35.23	kg	35.23	-0.31	4.53



Item	✓	✗		
	Case1	Case2	Case3	Case4
Value	Value	Value	Value	Value
Front-Left Sensor Load Value	- 37.75	45.33	- 37.75	45.33
Front-Right Sensor Load Value	- 35.90	35.23	45.33	- 37.75
Rear-Left Sensor Load Value	45.33	- 37.75	- 35.90	35.23
Rear - Right Sensor Load Value	35.23	- 35.90	35.23	- 35.90

**IMPORTANT:** In a case when the values do not match the desired specification, it possible the sensor mounting position is incorrect.

**STEP 42:** Once the values are confirmed. Save the data. Perform a DTC check and clear all fault codes. Confirm there are no current fault codes.

**NOTE:** DTC B14A1 (Sunload Sensor Circuit Low/Open) may be read as a current DTC but this is a normal condition.

**STEP 43:** Disconnect all battery charging equipment.



**IMPORTANT:** A detailed video of this Service Procedure can be viewed by accessing the following link:

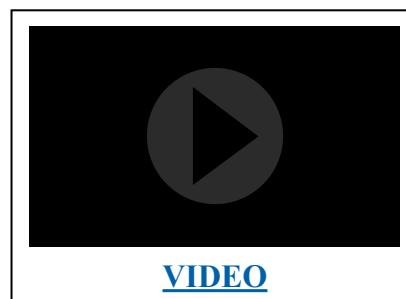

**END OF POWER SEAT SERVICE PROCEDURE/INFORMATION**

*Continued...*

**SERVICE PROGRAM IDENTIFICATION LABEL:**

Type or print the necessary information on a Campaign Identification Label. The completed label should be attached to the vehicle’s upper radiator support. Additional labels are available through normal parts ordering channels. The part number is **MSA6P1302**, which comes as one sheet of 20 labels.

Part Number	Applicability	Description	Order Quantity
MSA6P1302	All Models	Campaign Completion Labels (contains one sheet of 20 labels)	1

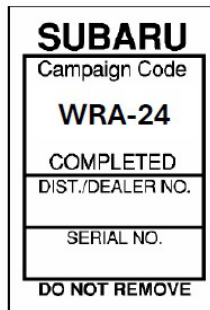

**CLAIM REIMBURSEMENT AND ENTRY PROCEDURES:**

Credit to perform this recall will be based on properly completed repair order information. Retailers may submit claims through [Subarunet.com](http://Subarunet.com).

MANUAL SEAT			
Labor Description	Labor Operation #	Labor Time	Recall Code
WRA-24 ODS SENSOR SET R&R	A100-579	1.1	WRA-24

POWER SEAT			
Labor Description	Labor Operation #	Labor Time	Recall Code
WRA-24 ODS SENSOR SET R&R	A100-579	.9	WRA-24

**IMPORTANT REMINDERS:**

- SOA strongly discourages the printing and/or local storage of service information as previously released information and electronic publications may be updated at any time.
- Always check for any open recalls or campaigns anytime a vehicle is in for servicing.
- Always refer to STIS for the latest service information before performing any repairs.

*Continued...*



**To:** All Subaru Retailers  
**From:** SubaruofAmerica,Inc. –ServiceQuality  
**Date:** May19,2025  
**Re:** **WRA-24ODSSensorReplacementFAQs,UsedVehicleInventory &CPO**

---

As we continue phased owner notification for the WRA-24 ODS Sensor Replacement recall, with owner notifications going out to affected 2020 Outback models, we have made some updates to the WRA-24 related processes and frequently asked questions. Some of the updates include:

- All Legacy and 2020 Outback models affected by the WRA-24 recall are currently in an “Open” status.
- Updates to the processes to handle each of the WRA-24 scenarios a retailer might encounter ([Question 9](#)).
- Updates to the process for [CPO](#) and [Used Vehicle Inventory](#) affected by the WRA-24 recall.

Additional updates have been highlighted throughout this document. Please review this document in its entirety and refer to this document as a consistent means of communicating with customers.

## Frequently Asked Questions

### 1. QUESTION: WHAT IS AN OCCUPANT DETECTION SYSTEM (ODS)?

Answer: The Occupant Detection System determines the occupant’s presence and status in the passenger seat to enable or disable the passenger side airbag from deployment in an accident

### 2. QUESTION: WHAT IS THE REASON FOR THE RECALL?

Answer: Vehicles affected by this recall may be equipped with defective Occupant Detection System (ODS) sensors on the front passenger seat. If the defect exists, a short circuit of the ODS sensors may occur, causing the SRS airbag system warning lamp to illuminate. At the same time, the front passenger’s airbag OFF indicator will also illuminate, indicating that the front passenger airbag may not deploy in certain crashes as designed, increasing the risk of injury to an occupant in the seat.

### 3. QUESTION: DOES THIS RECALL AFFECT ALL 2020-2022 MY LEGACY AND OUTBACK MODELS?

Answer: No. Not all 2020-2022 MY Legacy and Outback models are affected by this recall. Coverage will be confirmed by using the Vehicle Inquiry function on [Subarunet.com](#). A total of 118,723 U.S. vehicles have been affected by this recall. Vehicles not included in the recall are equipped with ODS sensors using a printed circuit board (PCB) that is not affected under this recall.

### 4. QUESTION: WHAT IS THE RECALL REMEDY?

Answer: Subaru retailers will replace all four of the ODS sensors on the front passenger seat with new ones and the necessary hardware at no cost to the customer.

*Continued...*

**5. Question: When will customer notifications begin?**

Answer: Subaru previously notified all affected vehicle owners of this recall with an interim letter by first class mail on May 17, 2024, advising them they would be re-notified with a follow up letter to schedule an appointment once parts became available. Subaru is currently receiving a limited number of ODS sensors and hardware kits to remedy this recall. To maximize completions of the recall while preventing a potential stock- out situation, Subaru will re-notify affected vehicle owners in small, controlled phases as described below:

Mailing Date	Group
02/03/2025	All Legacy models
05/19/2025	All 2020 Outback models
Estimated Q1 2026	2021-2022 Outback models
Estimated Q2 2026	2021-2022 Outback models

We will update you on timing of owner notification letters for subsequent phases as inventory of the remedy parts continues to arrive.

**6. QUESTION: AS THE OWNER NOTIFICATION PHASES OCCUR, HOW WILL A RETAILER KNOW WHETHER A WRA-24 RECALL CAN BE PERFORMED ON AN AFFECTED VEHICLE?**

Answer: As each owner notification for each phase is announced, the recall status for the vehicles included in the phase will change from “Open-Remedy not yet available” to “Open”. Retailers can perform the WRA-24 recall on any vehicle showing an “Open” status when running a VIN Inquiry on Subarunet.

**NOTE: The phasing schedule plan is based on the number of vehicles in each phase and the expected parts inventory. To ensure we are able to efficiently phase this recall as planned, it is imperative that retailers do not perform the WRA-24 recall on any vehicle where the recall status is “Open- Remedy not yet available”.**

If you encounter an affected vehicle in an “Open-Remedy not yet available” status and the customer is experiencing illumination of the SRS light, please refer to question 9, scenario 2 for additional information.

If the vehicle is used inventory or a Certified Pre-owned vehicle, please refer to the separate instructions titled “Used Vehicle Inventory Process” or “Procedure to CPO vehicles affected by the WRA-24 recall” in this announcement.

**7. QUESTION: WHAT IS THE REPAIR PROCEDURE FOR THE WRA-24 RECALL?**

Answer: For vehicles with an “Open” WRA-24 status, the recall repairs can be performed as outlined in the WRA-24 Recall Bulletin on STIS. The remedy repair will involve replacement of the 4 ODS sensors on the passenger side seat, as well as some hardware replacement. WRA-24 training videos will also be part of the required learning for technicians on STAR-U. Videos of the repair procedures are also embedded in the Recall Bulletin on STIS.

If you encounter an affected vehicle in an “Open- Remedy not yet available” status and the customer is not experiencing illumination of the SRS light, let the owner know that they will receive owner notification when parts are available to perform the remedy repair on their vehicle.

**NOTE: The remedy repair should only be performed on affected vehicles with the WRA-24 in an “Open” status.**

**8. QUESTION: WHAT IF A CUSTOMER VEHICLE DOES NOT HAVE A CURRENT FAILURE (NO SRS LIGHT ILLUMINATED), BUT THE CUSTOMER FEELS UNSAFE DRIVING THE VEHICLE?**

*Continued...*

**Answer:** There is NO risk to the driver of the vehicle; this recall affects only the front passenger side air bag. Additionally, a safety risk to the front passenger exists only if the SRS light is illuminated. Please reassure the customer that if the SRS light is not illuminated, then the ODS sensors are operating as designed and there is no need to take any action until Subaru notifies the customer that parts are available. **IMPORTANT NOTE:** Customers are eligible for alternate transportation only if the SRS light is illuminated.

If the ODS sensor failure occurs, the SRS light will illuminate. Please refer to question 9 for additional information.

**9. QUESTION: WHAT IF A CUSTOMER VEHICLE EXPERIENCES THE ODS SENSOR FAILURE (SRS LIGHT ILLUMINATES)?**

SRS airbag warning light:



**Answer:** If an ODS sensor failure occurs, the SRS light will illuminate. The customer should be instructed that if the SRS light illuminates, then any passenger in the front passenger seat should move to the rear seat, and they should avoid using the front passenger seat until the vehicle is inspected and repaired by the retailer.

There are a few different scenarios that the retailer can encounter. Please follow the instructions based on the relevant scenario:

**Scenario 1:** WRA-24 vehicle in an “Open” status, regardless of SRS illumination (affected Legacy models and 2020 Outback models)

Please refer to the WRA-24 Recall bulletin on STIS for the repair procedure to replace the ODS Sensor Kit and the related hardware kit. **The remedy repair should be performed on any vehicle with an “Open” status, regardless of whether the SRS light is illuminated.**

**Scenario 2:** WRA-24 vehicle in an “Open Remedy not yet available” status that has the SRS light illuminated (affected 2021-2022 Outback models)

Should a customer bring their vehicle in with the SRS light illuminated, and their WRA-24 recall status is “Open- Remedy not yet available”, the technician should first pull all DTCs.

If DTC B1788 is present, then the ODS sensor failure has occurred, and the retailer should order the appropriate seat bottom to resolve the concern. The retailer should order the appropriate seat bottom for the vehicle. It is no longer necessary to submit a QMR to obtain a seat bottom.

64139AN00A CUSHION AY OCPANTRH  
64139AN01B CUSHION AY OCPANTRH  
64139AN02B CUSHION AY OCPANTRH

If DTC B1788 is not present, then refer to the applicable service manual and perform diagnostics, noting all key steps and results. If the DTC diagnostic results leads to a seat bottom replacement, the retailer should order the appropriate seat bottom for the vehicle. It is no longer necessary to submit a QMR to obtain a seat bottom.

**NOTE: A seat bottom should ONLY be used for 2021 and 2022 Outback models affected by the WRA-24 recall in an “Open-Remedy not yet available” status with the DTC B1788 or a related DTC where diagnostics lead to a seat bottom replacement as outlined above.**

*Continued...*

If the vehicle is part of the WRA-24 recall and the retailer replaces a seat bottom, then a Recall Claim (RC) must be submitted using the following labor operation:

Recall Code	Labor Operation	Description	Description
WRA24	A100-576	WRA-24 ODS SEATBOTTOM R&R	0.9

Claim data will be monitored and failure to follow this procedure could affect claim payment.

Please note, if you encounter an affected vehicle in an “Open- Remedy not yet available” status and the customer is not experiencing illumination of the SRS light, let the owner know that they will receive owner notification when parts are available to perform the remedy repair on their vehicle.

If the vehicle is used inventory or a Certified Pre-owned vehicle, please refer to the separate instructions titled “Used Vehicle Inventory Process” or “Procedure to CPO vehicles affected by the WRA-24 recall” in this announcement.

Scenario 3: Seat bottom is needed for a non-WRA-24 affected vehicle or an unrelated service issue  
If the vehicle is not affected by the WRA-24 recall or has an unrelated service issue that requires a seat bottom, The retailer should order the appropriate seat bottom for the vehicle. It is no longer necessary to submit a QMR to obtain a seat bottom.

64139AN00A CUSHION AY OCPANTRH  
64139AN01B CUSHION AY OCPANTRH  
64139AN02B CUSHION AY OCPANTRH

## Procedure to CPO vehicles affected by the WRA-24 recall

If you have a used vehicle that is affected by the WRA-24 recall and is in an “Open” status (all Legacy models and 2020 Outback models), please refer to the Recall bulletin on STIS and perform the remedy repair. The process outlined below relates only to used vehicles affected by the WRA-24 recall in an “Open- Remedy not yet available” status (affected 2021-2022 Outback models) that will be considered for CPO certification.

To determine CPO eligibility, the retailer must first run a Carfax on the vehicle to ensure the vehicle does not have a branded title, the vehicle has not been in a moderate to severe accident, and there is no evidence of airbag deployment. If the Carfax report shows evidence of any of these, the vehicle is not able to go through CPO certification and the retailer should refer to the Used Vehicle Inventory process outlined in this announcement.

If the Carfax report is clean, the retailer should then work through the 152-point Certified Pre-Owned Vehicle Inspection Checklist for the vehicle. The retailer should have an accompanying repair order for any work that is done on the vehicle to meet the CPO certification requirements.

If the retailer determines the vehicle is eligible for CPO certification, but has an open WRA-24 recall, the retailer should order the appropriate seat bottom for the vehicle. The seat bottoms below are no longer on hold and should ONLY be used for a CPO eligible vehicle with a WRA-24 recall in an “Open-Remedy not yet available” status (2021-2022 Outback models).

64139AN00A CUSHION AY OCPANTRH  
64139AN01B CUSHION AY OCPANTRH  
64139AN02B CUSHION AY OCPANTRH

*Continued...*

Once the seat bottom is replaced, please submit a WRA-24 recall claim using labor operation 100576 WRA-ODS SEAT BOTTOM R&R for 0.9 hours, with a comment indicating this is a CPO unit.

Once the recall claim is approved, the status of the recall for the VIN will change to Completed. Timely claim entry is very important to keep the process of CPO certification moving forward. Retailers must wait 24 hours after the recall shows completed on the VIN before they can systematically begin certifying one of these vehicles via Subarunet.

**If your vehicle is a CPO, do not proceed beyond this point, follow the submission instructions above.**

## **Used Vehicle Inventory Process**

If you have a used vehicle that is affected by the WRA-24 recall and is in an “Open” status (all Legacy models and 2020 Outback models), please refer to the Recall bulletin on STIS and perform the remedy repair.

For used vehicles affected by the WRA-24 recall in an “Open- Remedy not yet available” status that do not have an SRS light illuminated and do not qualify for the CPO program, a seat bottom can be ordered in scenarios where the retailer has a purchaser for the affected vehicle. The WRA-24 recall should be completed prior to selling the used vehicle. Once the seat bottom is replaced, please submit a WRA-24 recall claim using labor operation 100576 WRA- ODS SEAT BOTTOM R&R for 0.9 hours, with a comment indicating this is a used vehicle inventory vehicle.

*Continued...*

**To:** All Subaru Retailers

**From:** Subaru of America, Inc. – Service Quality

**Date:** February 3, 2025

**Re:** WRA-24 ODS Sensor Replacement FAQs, Used Vehicle Inventory & CPO

---

As we begin phased owner notification for the WRA-24 ODS Sensor Replacement recall, we have updated the list of frequently asked questions and the instruction on how to handle CPO and Used Vehicle Inventory affected by WRA-24. Please refer to this document as a consistent means of communicating with customers.

## ***Frequently Asked Questions***

### **1. Question: What is an Occupant Detection System (ODS)?**

**Answer:** The Occupant Detection System determines the occupant's presence and status in the passenger seat to enable or disable the passenger side airbag from deployment in an accident.

### **2. Question: What is the reason for the recall?**

**Answer:** Vehicles affected by this recall may be equipped with defective Occupant Detection System (ODS) sensors on the front passenger seat. If the defect exists, a short circuit of the ODS sensors may occur, causing the SRS airbag system warning lamp to illuminate. At the same time, the front passenger's airbag OFF indicator will also illuminate, indicating that the front passenger airbag may not deploy in certain crashes as designed, increasing the risk of injury to an occupant in the seat.

### **3. Question: Does this recall affect all 2020-2022 MY Legacy and Outback models?**

**Answer:** No. Not all 2020-2022 MY Legacy and Outback models are affected by this recall. Coverage will be confirmed by using the Vehicle Inquiry function on [Subarunet.com](https://www.subaru.com/subarunet.com). A total of 118,723 U.S vehicles have been affected by this recall. Vehicles not included in the recall are equipped with ODS sensors using a printed circuit board (PCB) that is not affected under this recall.

### **4. Question: What is the recall remedy?**

**Answer:** Subaru retailers will replace all four of the ODS sensors on the front passenger seat with new ones at no cost to the customer.

### **5. Question: When will customer notifications begin?**

**Answer:** Subaru previously notified all affected vehicle owners of this recall with an interim letter by first class mail on May 17, 2024, advising them they would be re-notified with a follow up letter to schedule an appointment once parts became available. Subaru is currently receiving a limited number of ODS sensors and hardware kits to remedy this recall. To maximize completions of the recall while preventing a potential stock-out situation, Subaru will re-notify affected vehicle owners in small, controlled phases as described below:

*Continued...*

Mailing Date	Group
02/03/2025	All Legacy models
Estimated Q2 2025	2020 Outback (manual passenger seat)
Estimated Q3 2025	2020 Outback (power passenger seat)
Estimated Q1 2026	21-22 Outback (manual passenger seat)
Estimated Q3 2026	21-22 Outback (power passenger seat)
Estimated Q4 2026	21-22 Outback (power passenger seat)

We will update you on timing of owner notification letters for subsequent phases as inventory of the remedy parts continues to arrive.

**6. Question: As the owner notification phases occur, how will a retailer know whether a WRA-24 recall can be performed on an affected vehicle?**

**Answer:** As each owner notification for each phase is announced, the recall status for the vehicles included in the phase will change from “Open-Remedy not available” to “Open”. Retailers can perform the WRA-24 recall on any vehicle showing an “Open” status when running a VIN Inquiry on Subarunet.

**NOTE: The phasing schedule plan is based on the number of vehicles in each phase and the expected parts inventory. To ensure we are able to efficiently phase this recall as planned, it is imperative that retailers do not perform the WRA-24 recall on any vehicle where the recall status is “Open- Remedy Not available”.**

If you encounter an affected vehicle in an “Open-Remedy not yet available” status and the customer is experiencing illumination of the SRS light, please refer to question 9, scenario 2 for additional information.

If you encounter an affected vehicle that is eligible to be certified in the CPO program, please refer to the “Procedure to CPO vehicles affected by the WRA-24 recall” section below.

If you encounter an affected vehicle in your used vehicle inventory that does not qualify for the CPO Program, please refer to the “Used Vehicle Inventory Process” section below.

**7. Question: What is the repair procedure for the WRA-24 recall?**

**Answer:** For vehicles with an “Open” WRA-24 status, the recall repairs can be performed as outlined in the WRA-24 Recall Bulletin on STIS. The remedy repair will involve replacement of the 4 ODS sensors on the passenger side seat, as well as some hardware replacement. WRA-24 training videos will also be part of the required learning for technicians on STAR-U. Videos of the repair procedures are also embedded in the Recall Bulletin on STIS.

If you encounter an affected vehicle in an “Open- Remedy not yet available” status and the customer is not experiencing illumination of the SRS light, let the owner know that they will receive owner notification when parts are available to perform the remedy repair on their vehicle.

*Continued...*

**NOTE: The remedy repair should only be performed on affected vehicles with the WRA-24 in an “Open” status.**

1. 8.Question: What if a customer vehicle does not have a current failure (no SRS light illuminated), but the customer feels unsafe driving the vehicle?

**Answer: There is NO risk to the driver of the vehicle; this recall affects only the front passenger side air bag. Additionally, a safety risk to the front passenger exists only if the SRS light is illuminated.** Please reassure the customer that if the SRS light is not illuminated, then the ODS sensors are operating as designed and there is no need to take any action until Subaru notifies the customer that parts are available. IMPORTANT NOTE: *Customers are eligible for alternate transportation only if the SRS light is illuminated.*

If the ODS sensor failure occurs, the SRS light will illuminate. Please refer to question 9 for additional information.

9. **Question: What if a customer vehicle experiences the ODS sensor failure (SRS light illuminates)?**

**Answer:** If an ODS sensor failure occurs, the SRS light will illuminate. The customer should be instructed that if the SRS light illuminates, then any passenger in the front passenger seat should move to the rear seat, and they should avoid using the front passenger seat until the vehicle is inspected and repaired by the retailer.

There are a few different scenarios that your retailer can encounter. Please follow the instructions based on the relevant scenario:

**Scenario 1: WRA-24 vehicle in an “Open” status, regardless of SRS illumination**

Please refer to the WRA-24 Recall bulletin on STIS for the repair procedure to replace the ODS Sensor Kit and related hardware. The remedy repair should be performed on any vehicle with an “Open” status, regardless of whether the SRS light is illuminated.

**Scenario 2: WRA-24 vehicle in an “Open Remedy not yet available” status that has the SRS light illuminated**

Should a customer bring their vehicle in with the SRS light illuminated, and their WRA-24 recall status is “Open- Remedy not yet available”, the technician should first pull all DTCs.

If DTC B1788 is present, then the ODS sensor failure has occurred and a QMR should be submitted. Please [click here](#) to navigate to the appendix for specific instructions and requirements for QMR submission for this scenario.

If DTC B1788 is not present, then refer to the applicable service manual and perform diagnostics, noting all key steps and results. Please [click here](#) to navigate to the appendix for specific instructions and requirements for QMR submission for this scenario.

Please note, if you encounter an affected vehicle in an “Open- Remedy not yet available” status and the customer is not experiencing illumination of the SRS light, let the owner know that they will receive owner notification when parts are available to perform the remedy repair on their vehicle.

*Continued...*

**NOTE: The remedy repair should only be performed on affected vehicles with the WRA-24 in an “Open” status.**

If the vehicle is used inventory or a Certified Pre-owned vehicle, please refer to the separate instructions titled **“Used Vehicle Inventory Process”** or **“Procedure to CPO vehicles affected by the WRA-24 recall”** in this announcement.

***Scenario 3: Seat bottom is needed for a non-WRA-24 affected vehicle or an unrelated service issue***

If the vehicle is not affected by the WRA-24 recall or has an unrelated service issue that requires a seat bottom, a QMR is still required to obtain the seat bottom. Please [click here](#) to navigate to the appendix for specific instructions and requirements for QMR submission for this scenario.

***Procedure to CPO vehicles affected by the WRA-24 recall***

If you have a used vehicle that is affected by the WRA-24 recall and is in an “Open” Status, please refer to the Recall bulletin on STIS and perform the remedy repair. The process outlined below relates only to used vehicles affected by the WRA-24 recall in an “Open-Remedy not yet available” status that will be considered for CPO certification.

To determine CPO eligibility, the retailer must first run a Carfax on the vehicle to ensure the vehicle does not have a branded title, the vehicle has not been in a moderate to severe accident, and there is no evidence of airbag deployment. If the Carfax report shows evidence of any of these, the vehicle is not able to go through CPO certification and the retailer should refer to the Used Vehicle Inventory process outlined in this announcement.

If the Carfax report is clean, the retailer should then work through the 152-point Certified Pre-Owned Vehicle Inspection Checklist for the vehicle. The retailer should have an accompanying repair order for any work that is done on the vehicle to meet the CPO certification requirements.

If the retailer determines the vehicle is eligible for CPO certification, but has an open WRA-24 recall, the retailer should:

- Submit an order for the appropriate seat bottom for the vehicle. There are three seat bottom assembly part numbers, depending on model applicability, for the 2020-2022 MY Legacy and Outback models affected by this recall, and they are listed below. When placing the order, the last 8 characters of the VIN must be entered as the PO number.

64139AN00A CUSHION AY OCPANTRH

64139AN01B CUSHION AY OCPANTRH

64139AN02B CUSHION AY OCPANTRH

*Continued...*

- Once the order is placed, the retailer must email the 152-point CPO Inspection Checklist, with Section A completed, and the accompanying Repair Order to the Parts Information Coordinators (PICs) at [Picemail@subaru.com](mailto:Picemail@subaru.com). The subject line of the email should include reference to the WRA-24 recall and include the related 8-digit order number for the appropriate seat bottom for the vehicle (Example: WRA-24 parts order # 12345678).

Upon receipt of the email, the PICs will review the information and reply to the retailer email advising that either the order was released or requesting additional information. If the order is released, the retailer should expect to receive the seat bottom within 2-3 business days. If there is a request for additional information, and there is no response from the retailer providing the requested information within 5 business days, the order will be cancelled.

Once the retailer receives the part, the WRA-24 recall can be performed on the vehicle and a recall claim should be entered using the following guidelines:

Recall Code	Labor Operation	Description	Labor Hours
WRA24	100576	WRA-24 ODS SEAT BOTTOM R&R	0.9

Once the recall claim is approved, the status of the recall for the VIN will change to Completed. Timely claim entry is very important to keep the process of CPO certification moving forward. Retailers must wait 24 hours after the recall shows completed on the VIN before they can systematically begin certifying one of these vehicles via Subarunet.

**If your vehicle is a CPO, do not proceed beyond this point, follow the submission instructions above. Any questions should be directed to the Parts Information Coordinators (PICS) through email [Picemail@subaru.com](mailto:Picemail@subaru.com) or phone number 866-782-2782, option 2.**

## ***Used Vehicle Inventory Process***

If you have a used vehicle that is affected by the WRA-24 recall and is in an “Open” Status, please refer to the Recall bulletin on STIS and perform the remedy repair. The process outlined below relates only to used vehicles affected by the WRA-24 recall in an “Open- Remedy not yet available” status that do not have an SRS light illuminated and do not qualify for the CPO program. These vehicles may be delivered to a purchaser if the following 2 conditions are met:

- 1. The vehicle does not have the SRS indicator illuminated, and**
- 2. The selling retailer discloses information about this safety recall to the purchaser using the Vehicle Disclosure Form** - It is imperative that the purchaser is made aware of the open safety recall on the vehicle and signs the Vehicle Disclosure Form prior to completing the purchase. The customer must initial the Vehicle Disclosure Form to confirm that they received the WRA-24 Subaru Safety Recall Information prior to completing their purchase of the vehicle.

*Continued...*

If the vehicle is in your used car inventory and has an SRS light illuminated, the vehicle **must not be sold**. Please refer to question 9 for the procedure for obtaining a seat bottom when the SRS light is illuminated.

The Vehicle Disclosure Form and the WRA-24 Subaru Safety Recall Information sheet can be found on Subarunet in Recall & Campaigns, specifically in the WRA-24- ODS Sensor Replacement area of Recall/Campaign Details.

If the above conditions are met, as part of the delivery process we ask the Retailer Sales Department to please do the following:

1. Fill out the Owner Contact and Vehicle Disclosure Form included with this notice if the purchaser agrees to purchase the vehicle in this condition. This form can be found on Subarunet in the Resources area on the left navigation menu or in Recall & Campaigns, specifically in the WRA-24- ODS Sensor Replacement area of Recall/Campaign Details.
2. Print and provide a copy of the Safety Recall Information sheet, also included with this notice. There is an area on the disclosure form the customer will need to initial to acknowledge receipt of the Safety Recall Information sheet. The Safety Recall Information sheet can be found on Subarunet in the Resources area on the left navigation menu or in Recall & Campaigns, specifically in the WRA-24- ODS Sensor Replacement area of Recall/Campaign Details.
3. When remedy parts become available, we ask that the retailer contacts the owner to schedule an appointment to complete the WRA-24 recall.
4. Please encourage the purchaser to update their ownership information by visiting Customer Support in the Connect with Us area on Subaru.com.

If a 2020-2022 Legacy or Outback model affected by the WRA-24 recall does not meet the CPO certification process, the retailer can sell the vehicle as Used Vehicle Inventory using the disclosure letter process that was outlined in the Subarunet announcement.

*Continued...*

## Appendix 1 - WRA-24 vehicle in an “Open Remedy not yet available” status that has the SRS light illuminated with DTC B1788

If DTC B1788 is present, then the ODS sensor failure has occurred and a QMR should be submitted as outlined below.

**NOTE: The QMR instructions below must be followed to ensure you receive a response within one business day. This includes completing QMR with the correct coding and including all requested information in the appropriate format. Failure to do so will significantly delay the review process and potential part release.**

1. The QMR should be coded using WRA as the failure code. The SSM file data must be attached to the QMR in .SEPF format with the VIN written to the data.

All QMR submissions should have the customer’s Concern, Cause, and Correction filled out with detail and contain the technician’s observations, diagnostics, and recommendation.

2. The QMR and required attachments will be reviewed by SOA and, if approved, a parts order for the appropriate remedy part will be placed by the Parts Information Coordinators (PICs) for your dealership.

**NOTE: Orders will only be placed only if a QMR is submitted with the required attachments and SOA is able to confirm the diagnosis of a defect requiring replacement of the seat bottom.**

If there is sufficient inventory, then a parts order for the ODS sensor kit and related hardware kit will be placed by the PICs for your dealership. If we do not have sufficient inventory of the ODS sensor kits or hardware kits, then a parts order for the appropriate seat bottom part will be placed by the PICs for your dealership.

3. Once the appropriate part is received and the vehicle has been repaired, please submit a claim using the following information:
  - If the vehicle is part of the WRA-24 recall and the retailer was sent an ODS sensor kit and hardware kit, then a Recall Claim (RC) must be submitted using the following information:

Recall Code	Labor Operation	Description	Labor Hours
WRA24	A100-579	WRA-24 ODS SENSOR KIT R&R	1.1 (manual seat)
			0.9 (power seat)

*Continued...*

- If the vehicle is part of the WRA-24 recall and the retailer was sent a seat bottom, then a Recall Claim (RC) must be submitted using the following labor operation:

Recall Code	Labor Operation	Description	Labor Hours
WRA24	A100-576	WRA-24 ODS Seatbottom R&R	0.9

4. Please direct any inquiries as follows:

- If you have questions regarding the status of your QMR, please refer to the QMR itself, specifically the status on the QMR.
  - i. If the QMR is in a “Pending Review” status, then it has been received but has not been reviewed yet. The status will be updated once the QMR has been reviewed.
    - If the status of the QMR is “No Action Needed”, then either the PICs have placed an order for the seat bottom (which can be viewed in RPM), or you will be notified via phone or email of information that was missing from the QMR.
- Additional inquiries should be directed to the Subaru Claims Helpline at: 866-782-2782, option 2.

*Continued...*

## **Appendix 2** - WRA-24 vehicle in an “Open Remedy not yet available” status that has the SRS light illuminated with DTC other than B1788

Technicians should refer to the applicable service manual and perform diagnostics, noting all key steps and results. A QMR should be submitted as outlined below.

Currently, we have a limited supply of seat bottoms, which includes the ODS sensors, available for customers who experience an ODS failure (the SRS lamp is illuminated) prior to the recall part becoming available. There are three seat bottom assembly part numbers, depending on model applicability, for the 2020-2022 MY Legacy and Outback models affected by this recall:

64139AN00A CUSHION AY OCPANTRH

64139AN01B CUSHION AY OCPANTRH

64139AN02B CUSHION AY OCPANTRH

To ensure adequate inventory of these parts is available for customers that are experiencing an ODS sensor failure, these part numbers are restricted from retailer ordering. Therefore, the following process must be followed to obtain one of these parts. Failure to adhere to these instructions may result in a delay.

**NOTE: The QMR instructions below must be followed to ensure you receive a response within one business day. This includes completing the QMR with the correct coding and including all requested information in the appropriate format. Failure to do so will significantly delay the review process and potential part release.**

1. If technician’s diagnosis results in the seat bottom requiring replacement, a QMR must be submitted. The QMR should be coded using WRA as the failure code.

All QMR submissions should have the customer’s Concern, Cause, and Correction filled out with detail and contain the technician’s observations, diagnostics, and recommendation. If there are DTCs other than B1788, completed trouble tree results are required in the QMR. Squeaks and rattles should have video documentation and physical damage will require pictures. Secondary component failures such as power seat motors or seat position sensor failures will require completed diagnostics uploaded to the QMR.

Body shop orders should have a copy of the body shop repair order or proof of repair added to the QMR for documentation.

2. The QMR and required attachments will be reviewed by SOA and, if approved, a parts order for the appropriate remedy part will be placed by the Parts Information Coordinators (PICs) for your dealership.

**NOTE: Orders will only be placed only if a QMR is submitted with the required attachments and SOA is able to confirm the diagnosis of a defect requiring replacement of the seat bottom.**

*Continued...*

3. Once the appropriate part is received and the vehicle has been repaired, please submit a claim using the following information:
- If the vehicle is part of the WRA-24 recall and the retailer was sent a seat bottom, then a Recall Claim (RC) must be submitted using the following labor operation:

Recall Code	Labor Operation	Description	Labor Hours
WRA24	A100-576	WRA-24 ODS Seatbottom R&R	0.9

4. Please direct any inquiries as follows:

- If you have questions regarding the status of your QMR, please refer to the QMR itself, specifically the status on the QMR.
  - i. If the QMR is in a “Pending Review” status, then it has been received but has not been reviewed yet. The status will be updated once the QMR has been reviewed.
  - ii. If the status of the QMR is “No Action Needed”, then either the PICs have placed an order for the seat bottom (which can be viewed in RPM), or you will be notified via phone or email of information that was missing from the QMR.
- Additional inquiries should be directed to the Subaru Claims Helpline at: 866-782-2782, option 2.

*Continued...*

### **Appendix 3** - *Seat bottom is needed for a non-WRA-24 affected vehicle or an unrelated service issue*

If the vehicle is not affected by the WRA-24 recall or has an unrelated service issue that requires a seat bottom, then a QMR is still required to obtain the seat bottom. Technicians should refer to the applicable service manual and perform diagnostics, noting all key steps and results. A QMR should be submitted as outlined below.

There are three seat bottom assembly part numbers, depending on model applicability, for the 2020-2022 MY Legacy and Outback models affected by this recall:

64139AN00A CUSHION AY OCPANTRH

64139AN01B CUSHION AY OCPANTRH

64139AN02B CUSHION AY OCPANTRH

To ensure adequate inventory of these parts is available for customers that are experiencing an ODS sensor failure, these part numbers are restricted from retailer ordering. Therefore, the following process must be followed to obtain one of these parts. Failure to adhere to these instructions may result in a delay.

**NOTE: These QMR instructions must be followed to ensure you receive a response to your QMR within one business day. This includes completing the QMR with the correct coding and including all requested information in the appropriate format. Failure to do so will significantly delay the review process and potential parts order.**

1. If the technician diagnosis results in one of the above seat bottoms requiring replacement, then a QMR must be submitted. The QMR should be coded using WRA as the failure code. All Service Manual diagnostics steps/results as well as the SSM data, if there was a DTC, should be attached to the QMR in .SEPF format with the VIN written to the data.

All QMR submissions should have the customer's Concern, Cause, and Correction filled out with detail and contain the technician's observations, diagnostics, and recommendation. If there are DTCs other than B1788, completed trouble tree results are required in the QMR. Squeaks and rattles should have video documentation and physical damage will require pictures. Secondary component failures such as power seat motors or seat position sensor failures will require completed diagnostics uploaded to the QMR.

Body shop orders should have a copy of the body shop repair order or proof of repair added to the QMR for documentation.

*Continued...*

2. The QMR and required attachments will be reviewed by SOA and, if approved, a parts order for the appropriate seat bottom part will be placed by the PICs for your dealership.

**NOTE: Orders will only be placed only if a QMR is submitted with the required attachments and SOA is able to confirm the diagnosis of a defect requiring replacement of the seat bottom.**

3. Once the appropriate seat bottom part is received and the vehicle has been repaired, please submit a claim using the following information:
  - The seat bottom was replaced in a vehicle for reasons unrelated to the WRA-24 recall. Please refer to the Labor Time Guide for applicable coverage and claim coding.
4. Please direct any inquiries as follows:
  - If you have questions regarding the status of your QMR, please refer to the QMR itself, specifically the status on the QMR.
    - i. If the QMR is in a “Pending Review” status, then it has been received but has not been reviewed yet. The status will be updated once the QMR has been reviewed.
      - If the status of the QMR is “No Action Needed”, then either the PICs have placed an order for the seat bottom (which can be viewed in RPM), or you will be notified via phone or email of information that was missing from the QMR.
  - Additional inquiries should be directed to the Subaru Claims Helpline at: 866-782-2782, option 2.

*Continued...*

**URGENTIMPORTANT SAFETY RECALL**

**This notice applies to the VIN identified  
in the address section printed below**



**Subaru Safety Recall WRA-24  
NHTSA Recall ID 24V-227  
February 2025**

**Dear Subaru Owner:**

This notice is sent to you in accordance with the National Traffic and Motor Vehicle Safety Act.

Subaru of America, Inc. (Subaru) has decided that a defect which relates to motor vehicle safety exists in certain 2020-2022 model year Legacy and Outback vehicles. You previously received a letter informing you of this recall, stating that the remedy parts were not yet available.

***This letter is to inform you that parts are now available***

**DESCRIPTION OF THE DEFECT AND SAFETY RISK**

Your vehicle may be equipped with defective Occupant Detection System (ODS) sensors on the front passenger seat, which may result in an internal short circuit. If this happens, the supplemental restraint system (SRS) warning light will illuminate and the front passenger airbag may deactivate even though the seat is occupied, increasing the risk of injury to the front passenger in the event of a crash.

**WHAT SUBARU WILL DO**

Subaru will replace all four of the ODS sensors on the front passenger seat in your vehicle with new ones at no cost to you.

**WHAT YOU SHOULD DO**

Please contact your Subaru retailer (dealer) immediately for an appointment to have the ODS sensors in your vehicle replaced at no cost to you.

If the supplemental restraint system (SRS) airbag system warning light is illuminated in your instrument panel, your vehicle may be experiencing symptoms related to this safety recall. Please contact your authorized Subaru retailer for further diagnosis and refrain from allowing passengers in the front passenger seat until the diagnosis is complete.

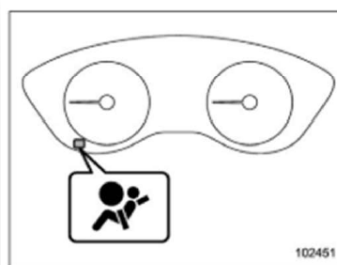

102451

SRS airbag system warning light

## **HOW LONG WILL THE REPAIR TAKE?**

The time required for this repair is approximately one hour. Your retailer can provide you with a better estimate of the overall time for this service visit, as it may be necessary to make your vehicle available for a longer period of time.

## **OWNER INFORMATION**

Government regulations require that recall notifications be sent to the last known owner of record. That information is based primarily on state registration and title data. If you are a lessor of this vehicle, federal regulations require you to forward this notice to your lessee within ten days.

If you have moved or sold your vehicle, please go to <https://www.subaru.com/support/customer-support.html> to send us your information.

## **IF YOU HAVE PREVIOUSLY PAID FOR A REPAIR**

If you have already paid for repairs associated with this condition, you may be eligible for reimbursement. Reimbursement consideration will be based on the amount an authorized Subaru retailer in your area would charge for the same repair.

Please send the original service repair order, which has the name of the repair facility, date of repair, mileage at the time of repair, complete 17-digit vehicle identification number (VIN), and your name, with correct mailing address and telephone number to the address listed below:

**Subaru of America, Inc.**  
**Customer Advocacy Department, Attention: WRA-24 Recall**  
**P.O. Box 9103, Camden, NJ 08101-9877**

Please send original receipts only and retain a photocopy for your records. Please be assured that we will attempt to process your reimbursement request as quickly as possible, but it may take up to 60 days for this process to be completed.

## **IF YOU NEED FURTHER ASSISTANCE:**

To locate the nearest Subaru retailer, you can access our website at [www.subaru.com](http://www.subaru.com) and select 'Find a Retailer.'

For additional information, please go to: <http://www.wra24.service-campaign.com>.

If you need additional assistance, please contact us directly:

- By e-mail: Go to <https://www.subaru.com/support/customer-support.html> and select 'Email Us'
- By telephone: 1-844-373-6614  
Monday through Friday between 8:00 a.m. and 7:00 p.m. ET
- By U.S. Postal mail:  
Subaru of America, Inc.  
Attn: Customer Advocacy Department  
P.O. Box 9103, Camden, NJ 08101-9877

To subscribe to the NHTSA Recall Notification email System, please go to: <https://www.wodi.nhtsa.dot.gov/nhtsa/subscriptions>.

Please contact us immediately if the Subaru retailer fails or is unable to make the necessary repairs free of charge.

If your dealer fails or is unable to remedy this defect without charge, or within a reasonable amount of time, you may submit a written complaint to: Administrator, National Highway Traffic Safety Administration (NHTSA), 1200 New Jersey Ave., SE, Washington, DC 20590 or call the toll-free Vehicle Safety Hotline at 1-888-327-4236 (TTY: 1-800-424-9153) or go to <http://www.NHTSA.gov>.

Your continued satisfaction with your Subaru is important to us. Please understand that we have taken this action in the interest of your safety and your vehicle's proper operation. We sincerely apologize for any inconvenience this matter may cause and urge you to schedule an appointment as soon as possible.

Sincerely,  
Subaru of America, Inc.

A subsidiary of SUBARU CORPORATION