



# Technical Service Bulletin

GROUP <b>CAMPAIGN</b>	NUMBER <b>25-01-037H</b>
DATE <b>JUNE 2025</b>	MODEL(S) <b>IONIQ 5 (NEA EV)</b>

**SUBJECT:** REAR BUMPER MISSING LICENSE PLATE MOUNTING HOLES INSPECTION & REPLACEMENT (SERVICE CAMPAIGN TCY)

## ★ IMPORTANT

Dealers must perform this service campaign on all affected vehicles prior to customer retail delivery and whenever an affected vehicle is in the shop for any maintenance or repair.

Access the “Vehicle Information” screen via WebDCS to identify open campaigns.

**Description:** Certain 2025MY IONIQ 5 vehicles (NEA EV) may be missing the license plate bracket mounting holes in the rear bumper cover. This bulletin provides instructions to inspect, and if needed replace the rear bumper cover with the mounting holes to accommodate the installation of the license plate bracket.

## *i* Information

This TSB applies only to IONIQ 5 vehicles with SE, SEL, and Limited trim. It does **NOT** apply to vehicles with XRT trim.

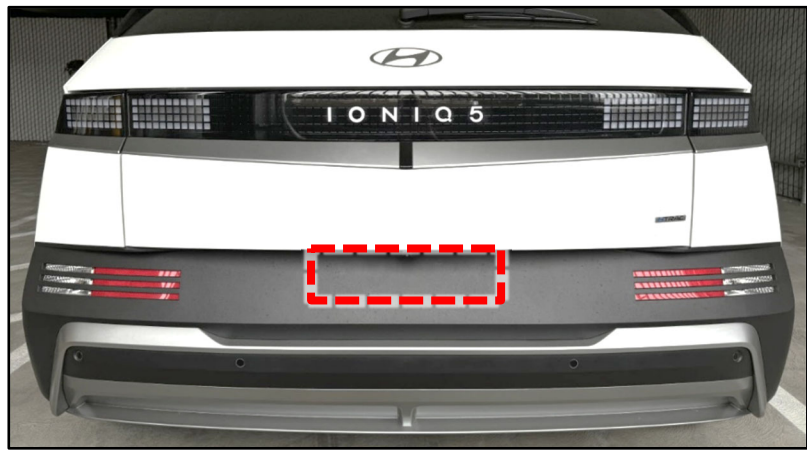





**Applicable Vehicles (Certain):**

- 2025MY IONIQ 5 (NEA EV) produced 11/12/2024 – 06/02/2025

## NOTICE

To avoid any potential damage to IONIQ vehicles, IONIQ repairs can only be performed at IONIQ certified dealers.

**SUBJECT:****REAR BUMPER MISSING LICENSE PLATE MOUNTING HOLES INSPECTION & REPLACEMENT (SERVICE CAMPAIGN TCY)****Parts Information:**

Model	Part Name	Part Number	Details/Figure	Remarks
IONIQ 5 (NEA EV)	Cover-RR Bumper Lower	86612-PI020	SEL, Limited Trim	QTY: 1
		86650-PI000CA	SE Trim	QTY: 1
	Clip	14206-08250B		Replace if broken
	Clip-Trim Mounting	84747-2L000		
	Clip-Side Garnish Mounting	87756-1F000		
	Clip-Cowl Top Cover Mounting	86157-37000		

**NOTE 1:** 86650-PI000CA will have a different part number label on the actual part. The part number label on the actual part will be 86612-PI000. However, this will not impact installation of the part and the external packaging will have the correct part number label (86650-PI000CA).

**NOTE 2:** Dealers will be reimbursed via sublet as noted below for any clips, regardless of replacement or not.

**Warranty Information:**

Model	Op. Code	Operation	Op. Time	Causal Part	Nature Code	Cause Code
IONIQ 5 (NEA EV)	50DV04I0	Rear Lower Bumper Cover Inspection (SEL & Limited Trim)	0.2 M/H	86612-PI020	A33	ZZ3
	50DV04I1	Rear Lower Bumper Cover Inspection (SE Trim)		86650-PI000CA		
	50DV04R0	Rear Lower Bumper Cover Inspection/Replacement (SEL & Limited Trim)	1.5 M/H	86612-PI020		
	50DV04R1	Rear Lower Bumper Cover Inspection/Replacement (SE Trim)		86650-PI000CA		

**NOTE 1:** Submit claim on Claim Entry Screen as "Campaign" type.

**NOTE 2:** This TSB includes repair validation photos. Op times include VIN, Mileage and repair validation photos as outlined in the Digital Documentation Policy.

**NOTE 3:** The incident parts are subject to callback through the normal Warranty Technical Center (WTC) parts return process. **Claim is subject to debit if the part is not returned.**

**NOTE 4:** If a part is found in need of replacement while performing this TSB and the affected part is still under warranty, submit a separate claim using the same repair order. If the affected part is out of warranty, submit a Prior Approval request for goodwill consideration prior to performing the work.

**NOTE 5:** Replacement operation codes 50DV04R0 and 50DV04R1 will reimburse \$1.50 in sublet for any clips that need to be replaced as part of the bumper replacement.

**SUBJECT:** REAR BUMPER MISSING LICENSE PLATE MOUNTING HOLES INSPECTION & REPLACEMENT (SERVICE CAMPAIGN TCY)

**Service Procedure:**

**DIGITAL DOCUMENTATION**



This TSB includes repair validation photos. Refer to the latest Warranty Digital Documentation Policy for requirements.

**NOTICE**

Applying the recommended torque to all fasteners is essential to reduce potential issues from occurring after the service procedure.

**Rear Bumper Assembly Inspection Procedure**

1. Inspect the area (A) on the rear bumper lower cover for missing license plate mounting holes.

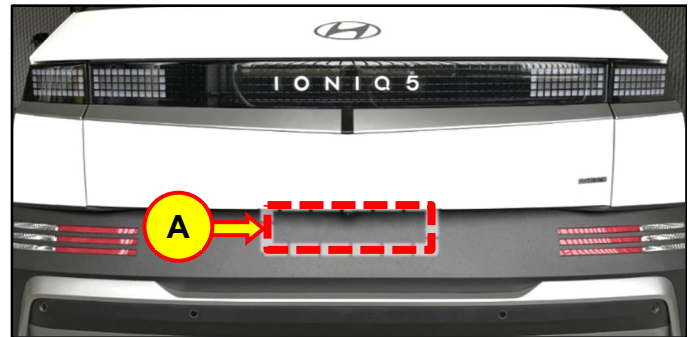

2. **GOOD:** If the license plate mounting holes are present on the rear bumper, take a photo per the below instructions.

**NOT GOOD:** If the license plate mounting holes are missing from the rear bumper, proceed to the **Rear Bumper Removal Procedure** section.

- 3.

**DIGITAL DOCUMENTATION**



Using STUI, take a photo of the rear bumper lower cover license plate mounting holes with the last 6 digits of the VIN and the date of repair on a piece of paper.

Upload the photo to STUI.



4. The procedure is now complete.

Rear Bumper Removal Procedure

1. Disconnect the negative (-) battery terminal to prevent an electrical short during the procedure (disconnecting connectors).

**Tightening Torque:**

lb-ft	6.5
lb-in	78
N.m	8.8

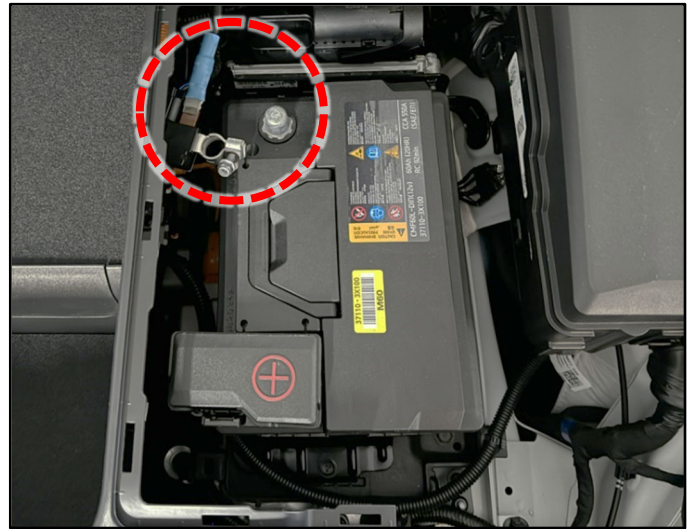

2. Remove the lower section of both rear quarter garnishes (A) so that the rear bumper can be removed from the vehicle (first **3-4 clips** from the rear edge **only**).

Refer to the shop manual:

- **Body (Interior / Exterior / Electrical)**  
  > **Body Side Molding > Quarter Garnish > Removal and Installation**

**i** **Information**

If clips are broken, reference the parts table for applicable clips/part numbers.

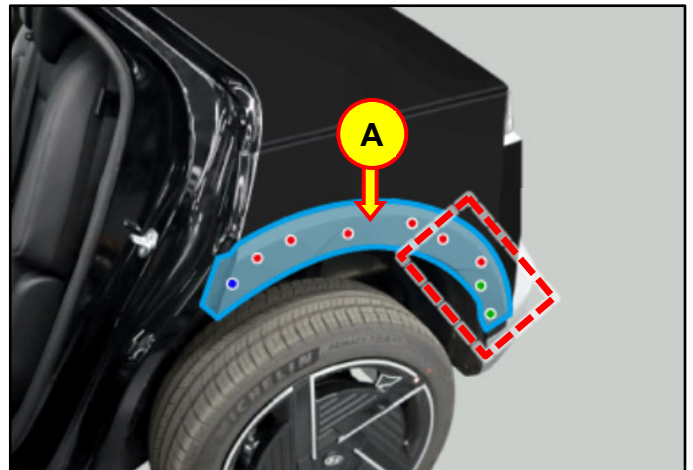

**SUBJECT:**

**REAR BUMPER MISSING LICENSE PLATE MOUNTING HOLES INSPECTION & REPLACEMENT (SERVICE CAMPAIGN TCY)**

3. Remove both rear combination lamps.

Refer to the shop manual:

- **Body (Interior / Exterior / Electrical > Light & Vision System > Rear Combination Lamp > Removal and Installation**



4. Remove the rear bumper upper clips (B) and screw (C) on both sides of the vehicle.

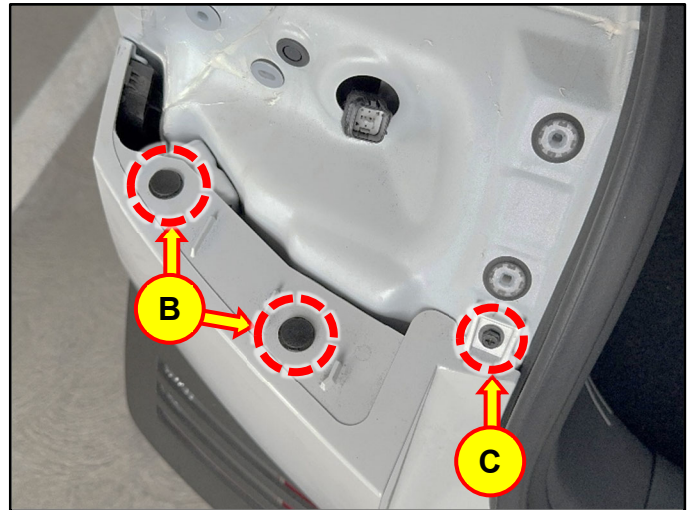

5. Remove the rear bumper lower clips.

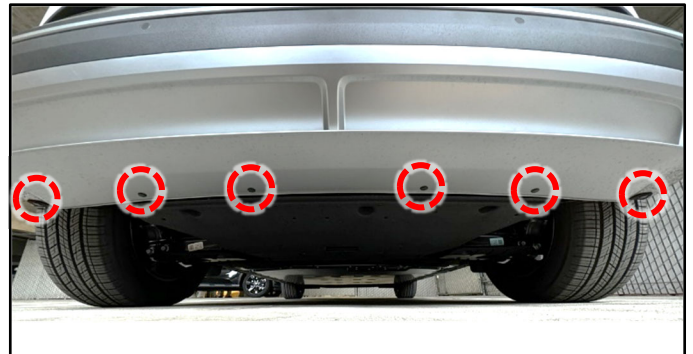

**SUBJECT:****REAR BUMPER MISSING LICENSE PLATE MOUNTING HOLES INSPECTION & REPLACEMENT (SERVICE CAMPAIGN TCY)**

6. Remove the screw (D), the clip (E), and the screws (F) from the rear inner fender wells on both sides of the vehicle.

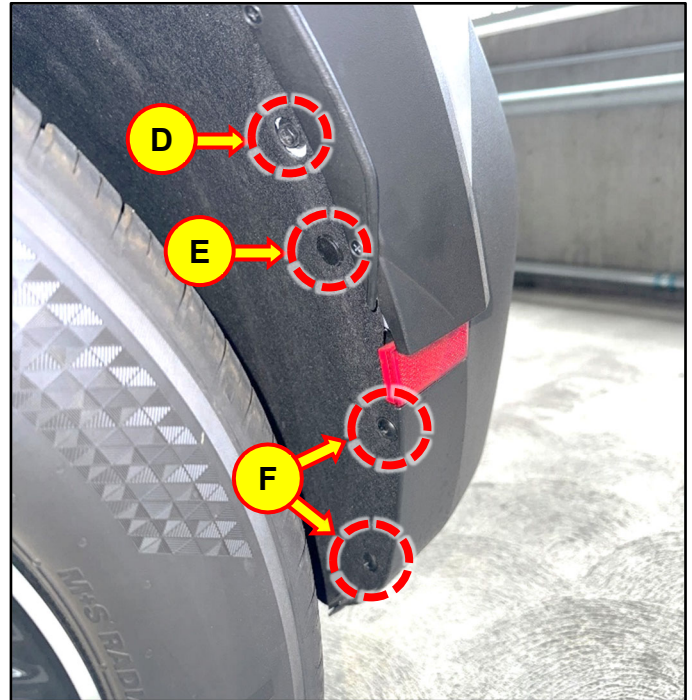

7. Remove the rear bumper from the vehicle.

Refer to the shop manual:

- **Body (Interior / Exterior / Electrical) > Front and Rear Bumper > Rear Bumper Assembly > Removal and Installation**

***i* Information**

To assist in removal of the rear bumper, first unseat the bumper from the area (G). Then push from the bottom of the bumper in the area (H) upward as pictured. Repeat on other side of the bumper.

***i* Information**

Refer to the QR code or link below for a demonstration of removing the bumper from the vehicle:

[Campaign TCY – IONIQ 5 Rear Bumper Removal Demonstration](#)

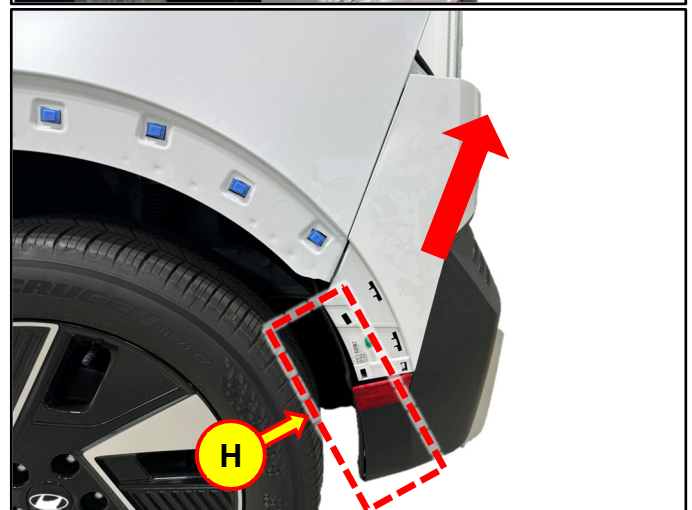

**SUBJECT:****REAR BUMPER MISSING LICENSE PLATE MOUNTING HOLES INSPECTION & REPLACEMENT (SERVICE CAMPAIGN TCY)**

8. Disconnect the harness (I) and remove the bumper from the vehicle.

**NOTICE**

Once the bumper has been removed from the vehicle, ensure it is placed on a clean, non-marring surface to prevent damage to the paint/finish before working.

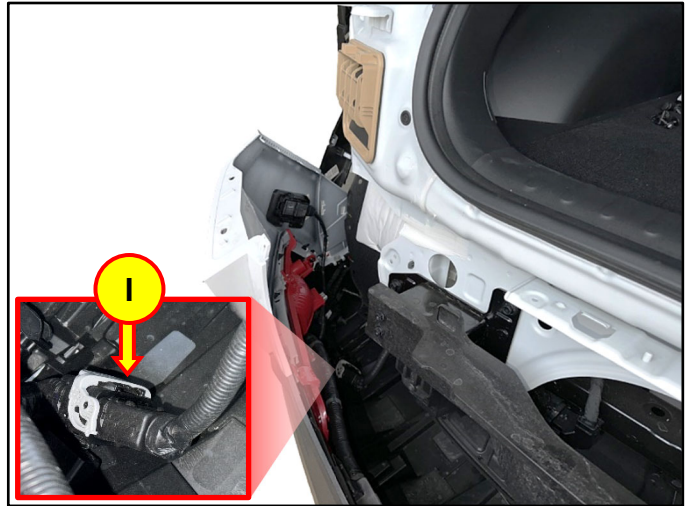
**Rear Bumper Lower Cover Assembly Replacement**

1. Remove the wiring harness (A) from the bumper.
  - Disconnect the wiring harness connectors from all sensors/electrical components.
  - Disconnect the arrowhead mount cable ties (B) from their mounting points.
2. Remove the ultrasonic sensors.

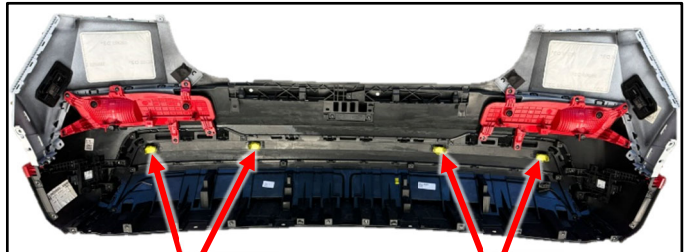
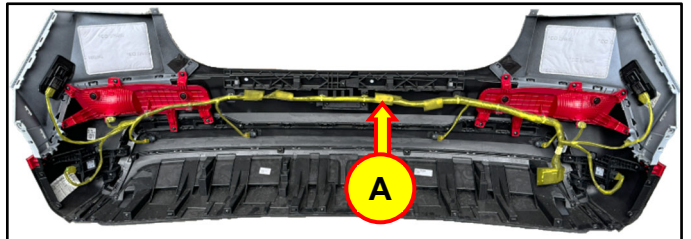

**SUBJECT:**

**REAR BUMPER MISSING LICENSE PLATE MOUNTING HOLES INSPECTION & REPLACEMENT (SERVICE CAMPAIGN TCY)**

3. Unscrew and remove the rear corner radar brackets.

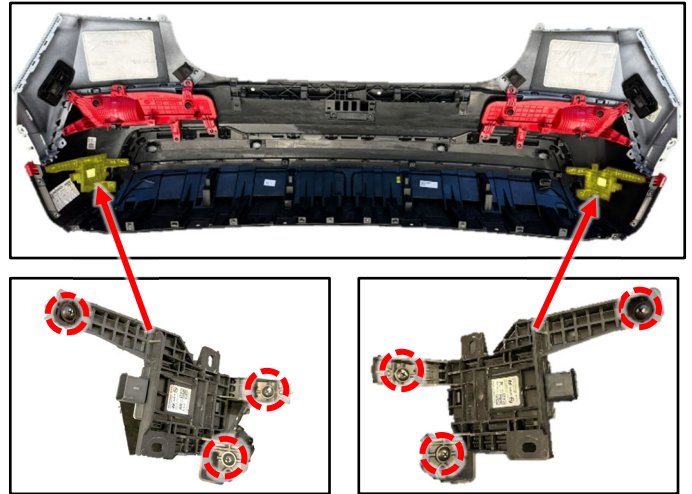

4. Unscrew and remove the rear lamp/reflector assemblies (if equipped).

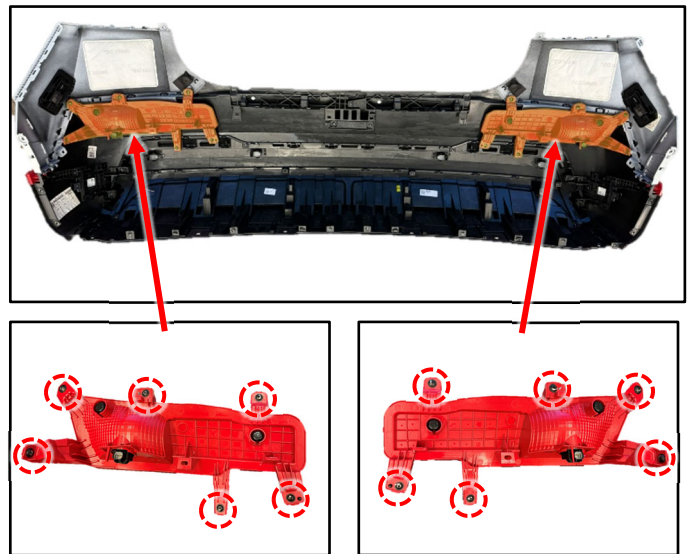

5. Unscrew (C), unclip (D), and remove the rear brackets.

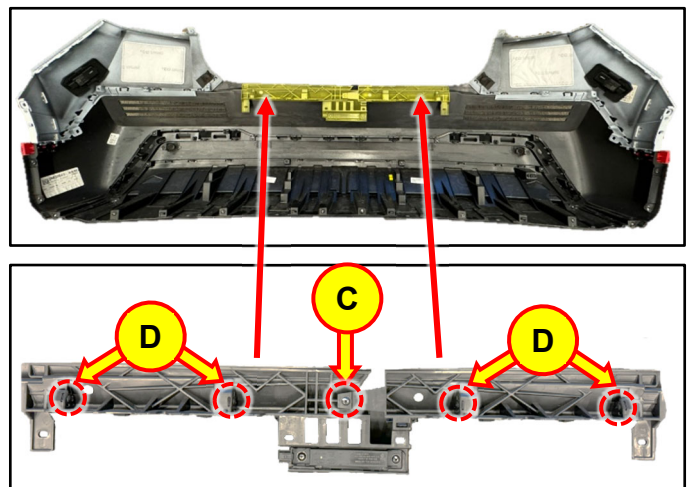

**SUBJECT:**

**REAR BUMPER MISSING LICENSE PLATE MOUNTING HOLES INSPECTION & REPLACEMENT (SERVICE CAMPAIGN TCY)**

6. Unscrew and remove the side reflectors.

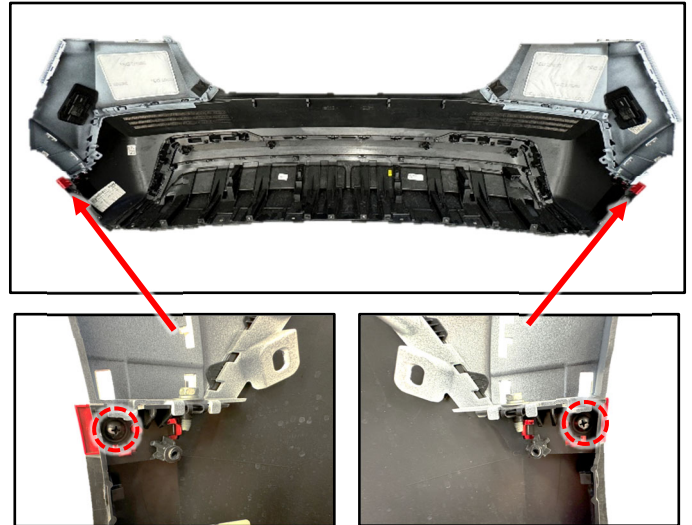

7. Remove the bolt from both sides of the rear bumper as shown.

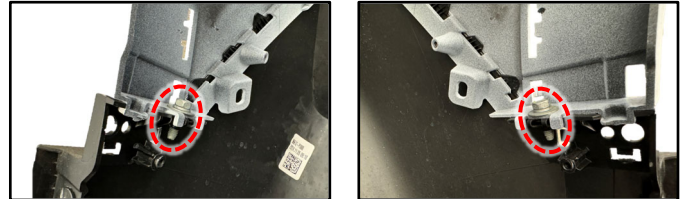

8. Remove both rear bumper side covers.

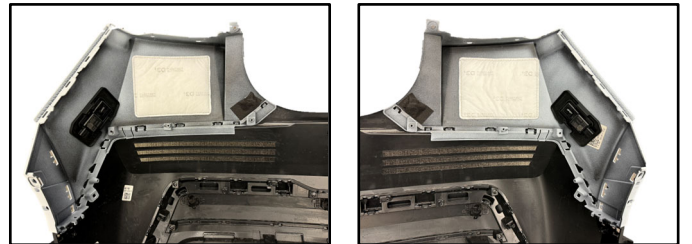

9. Remove all remaining screws (16) from the rear bumper.

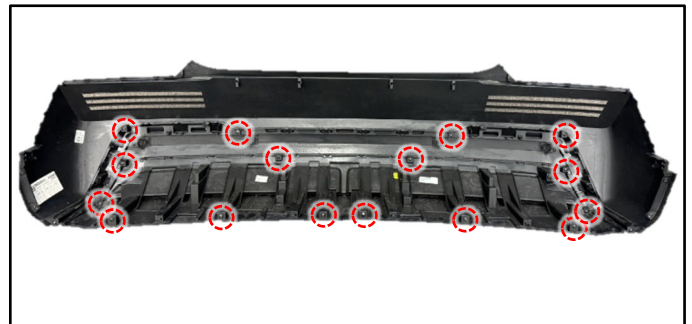

10. Remove the clips from the rear bumper.



**SUBJECT:** REAR BUMPER MISSING LICENSE PLATE MOUNTING HOLES INSPECTION & REPLACEMENT (SERVICE CAMPAIGN TCY)

- Carefully detaching the clips, remove the attached bumper skid plate (E) and center molding assembly (F) from the bumper cover assembly.

**i Information**

Ensure no other parts, sensors, screws, clips, etc. are attached to the original rear bumper lower assembly.

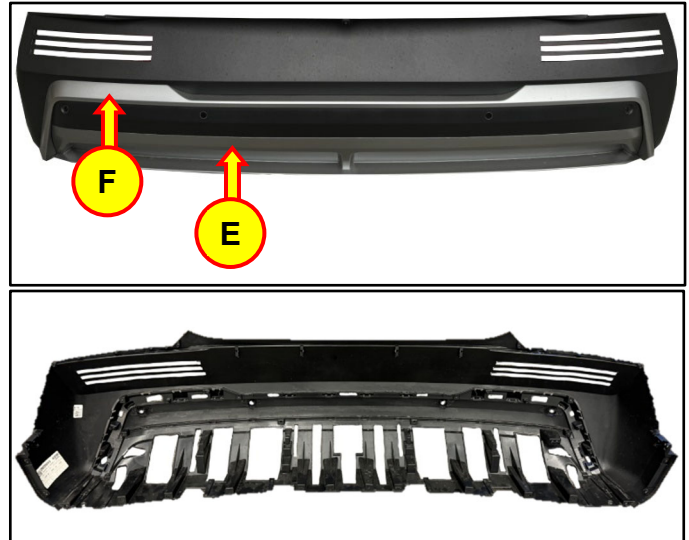

- Install all removed parts onto the replacement rear bumper cover in reverse order of removal.
- Reinstall the rear bumper onto the vehicle in reverse order of removal.
- Reconnect the battery.

- DIGITAL DOCUMENTATION** 

Using STUI, take a photo of the replacement rear bumper lower cover installed on the vehicle with the last 6 digits of the VIN and the date of repair on a piece of paper.



- Place the vehicle in “READY” mode and ensure normal vehicle operation.

**i Information**

Ensure no warnings lamps related to ADAS systems are present.

- The service procedure is complete.