

<b>REFERENCE:</b>	<b>TSB:</b> 21-009-25 REV. A <b>GROUP:</b> 21 - Transmission and Transfer Case	<b>Date:</b>	February 1, 2025	<b>REVISION:</b>	21-009-25
<b>VEHICLES AFFECTED:</b>	<p>2022 (WS) Wagoneer / Grand Wagoneer                  2020 - 2025 (WD) Dodge Durango                  2020 - 2023 (LD) Dodge Charger                  2020 - 2023 (LA) Dodge Challenger                  2020 - 2025 (DT) RAM 1500 Pickup                  2021 - 2024 (DS) RAM 1500 Classic                  2021 - 2024 (DX) RAM Truck (Mexico)                  2020 - 2022 (WK) Jeep Grand Cherokee                  2021 - 2024 (WL) Jeep Grand Cherokee / Grand Cherokee L                  2020 - 2025 (JT) Jeep Gladiator                  2020 - 2025 (JL) Jeep Wrangler                  2020 - 2023 (LX) Chrysler 300                  This bulletin applies to vehicles equipped with an Eight-Speed Auto 850RE Transmission (Sales Code DFT).</p>			<b>MARKET APPLICABILITY:</b>	
				<input checked="" type="checkbox"/> NA	<input checked="" type="checkbox"/> MEA
				<input checked="" type="checkbox"/> SA	<input checked="" type="checkbox"/> IAP
				<input checked="" type="checkbox"/> EE	<input checked="" type="checkbox"/> CH
<b>CUSTOMER SYMPTOM:</b>	<p>Customers must experience a Malfunction Indicator Lamp (MIL) illumination and the vehicle must exhibit/set one or more of the following Diagnostic Trouble Codes (DTCs):</p> <ul style="list-style-type: none"> <li>● P0733-00 - Gear 3 Shift Incorrect Ratio.</li> <li>● P1DA8-00 - Incorrect Gear Ratio Clutch A B or D Defective.</li> <li>● P1D92-00 - Incorrect Gear Ratio - Clutch 4 Defective.</li> </ul> <p>Customers may also comment on one or more of the following:</p> <ul style="list-style-type: none"> <li>● Transmission slips when shifting.</li> <li>● Vehicle will not move in reverse.</li> <li>● Vehicle will not shift higher than third gear.</li> </ul>				
<b>CAUSE:</b>	D Clutch repair				

This bulletin supersedes Technical Service Bulletin (TSB) 21-009-25, date of issue January 14, 2025, which should be removed from your files. All revisions are highlighted with **\*\*asterisks\*\*** and include an updated Related LOP labor description.

**REPAIR SUMMARY:**

This bulletin involves replacing the D clutch.

## CLAIMS DATA:

Labor Operation No:	Labor Description	Skill Category	Labor Time
21-00-64-90	D Clutch - Inspect and Replace 2020-2025 DT, 2021-2024 DX / DS (3 - Highly Skilled)	2 - Transmission and Transfer Case	9.7 Hrs.
21-00-64-91	D Clutch - Inspect and Replace 2020-2025 WD, 2020-2022 WK (3 - Highly Skilled)	2 - Transmission and Transfer Case	7.9 Hrs.
21-00-64-92	D Clutch - Inspect and Replace 2020-2023 LA / LD / LX (3 - Highly Skilled)	2 - Transmission and Transfer Case	6.7 Hrs.
21-00-64-93	D Clutch - Inspect and Replace 2020-2025 JL / JT (3 - Highly Skilled)	2 - Transmission and Transfer Case	6.4 Hrs.
21-00-64-94	D Clutch - Inspect and Replace 2021-2024 WL (3 - Highly Skilled)	2 - Transmission and Transfer Case	7.3 Hrs.
21-00-64-95	D Clutch - Inspect and Replace 2022 WS (3 - Highly Skilled)	2 - Transmission and Transfer Case	5.4 Hrs.
Failure Code	ZZ	Service Action	

## RELATED LOPS:

Labor Operation No:	Labor Description	Skill Category	Labor Time
21-00-64-60	Skid Plate - 2020-2025 DT, 2021-2024 DS / DX, 2020-2025 WD, 2020-2022 WK , 2020-2025 JL / JT, 2021-2024 WL, 2022 WS (3 - Highly Skilled)	2 - Transmission and Transfer Case	0.4 Hrs. <b>(DT DS/DX Only)</b> 0.2 Hrs. <b>(WL/WS/WD/WK/JL/JT Only)</b>
21-00-64-64	MGU Equipped - 2020-2025 DT, 2020-2025 JL / JT (3 - Highly Skilled)	2 - Transmission and Transfer Case	0.3 Hrs. <b>(DT Only)</b> 1.2 Hrs. <b>(JL/JT Only)</b>
21-00-64-66	**4x4/AWD Equipped - 2020-2025 DT, 2021-2024 DS / DX, 2020-2025 WD, 2020-2022 WK, 2021-2024 WL, 2022 WS** WL / WS	2 - Transmission and Transfer Case	0.6 Hrs. <b>(DT/DS/DX Only)</b> 0.9 Hrs. <b>(LD, LX Only)</b> 1.0 Hrs. <b>(WD/WK, WL/DS/DX Only)</b> 1.2 Hrs. <b>(LA Only)</b>

Labor Operation No:	Labor Description	Skill Category	Labor Time
	(3 - Highly Skilled)		
21-00-00-51	Adaptation Procedure - 2020-2025 DT, 2021-2024 DX / DS, 2020-2025 WD, 2020-2022 WK, 2020-2023 LA / LD / LX, 2020-2025 JL / JT, 2021-2024 WL, 2022 WS (2 - Skilled)	2 - Transmission and Transfer Case	1.0 Hrs.

**SPARE PARTS:**

Qty	Part No.	Description	Notes
1 (AR)	68676890AB	Shaft Kit, Output	D Clutch Repair Kit (4x4 JL, JT, WD, WK)
1 (AR)	68676891AB	Shaft Kit, Output	D Clutch Repair Kit (4x4 WL)
1 (AR)	68676887AB	Shaft Kit, Output	D Clutch Repair Kit (4x4 DS, DT, DX, WS)
1 (AR)	68239499AD	Shaft Kit, Output	D Clutch Repair Kit (AWD LA, LD, LX)
1 (AR)	68676892AB	Shaft Kit, Output	D Clutch Repair Kit (RWD LA, LD, LX)
1 (AR)	68676894AB	Shaft Kit, Output	D Clutch Repair Kit (RWD WD, WK, WL)
1 (AR)	68676893AB	Shaft Kit, Output	D Clutch Repair Kit (RWD DS, DT, DX, WS)
10 (AR)	68218925AB		Automatic Transmission Fluid

**DIAGNOSIS:**

If the customer describes the symptom/condition above, perform the repair procedure.

**SPECIAL TOOLS/EQUIPMENT:**

Description	Ref. No.	Notes
Guide Sleeve	10377	
Press Fixture	8925-3	
Bearing/Gear	1130	
Rings, Support	10378	
Installer, Seal	9677	

**REPAIR PROCEDURE:****CAUTION!**

The Transmission Control Module (TCM), or Transmission Control Module Assembly (TCMA) is extremely sensitive to Electrostatic Discharge (ESD). Always use a ground strap and follow the ESD guidelines in Electrostatic Discharge Sensitive Devices. Failure to follow these instructions may result in damage to the TCM/TCMA.

**CAUTION!**

If the transmission is being reconditioned (clutch/seal replacement) or replaced, it is necessary to perform the TCM Adaptation Procedure. Refer to the detailed service procedures available in DealerCONNECT/Service Library under: Service Info>08 - Electrical/8E - Electronic Control Modules/ Module, Transmission Control/ Module Programming.

**NOTE:** Tag all clutch pack assemblies as they are removed for reassembly identification.

**NOTE:** It is normal for the transmission to have fine debris present in the oil pan and stuck to the magnets. Burnt oil and debris do not warrant a transmission replacement for D piston seal failure.

**Fig. 1**  
Fluid Note

1. Are DTCs P0733, P1DA8 or P1D92 present?
  - YES >>> Proceed to [Step 2](#).
  - NO >>> The bulletin does not apply.
2. Remove the torque converter [Fig. 2](#).

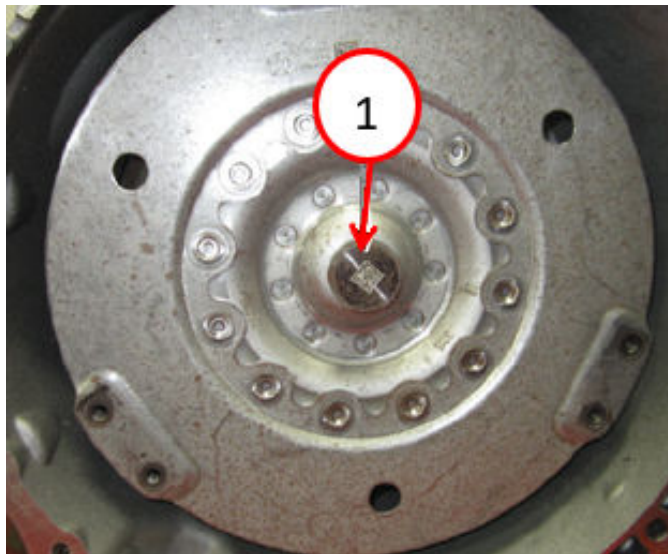

**Fig. 2**  
Torque Converter

3. If equipped with 4WD, remove the transmission housing extension bolts and remove the extension housing [Fig. 3](#).

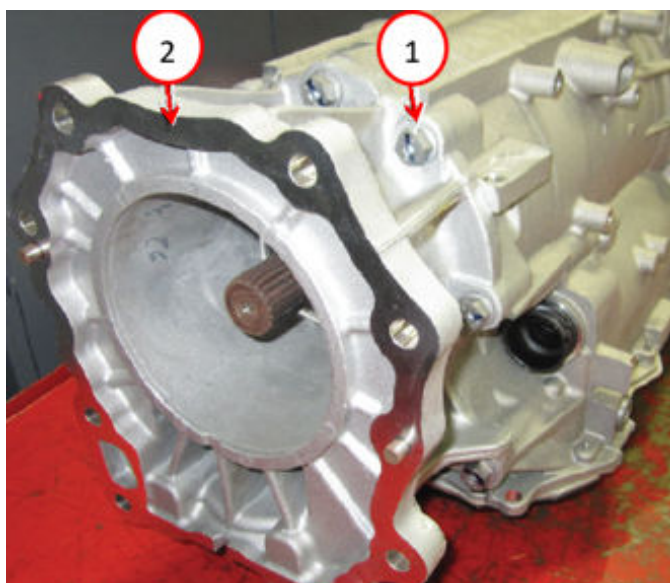

**Fig. 3**  
Extension Housing

1 - Extension Housing Bolts  
2 - Extension Housing

4. Remove the transmission output shaft seal [Fig. 4](#).

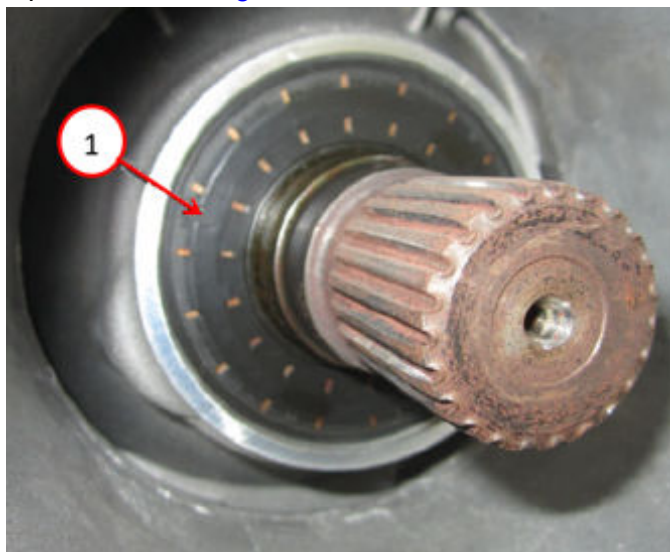
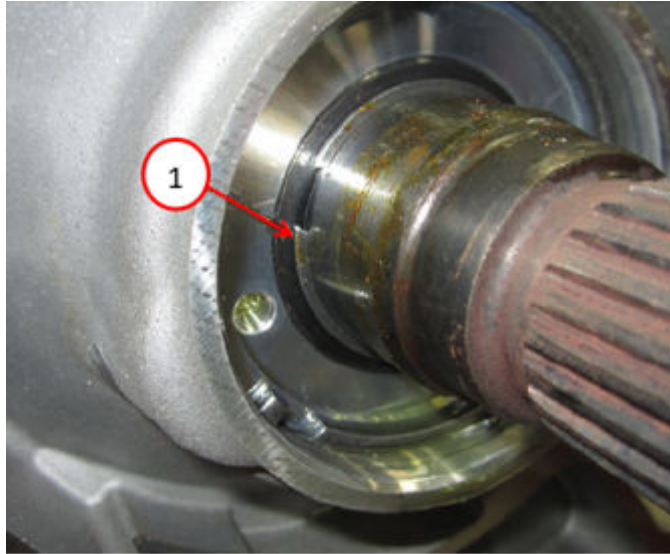

**Fig. 4**  
Transmission Output Shaft Seal

1 - Transmission Output Shaft Seal

5. Remove the output shaft snap ring [Fig. 5](#).

**NOTE: For 4X4 only.**

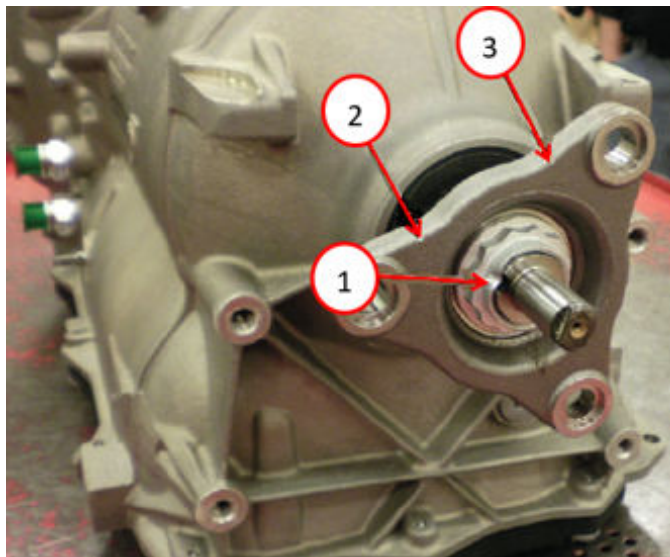

**Fig. 5**  
Output Shaft Snap Ring

1 - Output Shaft Snap Ring

6. Remove the output shaft flange locknut staking [Fig. 6](#).

**NOTE: 2WD only.**



**Fig. 6**  
Output Shaft

1 - Output Shaft Flange Locknut Staking

2 - Output Shaft Flange

3 - Output Shaft Flange

7. Using a flange holder, remove the output shaft flange nut.
8. Remove the output shaft flange and inspect the output shaft flange sealing surface for damage, replace as needed.

9. Remove the 13 transmission oil pan bolts [Fig. 7](#).

**NOTE: Inspect the gasket for reuse. If the seal is cut or torn, replace the gasket.**

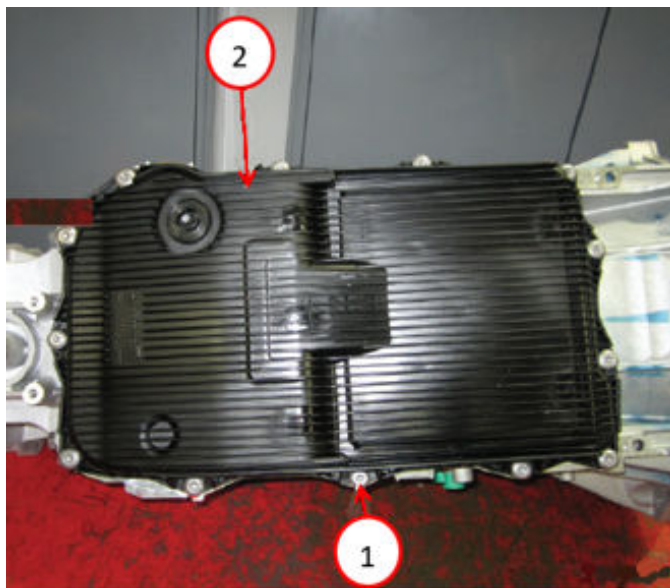
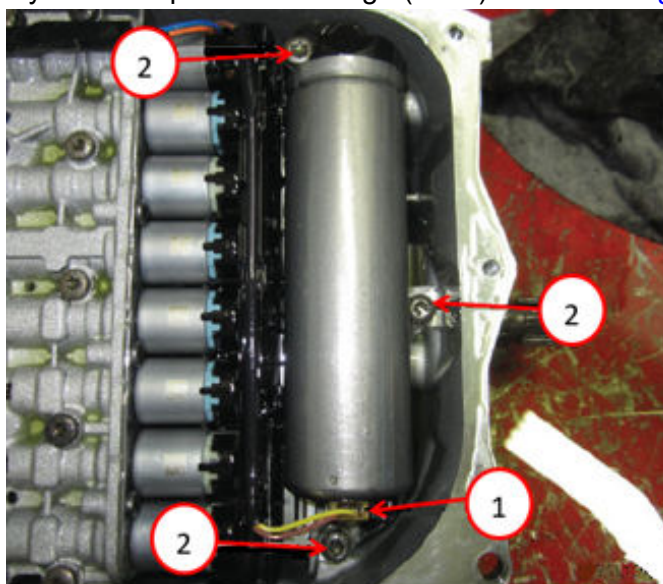

**Fig. 7**  
Transmission Oil Pan

- 1 - Transmission Oil Pan Bolts  
2 - Transmission Oil Pan

10. Carefully remove the transmission oil pan and gasket.

11. If equipped, disconnect the Hydraulic Impulse Oil Storage (H.I.S) connector [Fig. 8](#).

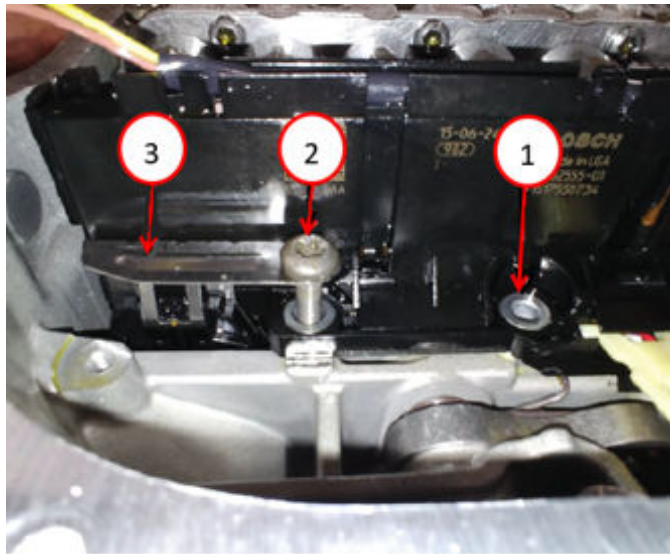

**Fig. 8**  
Hydraulic Impulse Oil Storage

- 1 - Hydraulic Impulse Oil Storage (H.I.S) Connector  
2 - Hydraulic Impulse Oil Storage (H.I.S) Bolts

12. If equipped, remove bolts and the H.I.S accumulator.

13. Remove the valve body assembly end retainer bolts [Fig. 9](#).

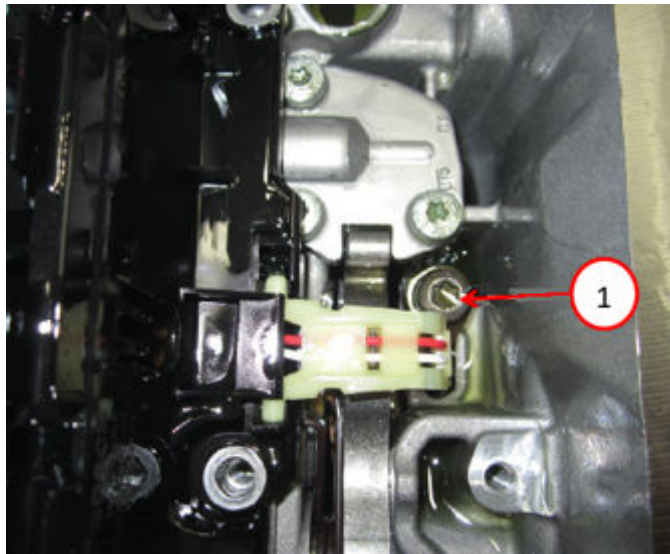

**Fig. 9**  
Valve Body Assembly

- 1 - Valve Body Assembly End Retainer Bolt
- 2 - Valve Body Assembly End Retainer Bolt
- 3 - Electrical Connector Lock

14. Lift the electrical connector lock to release the internal harness end from inside the transmission for valve body assembly removal.

15. Remove the Output Speed Sensor (OSS) bolt and gently lift the OSS out from the case [Fig. 10](#).



**Fig. 10**  
Output Speed Sensor

- 1 - Output Speed Sensor Bolt

16. Using Guide Sleeve 10377, carefully pull the electrical harness insulator straight out from the transmission case Fig. 11.

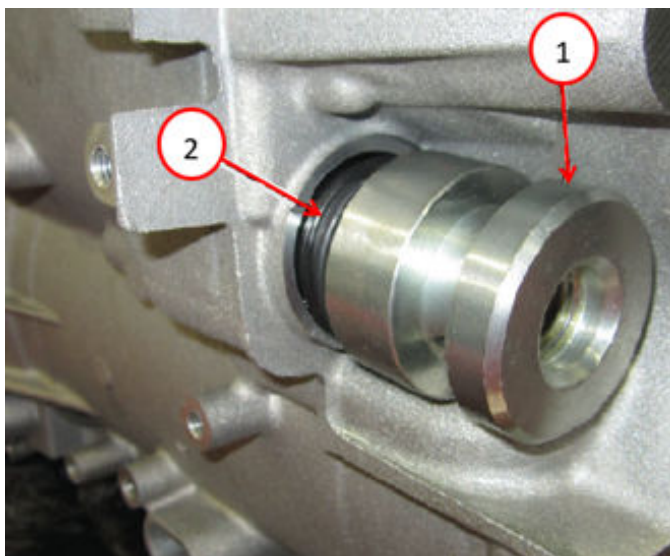

**Fig. 11**  
Electrical Harness Insulator

1 - Remover/Installer, Guide Sleeve 10377  
2 - Electrical Harness Insulator

17. Remove the valve body assembly bolts in the order shown and remove the valve body Fig. 12.

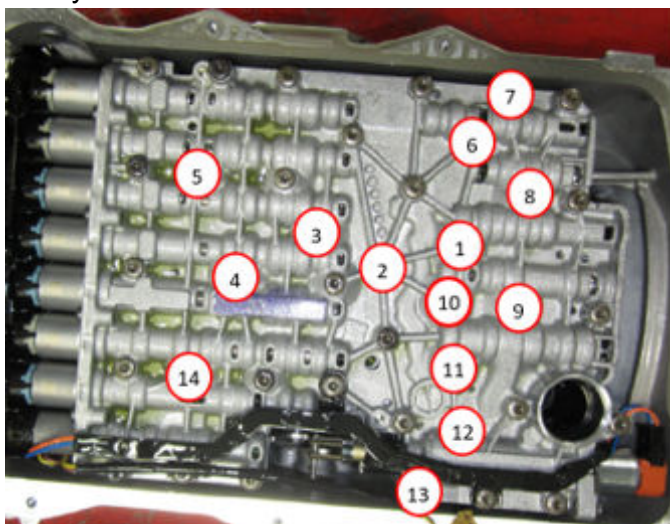

**Fig. 12**  
Valve Body Assembly

18. Remove the fluid port from the transmission or valve body assembly (the fluid port may stick in the valve body upon removal) [Fig. 13](#).

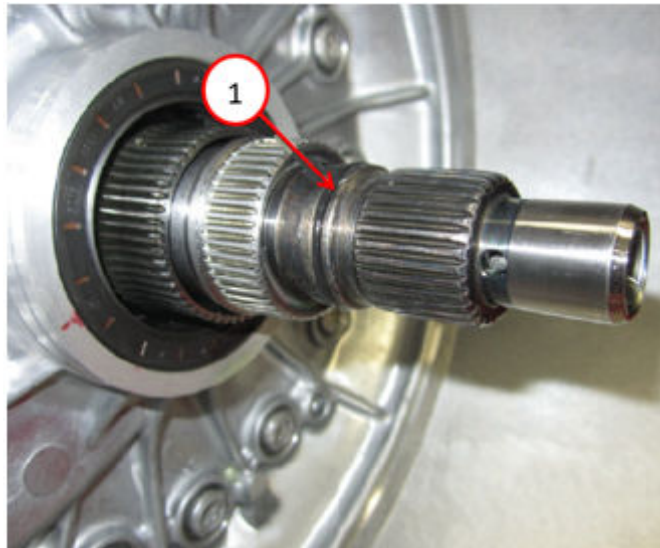

**Fig. 13**  
Fluid Port

1 - Fluid Port

---

19. Remove the fluid transfer tube and O-rings.  
20. Remove the input shaft O-ring using a small pick or equivalent [Fig. 14](#).



**Fig. 14**  
Input Shaft O-Ring

1 - Input Shaft O-ring

---

21. Remove and **DISCARD** the 14 oil pump housing bolts Fig. 15.

**NOTE:** Remove the input shaft O-ring before the oil pump is removed.

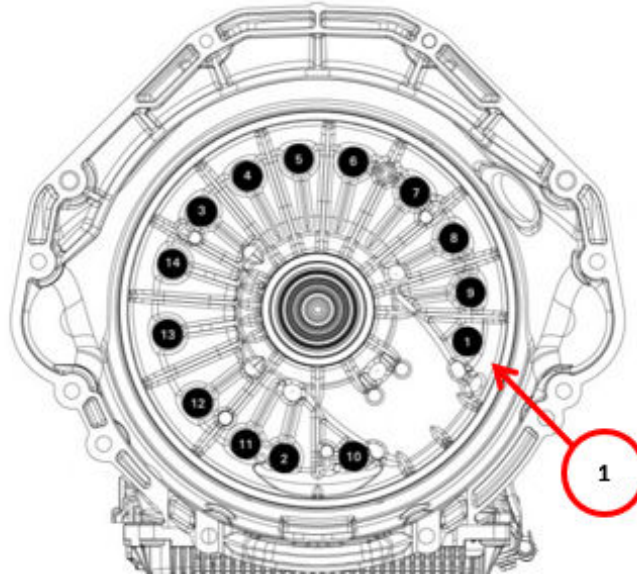

**Fig. 15**  
Oil Pump Housing

1 - Oil Pump Housing Bolts

22. Carefully pry the oil pump housing away from the case using a small flat blade screwdriver or equivalent through the case opening Fig. 16.

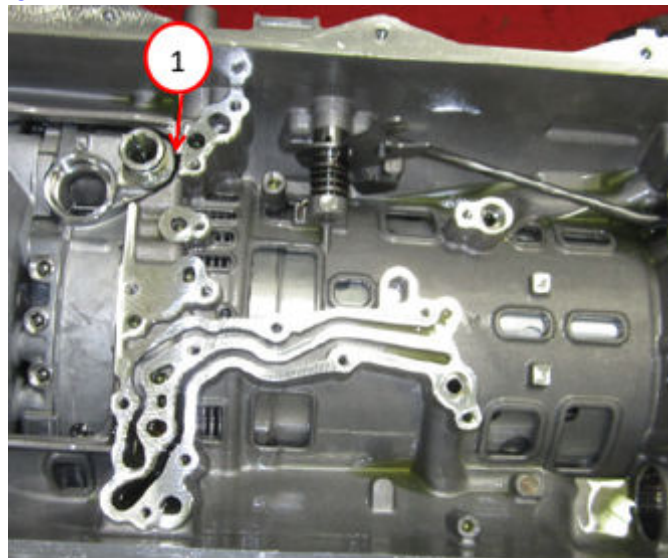
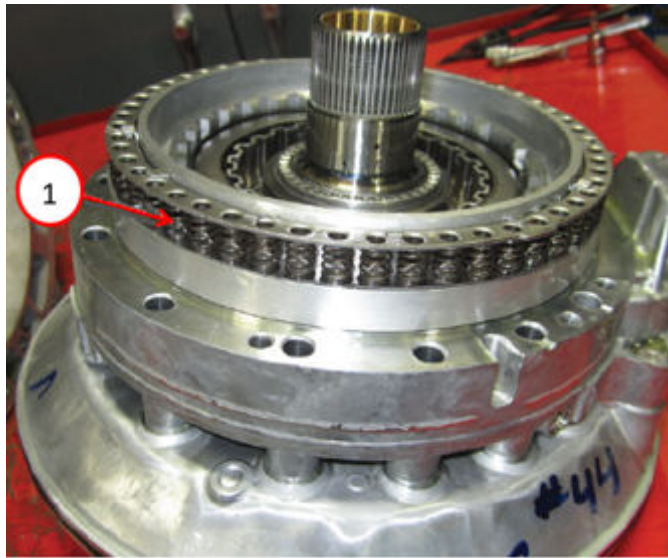

**Fig. 16**  
Oil Pump Housing Pry Point

1 - Oil Pump Housing Pry Point

23. From the front of the transmission, remove the oil pump housing.

24. Remove the B clutch spring damper [Fig. 17](#).

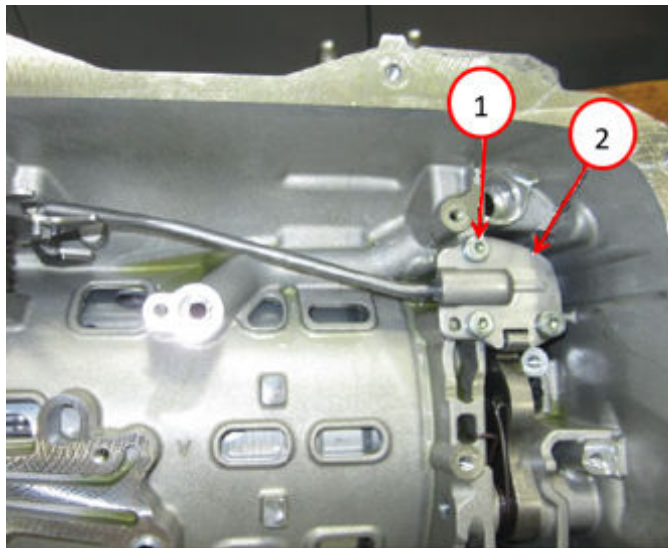

**Fig. 17**  
B Clutch Assembly

1 - B Clutch Spring Damper

25. Remove the park pawl lock rod guide plate bolts and remove the plate [Fig. 18](#).

**NOTE: The transmission must be in a vertical position before the main stack is removed, so damage to the drums does not occur.**



**Fig. 18**  
Pawl Lock Rod

1 - Pawl Lock Rod Guide Plate Bolts  
2 - Pawl Lock Rod Guide Plate

26. Remove the input/output shaft and P4 annulus drum assembly from the case [Fig. 19](#).

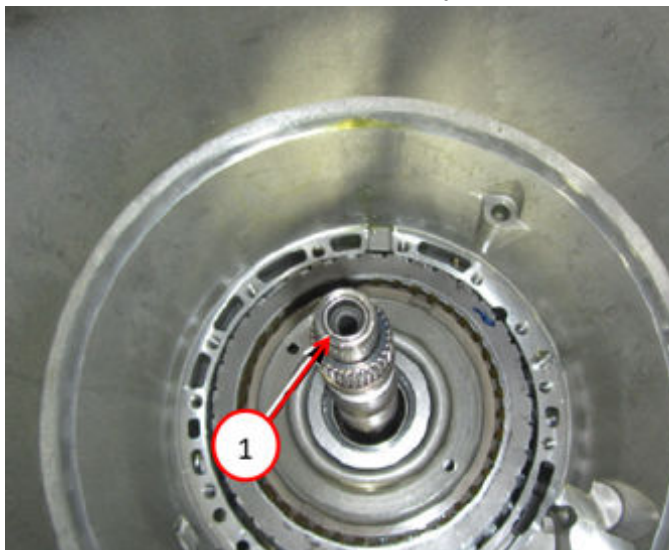

**Fig. 19**  
P4 Annulus Drum Assembly

1 - P4 Annulus Drum Assembly

27. Position the input/output shaft and P4 annulus drum assembly on a press fixture [Fig. 20](#).

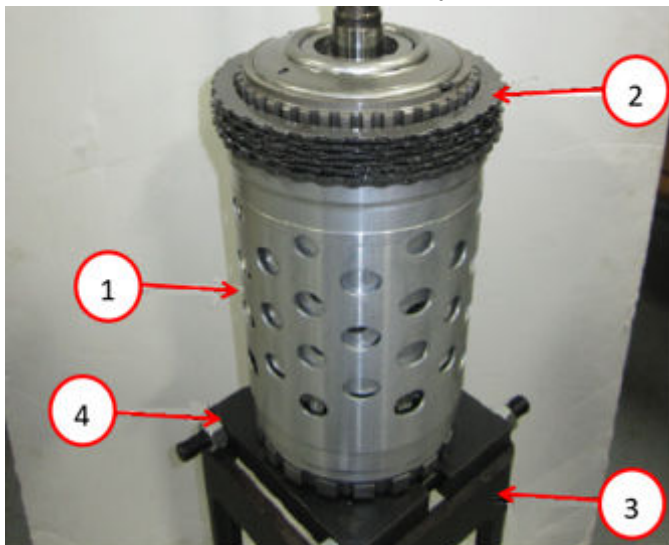

**Fig. 20**  
Input/Output Shaft And P4 Annulus Drum Assembly

1 - Input/Output Shaft And P4 Annulus Drum Assembly  
2 - B Clutch Pack  
3 - Assembly, Press Fixture 8925-3  
4 - Splitter, Bearing/Gear 1130

28. Remove the B clutch pack.

29. Remove the P1 annulus/B clutch hub assembly from the P4 annulus drum [Fig. 21](#).



**Fig. 21**  
P1 Annulus/B Clutch Hub Assembly

1 - P1 Annulus/B Clutch Hub Assembly

---

30. Remove the thrust bearing and holding plate from the P1 planetary carrier.

**NOTE:** There are three pieces intended to be used in multiple locations around the drum to prevent damage from prying [Fig. 22](#).

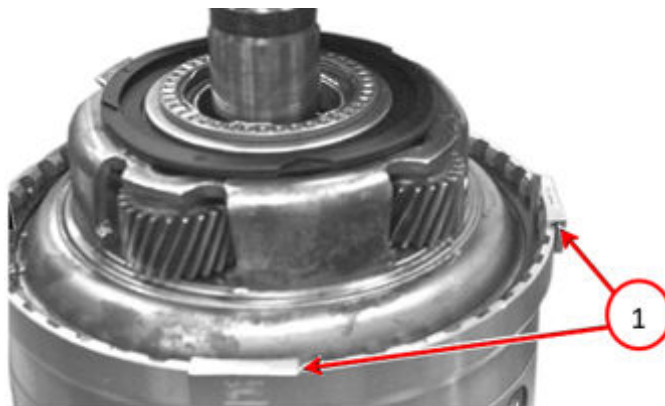

**Fig. 22**  
Rings Support

1 - Rings Support

---

31. Position the rings support on the P4 annulus drum assembly to protect the drum [Fig. 23](#).

**NOTE: Pry the snap ring from the opposite side of the snap ring openings to release.**

**NOTE: When the snap ring is removed the internal clutch drum may drop slightly.**



**Fig. 23**  
Snap Ring

- 1 - Snap Ring
- 2 - Snap Ring Openings

32. Using a suitable tool release the snap ring by prying in and up from the opposite side of the snap ring openings.

33. Remove the P1 planetary carrier.

34. Remove the input shaft with P2 planetary carrier from the drum assembly [Fig. 24](#).

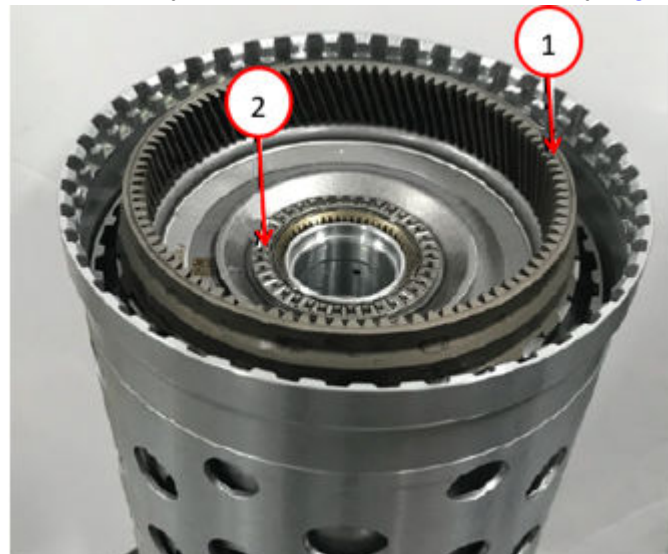
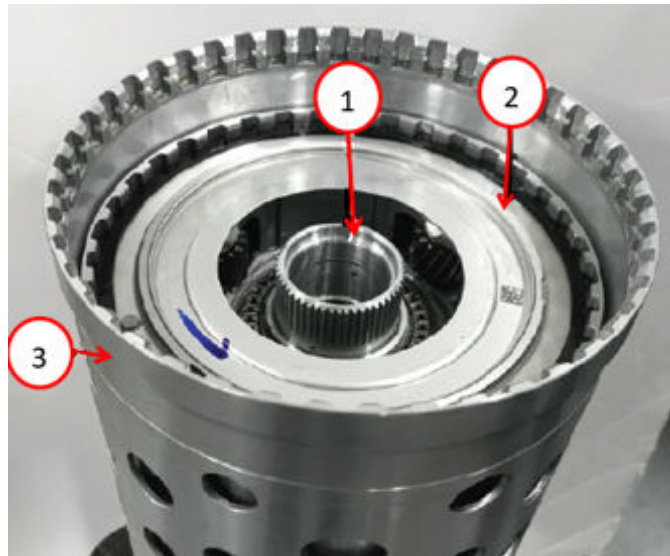

**Fig. 24**  
Input Shaft

- 1 - Input Shaft With P2 Planetary Carrier
- 2 - Thrust Bearing And Washer

35. Remove the thrust bearing and washer.

36. Remove the P2 annulus/P3 sun gear from the drum assembly [Fig. 25](#).



**Fig. 25**  
P4 Annulus Drum

- 1 - P2 Annulus/P3 Sun Gear
- 2 - D Clutch Drum
- 3 - P4 Annulus Drum

37. Remove the D clutch drum from the P4 annulus drum.

**NOTE: There are three pieces intended to be used in multiple locations around the drum to prevent damage from prying.**

38. Remove the P4 planetary carrier/output shaft lock ring from the P4 annulus drum by gently prying the locking tabs open and turning the lock ring to center the locating tabs in the output shaft tab openings. **Discard** the lock ring and install a **NEW** lock ring during assembly [Fig. 26](#).

**NOTE: Heavy duty park system only.**

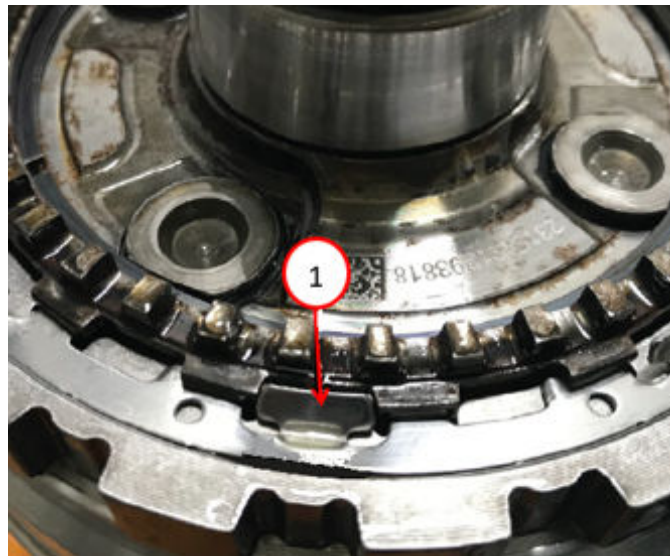

**Fig. 26**  
P4 Planetary Carrier

- 1 - P4 Planetary Carrier/Output Shaft Lock Ring Locking Tabs

**CAUTION!**

A unique transmission fluid has been developed for this transmission. This fluid is **NOT** compatible with ATF+4 or any other current FCA US LLC transmission fluid. For specifics about this unique fluid see **FLUIDS, LUBRICANTS AND GENUINE PARTS**.

**CAUTION!**

The Transmission Control Module (TCM), or Transmission Control Module Assembly (TCMA) is extremely sensitive to Electrostatic Discharge (ESD). Always use a ground strap and follow the ESD guidelines in Electrostatic Discharge Sensitive Devices. Failure to follow these instructions may result in damage to the TCM/TCMA.

**NOTE:** If the transmission is being reconditioned (clutch/seal replacement) or replaced, it is necessary to perform the TCM Adaptation Procedure. Refer to the detailed service procedures available in DealerCONNECT/Service Library under: **Service Info> 08 - Electrical/8E - Electronic Control Modules/Module, Transmission Control/ Module Programming.**

39. Install a **NEW** P4 planetary carrier/output shaft assembly into the P4 annulus drum and install park gear if one was removed from old assembly.
40. Install the **NEW** P4 planetary carrier/output shaft lock ring from the P4 annulus drum by turning the lock ring to center the lock ring tabs in the output shaft tab openings and gently staking the locking tabs closed [Fig. 27](#).

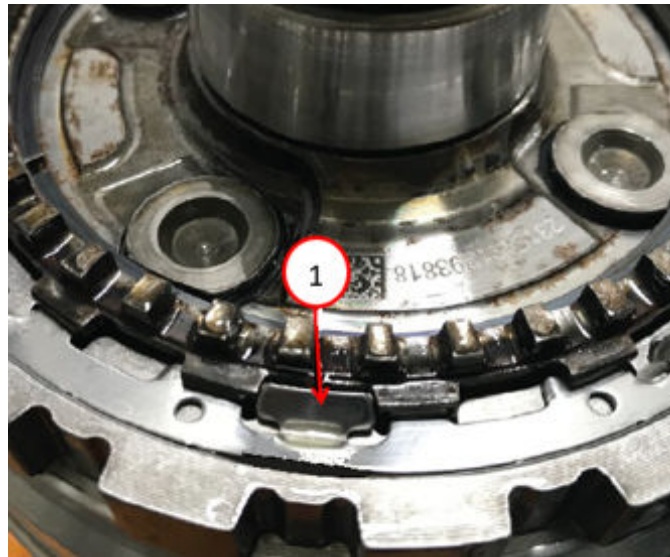

**Fig. 27**  
P4 Planetary Carrier

41. Install the D clutch drum into the P4 annulus drum [Fig. 28](#).

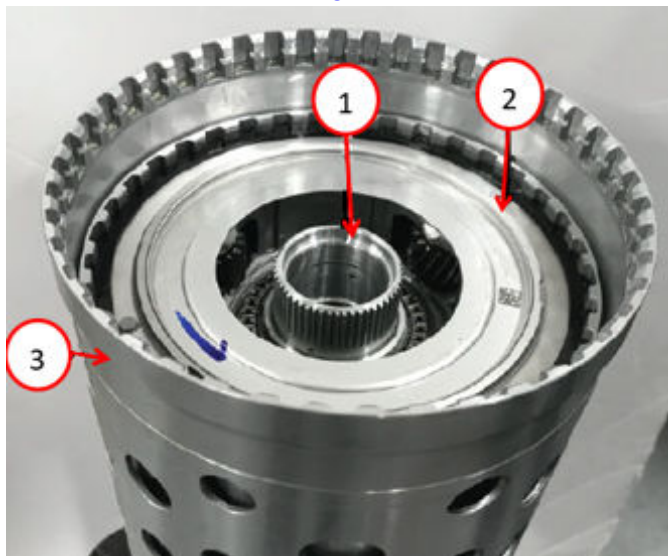

**Fig. 28**  
P4 Annulus Drum

- 1 - P2 Annulus/P3 Sun Gear
- 2 - D Clutch Drum
- 3 - P4 Annulus Drum

42. Install the P2 annulus/P3 sun gear in the drum assembly [Fig. 29](#).

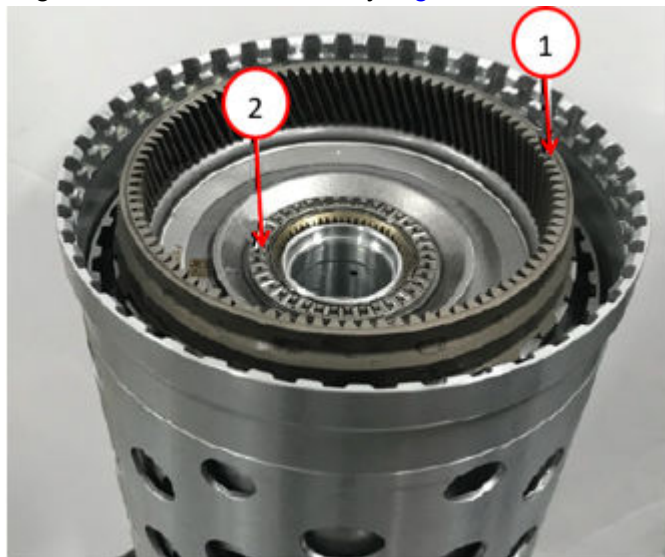
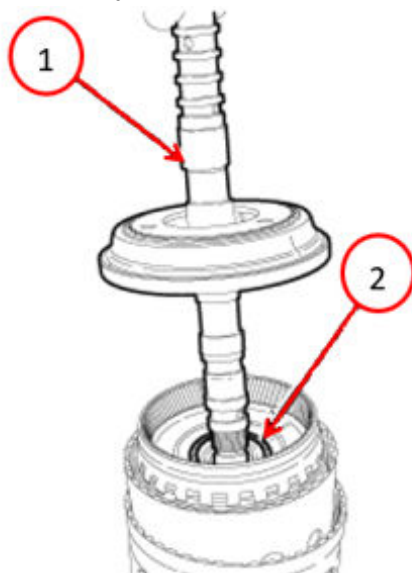

**Fig. 29**  
Input Shaft

- 1 - Input Shaft With P2 Planetary Carrier
- 2 - Thrust Bearing And Washer

43. Install the thrust bearing and washer.

44. Install the input shaft with P2 planetary carrier into the drum assembly [Fig. 30](#).



**Fig. 30**  
Input Shaft

- 1 - Input Shaft
- 2 - P2 Planetary Carrier

45. Install the snap ring in the orientation shown (snap ring will only install one way) with the locating tabs [Fig. 31](#).



**Fig. 31**  
Snap Ring

- 1 - Snap Ring
- 2 - Snap Ring Openings

46. Install the thrust bearing and holding plate onto the P1 planetary carrier.

47. Install the selectable shim to the P1 annulus/B clutch hub.

48. Install the P1 annulus\B clutch hub assembly onto the P4 annulus drum [Fig. 32](#).

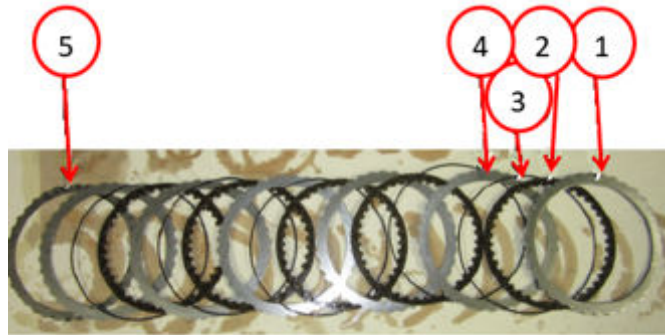

**Fig. 32**

P1 Annulus/B Clutch Hub Assembly

1 - P1 Annulus/B Clutch Hub

49. The B clutch, dependent on transmission Julian Date, may contain wave springs that sit around each fiber. There will be five friction plates (discs), five wave springs, five steel plates, one cover plate, one snap ring, and one wave plate (last plate far left in figure) [Fig. 33](#).

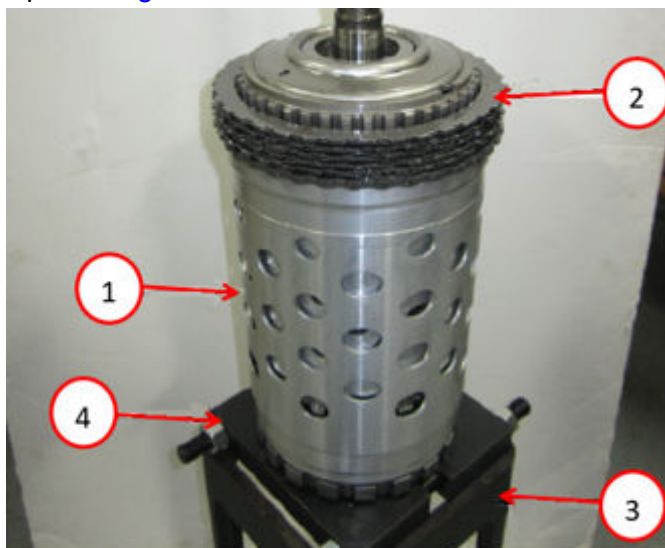

**Fig. 33**

Plates

1 - Cover Plate  
2 - Friction Plates  
3 - Wave Springs  
4 - Steel Plates  
5 - Wave Plate

50. Install the B clutch discs and plates [Fig. 34](#).



**Fig. 34**

Input/Output Shaft And P4 Annulus Drum Assembly

- 1 - Input/Output Shaft And P4 Annulus Drum Assembly
- 2 - B Clutch Pack
- 3 - Assembly, Press Fixture 8925-3
- 4 - Splitter, Bearing/Gear 1130

51. Install the snap ring.

**NOTE: The transmission must be in a vertical position when installing the main stack, so damage to the drums does not occur.**

52. Install the input/output shaft and P4 annulus drum assembly into the case [Fig. 35](#).

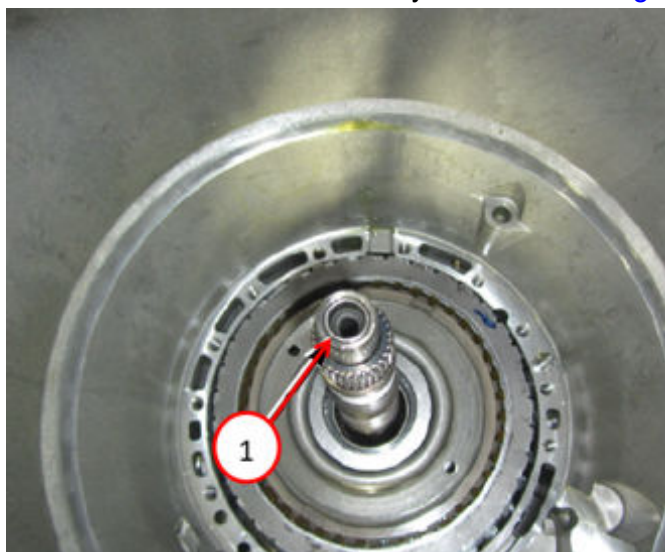
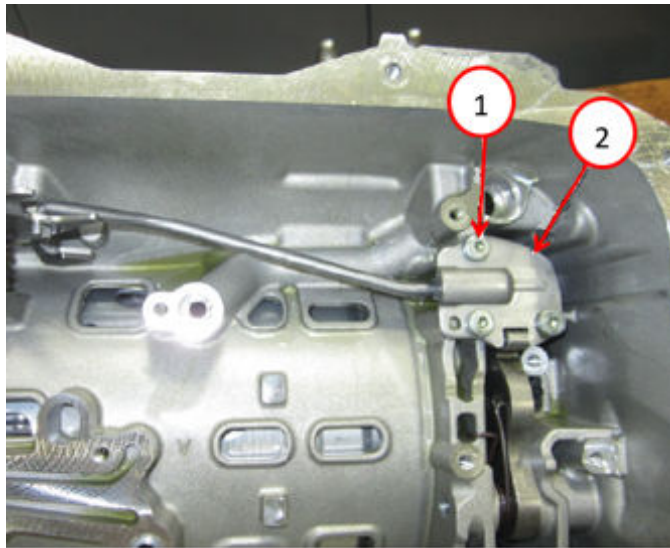

**Fig. 35**

P4 Annulus Drum Assembly

- 1 - P4 Annulus Drum Assembly

53. Install the park pawl lock rod onto the fork [Fig. 36](#).

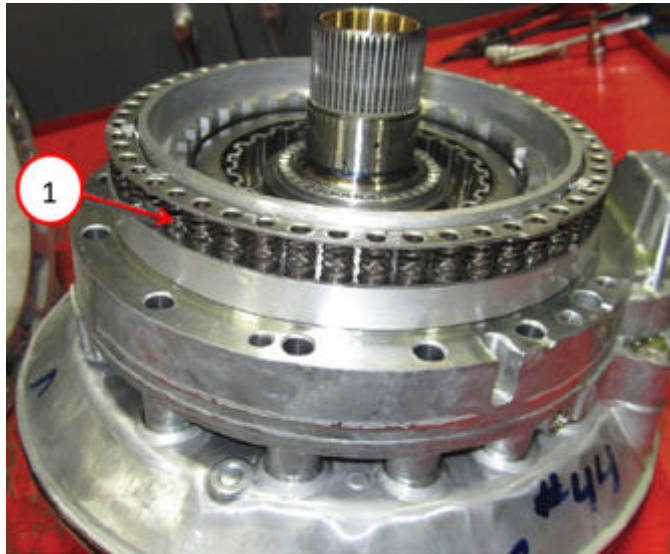

**Fig. 36**  
Pawl Lock Rod

1 - Pawl Lock Rod Guide Plate Bolts  
2 - Pawl Lock Rod Guide Plate

54. Position the park pawl lock rod guide plate, install the three park pawl lock rod guide plate retaining bolts. Tighten the bolts to 10 N-m (89 In. Lbs.).

55. Install the B clutch damper spring on the assembly [Fig. 37](#).



**Fig. 37**  
B Clutch

1 - B Clutch Spring Damper

56. Carefully position the oil pump housing assembly into the case.

57. Install the **NEW** input shaft O-ring [Fig. 38](#).

**NOTE:** Firmly press the oil pump in place before drawing it in with bolts.

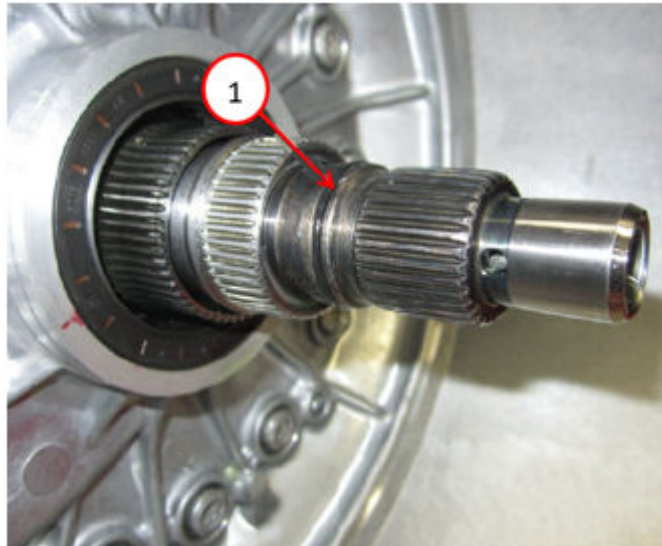
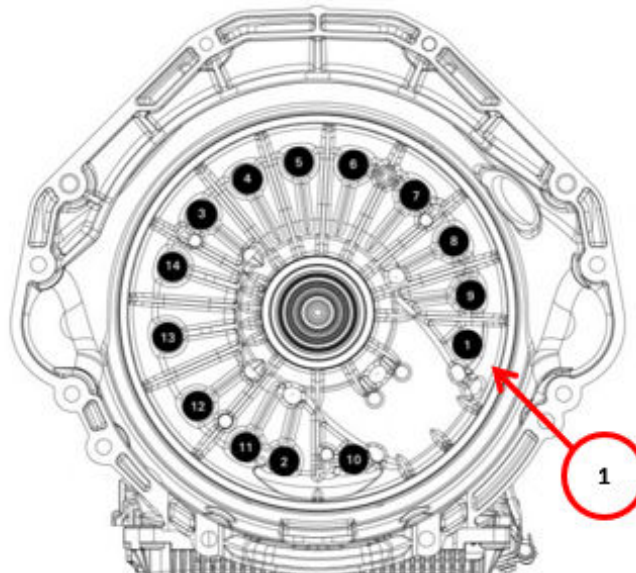

**Fig. 38**  
Input Shaft O-Ring

1 - Input Shaft O-Ring

58. Install the **NEW** oil pump cover retaining bolts and tighten the bolts as follows: Install the transmission oil pump assembly and secure using 14 **NEW** pump housing bolts [Fig. 39](#).

- a. In order to seat the oil pump cover properly, pre tighten bolts one, seven and nine to 6 N·m (53 in. lb.).
- b. Working in a clockwise pattern, beginning with number one, tighten to 10 N·m (89 in. lb.).
- c. Working in a clockwise pattern, beginning with number one, tighten an additional 90°.

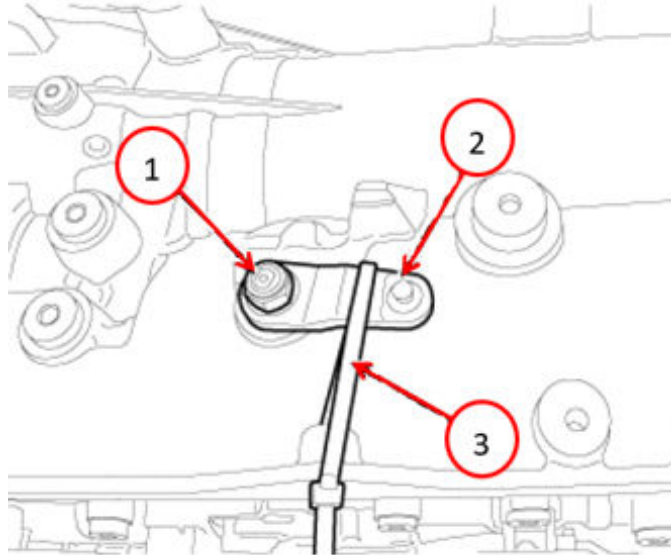

**Fig. 39**  
Oil Pump Housing

1 - Oil Pump Housing Cover And Bolts

59. Temporarily install the MPR lever to release tension on the shift fork as follows [Fig. 40](#):

- a. Install the MPR lever 180 degrees offset from its original position.
- b. Install the MPR retaining nut and hand tighten.
- c. Turn the MPR lever and using a tie strap, secure the lever into position so the park release fork is in the same position as it was before valve body assembly removal.



**Fig. 40**  
Manual Park Release

- 1 - MPR Lever Retaining Nut  
2 - MPR Lever  
3 - Tie Strap

60. Install **NEW** fluid transfer tube O-rings and install the fluid transfer tube to the transmission case [Fig. 41](#).

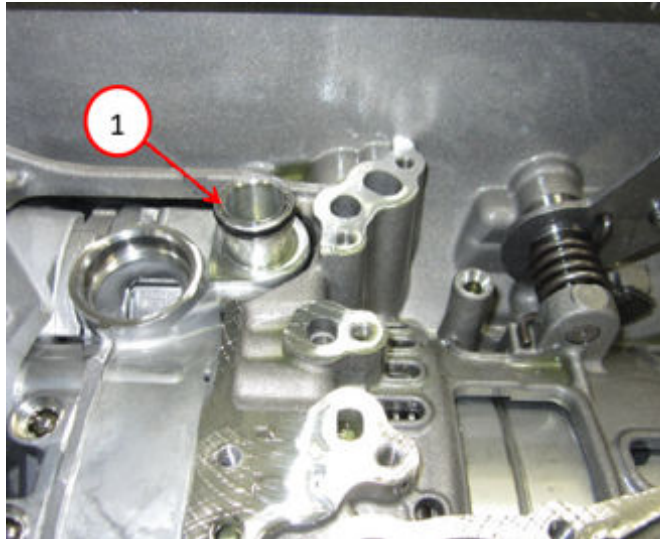

**Fig. 41**  
Fluid Port

- 1 - Fluid Tube

61. Install the valve body assembly alignment pins in the transmission case as guides for the valve body assembly.

**NOTE: Make sure the shift fork lines up properly.**

62. Using the valve body assembly alignment pins position the valve body assembly to the transmission.

**NOTE: After several bolts have been hand tightened, remove the guide pins.**

63. Install the valve body assembly bolts Fig. 42. Tighten the bolts to 8 N-m (71 In. Lbs.).

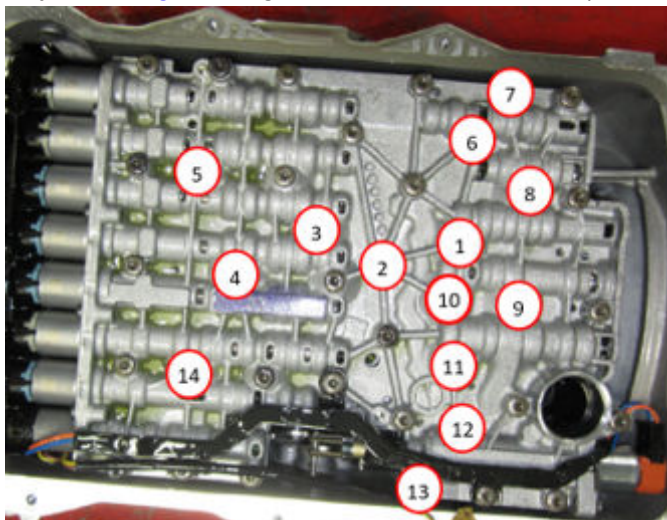

**Fig. 42**  
Valve Body Assembly

64. Using Guide Sleeve 10377, carefully install the electrical harness guide sleeve into the transmission case Fig. 43.

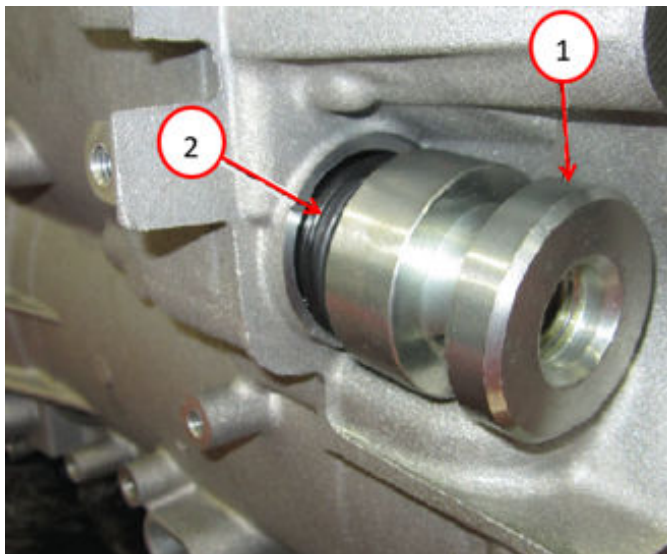
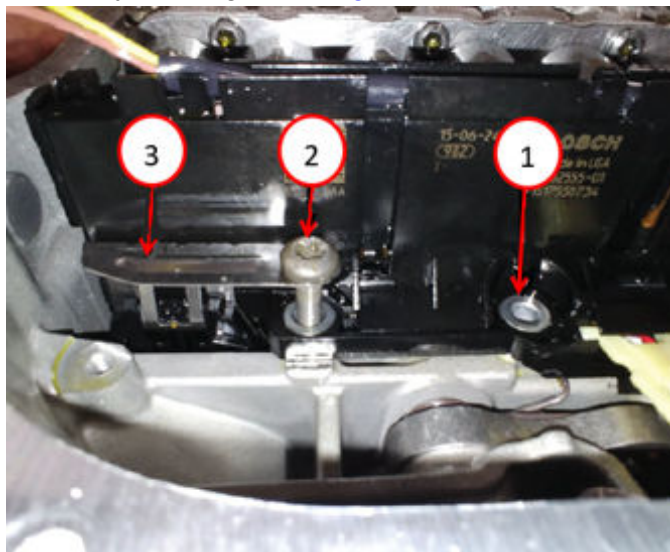

**Fig. 43**  
Electrical Harness Insulator

---

1 - Remover/Installer, Guide Sleeve 10377  
2 - Electrical Harness Insulator

65. Latch the electrical connector lock by pushing down [Fig. 44](#).

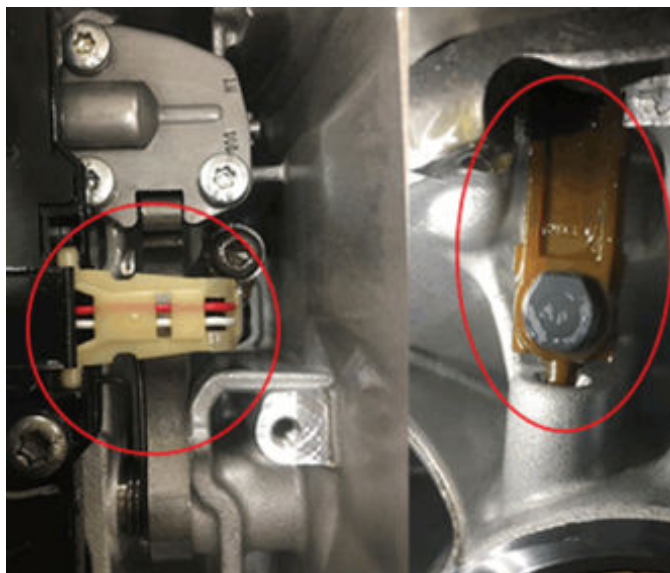

**Fig. 44**  
Valve Body Assembly

- 1 - Valve Body Assembly End Retainer Bolt
- 2 - Valve Body Assembly End Retainer Bolt
- 3 - Electrical Connector Lock

66. Install the valve body assembly end bolt and electrical connector lock bolt. Tighten the valve body end bolt to 8 N-m (71 In. Lbs.).

67. When installing the OSS into the case, take care to position the OSS guide pin [Fig. 45](#) or damage to the sensor may result [Fig. 46](#).



**Fig. 45**  
Correct Output Speed Sensor Pin Alignment

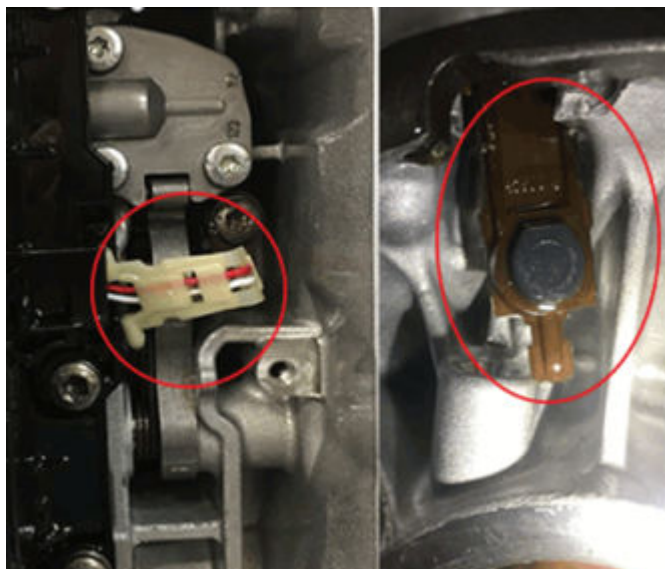

**Fig. 46**

Incorrect OSS Pin Alignment

68. If equipped, install the HIS and bolts [Fig. 48](#). Tighten the HIS bolts to 8 N-m (71 In. Lbs.).

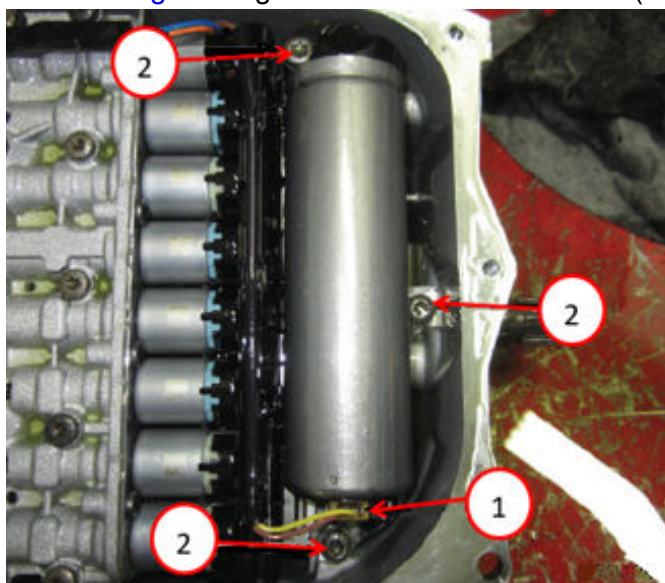
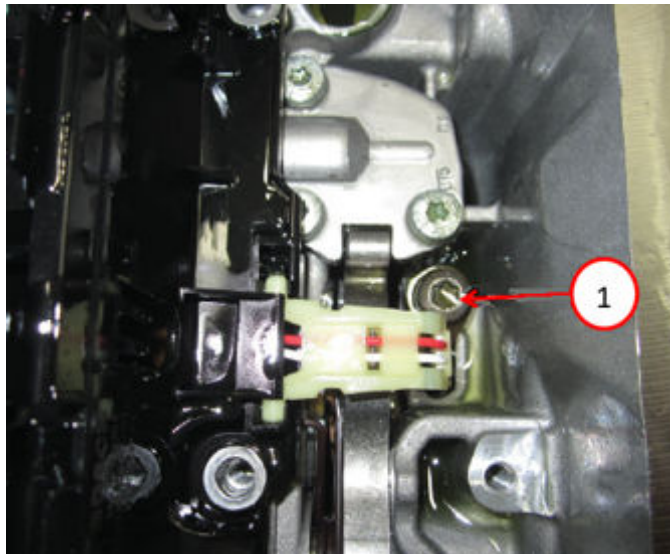

**Fig. 47**

Hydraulic Impulse Oil Storage

- 1 - Hydraulic Impulse Oil Storage (HIS) Connector
  - 2 - Hydraulic Impulse Oil Storage (HIS) Bolts
-

69. Install the OSS and tighten the OSS bolt to 8 N-m (71 In. Lbs.) [Fig. 47](#).

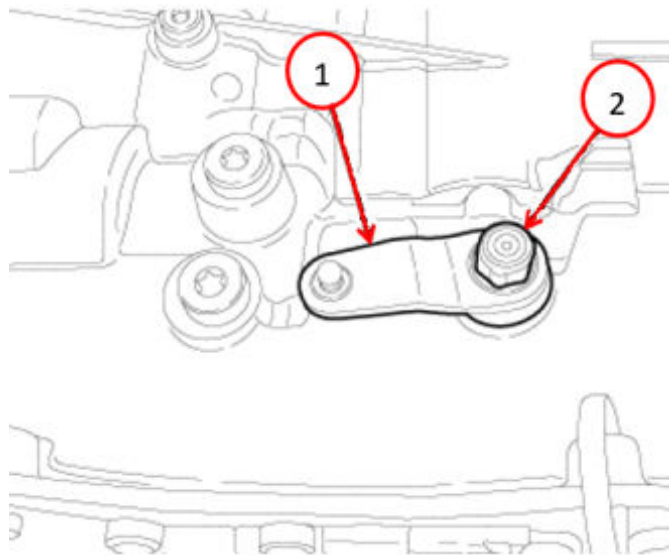

**Fig. 48**  
Output Speed Sensor

1 - Output Speed Sensor Bolt

70. Connect the HIS wire harness connector.

71. Remove the tie strap and return the MPR lever to its original position [Fig. 49](#).



**Fig. 49**  
Manual Park Release

1 - MPR Lever

2 - MPR Lever Retaining Nut

72. Install the MPR lever nut and tighten to 12 N-m (9 Ft. Lbs.).

73. Position the transmission oil pan and gasket [Fig. 50](#).

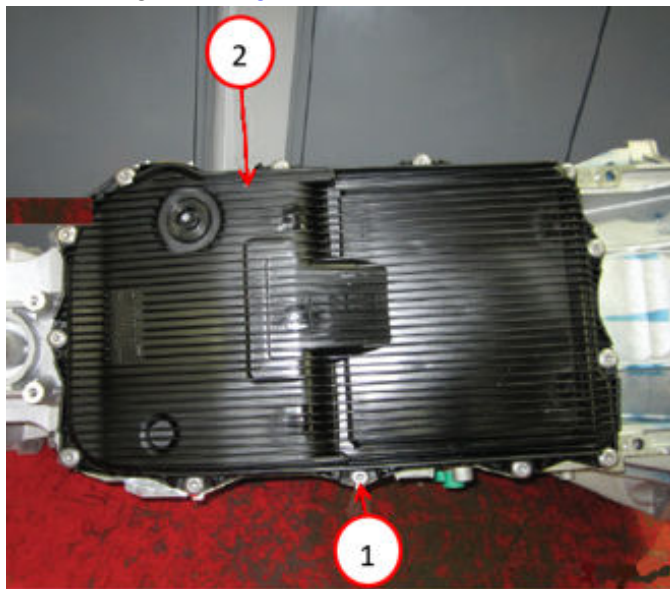

**Fig. 50**

Transmission Oil Pan Assembly

- 1 - Transmission Oil Pan Bolts
- 2 - Transmission Oil Pan

74. Install the 13 transmission oil pan bolts and tighten to 10 N-m (89 In. Lbs) [Fig. 50](#).

**NOTE: For 4X4 only.**

**CAUTION!**

**The seal must be installed flush with the case. Driving the seal deeper could damage the seal causing a leak.**

75. Position the **NEW** output shaft seal over the output shaft and against the transmission case [Fig. 51](#).

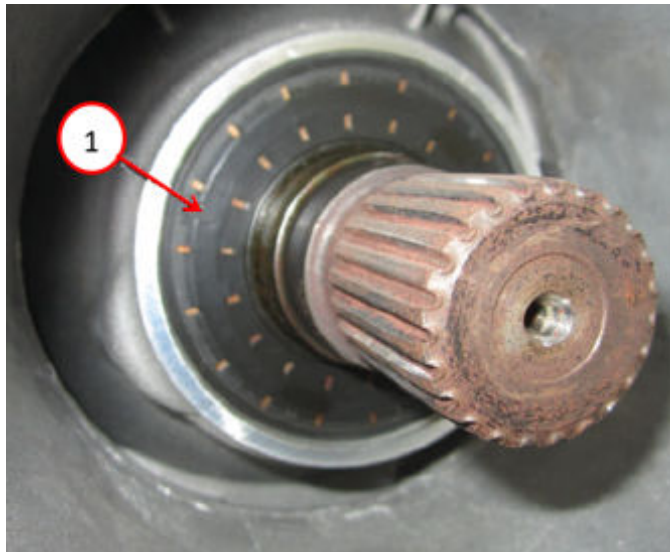
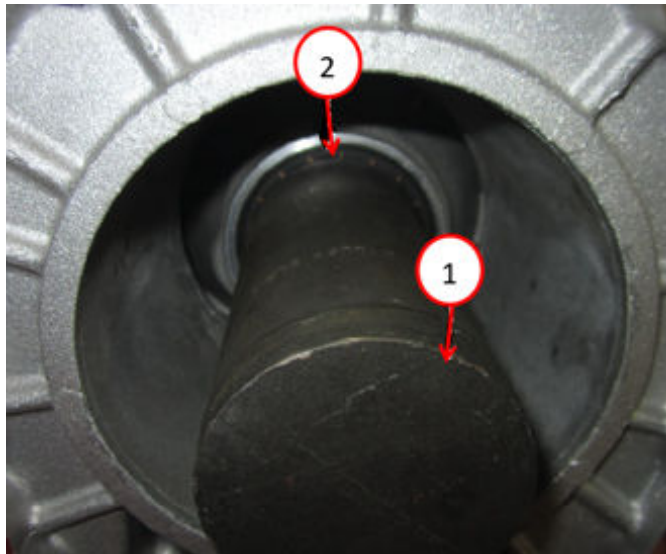

**Fig. 51**

Transmission Output Shaft Seal Installed

- 1 - Transmission Output Shaft Seal

76. Using Seal Installer 9677, install the output shaft seal [Fig. 52](#).



**Fig. 52**  
Output Shaft Installed

- 1 - Seal Installer
- 2 - Output Shaft Seal

77. **For 4X4 ONLY if equipped**, position the extension housing and install the extension housing bolts [Fig. 53](#) to 27 N-m (20 Ft. Lbs.).

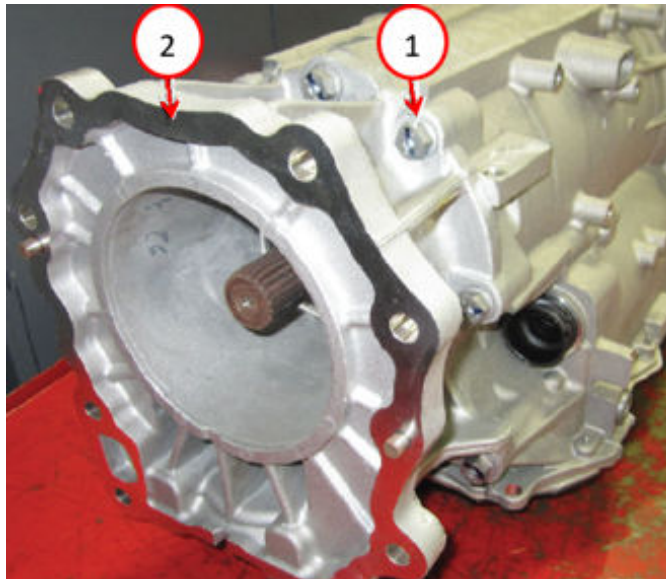

**Fig. 53**  
Extension Housing

- 1 - Extension Housing Bolts
- 2 - Extension Housing

78. For 2WD vehicles, remove and **DISCARD** the seal from the output flange and replace it with a **NEW** seal Fig. 54.

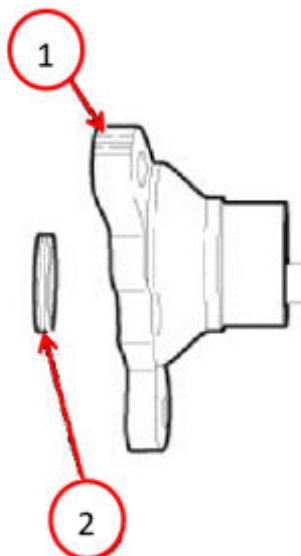

**Fig. 54**  
Output Flange And O-Ring

- 1 - Output Flange
- 2 - O-Ring

79. For 2WD vehicles, install the output shaft flange Fig. 55 using a **NEW** output flange nut and washer. Use a 34 mm, 12 point socket end to hold the flange during installation.

**CAUTION!**

The nut must be staked to prevent vibration from backing the nut out or loose.

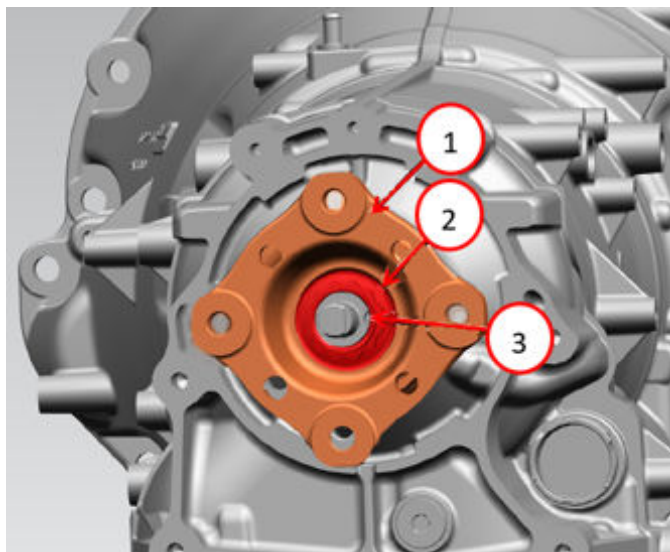

**Fig. 55**  
Transmission Output Flange

- 1 - Transmission Output Flange
- 2 - Transmission Output Flange Nut
- 3 - Transmission Output Flange Nut Stake

80. Install the torque converter [Fig. 56](#) Refer to the detailed service procedures available in DealerCONNECT/Service Library under: Service Info> 21 - Transmission and Transfer Case/Automatic/Torque Converter/Installation.

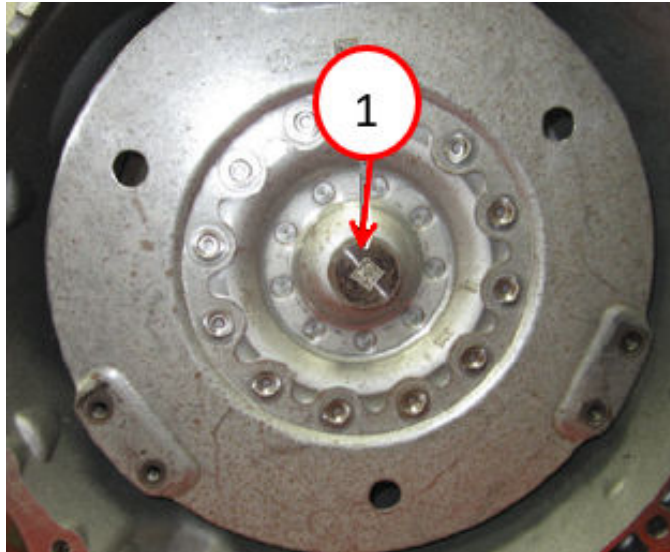

**Fig. 56**  
Torque Converter

1 - Torque Converter

81. For WL 4x4 only, install the O-ring/seal to the output shaft [Fig. 57](#).

**NOTE: Seal color can vary for this O-ring/seal.**



**Fig. 57**  
WL Output Shaft Seal

1 - WL Output Shaft Seal

82. Before installing the transmission in the vehicle, pre-fill the transmission as outlined in Fill Transmission After Service. Refer to the detailed service procedures available in DealerCONNECT/Service Library under: Service Info>21 - Transmission and Transfer Case/Automatic/Standard Procedure.
83. Install the transmission. Refer to the detailed service procedures available in DealerCONNECT/Service Library under: Service Info>21 - Transmission and Transfer Case / Automatic - 8HP50/850RE / Installation.

84. Use wiTECH to complete Quick Learn Procedure and clear any DTCs.

**POLICY:**

Reimbursable within the provisions of the warranty.

*This bulletin is supplied as technical information only and is not an authorization for repair. No part of this publication may be reproduced, stored in a retrieval system, or transmitted, in any form or by any means, electronic, mechanical, photocopying, or otherwise, without written permission of FCA US LLC.*