

Sports Exhaust System - Silver (OP8) / Dark Bronze (OP9)

Vehicle Type: **Cayenne E-Hybrid (9YA) / Cayenne S E-Hybrid (9YA)**
including associated coupé variants (9YB)

Model Year: **As of 2024**

Engine Type: **DCB** (basic engine – T91 / DC5) = 3.0-liter V6 turbo engine

- **DCBG** = Cayenne E-Hybrid = 224 kW (304 hp) / system power 346 kW (470 hp)
- **DCUA** = Cayenne S E-Hybrid = 260 kW (353 hp) / system power = 382 kW (519 hp)

Restrictions: Vehicles from **model year 2025 (S): ONLY** approved together with BOSE® Surround Sound System (9VL) or Burmester® 3D High-End Surround Sound System (9VJ)!

Cause: **Retrofitting**

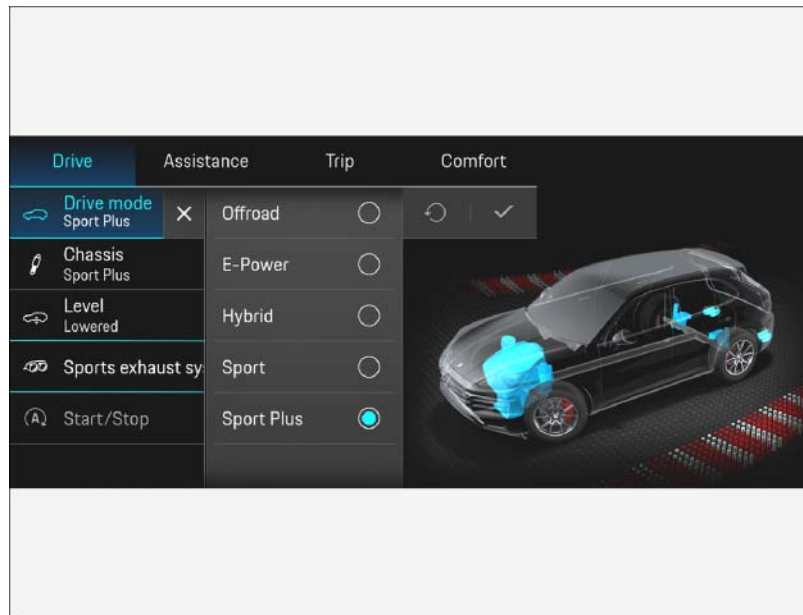

Figure 1

Notes: In the sports exhaust system, the signal for activating the flaps in the rear silencers (NSD) comes from the respective current map in the DME control unit. The driving status and accelerator pedal position, for example, are decisive factors.

The sports exhaust system can be switched on and off separately using the Porsche Communication Management system (PCM ⇒ Figure 1). To do this, select the menu "Car", then "Drive" and then "Exhaust system".

The sports exhaust system is also active in the "SPORT" or "SPORT PLUS" driving modes.

The engine power and exhaust behavior of the vehicle are not affected.

Under the individual equipment "OP8 - Sport exhaust system (tailpipe in silver)" or "OP9 - Sport exhaust system (tailpipe in dark bronze)", the sport exhaust system is also available ex works for new vehicles.

Parts Info:

ONLY for vehicles WITHOUT petrol particulate filter (PPF; emissions concept = 0GB / 7CE / 7GH / 7MM):

9Y0.044.234

⇒ Sports exhaust system (OP8) –Tailpipe in silver–, set

9Y0.044.234.A

⇒ Sports exhaust system (OP9) –Tailpipe in dark bronze–, set

N .105.184.05¹

1 x

⇒ Cheese head bolt with multiple-tooth socket head, self-locking (universal joint for steering gear)

¹ Also order the following **IF** necessary!

Parts List:

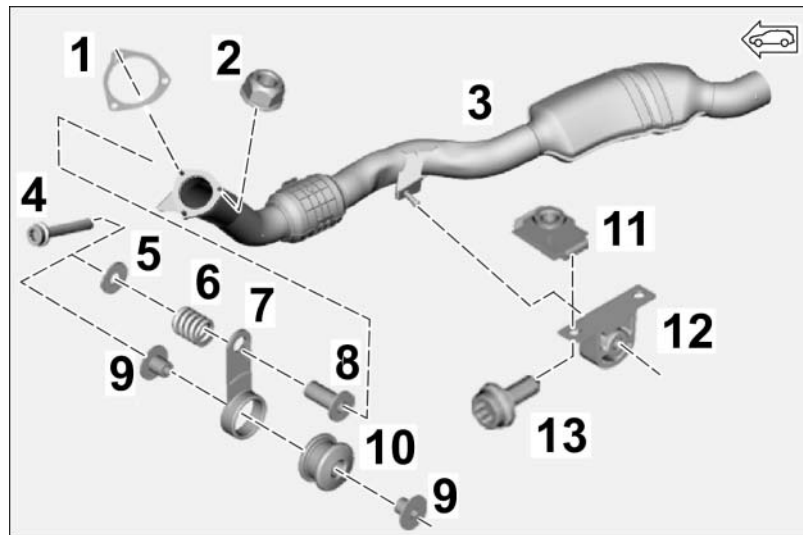

Figure 2

Scope of exhaust system – exhaust pipe area with front silencer (⇒ Figure 2 for vehicle WITHOUT PPF):

PAB.253.115.20	1 x	Seal (exhaust pipe / manifold) ⇒ Figure 2-1-
PAF.911.308	3 x	Hexagon collar nut, M8, self-locking (flange manifold) ⇒ Figure 2-2-
9Y0.253.301.G	1 x	Assembly (ASSY) exhaust pipe with front silencer (– PPF) ⇒ Figure 2-3-
N.106.720.01	2 x	Cheese head bolt with multiple-tooth internal M8 x 50 (tab on exhaust pipe / transmission) ⇒ Figure 2-4-
PAF.011.670.26	1 x	Washer, 8.4 x 24 x 2 (tab on exhaust pipe) ⇒ Figure 2-5-
PAB.253.353.00	1 x	Pressure spring (tab) ⇒ Figure 2-6-

PAC.253.295	1 x	Tab AL552 ⇒ <i>Figure 2-7-</i>
PAB.253.205.00	1 x	Spacer tube, Ø 24 x 32 (upper tab) ⇒ <i>Figure 2-8-</i>
PAB.253.205.A	2 x	Spacer tube, Ø 30 x 16 (lower tab) ⇒ <i>Figure 2-9-</i>
PAB.253.149	1 x	Rubber bush, Ø 42 x 29 (lower tab) ⇒ <i>Figure 2-10-</i>
4H0.821.213	2 x	Speed nut 28 x 18 x 11 ⇒ <i>Figure 2-11-</i>
PAB.253.099.00	1 x	Exhaust pipe holder with front silencer ⇒ <i>Figure 2-12-</i>
N.107.367.01	2 x	Cheese head bolt with internal multiple-tooth socket M8 x 20 (exhaust pipe holder with front silencer) ⇒ <i>Figure 2-13-</i>

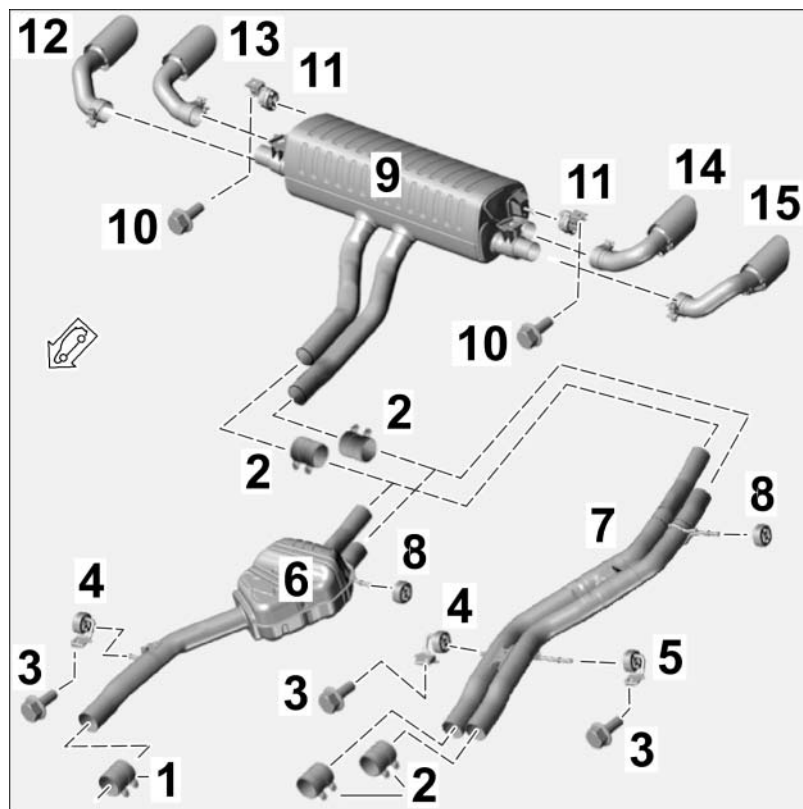

Figure 3

Scope of exhaust system – center, rear silencer (NSD) and sports tailpipes area (⇒ *Figure 3*):

PAB.253.141.20 ²	1 x	Clamping sleeve, Ø 75 x 88 ⇒ <i>Figure 3-1-</i>
958.111.220.10	2 x	Clamping sleeve, Ø 65 x 88 ⇒ <i>Figure 3-2-</i>
N.106.978.01	1 x	Hexagon-head bolt, M10 x 30 ⇒ <i>Figure 3-3-</i>
PAB.253.144.01	1 x	Holder for center silencer (MSD), front right ⇒ <i>Figure 3-4-</i>
PAB.253.409 ²	1 x	Center silencer assembly (MSD, -PPF) ⇒ <i>Figure 3-6-</i>
PAB.253.147.00	1 x	Retaining ring for center silencer, rear left ⇒ <i>Figure 3-8-</i>
9Y0.253.125.C	1 x	Rear silencer assembly ⇒ <i>Figure 3-9-</i>

N.106.421.01	2 x	Hexagon-head bolt, M8 x 25 ⇒ <i>Figure 3-10-</i>
PAB.253.144.03	2 x	Holder for rear silencer (NSD) ⇒ <i>Figure 3-11-</i>
PAF.038.549	8 x	Expansion rivet, A8 x 12 (air guide for tunnel, underbody panelling, not shown)
N.106.296.02	8 x	Hexagon head screw M10 x 35 (underbody crossbeam)
9Y0.253.824.DG ³	1 x	Sports tailpipe in silver, outer right ⇒ <i>Figure 3-12-</i>
9Y0.253.824.DL ³	1 x	Sports tailpipe in silver, inner right ⇒ <i>Figure 3-13-</i>
9Y0.253.823.EC ³	1 x	Sports tailpipe in silver, inner left ⇒ <i>Figure 3-14-</i>
9Y0.253.823.DQ ³	1 x	Sports tailpipe in silver, outer left ⇒ <i>Figure 3-15-</i>
9Y0.253.824.DH ³	1 x	Sports tailpipe in dark bronze, outer right (not shown)
9Y0.253.824.DM ³	1 x	Sports tailpipe in dark bronze, inner right (not shown)
9Y0.253.823.ED ³	1 x	Sports tailpipe in dark bronze, inner left (not shown)
9Y0.253.823.DT ³	1 x	Sports tailpipe in dark bronze, outer left (not shown)

² **ONLY** contained in set for vehicles WITHOUT PPF (9Y0.044.234 / 9Y0.044.234.A).

³ **ONLY** contained in respective set.



Figure 4

Scope of electrics – control unit, exhaust flaps and interior mechanics area (⇒ *Figure 4*):

9Y0.907.159.CD	1 x	Engine noise control unit (not shown)
9Y0.044.210.A	1 x	Wire harness assembly for exhaust flaps ⇒ <i>Figure 4-1-</i>
— — — — ⁴	1 x	Grommet (internal Ø 66.5 – left side) ⇒ <i>Figure 4-2-</i>
— — — — ⁴	1 x	Grommet (internal Ø 46 – right side) ⇒ <i>Figure 4-3-</i>
— — — — ⁴	1 x	Corrugated hose, 4.5 x 7.6 x 220 ⇒ <i>Figure 4-4-</i>
— — — — ⁴	1 x	Corrugated hose, 4.5 x 7.6 x 230 (not shown)
— — — — ⁴	2 x	Plug socket (4-pin) ⇒ <i>Figure 4-5-</i>
— — — — ⁴	2 x	15-A fuse (not shown)
N.020.902.2	20 x	Tie-wrap, 3.6 x 246 (not shown)
999.513.052.40	10 x	Tie-wrap, 4.8 x 188 (not shown)
PAB.886.373	5 x	Fixing clip for seat cushion ⇒ <i>Figure 4-6-</i>
N.912.052.01	8 x	Cheese head bolt with multiple-tooth internal M10 x 35 (front and rear seat) ⇒ <i>Figure 4-7-</i>
PAF.912.664	4 x	Hexagon flange bolt, M12 x 1.5 x 40 (rear seat) ⇒ <i>Figure 4-8-</i>
999.607.085.00	1 x	15 A fuse (not shown)

⁴ Contained in the “Wire harness assembly for exhaust flaps (9Y0.044.210.A)” set.



Information

ONLY in the event of repairs/replacement:

Items **WITHOUT** a part number in the parts list can be found/ordered from the Porsche Electronic Parts Catalog = PET.

Check model year and vehicle equipment (I-no.) in the standard catalog!

Materials:	000.043.172.00	1 x	Sealing cord
	— — — —	1 x	Commercially available rust solvent, e.g. WD40
	— — — —	1 x	Wrapping / insulating tape (commercially available)
	— — — —	1 x	Auxiliary line (Tekalan or Teflon hose) approx. 1,500 mm long

Notes:



Information

Please pass all this information on to the customer.

Also give the customer a copy of the first pages of these Installation and Conversion Instructions, including the legal regulations.

Tools: **P90999 - P90999 - PIWIS Tester 4**

VAS 6935 - Pole terminal puller

VAS 6931A - Transmission and gearbox jack**V.A.G 1331A - Torque wrench 6-50 Nm (4.5-37 ftlb.)**

- Assembly:
- 1 Preparatory work
 - 1.1 Drive the vehicle onto a lifting platform and connect a battery charger. ⇒ *Workshop Manual '2X00IN Battery trickle charging'*
 - 1.2 Raise the vehicle. ⇒ *Workshop Manual '4X00IN Raise the vehicle'*
 - 1.3 Remove the seats
 - 1.3.1 Remove boot cover.
 - 1.3.2 Remove padding for rear seat surface (2 / 3-split folding rear seat). ⇒ *Workshop Manual '744919 Remove and install padding for rear seat surface (2 / 3-split folding rear seat)'*

**Heavy components**

- Risk of squashing
- ⇒ Wear personal protective gear.
- ⇒ Get someone to help if necessary.

- 1.3.3 Remove 2 / 3-split folding rear seat. ⇒ *Workshop Manual '724819 Remove and install rear seat'*

**Information**

The help of another person is required for this step.

- 1.3.4 Carefully lift the 2/3-split folding rear seat towards the rear out of the vehicle via the boot.

**Heavy components**

- Risk of squashing
- ⇒ Wear personal protective gear.
- ⇒ Get someone to help if necessary.

- 1.3.5 Remove (left) front seat. ⇒ *Workshop Manual '720119 Remove and install front seat'*



Information

The help of another person is required for this step.

1.3.6 Carefully lift the front seat (left) from the vehicle to the rear via the boot.

1.4 Remove passenger compartment trim panels (left side).

1.4.1 Expose the A-pillar area (side):
(⇒ Figure 8)

- 1 – Front side-section trim panel
- 2 – Footrest
- 3 – Inner door sill trim (front)
- 4 – A-pillar trim panel (lower part)
- 5 – 1 / 3 rear seat



Figure 8

Remove the A-pillar trim panel (lower part). ⇒ *Workshop Manual '705719 Remove and install A-pillar trim panel (lower part)'*

1.4.2 Expose the B-pillar area (left side):
(⇒ Figure 9)

- 1 – B-pillar trim panel (upper part)
- 2 – B-pillar trim panel (lower part)
- 3 – Door sill trim (inner)
- 4 – C-pillar trim panel (lower part)
- 5 – Side trim panel of the boot (left side)
- 6 – Bulkhead cover

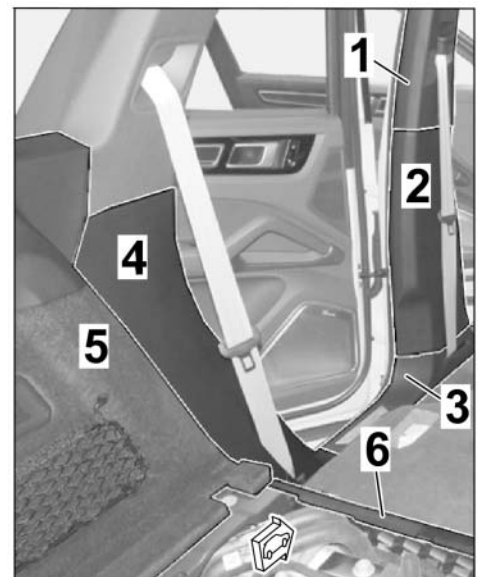

Figure 9

Remove B-pillar trim panel (lower part). ⇒ *Workshop Manual '706719 Remove and install B-pillar trim panel (lower part)'*

1.4.3 Expose boot area:
Remove side trim panel for boot (left / right).

- Basic version: ⇒ *Workshop Manual '700319 Remove and install rear boot side trim panel'*

- Coupé: ⇒ *Workshop Manual '700319 Remove and install rear boot side trim panel'*

- 1.4.4 Expose C-pillar area (left side):
Remove C-pillar trim panel (lower part) on left side. ⇒ *Workshop Manual '706819 Remove and install C-pillar trim panel (lower part)'*.
- 1.4.5 Push the 1 / 3 rear seat forward and remove the cover on the bulkhead.

CAUTION

Hot components

- Risk of burns
- ⇒ Let hot components cool down.
- ⇒ Wear personal protective gear.

- 1.5 Work in the exhaust system area
- 1 – Rear underbody cover
 - 2 – Rear tunnel cover
 - 3 – Front underbody cover (rear section)
 - 4 – Tailpipe (left / right)

- 1.5.1 Remove rear underbody cover and rear tunnel cover (⇒ *Figure 10 -1 and 2-*). ⇒ *Workshop Manual '519419 Remove and install rear underbody cover'*

- 1.5.2 Remove front underbody cover (rear section) (⇒ *Figure 10 -3-*). ⇒ *Workshop Manual '51921900 Remove and install front underbody cover'*

- 1.5.3 Remove tailpipe (left / right) (⇒ *Figure 10 -4-*). ⇒ *Workshop Manual '263419 Remove and install tailpipe - T9I'*

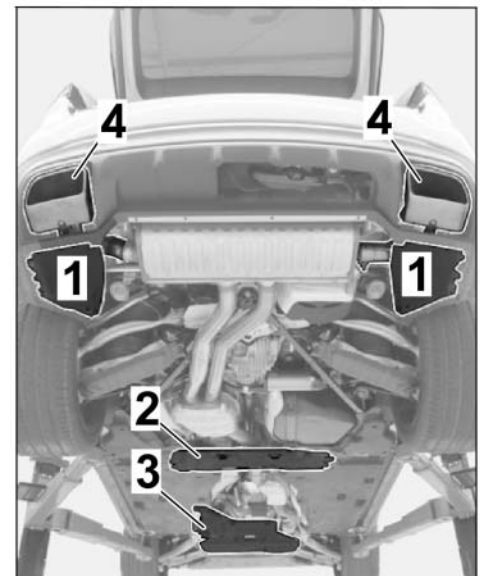

Figure 10

CAUTION

Heavy components

- Risk of squashing
- ⇒ Wear personal protective gear.
- ⇒ Get someone to help if necessary.

- 1.5.4 Remove exhaust system **WITHOUT** removing tunnel strut. ⇒ *Workshop Manual '260119 Remove and install exhaust system - T9I'*
- 1.6 Expose the plenum panel area
- Remove the cowl panel cover. ⇒ *Workshop Manual '508719 Remove and install cowl panel cover'*
- 1.7 **ONLY** for vehicles **WITHOUT** petrol particulate filter (PPF; emissions concept = OGB / 7CE / 7GH / 7MM):

- 1.7.1 Remove the engine cover (design cover) (⇒ *Figure 11-2-*). ⇒ *Workshop Manual '108319 Remove and install engine cover - T9I'*

- 1 – Filling neck for windshield-washer reservoir
- 2 – Engine cover (design cover)
- 3 – Strut brace (installation position of engine sound control unit)

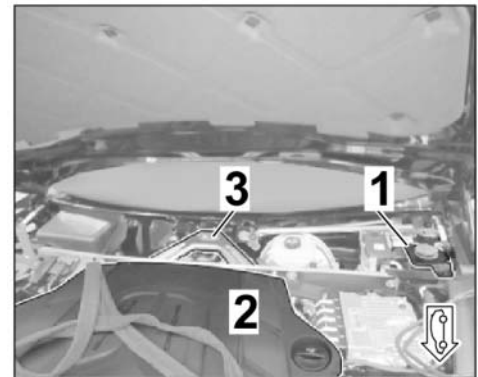

Figure 11

- 1.7.2 Remove the air cleaner housing. ⇒ *Workshop Manual '242519 Remove and install air cleaner housing - T9I, TB5'*
- 1.7.3 Remove exhaust pipe with front silencer. ⇒ *Workshop Manual '267319 Remove and install catalytic converter'*

NOTICE

Incorrect line routing

- Risk of damage to lines and hoses
 - Malfunction and fault memory entry on control unit
- ⇒ Avoid small bending radii when routing lines.
- ⇒ File down edges and burrs in the routing area or mask them with adhesive tape.
- ⇒ Maintain a sufficient distance from components exposed to high temperatures while driving.

- 2 Replace engine noise control unit
- 2.1 Check whether there is a tie-wrap on the side tab on the new engine noise control unit. Remove the tie-wrap if necessary.

- 2.2 Disconnect plug connection for the standard engine noise control unit and remove engine noise control unit with holder. ⇒ *Figure 12*

- 1 – Control unit holder
- 2 – Engine noise control unit
- 3 – Wire harness engine noise
- 4 – Line clip
- 5 – Dome strut
- 6 – Engine noise pulse sender (LHD position)

- 2.3 Replace engine noise control unit

- 2.3.1 Remove standard engine noise control unit from the strut brace.

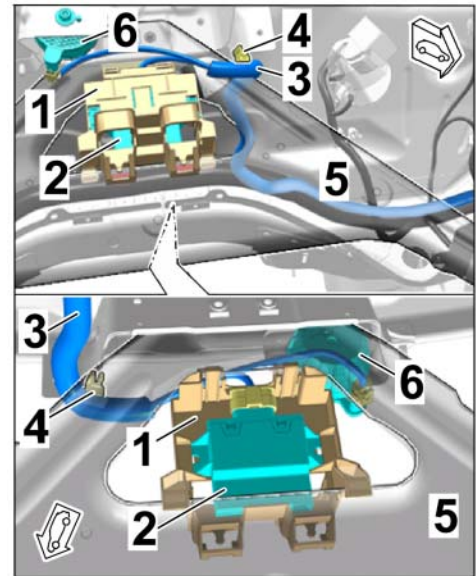

Figure 12

- 2.3.2 Insert new engine noise control unit at the underside in the control unit holder. ⇒ *Figure 13-A-*

- 1 – Engine noise control unit
- 2 – Control unit holder
- 3 – Locking / unlocking

- 2.3.3 Push the engine noise control unit in the holder to the opposite side of the plug connection (⇒ *Figure 13-B-*) until control unit engages in the holder.

- 2.4 Create a plug connection between wire harness and mount control unit with holder on dome strut.

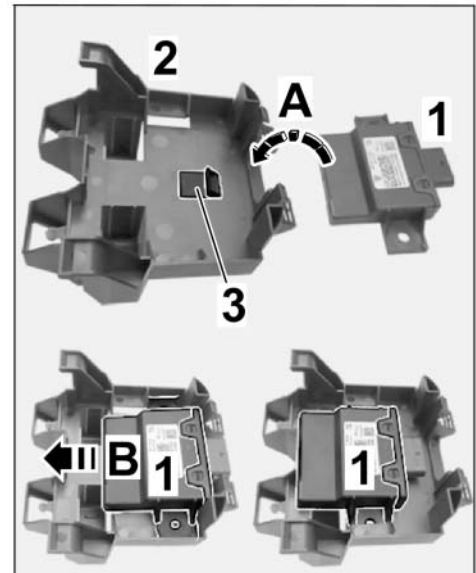

Figure 13

3 Routing and connecting wire harness for exhaust flaps

Connections for wire harness for exhaust flaps
(⇒ *Figure 14*):

- 1 – Connector for connection point (preparation of exhaust flaps, 6-pin)
 - 2 – Branch for exhaust flap (left)
 - 3 – Branch for exhaust flap (right)
- 3.1 Make a plug-in connection (6-pin) between the connection point (preparation) and exhaust flaps

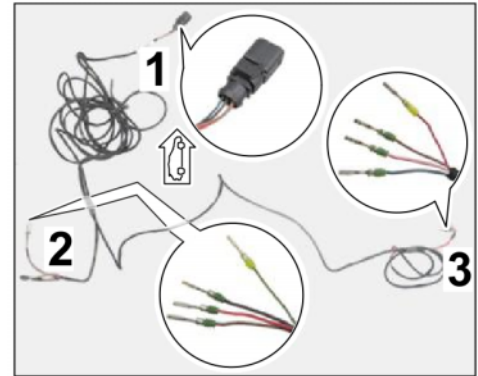

Figure 14

- 3.1.1 Expose the connection point (preparation = socket connector, 6-pin) in the passenger compartment of the vehicle, area of bulkhead grommet, A-pillar left. ⇒ *Figure 15 -A-*

- 1 – Foam preparation (socket connector, 6-pin)
- 2 – Grommet on bulkhead (LHD vehicle)
- 3 – Connector for wire harness for exhaust flaps (6-pin)

- 3.1.2 Push the foam preparation (socket connector, 6-pin) onto the line on the vehicle side.

- 3.1.3 Establish a connection between the plug connection preparation and the wire harness for the exhaust flaps (6-pin). ⇒ *Figure 15 -B-*

- 3.1.4 Push the foam over the plug connection (6-pin).

- 3.2 Lay the wire harness for the exhaust flaps to the rear of the vehicle as follows

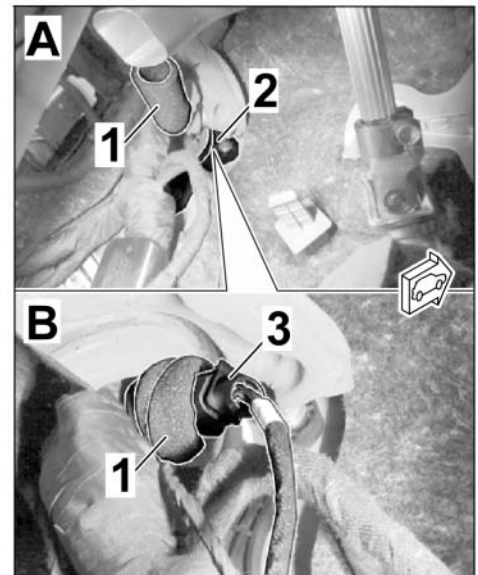

Figure 15

Route of the wire harness for exhaust flaps in the vehicle ⇒ *Figure 16*:

- 1 – Connection point (preparation)
- 2 – Grommet / stopper for boot floor (left)
- 3 – Grommet / stopper for boot floor (right)

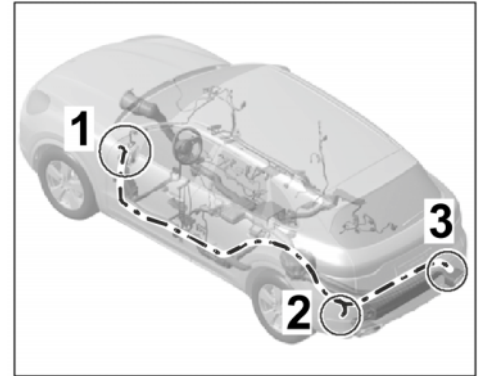

Figure 16

3.2.1 A-pillar area, left (⇒ *Figure 17*)

- 1 – Socket connector (6-pin, preparation)
- 2 – Pin connector (6-pin, wire harness for exhaust flaps)
- 3 – Fuses / relays (LHD vehicles)

- **Left-hand drive:** Connecting point (preparation = socket connector, 6-pin) → along wire harness A-pillar, left → beneath fuses / relays (DO **NOT** remove the relay carrier - at most loosen it.) → Door sill A-pillar, left
- **Right-hand drive:** Connecting point (preparation = socket connector, 6-pin) → along wire harness A-pillar, left → door sill A-pillar, left

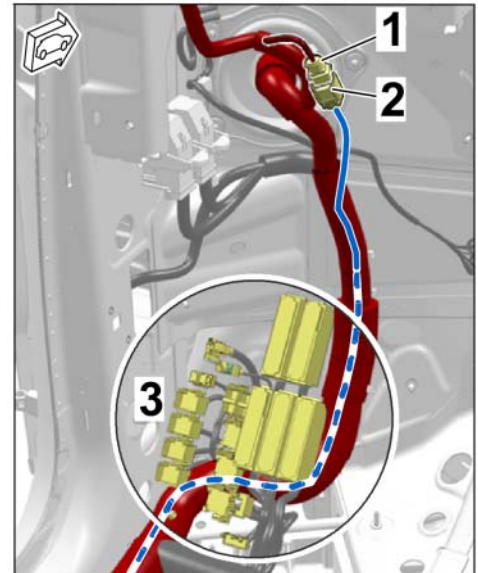

Figure 17

3.2.2 Door sill area, left (⇒ Figure 18)

- 1 – Wire harness for exhaust flaps
 - 2 – Cable holder, door sill B-pillar area (left)
 - 3 – Cable duct, rear door sill area (left)
- Door sill A-pillar, left → along wire harness for door sill, left (open cable ducts / holders if necessary) → wheel housing, rear left

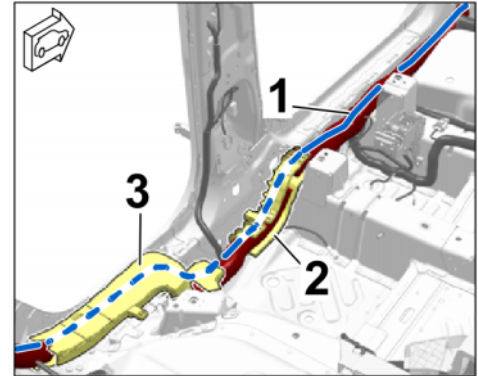

Figure 18

3.2.3 Wheel housing area, left (⇒ Figure 19)

- 1 – Cable duct, rear door sill area (left)
- 2 – Cable duct, rear wheel housing area (left)
- 3 – Fuse box in boot (left)
- 4 – Grommet / stopper for boot floor, left (Ø 66.5 mm)
- 5 – Branch for exhaust flap, right side

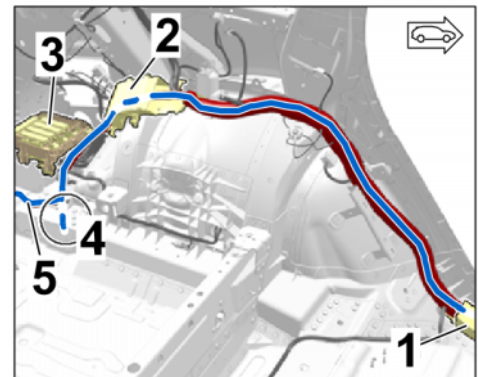

Figure 19

- Door sill, left → above wheel housing, left → branch for exhaust flap (left) to grommet / stopper for boot floor, left (beneath fuse / relay carrier) → branch for exhaust flap, right of the rear end plate

3.2.4 Rear end plate area and grommet / stopper for boot floor (⇒ *Figure 20*)

- 1 – Branch for exhaust flap (left)
- 2 – Branch for exhaust flap (right)
- 3 – Fuse box in boot (left)
- 4 – Grommet / stopper for boot floor, left (Ø 66.5 mm)
- 5 – Grommet / stopper for boot floor, right (Ø 46 mm)

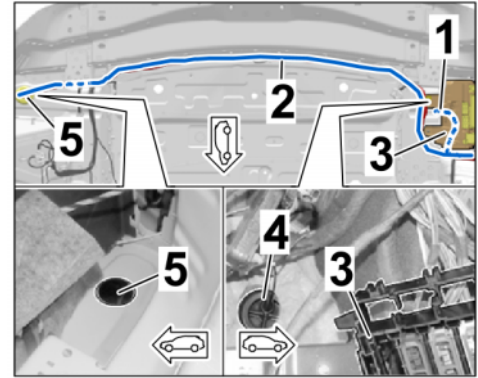

Figure 20

- Branch for exhaust flap (left) to grommet / stopper for boot floor, left (beneath fuse box in boot (left) → branch for exhaust flap on the right to rear closing panel → along rear closing panel (⇒ *Figure 20-top-*) → grommet / stopper for boot floor, right.

3.3 Lay the branch for the exhaust flap (left / right) to the underside of the vehicle

3.3.1 Loosen fuse box with holder in left rear boot and swivel it aside (⇒ *Figure 21*). ⇒ *Workshop Manual '978409 Loosening and securing fuse box in the boot'*

- 1 – Fuse box with holder
- 2 – Grommet (left = Ø 66.5 mm)

3.3.2 Loosen the heat shield on the underside of the vehicle in the area of the grommet (right / left) and stopper (right / left) and bend it down slightly.

3.3.3 Remove the stoppers in the boot floor (left = Ø 66.5 mm / right = Ø 46 mm). The stopper is replaced by a corresponding grommet (see parts package).

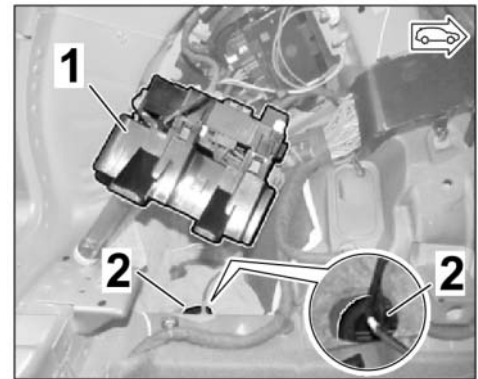

Figure 21

3.3.4 **ONLY** if a grommet with several lines is installed on the underside (including an exhaust flap branch (left / right of the standard rear silencer ⇒ *Figure 22*):

- 1 – Grommet
- 2 – Branch for exhaust flap
- 3 – Exhaust flap (standard rear silencer)

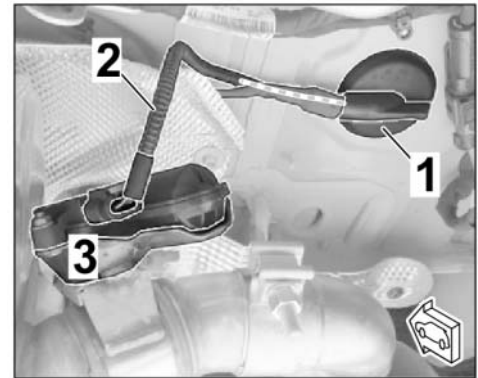

Figure 22

- Remove grommet(s) (left / right) with branches and guide it into the passenger compartment.
- Remove the connector housing from the respective exhaust flap branch (left / right of the standard rear silencer).
- Spread the grommet using a three mandrel pliers for hoses and grommets (commercially available) and remove adhesive residue from the grommet.
- **CAREFULLY** guide the exhaust flap standard branch through the grommet into the passenger compartment and wrap it with insulating tape and secure it.
- Guide the new branch for the exhaust flap (left / right) through the neck of the grommet (see also 3.3.6) **OR** through another hole in the grommet collar (⇒ *Figure 23*) **CAREFULLY** to the underside of the grommet.

- 1 – Grommet
- 2 – Branch for exhaust flap (left / right)
- 3 – Additional electric line

3.3.5 **ONLY** if a grommet is installed with the exhaust flap branch (left / right of the standard rear silencer):

- Remove grommet(s) with branch connections to the exhaust flap (left / right) and guide it / them into the passenger compartment.
- Tie back the exhaust flap branch (left / right) with the connector and grommet on the wire harness on the vehicle side in the passenger compartment.

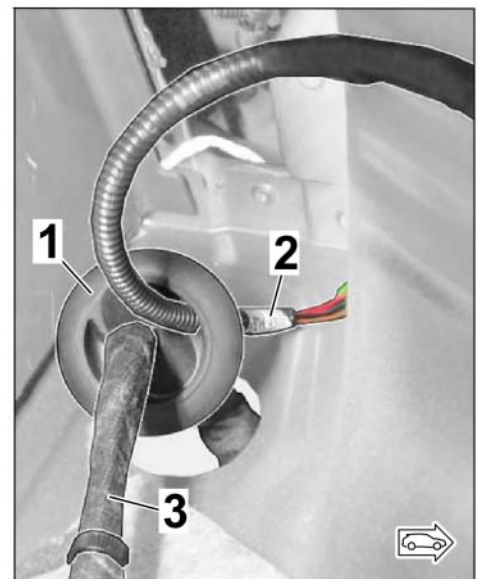

Figure 23

- Use a new grommet (left = Ø 66.5 mm / right = Ø 46 mm, see scope of parts) (see also 3.3.6).

3.3.6 **ONLY** if stopper (left = Ø 66.5 mm / right = Ø 46 mm) is installed:

- Remove the stoppers (left = Ø 66.5 mm / right = Ø 46 mm).
- Use a new grommet (left = Ø 66.5 mm / right = Ø 46 mm, see scope of parts) (see also 3.3.6).

3.3.7 Guide the new branch for the exhaust flap (left / right) through the new grommet (left = Ø 66.5 mm / right = Ø 46 mm) using three mandrel pliers and an auxiliary line (Tekalan or Teflon tube).
⇒ *Figure 24*

- 1 – Three mandrel pliers
- 2 – Grommet, right (Ø 46 mm)

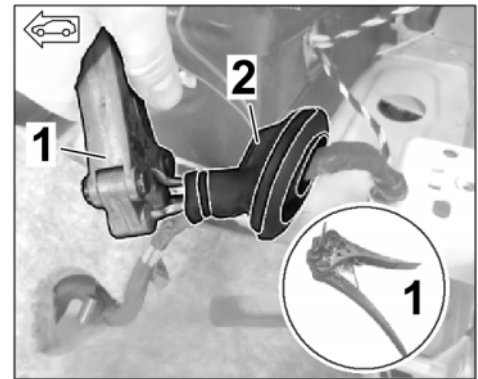

Figure 24

3.4 Installing the socket housing on the exhaust flap branch

3.4.1 Release the socket housing (4-pin, see parts list). ⇒ *Figure 25-A-*

- 1 – Fuse
- 2 – Plug socket (4-pin)

3.4.2 Connect the lines with female contacts and single-core seals (wire harness for exhaust flaps) in the socket housing (4-pin, see parts list) as follows:

- Left exhaust flap:

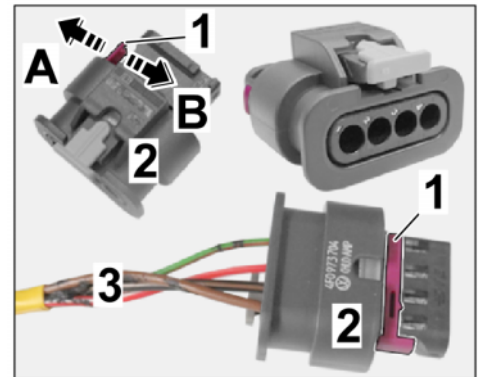

Figure 25

Plug socket (4-pin)	Line / function
Chamber 1	BN; 0.5 ² = Terminal 31 (ground)
Chamber 2	SW / BN; 0.75 ² = Pulse Width Module (PWM)
Chamber 3	RT / WS; 0.5 ² = Terminal 87 (power supply, fuse)
Chamber 4	GN / RT; 0.35 ² = Pulse Width Module out (PWM)

- Right exhaust flap:

Plug socket (4-pin)	Line / function
Chamber 1	BN; 0.5 ² = Terminal 31 (ground)
Chamber 2	SW / BL; 0.5 ² = Pulse Width Module (PWM)
Chamber 3	RT / WS; 0.5 ² = Terminal 87 (power supply, fuse)
Chamber 4	RT / SW; 0.35 ² = Pulse Width Module out (PWM)

3.4.3 Lock the socket housing (4-pin, see parts list). ⇒ *Figure 25-B-*

3.4.4 Wrap cables (4 x) with insulating tape from a distance of approx. 30 mm from the connector (socket housing 4-pin) as far as the underbody.

3.4.5 Install corrugated hose 4.5 x 7.6 x X to each branch from a distance of approx. 30 mm from the connector (socket housing 4-pin) to the underbody. ⇒ *Figure 26*

- 1 – Corrugated hose, 4.5 x 7.6 x X
- 2 – Connector (socket housing 4-pin)
- 3 – Branch for exhaust flap (right)
- 4 – Cable tie
- X – approx. 30 mm

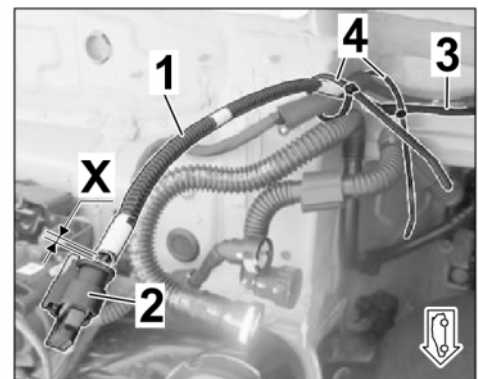

Figure 26

- Left side: Corrugated hose, 4.5 x 7.6 x 220
- Right side: Corrugated hose, 4.5 x 7.6 x 230

3.5 Check fuse assignment of exhaust flaps and engine sound pulse generator in the fuse box (left A-pillar footwell ⇒ *Figure 27*) (⇒ Cayenne Driver's Manual, section on "Fuses")

- 1 – Fuse strip A
- 2 – Fuse strip D

3.5.1 Check that slot A4 is inserted into fuse strip A (exhaust flaps) and secure with a new fuse if necessary.

Fuse: **Nominal value 7.5 A**

3.5.2 Check that slot D3 is inserted into fuse strip D (structure-borne noise control unit, engine noise generator) and secure with a new fuse if necessary.

Fuse: **Nominal value 15 A**



Figure 27

4 Install new exhaust system

4.1 **ONLY** for vehicles WITHOUT petrol particulate filter (PPF; emissions concept = OGB / 7CE / 7GH / 7MM):

- 1 – Spacer tube \varnothing 24 x 32
- 2 – Tab AL552
- 3 – Compression spring
- 4 – Washer, 8.4 x 24 x 2
- 5 – Cheese head bolt with multiple-tooth socket, M8 x 50
- 6 – Spacer pipe, \varnothing 30 x 16
- 7 – Rubber bush, \varnothing 42 x 29

4.1.1 Install exhaust pipe with front silencer. \Rightarrow *Workshop Manual '267319 Remove and install catalytic converter'*

Install new exhaust pipe with a new seal and new spring/tab assembly (\Rightarrow Figure 28).

Secure exhaust pipe on the transmission support using restraining strap for securing loads, for example, to prevent it from bending down.

4.1.2 Install the air cleaner housing. \Rightarrow *Workshop Manual '242519 Remove and install air cleaner housing - T9I, TB5'*4.1.3 Install engine cover (design cover). \Rightarrow *Workshop Manual '108319 Remove and install engine cover - T9I'*4.2 Install new rear silencer with a new clamping sleeve, \varnothing 65 x 88 (2 x). \Rightarrow *Workshop Manual '263355 Replace rear silencer'*

- Hexagon flange bolt, M8 x 25 (rear silencer holder): **Tightening torque 23 Nm**
- Clamping sleeve, \varnothing 65 x 88: **Tightening torque 30 Nm**

4.3 Connect electric plug connections for servo motor for exhaust flap (left / right).

4.3.1 Pull the excess branch wire for the exhaust flap (left / right) towards the grommet in the floor of the vehicle.

4.3.2 Seal the line bushing for the exhaust flap in the grommets (left / right) from the inside and outside using sealing cord.

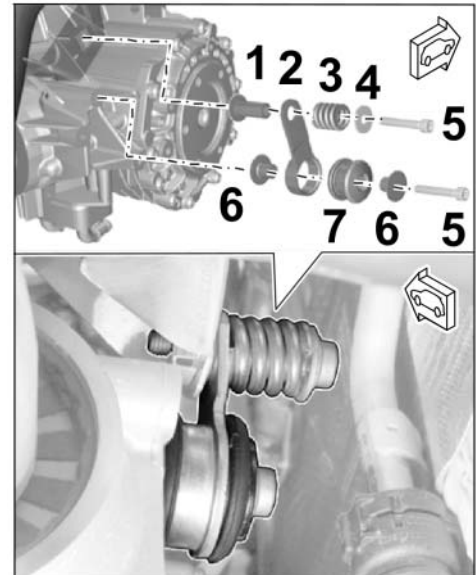

Figure 28

4.4 Install new sports tailpipes (silver or dark bronze) and align them with the rear apron.
 ⇒ *Installation and Conversion Instructions '263400 Sports tailpipe, twin-branch – silver (OP3) / dark bronze (OP6)'*

- 1 – Sports tailpipe – inner (right)
- 2 – Sports tailpipe – outer (right)
- 3 – Exhaust system panel (rear panel)

4.4.1 Check that the gap between the new sports tailpipes and the exhaust system cover (rear panel – left and right side of vehicle) is symmetrical and consistent. Adjust if necessary.

⇒ *Figure 30-Z-*: **Check value 21 mm +/- 1 mm**

4.4.2 Check spacing of inner / outer sports tailpipe (left and right side of vehicle). Adjust if necessary.

⇒ *Figure 30-Za-*: **Check value 11 mm +/- 1 mm**

4.4.3 Tighten pan head screw, M6 x 12 (underside of sports tailpipe cover).

Tightening torque 8 Nm +/- 1 Nm

4.5 Install all covers to the underbody of the vehicle.

5 Concluding work for vehicle interior / engine compartment

- 5.1 Secure routed wire harness (for exhaust flaps) in the vehicle to existing lines / components with tie-wraps without tensile stress and so that no chafing occurs.
- 5.2 Install bulkhead cover and install C-pillar trim panel. ⇒ *Workshop Manual '706819 Remove and install C-pillar trim panel (lower part)'*
- 5.3 Install side trim panel for boot (left / right).
 - Basic version: ⇒ *Workshop Manual '700319 Remove and install rear boot side trim panel'*
 - Coupé: ⇒ *Workshop Manual '700319 Remove and install rear boot side trim panel'*
- 5.4 Install B-pillar trim panel (lower part). ⇒ *Workshop Manual '706719 Remove and install B-pillar trim panel (lower part)'*
- 5.5 Install A-pillar trim panel (lower part). ⇒ *Workshop Manual '705719 Remove and install A-pillar trim panel (lower part)'*
- 5.6 Install the seat assembly

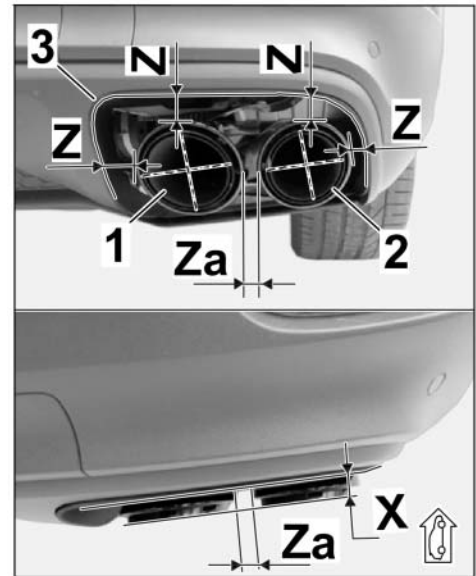

Figure 30

- 5.6.1 Carefully lift the front seat into the vehicle via the boot and install it with a new cheese head bolt. ⇒ *Workshop Manual '720119 Remove and install front seat'*
- 5.6.2 Carefully lift the 2/3-split folding rear seat into the vehicle via the boot and install it with a new cheese head bolt. ⇒ *Workshop Manual '724819 Remove and install rear seat'*
- 5.6.3 Install padding for rear seat surface (2 / 3-split folding rear seat) and if necessary, install with new fixing clip. ⇒ *Workshop Manual '744919 Remove and install padding for rear seat surface (2 / 3-split folding rear seat)'*
- 5.7 Complete the plenum panel area.
Install cowl panel cover. ⇒ *Workshop Manual '508719 Remove and install cowl panel cover'*

Coding: 6 Coding / programming sports exhaust system - silver (OP8) / dark bronze (OP9)

NOTICE**Voltage drop**

- Risk of irreparable damage to control unit
 - Risk of damage to control unit
 - Fault entries in the control unit
 - Coding in the control unit is aborted
 - Malfunctions in control unit, even during programming
- ⇒ Prior to disconnecting the control unit, switch off ignition and remove ignition key.
- ⇒ Ensure that the power supply is not interrupted during programming.
- ⇒ Connect a battery charger with a current rating of at least 90 A to the vehicle battery.

6.1 Preparatory work – Coding

NOTICE

Control unit programming will be aborted if the WLAN connection is unstable.

- An unstable WiFi connection can interrupt communication between the PIWIS Tester and the vehicle communication module (VCI). As a result, control unit programming may be aborted.
- ⇒ During control unit programming, always connect the PIWIS Tester to the vehicle communication module (VCI) via the USB cable.

- 6.1.1 Connect **P90999 - P90999 - PIWIS Tester 4** to the vehicle and switch it on.
- 6.1.2 Switch on ignition **AND** hazard warning lights on the vehicle.



Information

The **PIWIS Tester** instructions take precedence since the description may be different with later Tester releases.

The procedure described here has been structured in general terms. Different text or additional information may appear on the **PIWIS Tester**.

- 6.1.3 Select the "Diagnostics" menu item on the PIWIS Tester.
- 6.1.4 If **P90999 - P90999 - PIWIS Tester 4** is connected correctly, a connection to the vehicle will be established: "Cayenne" model line is detected.
- 6.1.5 Press •F12" to go to the control unit search screen.
- 6.1.6 Question: "Should an FAP be created?" If "Yes", press •F12" to confirm.
- 6.1.7 Select "KD-FAP" in the next menu item and press •F8" to start.



Information

The function is **ONLY** available when the Tester is online!

- 6.2 Enter the new vehicle equipment in the vehicle data using "PIWIS Online"
 - 6.2.1 Press •F7" in the control unit overview to switch to the "Additional menu".
 - 6.2.2 Select the "Maintain vehicle data with PIWIS-ONLINE" function.

A message appears informing you that the "Actual" (vehicle) data and "Required" (PIWIS Online) data will be compared.

Press •F12" to continue.
 - 6.2.3 Confirm the message "The vehicle data was compared with PIWIS Online. Significant differences were found with •F12" .
 - 6.2.4 Look for the option "INTERIOR SOUND MEASURES (VW SILENCERS)" in the "Family" column.

Select the option "2HB – INTERIOR SOUND MEASURES (SHAKER)" from the drop-down menu in the "Value" column.
 - 6.2.5 Look for the option "EXHAUST TAILPIPE" in the "Family" column.

Select "OP8 – SPORTS EXHAUST SYSTEM – STAINLESS-STEEL TAILPIPES" or "OP9 – SPORTS EXHAUST SYSTEM – BLACK TAILPIPES" from the drop-down menu in the "Value" column, depending on the installed option.

Press •F12" to continue.
 - 6.2.6 A table containing the coding value and the columns "new value" and "old value" is displayed in the overview. Press •F8" to continue.

6.2.7 Data is then written / saved. The following messages appear one after the other:

- Transferring vehicle data to PIWIS Online.
- Writing and transferring vehicle data to the vehicle.
- Vehicle order was written successfully.
- A check was performed in order to check whether control units have to be coded or programmed as a result of the changes that were made.

6.3 Code / program the new vehicle equipment.

6.3.1 Confirm the table containing a list of control units that must be coded / programmed, by pressing •F12” .

6.3.2 Individual data records will be loaded, depending on the number of control units to be coded / programmed.

Wait until messages “Creating backup documentation.” Please wait ... and “Coding was completed successfully”. Press •F12” to continue.

Repeat the process for other control units if necessary.

6.3.3 Wait for the “Adaptation of the control units is complete.” message and check the coding status of the control units in the displayed table.

Continue by pressing •F12” to return to the control unit overview.

6.4 Read out the fault memory of all systems, work through any existing faults and erase the fault memory. ⇒ *Workshop Manual '0335IN Diagnostics maintenance: Diagnostic system and maintenance inter...'*

6.5 Switch off ignition and disconnect **P90999 - P90999 - PIWIS Tester 4**.

6.6 Drive the vehicle off the lifting platform.

7 Perform “Sports exhaust system” function test

7.1 Start the engine.

7.2 Activate / deactivate the sports exhaust system, depending on vehicle equipment, using the following option:

- Porsche Communication Management: Select the menu “Car” → “Drive” → “Sports exhaust system”
- Porsche Communication Management: Select “SPORT” or “SPORT PLUS”

7.3 Switching off ignition

26 01 31 25: **ONLY** for vehicles WITHOUT petrol particulate filter (PPF; emissions concept = 0GB / 7CE / 7GH / 7MM):

– Retrofitting sports exhaust system (1 x)–

Labor time: **654 TU**

Includes: Replace engine noise control unit;
 Route and connect wire harness for exhaust flaps;
 Install new exhaust pipe with front silencer (WITHOUT PPF);
 Install new center and rear silencers;
 Install and align new sports tailpipes (4 x);
 Code the sports exhaust system;
 Read out fault memory, correct faults and delete them.

Without: Test drive

Important Notice: Technical Bulletins issued by Porsche Cars North America, Inc. are intended only for use by professional automotive technicians who have attended Porsche service training courses. They are written to inform those technicians of conditions that may occur on some Porsche vehicles, or to provide information that could assist in the proper servicing of a vehicle. Porsche special tools may be necessary in order to perform certain operations identified in these bulletins. Use of tools and procedures other than those Porsche recommends in these bulletins may be detrimental to the safe operation of your vehicle, and may endanger the people working on it. Properly trained Porsche technicians have the equipment, tools, safety instructions, and know-how to do the job properly and safely. Part numbers listed in these bulletins are for reference only. The work procedures updated electronically in the Porsche PIWIS diagnostic and testing device take precedence and, in the event of a discrepancy, the work procedures in the PIWIS Tester are the ones that must be followed.

© 2024 Porsche Cars North America, Inc.