

JLRTB02052NAS5

TECHNICAL BULLETIN

01 JAN 2001



© Jaguar Land Rover North America, LLC

NOTE: The information in Technical Bulletins is intended for use by trained, professional Technicians with the knowledge, tools, and equipment required to do the job properly and safely. It informs these Technicians of conditions that may occur on some vehicles, or provides information that could assist in proper vehicle service. The procedures should not be performed by 'do-it-yourselfers'. If you are not a Retailer, do not assume that a condition described affects your vehicle. Contact an authorized Land Rover service facility to determine whether this bulletin applies to a specific vehicle.

INFORMATION

This bulletin supersedes TSB JLRTB02052NAS4/2024 dated 18 JUL 2024, which should either be destroyed or clearly marked to show it is no longer valid (e.g. with a line across the page). Only refer to the electronic version of this Technical Bulletin in TOPIx.

SECTION:

501-03

SUBJECT /CONCERN:

Rear Doors Difficult To Open

AFFECTED VEHICLE RANGE:

MODEL:	MODEL YEAR:	VIN:	ASSEMBLY PLANT:	APPLICABILITY:
Defender (LE)	2020-2024	000431-356580	Nitra (Slovakia)	5-Door

MARKETS:

NORTH AMERICA

**CONDITION
SUMMARY:****SITUATION:**

When opening either of the rear doors, the door seal contacts the rear quarter window and makes opening the doors more difficult and sometimes noisy.

This technical bulletin has been updated due to changes to the affected vehicle range, addition of a Service Information Section and Service Instruction C.

CAUSE:

C-pillar exterior finisher trim to rear quarter window alignment incorrect.

ACTION:

Follow the instructions below.

PARTS: **NOTE:**

An allowance equivalent to £10.00 has been allocated to locally source 3M Double sided tape 4229P - 5 mm wide - 3 m roll (or equivalent). 1 role of 3M double side tape will repair a maximum of 3 vehicles.

PART NUMBER	DESCRIPTION	QUANTITY
LR132185	C-Pillar finisher trim - Left	1
LR132182	C-Pillar finisher trim - Right	1
ZZZ001	3M Double sided tape 4229P - 5 mm wide - 3 m roll (or equivalent)	£10.00

WARRANTY:**△ NOTE:**

* When submitting your Warranty claim within the Warranty portal, use the Condition Code list shown to select the Condition Code which best describes the vehicle defect.

△ NOTES:

- Repair procedures are under constant review, and therefore times are subject to change; those quoted here must be taken as guidance only. Use TOPIx to obtain the latest repair time.
- The JLR claims submission system requires the use of causal part numbers. Labor only claims must show the causal part number with a quantity of zero.

DESCRIPTION	SRO	TIME (HOURS)	CONDITION CODE	CAUSAL PART
JLRTB02052 - Rear door alignment - Single	99.01.21	0.2	*	LR132185 /LR132182
JLRTB02052 - Rear door alignment - Pair	99.01.22	0.3	*	LR132185 /LR132182
JLRTB02052 - C-pillar finisher trim - Single	99.01.23	0.2	*	LR132185 /LR132182
JLRTB02052 - C-pillar finisher trim - Pair	99.01.24	0.4	*	LR132185 /LR132182
JLRTB02052 - Rear door seal modification - Single	99.01.91	0.1	*	LR132185 /LR132182
JLRTB02052 - Rear door seal modification - Pair	99.01.92	0.2	*	LR132185 /LR132182

△ NOTE:

Normal Warranty procedures apply.

SERVICE INFORMATION:

1.



If the door seal is catching on the exterior trim panel, proceed to **Service Instruction A**.

2.

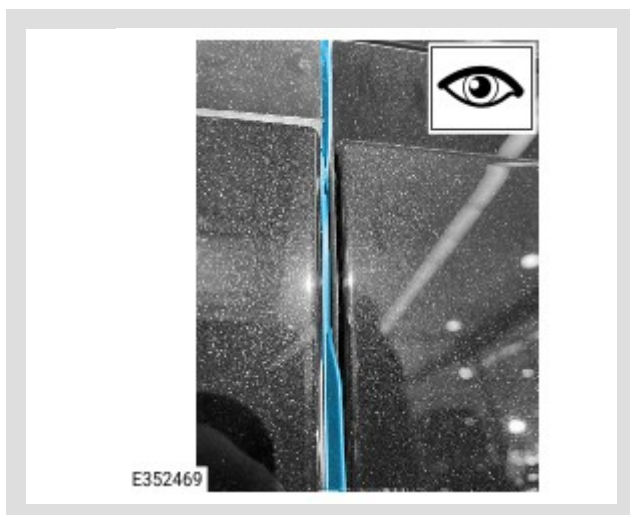

If the margin seal is catching on the C-Pillar glass, complete **Service Instruction C**.

- Check the operation of the rear door(s).
 - If the door is no longer difficult to open, do not continue with this technical bulletin.
 - If the door is still difficult to open, complete Service Instruction A and Service Instruction B.

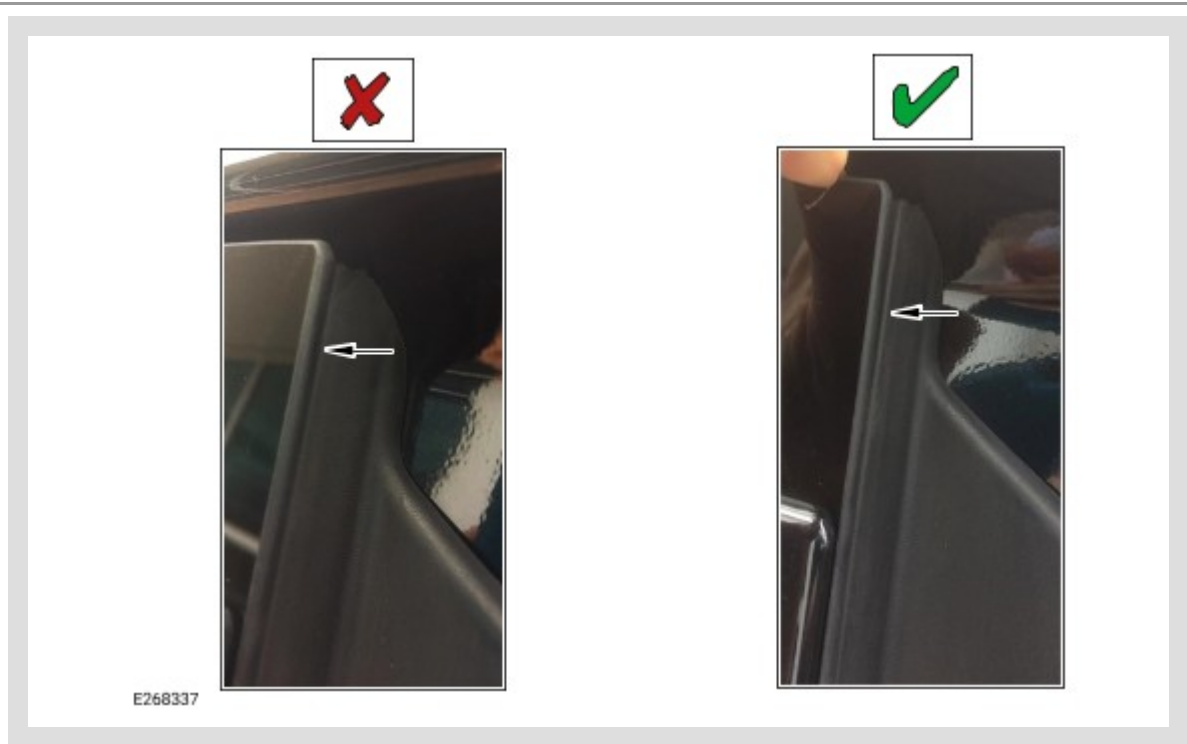

If the C-Pillar exterior trim is incorrectly installed, complete **Service Instruction C**.

- Check the operation of the rear door(s).
 - If the door is no longer difficult to open, do not continue with this technical bulletin.
 - If the door is still difficult to open, complete Service Instruction A and Service Instruction B.

SERVICE INSTRUCTION A - DOOR ALIGNMENT

1.

NOTE:

Only check the alignment of the rear doors that are difficult to open.

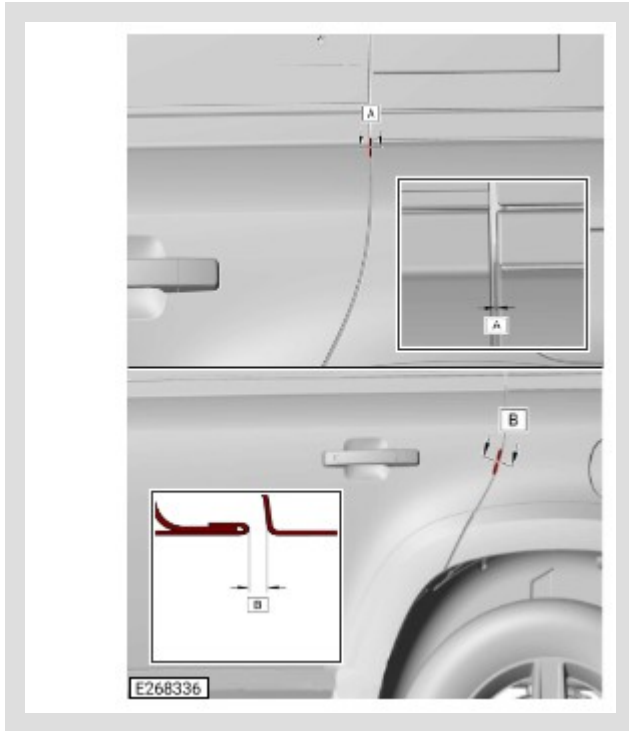

Check the alignment of the rear door(s) in the areas shown in the illustration.

2.

SECTION	DESCRIPTION	GAP	PROFILE
A	Rear door to rear quarter	N/A	0.0 ± 0.5 mm
B	Rear door to rear quarter	3.5 ± 0.7 mm	0.0 ± 0.7 mm

3.

 **NOTE:**

Only adjust the rear doors that are either out of alignment tolerance or do not have a gap of 2.8 mm.

Adjust the rear door(s) to be as far rearward as possible while still being within tolerance, the gap must be 2.8 mm (see TOPIx Workshop Manual section 501-26: Body Repairs: Vehicle Specific Information and Tolerance Checks - General Procedures - Rear Door Alignment).

4.

5.

Check the operation of the rear door(s).

- If the door is no longer difficult to open, do not continue with this technical bulletin.
- If the door is still difficult to open, continue to Service Instruction B.

SERVICE INSTRUCTION B - DOOR SEAL MODIFICATION

 **NOTE:**

Only complete the following steps for doors that were not repaired after completing Service Instruction A.

1.

Open the rear door that is difficult to open.

2.

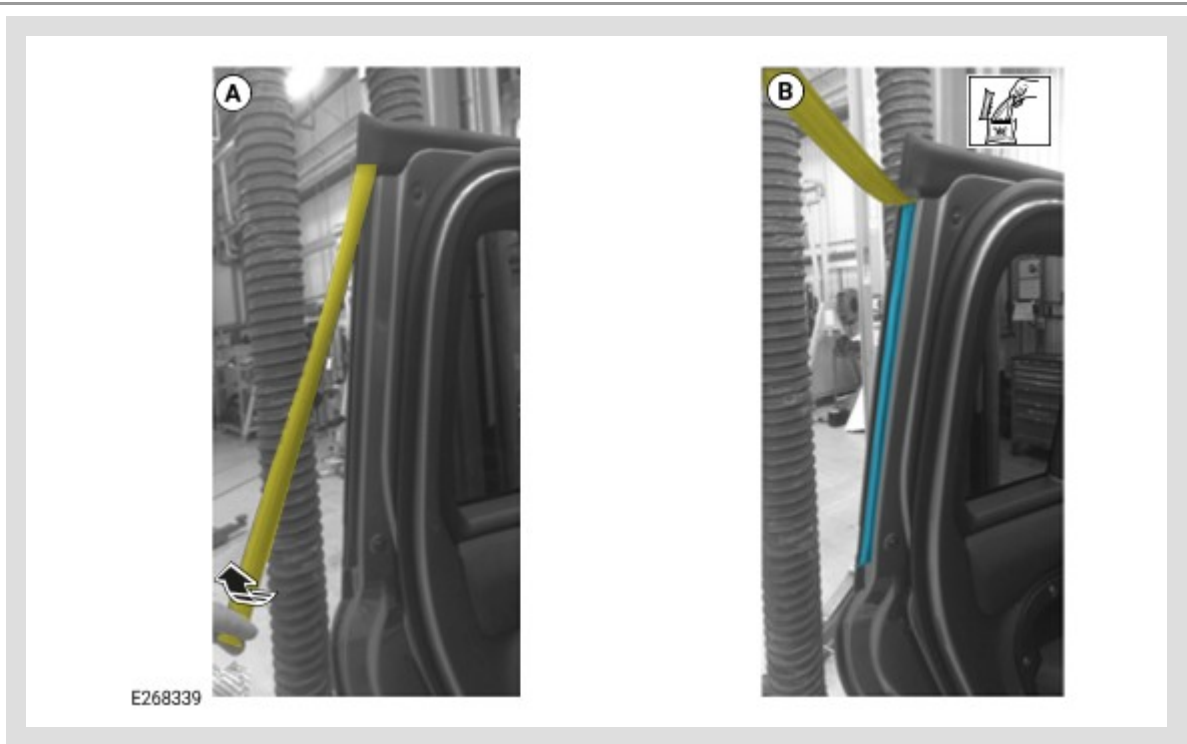

(A) Reposition the section of rear door seal shown in the illustration.

(B) Make sure the area highlighted in the illustration is clean, dry and free from contamination.

3.

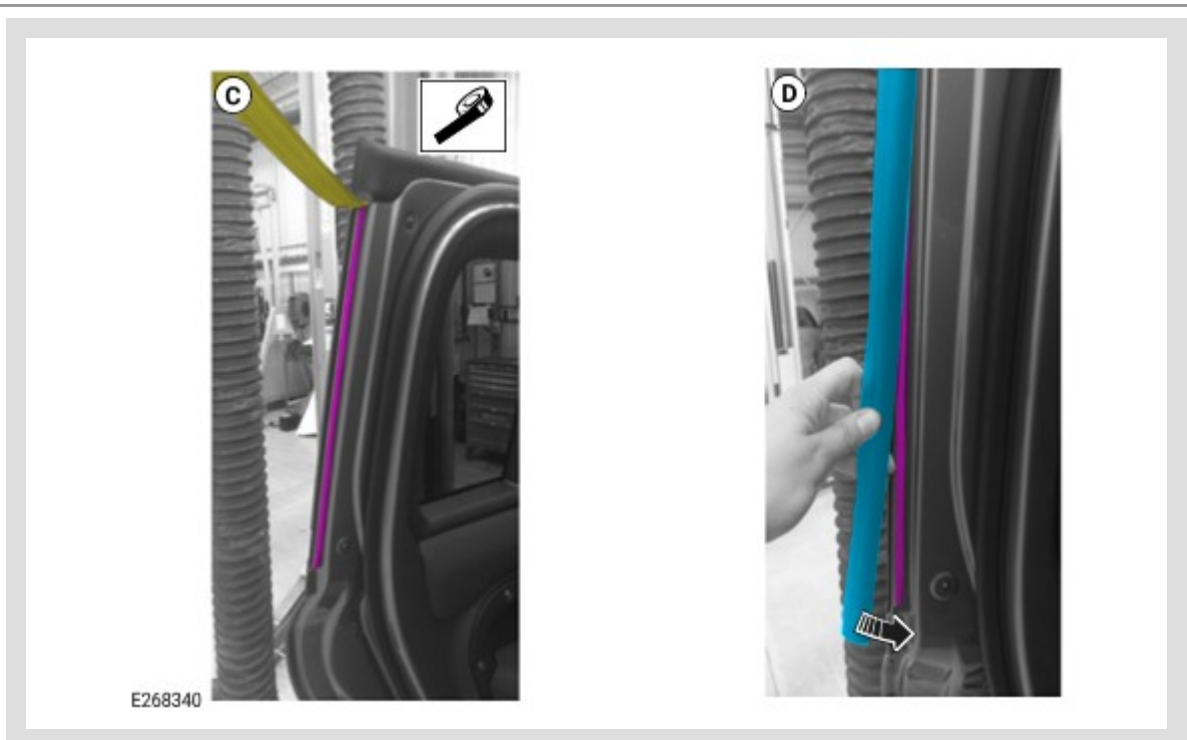

(C) Apply the double sided adhesive tape along the seal path on the door frame, as shown in illustration 'C'. Do not remove the protective backing from the double sided adhesive tape at this stage.

(D) Install the section of rear door seal removed during step 2.

4.

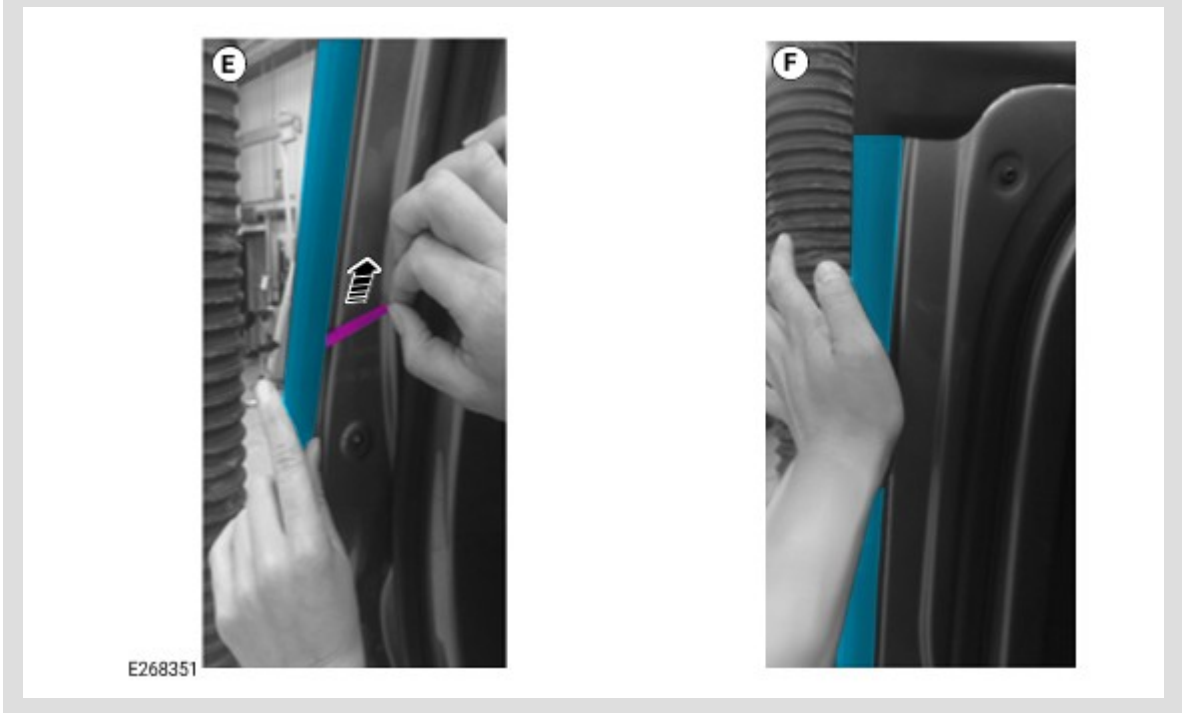

(E) With the rear door seal installed, remove the protective backing from the double sided adhesive tape.

(F) Apply firm pressure to the rear door seal to make sure it is adhered to the double sided adhesive tape.

5. Repeat steps 1 to 4 for the other door, if required.

6. Check the operation of the rear door(s).

- If the door is no longer difficult to open, do not continue with this technical bulletin.
- If the door is still difficult to open, continue to Service Instruction C.

SERVICE INSTRUCTION C - RENEW C-PILLAR EXTERIOR FINISHER TRIM

△ NOTE:

Only complete the following steps for doors that were not repaired after completing Service Instruction B, or if directed to by the Service Information section.

1. Open the rear door that is still difficult to open.

2.

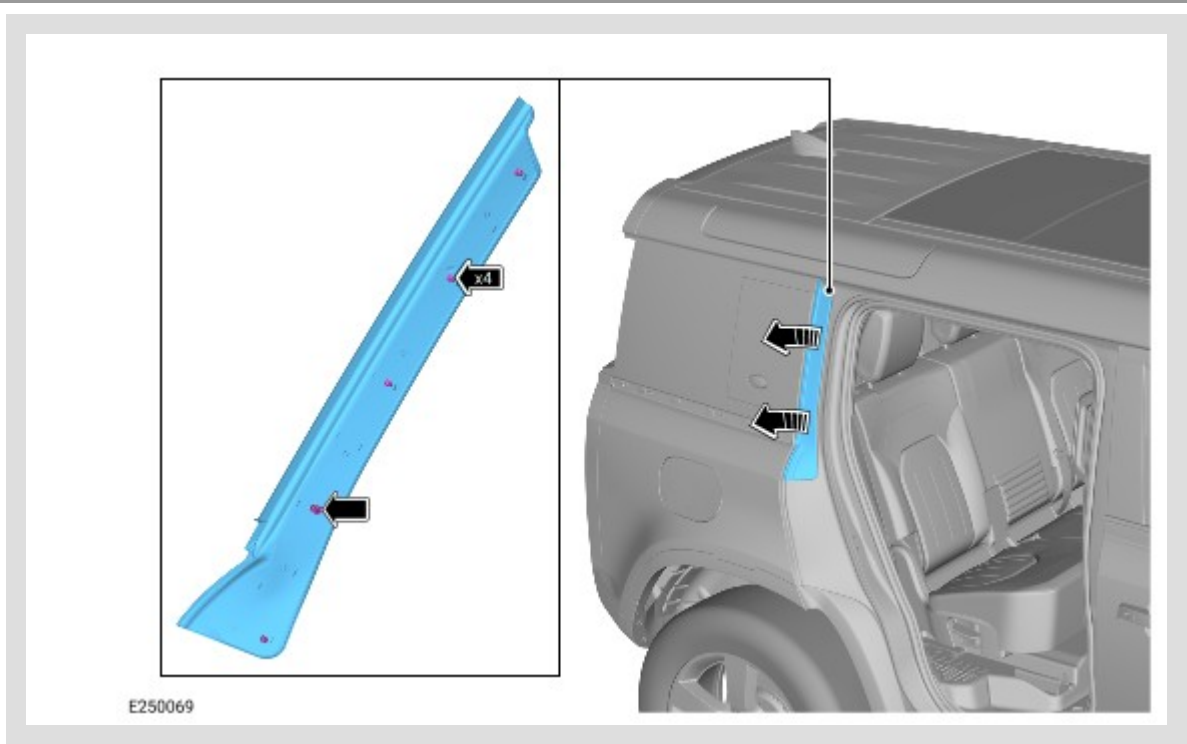

Remove and discard the C-pillar exterior finisher trim.

- Clean the area behind the C-pillar exterior finisher trim.

3.

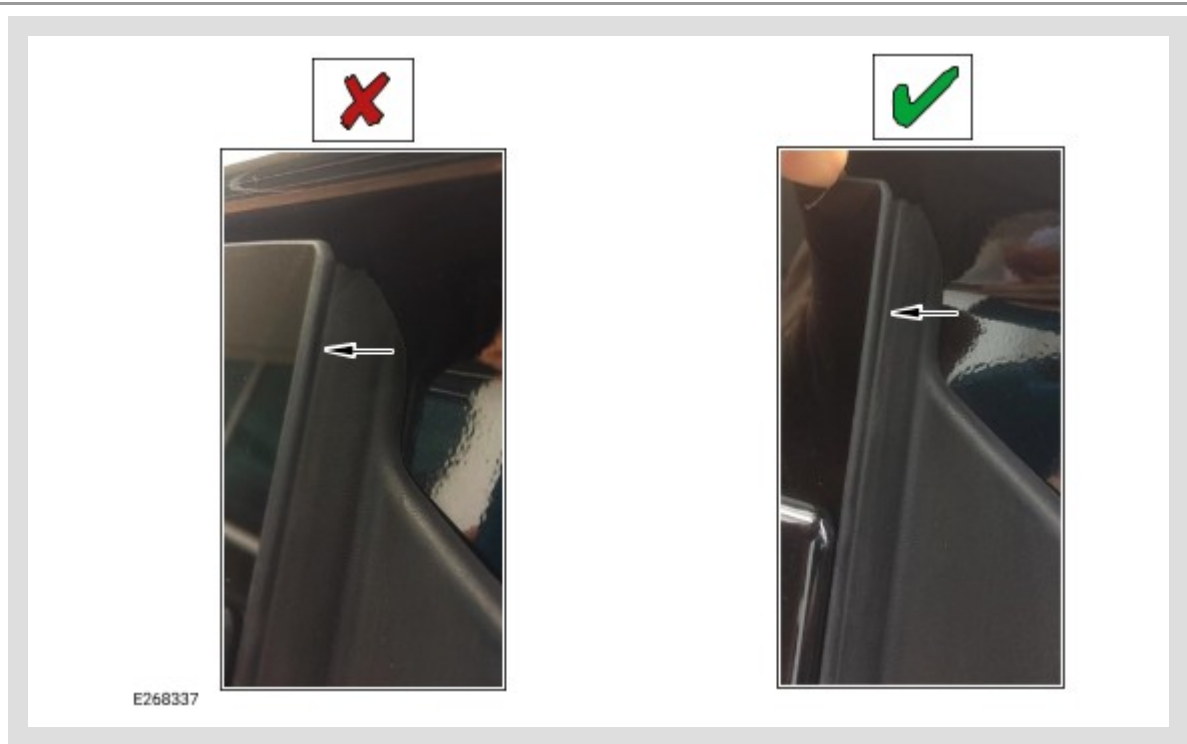

Install the new C-pillar exterior finisher trim.

- Remove the adhesive tape backing.
- **Make sure the C-pillar exterior finisher trim protrudes 1-1.5 mm away from the rear quarter window, as shown in the illustration, before fully securing.**

The image with the **RED 'X'** shows the C-pillar exterior finisher trim installed incorrectly behind the rear quarter window.

The image with the **GREEN "** shows the C-pillar exterior finisher trim installed correctly with a 1-1.5 mm protrusion from the rear quarter window.

4. Repeat steps 1 to 3 for the other door, if required.