

**PORSCHE Dashcam – Taycan**



**Information**

Please pass all this information on to the customer.

Also give the customer a copy of the first pages of these Installation and Conversion Instructions, including the legal regulations.

Change  
Overview:

Version	Date	Change
0	07/07/2021	• First publication
1	03/02/2022	• Update of information for cameras with serial number PDF2102*****
2	12/15/2022	• Update of X/Y values
3	09/03/2024	• Update of order types

Model Year: **As of 2020**

Information: **Retrofitting**



*Figure 1*

Note: The Porsche front camera (dashcam ⇒ *Figure 1*) is affixed to the **LEFT** of the interior mirror (viewed in direction of travel) on the windscreen and is connected to the vehicle electrical system.

It is ideal for making video recordings of driving situations and while parking. It can be configured and operated using a related app on your smartphone.

Recorded videos are stored on the supplied SD card and previous recordings are overwritten.

If the dashcam detects a shake/vibration or if the radar sensor is triggered, the recorded video is stored separately and not overwritten. Recordings can be downloaded directly from the SD card or via the app.



### Information

#### Important information for customers/customer advisors

- Ask customers to download and install the "Porsche Dashcam App" from the App Store (Apple or Google Play) on their device (smartphone/tablet) in advance.

#### For vehicle handover:

- Together with the customer, check whether a firmware update via "Porsche Dashcam App" is necessary. Perform the firmware update together if necessary.
- Together with the customer, choose the "Region/State/Country" by selecting the relevant flag and format the SD card.

#### Other information for the customer:

- The customer is responsible for choosing the right "Region/State/Country"!
- After crossing a national border: Update the "Region/State/Country" (see also conditions of use for this topic)

Parts Info: **9Y0.044.930** ⇒ PORSCHE front camera (dashcam), set

Parts list:



Figure 2

----	1x	3M privacy film (front & rear camera) ⇒ <i>Figure 2-1-</i>
----	1x	Front camera ⇒ <i>Figure 2-2-</i>
----	1x	Micro SD memory card (32 GB, plugged into front camera) ⇒ <i>Figure 2-3-</i>
----	1x	Front camera retainer plate assembly with wire harness ⇒ <i>Figure 2-4-</i>
----	1x	Wire harness assembly with connector (3-pin, wire approx. 4 m long) ⇒ <i>Figure 2-5-</i>
----	3x	Protective foam roll (Ø approx. 29 x 74) ⇒ <i>Figure 2-6-</i>
----	7x	Tie-wrap, 145 x 3.6 x 1.1 ⇒ <i>Figure 2-7-</i>
N.907.326.01	4x	Socket contact, 4.8 x Ø 1.0 mm <sup>2</sup> ⇒ <i>Figure 2-8-</i>
N.907.327.01	2x	Socket contact, 4.8 x Ø 2.5 mm <sup>2</sup> (standard power timer) ⇒ <i>Figure 2-9-</i>
N.906.844.01	3x	Socket contact, 2.8 x Ø 1.0 mm <sup>2</sup> (junior power timer) ⇒ <i>Figure 2-10-</i>
999.650.136.22	4x	Socket contact, 5.0 x Ø 1.0 mm <sup>2</sup> ⇒ <i>Figure 2-11-</i>
N.017.506.5	2x	Cable ring eyelet, A6 ⇒ <i>Figure 2-12-</i>
992.971.859.B	2x	Cable ring eyelet, M8 ⇒ <i>Figure 2-13-</i>

N.102.615.01	2 x	Blade-type fuse, 5 amp (mini) ⇒ <i>Figure 2-14-</i>
N .017.131.16	2 x	Blade-type fuse, 5 amp ⇒ <i>Figure 2-15-</i>
— — —	1x	PORSCHE dashcam operating instructions ⇒ <i>Figure 2-16-</i>

Repair kits: **ONLY** order when replacing the windscreen/rear window:

9Y0.044.931	1x	“Adhesive pad” repair kit, includes:
— — —	1x	Adhesive pad on front camera retainer plate (grey)
— — —	1x	Adhesive pad for rear camera (grey)
— — —	1x	3M privacy film (front & rear camera) ⇒ <i>Figure 2-1-</i>

**ONLY** order if front camera “wiring harness” is damaged:

9Y0.044.931	1x	“Adhesive pad” repair kit
9Y0.044.932	1x	Wiring harness repair kit, includes:
— — —	1x	Front camera retainer plate assembly with wire harness (WITHOUT adhesive pads, similar to ⇒ <i>Figure 2-3-</i> )
— — —	1x	Wire harness assembly with connector (3-pin, wire approx. 4 m long) ⇒ <i>Figure 2-4-</i>
— — —	3 x	Protective foam roll (∅ approx. 29 x 74) ⇒ <i>Figure 2-5-</i>
— — —	7 x	Tie-wrap, 145 x 3.6 x 1.1 ⇒ <i>Figure 2-6-</i>
— — —	1x	Bag with socket contacts, cable ring eyelets and fuses ⇒ <i>Figure 2-7 to 14-</i>

Technical details:

- Video recording in Quad High Definition (QHD)
- Lens with polarization filter to reduce reflections and improve colors and contrasts
- Audio recording (can be deactivated)
- Global positioning system (GPS) sensor
- Vibration sensor
- Radar sensor for video recording when an object is approaching the vehicle
- Bracket for the windscreen for fixed mounting on the vehicle

Materials:

— — —	1 x	Auxiliary line (Tekalan or Teflon hose) approx. 1,500 mm/ 59.1 in long
— — —	1 x	Wrapping / insulating tape (commercially available)
— — —	1 x	Cleaning cloth (commercially available)
— — —	1 x	Isopropanol (commercially available)

Tool:

**P90999 - PIWIS Tester 4**

Tablet, smartphone or PC with Internet access

Marking pencil / chalk

Flashlight

Plastic squeegee

- Installation:
- 1 Preparatory work
    - 1.1 Clean inside and outside of the windshield.
    - 1.2 Expose front roof area
      - 1.2.1 Remove roof console. ⇒ *Workshop Manual 'Removing and installing front roof console'*
    - 1.3 Expose A-pillar (left) and dashboard area.
      - 1.3.1 Remove A-pillar (left). ⇒ *Workshop Manual 'Remove and install A-pillar trim panel'*
      - 1.3.2 Remove dashboard trim panel (at the left). ⇒ *Workshop Manual 'Remove and install dashboard cover'*
      - 1.3.3 Loosen left fuse carrier. ⇒ *Workshop Manual 'Detaching and securing fuse box in footwell'*

2 Install PORSCHE front camera (dashcam) in the vehicle

Overview of installation position ⇒ *Figure 6*

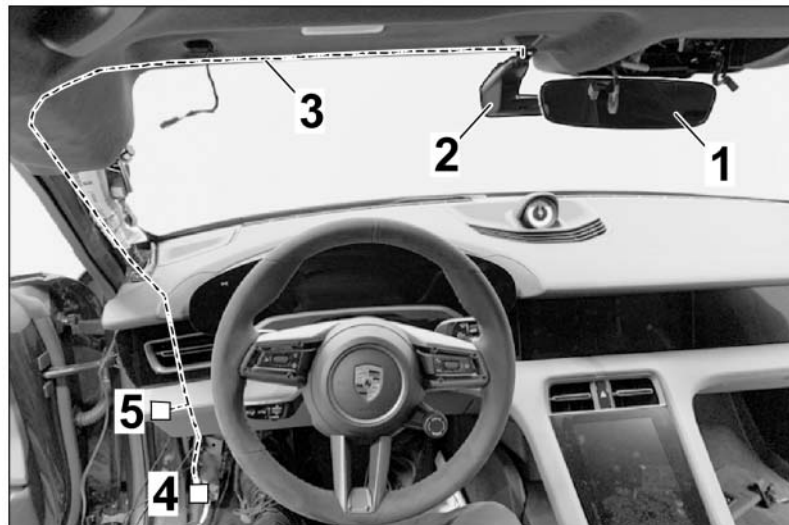

*Figure 6*

- 1 – Interior mirror
- 2 – Installation position of PORSCHE front camera (dashcam)
- 3 – Electric wiring harness
- 4 – Fuse box on dashboard (at the left)
- 5 – Ground pin

2.1 Position front camera (dashcam) to the **LEFT** of the interior mirror on the windshield in direction of travel

2.1.1 Install retainer plate with wire harness on the base of the front camera until the locking mechanism engages (⇒ *Figure 7*).

- 1 – Retainer plate with wire harness
- 2 – Front camera base

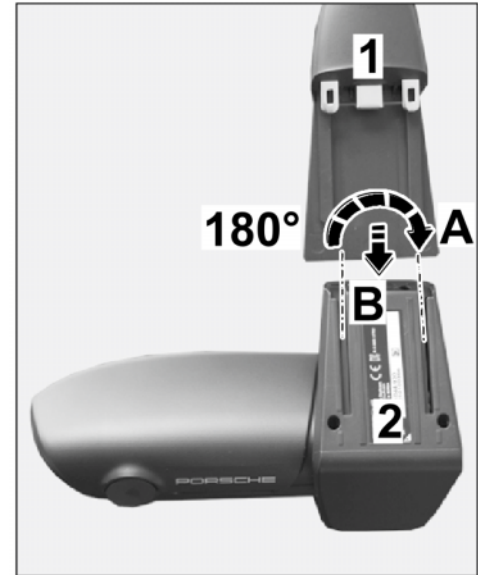

*Figure 7*

2.1.2 Trace the outline of the interior mirror (⇒ *Illustration may be different, check dimensions -1-*) on the outside of the windshield using a marking pencil / chalk.

- 1 – Outline of interior mirror
- 2 – Outline of front camera base
- 3 – Interior mirror
- 4 – Front camera
- X – RoW/NAR: 276 mm/ 10.9 in
- Z – RoW/NAR: 28 mm/ 1.1 in

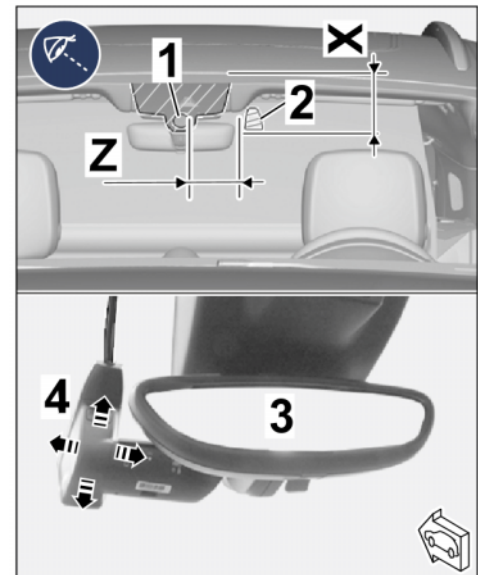

*Illustration may be different,  
check dimensions*

2.1.3 Copy dimensions X and Z on the windshield. **The following dimensions affect the RoW variants**

Dimension X = distance from lower edge of outline of front camera base to edge of roof: **Length 276 mm**

Dimension Z = distance from inner edge of outline of front camera base to inner edge of outline of rain sensor: **Length 28 mm**



## Information

Observe the following points during positioning/alignment:

- Sufficient distance between front camera and interior mirror base: at least 5 mm/ 0.2 in.
- Get another person standing in front of the vehicle to check and confirm the horizontal alignment of the camera with the PORSCHE logo!

2.1.4 Position front camera with retainer plate in the vehicle at the marking on the windshield.

2.1.5 Get another person to trace and shade in the outline of the retainer plate on the outside of the windshield using a marking pencil / chalk.

2.1.6 Clean the inside of the windshield in the bonding area for the retainer plate (shaded area) to remove any dust and grease.

2.2 Install front camera (dashcam) on the windshield

### NOTICE

#### Adhesive films not prepared/installed correctly

- **Damage to adhesive films**
  - **Inadequate adhesion of adhesive films**
- ⇒ **Carefully clean the areas on which you intend to stick the film to ensure that all traces of oil, grease and silicone are completely removed.**
- ⇒ **Do not touch the bonding surfaces.**
- ⇒ **Object (adhesive film, vehicle, etc.) and ambient temperature: Minimum temperature 15°C / 59 °F.**

2.2.1 Pull 3M privacy film off the backing sheet (⇒ *Figure 9-A*).

- 1 – 3M privacy film
- 2 – Marked bonding surface
- 3 – Interior mirror base

2.2.2 Position 3M privacy film on the marked bonding surface on the windshield (⇒ *Figure 9-B*).

2.2.3 Carefully affix 3M privacy film using a plastic squeegee, starting from the center and moving towards the edge.

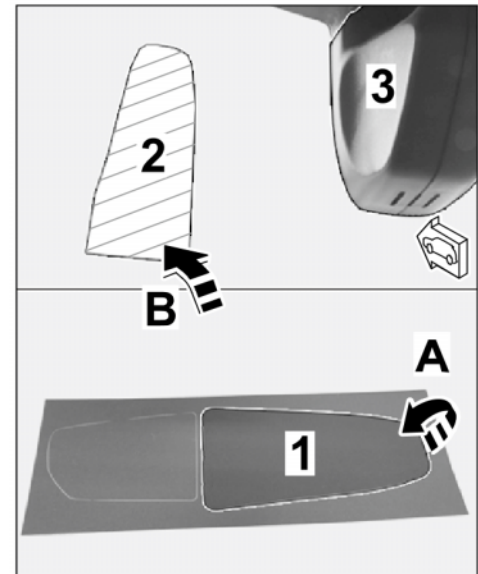

Figure 9

2.2.4 Pull protective film off the front camera retainer plate (⇒ *Figure 10-Top*).

- 1 – Protective film
- 2 – Front camera
- 3 – 3M privacy film
- 4 – Interior mirror



#### Information

Observe the following points during positioning/alignment:

- Sufficient distance between front camera and interior mirror base: at least 5 mm/ 0.2 in.
- Get another person standing in front of the vehicle to check and confirm the horizontal alignment of the camera with the PORSCHE logo!

Align front camera with retainer plate symmetrically with respect to the 3M privacy film (⇒ *Figure 10-Bottom*).

2.2.5 Press front camera with retainer plate firmly onto the 3M privacy film on the windshield.

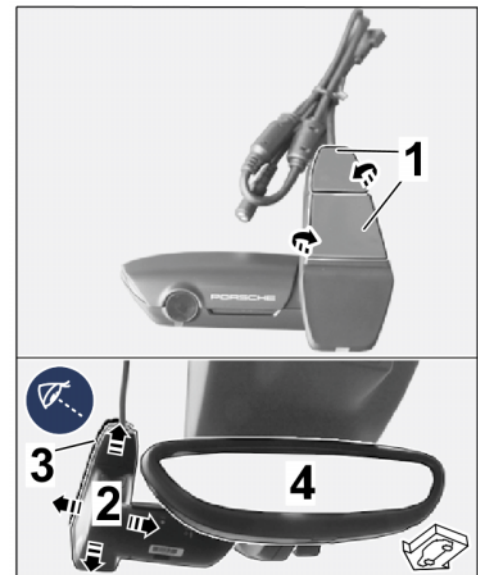

Figure 10

3 Route and connect electric wiring harness



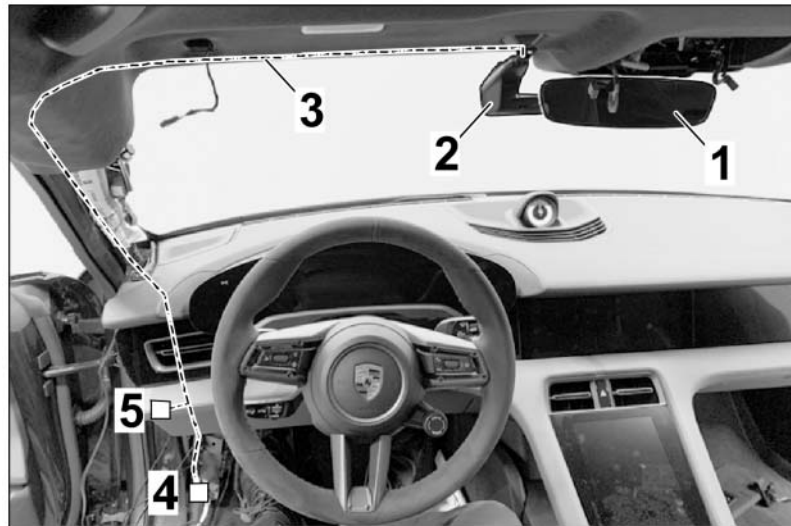

Figure 11

- 1 – Interior mirror
- 2 – Installation position of PORSCHE front camera (dashcam)
- 3 – Electric wiring harness
- 4 – Fuse box on dashboard (at the left)
- 5 – Ground pin

Line routing (⇒ Figure 11):

- Front camera → headliner / roof console → along windshield frame → left A-pillar (top) → along A-pillar → fuse carrier on dashboard at the left → left ground pin.

3.1 Routing wire harness

3.1.1 On the connector side, push one protective foam roll onto the wire harness for the front camera retainer plate and the (3-wire) wire harness.

- 1 – Protective foam roll
- 2 – Wire harness on front camera retainer plate
- 3 – Wire harness (3-wire)
- 4 – Connection for wire harness on retainer plate

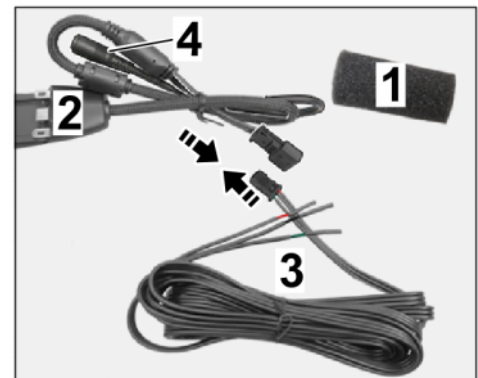

Figure 12

3.1.2 Connect plug connection (3-pin) (⇒ Figure 12-**Arrow**-).

3.1.3 Guide wire harness for front camera (dashcam) vertically with respect to the headliner / roof console.

- 3.1.4 Push protective foam roll over the (3-pin) plug connection.  
Secure (3-pin) plug connection and connection for front camera wiring harness to existing components / lines under the headliner in the roof console area with tie-wraps (⇒ *Figure 13-1-*). Install evenly spaced foam rolls under the roof lining. ⇒ *Figure 13-2-*

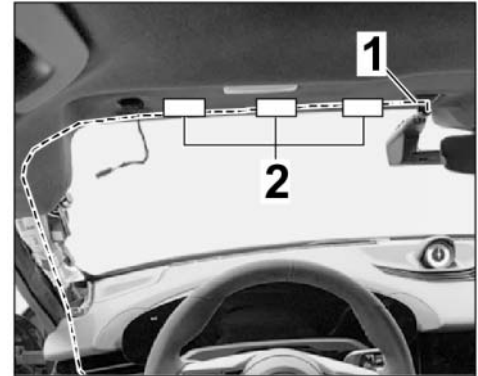

Figure 13

- 3.1.5 Route the rest of the wire harness ⇒ *Figure 14-1-* to the left fuse box ⇒ *Figure 14-2-* as follows; shorten the wiring harness as required and attach contacts.

- 1 – Wire harness for front camera (dashcam)
- 2 – Fuse carrier on dashboard (left)
- Roof console → under headliner along windshield frame → left A-pillar (top) → along A-pillar → fuse carrier on dashboard (left ⇒ *Figure 14-2-*) → BK 0.5<sup>2</sup> line → ground pin

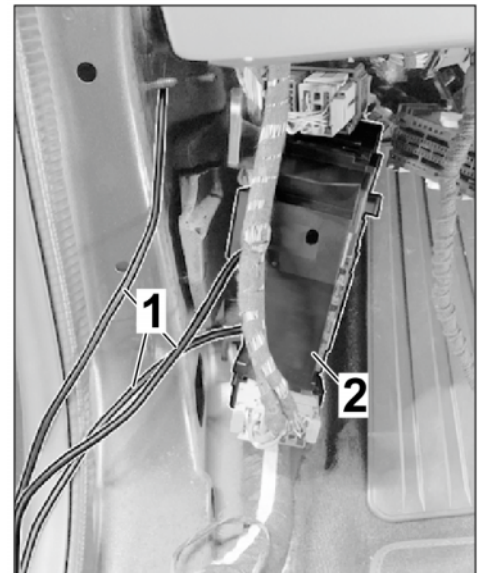

Figure 14

3.2 Connect electric wire harness

Function / line:	Connection point for LHD vehicles
Weight Terminal 31 = BK; 0.5 <sup>2</sup>	Cable ring eyelet (N.017.506.5) on left ground pin next to fuse box under carpet
Ignition positive Terminal 15 = GN; 0.5 <sup>2</sup>	Socket contact N.907.326.01 in fuse holder, White fuse latch D, fuse 2 <b>5 amp fuse, small</b>
Permanent positive Terminal 30 = RD; 0.5 <sup>2</sup>	Socket contact N.907.326.01 in fuse holder, Brown fuse latch B, fuse 8 <b>5 amp fuse, small</b>

- 3.2.1 Remove fuse holder and open rows D and B. ⇒ *Workshop Manual 'Detaching and securing fuse box in footwell'*
- 3.2.2 Connect power supply as shown in the table.
- 3.2.3 Protect front camera power supply by inserting new **small 5 amp fuses** in slots 2 and 8.

Fuse: **Setpoint value 5 A**

- 3.2.4 Loosen fuse carrier ⇒ *Figure 15 -1-* and route line BK; 0.5<sup>2</sup> (terminal 31) to the ground pin ⇒ *Figure 15 -2-* and install on the ground pin using a cable ring eyelet.
- 3.3 Secure routed wire harness to existing lines / components in the vehicle with tie-wraps without tensile stress and so that no chafing occurs.
- 4 Concluding work
  - 4.1 Install left fuse carrier. ⇒ *Workshop Manual 'Detaching and securing fuse box in footwell'*
  - 4.2 Install dashboard trim panel (at the left). ⇒ *Workshop Manual 'Remove and install dashboard cover'*
  - 4.3 Install A-pillar (left). ⇒ *Workshop Manual 'Remove and install A-pillar trim panel'*
  - 4.4 Install roof console. ⇒ *Workshop Manual 'Removing and installing front roof console'*
  - 4.5 Clean inside and outside of the windshield.



Figure 15

Coding: 5 Code the PORSCHE front camera (dashcam) in Dealer mode

5.1 Preparatory work

- 1 – PORSCHE front camera
- 2 – Micro SD memory card (32 GB)
- 3 – Retainer plate
- 4 – Power button
- 5 – WiFi status LED display
- 6 – PRESS (release button)

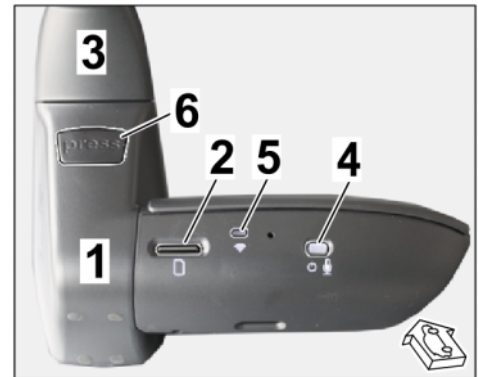

Figure 16

- 5.1.1 Remove micro SD memory card (32 GB, ⇒ *Figure 16-2-*) from card slot for front camera.
- 5.1.2 With the ignition switched on, push the front camera (dashcam ⇒ *Figure 16-1-*) into the retainer plate on the windshield (⇒ *Figure 16-3-*)
- 5.1.3 Press the power button (⇒ *Figure 16-4-*) for 10 seconds until you hear the second double beeping sound.
- 5.1.4 The front camera (dashcam) starts in Dealer mode: WiFi LED (⇒ *Figure 16-5-*) lights up "yellow".

5.2 Connect the front camera (dashcam) to the device (tablet, smartphone or PC)



**Information**

The "Dealer mode" network ID name ends with a "D". A password is **NOT** required!

The language setting can be changed by following the menu prompts after opening the first page.

- 5.2.1 Search available networks for Dealer mode WiFi.
- 5.2.2 Open Dealer mode on the device (tablet, smartphone or PC) using any browser.  
To do this, enter "**192.168.1.1/diagnostics**" in the browser's address line.
- 5.2.3 Displays in "Dealer mode" main menu:

Options:

- 1 – Browser's address line
- 2 – "Options" menu item

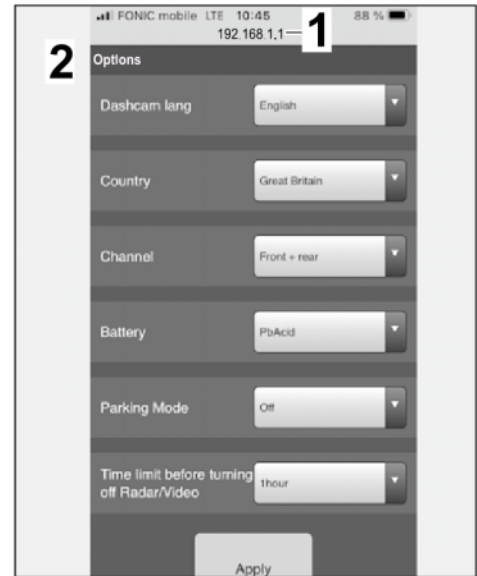

Figure 17

Diagnostics:

- 1 – Browser's address line
- 2 – "Diagnostics" menu item

5.3 Basic settings for front camera (dashcam) in the "Options" menu item

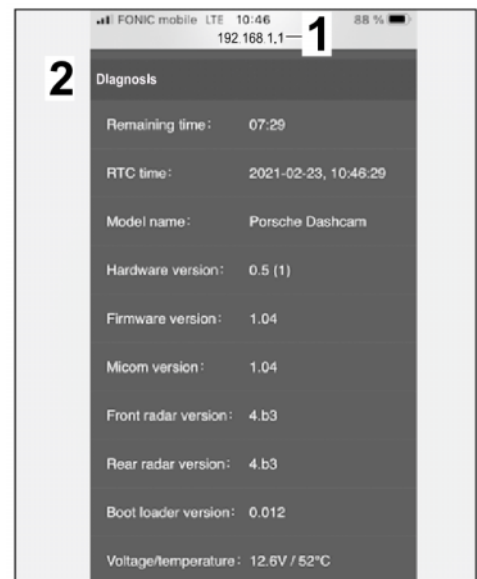

Figure 18

5.3.1 Change the default language "English" to the desired language:

- 1 – Default language "English"
- 2 – German

For example: German

- Up to 19 different languages can be selected.

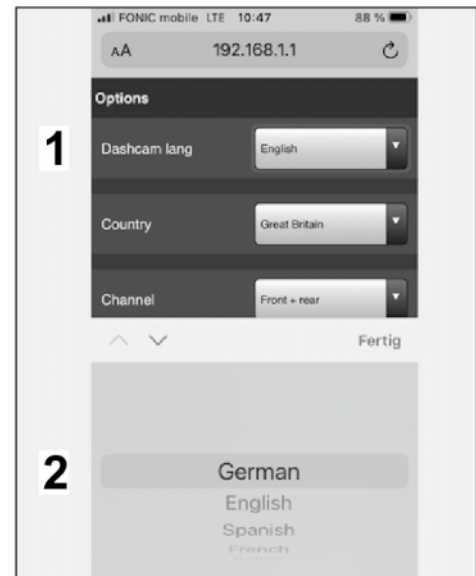

Figure 19



#### Information

**ONLY** for cameras with serial numbers "PDF2101\*\*\*\*\*", the country can be selected directly via the app on the customer's device (smartphone/tablet).

Country selection is possible for cameras, starting with the serial number "PDF2102\*\*\*\*\*"!

If the relevant country is **NOT** displayed in the drop-down menu: Please select "Global".

5.3.2 Select the country.

- 1 – Serial number of front camera (dashcam)
- 2 – Country
- 3 – Great Britain

- Up to 48 countries are currently available for selection.
- The Country selection screen includes, for example: Units of measurement, frequencies and also legal regulations of the respective country.
- **Taycan:** ⇒ Choose Region/State/Country by selecting the appropriate flag.

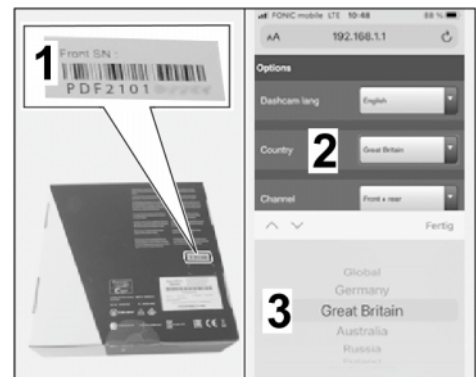

Figure 20

5.3.3 Select the required camera channel.

- 1 - Channel
- 2 - Front + Rear

- **TEQUIPMENT:** ⇒ "Front Only" (front camera) is preset.

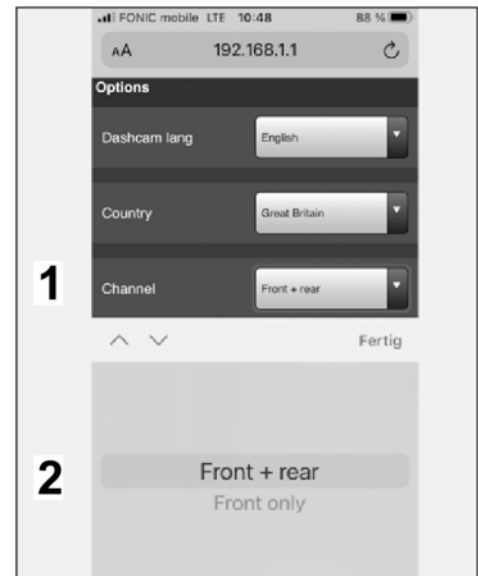

Figure 21



### Information

Check which vehicle electrical system battery is installed in the vehicle if necessary by entering the vehicle identification number (VIN) in the Porsche Central Service System (PCSS).

**Background:** The front camera shuts down if the correct battery voltage (switch-off threshold) is not reached over a period of 5 minutes.

- Switch-off threshold for lead-acid battery (PbAcid) = 11 V

- Switch-off threshold for lithium-ion battery (LiFePO) = 13 V

#### 5.3.4 Select the battery type

- 1 – Battery
  - 2 – PbAcid
- Select the vehicle electrical system battery installed in the vehicle.
  - **Taycan:** ⇒ LiFePo

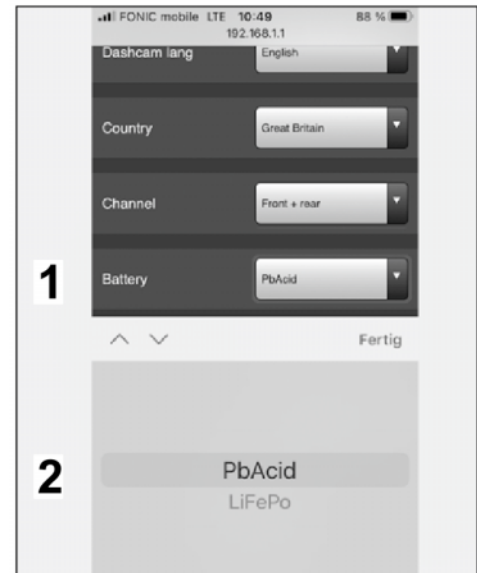

Figure 22

#### 5.3.5 Select Park mode

- 1 – Park mode
  - 2 – Off
- Depending on the approval for the respective vehicle.
  - **Taycan:** ⇒ Off.

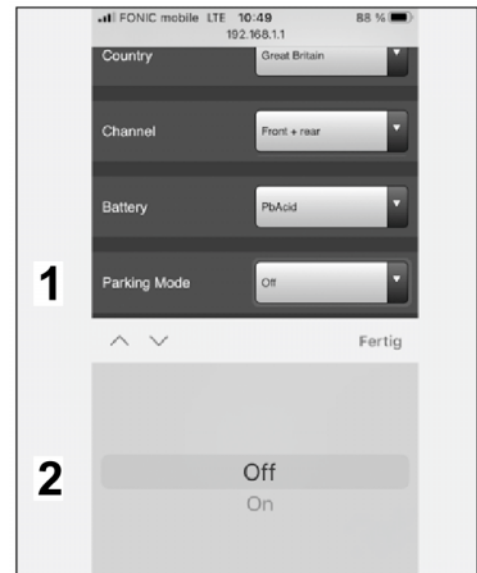

Figure 23



- 5.3.6 Select the time limit
- 1 – Time limit until radar/video is switched off
  - 2 – 1 hour
- Turn off radar/video monitoring in Park mode (battery management). After the selected time limit, fast activation of the monitoring system **ONLY** occurs if the vehicle shakes/vibrates!
  - **Taycan:** ⇒ Off

5.4 Cancel Dealer mode (WiFi LED is still yellow)

5.4.1 Close the browser and switch off ignition.

5.4.2 Pull the front camera (dashcam) off the retainer plate by pressing "PRESS" (release button).

5.4.3 Insert micro SD memory card (32 GB) in the front camera (dashcam).

5.4.4 Install the front camera (dashcam) in the retainer plate.

5.5 The settings configured under Step 5.3 are set when the ignition is switched on again.

5.6 Format the micro SD memory card (32 GB)

5.6.1 Switch on ignition.

5.6.2 Press the power button quickly 6 times in a row within 3 seconds.

Announcements via front camera speaker: "Formatting..." and "Formatting complete."

Diagnostics: 6 Perform diagnostics on front camera (dashcam) – **ONLY** if necessary!

Information can be displayed, function tests can be run and results can be stored in the "Diagnostics" menu item.

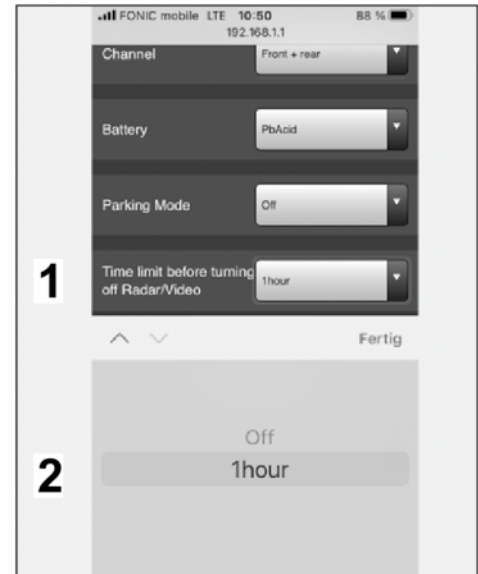

Figure 24

6.1 Information about the model name, hardware and software version, radar and more.

- 1 – Model name
- 2 – Hardware version
- 3 – Software version

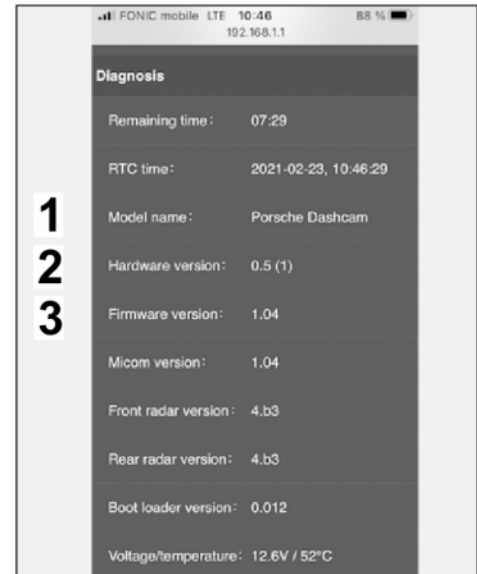

Figure 25

6.2 Display of live images from front camera, connection status, memory card status, GPS and radar status and more.

- 1 – Front camera live image
- 2 – Rear camera status (if installed)
- 3 – Micro SD memory card contents
- 4 – GPS status
- 5 – GPS coordinates

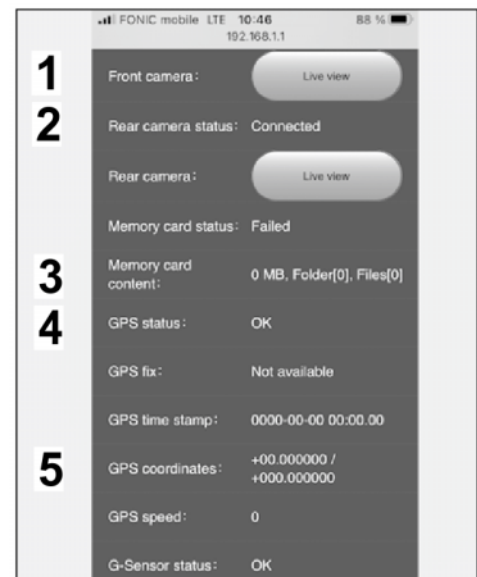

Figure 26

6.3 Display of radar status, possible tests for LED lights, loudspeaker and microphone

- 1 – Radar status
- 2 – LED Lights test
- 3 – Loudspeaker test
- 4 – Microphone test

6.4 The fault report can be stored on the micro SD memory card (32 GB). To do this, use micro SD memory card in Dealer mode and select "Diagnostics" menu item in the front camera.

Installing:

7 Concluding work

7.1 Read out the fault memories of all systems, work through any existing faults and erase the fault memories. ⇒ *Workshop Manual '0X03IN Diagnostic maintenance: diagnostic system and maintenance inter...'*

7.2 Disconnect the battery charger. ⇒ *Workshop Manual '2X00IN Work instructions after disconnecting the battery'.*

7.3 Vehicle handover to customer



**Information**

Please pass all this information on to the customer.

Also give the customer the PORSCHE dashcam operating instructions.

Also give the first 3 pages of these Installation and Conversion Instructions to the customer.

7.3.1 Download the app from the App Store to the customer's device (smartphone/tablet).

7.3.2 Select and set Region/State/Country (flag) in the app on the customer's smartphone/tablet.

7.3.3 Firmware update by the customer via the app.

7.3.4 Format micro SD memory card (32 GB).

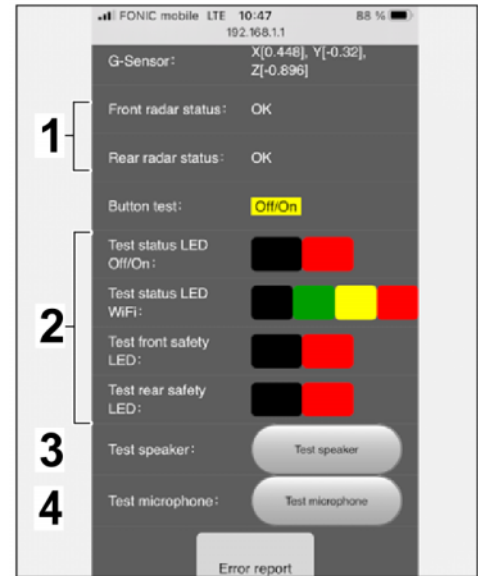

Figure 27

- 91 63 23 40: –Retrofitting PORSCHE front camera (dashcam) (1 x)– Labor time: **295 TU**
- Includes:
- Installing retainer plate for PORSCHE front camera (dashcam) on windshield.
  - Routing and connecting electric wire harness.
  - Coding PORSCHE front camera (dashcam) in Dealer mode and formatting micro SD memory card.
  - Reading out fault memories and correcting and deleting faults.

**Important Notice:** Technical Bulletins issued by Porsche Cars North America, Inc. are intended only for use by professional automotive technicians who have attended Porsche service training courses. They are written to inform those technicians of conditions that may occur on some Porsche vehicles, or to provide information that could assist in the proper servicing of a vehicle. Porsche special tools may be necessary in order to perform certain operations identified in these bulletins. Use of tools and procedures other than those Porsche recommends in these bulletins may be detrimental to the safe operation of your vehicle, and may endanger the people working on it. Properly trained Porsche technicians have the equipment, tools, safety instructions, and know-how to do the job properly and safely. Part numbers listed in these bulletins are for reference only. The work procedures updated electronically in the Porsche PIWIS diagnostic and testing device take precedence and, in the event of a discrepancy, the work procedures in the PIWIS Tester are the ones that must be followed.

© 2024 Porsche Cars North America, Inc.