



Subject: CX-70 AND CX-90 SERVICE CAUTIONS FOR NEW AND REVISED FEATURES	Service Alert No.: SA-020/24
	Last Issued : 09/10/2024

BULLETIN NOTES

This Service Alert supersedes the previously issued SA(s) listed below. The changes are noted in Red.

Previous SAs:	Date(s) Issued:
SA-020/24	04/23/24 and 03/19/24
SA-017/23	11/06/23, 09/14/23, 08/28/23, 07/24/23, 06/09/23, 05/24/23, 05/15/23 and 03/27/23

APPLICABLE MODEL(S)/VINS

2025 CX-70
2024-~~2025~~ CX-90

DESCRIPTION

The CX-70 and CX-90 have new and revised features that are different from previous models and may be difficult to understand. This Service Alert provides valuable information to support potential dealer and customer concerns.

Index

- [PDI fuse](#)
- [Key Transmitter and Auxiliary Key](#)
- [Immobilizer \(Code Word\)](#)
- [Theft-Deterrent System](#)
- [High Voltage](#)
 - [Mazda M Hybrid Boost](#)
 - [Plug-In Hybrid Electric Vehicle \(PHEV\)](#)
 - [High Voltage Battery Service Cautions](#)
 - [High Voltage Battery Maintenance](#)
 - [PHEV 355V High Voltage Shutdown Before Service](#)
 - [M Hybrid Boost 48V High Voltage Shutdown Before Service](#)
 - [High Voltage Battery Replacement](#)
 - [Back Up Sub Battery for e-SKYACTIV PHEV](#)
 - [PHEV Refueling Procedure](#)
 - [PHEV Instrument Cluster Battery Range](#)
 - [PHEV interfere with flat lift](#)
 - [PHEV 355V and M Hybrid Boost 45V Electric Fan Service Caution](#)
 - [Engine Coolant Drain Location](#)

CONSUMER NOTICE: The information and instructions in this bulletin are intended for use by skilled technicians. Mazda technicians utilize the proper tools/ equipment and take training to correctly and safely maintain Mazda vehicles. These instructions should not be performed by "do-it-yourselfers." Customers should not assume this bulletin applies to their vehicle or that their vehicle will develop the described concern. To determine if the information applies, customers should contact their nearest authorized Mazda dealership. Mazda North American Operations reserves the right to alter the specifications and contents of this bulletin without obligation or advance notice. All rights reserved. No part of this bulletin may be reproduced in any form or by any means, electronic or mechanical--including photocopying and recording and the use of any kind of information storage and retrieval system ---without permission in writing.

- PHEV 355V HVAC Compressor Oil
- Engine Oil Level Measurement (Infotainment Center Display)
- FR-8EAT(Front Engine Rear Drive-8 Electrical Automatic Transmission)
- Transfer Case for All-Wheel Drive
- i-stop
- 12V Battery Charging / Testing
- i-ACTIVSENSE
 - i-ACTIVSENSE Indicators
 - Smart Brake Support (SBS)
 - Forward detection function
 - Turn-Across Traffic
 - Front Crossing
 - Intersection accident avoidance assist function
 - Rearward detection function
 - Rear Crossing
 - Secondary Collision Reduction
 - Mazda Radar Cruise Control with Stop & Go Function System (MRCC)
 - Speed Limit Assist
 - Cruising & Traffic Support (CTS)
 - Cruising and Traffic Support- Risk Mitigation Function (CTS-RMF) (CX-70 only)
 - Distance & Speed Alert (DSA)
 - Lane-Keep Assist System
 - Lane Departure Warning System (LDWS)
 - Emergency Lane Keeping (ELK)
 - Road Keep Assist
 - Blind Spot Assist
 - Head-on traffic avoidance assist
 - High Beam Control System (HBC)
 - Blind Spot Monitoring (BSM) System
 - Vehicle Exit Warning
 - Front Cross Traffic Alert (FCTA) System
 - Rear Cross Traffic Alert (RCTA) System
 - Driver Attention Alert (DAA) System
 - Driver Monitoring (DM)
 - Private e-call (Canada Only) (CX-70 only)
 - Traffic Sign Recognition System (TSR)
 - 360° View Monitor System
 - Trailer Hitch View (CX-70 only)
- Driver Personalization System
- Connected Vehicle
 - MyMazda App Remote Engine Start
 - Mazda Connected Vehicle Viewer (MCVV)
- Mazda intelligent Drive Select (Mi-Drive)
- Hill Descent Control
- AUTOHOLD
- Hill Launch Assist (HLA)
- Kinematic Posture Control (KPC)
- Liftgate Lens Illumination

CONSUMER NOTICE: The information and instructions in this bulletin are intended for use by skilled technicians. Mazda technicians utilize the proper tools/ equipment and take training to correctly and safely maintain Mazda vehicles. These instructions should not be performed by "do-it-yourselfers." Customers should not assume this bulletin applies to their vehicle or that their vehicle will develop the described concern. To determine if the information applies, customers should contact their nearest authorized Mazda dealership. Mazda North American Operations reserves the right to alter the specifications and contents of this bulletin without obligation or advance notice. All rights reserved. No part of this bulletin may be reproduced in any form or by any means, electronic or mechanical--including photocopying and recording and the use of any kind of information storage and retrieval system ---without permission in writing.

- Power Liftgate Hands-free function
- Remote Power Window
- Electric Parking Brake (EPB)
- MAZDA CONNECT
 - MAZDA CONNECT Power Function
 - Alexa Built-In (CX-70 only)
 - Mazda Online Navigation (CX-70 only)
 - Wireless Apple Carplay™ / Android Auto™
 - Wireless Qi Charger
 - USB Type C Flash Drive
- Transmitter Battery Saving Function
- Occupant Comfort
- Rear Seat Alert
- Maintenance Mode
 - Connected Vehicle Maintenance Mode
 - Engine Maintenance Mode
 - Front Wiper Service Position
 - Rear Brake Maintenance Mode
 - PHEV 355V High Voltage Shutdown Before Service
 - M Hybrid Boost 48V High Voltage Shutdown Before Service
- Web-Based Training Courses

CONSUMER NOTICE: The information and instructions in this bulletin are intended for use by skilled technicians. Mazda technicians utilize the proper tools/ equipment and take training to correctly and safely maintain Mazda vehicles. These instructions should not be performed by "do-it-yourselfers." Customers should not assume this bulletin applies to their vehicle or that their vehicle will develop the described concern. To determine if the information applies, customers should contact their nearest authorized Mazda dealership. Mazda North American Operations reserves the right to alter the specifications and contents of this bulletin without obligation or advance notice. All rights reserved. No part of this bulletin may be reproduced in any form or by any means, electronic or mechanical---including photocopying and recording and the use of any kind of information storage and retrieval system ---without permission in writing.

Item	Service Information
------	---------------------

Fuse to be Installed at PDI

Fuse F1 (25A) is removed from the engine compartment drivers side fuse block.

NOTE:

- Make sure the fuse is fully installed into position and flush with all of the other fuses.
- Check for the Connected Vehicle signal after installing fuse F1. The connectivity signal bar looks like a vertical stack bar on the bottom right corner of the screen and should be white as shown below to be working properly. This bar is not displayed on the "Home" screen, but on the "Entertainment" or "Navigation" menu.



- The following instrument cluster error messages may appear prior to PDI completion. The error messages will clear after fuse F1 is installed.

In-Vehicle Network Malfunction. Have the Vehicle Inspected

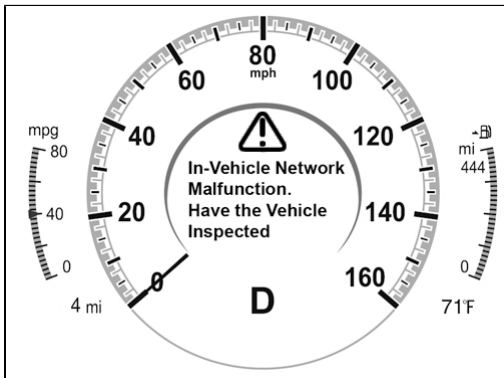

Driver Attention Alert Disabled

Service Information

Fuse Block (Engine Compartment Drivers Side)

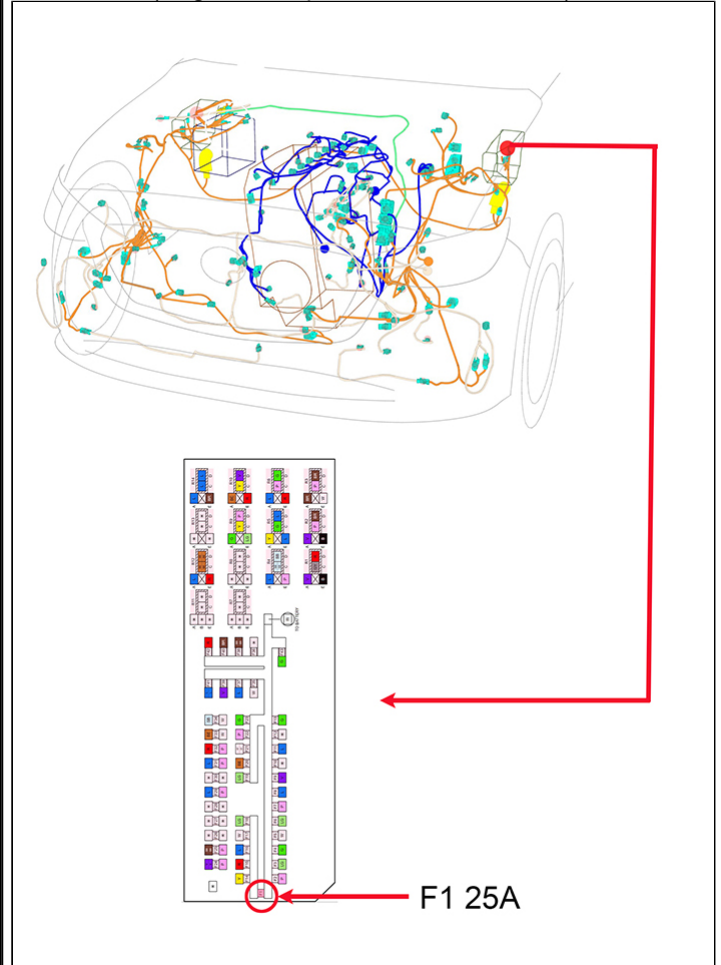

CONSUMER NOTICE: The information and instructions in this bulletin are intended for use by skilled technicians. Mazda technicians utilize the proper tools/ equipment and take training to correctly and safely maintain Mazda vehicles. These instructions should not be performed by "do-it-yourselfers." Customers should not assume this bulletin applies to their vehicle or that their vehicle will develop the described concern. To determine if the information applies, customers should contact their nearest authorized Mazda dealership. Mazda North American Operations reserves the right to alter the specifications and contents of this bulletin without obligation or advance notice. All rights reserved. No part of this bulletin may be reproduced in any form or by any means, electronic or mechanical---including photocopying and recording and the use of any kind of information storage and retrieval system ---without permission in writing.

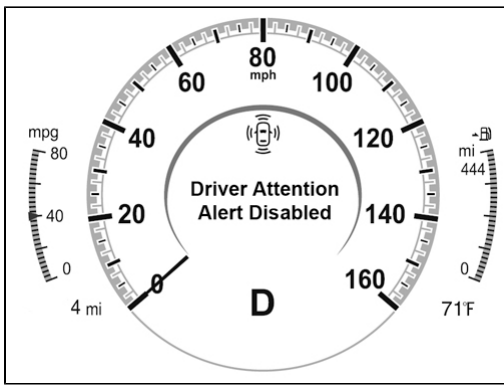

Key Transmitter and Auxiliary Key

Vehicles arrive at the dealer with auxiliary keys and key transmitters located in the front cup holders.

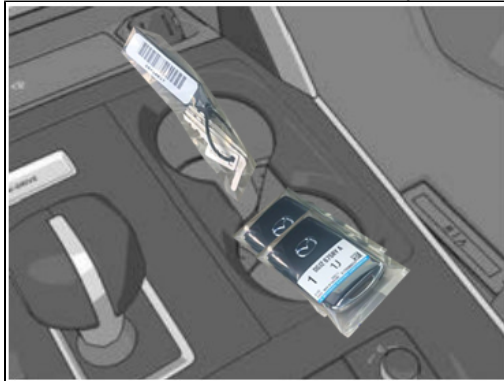

[SA-016/23](#)

Temporary Lost Key Procedure

See Owner's Manual -> Opening/closing -> [Key](#)

<p>Except CX-50, CX-70, CX-90, 5 digit key code</p>	<p>CX-50, CX-70, CX-90, 4 digit key code and a plastic bar code tag</p>

CONSUMER NOTICE: The information and instructions in this bulletin are intended for use by skilled technicians. Mazda technicians utilize the proper tools/ equipment and take training to correctly and safely maintain Mazda vehicles. These instructions should not be performed by "do-it-yourselfers." Customers should not assume this bulletin applies to their vehicle or that their vehicle will develop the described concern. To determine if the information applies, customers should contact their nearest authorized Mazda dealership. Mazda North American Operations reserves the right to alter the specifications and contents of this bulletin without obligation or advance notice. All rights reserved. No part of this bulletin may be reproduced in any form or by any means, electronic or mechanical--including photocopying and recording and the use of any kind of information storage and retrieval system ---without permission in writing.



- Discard the plastic bar code tag during PDI. The plastic bar code tag is used during vehicle production and is not needed by the customer.
- If additional auxiliary metal keys are needed, the key machine will require a 5-digit code. Just add "5" as the 1st digit to make the 4-digit to 5-digit.

The auxiliary keys need to be inserted into the key transmitters during PDI.

<p>Remove the transmitter lower cover by sliding the knob in the direction shown and then sliding the cover in the opposite direction.</p>	
<p>Insert the auxiliary key.</p>	
<p>Install the transmitter lower cover by inserting the tabs of the lower cover into the slots of the transmitter.</p>	

Transmitter Note:

CONSUMER NOTICE: The information and instructions in this bulletin are intended for use by skilled technicians. Mazda technicians utilize the proper tools/ equipment and take training to correctly and safely maintain Mazda vehicles. These instructions should not be performed by "do-it-yourselfers." Customers should not assume this bulletin applies to their vehicle or that their vehicle will develop the described concern. To determine if the information applies, customers should contact their nearest authorized Mazda dealership. Mazda North American Operations reserves the right to alter the specifications and contents of this bulletin without obligation or advance notice. All rights reserved. No part of this bulletin may be reproduced in any form or by any means, electronic or mechanical---including photocopying and recording and the use of any kind of information storage and retrieval system ---without permission in writing.



- If one transmitter is lost, inform the customer to take cautions not to lose the 2nd transmitter.
- If both transmitters are lost, the vehicle will be disabled and MDARS will need to be used to program new transmitters.
- Replacement battery type is CR2032 (3V, 225mAh), which is different then previous 6th generation transmitter battery type CR2025 (3V, 160mAh). If the wrong battery is installed, the transmitter might not work properly (malfunction).

Immobilizer (Code Word)

CX-70, CX-90 have 32 character immobilizer in and out codes (2 sets of 16 characters).

When a CX-70, CX-90 VIN is input into the Immobilizer (Code Word application you will have two Out Code fields. Outcode #1 and Outcode #2 from MDARS should be entered in these fields.

**Mazda North American Operations
Immobilizer (Code Word)**

Dealer Code

User ID

VIN

Part Number

Serial/Authentication Number

Error Control Number

Request Reason

Model Type

Outcode1 Outcode2

Once retrieved, there will be an "Incode1" and "Incode2" that will need to be entered into MDARS.

**Mazda North American Operations
Immobilizer (Code Word)**

Immobilizer In Code

Incode1 **54BBCAF912B14A11** Incode2 **B1A753A373024EC7**

Theft-Deterrent System

If the theft-deterrent system detects an inappropriate entry into the vehicle, which could result in the vehicle or its contents being stolen, the alarm alerts the surrounding area

Owner's Manual -> Opening / Closing -> Security System -> [Theft-Deterrent System](#)

CONSUMER NOTICE: The information and instructions in this bulletin are intended for use by skilled technicians. Mazda technicians utilize the proper tools/ equipment and take training to correctly and safely maintain Mazda vehicles. These instructions should not be performed by "do-it-yourselfers." Customers should not assume this bulletin applies to their vehicle or that their vehicle will develop the described concern. To determine if the information applies, customers should contact their nearest authorized Mazda dealership. Mazda North American Operations reserves the right to alter the specifications and contents of this bulletin without obligation or advance notice. All rights reserved. No part of this bulletin may be reproduced in any form or by any means, electronic or mechanical--including photocopying and recording and the use of any kind of information storage and retrieval system ---without permission in writing.

of an abnormality by sounding the horn and flashing the hazard warning lights.
The system will not function unless it's properly armed. So when you leave the vehicle, follow the arming procedure correctly.

Mazda M Hybrid Boost (Inline 6 cylinder)

M hybrid boost uses kinetic energy generated during deceleration to charge the M hybrid boost battery which generates power using a motor with excellent power generation efficiency. Using the electrical power stored in the M hybrid boost battery, a high-capacity storage battery, contributes to improved driving performance and fuel economy by reducing engine load and performing motor assist. In addition, restarting the engine from the istop status using the motor achieves quiet performance.

MGSS -> [Mazda M Hybrid Boost](#)

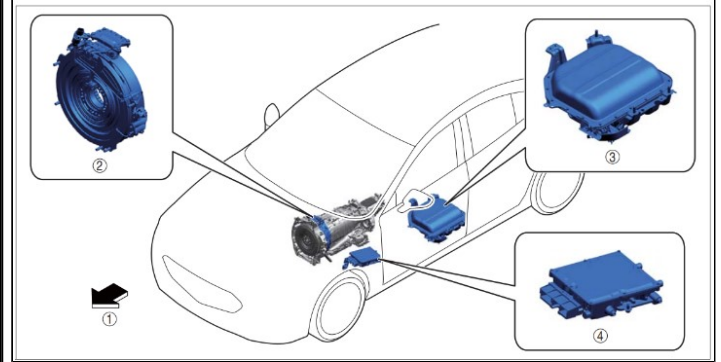

1. Vehicle Front
2. Motor
3. M hybrid boost battery (48 volts LiB Pack)
4. DC-DC Converter (M Hybrid Boost)

Plug-In Hybrid Electric Vehicle (PHEV) System Outline (Inline 4 cylinder)

- The motor is integrated between the longitudinal engine and the transmission, and a two-clutch, one-motor parallel hybrid system that transmits drive force through the clutch has been adopted.
- A plug-in hybrid system that can be can be recharged from an external power source has been adopted

MGSS -> [EV SYSTEM OUTLINE](#)

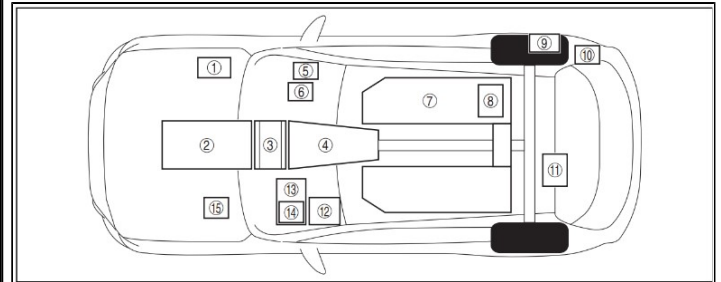

1. Lead-acid Battery
2. Engine
3. Motor

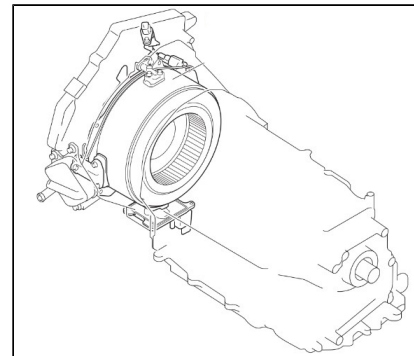

4. Transmission

CONSUMER NOTICE: The information and instructions in this bulletin are intended for use by skilled technicians. Mazda technicians utilize the proper tools/ equipment and take training to correctly and safely maintain Mazda vehicles. These instructions should not be performed by "do-it-yourselfers." Customers should not assume this bulletin applies to their vehicle or that their vehicle will develop the described concern. To determine if the information applies, customers should contact their nearest authorized Mazda dealership. Mazda North American Operations reserves the right to alter the specifications and contents of this bulletin without obligation or advance notice. All rights reserved. No part of this bulletin may be reproduced in any form or by any means, electronic or mechanical--including photocopying and recording and the use of any kind of information storage and retrieval system ---without permission in writing.

- 5. Sub-battery
- 6. PCM
- 7. High voltage (for drive) battery (355 volts LiB Pack)

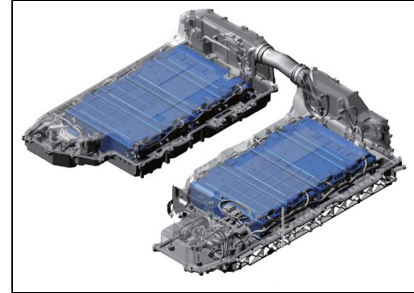

- 8. BECM
- 9. Charging port electrical supply unit
- 10. Charging control unit
- 11. 1500W PSU
- 12. DC/DC converter
- 13. Inverter
- 14. Drive Motor Control Module
- 15. Electronically controlled brake unit

High Voltage Battery Service Cautions

Inner Service of High Voltage Battery (LiB Pack for PHEV: 355 volts) should **NOT** be handled by Dealer Technicians for SAFETY reason. Also, NO Inner Service for 48 volts LiB Pack is allowed.

High Voltage Battery Maintenance

For new vehicles in stock at the dealer, inspect and maintain the high voltage battery periodically.

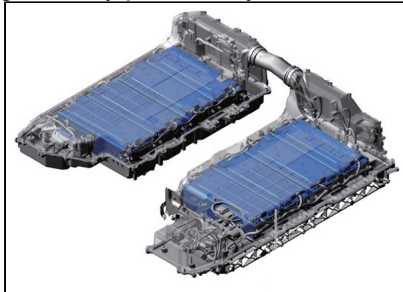

SA-018/23

PHEV 355V High Voltage Shutdown Before Service

CAUTION: Technician **Hybrid & EV Specialist Certification** is required.

Always make sure to follow the MGSS High Voltage Shutdown procedure before servicing the vehicle.

- 1) Confirm No charging cable at the charging connector.
- 2) Open the Driver's side door.
- 3) IG ON (READY LAMP ON) and wait for 3 seconds or more.

View from the bottom of
PHEV LiB Package

P-N Terminals

CONSUMER NOTICE: The information and instructions in this bulletin are intended for use by skilled technicians. Mazda technicians utilize the proper tools/ equipment and take training to correctly and safely maintain Mazda vehicles. These instructions should not be performed by "do-it-yourselfers." Customers should not assume this bulletin applies to their vehicle or that their vehicle will develop the described concern. To determine if the information applies, customers should contact their nearest authorized Mazda dealership. Mazda North American Operations reserves the right to alter the specifications and contents of this bulletin without obligation or advance notice. All rights reserved. No part of this bulletin may be reproduced in any form or by any means, electronic or mechanical--including photocopying and recording and the use of any kind of information storage and retrieval system ---without permission in writing.

4) IG OFF (READY LAMP OFF) and wait for 5 minutes (Wait for stop of Electric fan if moving even after 5 minutes.)
 5) Remove minus terminal at 12 volts Lead-acid battery within 25 minutes after IG OFF (then, Driver's door can be closed.) and wait for more 1 minute.
 6) Remove SERVICE PLUG with electrical insulating gloves.
 7) Leave 10 minutes or more for electric discharge.
 8) Check NO voltage at INVERTER Harness connection (P-N terminals) in PHEV LiB Package with electrical insulating gloves.
 9) In case of removing OBC &/or 1500W Power Supply after OBC Contactor, Check NO voltage at P-N terminals at 1500W Power Supply coupler with electrical insulating gloves.

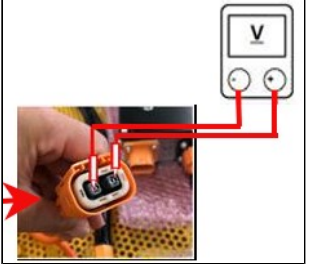
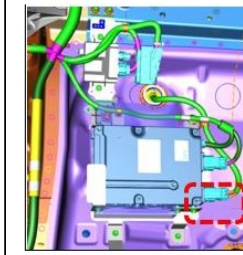
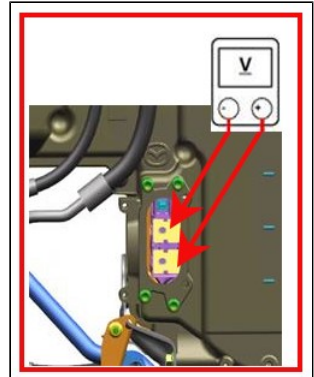
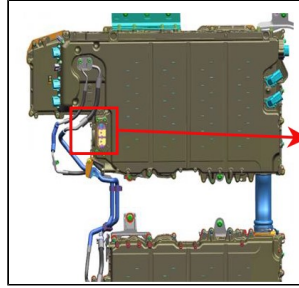

1500W Power Supply

P-N Terminals
 Volt Meter to use Max DC 450V

M Hybrid Boost 48V High Voltage Shutdown Before Service

Always make sure to follow the MGSS High Voltage Shutdown procedure before servicing the vehicle.
 1) IG OFF (READY LAMP OFF) and confirm stopping the Engine.
 2) Leave 30 seconds or more.
 3) Remove minus terminal at 12 volts Lead-acid battery.

High Voltage Battery Replacement

If MGSS diagnosis leads to a high voltage battery replacement, contact Hotline for technical support.
CAUTION: DO NOT perform MGSS HIGH VOLTAGE BATTERY REMOVAL/INSTALLATION.

CONSUMER NOTICE: The information and instructions in this bulletin are intended for use by skilled technicians. Mazda technicians utilize the proper tools/ equipment and take training to correctly and safely maintain Mazda vehicles. These instructions should not be performed by "do-it-yourselfers." Customers should not assume this bulletin applies to their vehicle or that their vehicle will develop the described concern. To determine if the information applies, customers should contact their nearest authorized Mazda dealership. Mazda North American Operations reserves the right to alter the specifications and contents of this bulletin without obligation or advance notice. All rights reserved. No part of this bulletin may be reproduced in any form or by any means, electronic or mechanical--including photocopying and recording and the use of any kind of information storage and retrieval system ---without permission in writing.

Back Up Sub Battery for e-SKYACTIV PHEV

PHEV models have a Sub Battery for backup power to several systems when losing their electric supply from the main battery. The Backup Power Supply Battery (BPS) is located under the passenger-side foot support. Inspection at regularly scheduled maintenance intervals and additional charging is NOT necessary. If the Warning light/DTC (P143B:00) is found based on the voltage down from the BPS, replace the Sub Battery following the procedures in the Workshop Manual.

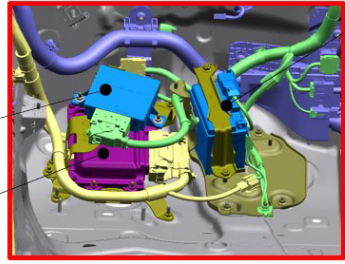

1. PCM
2. BPS Unit
3. Sub Battery

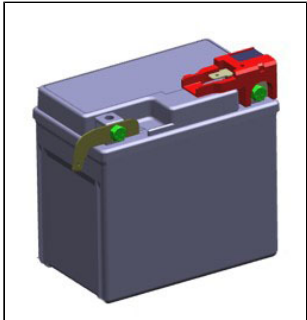

PHEV Refueling Procedure

1. Press the Fuel lid opener switch on the cluster panel

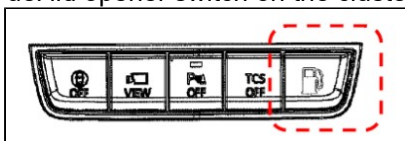

2. "Preparing for refueling" is displayed on the instrument cluster.
3. Wait for instrument cluster to display "Ready to Refuel". This will take 1~10 seconds.
4. Fuel Filler Lid unlocks after "Ready to Refuel" is displayed.

NOTE: If the customer leaves the vehicle with the fuel lid door open for 10-20 min, the on-board fuel tank vapor recovery system will re-seal itself. Then when the customer tries to refuel the vehicle, the pump dispenser may click off due to pressure in the fuel tank.
To reset the system:

1. Install the fuel cap and close the fuel lid.
2. Turn the vehicle on with the START pushbutton and when the READY indicator turns ON, turn the vehicle off.
3. Press the fuel lid opener button and start the process over again.

PHEV Instrument Cluster Battery Range

Battery range shows 1mi even enough Battery State of Charge (SOC) is high.

Under low temperature environment, the engine output characteristics decrease significantly due to the characteristics of Lithium-ion Battery (LiB). Therefore, even though the SOC remains enough, when the motor output is lower than the threshold of battery output (*), the drive mode is switched from EV mode to HEV mode, and the maximum driving distance display shows 1 mile (1 km) as the minimum driving distance.
*: The threshold of battery output is 55 kW.

CONSUMER NOTICE: The information and instructions in this bulletin are intended for use by skilled technicians. Mazda technicians utilize the proper tools/ equipment and take training to correctly and safely maintain Mazda vehicles. These instructions should not be performed by "do-it-yourselfers." Customers should not assume this bulletin applies to their vehicle or that their vehicle will develop the described concern. To determine if the information applies, customers should contact their nearest authorized Mazda dealership. Mazda North American Operations reserves the right to alter the specifications and contents of this bulletin without obligation or advance notice. All rights reserved. No part of this bulletin may be reproduced in any form or by any means, electronic or mechanical--including photocopying and recording and the use of any kind of information storage and retrieval system ---without permission in writing.

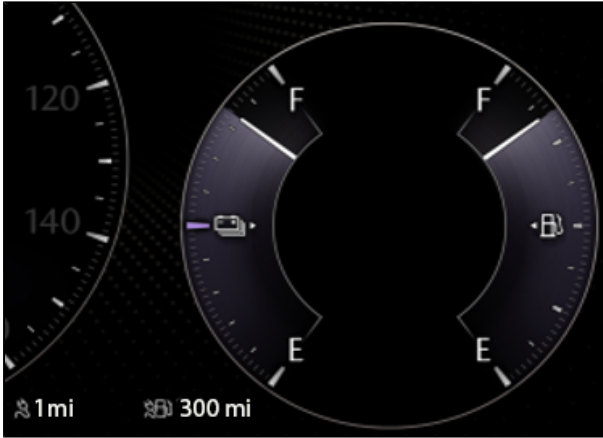

This is caused by low ambient temperature and low battery temperature. This is normal operation.

PHEV interfere with flat lift

The high voltage battery is laid out under the floor, so the undercover is greatly extended downward. Therefore, when trying to use a flat lift, there is a risk of deformation or breakage at the undercover due to interference with the plate of the lift.

Always make sure to use an attachment of 85 mm height when using the lift.

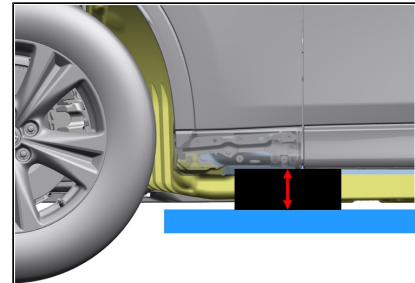

Lift Positions

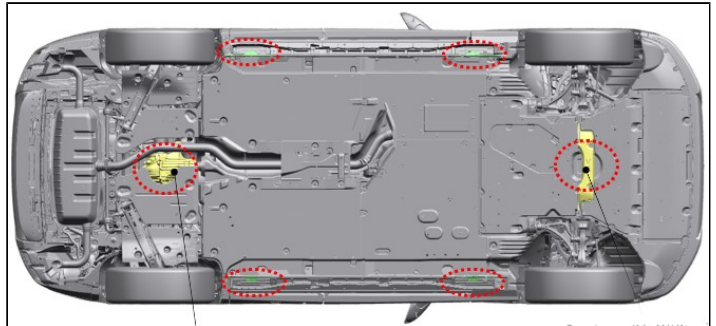

PHEV 355V and M Hybrid Boost Electric Fan Service Caution

The Electric Fan in Engine compartment may operate during Hood Open even at READY OFF based on some system requirements of e-SKYACTIV (PHEV & M Hybrid Boost). Therefore, prior to any services by opening the Hood,

CONSUMER NOTICE: The information and instructions in this bulletin are intended for use by skilled technicians. Mazda technicians utilize the proper tools/ equipment and take training to correctly and safely maintain Mazda vehicles. These instructions should not be performed by "do-it-yourselfers." Customers should not assume this bulletin applies to their vehicle or that their vehicle will develop the described concern. To determine if the information applies, customers should contact their nearest authorized Mazda dealership. Mazda North American Operations reserves the right to alter the specifications and contents of this bulletin without obligation or advance notice. All rights reserved. No part of this bulletin may be reproduced in any form or by any means, electronic or mechanical--including photocopying and recording and the use of any kind of information storage and retrieval system ---without permission in writing.

- Always make sure NOT to Charge (PHEV).
- Always make sure to set TCU (Telematics Communication Unit) into communication restriction mode.
- Always make sure to cancel Climate Control Timer only for PHEV.

to avoid any unexpected Operation of Electric Fan for safety in the service.

Engine Coolant Drain Location

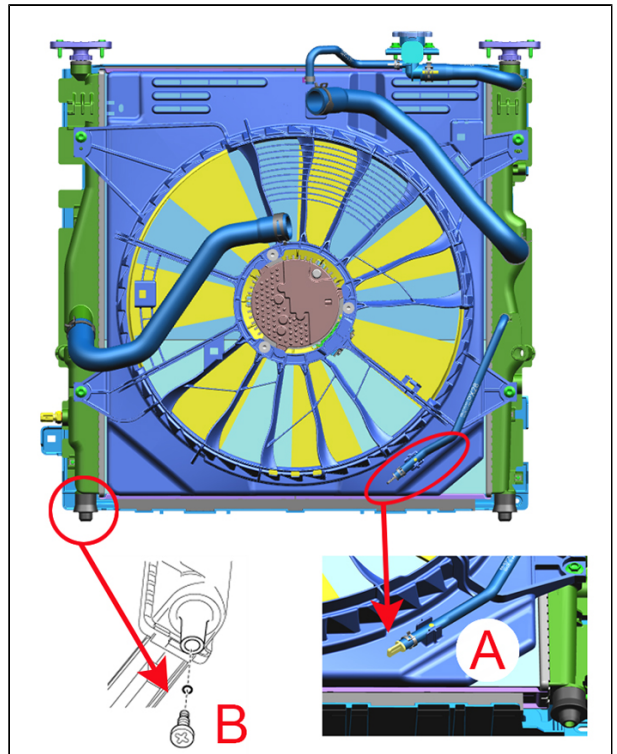

A. Drain Plug for High Temperature (Engine Cooling)
 B. Drain Plug for Low Temperature (EV System Cooling)

PHEV 355V HVAC Compressor Oil

PHEV 355V electric A/C compressor requires Polyolester (POE) oil (part number KRY9-61-K39 -9U) due to the electrical insulation performance. Polyalkyleneglycol (PAG) oil (such as E1Y0-61-K39) cannot be used in an electric A/C compressor.

Always make sure to use only Mazda Genuine POE oil (KRY9-61-K39 -9U) for the electric A/C compressor. Using any POE Oil other than Mazda Genuine POE oil may cause electric leakage, deteriorated A/C performance, or damages to A/C components.

NOTE:

CAUTION: A properly adjusted amount of fluorescent agent (dye) is used during vehicle production.

- **NEVER** add fluorescent agent (dye) into the refrigerant system, otherwise the electrical insulation performance may deteriorate.
- **NEVER** use A/C refrigerant gas containing A/C compressor oil and fluorescent agent (dye).

CONSUMER NOTICE: The information and instructions in this bulletin are intended for use by skilled technicians. Mazda technicians utilize the proper tools/ equipment and take training to correctly and safely maintain Mazda vehicles. These instructions should not be performed by "do-it-yourselfers." Customers should not assume this bulletin applies to their vehicle or that their vehicle will develop the described concern. To determine if the information applies, customers should contact their nearest authorized Mazda dealership. Mazda North American Operations reserves the right to alter the specifications and contents of this bulletin without obligation or advance notice. All rights reserved. No part of this bulletin may be reproduced in any form or by any means, electronic or mechanical---including photocopying and recording and the use of any kind of information storage and retrieval system ---without permission in writing.

- ETA for orderability of POE oil (KRY9-61-K39 -9U) late April 2023.
- A properly adjusted amount of fluorescent agents is used during vehicle production. Never add fluorescent agent into the refrigerant system, otherwise the insulation performance may deteriorate. Never use A/C refrigerant gas containing A/C compressor oil and fluorescent agent, or A/C compressor oil with fluorescent agent.

- **NEVER** use A/C compressor oil with fluorescent agent (dye).

Model	Part Number	Description
PHEV	KRYP-61-K39 9U	POE Oil for Electric Compressor
H3T	0000-77-540E-20	PAG Oil

Engine Oil Level Measurement (Infotainment Center Display)

1. Make sure the hood is closed.
2. Start the engine.
3. Select "Information" on the Home screen to display the vehicle status monitor.
4. Select "Vehicle Status Monitor".



5. Select "Engine Oil Level".

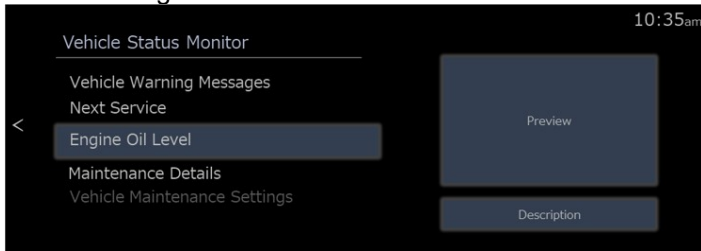

6. Select "Measure Engine Oil Level".



7. Select "Start Measurement"

CONSUMER NOTICE: The information and instructions in this bulletin are intended for use by skilled technicians. Mazda technicians utilize the proper tools/ equipment and take training to correctly and safely maintain Mazda vehicles. These instructions should not be performed by "do-it-yourselfers." Customers should not assume this bulletin applies to their vehicle or that their vehicle will develop the described concern. To determine if the information applies, customers should contact their nearest authorized Mazda dealership. Mazda North American Operations reserves the right to alter the specifications and contents of this bulletin without obligation or advance notice. All rights reserved. No part of this bulletin may be reproduced in any form or by any means, electronic or mechanical---including photocopying and recording and the use of any kind of information storage and retrieval system ---without permission in writing.



Measurement of the engine oil level begins. Do not depress the accelerator pedal during the measurement.

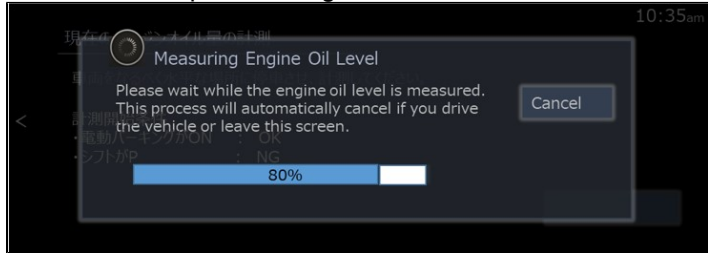

8. Oil Level Result is displayed

- Normal
- Low
- High



CONSUMER NOTICE: The information and instructions in this bulletin are intended for use by skilled technicians. Mazda technicians utilize the proper tools/ equipment and take training to correctly and safely maintain Mazda vehicles. These instructions should not be performed by "do-it-yourselfers." Customers should not assume this bulletin applies to their vehicle or that their vehicle will develop the described concern. To determine if the information applies, customers should contact their nearest authorized Mazda dealership. Mazda North American Operations reserves the right to alter the specifications and contents of this bulletin without obligation or advance notice. All rights reserved. No part of this bulletin may be reproduced in any form or by any means, electronic or mechanical---including photocopying and recording and the use of any kind of information storage and retrieval system ---without permission in writing.

FR-8EAT (PHEV and M Hybrid Boost) Front Engine Rear Drive-8 Electrical Automatic Transmission)

FR-8EAT (No torque Converter) Unit to be installed in this model, which is including a Motor in cases of PHEV & M Hybrid Boost models.

Always make sure to only use ATF-A7, which is marked on the Filler Plug. If the new FR-8EAT or the motor drive unit needs to be replaced, the transmission including the motor drive will need to be replaced as an assembly. The Oil Pan is made from Resin which needs to be cared for to avoid breakage. Never set the transmission on the oil pan or ATF cooler, Damage could occur. Use support blocks as shown in WSM.

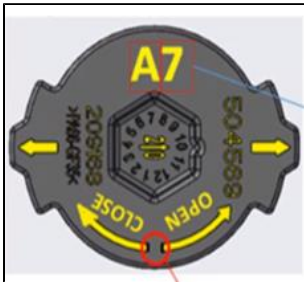

Also, always make sure to use a nozzle tube (about 8mm less than 10mm inner diameter of Overflow tube) and the service mode to fill ATF-A7 into FR-8EAT through the Filler Plug with the correct volume.

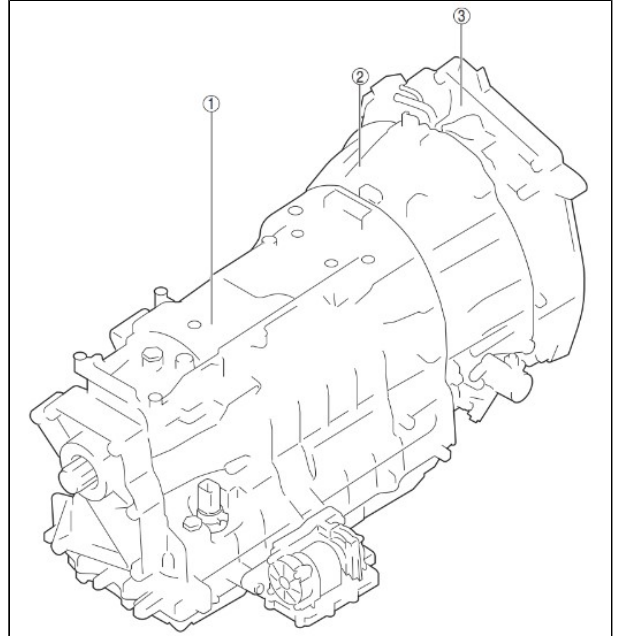
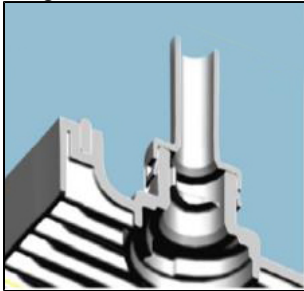

- 1. Transmission Case
- 2. Motor Housing
- 3. Bearing Cover Component

CONSUMER NOTICE: The information and instructions in this bulletin are intended for use by skilled technicians. Mazda technicians utilize the proper tools/ equipment and take training to correctly and safely maintain Mazda vehicles. These instructions should not be performed by "do-it-yourselfers." Customers should not assume this bulletin applies to their vehicle or that their vehicle will develop the described concern. To determine if the information applies, customers should contact their nearest authorized Mazda dealership. Mazda North American Operations reserves the right to alter the specifications and contents of this bulletin without obligation or advance notice. All rights reserved. No part of this bulletin may be reproduced in any form or by any means, electronic or mechanical---including photocopying and recording and the use of any kind of information storage and retrieval system ---without permission in writing.

Transfer Case for All-Wheel Drive

Transfer Case (A) to be installed in the All-Wheel Drive model.
Always make sure to use ATF-A7 (Not to use SG1), which is marked on the case near the Filler Bolt (B), to improve fuel economy.

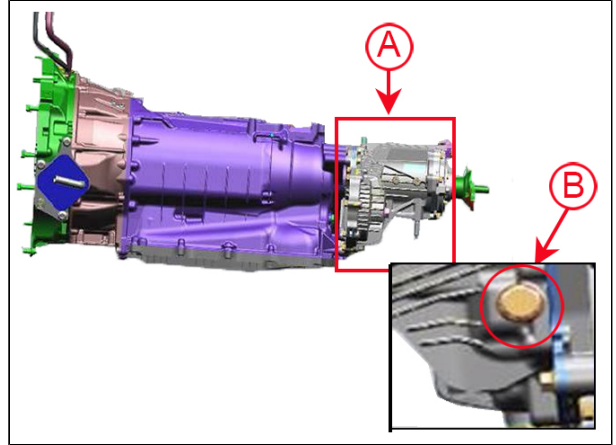

i-stop (M Hybrid Boost Inline 6 cylinder)

i-stop is a function that automatically stops and restarts the engine to improve fuel economy, reduce exhaust emissions, and idling noise.

Stopping the Operation of the i-stop Function
The i-stop function stops and the i-stop OFF switch indicator light turns on.

NOTE When the i-stop function is stopped and the engine is stopped, the i-stop function becomes operational again the next time the engine is started.

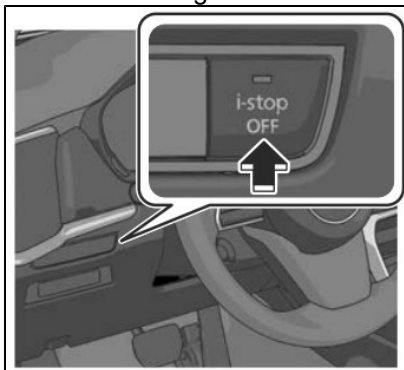

NOTE

- If the engine is stopped with the i-stop function stopped, the i-stop function becomes operational again when the engine is started the next time.
- LN3 Battery for vehicles equipped with i-stop.
- Battery disconnect/reconnect - Perform the battery

Owner's Manual -> Driving -> i-stop

Indicator Light

Green



The i-stop indicator light (green) notifies the driver that the engine is stopped by i-stop control.

Amber Flashing



If the i-stop control inhibits i-stop operation, the i-stop warning light (amber) flashes to inform the driver.

- DTC stored

Amber Solid



If the i-stop control inhibits i-stop operation, the i-stop warning light (amber) turns ON solid to inform the driver.

- Ignition switched ON (check of i-stop control system)
- Engine stalls due to driver's operation while engine is stopped by i-stop control

CONSUMER NOTICE: The information and instructions in this bulletin are intended for use by skilled technicians. Mazda technicians utilize the proper tools/ equipment and take training to correctly and safely maintain Mazda vehicles. These instructions should not be performed by "do-it-yourselfers." Customers should not assume this bulletin applies to their vehicle or that their vehicle will develop the described concern. To determine if the information applies, customers should contact their nearest authorized Mazda dealership. Mazda North American Operations reserves the right to alter the specifications and contents of this bulletin without obligation or advance notice. All rights reserved. No part of this bulletin may be reproduced in any form or by any means, electronic or mechanical--including photocopying and recording and the use of any kind of information storage and retrieval system ---without permission in writing.

condition initial setting (i-stop setting). Go to MGSS **BATTERY CONDITION INITIALIZATION SETTING (i-stop SETTING)**

- Communication error to PCM and instrument cluster

12V Battery Charging / Testing

MGSS -> **01-007/23**

i-ACTIVSENSE

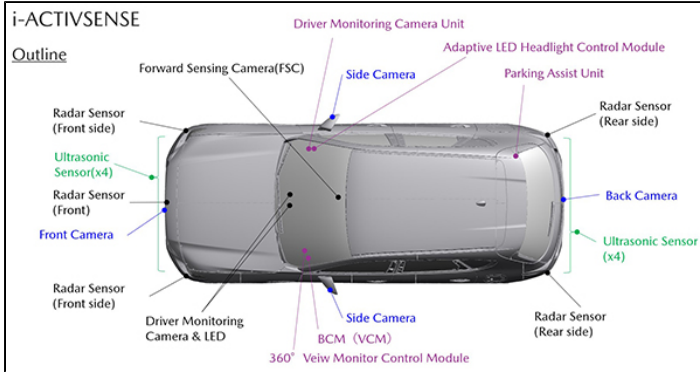

Owner's Manual -> Driving -> **i-ACTIVSENSE**

i-ACTIVSENSE Indicators

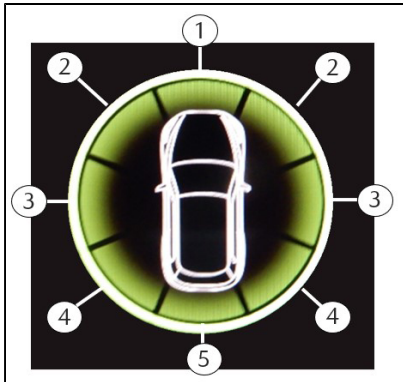

1. Forward Sensing System Operation State

- Distance & Speed Alert (DSA)
- Smart Brake Support (SBS) [forward sensing function]
- Smart Brake Support (SBS) [collision avoiding assist system during turning]

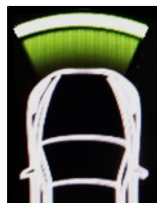

2. Forward Side Sensing System Operation State

Owner's Manual -> Driving -> **i-ACTIVSENSE Status Symbol**

CONSUMER NOTICE: The information and instructions in this bulletin are intended for use by skilled technicians. Mazda technicians utilize the proper tools/ equipment and take training to correctly and safely maintain Mazda vehicles. These instructions should not be performed by "do-it-yourselfers." Customers should not assume this bulletin applies to their vehicle or that their vehicle will develop the described concern. To determine if the information applies, customers should contact their nearest authorized Mazda dealership. Mazda North American Operations reserves the right to alter the specifications and contents of this bulletin without obligation or advance notice. All rights reserved. No part of this bulletin may be reproduced in any form or by any means, electronic or mechanical--including photocopying and recording and the use of any kind of information storage and retrieval system ---without permission in writing.

- Front Cross Traffic Alert (FCTA) (if equipped)



3. Lateral Side Sensing System Operation State

- Lane Departure Warning System (LDWS)
- Lane-Keep Assist System (LAS)
- Emergency Lane Keeping [road keep assist] (ELK)



4. Rear Side Sensing System Operation State

- Blind Spot Monitoring (BSM)
- Rear Cross Traffic Alert (RCTA) System
- Smart Brake Support [Rear Crossing] (SBS-RC)
- Emergency Lane Keeping [blind spot assist]



5. Rear Sensing System Operation State

- Smart Brake Support (SBS) [rear side sensing function] (if equipped)



Smart Brake Support (SBS)

Owner's Manual -> Driving -> [Smart Brake Support \(SBS\)](#)

Page 19 of 54

CONSUMER NOTICE: The information and instructions in this bulletin are intended for use by skilled technicians. Mazda technicians utilize the proper tools/ equipment and take training to correctly and safely maintain Mazda vehicles. These instructions should not be performed by "do-it-yourselfers." Customers should not assume this bulletin applies to their vehicle or that their vehicle will develop the described concern. To determine if the information applies, customers should contact their nearest authorized Mazda dealership. Mazda North American Operations reserves the right to alter the specifications and contents of this bulletin without obligation or advance notice. All rights reserved. No part of this bulletin may be reproduced in any form or by any means, electronic or mechanical---including photocopying and recording and the use of any kind of information storage and retrieval system ---without permission in writing.

SBS is a system designed to avoid collisions and reduce damage in the event of a collision by controlling the brakes. Sensors and camera equipped on the vehicle detect objects, and operate brake control if there is a possibility of your vehicle colliding with the object.

One part of the SBS functions when you are driving forward and the other part functions when you are driving in reverse.

Forward drive detection

Forward drive detection has the following 4 functions.

1. Forward detection function*

The forward detection function is designed to assist the driver in avoiding collisions with objects (vehicles ahead, pedestrians, bicycles, and motorcycles) at the front and to reduce damage in the event of a collision.

If there is a possibility of your vehicle colliding with a target object at the front, you are notified of possible danger by a screen display and a warning sound. Furthermore, if the possibility of a collision increases,

brake control is performed to avoid collision and reduce damage in the event of a collision.

In addition, when the driver depresses the brake pedal, the brakes are applied firmly and quickly to assist.

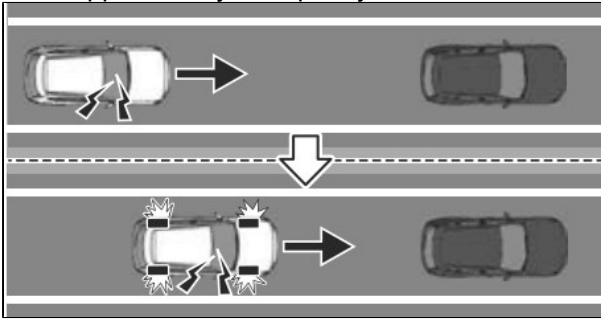

2. Turn-Across Traffic*

The Turn-Across Traffic is designed to assist the driver in avoiding a collision with a vehicle approaching in the opposite direction when making a left turn at an intersection and to reduce damage in the event of a collision.

If there is a possibility of your vehicle colliding with a vehicle approaching in the opposite direction when you make a left turn at an intersection, you are notified of possible danger by a screen display and a warning sound.

Furthermore, if the possibility of a collision increases, brake control is performed to avoid collision and reduce damage in the event of a collision.

CONSUMER NOTICE: The information and instructions in this bulletin are intended for use by skilled technicians. Mazda technicians utilize the proper tools/ equipment and take training to correctly and safely maintain Mazda vehicles. These instructions should not be performed by "do-it-yourselfers." Customers should not assume this bulletin applies to their vehicle or that their vehicle will develop the described concern. To determine if the information applies, customers should contact their nearest authorized Mazda dealership. Mazda North American Operations reserves the right to alter the specifications and contents of this bulletin without obligation or advance notice. All rights reserved. No part of this bulletin may be reproduced in any form or by any means, electronic or mechanical--including photocopying and recording and the use of any kind of information storage and retrieval system ---without permission in writing.

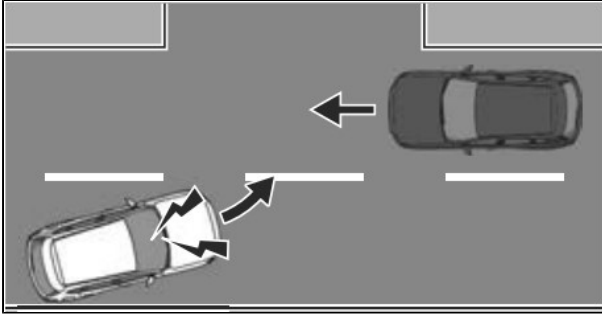

3. Front Crossing*

Front Crossing is designed to assist the driver in avoiding a collision at an intersection and reduce damage.

If there is a possibility of a collision with a vehicle at an intersection, brake control is performed to avoid a collision or to reduce damage in the event of a collision.

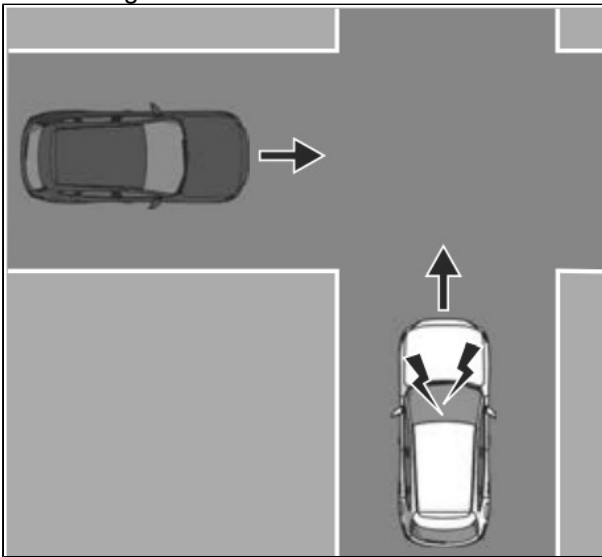

4. Intersection accident avoidance assist function*

Intersection accident avoidance assist function is designed to avoid collisions with objects (pedestrians and bicycles) when making a left or right turn at an intersection and to reduce damage in the event of a collision.

If there is a possibility of your vehicle colliding with a target object when you make a left or right turn at an intersection, you are notified of possible danger by a screen display and a warning sound. Furthermore, if the possibility of a collision increases, brake control is performed to avoid collision and reduce damage in the event of a collision.

CONSUMER NOTICE: The information and instructions in this bulletin are intended for use by skilled technicians. Mazda technicians utilize the proper tools/ equipment and take training to correctly and safely maintain Mazda vehicles. These instructions should not be performed by "do-it-yourselfers." Customers should not assume this bulletin applies to their vehicle or that their vehicle will develop the described concern. To determine if the information applies, customers should contact their nearest authorized Mazda dealership. Mazda North American Operations reserves the right to alter the specifications and contents of this bulletin without obligation or advance notice. All rights reserved. No part of this bulletin may be reproduced in any form or by any means, electronic or mechanical---including photocopying and recording and the use of any kind of information storage and retrieval system ---without permission in writing.

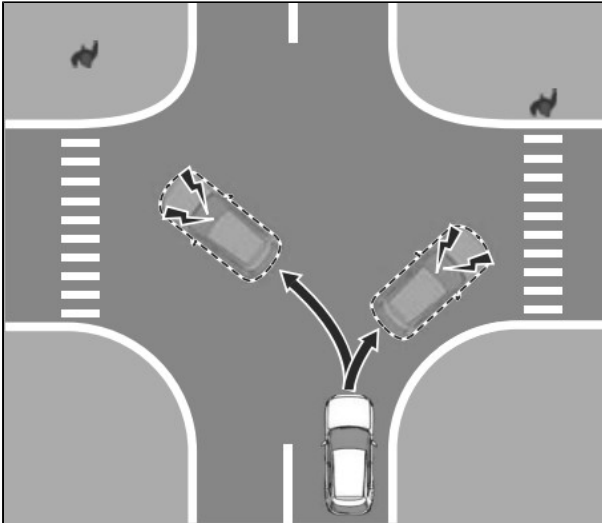

Reverse drive detection

Reverse drive detection has the following 2 functions.

1. Rearward detection function*

The rearward detection function is designed to assist the driver in avoiding collisions with objects at the rear (obstructions and pedestrians*) and to reduce damage in the event of a collision.

If there is a possibility of your vehicle colliding with a target object at the rear, you are notified of possible danger by a screen display and a warning sound. Furthermore, if the possibility of a collision increases, brake control is performed to avoid collision and reduce damage in the event of a collision.

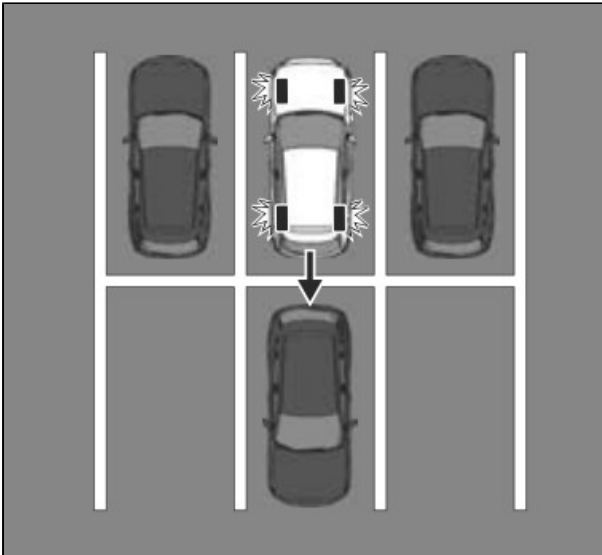

2. Rear Crossing*

CONSUMER NOTICE: The information and instructions in this bulletin are intended for use by skilled technicians. Mazda technicians utilize the proper tools/ equipment and take training to correctly and safely maintain Mazda vehicles. These instructions should not be performed by "do-it-yourselfers." Customers should not assume this bulletin applies to their vehicle or that their vehicle will develop the described concern. To determine if the information applies, customers should contact their nearest authorized Mazda dealership. Mazda North American Operations reserves the right to alter the specifications and contents of this bulletin without obligation or advance notice. All rights reserved. No part of this bulletin may be reproduced in any form or by any means, electronic or mechanical---including photocopying and recording and the use of any kind of information storage and retrieval system ---without permission in writing.

The Rear Crossing is designed to avoid collision and reduce damage in the event of a collision with a vehicle approaching from the rear sides.

If there is a possibility of your vehicle colliding with a vehicle approaching from the rear sides, you are notified of possible danger by a screen display and a warning sound.

Furthermore, if the possibility of a collision increases, brake control is performed to avoid collision and reduce damage in the event of a collision.

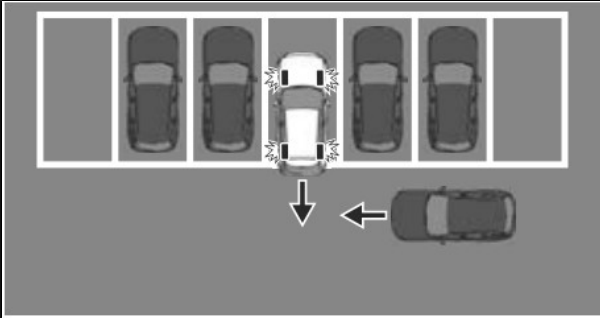

Secondary Collision Reduction*

The Secondary Collision Reduction reduces secondary damage by decelerating the vehicle when it is damaged in a collision to the extent that the airbags are deployed while driving.

If a collision occurs to the extent that the airbags are deployed while driving, the hazard warning lights flash to alert surrounding vehicles and the brakes are controlled to reduce damage in the event of a collision with an obstruction or other object.

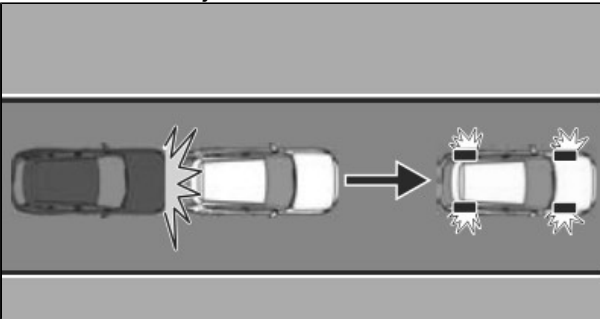

Owner's Manual -> Driving -> [Secondary Collision Reduction](#)

Mazda Radar Cruise Control with Stop & Go Function System (MRCC)

MRCC is a system that reduces load on the driver through constant speed and headway control. The function performs headway control to maintain the distance with a vehicle ahead at a constant preset speed without you having to depress the accelerator or brake pedal.

Owner's Manual -> Driving -> [Mazda Radar Cruise Control \(MRCC\)](#)

CONSUMER NOTICE: The information and instructions in this bulletin are intended for use by skilled technicians. Mazda technicians utilize the proper tools/ equipment and take training to correctly and safely maintain Mazda vehicles. These instructions should not be performed by "do-it-yourselfers." Customers should not assume this bulletin applies to their vehicle or that their vehicle will develop the described concern. To determine if the information applies, customers should contact their nearest authorized Mazda dealership. Mazda North American Operations reserves the right to alter the specifications and contents of this bulletin without obligation or advance notice. All rights reserved. No part of this bulletin may be reproduced in any form or by any means, electronic or mechanical--including photocopying and recording and the use of any kind of information storage and retrieval system ---without permission in writing.

Speed Limit Assist

It is possible to set the vehicle speed of the speed sign recognized by the FSC and map information to the MRCC with one touch (RES button).

Note: Navigation SD Card is required

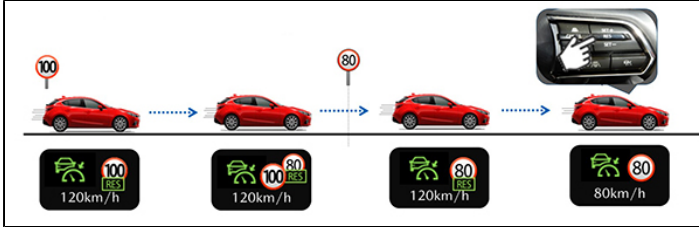

User Customization

- Manual (On)
- Off
- 0 mph (same as speed limit sign)
- 3 mph offset
- 5 mph offset
- 10 mph offset

Cruising & Traffic Support (CTS)

The CTS is a system that reduces the load on the driver while the vehicle is driven on expressways or highways. The CTS has the following 2 functions.

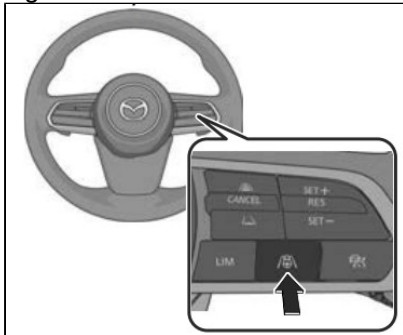

Constant speed/Headway control function

The function performs headway control to maintain the distance with a vehicle ahead at a constant preset speed without you having to depress the accelerator or brake pedal.

Steering wheel assist function

When vehicle lane lines are detected, the function assists your steering wheel operation to follow the vehicle lane lines. When vehicle lane lines are not detected, the function assists your steering wheel operation to follow the trajectory of the vehicle ahead.

Owner's Manual -> Driving -> [Cruising & Traffic Support \(CTS\)](#)

Cruising & Traffic Support - Risk Mitigation Function (CTS-RMF) (CX-70 only)

MGSS -> [CRUISING & TRAFFIC SUPPORT \(CTS\)](#)

CONSUMER NOTICE: The information and instructions in this bulletin are intended for use by skilled technicians. Mazda technicians utilize the proper tools/ equipment and take training to correctly and safely maintain Mazda vehicles. These instructions should not be performed by "do-it-yourselfers." Customers should not assume this bulletin applies to their vehicle or that their vehicle will develop the described concern. To determine if the information applies, customers should contact their nearest authorized Mazda dealership. Mazda North American Operations reserves the right to alter the specifications and contents of this bulletin without obligation or advance notice. All rights reserved. No part of this bulletin may be reproduced in any form or by any means, electronic or mechanical--including photocopying and recording and the use of any kind of information storage and retrieval system ---without permission in writing.

The risk mitigation function is a function that decelerates the vehicle if the driver is not driving the vehicle under the appropriate conditions. If the driver is not driving the vehicle under the appropriate conditions, a screen display and a warning sound urge the driver to drive appropriately. Furthermore, if this situation continues for a certain period of time, the vehicle is decelerated.
 Press the CTS switch to turn the system on.

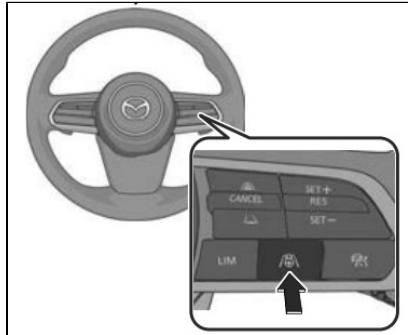

Driver Behavior to determine “the risk is imminent”

- Inattention
 - Eyes Closed
 - Looking aside
- Improper Driving
 - Hands off

Operation: System determines risk and responds with:

- Multiple warning messages
- Delecerates to a stop
- Keeps vehicle parked by applying EPB

Driver input such as steering wheel operation will cancel CTS-RMF

Owner's Manual -> Driving -> Cruising & Traffic Support (CTS) -> Risk mitigation function

Distance & Speed Alert (DSA)

The DSA is a system in which the screen display notifies the driver that the distance between your vehicle and a vehicle ahead is close.

Owner's Manual -> Driving -> [Distance & Speed Alert \(DSA\)](#)

CONSUMER NOTICE: The information and instructions in this bulletin are intended for use by skilled technicians. Mazda technicians utilize the proper tools/ equipment and take training to correctly and safely maintain Mazda vehicles. These instructions should not be performed by "do-it-yourselfers." Customers should not assume this bulletin applies to their vehicle or that their vehicle will develop the described concern. To determine if the information applies, customers should contact their nearest authorized Mazda dealership. Mazda North American Operations reserves the right to alter the specifications and contents of this bulletin without obligation or advance notice. All rights reserved. No part of this bulletin may be reproduced in any form or by any means, electronic or mechanical--including photocopying and recording and the use of any kind of information storage and retrieval system ---without permission in writing.

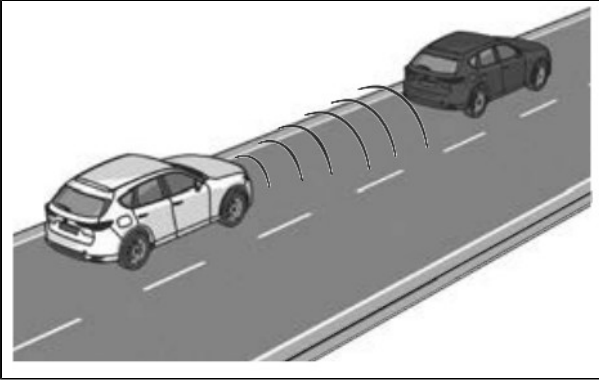

Lane-Keep Assist System*

The LAS is a system to help the driver stay within the vehicle lane if the vehicle might be deviating. If your vehicle may be deviating from the vehicle lane, the LAS provides steering assistance to avoid departure from the lane.

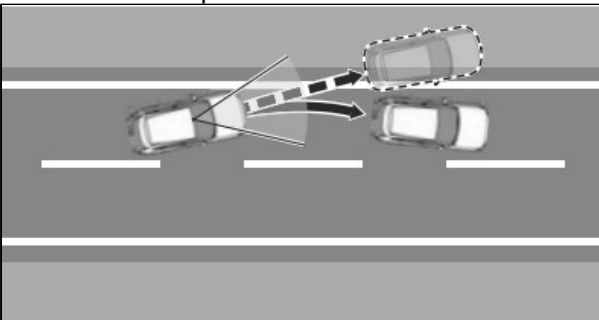

Owner's Manual -> Driving -> [Lane-keep Assist System \(LAS\)](#)

Lane Departure Warning System (LDWS)

The LDWS notifies the driver that the vehicle might be deviating from its lane. If there is a possibility of your vehicle deviating from the vehicle lane, a screen display and a warning sound notify the driver of the danger.

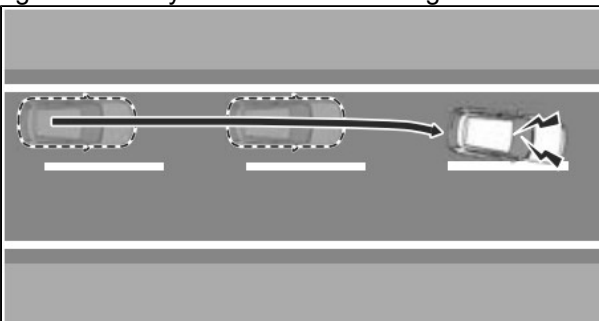

Owner's Manual -> Driving -> [Lane Departure Warning System \(LDWS\)](#)

Emergency Lane Keeping (ELK)*

The ELK is a system designed to assist the driver's steering wheel operation to avoid danger. The ELK has the following

Owner's Manual -> Driving -> [Emergency Lane Keeping \(ELK\)](#)

CONSUMER NOTICE: The information and instructions in this bulletin are intended for use by skilled technicians. Mazda technicians utilize the proper tools/ equipment and take training to correctly and safely maintain Mazda vehicles. These instructions should not be performed by "do-it-yourselfers." Customers should not assume this bulletin applies to their vehicle or that their vehicle will develop the described concern. To determine if the information applies, customers should contact their nearest authorized Mazda dealership. Mazda North American Operations reserves the right to alter the specifications and contents of this bulletin without obligation or advance notice. All rights reserved. No part of this bulletin may be reproduced in any form or by any means, electronic or mechanical--including photocopying and recording and the use of any kind of information storage and retrieval system ---without permission in writing.

3 functions.

Road Keep Assist

The Road Keep Assist assists the driver to avoid departure from the road.

If your vehicle may be deviating from the road, the Road Keep Assist provides steering assistance to avoid departure from the road. In addition, a screen display and a warning sound notify the driver of the danger.

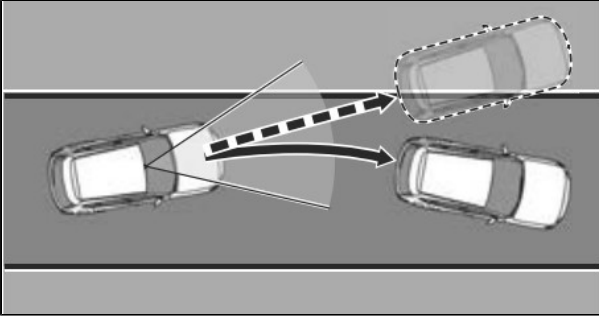

Blind Spot Assist*

The Blind Spot Assist assists the driver in avoiding collisions with vehicles in adjacent lanes (excluding vehicles approaching in the opposite direction).

If there is a possibility of a collision with a vehicle in an adjacent lane when you try to change lanes or if you may deviate from your lane, the Blind Spot Assist assists your steering wheel operation to keep you in the driving lane. In addition, a screen display and a warning sound notify the driver of the danger.

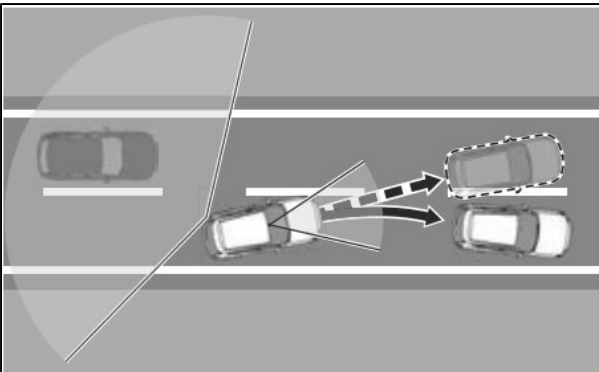

Head-on traffic avoidance assist*

The Head-on traffic avoidance assist assists you in avoiding a collision with a vehicle approaching in the oncoming lane and your vehicle.

If there is a possibility of a collision with a vehicle approaching in the oncoming lane due to your vehicle departing from its lane, the

CONSUMER NOTICE: The information and instructions in this bulletin are intended for use by skilled technicians. Mazda technicians utilize the proper tools/ equipment and take training to correctly and safely maintain Mazda vehicles. These instructions should not be performed by "do-it-yourselfers." Customers should not assume this bulletin applies to their vehicle or that their vehicle will develop the described concern. To determine if the information applies, customers should contact their nearest authorized Mazda dealership. Mazda North American Operations reserves the right to alter the specifications and contents of this bulletin without obligation or advance notice. All rights reserved. No part of this bulletin may be reproduced in any form or by any means, electronic or mechanical--including photocopying and recording and the use of any kind of information storage and retrieval system ---without permission in writing.

Head-on traffic avoidance assist assists your steering wheel operation to keep you in the original driving lane. In addition, a screen display and a warning sound notify the driver of the danger.

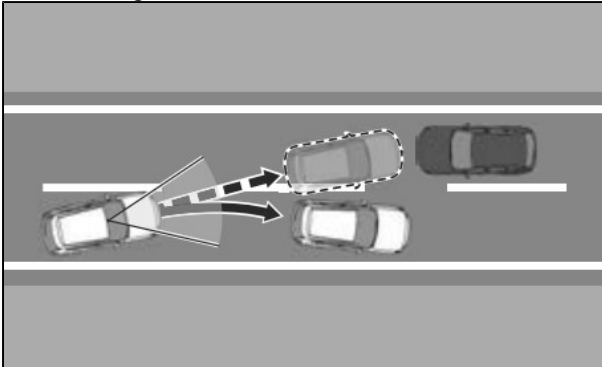

High Beam Control System (HBC)*

The HBC determines the conditions in front of the vehicle while driving at night to automatically switch the headlights between high and low beams.

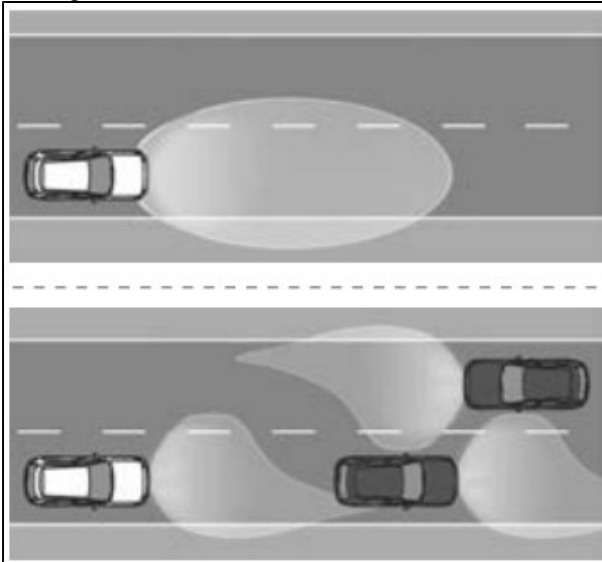

Owner's Manual -> Driving -> [High Beam Control System \(HBC\)](#)

Blind Spot Monitoring (BSM) System

The BSM is a system that assists the driver in checking for vehicles at your rear when making a lane change. When a vehicle approaching from the rear is detected, various screen displays and warning sounds notify the driver of the danger.

Owner's Manual -> Driving -> [Blind Spot Monitoring \(BSM\)](#)

CONSUMER NOTICE: The information and instructions in this bulletin are intended for use by skilled technicians. Mazda technicians utilize the proper tools/ equipment and take training to correctly and safely maintain Mazda vehicles. These instructions should not be performed by "do-it-yourselfers." Customers should not assume this bulletin applies to their vehicle or that their vehicle will develop the described concern. To determine if the information applies, customers should contact their nearest authorized Mazda dealership. Mazda North American Operations reserves the right to alter the specifications and contents of this bulletin without obligation or advance notice. All rights reserved. No part of this bulletin may be reproduced in any form or by any means, electronic or mechanical--including photocopying and recording and the use of any kind of information storage and retrieval system ---without permission in writing.

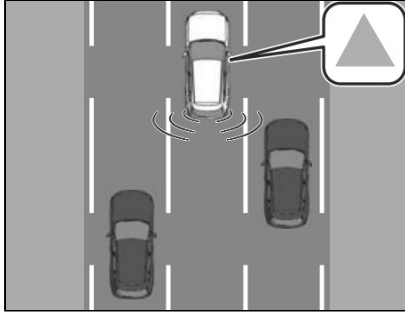

Vehicle Exit Warning

The vehicle exit warning is a system that assists the driver in checking the rear of the vehicle when exiting the vehicle. When a vehicle or bicycle approaching from the rear is detected, various screen displays and warning sounds notify the driver of the danger.

Detectable Scenes

1. Bicycle approaches from the rear side

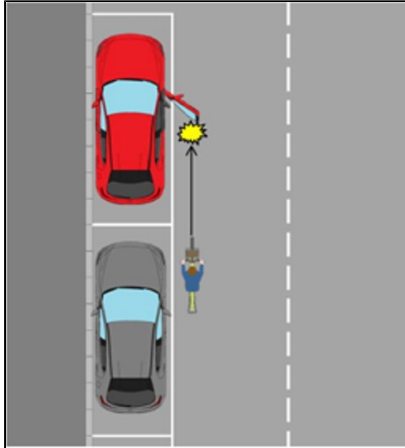

2. Pedestrians pass by the side

CONSUMER NOTICE: The information and instructions in this bulletin are intended for use by skilled technicians. Mazda technicians utilize the proper tools/ equipment and take training to correctly and safely maintain Mazda vehicles. These instructions should not be performed by "do-it-yourselfers." Customers should not assume this bulletin applies to their vehicle or that their vehicle will develop the described concern. To determine if the information applies, customers should contact their nearest authorized Mazda dealership. Mazda North American Operations reserves the right to alter the specifications and contents of this bulletin without obligation or advance notice. All rights reserved. No part of this bulletin may be reproduced in any form or by any means, electronic or mechanical---including photocopying and recording and the use of any kind of information storage and retrieval system ---without permission in writing.

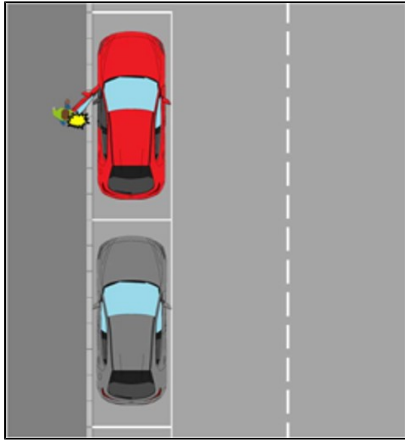

3. Other scenes

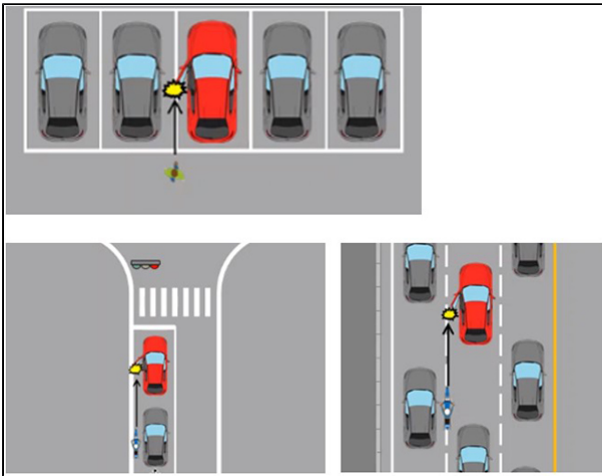

Front Cross Traffic Alert (FCTA) System

The FCTA assists the driver in checking both sides of the vehicle when the vehicle starts to drive at an intersection. When a vehicle approaching from the blind spots on the front left or right side is detected, a screen display and warning sound notify the driver of the danger.

Owner's Manual -> Driving -> [Front Cross Traffic Alert \(FCTA\)](#)

CONSUMER NOTICE: The information and instructions in this bulletin are intended for use by skilled technicians. Mazda technicians utilize the proper tools/ equipment and take training to correctly and safely maintain Mazda vehicles. These instructions should not be performed by "do-it-yourselfers." Customers should not assume this bulletin applies to their vehicle or that their vehicle will develop the described concern. To determine if the information applies, customers should contact their nearest authorized Mazda dealership. Mazda North American Operations reserves the right to alter the specifications and contents of this bulletin without obligation or advance notice. All rights reserved. No part of this bulletin may be reproduced in any form or by any means, electronic or mechanical---including photocopying and recording and the use of any kind of information storage and retrieval system ---without permission in writing.

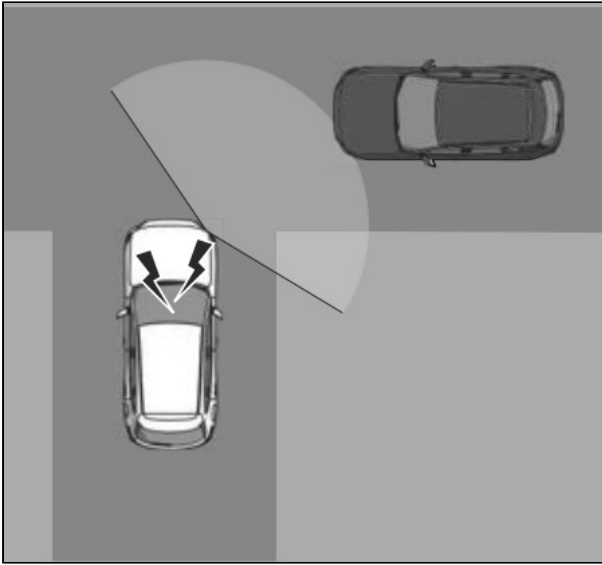

Rear Cross Traffic Alert (RCTA) System

The RCTA assists the driver in checking the area to the rear of the vehicle, such as while reversing out of a parking space. When a vehicle approaching from the rear on the left or right is detected, various screen displays and warning sounds notify the driver of the danger.

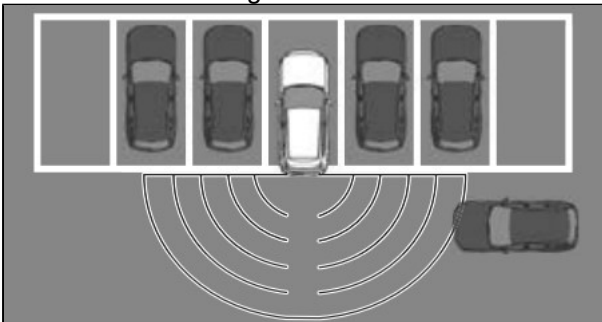

When the RCTA operates, the driver is notified of the danger by flashing of the BSM warning lights, a warning indication, and a warning sound.

Owner's Manual -> Driving -> [Rear Cross Traffic Alert \(RCTA\)](#)

CONSUMER NOTICE: The information and instructions in this bulletin are intended for use by skilled technicians. Mazda technicians utilize the proper tools/ equipment and take training to correctly and safely maintain Mazda vehicles. These instructions should not be performed by "do-it-yourselfers." Customers should not assume this bulletin applies to their vehicle or that their vehicle will develop the described concern. To determine if the information applies, customers should contact their nearest authorized Mazda dealership. Mazda North American Operations reserves the right to alter the specifications and contents of this bulletin without obligation or advance notice. All rights reserved. No part of this bulletin may be reproduced in any form or by any means, electronic or mechanical---including photocopying and recording and the use of any kind of information storage and retrieval system ---without permission in writing.

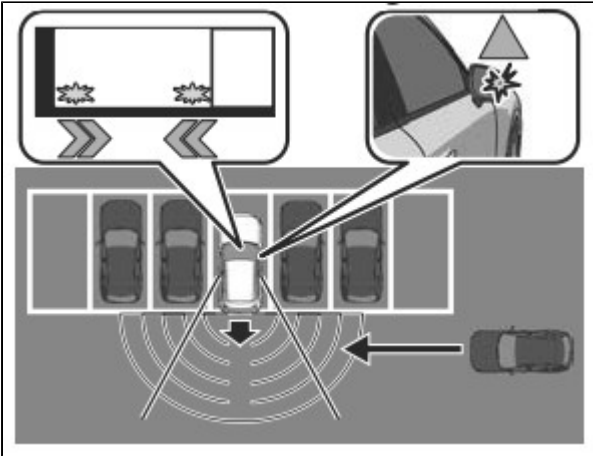

Driver Attention Alert (DAA) System

The DAA is a system that detects the driver fatigue and decreased attentiveness based on various types of vehicle information, and encourages the driver to take a rest using a screen display and warning sound.

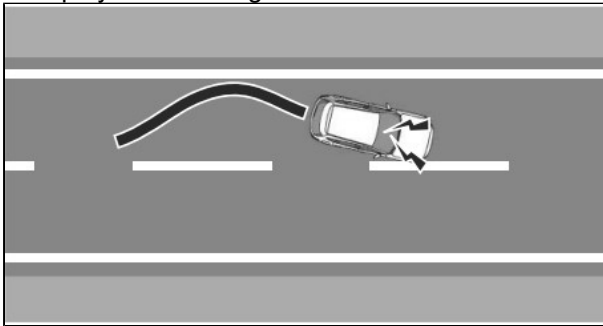

Owner's Manual -> Driving -> [Driver Attention Alert \(DAA\)](#)

Driver Monitoring (DM)*

The DM is a system that detects dangerous conditions and behavior of the driver and notifies the driver of possible danger. The DM has two detection functions.

Drowsiness detection function

The drowsiness detection function detects the level of driver drowsiness.

When the driver drowsiness is detected, the screen display and warning sound encourage the driver to take a rest. There are 2 levels of screen display and warning sound.

- Warning pattern (caution)

Owner's Manual -> Driving -> [Driver Monitoring \(DM\)](#)

CONSUMER NOTICE: The information and instructions in this bulletin are intended for use by skilled technicians. Mazda technicians utilize the proper tools/ equipment and take training to correctly and safely maintain Mazda vehicles. These instructions should not be performed by "do-it-yourselfers." Customers should not assume this bulletin applies to their vehicle or that their vehicle will develop the described concern. To determine if the information applies, customers should contact their nearest authorized Mazda dealership. Mazda North American Operations reserves the right to alter the specifications and contents of this bulletin without obligation or advance notice. All rights reserved. No part of this bulletin may be reproduced in any form or by any means, electronic or mechanical--including photocopying and recording and the use of any kind of information storage and retrieval system ---without permission in writing.

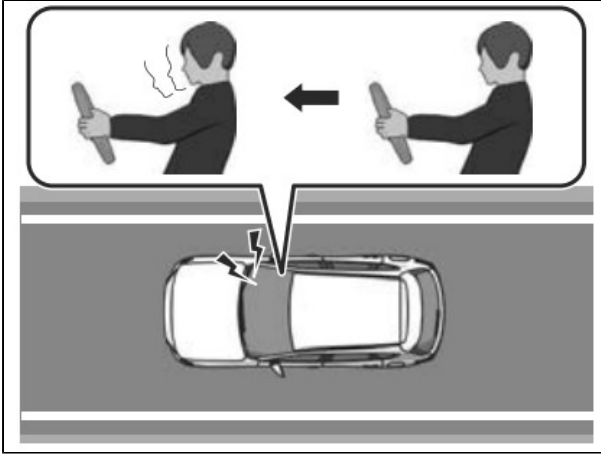

- Warning pattern (warning)

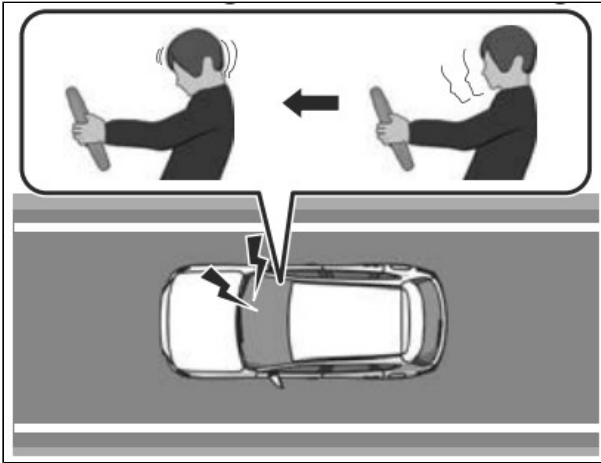

Inattentive driving detection function

The inattentive driving detection function detects that the driver is not paying attention to the road. When the system detects that the driver is not paying attention to the road, it alerts the driver with a screen display and a warning sound.

CONSUMER NOTICE: The information and instructions in this bulletin are intended for use by skilled technicians. Mazda technicians utilize the proper tools/ equipment and take training to correctly and safely maintain Mazda vehicles. These instructions should not be performed by "do-it-yourselfers." Customers should not assume this bulletin applies to their vehicle or that their vehicle will develop the described concern. To determine if the information applies, customers should contact their nearest authorized Mazda dealership. Mazda North American Operations reserves the right to alter the specifications and contents of this bulletin without obligation or advance notice. All rights reserved. No part of this bulletin may be reproduced in any form or by any means, electronic or mechanical---including photocopying and recording and the use of any kind of information storage and retrieval system ---without permission in writing.

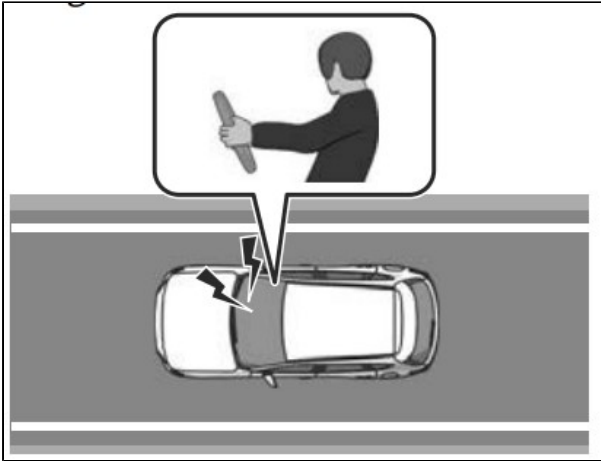

Private e-call (CX-70 - Canada spec Only)

If the vehicle is involved in a collision that deploys the airbags or when the SOS button is pressed, an emergency vehicle can be arranged through Private eCall center.

To operate Private eCall, a contract with Connected Service is required.

Automatic 911 Dialing vs Private e-call:

Automatic 911 Dialing (Smart Phone)

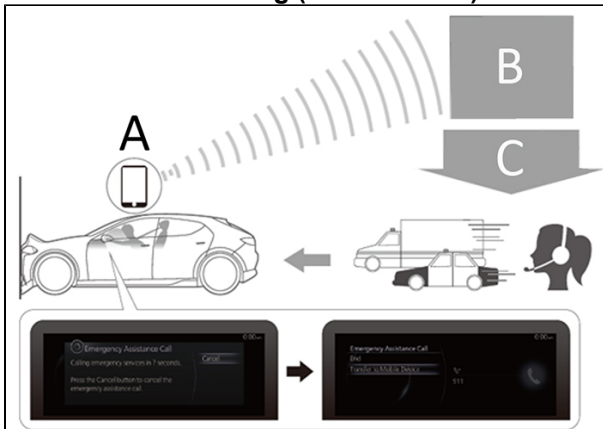

- A. Smart phone
- B. 911 Emergency Services
- C. Take appropriate measures according to circumstances

Private e-call (TCU)

Owner's Manual -> Other Equipment -> Private eCall

CONSUMER NOTICE: The information and instructions in this bulletin are intended for use by skilled technicians. Mazda technicians utilize the proper tools/ equipment and take training to correctly and safely maintain Mazda vehicles. These instructions should not be performed by "do-it-yourselfers." Customers should not assume this bulletin applies to their vehicle or that their vehicle will develop the described concern. To determine if the information applies, customers should contact their nearest authorized Mazda dealership. Mazda North American Operations reserves the right to alter the specifications and contents of this bulletin without obligation or advance notice. All rights reserved. No part of this bulletin may be reproduced in any form or by any means, electronic or mechanical--including photocopying and recording and the use of any kind of information storage and retrieval system ---without permission in writing.

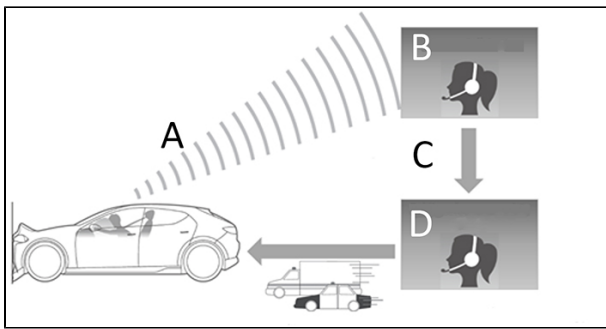

- A. TCU
- B. Private eCall Center
- C. Arrange emergency service
- D. Public Safety Answering Point

SOS button

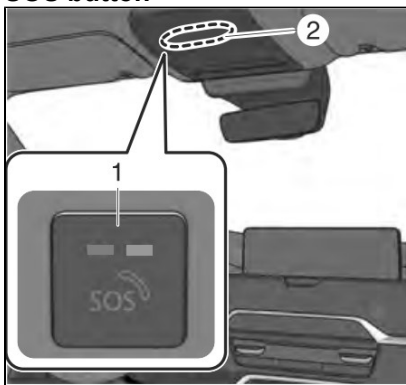

- 1. Emergency call switch
- 2. Microphone, Speaker

Traffic Sign Recognition System (TSR)*

The TSR is a system to notify the driver of traffic signs by displaying traffic signs on the screen which are recognized by the vehicle while driving.

Owner's Manual -> Driving -> [Traffic Sign Recognition System \(TSR\)](#)

360° View Monitor System

The 360° view monitor is a system which assists the driver in checking safety by displaying the conditions around the vehicle on the center display when the vehicle is driven at low speeds or when the vehicle is parked or stopped.

Owner's Manual -> Driving -> [360° View Monitor](#)

Display Button

CONSUMER NOTICE: The information and instructions in this bulletin are intended for use by skilled technicians. Mazda technicians utilize the proper tools/ equipment and take training to correctly and safely maintain Mazda vehicles. These instructions should not be performed by "do-it-yourselfers." Customers should not assume this bulletin applies to their vehicle or that their vehicle will develop the described concern. To determine if the information applies, customers should contact their nearest authorized Mazda dealership. Mazda North American Operations reserves the right to alter the specifications and contents of this bulletin without obligation or advance notice. All rights reserved. No part of this bulletin may be reproduced in any form or by any means, electronic or mechanical--including photocopying and recording and the use of any kind of information storage and retrieval system ---without permission in writing.

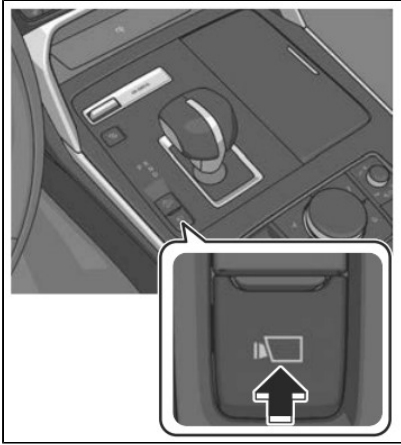

Top View

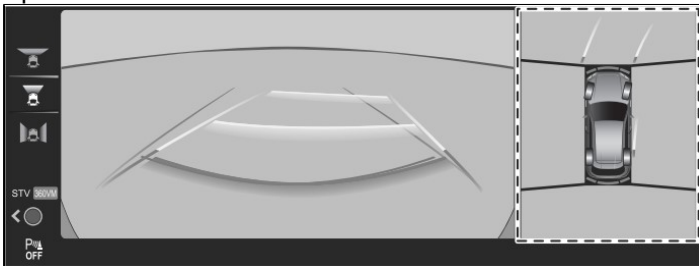

Front View

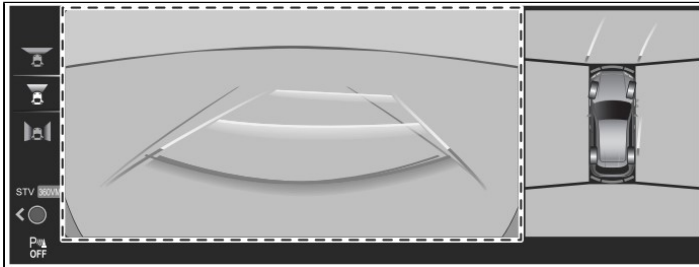

Front Wide View

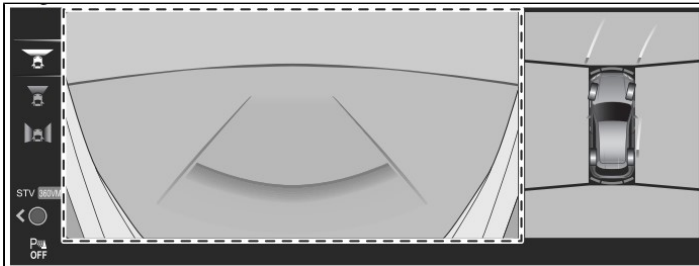

Side View

CONSUMER NOTICE: The information and instructions in this bulletin are intended for use by skilled technicians. Mazda technicians utilize the proper tools/ equipment and take training to correctly and safely maintain Mazda vehicles. These instructions should not be performed by "do-it-yourselfers." Customers should not assume this bulletin applies to their vehicle or that their vehicle will develop the described concern. To determine if the information applies, customers should contact their nearest authorized Mazda dealership. Mazda North American Operations reserves the right to alter the specifications and contents of this bulletin without obligation or advance notice. All rights reserved. No part of this bulletin may be reproduced in any form or by any means, electronic or mechanical---including photocopying and recording and the use of any kind of information storage and retrieval system ---without permission in writing.

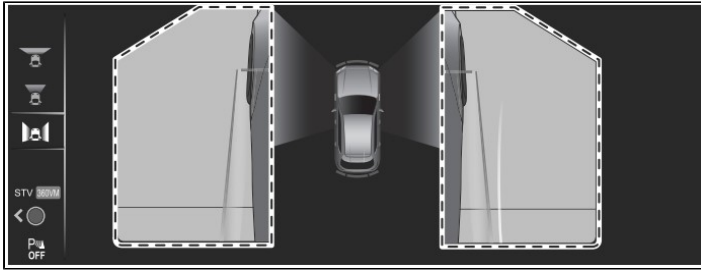

Rear View

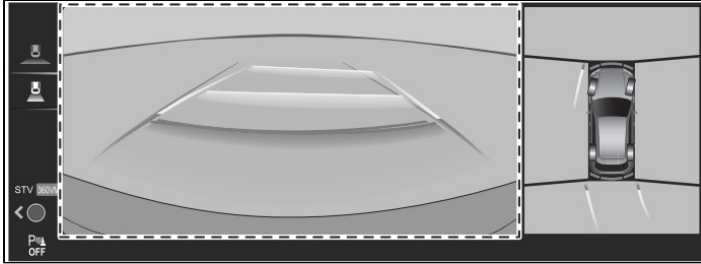

Rear Wide View

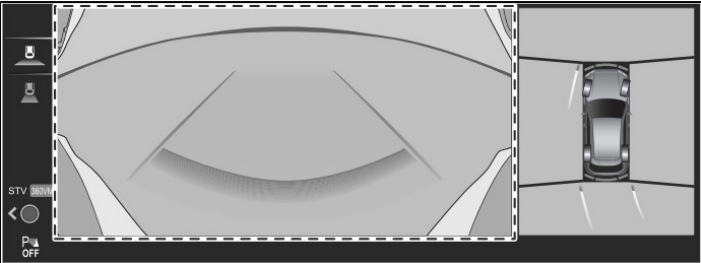

See-Through View

The See-Through View is a function that combines the images taken by each camera and processes them to look as if the vehicle is transparent and displays them on the center display.

Front See-Through View

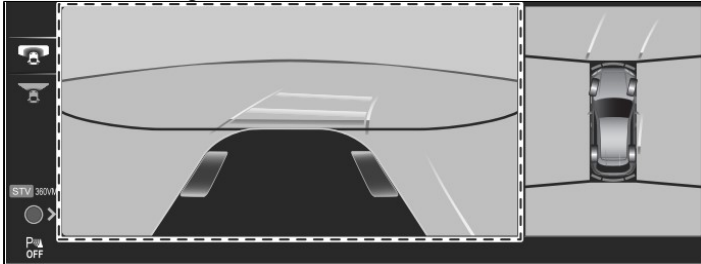

Rear See-Through View

CONSUMER NOTICE: The information and instructions in this bulletin are intended for use by skilled technicians. Mazda technicians utilize the proper tools/ equipment and take training to correctly and safely maintain Mazda vehicles. These instructions should not be performed by "do-it-yourselfers." Customers should not assume this bulletin applies to their vehicle or that their vehicle will develop the described concern. To determine if the information applies, customers should contact their nearest authorized Mazda dealership. Mazda North American Operations reserves the right to alter the specifications and contents of this bulletin without obligation or advance notice. All rights reserved. No part of this bulletin may be reproduced in any form or by any means, electronic or mechanical---including photocopying and recording and the use of any kind of information storage and retrieval system ---without permission in writing.

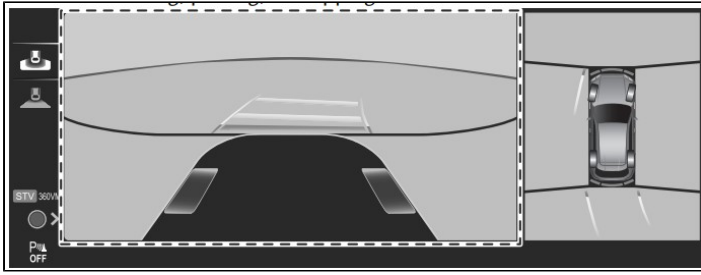

Trailer Hitch View (CX-70 only)

The Trailer Hitch View is a function that combines the image of the vehicle rear with the Trailer Hitch Guideline on the center display to facilitate alignment when hitching a trailer to the vehicle. Trailer Hitch View can be selected if equipped with a Mazda genuine trailer hitch.

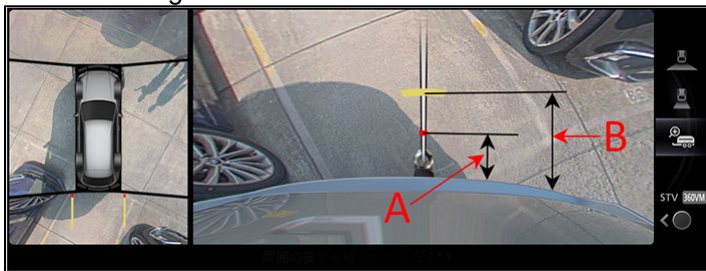

A - About 19in (50cm)
 B - About 39in (1m)

MGSS -> [360°VIEW MONITOR SYSTEM](#) -> Trailer Hitch View
 Owner's Manual -> Driving -> 360° View Monitor -> Trailer Hitch View

Driver Personalization System*

The Driver Personalization System recognizes the driver using the camera inside the vehicle and automatically restores the various driver settings that have been stored. The following 2 functions have been added depending on the grade and specification.

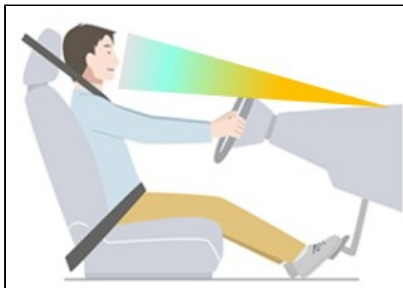

Ideal Driving Position Assist*

This function makes an overall determination of the driver's physique based on the information from the camera in the vehicle and the input height, and automatically adjusts to the recommended driving position.

[SA-061/23](#) - OPERATION OF DRIVER PERSONALIZATION SYSTEM
 Owner's Manual -> Equipment to Make Cabin More Comfortable -> [Driver Personalization System](#)
 MGSS -> [DRIVER PERSONALIZATION SYSTEM](#)

CONSUMER NOTICE: The information and instructions in this bulletin are intended for use by skilled technicians. Mazda technicians utilize the proper tools/ equipment and take training to correctly and safely maintain Mazda vehicles. These instructions should not be performed by "do-it-yourselfers." Customers should not assume this bulletin applies to their vehicle or that their vehicle will develop the described concern. To determine if the information applies, customers should contact their nearest authorized Mazda dealership. Mazda North American Operations reserves the right to alter the specifications and contents of this bulletin without obligation or advance notice. All rights reserved. No part of this bulletin may be reproduced in any form or by any means, electronic or mechanical--including photocopying and recording and the use of any kind of information storage and retrieval system ---without permission in writing.

- Seat Position



- Steering Wheel Position

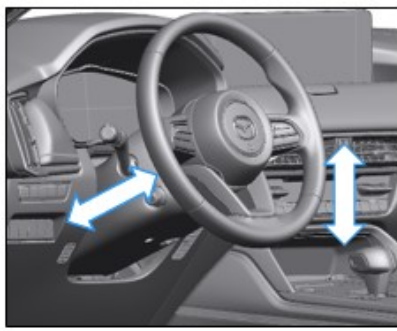

- Outside Mirror Position



- Active Driving Display Position

CONSUMER NOTICE: The information and instructions in this bulletin are intended for use by skilled technicians. Mazda technicians utilize the proper tools/ equipment and take training to correctly and safely maintain Mazda vehicles. These instructions should not be performed by "do-it-yourselfers." Customers should not assume this bulletin applies to their vehicle or that their vehicle will develop the described concern. To determine if the information applies, customers should contact their nearest authorized Mazda dealership. Mazda North American Operations reserves the right to alter the specifications and contents of this bulletin without obligation or advance notice. All rights reserved. No part of this bulletin may be reproduced in any form or by any means, electronic or mechanical---including photocopying and recording and the use of any kind of information storage and retrieval system ---without permission in writing.

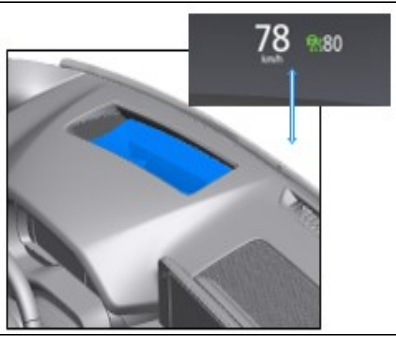

- Personalization feature settings
 - Example: Entertainment System favorites
- Climate control settings

NOTE: A driver needs to be programmed in advance to use this function. Additionally, driver information that is no longer needed can be deleted.

Entry/Exit Assist*

This function automatically moves the seat and the steering wheel so that the driver can easily enter and exit the vehicle.

MyMazda App

- The MyMazda App Remote Engine Start function **is** only available on H3T (inline 6) M Hybrid Boost models.
- The MyMazda App Remote Engine Start function **is not** available on PHEV (inline 4 2.5l) models.

MGSS -> [SA-038/23](#)

Mazda Connected Vehicle Viewer (MCVV)

The Mazda Connected Vehicle Viewer (MCVV) enhances the Mazda ownership experience by providing Mazda Service Advisors, Technicians and Call Center Associates access to real-time vehicle status information alerts for applicable Mazda connected vehicles.

This powerful tool allows you to proactively understand and diagnose customer concerns and resolve potential issues, demonstrating how well you know the customer's vehicle while establishing your readiness and willingness to assist.

[MAZDA CONNECTED VEHICLE VIEWER USER GUIDE \(MCVV\)](#)

CONSUMER NOTICE: The information and instructions in this bulletin are intended for use by skilled technicians. Mazda technicians utilize the proper tools/ equipment and take training to correctly and safely maintain Mazda vehicles. These instructions should not be performed by "do-it-yourselfers." Customers should not assume this bulletin applies to their vehicle or that their vehicle will develop the described concern. To determine if the information applies, customers should contact their nearest authorized Mazda dealership. Mazda North American Operations reserves the right to alter the specifications and contents of this bulletin without obligation or advance notice. All rights reserved. No part of this bulletin may be reproduced in any form or by any means, electronic or mechanical--including photocopying and recording and the use of any kind of information storage and retrieval system ---without permission in writing.

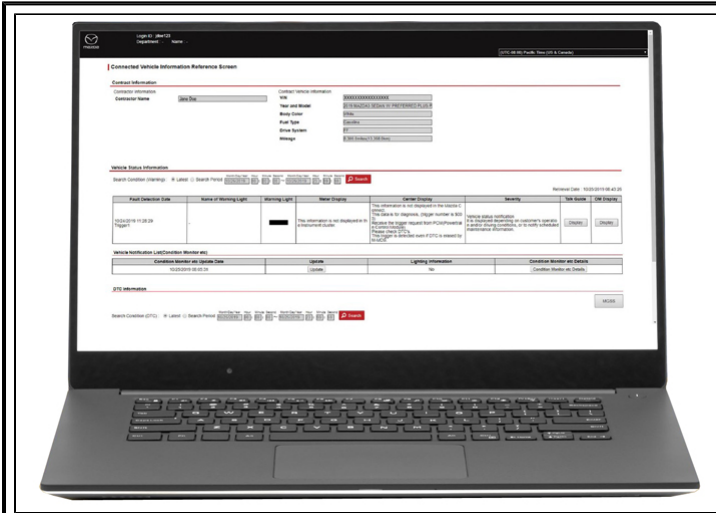

Mazda intelligent Drive Select (Mi-Drive)*

Mi-Drive is a system which switches the vehicle’s drive mode depending on the driving conditions, road conditions, and vehicle conditions.

Mi-Drive has the following driving modes.



The following drive modes can be switched according to the conditions.

See Owner's Manual -> Driving -> [Mazda intelligent Drive Select \(Mi-Drive\)](#)

CONSUMER NOTICE: The information and instructions in this bulletin are intended for use by skilled technicians. Mazda technicians utilize the proper tools/ equipment and take training to correctly and safely maintain Mazda vehicles. These instructions should not be performed by "do-it-yourselfers." Customers should not assume this bulletin applies to their vehicle or that their vehicle will develop the described concern. To determine if the information applies, customers should contact their nearest authorized Mazda dealership. Mazda North American Operations reserves the right to alter the specifications and contents of this bulletin without obligation or advance notice. All rights reserved. No part of this bulletin may be reproduced in any form or by any means, electronic or mechanical--including photocopying and recording and the use of any kind of information storage and retrieval system ---without permission in writing.

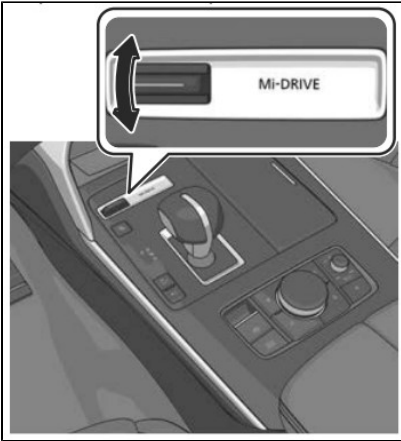

Normal mode

- This mode optimizes fuel efficiency.

Sport mode

- This mode maximizes responsiveness. It increases vehicle response when the accelerator pedal is depressed and accelerates powerfully.

Off-road mode

- This mode maximizes running performance. It prevents the drive wheels from spinning during off-road driving and improves the running performance.

Towing mode*

- This mode optimizes power performance. It reduces the loss of driving performance due to increased weight when towing a trailer and improves the vehicle stability.

EV mode (PHEV)

- This mode enables pure electric driving.

* if equipped

Hill Descent Control

The hill descent control is a system that maintains a constant vehicle speed when the vehicle descends a steep slope, off-road or on a snowy road. As the low speed can be maintained without operating the accelerator pedal or the brake pedal, the driver can concentrate on the steering wheel operation.

See Owner's Manual -> Driving -> [Hill Descent Control](#)

CONSUMER NOTICE: The information and instructions in this bulletin are intended for use by skilled technicians. Mazda technicians utilize the proper tools/ equipment and take training to correctly and safely maintain Mazda vehicles. These instructions should not be performed by "do-it-yourselfers." Customers should not assume this bulletin applies to their vehicle or that their vehicle will develop the described concern. To determine if the information applies, customers should contact their nearest authorized Mazda dealership. Mazda North American Operations reserves the right to alter the specifications and contents of this bulletin without obligation or advance notice. All rights reserved. No part of this bulletin may be reproduced in any form or by any means, electronic or mechanical--including photocopying and recording and the use of any kind of information storage and retrieval system ---without permission in writing.

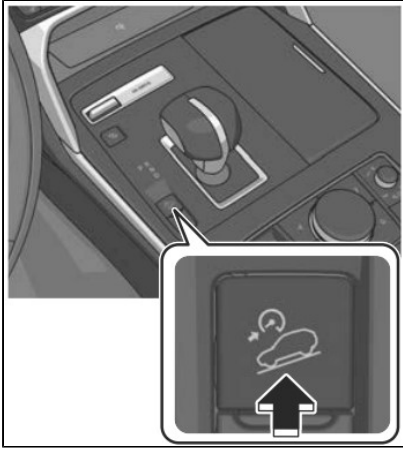

AUTOHOLD

AUTOHOLD is a function to keep the vehicle stopped by applying the brakes even if you take your foot off the brake pedal while the vehicle is stopped. This function reduces the burden on the driver while the vehicle is stopped, such as at traffic lights.

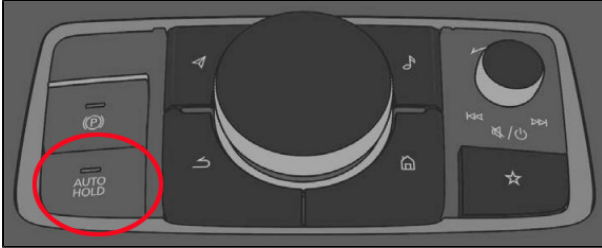

See Owner's Manual -> Driving -> [AUTOHOLD](#)

Hill Launch Assist (HLA)

The HLA prevents the vehicle from rolling backward or forward, such as when releasing the brake pedal while on a slope.

See Owner's Manual -> Driving -> [Hill Launch Assist \(HLA\)](#)

Kinematic Posture Control (KPC)

- Kinematic Posture Control (KPC) is a function that stabilizes the vehicle's turning posture by combining the rear suspension structure, which has the characteristic of pulling the vehicle down during braking, with the brake control.
- Braking control is performed to stabilize the turning posture in situations where high G is generated on the vehicle, such as during turning at high speed, tight cornering, or driving on rough road surfaces.

See MGSS -> [KINEMATIC POSTURE CONTROL \(KPC\)](#)

CONSUMER NOTICE: The information and instructions in this bulletin are intended for use by skilled technicians. Mazda technicians utilize the proper tools/ equipment and take training to correctly and safely maintain Mazda vehicles. These instructions should not be performed by "do-it-yourselfers." Customers should not assume this bulletin applies to their vehicle or that their vehicle will develop the described concern. To determine if the information applies, customers should contact their nearest authorized Mazda dealership. Mazda North American Operations reserves the right to alter the specifications and contents of this bulletin without obligation or advance notice. All rights reserved. No part of this bulletin may be reproduced in any form or by any means, electronic or mechanical--including photocopying and recording and the use of any kind of information storage and retrieval system ---without permission in writing.

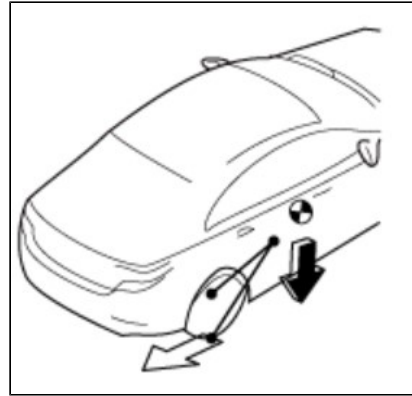

Wireless Qi Charger*

You can charge mobile devices such as Smartphones which comply with the Qi Wireless Charging standard. Only use mobile devices that have a maximum power consumption of 5 W, or 15 W or below. The maximum power consumption differs depending on the mobile device.

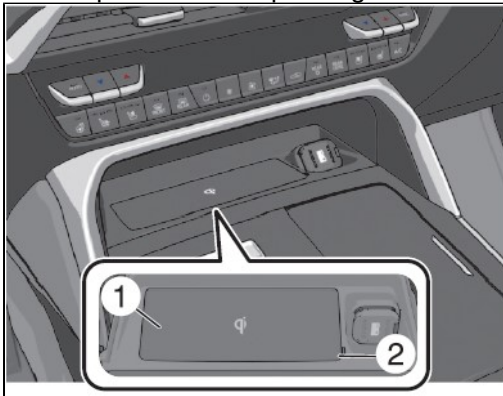

- 1. Charging area
- 2. LED indicator

- The LED indicator turns on in **amber** or **green** when charging starts.
- For details on the LED indicator, refer to the LED indicator table.
- Charging starts when
 1. Engine is running
 2. Qi compatible device placed in center of the charging area on the tray
 3. All the doors and liftgate are closed.

* if equipped

See [SA-021/23](#) for troubleshooting
 See Owner's Manual -> Other Equipment -> [Wireless Charger \(Qi\)](#)
 See Service Highlights -> [WIRELESS CHARGER \(Qi\)](#)

LED Indicator	Infotainment Display	Status
Does not turn on	---	System turned off
Solid white		Charging is possible
Solid amber		Normal charging
Solid green		Fast charging*1
Flashes white		Charging conditions are not met
Flashes red	 Vehicle side	Charging is not possible because charging pad high temperature is detected (Charging will resume when charging pad cools)

Charging is not possible because:

CONSUMER NOTICE: The information and instructions in this bulletin are intended for use by skilled technicians. Mazda technicians utilize the proper tools/ equipment and take training to correctly and safely maintain Mazda vehicles. These instructions should not be performed by "do-it-yourselfers." Customers should not assume this bulletin applies to their vehicle or that their vehicle will develop the described concern. To determine if the information applies, customers should contact their nearest authorized Mazda dealership. Mazda North American Operations reserves the right to alter the specifications and contents of this bulletin without obligation or advance notice. All rights reserved. No part of this bulletin may be reproduced in any form or by any means, electronic or mechanical--including photocopying and recording and the use of any kind of information storage and retrieval system ---without permission in writing.

*1 Some mobile devices can switch between normal charging and fast charging.



Customer device issue

- Customer device high temperature
- Foreign matter is detected
- Phone case is not compatible with Qi wireless charger

Solid red



Problem with Wireless Charger (Qi)

Liftgate Lens Illumination

Liftgate lens on higher trims illuminates when tail lights are on

Liftgate lens on lower trims does not illuminate

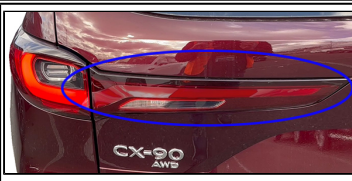

Use MGSS or GEPC with VIN to determine if vehicle is equipped with illumination:

MGSS -> Other Application -> Warranty Veh. Inq -> Model / Year

With illumination	No illumination
<ul style="list-style-type: none"> • C90 S • C90 SPP • C90 SPPP 	<p>Except</p> <ul style="list-style-type: none"> • C90 S • C90 SPP • C90 SPPP

Detail:

- C90 S = 3.3 Turbo S
- C90 SPP = 3.3 Turbo S Premium Package
- C90 SPPP = 3.3 Turbo S Premium Plus Package

GEPC (with VIN)

	With illumination	No illumination
Left	KMV7513G0*	KMV6513G0*
Right	KMV7513F0*	KMV6513F0*

NOTE: Parts are not interchangeable. This method is used to determine if vehicle is equipped with illumination.

Power Liftgate Hands-free function*

The liftgate can be opened and closed by doing a kicking

See Owner's Manual -> Opening / closing -> Liftgate -> [Hands-free function](#)

CONSUMER NOTICE: The information and instructions in this bulletin are intended for use by skilled technicians. Mazda technicians utilize the proper tools/ equipment and take training to correctly and safely maintain Mazda vehicles. These instructions should not be performed by "do-it-yourselfers." Customers should not assume this bulletin applies to their vehicle or that their vehicle will develop the described concern. To determine if the information applies, customers should contact their nearest authorized Mazda dealership. Mazda North American Operations reserves the right to alter the specifications and contents of this bulletin without obligation or advance notice. All rights reserved. No part of this bulletin may be reproduced in any form or by any means, electronic or mechanical--including photocopying and recording and the use of any kind of information storage and retrieval system ---without permission in writing.

motion when both hands are occupied, such as when holding groceries or luggage.

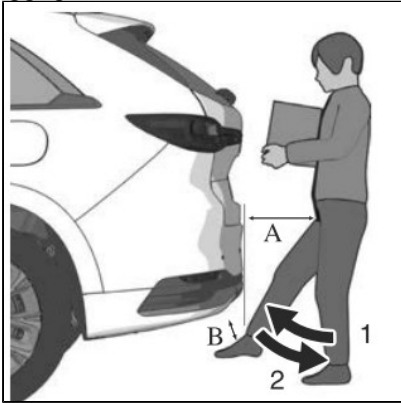

A : About 30—50 cm (12—19.7 in)
 B : About 10 cm (3.9 in)

Remote Power Window Operation

The windows can be opened for ventilating the cabin before getting in the vehicle. Press the unlock button on the key quickly and briefly 3 times and then immediately afterwards, press and hold the unlock button to open the windows.

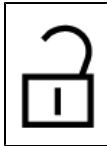

To stop the windows from opening, release the button. If the operation is performed from the beginning again, the windows open.

See Owner's Manual -> Opening / closing -> Windows -> [Remote Power Window Operation](#)

Electric Parking Brake (EPB)

The EPB system applies the parking brake using a motor.
NOTE If the parking brake is applied with the vehicle power switched to OFF or ACC, the EPB indicator light in the instrument cluster and the indicator light in the switch may turn on for a certain period of time.
 Applying the Parking Brake

See Owner's Manual -> Driving -> [Electric Parking Brake \(EPB\)](#)

CONSUMER NOTICE: The information and instructions in this bulletin are intended for use by skilled technicians. Mazda technicians utilize the proper tools/ equipment and take training to correctly and safely maintain Mazda vehicles. These instructions should not be performed by "do-it-yourselfers." Customers should not assume this bulletin applies to their vehicle or that their vehicle will develop the described concern. To determine if the information applies, customers should contact their nearest authorized Mazda dealership. Mazda North American Operations reserves the right to alter the specifications and contents of this bulletin without obligation or advance notice. All rights reserved. No part of this bulletin may be reproduced in any form or by any means, electronic or mechanical--including photocopying and recording and the use of any kind of information storage and retrieval system ---without permission in writing.

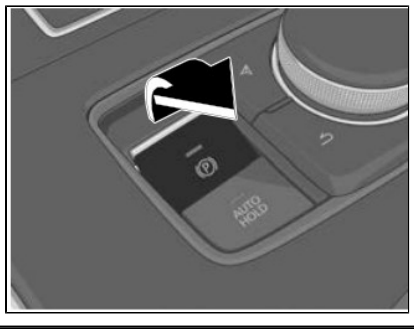

Releasing the Parking Brake.

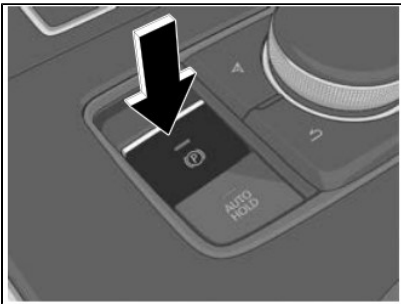

MAZDA CONNECT Power Off Function

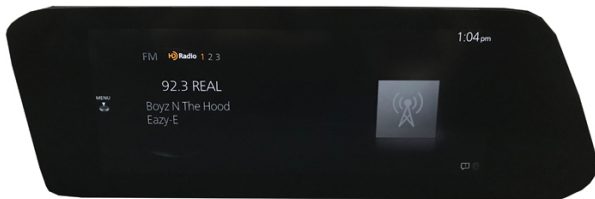

- Audio Mute: Short press the volume knob (press again to cancel)
- Power Off: Press and hold the volume knob (press and hold again to Power On)



See Owner's Manual -> MAZDA CONNECT OWNER'S MANUAL -> Basic Operations -> Commander Switch Operation -> [Power off/on](#)

CONSUMER NOTICE: The information and instructions in this bulletin are intended for use by skilled technicians. Mazda technicians utilize the proper tools/ equipment and take training to correctly and safely maintain Mazda vehicles. These instructions should not be performed by "do-it-yourselfers." Customers should not assume this bulletin applies to their vehicle or that their vehicle will develop the described concern. To determine if the information applies, customers should contact their nearest authorized Mazda dealership. Mazda North American Operations reserves the right to alter the specifications and contents of this bulletin without obligation or advance notice. All rights reserved. No part of this bulletin may be reproduced in any form or by any means, electronic or mechanical---including photocopying and recording and the use of any kind of information storage and retrieval system ---without permission in writing.

Alexa Built-In (CX-70 only)

Alexa is a hands-free and easy to use, allowing the user to control vehicle functions with verbal commands while maintaining the driving posture.

Alexa voice recognition can operate the navigation, hands-free telephone, and the audio functions, along others.

In addition, Alexa's various functions (such as weather information, news functions, shopping and Smart Home)

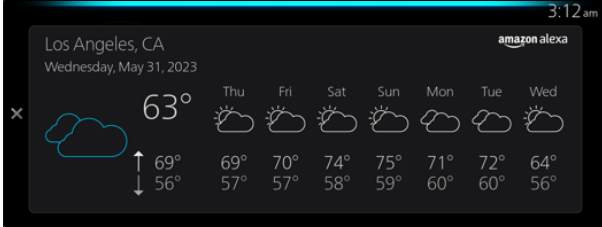

See [SA-015/24](#) - ALEXA BUILT-IN FAQ

Note: Requires Connected Vehicle Contract.

Mazda Online Navigation (CX-70 only)

Online Navigation uses online data for Navigation. Users can access wider range of and more up-to-date information.

Offline

- Operates same as previous Gen 7 Navi SD Card system

Online**

- POI
 - Larger geographical area (surrounding states)
- Route
 - Server based live search / traffic
 - Up-to-date map
- Traffic
 - More frequent update and detailed maps
- Map Update
 - On-demand map update (4 times a year)

****Requires:**

- Connected Vehicle Contract
- Navi SD Card
- Initial setup (License Agreement)
- Good signal strength

Wireless Apple Carplay™ / Android Auto™

Infotainment Touchscreen* enabled during Wireless Apple Carplay™ / Android Auto™ operation.

Owner's Manual -> MAZDA CONNECT OWNER'S MANUAL -> [Touch Panel Operation](#)

Owner's Manual -> MAZDA CONNECT OWNER'S MANUAL -> [Apple Carplay™ / Android Auto™](#)

CONSUMER NOTICE: The information and instructions in this bulletin are intended for use by skilled technicians. Mazda technicians utilize the proper tools/ equipment and take training to correctly and safely maintain Mazda vehicles. These instructions should not be performed by "do-it-yourselfers." Customers should not assume this bulletin applies to their vehicle or that their vehicle will develop the described concern. To determine if the information applies, customers should contact their nearest authorized Mazda dealership. Mazda North American Operations reserves the right to alter the specifications and contents of this bulletin without obligation or advance notice. All rights reserved. No part of this bulletin may be reproduced in any form or by any means, electronic or mechanical--including photocopying and recording and the use of any kind of information storage and retrieval system ---without permission in writing.

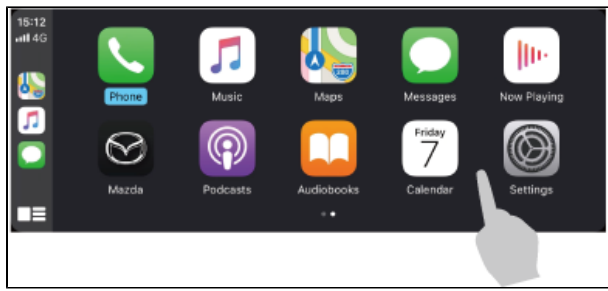

* if equipped (higher trim levels have touchscreen available while lower trim levels only use the commander switch)

USB Type C Flash Drive (Except 3.3 Turbo Select Package)
Used for module software update and/or Data Collection

- USB Type C



- USB Type A / USB Type C combination



- USB Type A to USB Type C adapter may be used but not recommended



- DO NOT USE USB Multi Adapter

CONSUMER NOTICE: The information and instructions in this bulletin are intended for use by skilled technicians. Mazda technicians utilize the proper tools/ equipment and take training to correctly and safely maintain Mazda vehicles. These instructions should not be performed by "do-it-yourselfers." Customers should not assume this bulletin applies to their vehicle or that their vehicle will develop the described concern. To determine if the information applies, customers should contact their nearest authorized Mazda dealership. Mazda North American Operations reserves the right to alter the specifications and contents of this bulletin without obligation or advance notice. All rights reserved. No part of this bulletin may be reproduced in any form or by any means, electronic or mechanical--including photocopying and recording and the use of any kind of information storage and retrieval system ---without permission in writing.



NOTE: 3.3 Turbo Select Package uses USB Type A



Key Transmitter Power Saving Function

"Power saving" function is built into the keyless entry system where **some** key fob functions are disabled. This feature could accidentally be enabled and some concerns with the vehicle may be:

- Engine does not start.
- Engine does not start unless you hold the fob to the start/stop button.
- Doors do not unlock using the door handle, but unlock with the remote.
- Doors do not lock using the door handle, but lock with the remote.
- Transmitter indicator light does not turn on/flash.

See Owner's Manual -> Opening/closing -> Key -> [Power saving function](#)

Occupant Comfort*

The driver and front passenger's seater warmers*, seat ventilation and the heated steering wheel* can be set to be automatically controlled (turned on and off) by the climate control system, depending on the set temperature.

1. Go to MAZDA CONNECT home screen and select "Settings"
2. Select "Vehicle Settings".
3. Select "Occupant Comfort".

See Owner's Manual -> Equipment to Make Cabin More Comfortable -> [Occupant Comfort](#)

CONSUMER NOTICE: The information and instructions in this bulletin are intended for use by skilled technicians. Mazda technicians utilize the proper tools/ equipment and take training to correctly and safely maintain Mazda vehicles. These instructions should not be performed by "do-it-yourselfers." Customers should not assume this bulletin applies to their vehicle or that their vehicle will develop the described concern. To determine if the information applies, customers should contact their nearest authorized Mazda dealership. Mazda North American Operations reserves the right to alter the specifications and contents of this bulletin without obligation or advance notice. All rights reserved. No part of this bulletin may be reproduced in any form or by any means, electronic or mechanical--including photocopying and recording and the use of any kind of information storage and retrieval system ---without permission in writing.



4. Enable Drivers Seat Temperature, Passenger Seat Temperature and Heated Steering wheel.



5. Select Climate Control Auto Switch

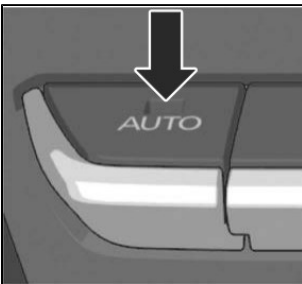

* if equipped

***Rear Seat Alert**

See Owner's Manual -> Opening/Closing -> [Rear Seat Alert](#)

CONSUMER NOTICE: The information and instructions in this bulletin are intended for use by skilled technicians. Mazda technicians utilize the proper tools/ equipment and take training to correctly and safely maintain Mazda vehicles. These instructions should not be performed by "do-it-yourselfers." Customers should not assume this bulletin applies to their vehicle or that their vehicle will develop the described concern. To determine if the information applies, customers should contact their nearest authorized Mazda dealership. Mazda North American Operations reserves the right to alter the specifications and contents of this bulletin without obligation or advance notice. All rights reserved. No part of this bulletin may be reproduced in any form or by any means, electronic or mechanical--including photocopying and recording and the use of any kind of information storage and retrieval system ---without permission in writing.

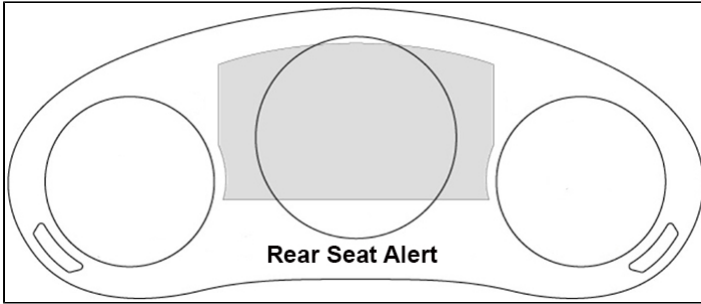

The Rear Seat Alert is a system that reminds the driver to check if any occupants or luggage have been left behind on the second/third-row seats.

The system determines if there is the possibility that occupants or luggage are on a second/third-row seat based on the opening and closing history of the rear doors. For this reason, the system may operate differently from the actual conditions, such as it is not activated even if occupants or luggage are occupying a second/third-row seat.

Connected Vehicle Maintenance Mode

When vehicle is being serviced, switch to Restricted Transmitting Mode.

- Restricts MyMazda App remote functions.
- Prevents error messages being sent to the customer during vehicle service.

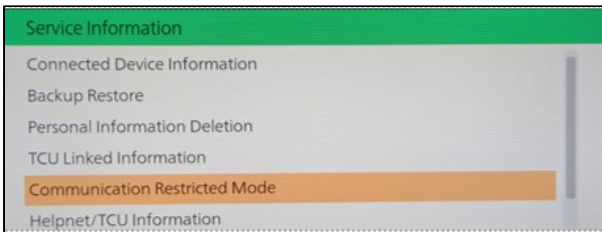

Cancel Restricted Transmitting Mode after completing vehicle service.

Go to MGSS [SERVICE CAUTIONS FOR VEHICLES WITH TELEMATICS COMMUNICATION SYSTEM \[\(US\)\]](#).

CONSUMER NOTICE: The information and instructions in this bulletin are intended for use by skilled technicians. Mazda technicians utilize the proper tools/ equipment and take training to correctly and safely maintain Mazda vehicles. These instructions should not be performed by "do-it-yourselfers." Customers should not assume this bulletin applies to their vehicle or that their vehicle will develop the described concern. To determine if the information applies, customers should contact their nearest authorized Mazda dealership. Mazda North American Operations reserves the right to alter the specifications and contents of this bulletin without obligation or advance notice. All rights reserved. No part of this bulletin may be reproduced in any form or by any means, electronic or mechanical--including photocopying and recording and the use of any kind of information storage and retrieval system ---without permission in writing.

Engine Maintenance Mode

If the fuel has not been replenished for a certain period of time and the quality of the fuel in the tank is expected to change, an "Engine Maintenance Mode" message is displayed in the instrument cluster when the hybrid system is started. When a certain amount of fuel is consumed, the message displayed in the instrument cluster is no longer displayed.

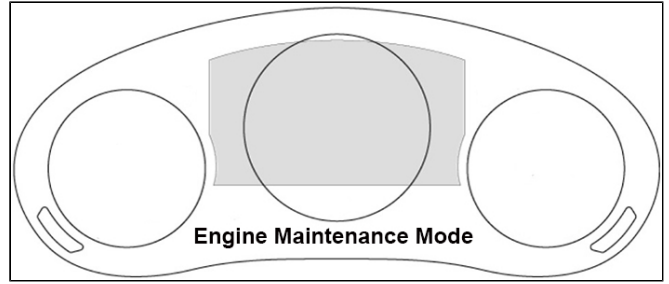

**Front Wiper Service Position
Start Procedure**

- a) Switch the vehicle power ON.
- b) Switch the vehicle power OFF.
- c) Press up the wiper switch to the MIST position 2 times within 30 seconds after switching the vehicle power OFF. When the procedure is completed, the wipers operate and they stop at the service positions.

End Procedure

- a) Make sure that the wipers are set on the windshield.
- b) Switch the vehicle power ON.
- c) Press up the wiper switch to the MIST position 2 times.

See Owner's Manual -> Inspection and Servicing/Cleaning -> Vehicle Exterior Inspection -> [Replacing Front Windshield Wiper Blade rubbers](#)

Rear Brake Maintenance Mode

When in maintenance mode, the clearance between the disc pad and the disc plate expands.

Switching to Maintenance Mode -> See [MAINTENANCE MODE](#) found in MGSS.

MGSS -> [MAINTENANCE MODE](#)

CX-90 Mazda Brand Academy

Hybrid & EV Specialist Certification		
Course	Description	Note
40067	Hybrid & EV Safety Essentials	Current Certified Level requirement
40068TST	Certification Test 6	Current Certified Level requirement
40075	Hybrid & EV Theory of Operation	Current Senior Level requirement
40072	Large Platform Introduction	New Hybrid & EV Specialist requirement
40073	Large Platform Powertrains	New Hybrid & EV Specialist requirement
40074	Hybrid & EV Technology ILT	New Hybrid & EV Specialist requirement – Enrollment available upon completing prerequisites. Classes available beginning late May 2023.

CONSUMER NOTICE: The information and instructions in this bulletin are intended for use by skilled technicians. Mazda technicians utilize the proper tools/ equipment and take training to correctly and safely maintain Mazda vehicles. These instructions should not be performed by "do-it-yourselfers." Customers should not assume this bulletin applies to their vehicle or that their vehicle will develop the described concern. To determine if the information applies, customers should contact their nearest authorized Mazda dealership. Mazda North American Operations reserves the right to alter the specifications and contents of this bulletin without obligation or advance notice. All rights reserved. No part of this bulletin may be reproduced in any form or by any means, electronic or mechanical--including photocopying and recording and the use of any kind of information storage and retrieval system ---without permission in writing.

Prerequisites: Senior Certification, Electrical Specialty and courses 40072 and 40073

CONSUMER NOTICE: The information and instructions in this bulletin are intended for use by skilled technicians. Mazda technicians utilize the proper tools/ equipment and take training to correctly and safely maintain Mazda vehicles. These instructions should not be performed by "do-it-yourselfers." Customers should not assume this bulletin applies to their vehicle or that their vehicle will develop the described concern. To determine if the information applies, customers should contact their nearest authorized Mazda dealership. Mazda North American Operations reserves the right to alter the specifications and contents of this bulletin without obligation or advance notice. All rights reserved. No part of this bulletin may be reproduced in any form or by any means, electronic or mechanical---including photocopying and recording and the use of any kind of information storage and retrieval system ---without permission in writing.