

Service Alert

Mazda North American Operations
Irvine, CA 92618-2922



Subject: ELECTRICAL CONCERN AND/OR MULTIPLE DTC'S DUE TO AFTERMARKET DEVICE	Service Alert No.: SA-057/24
	Last Issued : 08/15/2024

BULLETIN NOTES

This SA supersedes the previously issued SA(s) listed below. The changes are noted in Red.

Previous SAs:	Date(s) Issued:
SA-032/23	5/24/23 and 10/11/23
SA-075/22	11/14/22

APPLICABLE MODEL(S)/VINS:

2007-2025 Mazda3	2007-2015 Mazda5	2013-2025 CX-5	2023-2025 CX-50
2007-2021 Mazda6	2007-2012 CX-7	2016-2023 CX-3	2025 CX-70
2007-2024 MX-5	2007-2023 CX-9	2020-2025 CX-30	2024-2025 CX-90
2007-2011 RX-8	2011-2023 Mazda2	2022-2023 MX-30	

DESCRIPTION

If you encounter any type of electrical concern (e.g. dead battery, engine no start, DTC(s) stored...), interview the customer before proceeding with normal MGSS diagnosis by asking if any aftermarket devices have been installed. Aftermarket devices may be the cause of the electrical concern. Below are a few examples of unusual electrical concerns caused by aftermarket devices.

Examples:

1. Devices connected to the DLC-2 (battery discharge/DTC stored)
2. Devices plugged into the 12V outlet
3. GPS tracking device (engine no start/battery discharge)
4. Dash cam (DTC stored)
5. Non-certified USB cable (Apple Carplay™/ Android Auto™ will not connect)
6. Over-sized wheels/tires (incorrect GPS location)
7. DTC C0023:14
8. Decorative trim and/or cover on the START/STOP ENGINE button

CONSUMER NOTICE: The information and instructions in this bulletin are intended for use by skilled technicians. Mazda technicians utilize the proper tools/ equipment and take training to correctly and safely maintain Mazda vehicles. These instructions should not be performed by "do-it-yourselfers." Customers should not assume this bulletin applies to their vehicle or that their vehicle will develop the described concern. To determine if the information applies, customers should contact their nearest authorized Mazda dealership. Mazda North American Operations reserves the right to alter the specifications and contents of this bulletin without obligation or advance notice. All rights reserved. No part of this bulletin may be reproduced in any form or by any means, electronic or mechanical---including photocopying and recording and the use of any kind of information storage and retrieval system ---without permission in writing.

Example 1:

Some electrical devices connected to the DLC-2 connector by insurance or mobile phone companies may cause:

- Battery discharge. The device may disrupt the CAN system battery saver mode.
- IDS/MMDS will not communicate with the vehicle due to poor DLC-2 connection. The aftermarket device may cause DLC-2 female terminals to spread open.
- DTCs
 - B1041:54 - ADAPTIVE FRONT LIGHTING SYSTEM (AFS) CONTROL MODULE
 - B108E:04 - CENTER DISPLAY INTERNAL MALFUNCTION
 - C0061:54 - DSC HU/CM
 - C1001:92 - FORWARD SENSING CAMERA (FSC)
 - C1001:97 - FORWARD SENSING CAMERA (FSC)
 - U300A:62 - ELECTRIC PARKING BRAKE (EPB)
 - U3004:17 - ACC RELAY CIRCUIT MALFUNCTION
 - U0415:00 - MAZDA RADAR CRUISE CONTROL (MRCC)/SMART BRAKE SUPPORT (SBS)
 - U0420:00 - MAZDA RADAR CRUISE CONTROL (MRCC)/SMART BRAKE SUPPORT (SBS)
 - Multiple DTC's (U0XXX:00 COMMUNICATION ERROR)

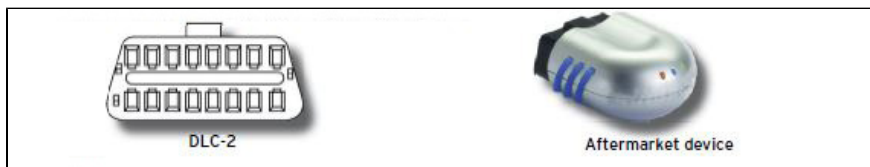

- If an aftermarket device is found connected to DLC-2, take a photo and attach it to the RO. Advise the customer to remove it.
- If you determine that no aftermarket devices have been installed, continue with normal MGSS diagnosis.

Example 2:

Some aftermarket cell phone chargers, accessories connected to the 12V outlet or key fob proximity to a cell phone may cause issues with the START/STOP button or rear view camera.

Possible symptoms can include:

- Intermittent engine no start or unable to turn off
- Instrument cluster red security indicator light ON
- Engine Start/Start Button Amber indicator light flashing
- Battery discharge
- Electrical relay buzzing noise
- DTC B13D3:94 stored (Communication error with remote transmitter)
- DTC P1260:00 stored (Immobilizer system problem)
- Rear View Monitor Display is Blurry

For concerns where the vehicle power supply cannot be controlled adequately, such as an engine no start condition or the engine cannot be turned off, explain to the customer as follows: Due to the reverse power supply from electronic devices with internal batteries connected through the vehicle's accessory socket, the vehicle system may not be able to determine the vehicle electronic status. As a result, the vehicle power supply control fails. To overcome this situation, remove the electronic device with internal batteries from the accessory socket.

CONSUMER NOTICE: The information and instructions in this bulletin are intended for use by skilled technicians. Mazda technicians utilize the proper tools/ equipment and take training to correctly and safely maintain Mazda vehicles. These instructions should not be performed by "do-it-yourselfers." Customers should not assume this bulletin applies to their vehicle or that their vehicle will develop the described concern. To determine if the information applies, customers should contact their nearest authorized Mazda dealership. Mazda North American Operations reserves the right to alter the specifications and contents of this bulletin without obligation or advance notice. All rights reserved. No part of this bulletin may be reproduced in any form or by any means, electronic or mechanical--including photocopying and recording and the use of any kind of information storage and retrieval system ---without permission in writing.

Additionally, the above symptoms may be caused by the key fob in close proximity to a cell phone (radio waves may interrupt the immobilizer system) Or Type "B" Key Transmitter Power Saving Function enabled (Refer to SA-020/21).

Aftermarket Cell Phone Charger/Accessory connected to 12V outlet	Engine Start/Stop Button Amber Indicator Light Flashing	Key Warning Light (red)
		

Rear View Monitor Display is Blurry:

Blurry Display



With aftermarket cell phone charger connected to 12V outlet

=



OK



Without aftermarket cell phone charger

=



CONSUMER NOTICE: The information and instructions in this bulletin are intended for use by skilled technicians. Mazda technicians utilize the proper tools/ equipment and take training to correctly and safely maintain Mazda vehicles. These instructions should not be performed by "do-it-yourselfers." Customers should not assume this bulletin applies to their vehicle or that their vehicle will develop the described concern. To determine if the information applies, customers should contact their nearest authorized Mazda dealership. Mazda North American Operations reserves the right to alter the specifications and contents of this bulletin without obligation or advance notice. All rights reserved. No part of this bulletin may be reproduced in any form or by any means, electronic or mechanical---including photocopying and recording and the use of any kind of information storage and retrieval system ---without permission in writing.

Example 3:

Some aftermarket devices that are wired to the vehicles's wiring harness may create unusual electrical symptoms and/or store DTCs.

Below are examples of concerns due to an aftermarket GPS tracking device wired to the power window main switch:

- Engine no start
- Battery discharge
- Main relay buzzing

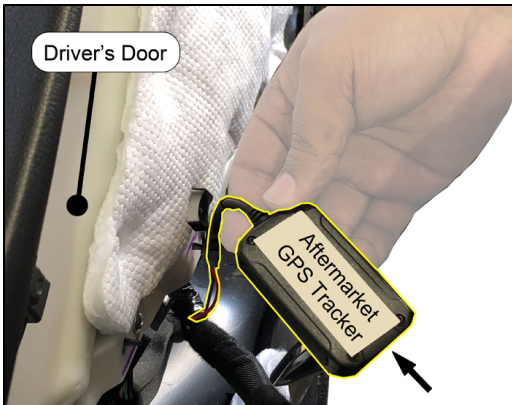

Below is an example of a dim headlight. The aftermarket device changed the headlight circuit resistance, causing a dim headlight.

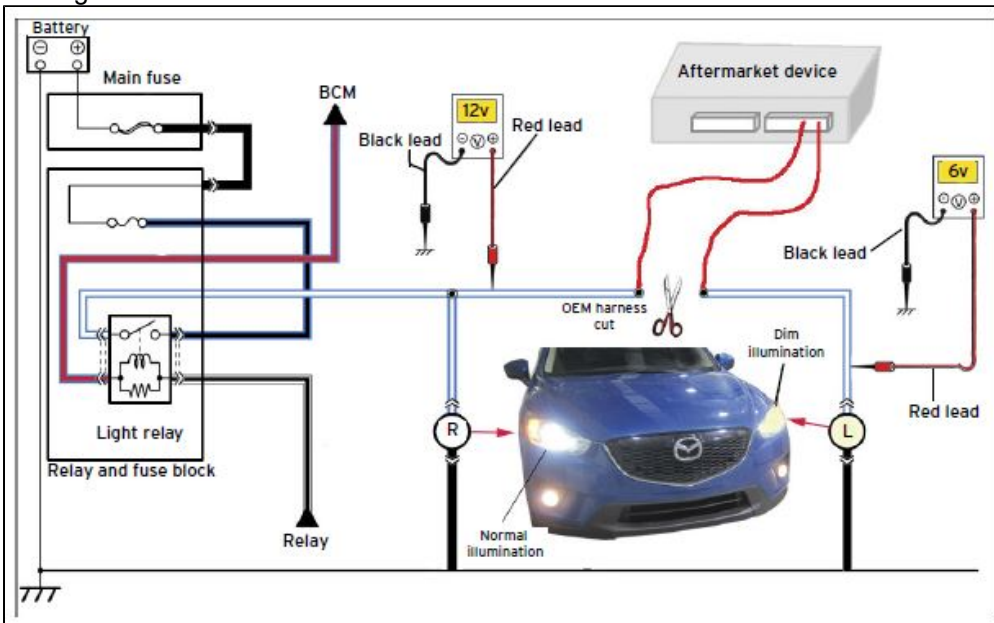

CONSUMER NOTICE: The information and instructions in this bulletin are intended for use by skilled technicians. Mazda technicians utilize the proper tools/ equipment and take training to correctly and safely maintain Mazda vehicles. These instructions should not be performed by "do-it-yourselfers." Customers should not assume this bulletin applies to their vehicle or that their vehicle will develop the described concern. To determine if the information applies, customers should contact their nearest authorized Mazda dealership. Mazda North American Operations reserves the right to alter the specifications and contents of this bulletin without obligation or advance notice. All rights reserved. No part of this bulletin may be reproduced in any form or by any means, electronic or mechanical---including photocopying and recording and the use of any kind of information storage and retrieval system ---without permission in writing.

Example 4:

DTC B119F:01 (TEL antenna No.1 malfunction) stored. This may be caused by an aftermarket dash cam, radar detector and/or FasTrak device.

The aftermarket device may cause electrical noise disturbing the reception of GPS signals.



Example 5:

Apple Carplay™/ Android Auto™ will not function when connected to USB port. This may be caused a by low quality, non-certified USB cable.

Example 6:

Navigation display map shows incorrect GPS location (A). This may be caused by over-sized wheels/tires. Confirm correct wheel/tire size according to the tire label.

Navi Map Shows Incorrect GPS position (A)	Possible oversized wheels/tires

CONSUMER NOTICE: The information and instructions in this bulletin are intended for use by skilled technicians. Mazda technicians utilize the proper tools/ equipment and take training to correctly and safely maintain Mazda vehicles. These instructions should not be performed by "do-it-yourselfers." Customers should not assume this bulletin applies to their vehicle or that their vehicle will develop the described concern. To determine if the information applies, customers should contact their nearest authorized Mazda dealership. Mazda North American Operations reserves the right to alter the specifications and contents of this bulletin without obligation or advance notice. All rights reserved. No part of this bulletin may be reproduced in any form or by any means, electronic or mechanical---including photocopying and recording and the use of any kind of information storage and retrieval system ---without permission in writing.

Example 7:

DTC C0023:14 (Brake light circuit malfunction) stored. This may be caused by an aftermarket brake light flasher.

**Example 8:**

When programming a key or installing a Genuine Mazda Accessory Remote Engine Start system, you may encounter programming difficulty. This may be caused by a customer installed aftermarket decorative trim and/or cover on the START/STOP ENGINE button. The aftermarket accessory may create electrical interference, which may interfere with programming.

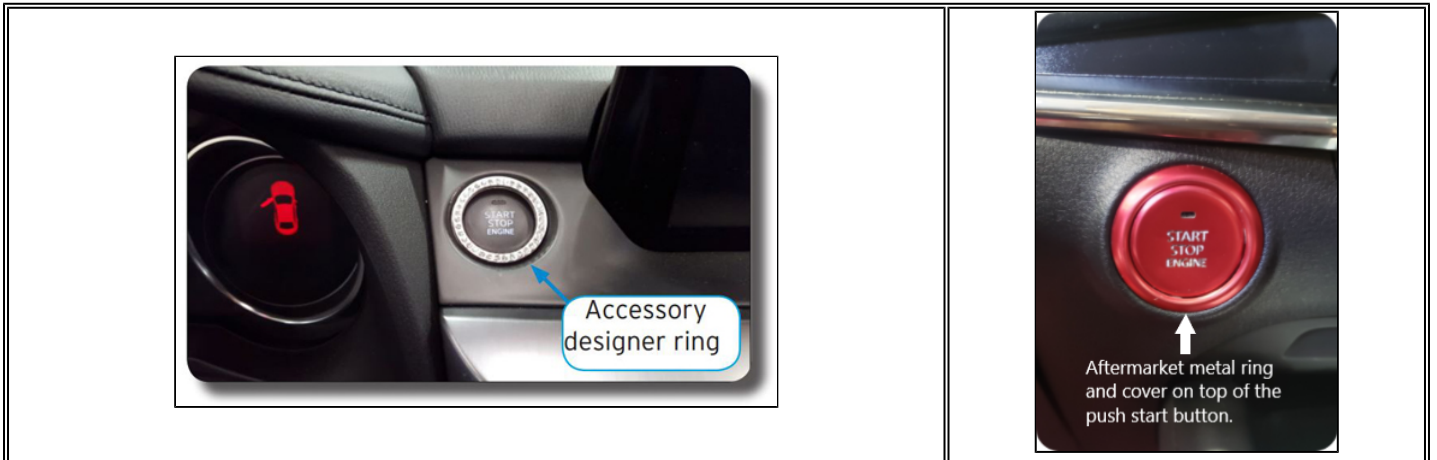
**REPAIR PROCEDURE**

1. Verify the customer concern.

CONSUMER NOTICE: The information and instructions in this bulletin are intended for use by skilled technicians. Mazda technicians utilize the proper tools/ equipment and take training to correctly and safely maintain Mazda vehicles. These instructions should not be performed by "do-it-yourselfers." Customers should not assume this bulletin applies to their vehicle or that their vehicle will develop the described concern. To determine if the information applies, customers should contact their nearest authorized Mazda dealership. Mazda North American Operations reserves the right to alter the specifications and contents of this bulletin without obligation or advance notice. All rights reserved. No part of this bulletin may be reproduced in any form or by any means, electronic or mechanical--including photocopying and recording and the use of any kind of information storage and retrieval system ---without permission in writing.

- If the customer's concern(s) are verified to be caused by any aftermarket device as described in the examples above, take a photo of the device and include it with the RO. The customer should also be advised to remove the device.
- If it is determined that no aftermarket devices have been installed, continue with normal diagnosis on MGSS. Please contact [Technical Hotline](#) for repeat visits.

2. Verify the repair.

WARRANTY INFORMATION

Use DSA to submit for non-problem found non-warrantable diagnosis for up to 0.7 hrs. if needed.

CONSUMER NOTICE: The information and instructions in this bulletin are intended for use by skilled technicians. Mazda technicians utilize the proper tools/ equipment and take training to correctly and safely maintain Mazda vehicles. These instructions should not be performed by "do-it-yourselfers." Customers should not assume this bulletin applies to their vehicle or that their vehicle will develop the described concern. To determine if the information applies, customers should contact their nearest authorized Mazda dealership. Mazda North American Operations reserves the right to alter the specifications and contents of this bulletin without obligation or advance notice. All rights reserved. No part of this bulletin may be reproduced in any form or by any means, electronic or mechanical---including photocopying and recording and the use of any kind of information storage and retrieval system ---without permission in writing.