

July 25, 2024

Version 1

EPS Sticking and Slipping

AFFECTED VEHICLES

Year	Model	Trim Level	VIN Range
2023–24	Integra (excluding Type-S)	ALL	ALL

SYMPTOM

While driving at highway speeds, clients may find that the steering wheel does not automatically return to center.

CORRECTIVE ACTION

Redistribute grease to the worm gear, and replace the end cap, spring, and spring seat in the EPS gearbox assembly.

PARTS INFORMATION

Part Name	Part Number	Quantity
Gearbox Assembly Steering Kit	06530-T20-305	1
Washer Bolt (14X85)	90179-T20-A01	4
Washer Bolt (14X45)	90163-TGH-A01	2
Washer Bolt (14X85)	90130-T20-A00	1
Flange Bolt (14X35)	90181-TBA-A00	2
Flange Bolt (14X80)	90108-T20-A00	3
Split Pin (3.0X22)	94201-30220	2
Washer Bolt (10X25)	90159-TBA-A00	3
Self-Lock Nut (12mm)	90215-SB0-003	6
Flange Nut (10mm)	90002-S10-000	2
Flange Bolt (12x95)	90167-SEA-E11	2

REQUIRED MATERIALS

Part Name	Part Number	Quantity
Hondabond HT	08718-0004	1 tube for 50 vehicles

CLIENT INFORMATION: The information in this bulletin is intended for use only by skilled technicians who have the proper tools, equipment, and training to correctly and safely maintain your vehicle. These procedures should not be attempted by “do-it-yourselfers,” and you should not assume this bulletin applies to your vehicle, or that your vehicle has the condition described. To determine whether this information applies, contact an authorized Acura automobile dealer.

TOOL INFORMATION

Tool Name	Tool Number	Quantity
Subframe Adapter	VSB02C000016	1
Ball Joint Thread Protector (12mm)	07AAF-SDAA100	1
Ball Joint Remover (28mm)	07MAC-SL00202	1
Subframe Alignment Pin	070AG-SJAA10S	1

WARRANTY CLAIM INFORMATION

The normal warranty applies.

Operation Number	Description	Flat Rate Time	Defect Code	Symptom Code	Template ID	Failed Part Number
5130A3	Replace the spring seat, spring, and end cap in the EPS gearbox and redistribute the grease to the worm gear (includes VSA relearn, and alignment).	1.7 hr	03001	03225	B24037A	53620-3S5-A04

Skill Level: Repair Technician

REPAIR PROCEDURE

1. Remove the steering gearbox/subframe assembly.

NOTE: **Do not** remove the steering gearbox from the subframe.

- Steps 1–10, *Steering Gearbox Removal and Installation*, ([Click Here](#)).

2. Remove the heat shield.

- *Front Subframe/Steering Gearbox Area* ([Click Here](#))

3. With a clean, damp rag, clean any dirt, mud, or debris around the black cover on the EPS gearbox. While wearing safety glasses, use compressed air to dry the area around the black cover and to remove any debris.

NOTE: Take appropriate steps to ensure that no debris enters the gearbox.

4. Removing the steering motor black cover:

1. Remove the two bolts securing the black cover.
2. Using a plastic trim tool, gently pry the cover to separate it from the EPS gearbox. Slowly work the tool around the bottom edge of the cover to release the cover.

NOTE:

- **Do not** use a screwdriver or metal tool to pry the cover.
- The cover is sealed with an O-ring, which may provide some resistance.

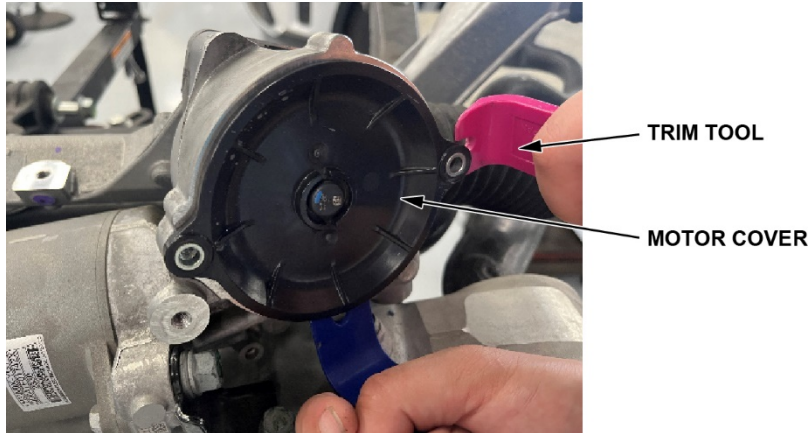

3. Remove the cover.

NOTE: The amount and color of the grease inside the housing may vary from vehicle to vehicle.

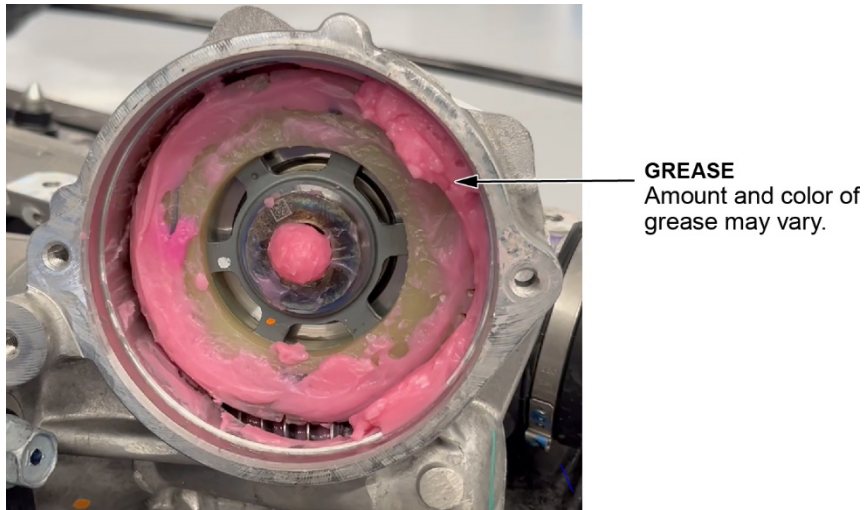

5. Remove the original O-ring from the cover and discard.
6. With a clean cloth, wipe the cover to remove any grease or contamination.

NOTE: **Do not** use brake cleaner to clean the cover.

7. Pack the grease into the worm gear:

NOTE:

- **Do not** add any additional grease.
 - Save a small amount of grease to be used in Steps 8 and 9.
1. While wearing clean gloves, start at the top and run your finger along the nylon gear and aluminum housing while directing the excess grease to the metal worm gear at the lower area of the housing.
 2. Once the excess grease is moved to the lower area of the nylon gear, pack the grease into the worm gear location until the grease fills the gap where the worm gear mates with the nylon gear.

Click here to view the video:



BEFORE



AFTER



8. **Using the extra grease from the previous step**, apply grease between the new replacement end cap, spring, spring seat, and also on top of the spring seat. Protect the assembly from potential contamination by setting it aside in a safe place.

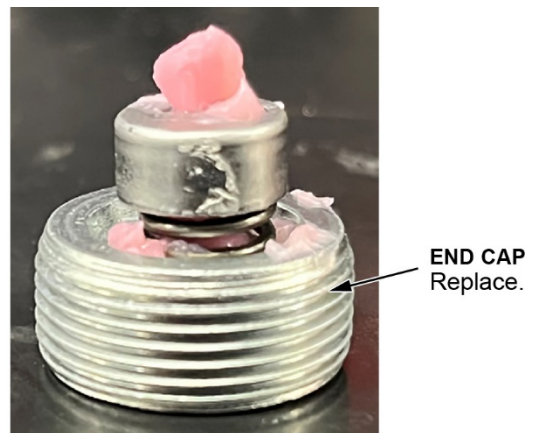
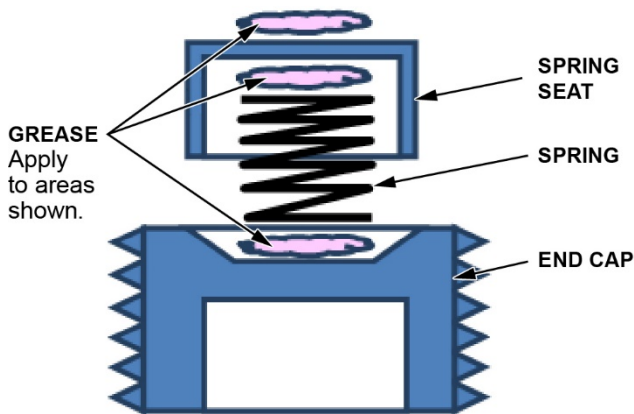

9. Apply grease to the new O-ring.

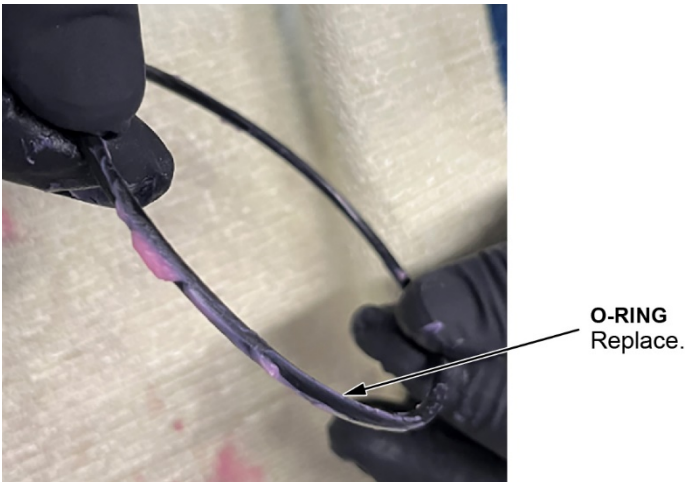

10. Install the new greased O-ring onto the cover.

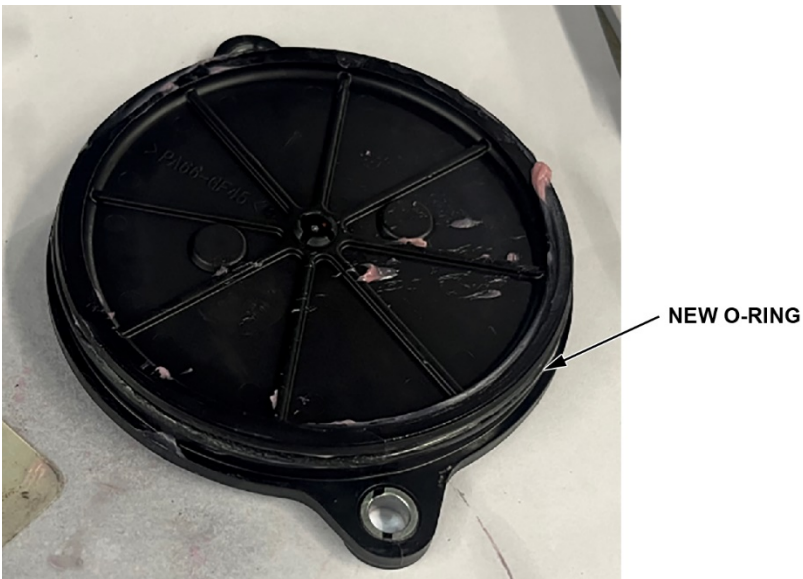

11. Wipe off any excess grease around the EPS aluminum housing.

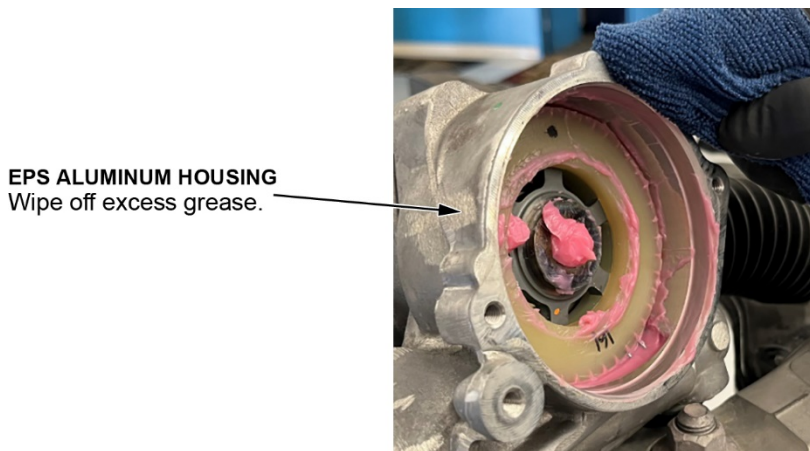

12. Install the steering motor black cover:

- Loosely install the bolts.
- Gently press the cover to set the cover onto the aluminum housing.
- Torque the two bolts to **8 N·m (6 lb-ft)**.



BOLTS
Loosely install.



COVER
Gently press.



TORQUE BOLTS
8 N·m (6 lb-ft)

13. Remove the EPS bracket.



EPS BRACKET

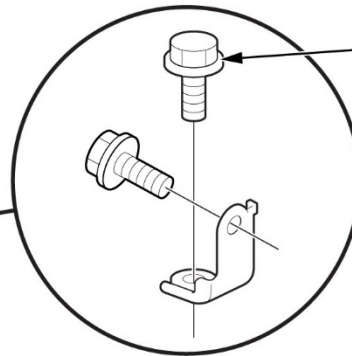

BOLTS (2)
44 N·m (32 lb-ft)

14. Remove the EPS gearbox from the subframe.

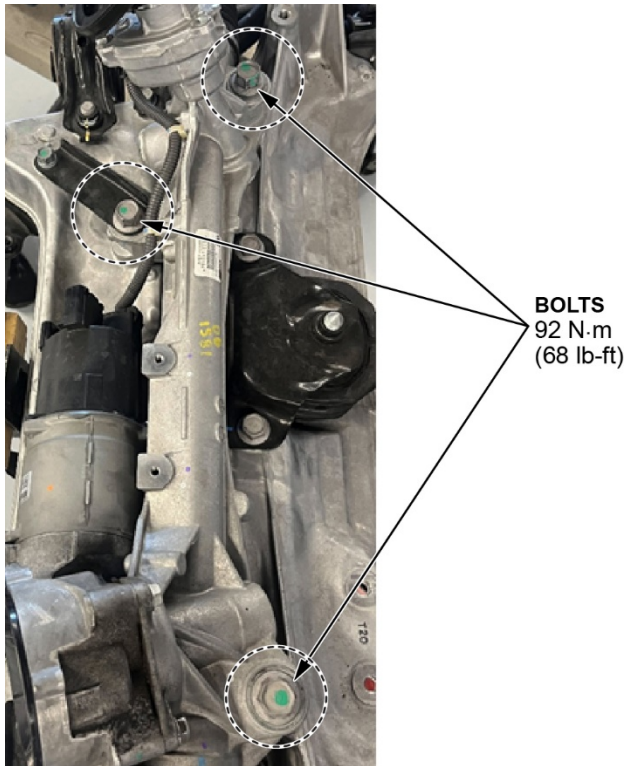

15. Using a wire brush, clean off the exposed sealant around the end cap. Then, use a rag (with brake cleaner) to wipe away any residual loose material.

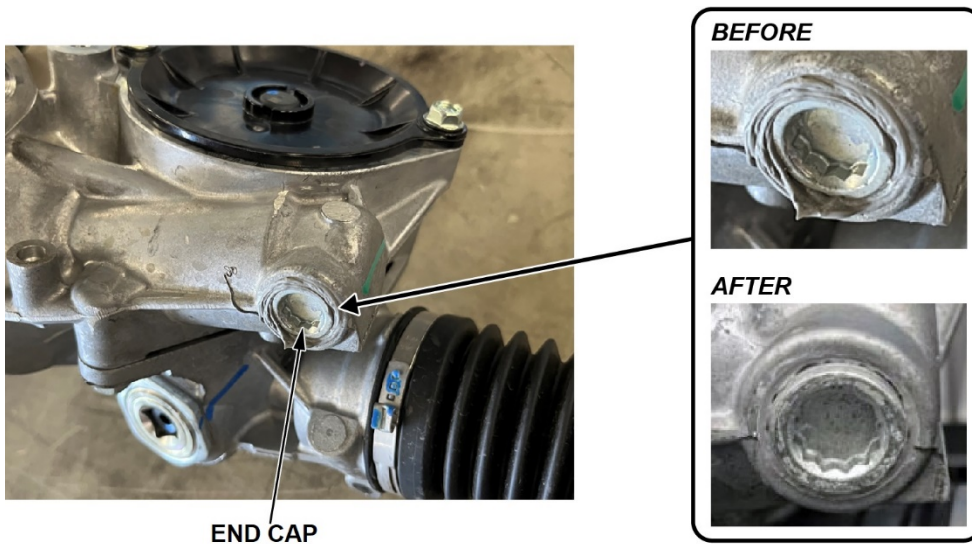

16. With a **10 mm** hex socket bit, remove the end cap on the EPS gearbox.



17. Using a magnet tool, remove the spring from the EPS gearbox and **immediately discard upon removal**.

NOTE: Be careful not to get contamination in the opening.



SPRING
Discard.

18. Using a magnet tool, remove the spring seat from the EPS gearbox and **immediately discard upon removal**.

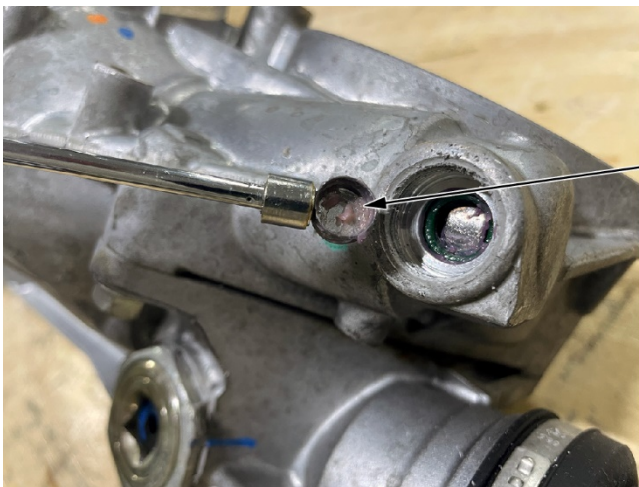

SPRING SEAT
Discard.

19. With the new spring seat, spring, and end cap held together by the grease, install the pieces together into the EPS gearbox, then tighten the end cover plug until **4 mm** of threads remain exposed.

NOTE: To keep the parts from falling off the hex socket bit while installing, rotate the EPS housing until the hole is facing downward, then install the spring seat, spring, and end cap up into the hole.



20. Before torquing, apply Hondabond sealant to the exposed threads of the end cover plug.

HONDABOND



21. Torque the end cap to **12 N·m (9 lb-ft)**, then clean off all excess Hondabond.



END CAP
12 N·m (9 lb-ft)

22. Install all parts in reverse order of removal.
23. Turn the steering wheel full left then full right to ensure smooth operation.
24. Do a wheel alignment.
25. Do the *VSA Sensor Neutral Position Memorization* ([Click Here](#)).