

JLRTB02120NAS2

TECHNICAL BULLETIN

22 MAY 2024



© Jaguar Land Rover North America, LLC

NOTE: The information in Technical Bulletins is intended for use by trained, professional Technicians with the knowledge, tools, and equipment required to do the job properly and safely. It informs these Technicians of conditions that may occur on some vehicles, or provides information that could assist in proper vehicle service. The procedures should not be performed by 'do-it-yourselfers'. If you are not a Retailer, do not assume that a condition described affects your vehicle. Contact an authorized Land Rover service facility to determine whether this bulletin applies to a specific vehicle.

INFORMATION

This reissue replaces all previous versions. Please destroy all previous versions.

This bulletin supersedes TSB JLRTB02120NAS1/2023 dated 14 DEC 2023, which should either be destroyed or clearly marked to show it is no longer valid (e.g. with a line across the page). Only refer to the electronic version of this Technical Bulletin in TOPIx.

Changes are highlighted in blue

SECTION:

501-02

SUBJECT /CONCERN:

Excessive Wind Noise

AFFECTED VEHICLE RANGE:

MODEL:	MODEL YEAR:	VIN:	ASSEMBLY PLANT:
Range Rover (LK)	2022 Onwards	000293 Onwards	Solihull
Range Rover Sport (L1)	2023 Onwards	100000 Onwards	Solihull

MARKETS:

NORTH AMERICA

CONDITION SUMMARY:**SITUATION:**

Excessive wind noise may be heard from the upper A-pillar and door mirror areas when driving the vehicle at speeds of 80 km/h (50 mph) or more.

CAUSE:

Manufactured away from the required specification.

Suggested customer concern code - PB1

ACTION:

Follow the instructions below.

This Technical Bulletin has been updated due to a change to the parts section.

PARTS:**NOTES:**

- RANGE ROVER SPORT ONLY - *An allowance equivalent to £20.00 Sterling has been allocated to locally source 1 meter of 6 mm (width) 3M™ Scotch-Weld 5313 (or an equivalent suitable black butyl strip) and a 300 ml tube of SikaTack OEM+ (or an equivalent suitable polyurethane glazing adhesive)

- RANGE ROVER ONLY - **An allowance equivalent to £30.00 Sterling has been allocated to locally source 2 meters of 6 mm (width) x 1 mm (height) 3M™ Adhesive Tape - PX5011 (or an equivalent suitable double-sided tape), 1 meter of 6 mm (width) 3M™ Scotch-Weld 5313 (or an equivalent suitable black butyl strip), a 300 ml tube of SikaTack OEM+ (or an equivalent suitable polyurethane glazing adhesive) and 2 polyethylene closed-cell Noise, Vibration and Harshness (NVH) pads 35 mm (length) x 20 mm (width) x 8 mm (height) with an adhesive backing

PART NUMBER	DESCRIPTION	QUANTITY
*ZZZ001	RANGE ROVER SPORT ONLY: 3M™ Scotch-Weld 5313, SikaTack OEM+	£20.00
**ZZZ001	RANGE ROVER ONLY: 3M™ adhesive tape - PX5011, 3M™ Scotch-Weld 5313, SikaTack OEM+, 2 polyethylene closed-cell NVH pads	£30.00
523123471	RANGE ROVER ONLY: Right Hand - Baffle Molding Assembly	1
523123472	RANGE ROVER ONLY: Left Hand - Baffle Molding Assembly	1

WARRANTY:

△ NOTE:

* When submitting your Warranty claim within the Warranty portal, use the Condition Code list shown to select the Condition Code which best describes the vehicle defect.

△ NOTES:

- Repair procedures are under constant review, and therefore times are subject to change; those quoted here must be taken as guidance only. Use TOPIx to obtain the latest repair time.
- The JLR claims submission system requires the use of causal part numbers. Labor only claims must show the causal part number with a quantity of zero.

DESCRIPTION	SRO	TIME (HOURS)	CONDITION CODE	CAUSAL PART
RANGE ROVER: JLRTB - Wind Noise Modifications	99.01.83	1.8	*	LR159298 /LR159299
RANGE ROVER SPORT: JLRTB - Wind Noise Modifications	99.01.83	1.4	*	LR159298 /LR159299

NOTE:

Normal Warranty procedures apply.

SERVICE INFORMATION

- Any known faults or evident concerns which could cause a potential wind noise when driving the vehicle, **must** be investigated and rectified before completing this Technical Bulletin.

RANGE ROVER

- SERVICE INSTRUCTIONS 1, 2, 3, 4 and 5 **must** be completed on **both** sides of the vehicle.

RANGE ROVER SPORT

- SERVICE INSTRUCTIONS 2 and 3 **must** be completed on **both** sides of the vehicle.

SERVICE INSTRUCTION 1

RANGE ROVER ONLY

NOTES:

- Some illustrations may vary depending on the vehicle specification, the essential information is always correct.
- Some components may have been removed from the vehicle to provide extra

clarity.

- The left side is shown, the right side is similar.

1. Open the hood.

2.

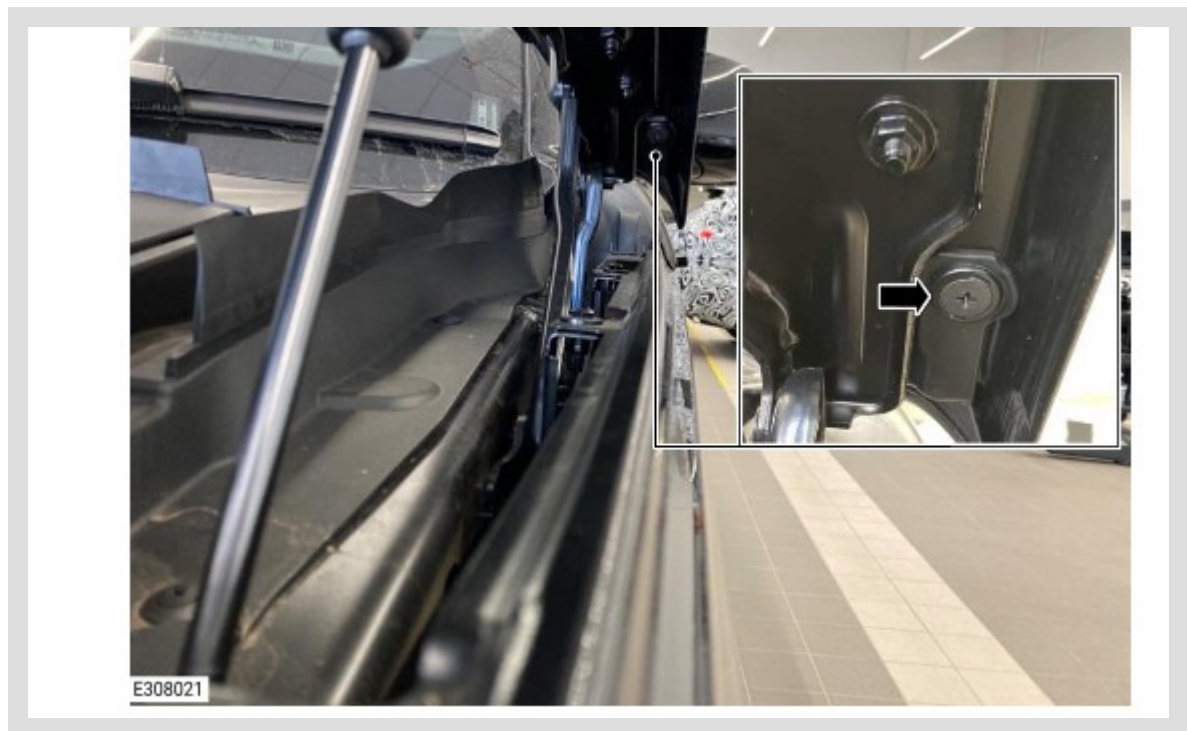

Remove the trim clip.

3.

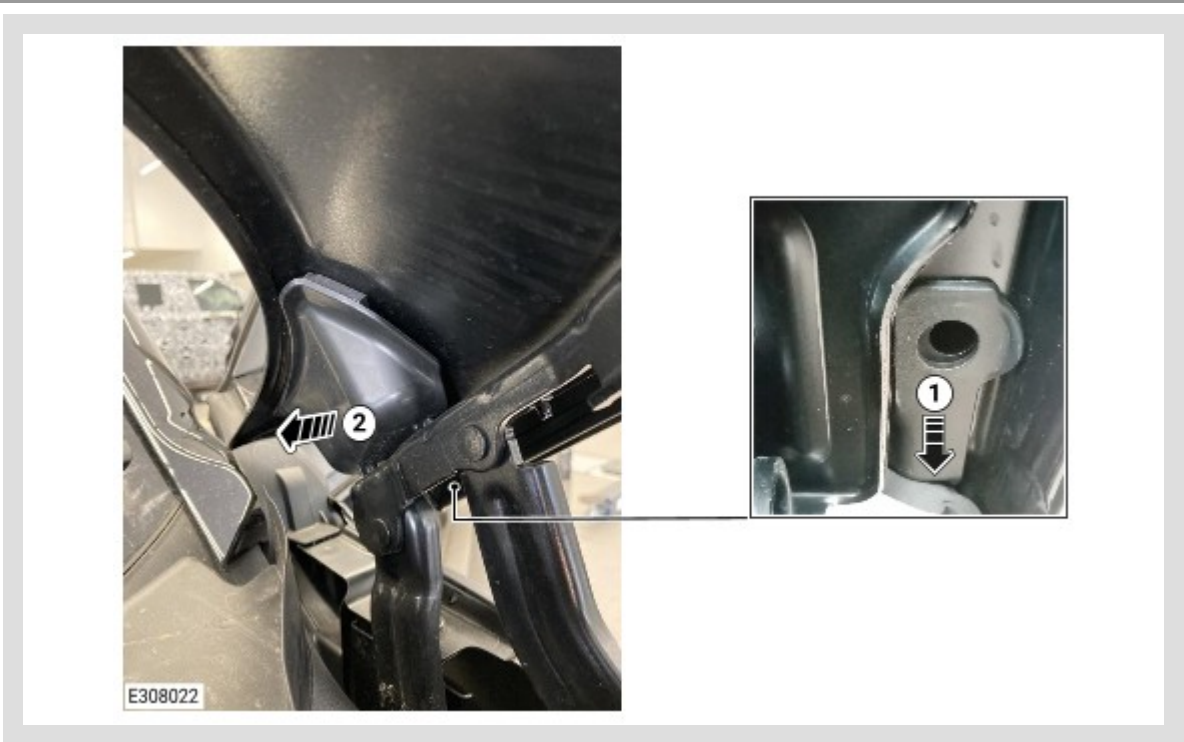

Remove the trim.

1. Slide the trim downward.
2. Slide the trim inward, toward the windshield.

4.

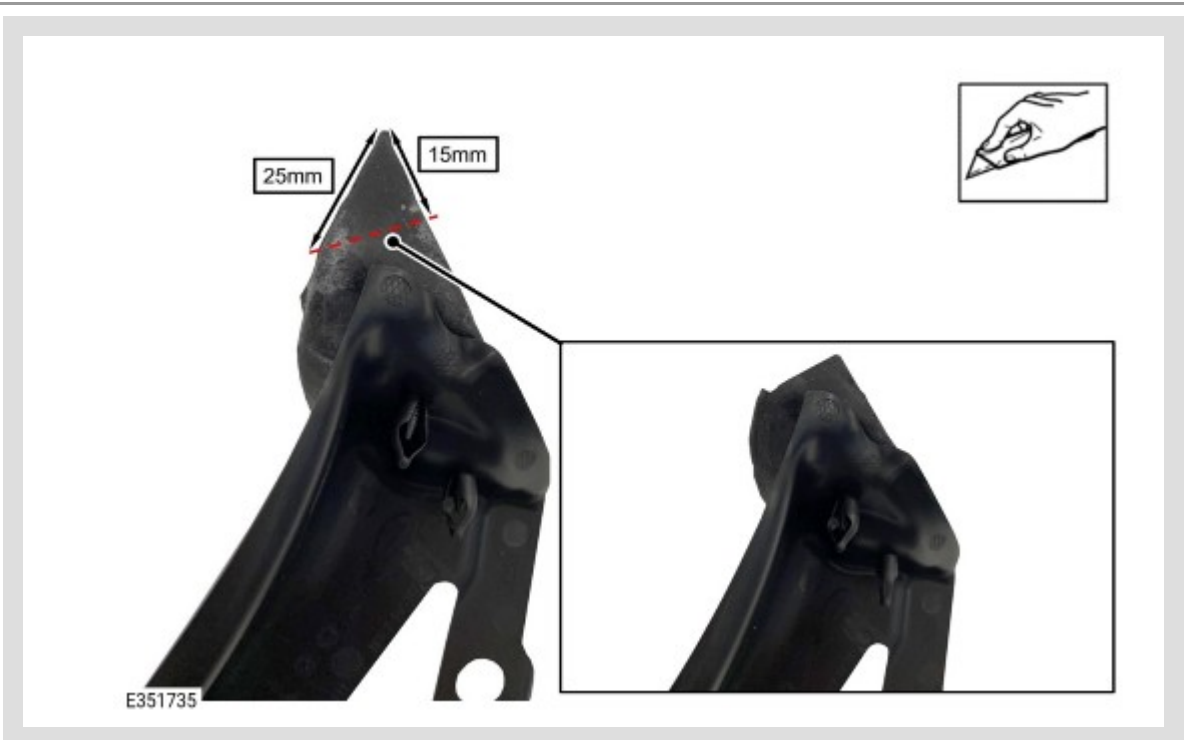

Using the measurements shown as a guide, trim the new NVH molding, as shown in the illustration.

5.



Reverse steps 2 and 3 to install the new NVH molding. Make sure that the NVH molding is correctly positioned as shown in the illustration, before continuing.

6. Complete steps 1 to 5 for the opposite side of the vehicle.

7.



Close the hood.

- With the hood and front doors closed, make sure the NVH moldings are correctly positioned as shown in the illustration, before continuing.

RANGE ROVER AND RANGE ROVER SPORT

NOTES:

- Range Rover shown, Range Rover Sport is similar.
- Some illustrations may vary depending on the vehicle specification, the essential information is always correct.
- Some components may have been removed from the vehicle to provide extra clarity.

1. Remove the front left interior door trim, (see TOPIx Workshop Manual section 501-05: Interior Trim And Ornamentation - Removal and Installation - Front Interior Door Trim).

2.

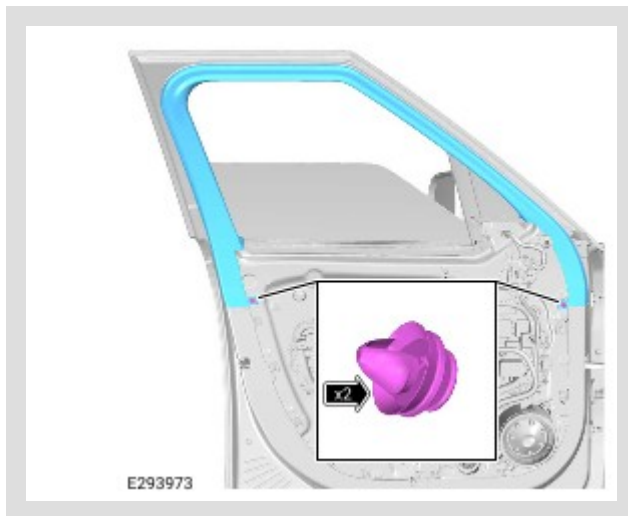

Remove the front left door upper finisher.

3.

 **NOTE:**

Retain the adhesive NVH pad.



Carefully remove the adhesive NVH pad.

4.

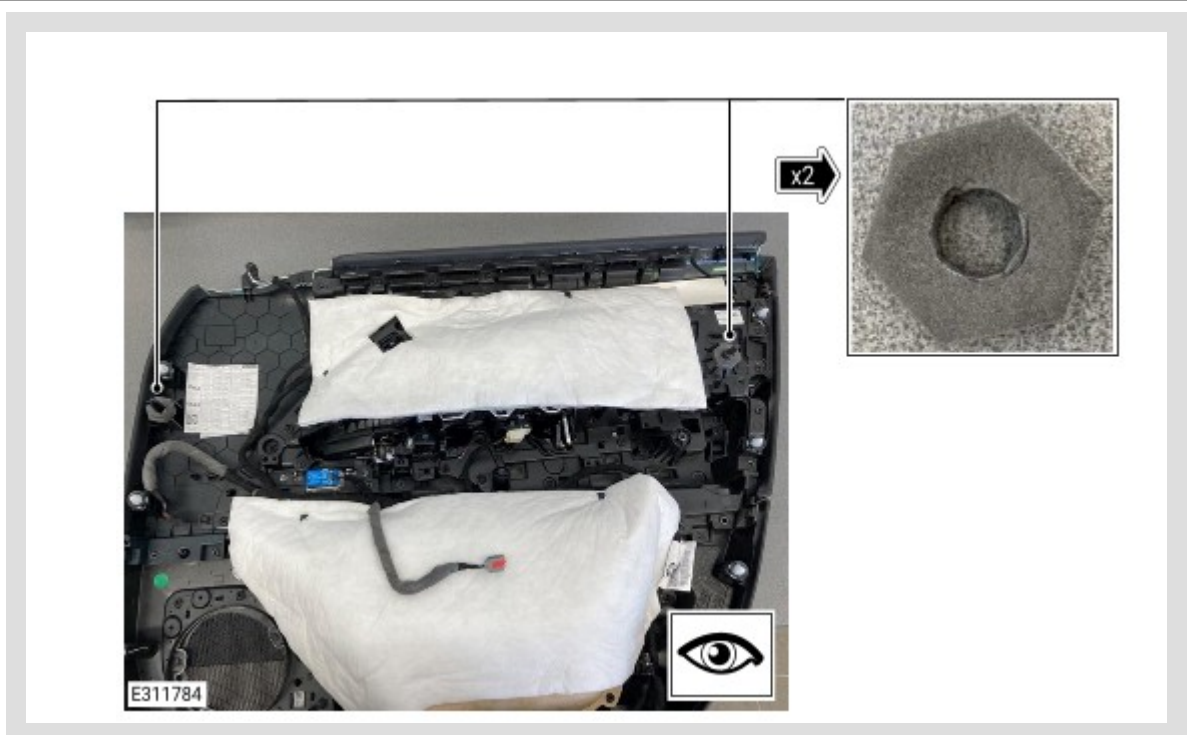

Make sure the 2 front interior door trim NVH pads are installed.

5.



Make sure that any installed wiring harness retainers, fixings, clips, grommets and adhesive patches are all correctly installed to the door before continuing.

6.

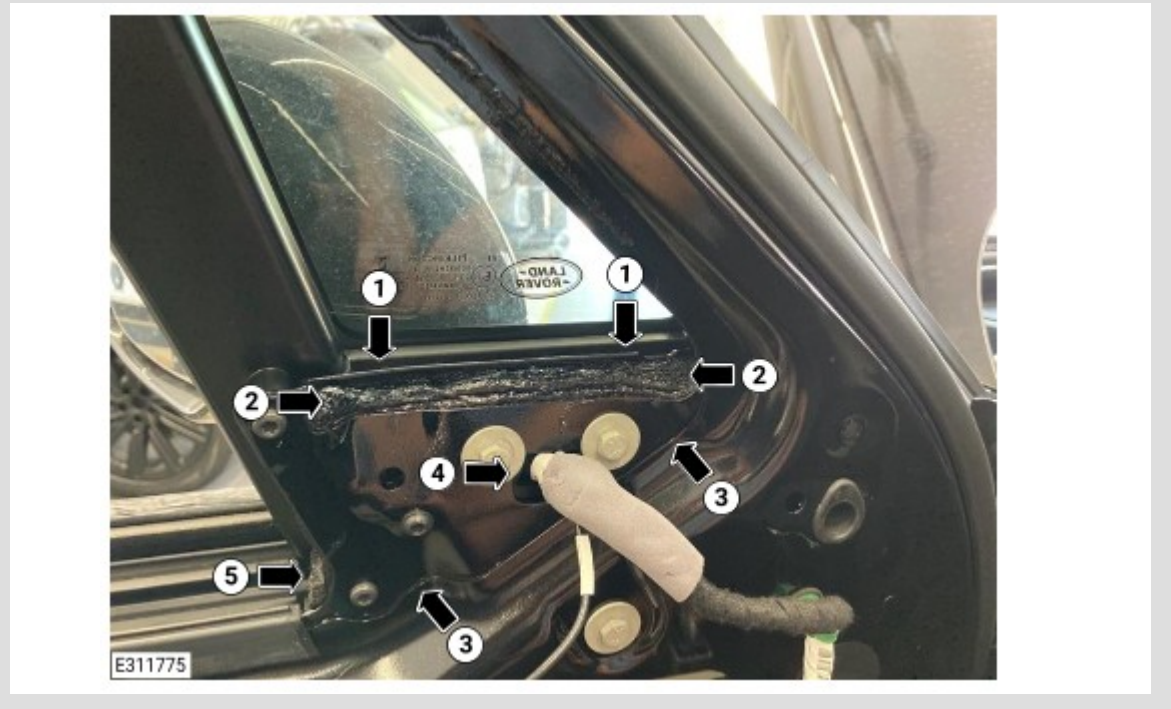

The illustration shows the 5 areas to be reworked during this SERVICE INSTRUCTION.

REWORK 1

7.

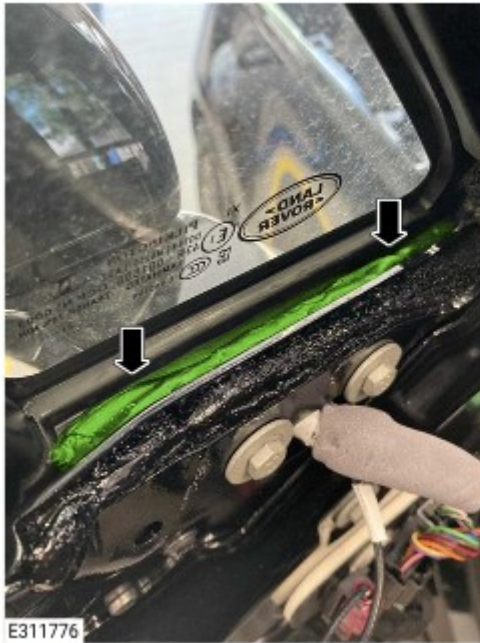

Apply 3M™ Scotch-Weld 5313 (or an equivalent suitable black butyl strip) into the cavity shown. Apply enough butyl to fill the cavity without the butyl covering the top edges of the window seal and body panel.

- Use a finger or thumb to firm down the butyl.

REWORK 2

8.



Inspect the NVH material already applied in the area shown.

- Apply 3M™ Scotch-Weld 5313 (or an equivalent suitable black butyl strip) to fill any cavities which may be present in the area shown.
- Use a finger or thumb to firm down the butyl.

REWORK 3

9.



Mold a piece of 3M™ Scotch-Weld 5313 (or an equivalent suitable black butyl strip) approximately 155 mm in length and 5 mm in width.

10.



Apply the butyl along the body panel seam, as shown in the illustration.

- Use a finger or thumb to firm down the butyl.

REWORK 4

11.

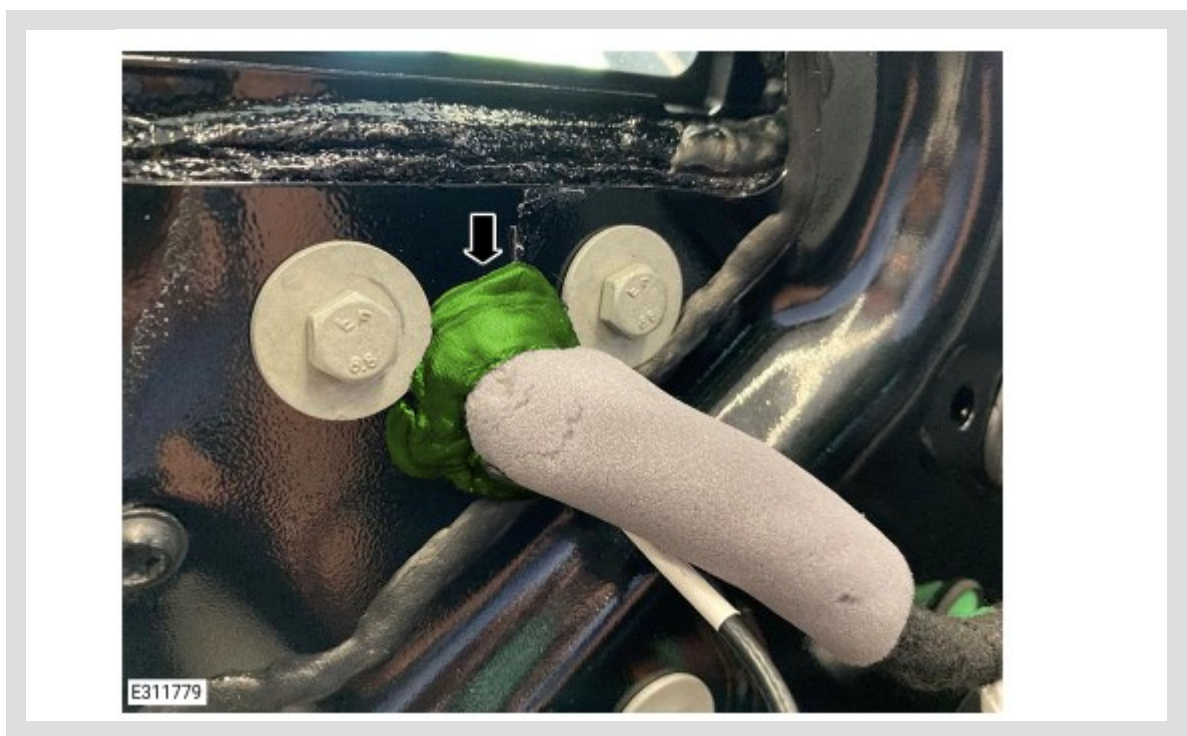

Apply 3M™ Scotch-Weld 5313 (or an equivalent suitable black butyl strip) around the wiring harness, as shown in the illustration. The butyl must fully seal the hole within the body panel.

- Use a finger or thumb to firm down the butyl.

REWORK 5

12.



Locate the NVH material already applied in the area shown.

13.

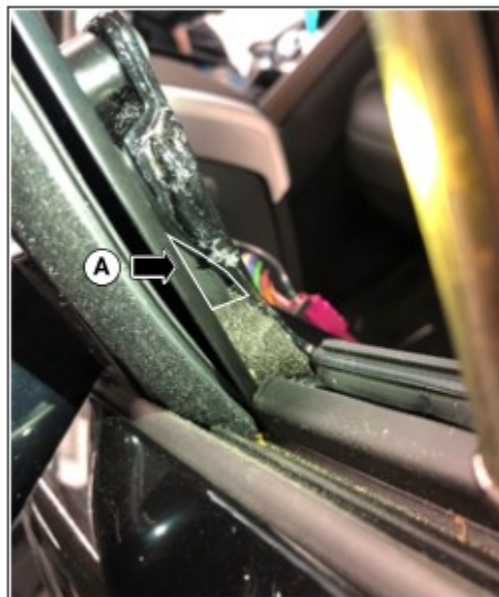

Apply 3M™ Scotch-Weld 5313 (or an equivalent suitable black butyl strip) to fill the small cavity marked 'A' in the illustration, directly above the NVH material already applied.

14.

Reverse steps 1 to 3.

15. Complete steps 1 to 14 for the opposite side of the vehicle.

SERVICE INSTRUCTION 3

RANGE ROVER AND RANGE ROVER SPORT

△ NOTES:

- Range Rover shown, Range Rover Sport is similar.
- Some illustrations may vary depending on the vehicle specification, the essential information is always correct.
- Some components may have been removed from the vehicle to provide extra clarity.

1. Lower the front left window.

2.



Reposition the front door window seal, as shown in the illustration.

3.

⚠ WARNING:

Always follow the manufacturer's instructions.



Use SikaTack OEM+ (or an equivalent suitable polyurethane glazing adhesive) to seal the front window seal.

1. Apply a suitable masking tape to the area shown in the illustration.
2. Apply a bead of sealant within the front window seal, as shown in the illustration.
3. Apply a bead of sealant to the area shown in the illustration, making sure to fill any cavities present.

4. Reverse steps 1 to 3.

- Remove any residue caused by the masking tape.

5.

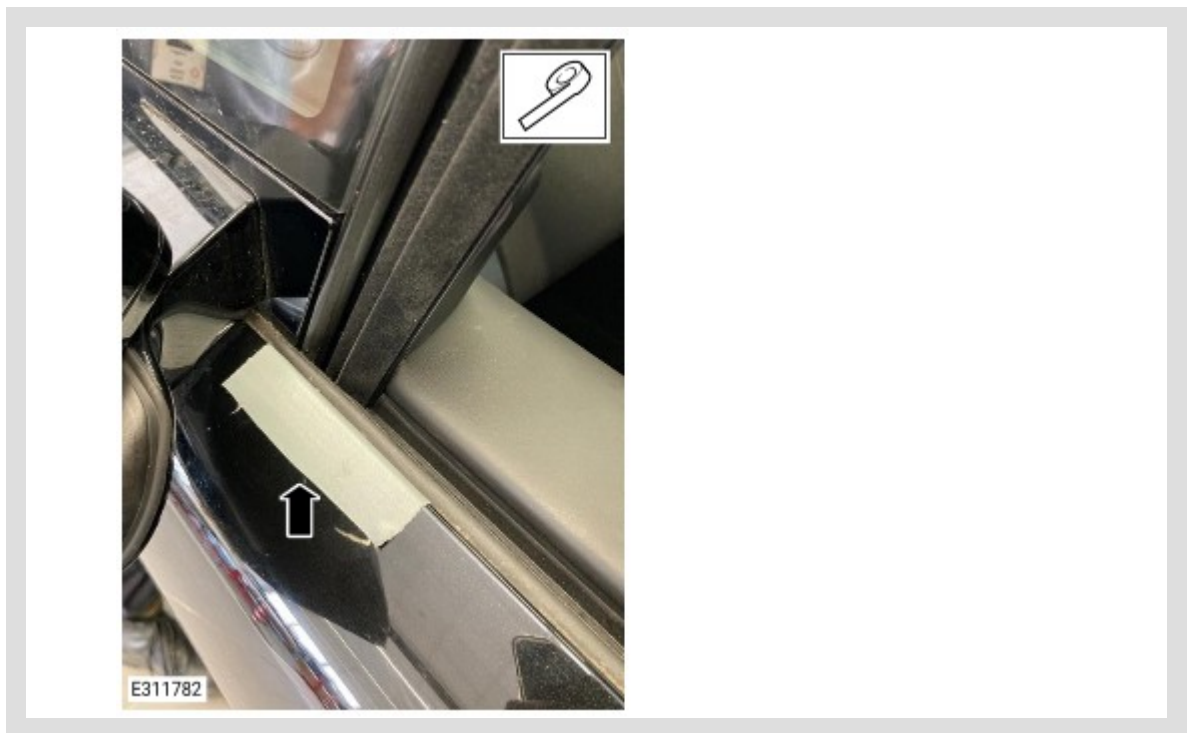

Apply a suitable masking tape to the upper area of the front door, as shown in the illustration.

6.

⚠ CAUTION:

The cut must be made in line with the front door glass.

△ NOTE:

If required, raise the window slightly to aid with this step.



Using a suitable tool, cut through the front door outer waist seal, as shown in the illustration.

- Remove the masking tape.
- Remove any residue caused by the masking tape.

7. Complete steps 1 to 6 for the opposite side of the vehicle.

SERVICE INSTRUCTION 4

RANGE ROVER ONLY

△ NOTES:

- Some illustrations may vary depending on the vehicle specification, the essential information is always correct.

- Some components may have been removed from the vehicle to provide extra clarity.

1. Open the hood.

2. Open the front left door.

3.

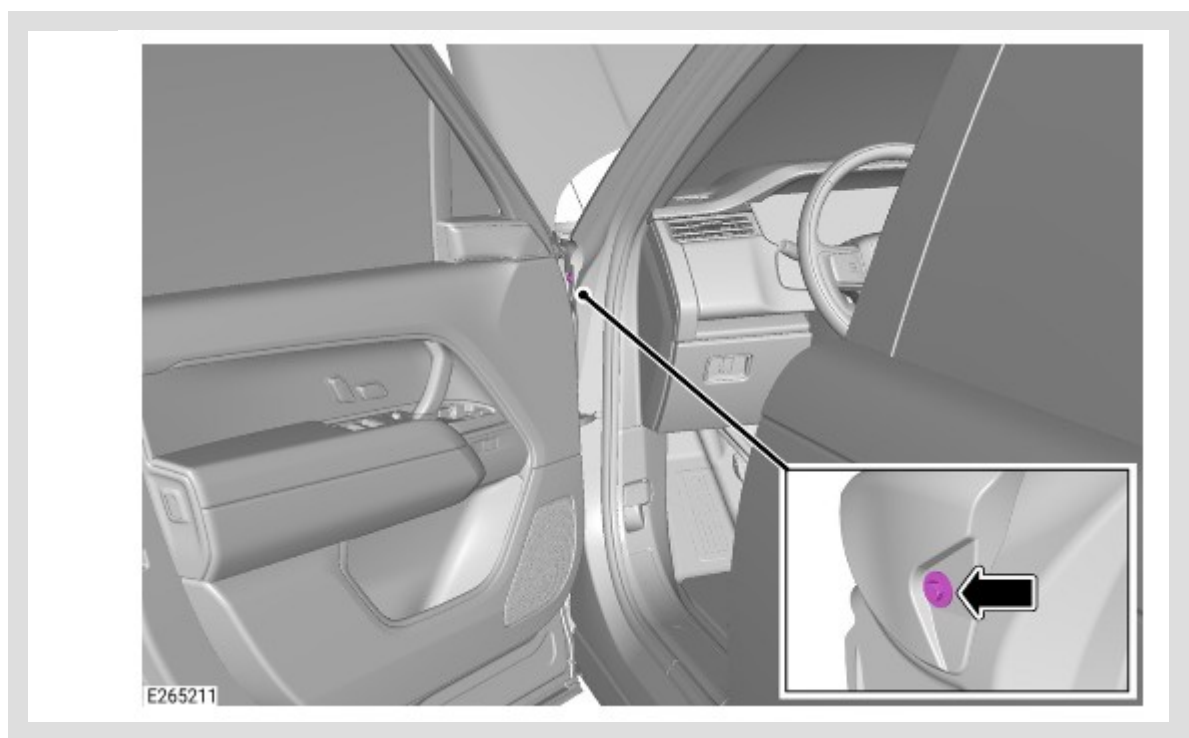

Remove the bolt.

ⓘ CAUTIONS:

- Before removing the a-pillar molding, make sure the surrounding area is clean and dry.
- Before removing the a-pillar molding, make sure the a-pillar molding is clean and dry.
- Do not use tools during this operation, removal of the a-pillar molding must be completed by hand.

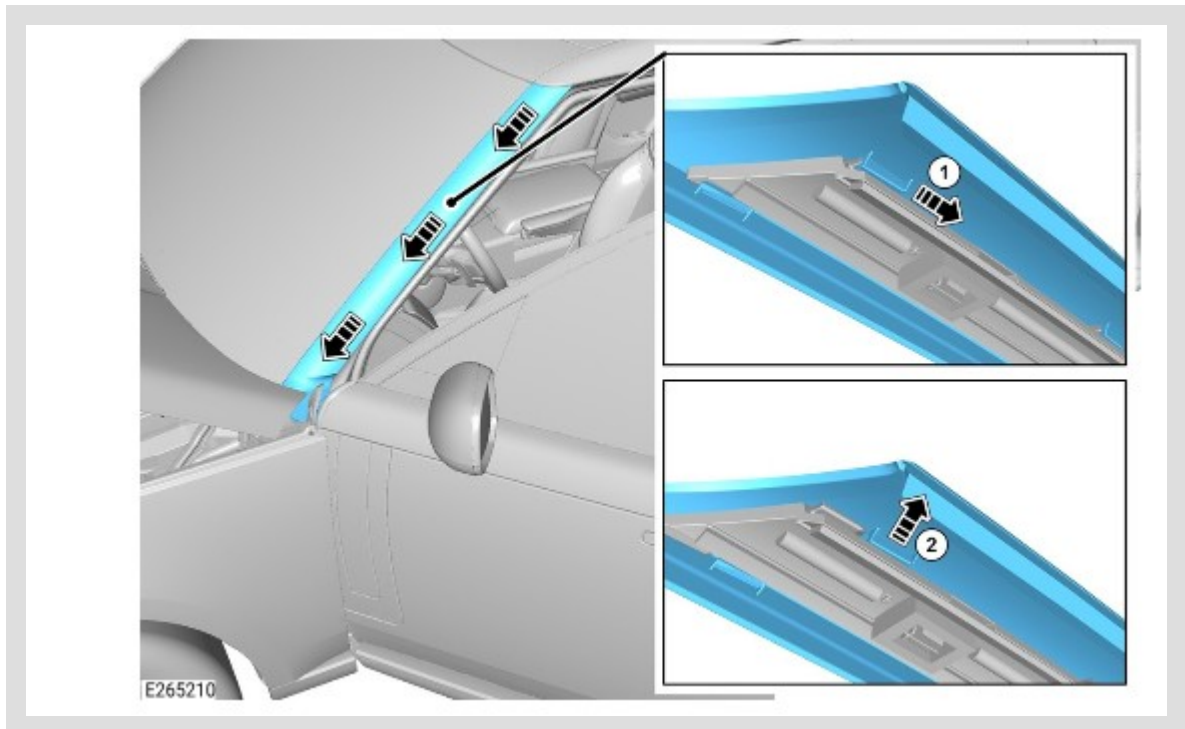

Remove the a-pillar molding by pushing with both hands and sliding down.

5.

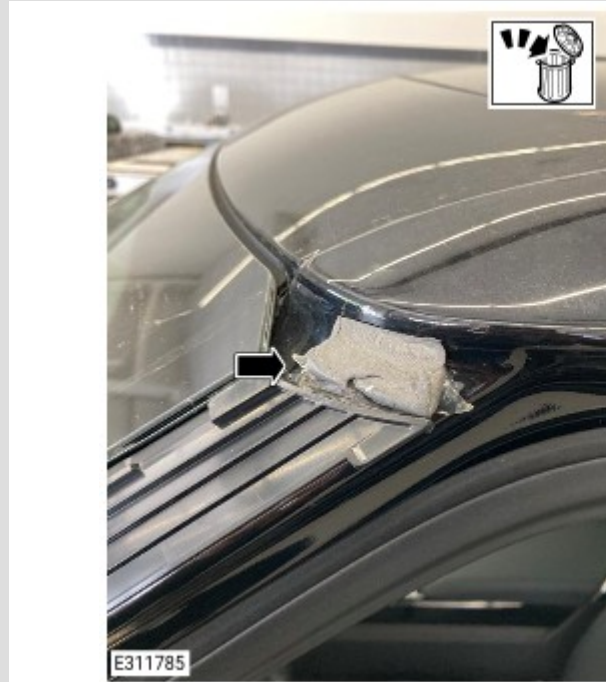

Remove and discard the NVH pad at the top of the a-pillar.

- Clean the surrounding area.

6.

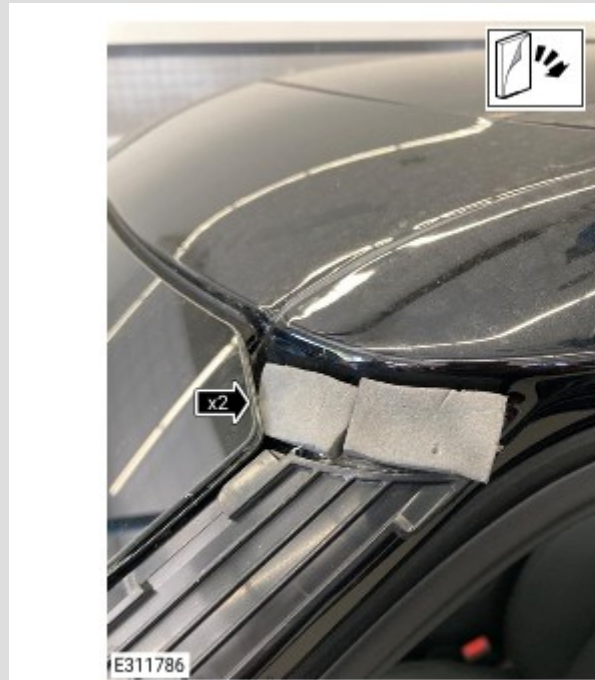

Install the new polyethylene closed-cell foam NVH pads at the top of the a-pillar.

7.



Place the a-pillar molding onto a suitable flat surface and locate the foam NVH pad which is applied across the length of the a-pillar molding.

8.



E311788

Apply 3M™ Adhesive Tape - PX5011 (or an equivalent suitable double-sided tape) on top of the foam NVH pad. Leave a minimum of 30 mm excess backing exposed at the top of the a-pillar molding, as shown in the illustration.

9.

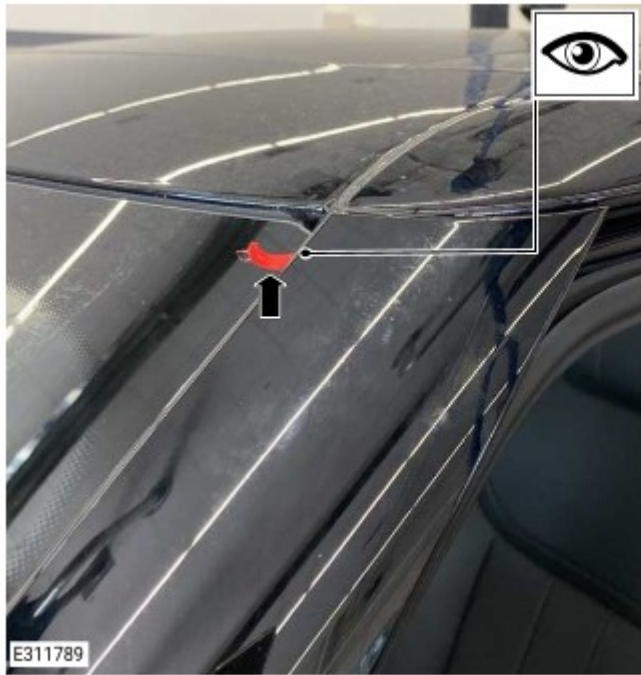

When completing step 9 below, make sure the 30 mm excess backing is positioned as shown in the illustration. This will allow the backing to be removed from the a-pillar molding after the a-pillar molding is installed.

ⓘ CAUTIONS:

- Make sure the front edge to the windshield has a consistent gap and that the air deflector is seated correctly.
- Do not use tools during this operation, installation of the a-pillar molding must be completed by hand.
- Make sure all fixing tabs are correctly located.

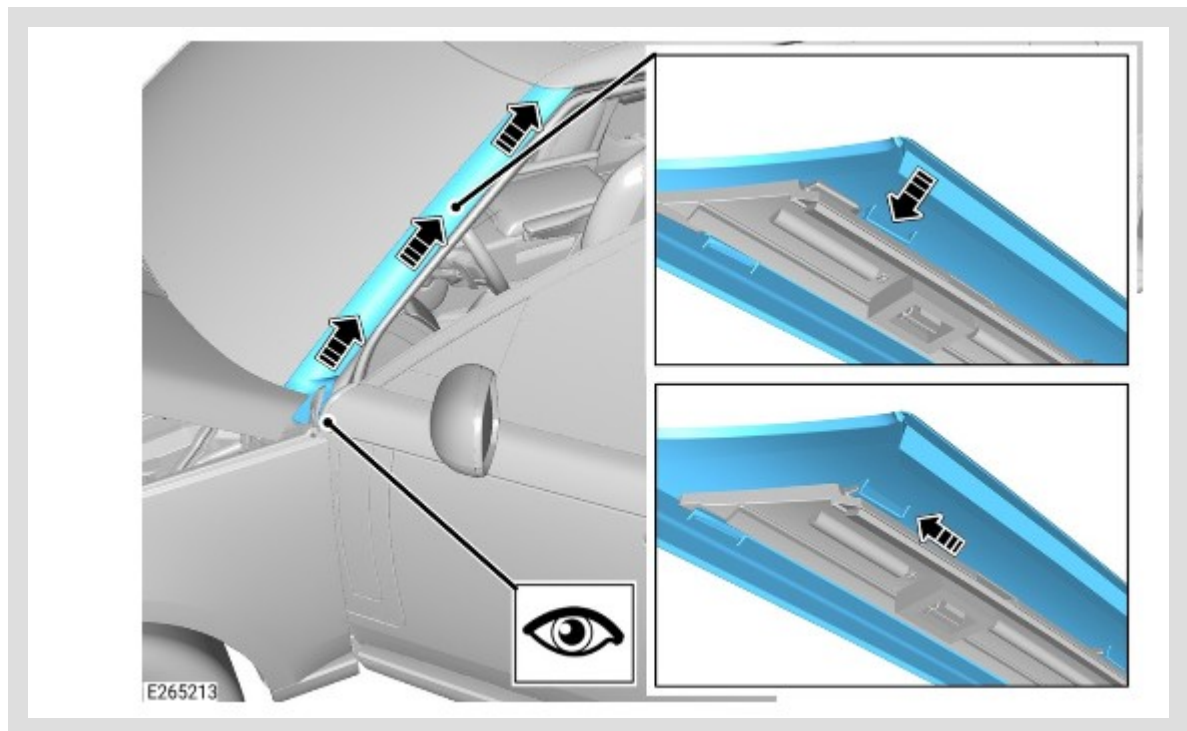

Install the a-pillar molding by pushing with both hands and sliding up.

⚠ CAUTION:

Make sure to pull downward when removing the backing from the double-sided tape.



E311790

Carefully and very slowly, remove the backing from the double-sided tape.

12.

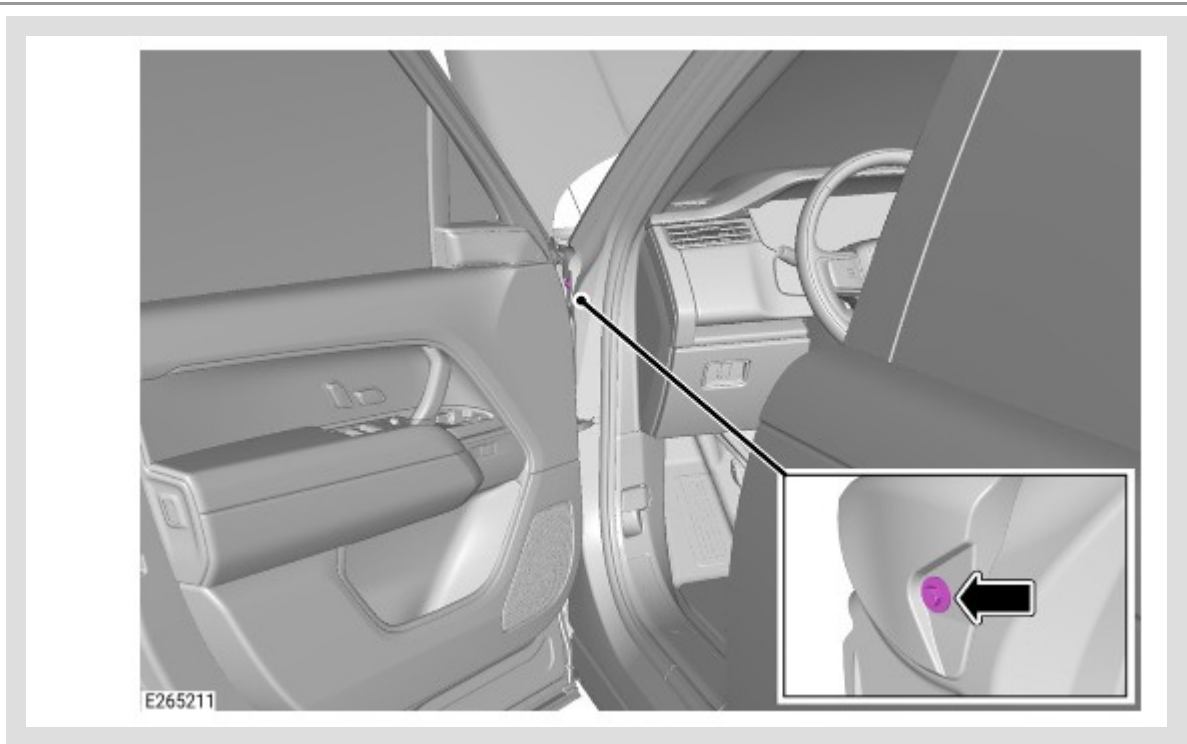

Install the bolt.

- Torque: 1.3 Nm

13. Close the front left door.

14. Complete steps 2 to 13 for the opposite side of the vehicle.

15. Close the hood.

SERVICE INSTRUCTION 5

RANGE ROVER ONLY

△ NOTES:

- Some illustrations may vary depending on the vehicle specification, the essential information is always correct.
- Some components may have been removed from the vehicle to provide extra clarity.

1. Open the rear left door.

2.

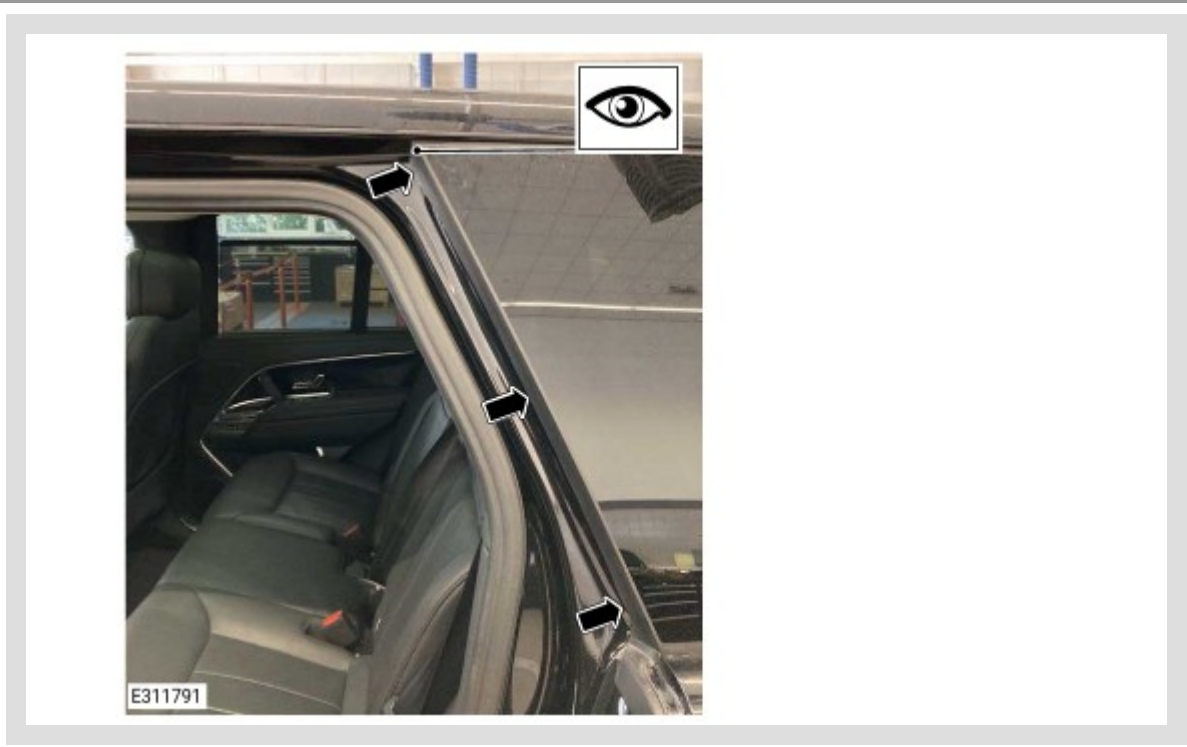

Locate the rear quarter window seal.

3.



E311989

Apply a suitable masking tape to the rear quarter window seal. Make sure the window seal can still be lifted.

⚠ WARNING:

Always follow the manufacturer's instructions.



E311990

Using the aid of another technician, apply approximately 75 ml of SikaTack OEM+ (or an equivalent suitable polyurethane glazing adhesive) along the cavity behind the window seal.

⚠ NOTE:

Use a suitable trim tool to assist in lifting the window seal.

Insert the applicator at the top of the window seal and seal the hole in the area marked 'A' in the illustration.

2. While applying the sealant, move the applicator downward behind the window seal, to the bottom of the window seal.

5.



E311991

Use a finger or thumb to firm down the window seal.

- Remove the masking tape.
- Remove any residue caused by the masking tape.

6. Close the rear left door.

7. Complete steps 1 to 6 for the opposite side of the vehicle.