



**TEMSA**

# SERVICE BULLETIN

Subject: New Decals Location in Engine Room      Bulletin Type:      Field Fix Conditional

---

Bulletin No: TS35-FC-2401

PQR No: 500000007290

---

Rev No: 00

Ref. No: 700004414

---

Vehicle Model: TS 35

Flat Rate Time / Code: 105 min

---

Date of issue: 23.01.2024

Modify Before: 23.01.2025

---

What to do with off coming parts:

- Scrap
- Return
- Use with additional parts
- On consignment
- No off coming parts

What to do with outstanding parts of previous revision:

- Scrap
  - Return
  - Use with additional parts
  - On consignment
  - No outstanding parts
- 

Description of the modification:

Belt guard was phased out. So, decals which were located on the belt guard moved to a new location.

---

Bulletin Responsible: Musa Akalın

Published & Approved By: Cihan Yaycioğlu

---



**TEMSA**

# SERVICE BULLETIN

## SAFETY INSTRUCTIONS

### 1. Mechanical Requested Dress Code



#### WARNING:

- Dress properly to avoid personal injury and damage to the vehicle

- ✓ Always wear protective clothing
- ✓ Do not wear any worn or loose-fitting clothing
- ✓ Remove jewelry before starting to work
- ✓ In case of long hair, use hairnet
- ✓ The illustration on the left shows some of the correct and incorrect clothing
- ✓ Sharp edged items should be avoided in order not to scratch vehicle (i.e. belts, watches, necklace)

### 2. Protect Seats when Mechanic Starts Working

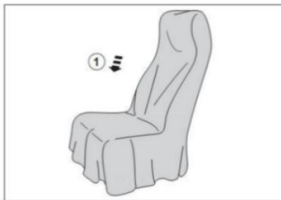

- ✓ Seats, trimming, upholstery stuff and carpeting should be protected with appropriate coverings.

### 3. Welding on the Chassis





- Always disconnect the batteries (starting with the negative lead).
- Disconnect the connectors of electrical and electronic equipment (electronic control units, sensors and actuators) if they are less than 2 meters away from the chassis part to be welded or the earth terminal of the welding equipment.
- The earth terminal should never be attached to vehicle components such as engine, axles and springs. Arcing on these parts is not permitted, because of the risk of damage to bearings, springs, etc.
- The earth terminal must make good contact and be placed as close as possible to the part to be welded.
- Plastic pipes, rubber parts and parabolic springs should be well protected against welding spatter and temperatures higher than 70°.
- The contact switch must not be in the accessory or contact position. The contact key should be removed.
- Reconnect in reversed order of disconnecting. Ensure that a good earth connection is made between chassis, engine and cab.



TEMSA

# SERVICE BULLETIN





## INCLUDED PARTS LIST

No	Part No	Part Name	Picture	Qty	Unit of Measure
1	9325-7301Y	PANEL, LABEL		1	Piece
2	MF140005Y	BOLT,HEX,FLANGE (M6X0.9X16 4T) K:5.8		2	Pieces
3	9050-314Y	LABEL(DRIVE AXLE SHAFT WARNING)		1	Piece
4	9050-315Y	LABEL(USE REFRIGERANT R-134a ONLY)		1	Piece
5	9050-1044Y	LABEL, TRANSMISSION, ENG-FRE		1	Piece
6	9050-302Y	LABEL(OIL STICK AREA)(ENG-SPA)		1	Piece
7	9050-298Y	LABEL,ENGINE LID WARNING (ENG-SPA)		1	Piece

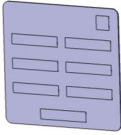

TEMESA

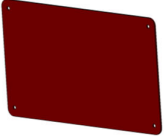
# SERVICE BULLETIN

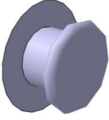
No	Part No	Part Name	Picture	Qty	Unit of Measure
8	9050-264Y	TS30E,TS35E,TS45 ISX12 LUB. LABEL		1	Piece
9	9050-313Y	LABEL(DONT LEAVE RAGS IN ENGINE BAY)		1	Piece
10	9050-300Y	LABEL (ENGINE COMPARTMENT WARNING)		1	Piece
11	9050-633Y	LABEL, BELT TS35		1	Piece
12	9050-1073Y	LABEL, COOLANT FILLING INSTRUCTION		1	Piece
13	TC395107Y	RIVET,BLIND (2.4X6)		28	Pieces



**TEMSA**

# SERVICE BULLETIN

## TECHNICAL INSTRUCTIONS

1- Open the engine cover. (See Figure-1).

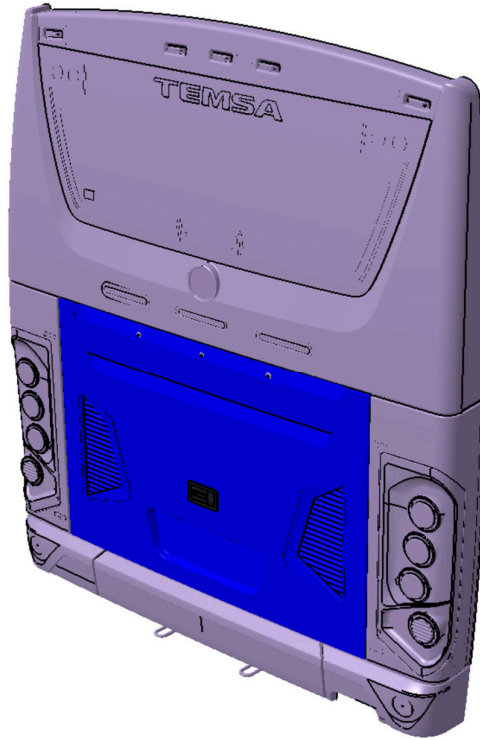

**Figure-1**

2- Mount the label numbered 9050-314Y on the rear bumper with TC395107Y (See Figure-2).

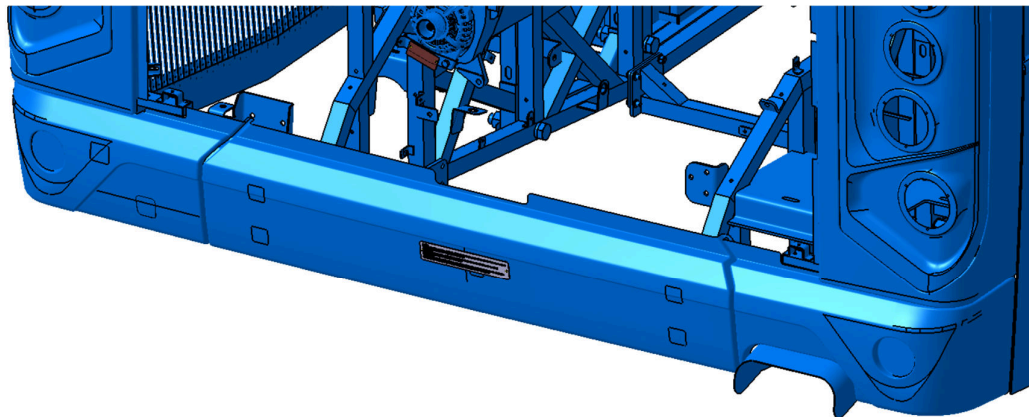

**Figure-2**



**TEMSA**

# SERVICE BULLETIN

3- Mount the label numbered 9050-1044Y on the oil filling bracket with TC395107Y  
(See Figure-3).

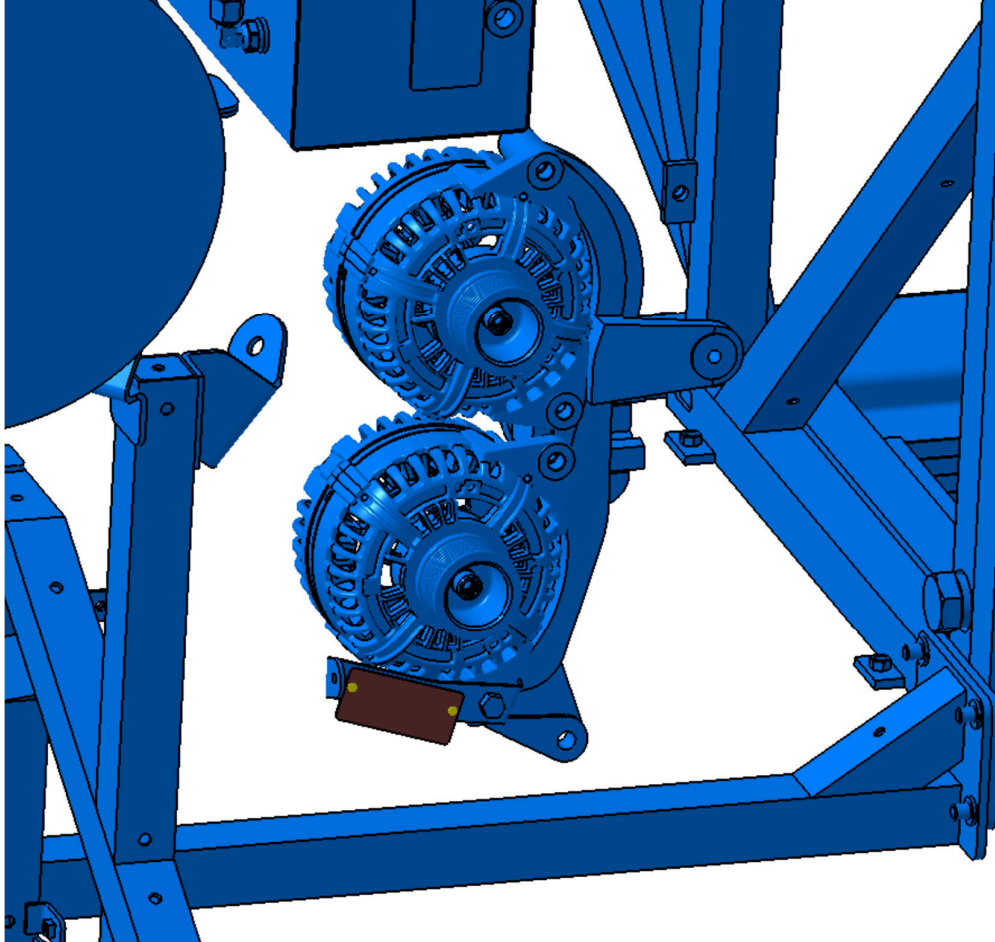

Figure-3



TEMESA

# SERVICE BULLETIN

4- Mount labels shown in the picture below on the panel numbered 9325-7425Y with TC395107Y. (See Figure-4).

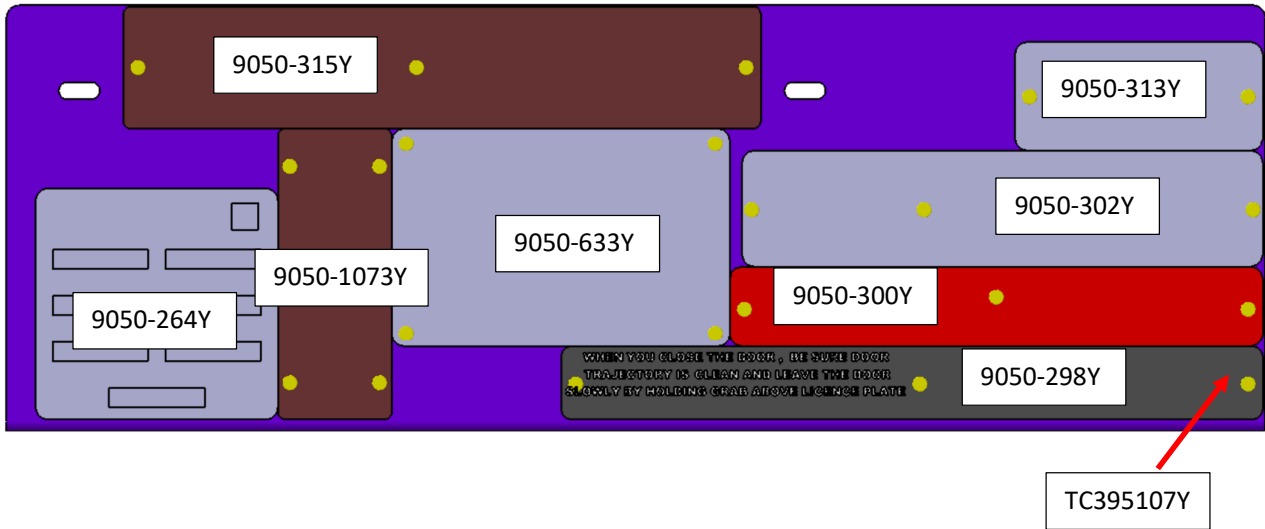

Figure-4

5- Mount the label panel numbered 9325-7301Y on the vehicle. (MF140005Y 2pc) (See Figure-5).

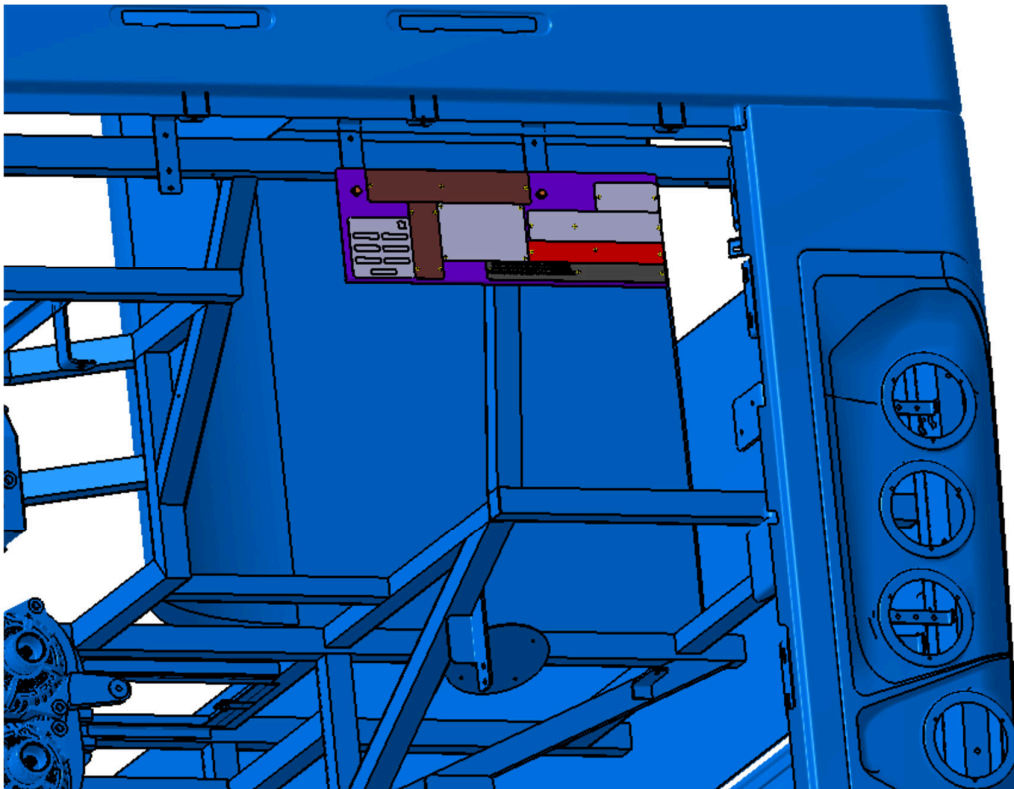

Figure-5



**TEMESA**

# SERVICE BULLETIN

## LABOR BREAKDOWN

<b>Application</b>	<b>Time</b>
Open engine cover	5'
Mounting labels on the vehicle	20'
Mounting labels on the panel	60'
Mounting label on the vehicle	20'
<b>Total Labor Time</b>	<b>105'</b>