

TO: Freightliner Dealer Principals, General Managers, Service Managers, Parts Managers	FROM: Anthony Washington, Senior Manager, Regulations and Certifications
Re: Launch Recall Campaign Notification Model 907 Sprinter Model Years 2019-2021 Inspect Frame Reinforcement	DATE: February, 2024



IMPORTANT RECALL CAMPAIGN INFORMATION

Please see the attached documents related to the campaign listed above.

Campaign No. :	Campaign Desc. :	Inspect Frame Reinforcement
2024010007	VS3ROHRAH	
<p>This is to notify you of a Recall Campaign to inspect the Frame Reinforcement on approximately 130 MY 2019-2021 Freightliner Sprinter Vans. The recall campaign will be visible on the www.safercar.gov website and may generate questions from customers. All affected VINs will be flagged as "OPEN" in VMI and cannot be sold.</p>		
Background		
Issue	<p>Mercedes-Benz AG ("MBAG"), the manufacturer of Freightliner Sprinter Vans, has determined that on certain Sprinter (907 platform) vehicles, the longitudinal frame members of the body-in-white might not meet specifications. Missing reinforcements might lead to damage in the rear area of the longitudinal frame members. Over time, impairment of driving stability cannot be ruled out. In addition, vehicles equipped with a bench seat in the 3rd passenger seat row, could experience a failure of the seat mountings in the event of a crash. In this case, the risk of injury would increase.</p>	
What We're Doing	<p>DVUSA will conduct a voluntary recall. As a precautionary measure, an authorized Freightliner Sprinter dealer will check the longitudinal frame members on the affected vehicles and rework them, if necessary.</p>	
Parts	<p>Parts are available and can be ordered as necessary.</p>	
Vehicles Affected		
Vehicle Model Year(s)	2019-2021	
Vehicle Model	Sprinter	
Vehicle Populations		
Population	130	
Dealer Inventory	0	
<p>Given this notice, it is <u>a violation of Federal law</u> for a dealer to sell or lease any <u>new</u> Sprinter vehicles in dealer inventory covered by this notification until the vehicle has been repaired.</p> <p style="text-align: center;">Loaner and demonstrator vehicles may continue to be driven, but must not be retailed until repaired.</p> <p>Additionally, given this notice, it is <u>a violation of Federal Law for rental companies to rent</u> new Sprinter vehicles covered by this notification until the vehicle has been repaired.</p>		
Next Steps/Notes		
Customer Notification Timeline	An owner notification letter to be mailed in March, 2024.	
AOMS/SOMS	AOMs – This recall may generate questions from your dealers. Please forward this notice to your dealers ASAP.	
Rental Fleet Partners	This recall may affect vehicles in your fleet. Please contact your respective DVUSA fleet representative for further information and next steps. For repairs, please contact your preferred DVUSA dealer.	
<p>While we regret any inconvenience this may cause, we are determined to maintain a high level of vehicle quality and customer satisfaction.</p>		

Model 907.6##/7## #T
with code V40 (Crew cab floor assy)

Operation no. of the operation texts or standard texts and flat rates

Category	Op. no.	Operation text	Time	Damage Code	Codeword
L	12 1609	Operations: Subsequently reinforce 2 longitudinal frame members	14.3 hrs	3190304	VS3ROHRAH

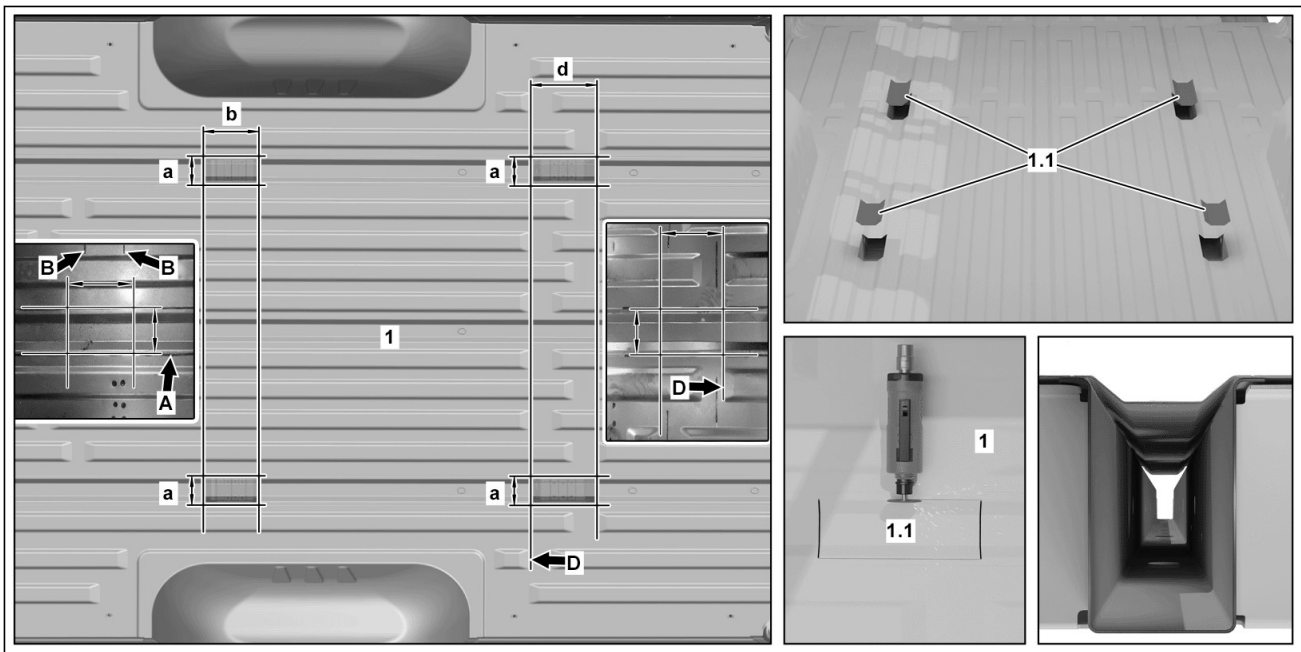

D61.25-A014-79

- | | | | |
|-----|----------------------------|---|-----------------------------|
| 1 | Vehicle floor | a | Dimension (width of crease) |
| 1.1 | Sections | b | Dimension (approx. 120 mm) |
| 01 | Welding protection blanket | d | Dimension (approx. 190 mm) |

c Dimension (approx. 565 mm)

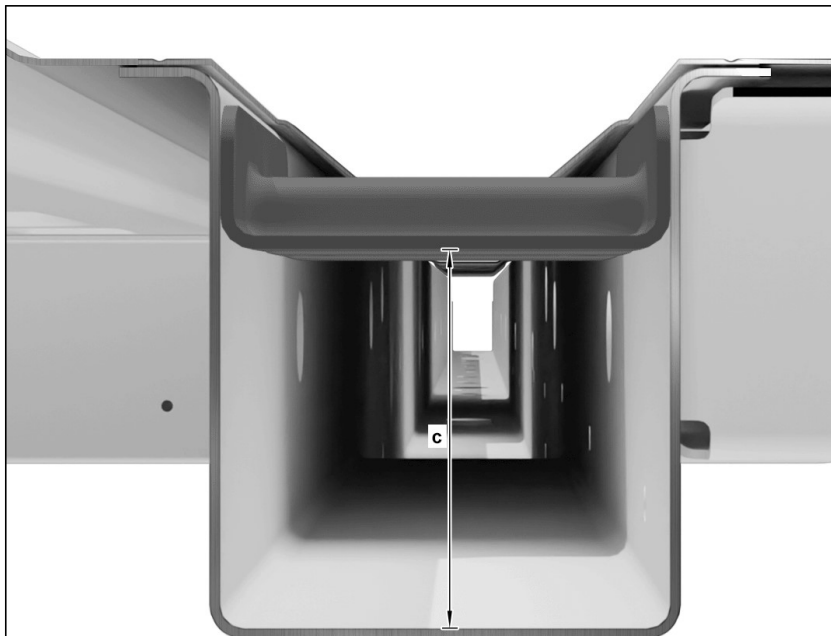



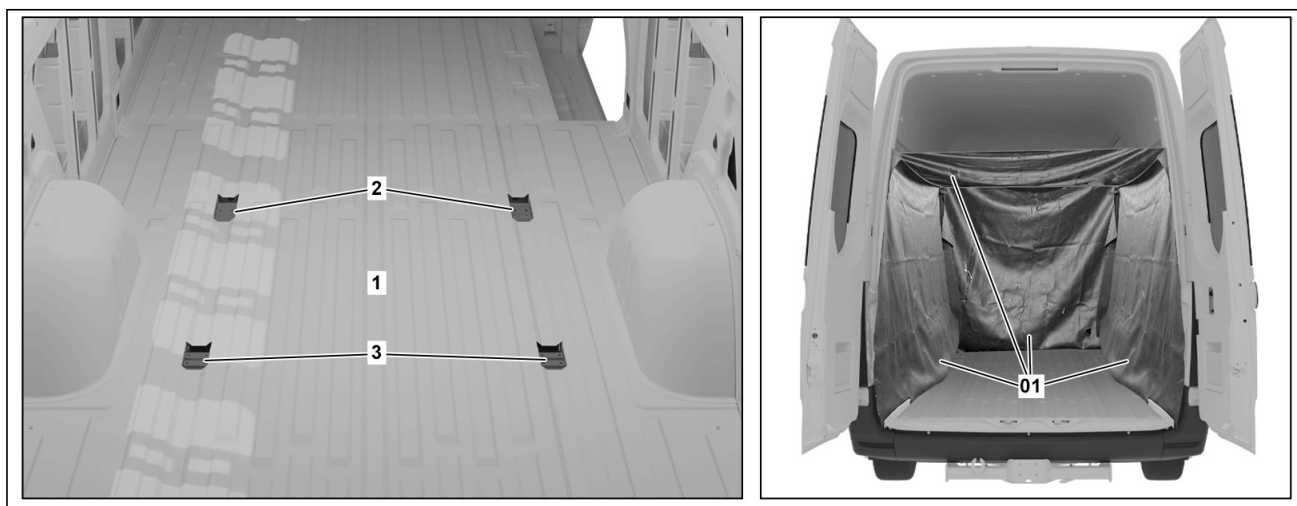





D61.25-A024-76





























D61.25-A013-78

1 Vehicle floor
2 Reinforcements

3 Reinforcements
01 Welding protection blanket

 Danger	The high voltage used for electric welding presents a lethal hazard. Risk of explosion from welding in areas close to highly inflammable materials. Risk of injury from weld splatter and UV-light when welding. Risk of poisoning from inhaling welding gases	Use insulating mats. Wear protective clothing, safety glasses and a protective mask. Remove highly inflammable materials from the hazard area. Use air extraction system.	AS00.00-Z-0007-01A
 Caution	Risk of injury caused by scraping or cutting body parts on sharp vehicle parts	Always wear protective gloves when working on or near sharp and non-deburred vehicle parts. Deburr repair panels.	AS00.00-Z-0017-01A
Notice	Measures for preventing damage to vehicles or components when performing electric welding work		AH00.00-P-0005-01KOA
Notice	Notes on battery		AH54.10-P-0001-01A
Notice	General information on body repair		AH60.00-P-0001-01KOA
Notice	Notes on carrying out repair work in the vehicle interior		AH68.00-D-0001-01KOS
 Check			
1	Check whether vehicle is affected by measure.	Clip: Subsequently reinforce longitudinal frame member (code: VS3ROHRAH, acc. no.: 31 903 04)  A video with a simplified presentation is available for this measure. Nevertheless, all work instructions and information in this document are to be observed as a matter of priority.	Page 7
 Remove			
2  AR	Remove passenger bench seat.	Model 907.6###/7## #T with passenger compartment seating	AR91.21-D-4425TS
3  AR	Remove seat anchorages for passenger bench seat/passenger bench seats.		AR91.21-D-3772TSR
4  AR  AR	Remove B-pillar trim on driver's side. Remove/install B-pillar trim	Model 907.7 Model 907.6	AR68.30-D-4707TS AR68.30-D-4705TS

5	Remove B-pillar trim on front passenger side.		
 AR		Model 907.7	AR68.30-D-4706TS
 AR	Remove/install B-pillar trim	Model 907.6	AR68.30-D-4705TS
6	Remove D-pillar trim.		
 AR			AR68.30-D-4497TSR
7	Remove floor covering in passenger compartment.		
 AR			AR68.80-D-0012TSR
	Retrofit reinforcements		
8	Scribe separation lines on vehicle floor (1).	 The width of the cutout is based on the laser weld seams (A). The length of the cutout is based on the chamfer (D). Dimension a: 70 mm Dimension b: 120 mm Dimension d: 180 mm	
9	Cover all detachable parts remaining in vehicle with welding protection blankets (01).	 Commercially available devices/ tools Welding protection blanket	
10	Detach vehicle floor (1).	 Do not make the cuts too deep. This prevents damage to the component parts located underneath.	
11	Remove sections (1.1).	 Do not dispose of sections (1.1).	
12	Clean weld joints and sheet metal flange.	 Commercially available devices/ tools Rotary wire brush	
13	Retrofit reinforcements (2, 3). 000 588 02 84 00 Welder	 For reinforcements (3), observe dimension c: 565 mm.  Commercially available devices/ tools Clamping pliers (Standard) Smoke extraction Rotary wire brush 1K-zinc dust paint	Page 8 WS60.00-P-0022K BR00.45-Z-1056-07A
14	Insert vehicle floor (1). 000 588 02 84 00 Welder		WS60.00-P-0022K
 WS			

15	Clean weld joints and sheet metal flange.	 Commercially available devices/ tools Clamping pliers (Standard) Smoke extraction Rotary wire brush	
16	Remove welding protection blankets.		
 Danger	Risk of explosion caused by paint vapors igniting. Risk of poisoning caused by inhaling paint vapors.	No smoking! No open fire! Use respiratory protection, protective clothing, gloves, safety glasses and protective skin cream. Ensure that the area is well ventilated.	AS98.00-Z-0002-01A
17	Prime repair area with primer filler.		
 Notice	Notes on paintwork repairs	 Use only primer fillers approved by manufacturer. See guidelines for paint technology in the workshop portal.	AH98.00-P-9408-02A
 Danger	Risk of explosion caused by paint vapors igniting. Risk of poisoning caused by inhaling paint vapors.	No smoking! No open fire! Use respiratory protection, protective clothing, gloves, safety glasses and protective skin cream. Ensure that the area is well ventilated.	AS98.00-Z-0002-01A
18	Paint repair area and adjacent surfaces.		
 Notice	General notes on touch-up applicators and paint spray cans		AH98.00-P-9409-06A
 Notice	Notes on paintwork repairs	 Use only paints approved by Daimler AG. See guidelines for paint technology in the workshop portal.	AH98.00-P-9408-02A
19	Add cavity preservation to repair area.		
 AR			AR97.20-D-1500TS
 Install			
20	Install floor covering in passenger compartment.		
 AR			AR68.80-D-0012TSR
21	Install D-pillar trim.		
 AR			AR68.30-D-4497TSR
22	Install B-pillar trim on front passenger side.		
 AR		Model 907.7	AR68.30-D-4706TS
 AR	Remove/install B-pillar trim	Model 907.6	AR68.30-D-4705TS

23	Install B-pillar trim on driver's side.	Model 907.7	AR68.30-D-4707TS
AR	Remove/install B-pillar trim	Model 907.6	AR68.30-D-4705TS
24	Install seat anchorages for passenger bench seat/passenger bench seats.		AR91.21-D-3772TSR
AR	Install passenger bench seat.	Model 907.6##/7## #T with passenger compartment seating	AR91.21-D-4425TS
AR			

Repair materials

Order number	Designation	Number
A 000 986 28 00 09	1K-zinc dust paint	BR00.45-Z-1056-07A





Parts ordering note

Part no.	Designation	Quantity
A 906 311 06 95	Front longitudinal member reinforcement	2
A 906 311 01 53	Rear longitudinal member reinforcement	2
---	Additional replacement part scopes, small parts and consumable materials required for carrying out this service measure must be replaced in accordance with the information in the repair documents referenced in this document. These must be determined according to the vehicle identification number (FIN) via the "XENTRY Parts Information" system and, whilst not listed in the parts ordering note, they are included in the costing.	As Needed

GB61.25-D-0000-00A	Clip: Subsequently reinforce longitudinal frame member (code: VS3ROHRAH, acc. no.: 31 903 04)		
--------------------	---	--	--

Model **907.6##/7## #T**
with code V40 (Crew cab floor assy)

			wsm://04_202400_04
--	--	--	--------------------

SM61.25-D-0006-02SGG	Retrofit reinforcements in longitudinal frame members (code: VS3ROHRAH, acc. no.: 31 903 04)		
 Danger	Risk of explosion caused by paint vapors igniting. Risk of poisoning caused by inhaling paint vapors.	No smoking! No open fire! Use respiratory protection, protective clothing, gloves, safety glasses and protective skin cream. Ensure that the area is well ventilated.	AS98.00-Z-0002-01A
 Danger	Risk of explosion and poisoning caused by solvent vapors and gasses. Risk of injury to skin and eyes when working with anticorrosion agents	Never spray corrosion protection on flames or hot, glowing objects and keep them well away from all potential sources of ignition. Use them only in well-ventilated rooms; wear respiratory protection.	AS97.00-Z-0001-01A
 Danger	The high voltage used for electric welding presents a lethal hazard. Risk of explosion from welding in areas close to highly inflammable materials. Risk of injury from weld splatter and UV-light when welding. Risk of poisoning from inhaling welding gases	Use insulating mats. Wear protective clothing, safety glasses and a protective mask. Remove highly inflammable materials from the hazard area. Use air extraction system.	AS00.00-Z-0007-01A
 Caution	Risk of injury caused by scraping or cutting body parts on sharp vehicle parts	Always wear protective gloves when working on or near sharp and non-deburred vehicle parts. Deburr repair panels.	AS00.00-Z-0017-01A
Notice	Notes on paintwork repairs		AH98.00-P-9408-02A
Notice	Notes on cavity preservation		AH97.20-P-0001-01B
Notice	Notes on carrying out repair work in the vehicle interior		AH68.00-D-0001-01KOS
Notice	General information on body repair		AH60.00-P-0001-01KOA
Notice	Measures for preventing damage to vehicles or components when performing electric welding work		AH00.00-P-0005-01KOA
Notice	Notes on paintwork repairs General information on operation items and work procedures for painting		AH98.00-P-9408-02A AH98.00-P-0003-01A

Model **907.6##/7## #T**
with code V40 (Crew cab floor assy)

Prepare vehicle floor sections

- 1 Grind mating surfaces in the cross-hatched areas on sections (1.1, 1.2) of vehicle floor down to bare metal.
- 2 Remove shavings.

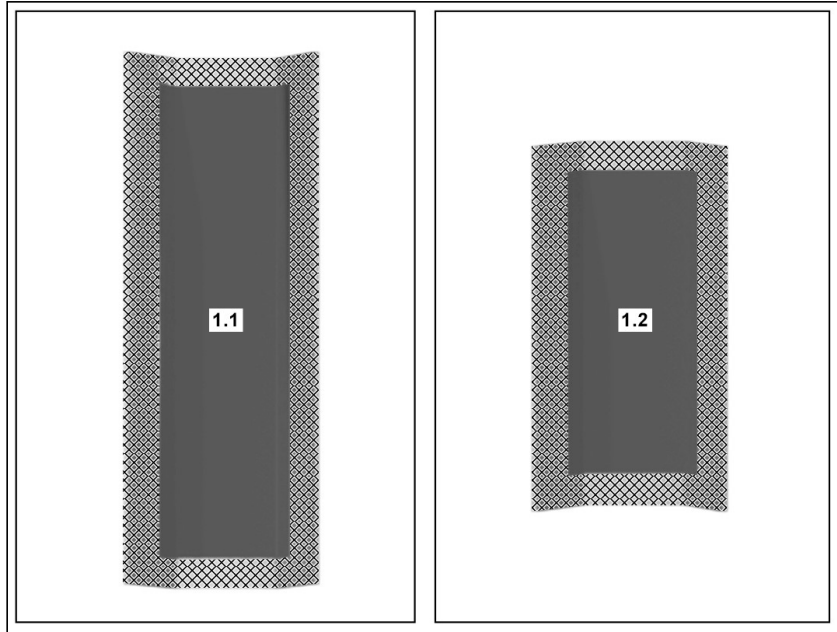

D61.25-A015-76

Prepare reinforcements for installation

- 3 Grind mating surfaces in the cross-hatched areas on reinforcements (2, 3) down to bare metal.
- 4 Remove shavings.

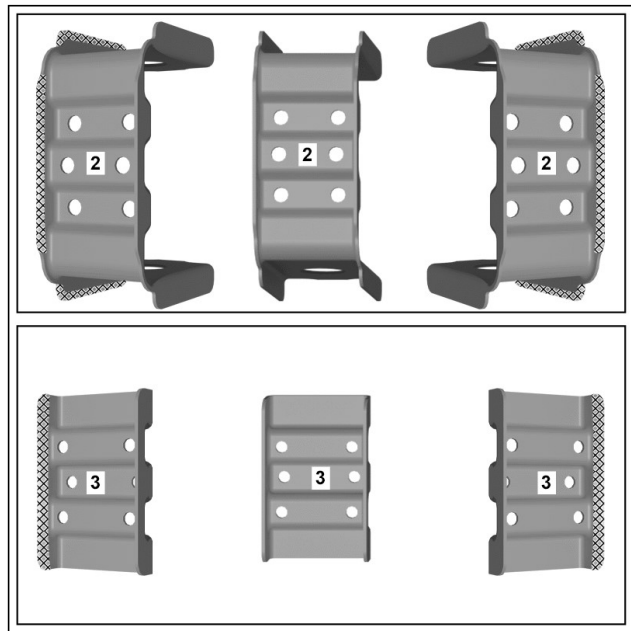

D61.25-A016-82

Prepare longitudinal members

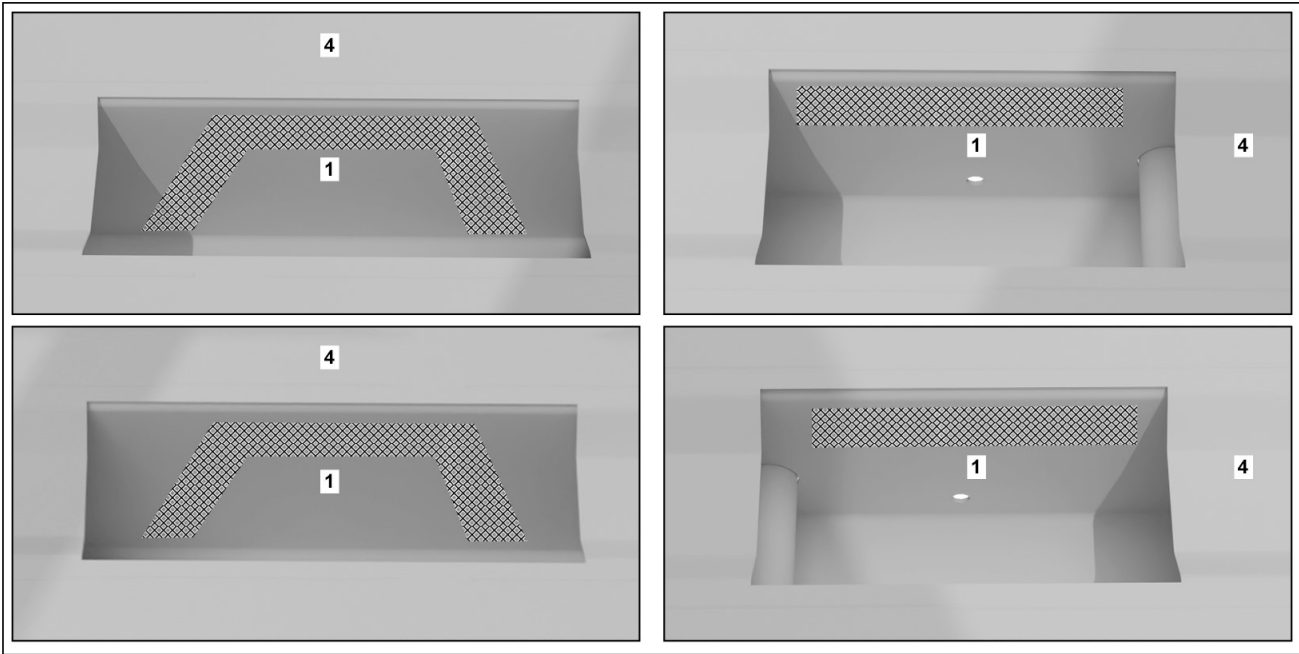

D61.25-A017-79

5 Grind mating surfaces in the cross-hatched areas on longitudinal members (1) down to bare metal.

6 Remove shavings.

Prepare vehicle floor

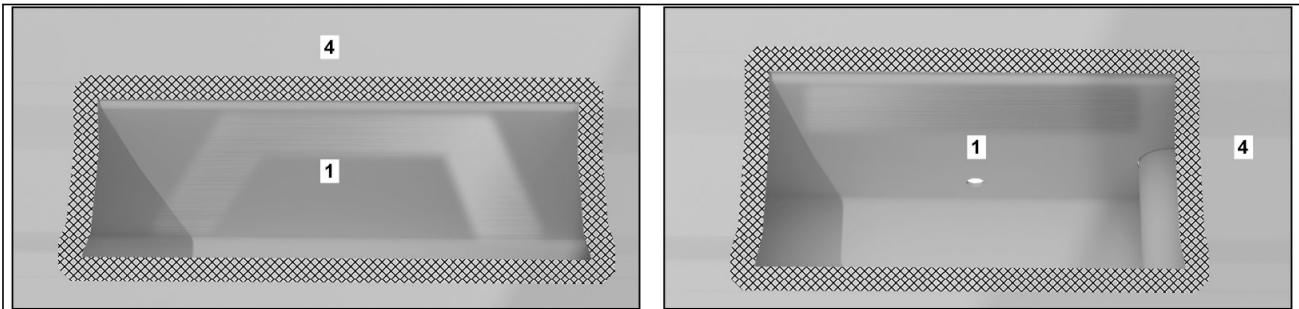

D61.25-A018-77

7 Grind mating surfaces in cross-hatched areas on vehicle floor (4) down to bare metal.

8 Remove shavings.

Install reinforcements

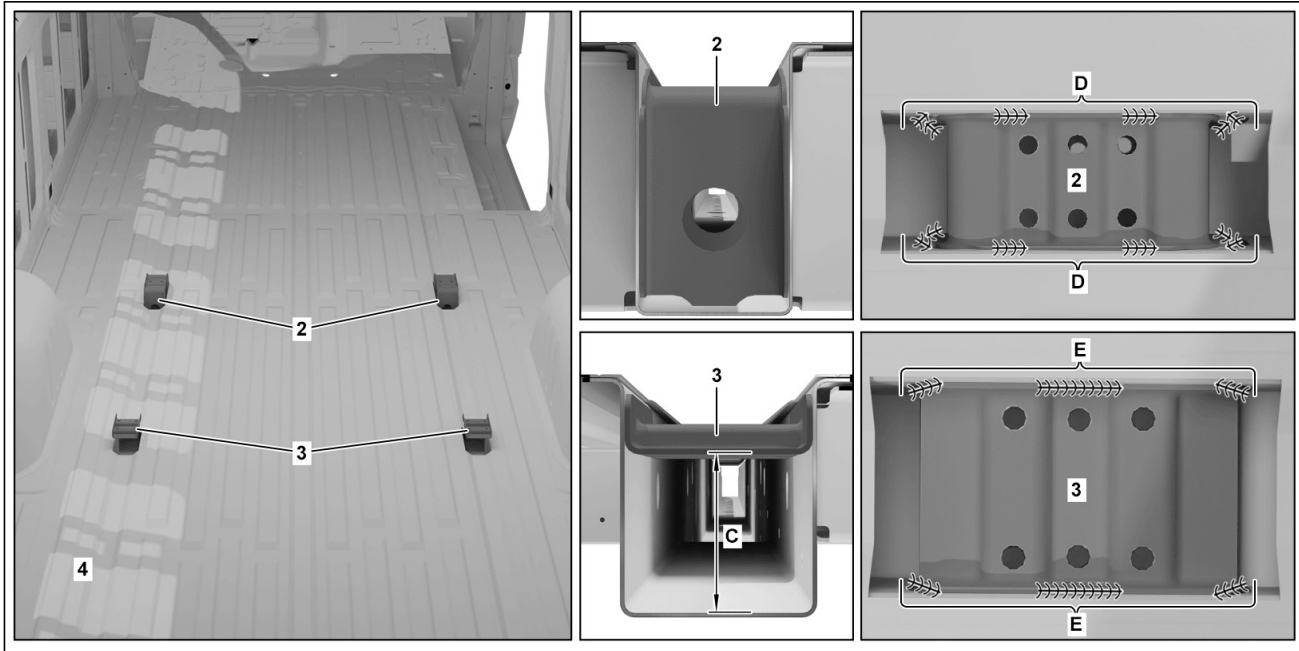

D61.25-A019-79

- 9 Position reinforcements (2, 3) in longitudinal member (1).
- i**
 Reinforcements (2): A 906 311 06 95
 Reinforcements (3): A 906 311 01 53
- i**
 Observe dimension (C) here. Dimension (C) is 565 mm.

- 10 Reinforcements (2, 3) sg (areas D, E).
- i**
 Inert gas weld in intervals and allow to cool down in between. This reduces the heat distortion.

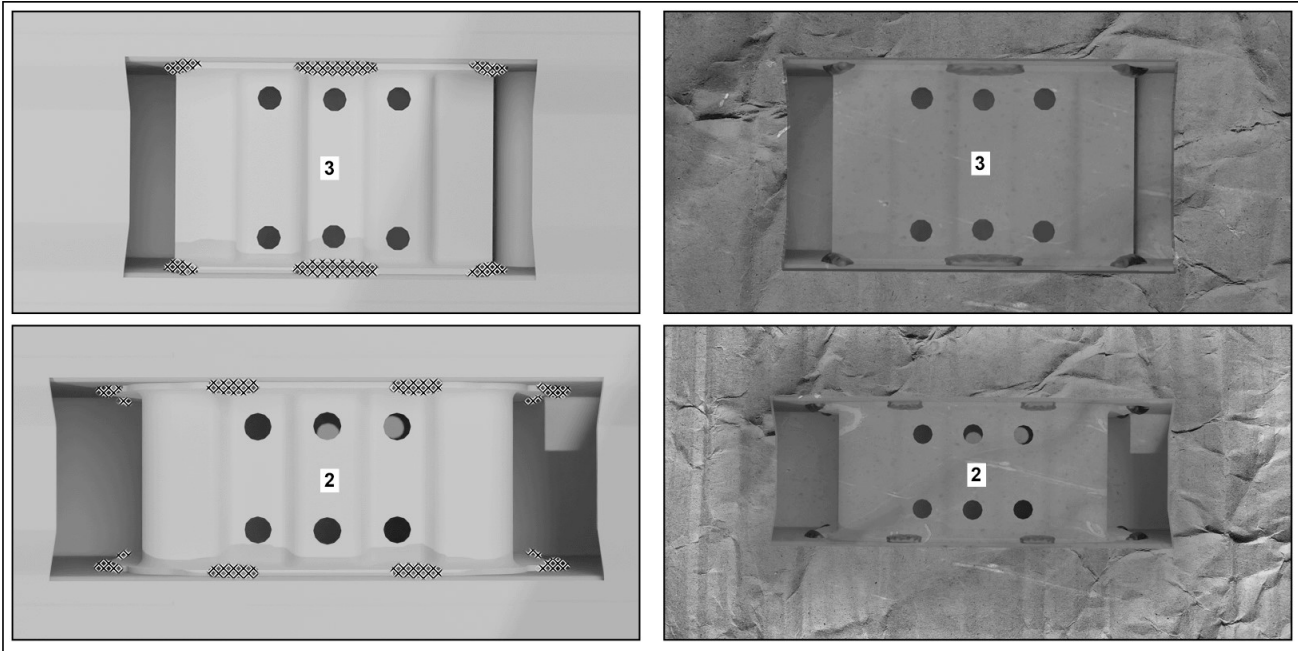

D61.25-A020-79

- 11 Clean weld joints and sheet metal flanges in cross-hatched area.
- 12 Prime repair area with a primer filler.
 Use only primer fillers approved by manufacturer.
See guidelines for paint technology in the workshop portal.

Install sections

- 1.1 Part section
- 1.2 Part section
- 4 Vehicle floor

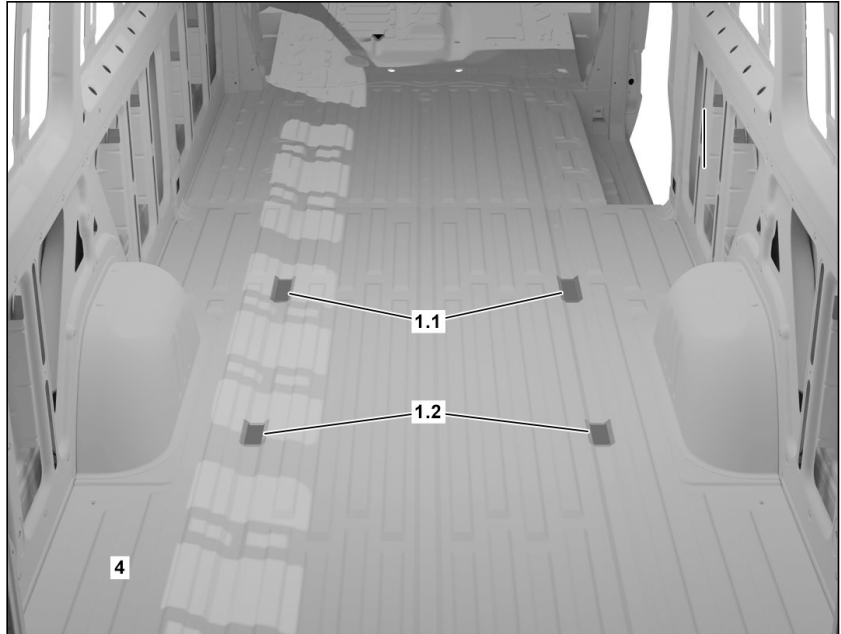

D61.25-A021-76

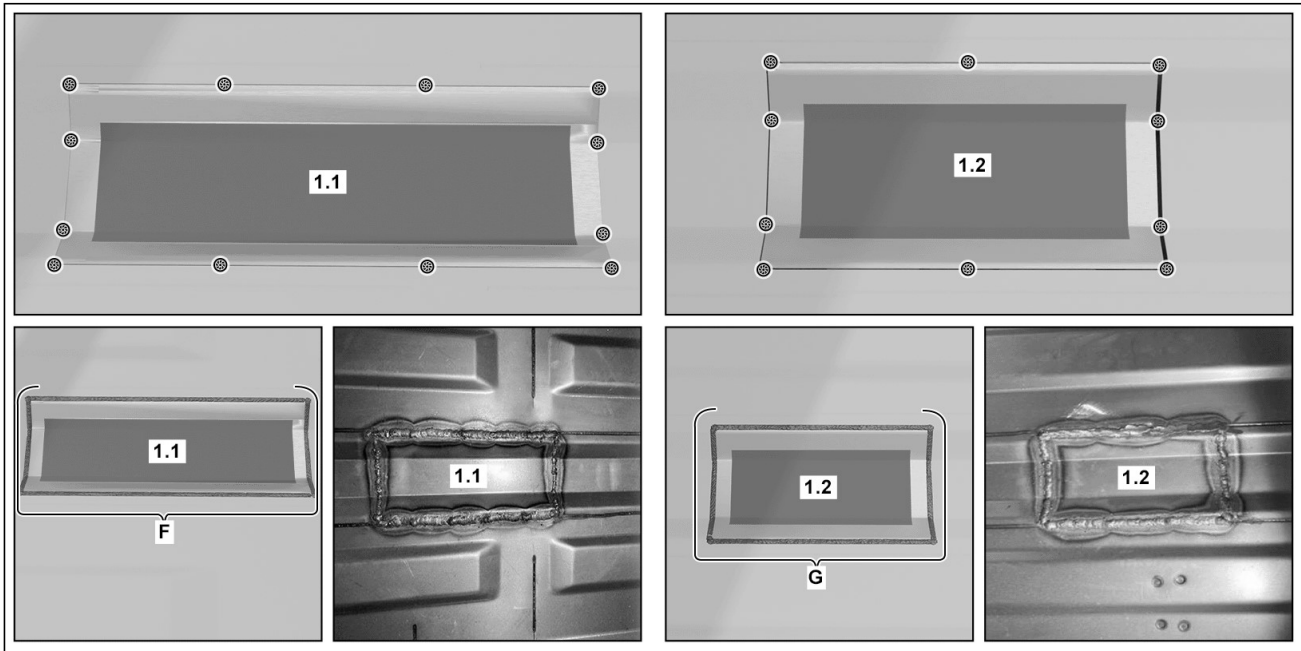

D61.25-A022-79

- 13 Position sections (1.1, 1.2) on vehicle floor (3).
- 14 Tack sections (1.1, 1.2) sg  into place.

- 15 Sections (1.1, 1.2) sg  (areas F, G).



Inert gas weld in intervals and allow to cool down in between. This reduces the heat distortion.

16 Grind inert gas weld down flat (areas F, G).

17 Remove shavings.

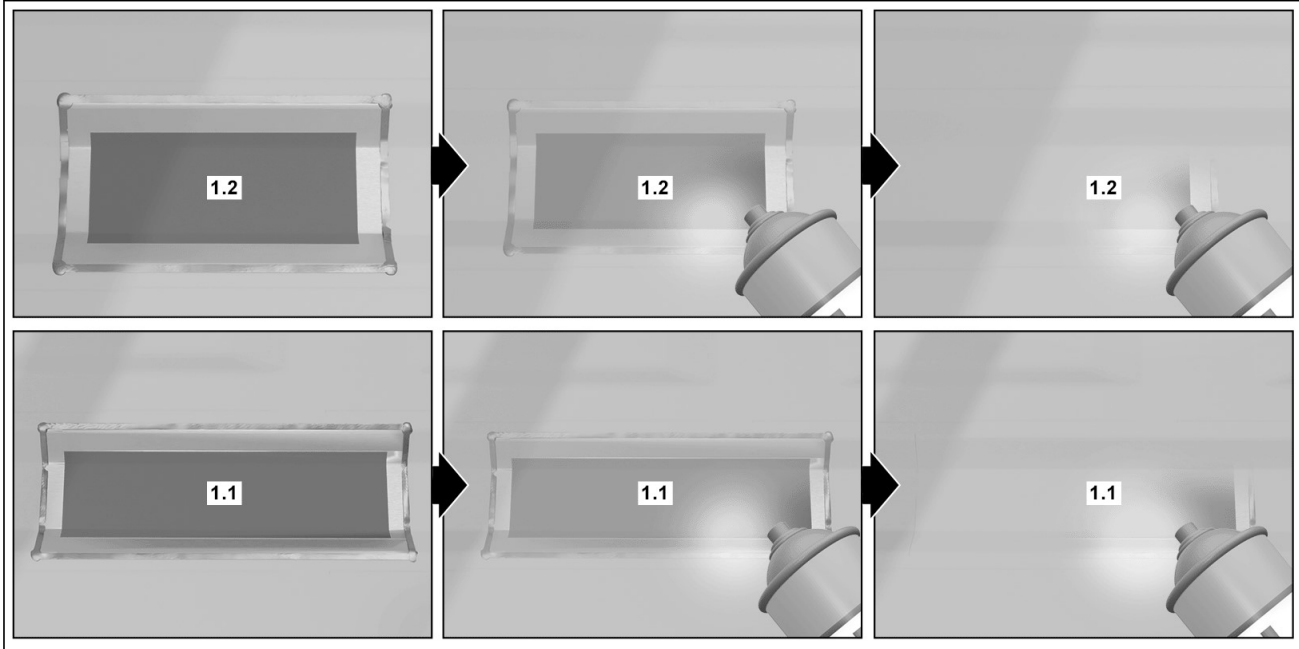

D61.25-A023-79

18 Clean weld joints and sheet metal flange.

20 Paint repair area and adjacent surfaces.

19 Prime repair area with a primer filler.



Use only primer fillers approved by manufacturer.

See guidelines for paint technology in the workshop portal.



Only use paints approved by the manufacturer.

See guidelines for paint technology in the workshop portal.