

**ATTENTION:**

- GENERAL MANAGER
- PARTS MANAGER
- CLAIMS PERSONNEL
- SERVICE MANAGER

IMPORTANT - All Service Personnel Should Read and Initial in the boxes provided, right.



QUALITY DRIVEN® SERVICE

© 2020 Subaru of America, Inc. All rights reserved.

**PRODUCT CAMPAIGN BULLETIN**

<p><b>APPLICABILITY:</b> 2003-14 MY Legacy          2003-14 MY Outback          2003-06 MY Baja          2009-13 MY Forester          2004-11 MY Impreza          2004-14 MY WRX and STI</p> <p><b>SUBJECT:</b> Takata Front Passenger Airbag Module /          Inflator “Like for Like” Recall</p>	<p><b>NUMBERS:</b> TKA-20R          TKB-20R          TKC-20R</p> <p><b>DATE:</b> 01/06/20</p> <p><b>REVISED:</b> 12/28/23</p> <p><b>NHTSA ID:</b> 20V001          20V002          20V003</p>
---	--

SUBARU OF AMERICA, INC. has determined that a defect, which relates to motor vehicle safety, exists in certain 2003-2014 model year Legacy and Outback vehicles, 2003-2006 model year Baja vehicles, 2009-2013 model year Forester vehicles, 2004-2011 model year Impreza vehicles, and 2004-2014 WRX (including STI) vehicles equipped with a non-desiccated Takata-sourced passenger-side frontal air bag containing the propellant Phase Stabilized Ammonium Nitrate (PSAN).

As previously communicated, this phase of the Takata airbag recall includes vehicles which had an *interim repair* performed under previous Takata airbag recalls.

Interim repairs, also referred to as “like-for-like” repairs, involved the installation of a non-desiccated PSAN Takata-sourced inflator, prior to the availability of final repair parts which do not contain PSAN. The vehicles included in this recall were identified from recall claim data indicating that a “like-for-like” Takata-sourced non-desiccated PSAN inflator may have been installed.

**DESCRIPTION OF THE SAFETY DEFECT AND SAFETY HAZARD**

Despite the previous recall repair for a “like-for-like” air bag inflator replacement, vehicles containing a Takata-sourced passenger-side frontal air bag inflator remain susceptible to propellant degradation occurring after long-term exposure to high absolute humidity, temperature and temperature cycling. Over time, this could cause the inflator within the air bag to explode when the passenger’s frontal air bag deploys in a crash.

If the air bag inflator explodes, sharp metal fragments could strike vehicle occupants, potentially resulting in serious injury or death.

*Continued...*

<p><b>CAUTION: VEHICLE SERVICING PERFORMED BY UNTRAINED PERSONS COULD RESULT IN SERIOUS INJURY TO THOSE PERSONS OR TO OTHERS.</b></p> <p>Subaru Service Bulletins are intended for use by professional technicians ONLY. They are written to inform those technicians of conditions that may occur in some vehicles, or to provide information that could assist in the proper servicing of the vehicle. Properly trained technicians have the equipment, tools, safety instructions, and know-how to do the job correctly and safely. If a condition is described, DO NOT assume that this Service Bulletin applies to your vehicle, or that your vehicle will have that condition.</p>	<p><b>SUBARU OF AMERICA, INC. IS ISO 14001 COMPLIANT</b></p> <p>ISO 14001 is the international standard for excellence in Environmental Management Systems. Please recycle or dispose of automotive products in a manner that is friendly to our environment and in accordance with all local, state and federal laws and regulations.</p>
--	--

## BACKGROUND

The National Highway Traffic Safety Administration (NHTSA) has prioritized the recalls of all non-desiccated Takata-sourced passenger side Takata airbag inflators based on the risk of injury or death to vehicle occupants.

The combination of time, high temperature fluctuations, and humidity contribute to the degradation of the propellant in the inflators. Therefore, NHTSA prioritized the Takata recalls by age and location history of the vehicles. To do so, NHTSA has established three geographical Zones – A, B, and C – based on the level of heat and humidity as listed below:

### **Zone A: Hot and Humid**

Alabama, California, Florida, Georgia, Hawaii, Louisiana, Mississippi, South Carolina, Texas, Puerto Rico, American Samoa, Guam, the Northern Mariana Islands (Saipan), and the U.S. Virgin Islands.

### **Zone B: Less Hot and Humid**

Arizona, Arkansas, Delaware, District of Columbia, Illinois, Indiana, Kansas, Kentucky, Maryland, Missouri, Nebraska, Nevada, New Jersey, New Mexico, North Carolina, Ohio, Oklahoma, Pennsylvania, Tennessee, Virginia, and West Virginia.

### **Zone C: Least Hot and Humid**

Alaska, Colorado, Connecticut, Idaho, Iowa, Maine, Massachusetts, Michigan, Minnesota, Montana, New Hampshire, New York, North Dakota, Oregon, Rhode Island, South Dakota, Utah, Vermont, Washington, Wisconsin, and Wyoming.

## AFFECTED VEHICLES

This phase of the Takata recall includes vehicles which may have had an interim (“like-for-like”) repair performed under a previous airbag recall, to reduce the risk of injury before final remedy parts were available:

- Previously repaired Zone A vehicles will be included in recall code TKA-20
- Previously repaired Zone B vehicles will be included in recall code TKB-20
- Previously repaired Zone C vehicles will be included in recall code TKC-20

If the previous recall claim data is unclear as to whether a PSAN “like-for-like” inflator was installed or not, the vehicle has been included in this phase of the Takata airbag recall out of an abundance of caution.

Examples of unclear retailer claim data are listed below:

- Missing installed inflator/module serial numbers
- Installed inflator/module serial numbers that do not correspond with the part number claimed
- Returned part information that indicates that a PSAN unit may have been installed

Retailer affected vehicle counts by model year/carline were distributed to all Regional/Distributor offices in December to assist with capacity planning purposes. Lists of the affected VINs will be distributed when owner notification begins.

The status of TKA20, TKB20, and TKC20 coverage will display as “Open – Pending Phased Mailing” until all official owner notification letters have been released. This status is not intended to discourage retailers from scheduling these repairs and will not affect the retailers’ ability to file a claim for repairs performed prior to the official owner notification.

*Continued...*

## REPAIR

The repair procedures for this recall include a required inspection prior to replacement, to confirm whether a PSAN “like-for-like” inflator was previously installed or not.

- If inspection confirms the affected vehicle **DOES** contain a previously-installed PSAN “like-for-like” air bag inflator, it will be replaced with a final remedy non-Takata sourced inflator/module.
- If inspection confirms the vehicle **DOES NOT** contain a previously-installed PSAN “like-for-like” inflator, Subaru will reimburse retailers for the required inspection procedure.

## OWNER NOTIFICATION

Owner notification will begin January 7, 2020 and will be phased in weekly mail drops through the end of February. Listed below is the current mailing plan, based on the model year (MY) of the affected vehicles:

- January 7: affected 2003-2004 MY vehicles
- January 16: affected 2005 MY vehicles
- January 23: affected 2006-2007 MY vehicles
- January 30: affected 2008 MY vehicles
- February 6: affected 2009 MY vehicles
- February 13: affected 2010 MY vehicles
- February 20: affected 2011 MY vehicles
- February 27: affected 2012-2014 MY vehicles

As a reminder, if a customer requests a loaner car, retailers should make every effort to comply with that request and follow normal warranty procedures to obtain reimbursement for the loaner car. See Section 8.4.7 (Alternate Transportation Program) of the Claims Policies and Procedures Manual on [subarunet.com](http://subarunet.com) under ‘Claims & Warranty Administration’ for details.

## RETAILER VIN ASSIGNMENT

Each Subaru retailer will receive an affected VIN list from their Zone office when owner notification begins. Vehicles will be assigned to retailers in the affected VIN list as follows. Please note that this logic has recently changed:

1. If there is a preferred retailer on file, the VIN will be assigned to the preferred retailer.
2. If there is no preferred retailer on file:
  - a) Original vehicle owners are assigned to the original selling retailer if their current DMV registration address is within a 50-mile radius of that retailer.
  - b) If the original selling retailer is inactive, the VIN is assigned to the nearest active retailer.
  - c) If the owner is not the original owner, the VIN is assigned to the nearest active retailer.

*Continued...*

## RETAILER PROGRAM RESPONSIBILITY

Any vehicles listed in a recall/campaign that are in retailer stock must be:

- Immediately identified.
- Tagged or otherwise marked to prevent their delivery or use prior to inspection and/or repair.
- Repaired in accordance with the repair procedures outlined in this Product Campaign Bulletin.

Retailers are to promptly perform the applicable service procedures to correct all affected vehicles in their inventory (used, demo & SSLP).

Additionally, whenever a vehicle subject to this recall is taken into retailer inventory, or in for service, necessary steps should be taken to ensure the recall correction has been made before selling or releasing the vehicle, provided that parts are available to complete this recall.

## PARTS INFORMATION

The current part numbers required for this recall are the passenger airbag inflator kits or modules listed below:

Applicability	Part Number	Type	Order Qty.
2003-2004 MY Legacy 2003-2004 MY Outback 2003-2006 MY Baja	98279AE04A	Module	1
2005-2009 MY Legacy 2005-2009 MY Outback	98279AG05A or B	Inflator	1
	SOA963W110*	Non-Woven Material	
2010-2014 MY Legacy 2010-2014 MY Outback	98279AJ06A	Module	1
2004-2005 MY Impreza 2004-2005 MY WRX & STI	98279FE070	Inflator	1
2006-2007 MY Impreza 2006-2007 MY WRX & STI	98279FE12A	Module	1
2008-2011 MY Impreza 2008-2014 MY WRX & STI	98279FG07B	Module	1
2009-2013 MY Forester	98279SC05B	Module	1

\* Use part number **SOA635079** to claim for non-woven material.

## REMINDERS:

- Always order the most up-to-date replacement parts based on the specific VIN being repaired.
- One sheet of the **SOA963W110** non-woven material is enough for approximately 8 vehicles.

*Continued...*

## **PART RETURN PROCEDURES**

The part return information is susceptible to change. Always refer to the “Takata Airbag Inflator & Module Returns” information supplied in the link provided in the APPENDIX A section of this document.

*Continued...*

## SOA PART RETURN NOTICE INFORMATION

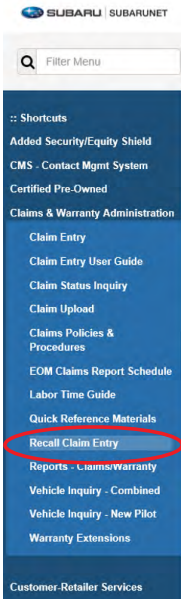

**IMPORTANT NOTE:** The following information is applicable to SOA and Subaru Distributors Corporation (SDC) retailers **ONLY**. Subaru New England (SNE) retailers will continue to follow the procedures currently in place as supplied below.

All SOA and SDC retailers are required to enter **BOTH** the newly-installed (replacement) and the removed (original) serial numbers for the airbag inflator (or module assembly) into the supplied fields as shown in the screen shot below. Claims will not receive an “Approved” status without the serial number information being entered in the appropriate fields in the Recall Claim Entry system. As a result of adding these new required entry fields, Part Return Notices will no longer be generated.

The image shows a screenshot of the Subaru Recall Claim Entry form. The form includes fields for Claim Type, VIN, Recall Code, Auth Code, Total Amount, VIN, RO Start Date, Misc Detail, Status, RO #, RO Completion Date, Dealer #, Job, Rental, Mileage, Towing, Resultant Damage, Tech Name, and SA Name. The 'Installed Serial#' field contains 'XMBLH552899' and the 'Removed Serial#' field contains 'XMBLA242204'. Both fields are highlighted with red circles.

### The information below is applicable to SNE retailers only:

- Upon claim approval and where applicable, Subaru of America, Inc. will generate a Part Return Notice requesting information only.
- To ensure proper claim credit where applicable, the old and new inflator/module serial numbers must be recorded on the Part Return Notice and sent to SOA Part Collection Center (PCC) as instructed on the return notice.
- Where applicable, the completed Part Return Notice should then be sent using the YRC web portal and utilizing the “Ship Small Parcel” link which will direct the user to the appropriate UPS web page application to complete the shipment. Please keep the UPS tracking number for your records.
- **DO NOT WAIT FOR TAKATA XPO TO PICK UP THE INFLATOR/MODULE TO SEND THIS INFORMATION TO THE PCC.**

**Under no circumstances should any airbag inflators or modules be sent to Subaru of America, Inc.**

## SERVICE PROCEDURE

This safety recall involves the inspection and/or replacement of the passenger-side front air bag inflator or module.

As previously communicated, this phase of the Takata recall will include vehicles which previously had an interim repair performed under the current Takata recalls. Interim repairs, also referred to as like-for-like repairs, involved the installation of a non-desiccated PSAN Takata-sourced inflator, prior to the availability of final repair parts which do not contain PSAN.

**IMPORTANT:** Inspection of the airbag inflator **MUST** be performed on **ALL** affected vehicles **BEFORE** proceeding with any part replacements. Use the charts on pages 10 and 11 as a guide when performing the inspection to determine if the currently installed airbag inflator is either a Takata or ZF / TRW manufactured part. If inspection determines the airbag inflator or module assembly requires replacement, refer to the Table of Contents below for the applicable Service Procedure.

As previously communicated, this phase of the Takata recall will include vehicles which previously had an interim repair performed under the current Takata recalls. Interim repairs, also referred to as like-for-like repairs, involved the installation of a non-desiccated PSAN Takata-sourced inflator, prior to the availability of final repair parts which do not contain PSAN.

**VERY IMPORTANT:** **Failure to follow these service procedures carefully and correctly may result in an accidental deployment of the inflator and potentially cause serious injury. Please read through and understand these procedures COMPLETELY before beginning repairs. In addition, proper operation of the airbag after reassembly may be compromised if these service procedures are not followed.**

As additional service procedures are developed for the other models affected by the expansion and implementation of this recall campaign, they will be added to this document and also made available on STIS.

## TABLE OF CONTENTS – SERVICE PROCEDURES

Description	Starting Page Number
<a href="#">Airbag Inflator Inspection Guidelines</a>	<a href="#">10</a>
<a href="#">Service Procedure for 2010-2014MY Legacy / Outback Models, Airbag Module Assembly, Part Number: 98279AJ06A</a>	<a href="#">12</a>
<a href="#">Service Procedure for 2009-2013MY Forester (Part Number: 98279SC05B) and 2008-2011MY Impreza, and 2008-2014MY WRX &amp; STI Models (Part Number: 98279FG07B), Airbag Module Assembly</a>	<a href="#">14</a>
<a href="#">Service Procedure for 2003-2004MY Legacy/Outback and 2003-2006MY Baja Models, Airbag Module Assembly, Part Number: 98279AE04A</a>	<a href="#">16</a>
<a href="#">Service Procedure for 2005-2009MY Legacy / Outback Models, Inflator Type 2, Part Number: 98279AG05A or B</a>	<a href="#">20</a>
<a href="#">Service Procedure for 2004-2005MY Impreza, WRX, and STI Models, Inflator Type 2, Part Number: 98279FE070</a>	<a href="#">30</a>
<a href="#">Service Procedure for 2006-2007MY Impreza, WRX and STI Models, Airbag Module Assembly, Part Number: 98279FE12A</a>	<a href="#">38</a>
<a href="#">Appendix B (2003MY Legacy, Outback, and Baja models ONLY)</a>	<a href="#">47</a>

*Continued...*

**Tools Required:**

DESCRIPTION	BRAND OR TYPE	QUANTITY
Pliers	-	1
Wire Cutters	-	1
Needle-Nose Pliers	-	1
Torque Wrench	Inch-Pound	1
Safety Goggles	-	1
Flat-Blade Screwdriver	-	1
Scissors	-	1
Ratchet	1/4" Drive	1
8 mm and 10 mm Socket		1 ea.
Airbag Deployment Fixture	J-39401-B	1
Tether Clip Release Tool *See Page 9 for more information	SOA635147	1

**CAUTION:** Before starting this service procedure, perform a visual inspection of both front airbags looking for any damage or abnormality. Next, turn the ignition switch to the “ON” position and confirm the airbag warning lamp illuminates then extinguishes normally. If it does not or if **ANY** concern is noted with the airbag system, **STOP** and report these findings to the customer **BEFORE** proceeding further. Any concerns identified with the airbag system (when no airbag deployment has occurred), are not related to this campaign and must be addressed separately. Even if the system has a concern, this may not preclude completion of this campaign. If you are unsure about proceeding, document and fully diagnose the concern then contact the SOA Technical Helpline to review your findings. It is in the best interest of the retailer to fully document any concerns found during this preliminary inspection and review with the customer **BEFORE** proceeding with the campaign service procedure.

- **Vehicles that do not contain Genuine Subaru airbags are not eligible for this recall repair.** For more information on identifying counterfeit airbags and how to address related customer situations, please refer to STIS for the “Counterfeit Airbag Information” Dealer Advisory Bulletin dated October 25, 2012 by going to [Subarunet>Service>STIS>Online Reference](#) - choose Publication Type: ‘Other/Miscellaneous’ and search keywords: ‘Airbag’).
- **Do not proceed with this repair if your inspection reveals a non-Genuine Subaru airbag module has been installed in the vehicle.** Follow the instructions described in the “Counterfeit Airbag Information” Dealer Advisory Bulletin.
- **IMPORTANT:** Always examine airbag modules closely before and during removal. Confirm they match the photos of the Genuine Subaru airbag components supplied throughout this bulletin **BEFORE** proceeding. The photo below shows an example of an aftermarket or counterfeit airbag inflator. This photo is being provided as an example of what may be a wide variety of non-OEM components.
- If an aftermarket or counterfeit passenger airbag or inflator is identified at any point during the campaign service procedure, **STOP IMMEDIATELY. NEVER attempt to remove or otherwise disable any aftermarket or counterfeit device.**
- Document the presence of the aftermarket or counterfeit device on the repair order and with photos. Report this information immediately on a Quality Monitoring Report (QMR). **IMPORTANT:** When entering a related QMR, use failure code **ULF** and **NOT** the campaign fail code.
- Once the QMR has been submitted, contact the Subaru Claims Helpline to discuss the details. They will advise you on how to proceed with treatment of the open campaign.

*Continued...*



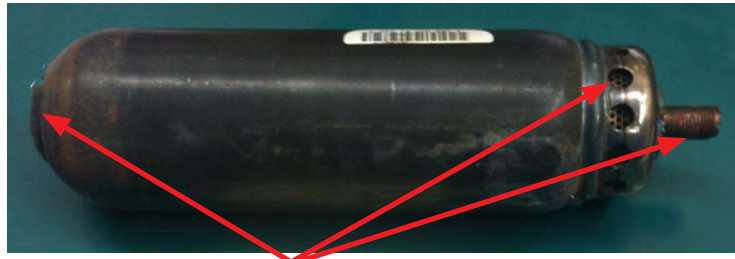



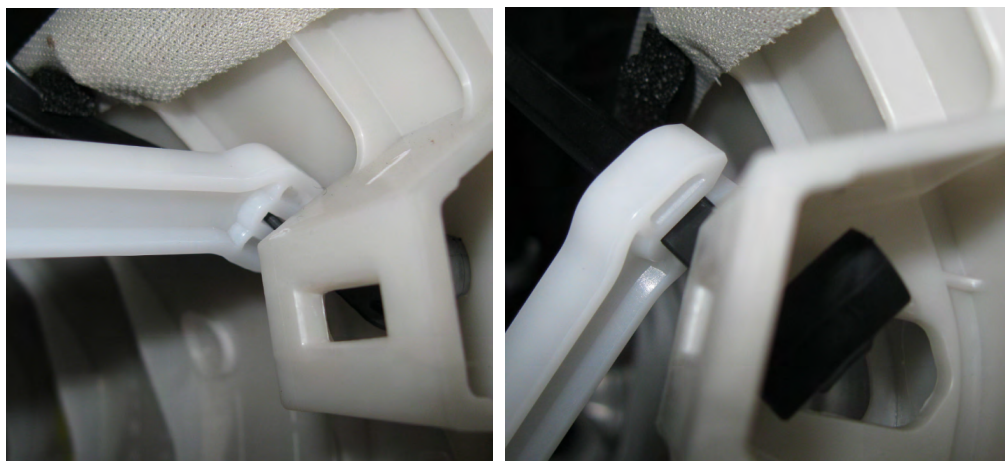
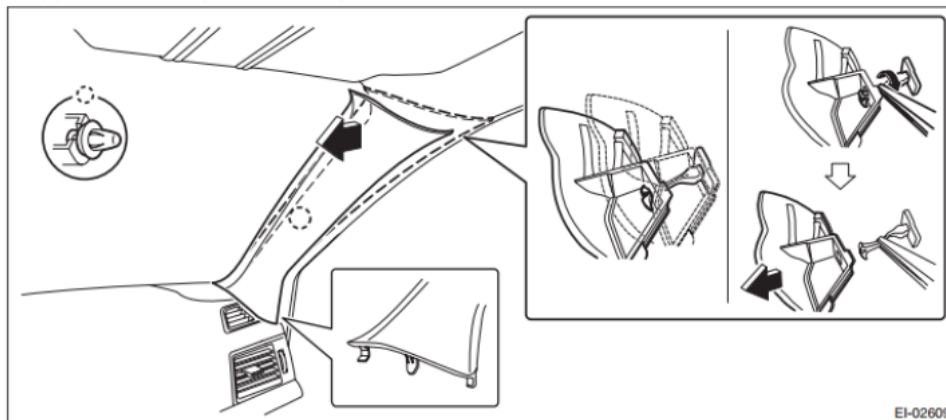

**The shape, holes, and copper-colored stud indicate this is not a Genuine Subaru inflator.**

**NOTE:** Some models utilize a “tether clip” to secure the upper portion of the “A” pillar trim. The tether clip is located just below where the “A” pillar trim meets the head liner. If the tether clip becomes damaged, it **MUST** be replaced. The illustrations and photos below show the location of the tether clip and how to release it. It is **STRONGLY RECOMMENDED** to use the release tool (p.n. **SOA635147**) specifically designed for tether clip removal. Each Retailer has been supplied with 2 of these tools. If the tool is unavailable, a needle-nosed plier can be used to **CAREFULLY** release the tether clip as shown in the illustration below.







*Continued...*

# INSPECTION: How To Determine if the Installed Inflator Is Takata or ZF / TRW

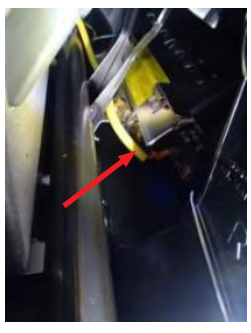
Model Years	Carline	Part Number	Type	Procedure / How to Identify	ZF TRW End Collar Color	ZF TRW: OK - Do NOT replace the Inflator or Module Assembly. Process Claim for INSPECTION ONLY.	TAKATA: NG - Replace the Inflator or Module Assembly per the table.
2004-05MY	IMPREGZA WRX	98279FE070 98279FE07A	Inflator	<ol style="list-style-type: none"> <li>For these models, there is no need to remove any parts.</li> <li>Check the inflator collar from the bottom backside of the instrument panel (IP) on the passenger side.                             <ul style="list-style-type: none"> <li>If the color of the collar is <b>Pink</b>, it is a ZF TRW inflator.</li> <li>If <b>no</b> collar is found, it is a Takata inflator.</li> </ul> </li> </ol>	Pink		
2006-07MY		98279FE12A 98279FE12B	Module		Pink		
2005-09MY	LEGACY OUTBACK	98279AG05B	Inflator	<ol style="list-style-type: none"> <li><b>CAREFULLY</b> remove the air conditioning vent duct on the passenger side.</li> <li>Check the inflator collar inside the IP.                             <ul style="list-style-type: none"> <li>If the color of the collar is <b>Pink</b>, it is a ZF TRW inflator.</li> <li>If <b>no</b> collar is found, it is a Takata inflator.</li> </ul> </li> </ol>	Pink		
2003-06MY	Legacy Outback Baja	98279AE04A 98279AE04B	Module		<p><b>IMPORTANT: For 2003MY ONLY see Appendix B on page 47 for more information.</b></p> <ol style="list-style-type: none"> <li>Release the stoppers of the glovebox and open it fully.</li> <li>Check for the inflator collar from the bottom (<b>TIP</b>: use a Mechanic's mirror to make it easier).</li> </ol> <ul style="list-style-type: none"> <li>If the color of the collar is <b>Pink</b>, it is a ZF TRW inflator.</li> <li>If <b>no</b> collar is found, it is a Takata inflator.</li> </ul> <p><b>TIP:</b> In some cases, removal of the module / dash cover assembly from the IP may be easier and quicker.</p>		

Using a Mechanic's Mirror to confirm the **NG** inflator.

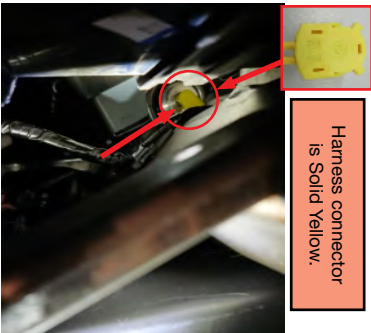
Model Years	Carline	Part Number	Type	Procedure / How to Identify	ZF TRW End Collar Color	ZF TRW: OK - Do NOT replace the Inflator or Module Assembly. Process Claim for INSPECTION ONLY.	TAKATA: NG - Replace the Inflator or Module Assembly per the table.
2008-14MY	IMPRESZA V/RX	98279FG07A 98279FG07B	Module	<ol style="list-style-type: none"> <li><b>CAREFULLY</b> remove the end panel of the IP on the passenger side.</li> <li>Check the inflator collar inside the IP. <ul style="list-style-type: none"> <li>If the color of the collar is <b>Pink</b>, it is a ZF TRW inflator.</li> <li>If <b>no</b> collar is found, it is a Takata inflator.</li> </ul> </li> </ol>	Pink		
2009-13MY	FORESTER	98279SC05A 98279SC05B	Module	<ol style="list-style-type: none"> <li><b>CAREFULLY</b> remove the end panel of the IP on the passenger side.</li> <li>Check for the inflator collar inside the IP. <ul style="list-style-type: none"> <li>If the color of the collar is <b>Pink</b>, it is a ZF TRW inflator.</li> <li>If <b>no</b> collar is found, it is a Takata inflator.</li> </ul> </li> </ol>	Pink		
2010-14MY	LEGACY OUTBACK	98279AJ06A	Module	<ol style="list-style-type: none"> <li><b>CAREFULLY</b> remove the end panel of the IP on the passenger side.</li> <li>Check <b>the harness connector color</b> of the inflator inside the IP. <ul style="list-style-type: none"> <li>If the connector is <b>Black/Yellow</b>, it is a ZF TRW inflator.</li> <li>If the connector is <b>Solid Yellow</b>, it is a Takata inflator.</li> </ul> </li> </ol>	No End Collars Are Used	 <p>Harness connector is a combination of Black and Yellow.</p>	 <p>Harness connector is Solid Yellow.</p>

**\*SERVICE PROCEDURE FOR 2010-14MY LEGACY / OUTBACK MODELS\***  
**Replacement Airbag Module Assembly Part Number: 98279AJ06A**

**CAUTION: Refer to the “CAUTION” section in the General Description portion of Airbag System AB in the Body Section of the Service Manual before handling or servicing any airbag module!**

**STEP 1- PREPARATION:**

- Record the customer’s radio station presets (and Navigation favorites where applicable).
- Turn the ignition “OFF”.
- Disconnect the Negative (ground) cable from the battery and wait **at least 60 seconds** before proceeding further.
- Follow the procedures in the applicable Service Manual for removing the instrument panel assembly as required to access the passenger side airbag module.
- Disconnect the wiring harness and remove the airbag module.

**IMPORTANT: Whenever beginning to remove (or install) the airbag assembly, and periodically while performing the procedure or after stepping away, remove any possible static charge from your body by momentarily touching a clean, bare metal ground point on the vehicle (e.g. the door striker). Remove from your person all electronic devices including cell phones before proceeding.**

**IMPORTANT: DO NOT destroy or damage the Shipping Box as it MUST be used for the original module’s return shipping.**

**STEP 2-** To access the passenger’s airbag module, the complete instrument panel assembly must be removed. Follow the procedures in the applicable Service Manual for removing the instrument panel assembly in addition to the necessary related interior trim components.

**NOTE:** When removing the “A” pillar trim, be **VERY CAREFUL** not to damage the upper trim retaining (tether) clip. The clip is located just below where the trim panel meets the head liner. If the tether clip becomes damaged, it **MUST** be replaced. The illustrations below show how to release the tether clip and remove the “A” pillar trim. It is **STRONGLY RECOMMENDED** to use the release tool (p.n. SOA635147) specifically designed for tether clip removal. See pg. 8 of this bulletin for more information.

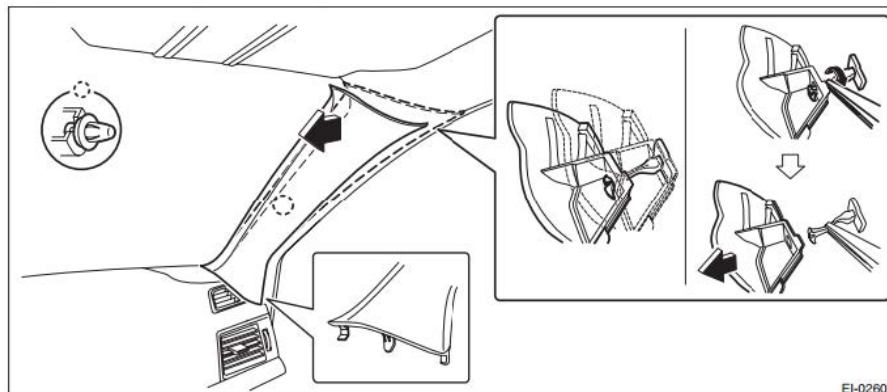

Once the instrument panel assembly has been removed from the vehicle, **CAREFULLY** release the retaining claws and separate the airbag bag module.

*Continued...*

**STEP 3-** Install the new airbag module to the instrument panel.

**STEP 4-** Reinstall the instrument panel assembly into the vehicle in reverse order of disassembly. Once the negative battery cable has been reconnected, turn the ignition key “ON” and confirm the AIRBAG warning light comes on then cycles off properly. Once proper warning light operation is confirmed, reinstall the remaining components and reset the radio station presets (and Navigation favorites where applicable) to complete the procedure.

**STEP 5-** If not already done, place the removed original air bag module in the Shipping Box, with a completed SOA warranty parts tag (MSA5W1901A) attached to it. The tag must contain the following information: **Claim Number, Repair Date, 17-digit VIN, and vehicle mileage.** Refer to the “PART RETURN PROCEDURES” section of this bulletin for further return shipping instructions and information. **Ensure both the removed and installed module serial numbers have been recorded correctly as previously instructed on the repair order hard copy before returning the removed part to your Parts Department.**

**IMPORTANT: UNDER NO CIRCUMSTANCES SHOULD ANY AIR BAG INFLATORS OR MODULE ASSEMBLIES BE RETURNED TO SUBARU OF AMERICA, INC.**

*Continued...*

**\*SERVICE PROCEDURE FOR 2009-2013MY FORESTER and 2008-2011MY IMPREZA and 2008-2014 MY WRX and STI MODELS\* Replacement Airbag Module Assembly Part Number 98279FG07B (Impreza, WRX and STI) and 98279SC05B (Forester)**

**CAUTION: Refer to the “CAUTION” section in the General Description portion of Airbag System AB in the Body Section of the Service Manual before handling or servicing any airbag module!**

**STEP 1- PREPARATION:**

- Record the customer’s radio station presets (and Navigation favorites where applicable).
- Turn the ignition “OFF”.
- Disconnect the Negative (ground) cable from the battery and wait **at least 60 seconds** before proceeding further.
- Follow the procedures in the applicable Service Manual for removing the instrument panel assembly as required to access the passenger side airbag module.
- Disconnect the wiring harness and remove the airbag module.

**IMPORTANT: Whenever beginning to remove (or install) the airbag assembly, and periodically while performing the procedure or after stepping away, remove any possible static charge from your body by momentarily touching a clean, bare metal ground point on the vehicle (e.g. the door striker). Remove from your person all electronic devices including cell phones before proceeding.**

**IMPORTANT: DO NOT destroy or damage the Shipping Box as it MUST be used for the original module’s return shipping.**

**STEP 2-** To access the passenger’s airbag module, the complete instrument panel assembly must be removed. Follow the procedures in the applicable Service Manual for removing the instrument panel assembly in addition to the necessary related interior trim components.

**NOTE:** On **FORESTER** models, when removing the “A” pillar trim, be **VERY CAREFUL** not to damage the upper trim retaining (tether) clip. It is **STRONGLY RECOMMENDED** to use the release tool (p.n. SOA635147) specifically designed for tether clip removal. See pg. 8 of this bulletin for more information. The clip is located just below where the trim panel meets the head liner. If the tether clip becomes damaged, it **MUST** be replaced. The illustrations below show how to release the tether clip and remove the “A” pillar trim.

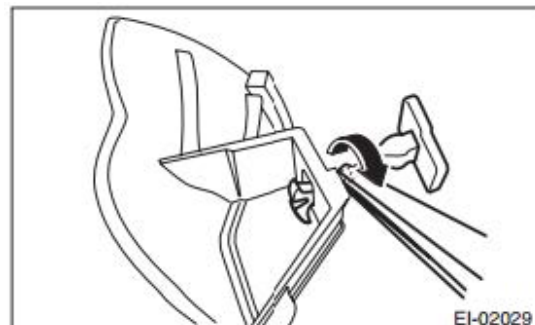
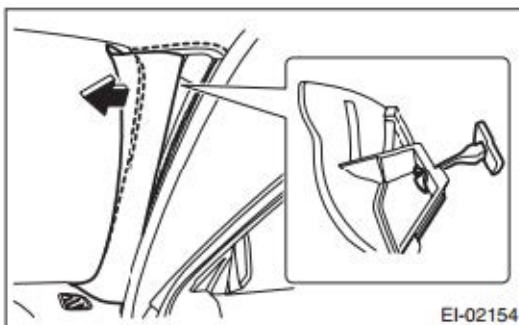

On **IMPREZA** models, in place of the tether clip, the trim is secured by a screw accessible by removing the small access cover.

*Continued...*

Once the instrument panel assembly has been removed from the vehicle, **CAREFULLY** release the retaining claws and separate the airbag bag module.

**STEP 3-** Install the new airbag module to the instrument panel.

**STEP 4-** Reinstall the instrument panel assembly into the vehicle in reverse order of disassembly. Once the negative battery cable has been reconnected, turn the ignition key “ON” and confirm the AIRBAG warning light comes on then cycles off properly. Once proper warning light operation is confirmed, reinstall the remaining components and reset the radio station presets (and Navigation favorites where applicable) to complete the procedure.

**STEP 5-** If not already done, place the removed original air bag module assembly in the Shipping Box (or into the returnable shipping box), with a completed SOA warranty parts tag (MSA5W1901A) attached to it. The tag must contain the following information: **Claim Number, Repair Date, 17-digit VIN, and vehicle mileage.** Refer to the “PART RETURN PROCEDURES” and Appendix “A” sections of this bulletin for further return shipping instructions and information. **Ensure both the removed and installed module serial numbers have been recorded correctly as previously instructed on the repair order hard copy before returning the removed part to your Parts Department.**

**IMPORTANT: UNDER NO CIRCUMSTANCES SHOULD ANY AIR BAG INFLATORS OR MODULE ASSEMBLIES BE RETURNED TO SUBARU OF AMERICA, INC.**

*Continued...*

**\*SERVICE PROCEDURE FOR 2003-2004MY LEGACY / OUTBACK AND 2003-2006MY BAJA MODELS\* Replacement Airbag Module Assembly Part Number: 98279AE04A**

**IMPORTANT: For 2003MY vehicles ONLY, see Appendix B on page 47, BEFORE proceeding.**

**IMPORTANT NOTES:**

The new module assembly does not include the lid (outer trim cover). In this procedure, the lid is transferred to the new module from the original. In an extremely rare case where a lid gets damaged during the transfer, part numbers for replacements are provided below.

Description	Part Number	Color
AIR B MOD P KIT LID	98279AE05ADG	Brown
	98279AE05AML	Black

**CAUTION: Refer to the “CAUTION” section in the General Description portion of Airbag System AB in the Body Section of the Service Manual before handling or servicing any airbag module!**

**STEP 1- PREPARATION:**

Before proceeding, confirm the airbag lamp cycles on and then off normally as part of the self-check and using SSM, confirm there are no DTCs stored in the airbag system. Inspect the dash area around the passenger airbag module for any marks or damage. Document and photograph any conditions observed before starting this procedure.

- Turn the ignition “OFF”.
- Disconnect the Negative (ground) cable from the battery and wait at least 60 seconds before proceeding further.
- Remove the glove box assembly following the procedure in the applicable Service Manual and using the tips below.
  - The glove box is held in place by 8 screws. The 2 upper left and right hand corner screws have a distinctive gold finish and 10mm hex head. It is helpful to leave these 2 screws until last when removing and install first during replacement to support the weight of the assembly.
  - It is necessary to remove the knockout plugs (stopper in the Service Manual) to gain access to all the mounting screws.

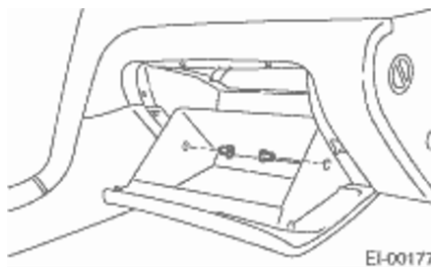

- It is possible to leave the stoppers in place during servicing by carefully bending in the sides of the glove box until the stoppers are cleared.
- To prevent damage, do not bend them in any further than necessary.

**IMPORTANT: Whenever beginning to remove (or install) the airbag assembly, and periodically while performing the procedure or after stepping away, remove any possible static charge from your body by momentarily touching a clean, bare metal ground point on the vehicle (e.g. the door striker). Remove from your person all electronic devices including cell phones before proceeding.**

*Continued...*



- Disconnect the airbag module harness connector (A) and release it from the support beam bracket.
- Remove the 3 retaining bolts and CAREFULLY remove the airbag module from the vehicle by carefully releasing the cover tabs from the underside of the dash and pushing the module up and out. Use caution and protective coverings to avoid damaging the dashboard pad. Place the airbag module on a clean cloth to protect the module lid from scuffs, scratches or other damage.

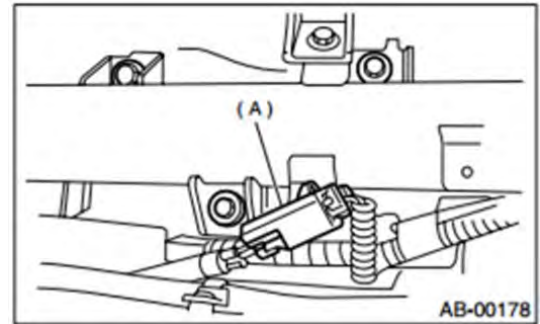

**STEP 2- TRIM COVER / LID REMOVAL:**

**VERY IMPORTANT:** Before removing the original trim cover / lid from the module, note the orientation of the cover in relation to the module as the module can be installed upside down in the cover. (TIP: The bottom or harness side goes toward the “SRS AIRBAG” side of the cover as shown.)

**CAUTION:** During cold temperatures always let the cover warm to room temperature before attempting claw removal. In all cases, limit any distortion of the airbag cover to avoid damaging it.



- Using a trim clip removal tool and starting on the harness-side of the module assembly as shown in the sequence below, CAREFULLY insert the tool and twist ONLY AS MUCH AS IS REQUIRED to release the slightly longer center retaining claw from the trim cover. Once released with the tool, the other 6 claws will release easily by hand.
- Rotate the inflator portion of the assembly outward from the cover to release the 7 label-side claws and separate the cover from the module. No tool is required as all the 7 label-side claws are the same size.

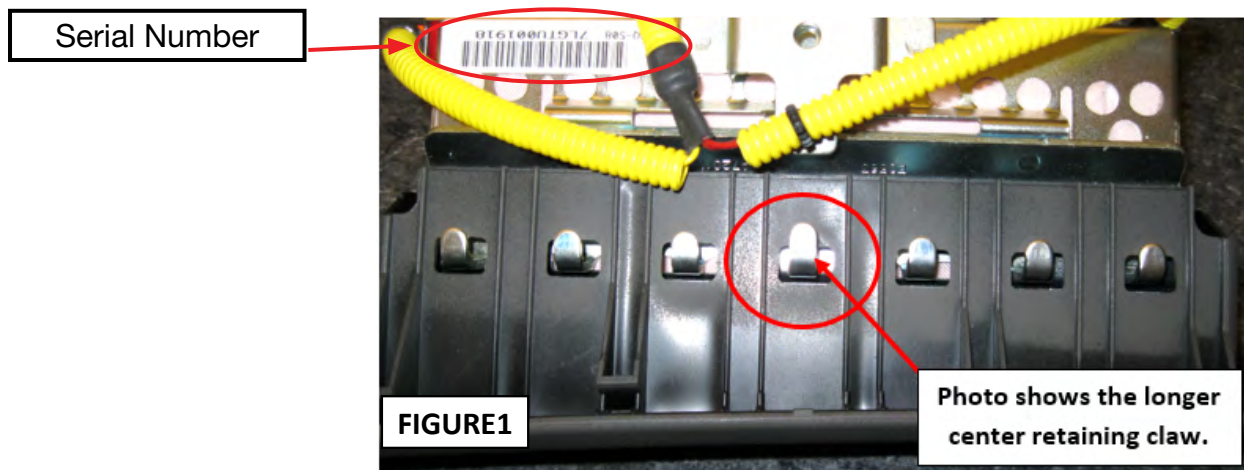

*Continued...*

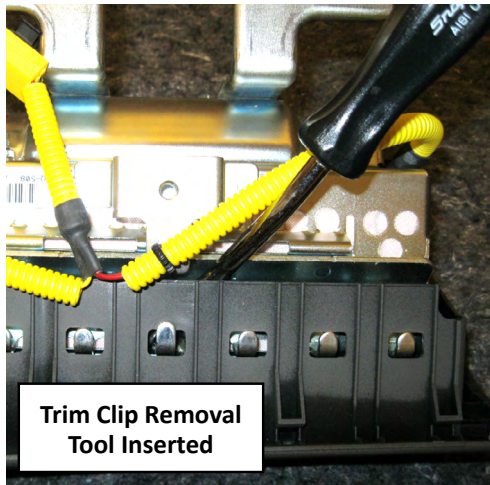

Trim Clip Removal Tool Inserted



Twisting the Tool and Releasing Center Claw



Center Claw Released

All Harness-Side Claws Released

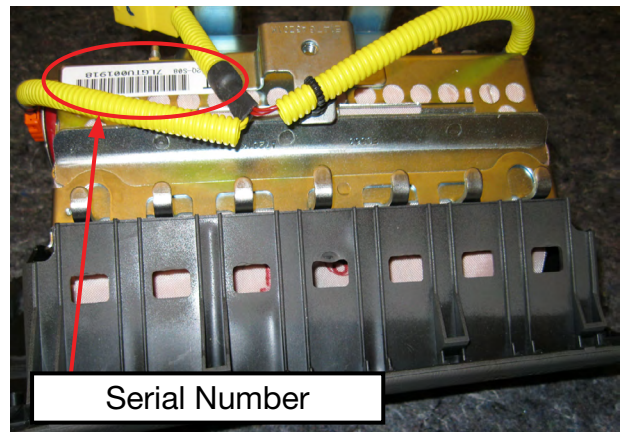

Serial Number

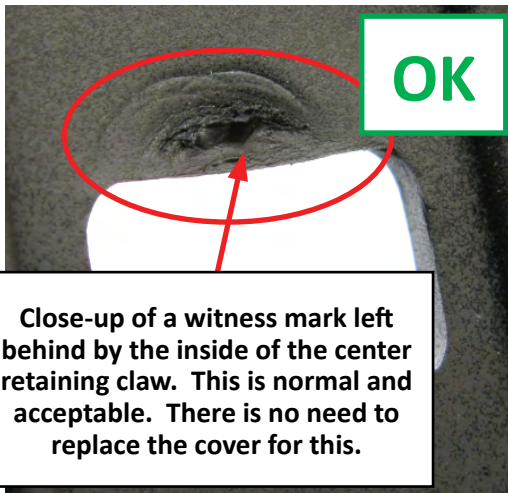

Close-up of a witness mark left behind by the inside of the center retaining claw. This is normal and acceptable. There is no need to replace the cover for this.



Inside view of a damaged cover, shows tearing and material missing. This cover must be replaced.

**Step 3-** Confirm the orientation is correct as outlined earlier in this bulletin. Refit the original cover, if reusable, onto the replacement module assembly. Make sure all the claws are fully engaged (see Figure 1 above). When properly installed, the cover should feel loose with a small amount of freeplay. If the cover is tight (no freeplay or looseness), it most likely is not fully engaged onto the claws.

*Continued...*

**Step 4- VERY IMPORTANT:** Record the alpha-numeric serial numbers for **BOTH** the original and the replacement module assemblies on the hard copy of the Repair Order. See pages 17 & 18 for serial number location photos. **For SOA and SDC Retailers ONLY**, this information will be required for claim approval. **For SNE retailers**, this information will be required for completion of the Part Return Notice which will be forwarded by the retailer to the PCC.

**Step 5-** After confirming the cover is properly fitted to the module, reinstall the module assembly in reverse order of disassembly. Before installing the glove box assembly, reconnect the negative battery cable. Turn the ignition key “ON” and confirm the AIRBAG warning light comes on then cycles off properly. Once proper warning light operation is confirmed, reinstall the glove box assembly.

**Step 6-** Place the removed module assembly into the returnable shipping box. Refer to the **SHIPPING DOCUMENTATION AND INSTRUCTIONS (Appendix A)** found toward the end of this bulletin.



**IMPORTANT: UNDER NO CIRCUMSTANCES SHOULD ANY AIRBAG MODULES BE RETURNED TO SUBARU OF AMERICA, INC.**

*Continued...*

**\*SERVICE PROCEDURE FOR 2005-2009MY LEGACY / OUTBACK MODELS\***  
**Inflator Type 2, Inflator Kit Part Number: 98279AG05A or B**

**CAUTION: Refer to the “CAUTION” section in the General Description portion of Airbag System AB in the Body Section of the Service Manual before handling or servicing any airbag module!**

**STEP 1- PREPARATION:**

- Record the customer’s radio station presets (and Navigation favorites where applicable).
- Turn the ignition “OFF”.
- Disconnect the Negative (ground) cable from the battery and wait **at least 60 seconds** before proceeding further.
- Follow the procedures in the applicable Service Manual for removing the instrument panel assembly as required to access the passenger side airbag module.
- Disconnect the wiring harness and remove the airbag module.
- Secure the removed airbag module to the Airbag Deployment Fixture (part number J-39401-B).

**IMPORTANT NOTE:** The photos available at the time of this procedure’s preparation do not show the removed airbag module assembly as being secured to the J-39401-B Airbag Deployment Fixture during inflator replacement. Subaru of America, Inc. **STRONGLY RECOMMENDS ALWAYS** utilizing a J-39401-B fixture whenever performing **ANY** airbag inflator replacement service procedure.

**IMPORTANT: Whenever beginning to remove (or install) the airbag assembly, and periodically while performing the procedure or after stepping away, remove any possible static charge from your body by momentarily touching a clean, bare metal ground point on the vehicle (e.g. the door striker). Remove from your person all electronic devices including cell phones before proceeding.**

**IMPORTANT: DO NOT destroy or damage the Kit Box as it MUST be used for the original inflator’s return shipping.**

Open the Kit Box and confirm all the necessary components are included:

- 4 Self-Locking nuts
- New **Type 2** Inflator (pink collars on each end identify it as the replacement part)
- New Inflator Harness
- 1 new Stopper Plate (A)
- Heat Insulating Plate
- Electro-Tap (red shorting crimp connector)
- Shipping Documentation

Inspect the new **Type 2** inflator to confirm the locating protrusions on each of the pink collar portions are aligned as shown below. The “short” collar can be rotated as needed to align it with the protrusion on the “long” collar if necessary.

*Continued...*

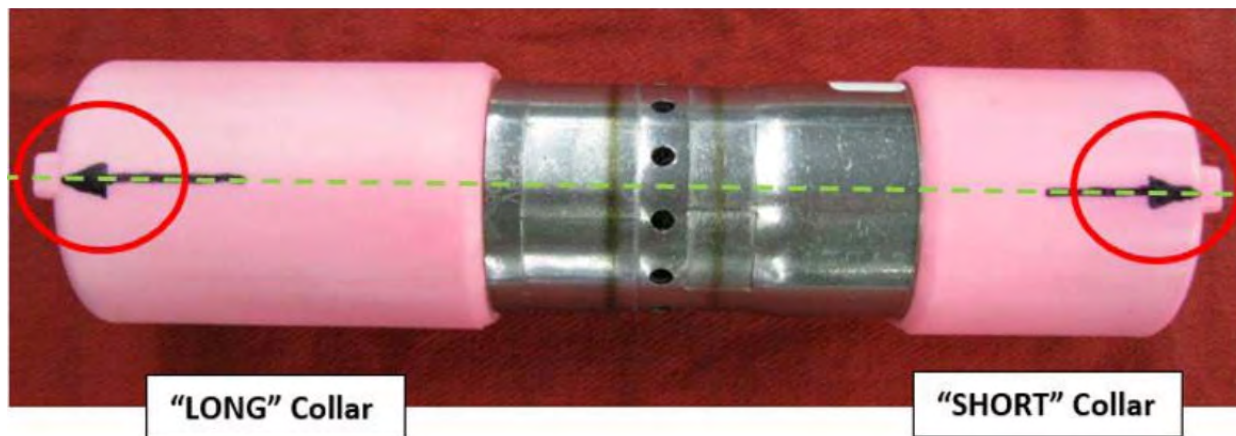

**STEP 2-** To access the passenger’s airbag module, the complete instrument panel assembly must be removed. Follow the procedures in the applicable Service Manual for removing the instrument panel assembly in addition to the necessary related interior trim components.

**NOTE:** When removing the “A” pillar trim, be **VERY CAREFUL** not to damage the upper metal retaining clip. The clip is located just below where the trim panel meets the head liner. If the metal retaining clip becomes damaged or separated from the trim panel, the trim panel **MUST** be replaced as the clip is not available separately. Use a plastic trim tool to push and release the upper portion of the metal clip from the body. Be careful to not pull the trim panel open any further than necessary to gain access for releasing the clip. There is a plastic retaining clip in the lower portion of the trim panel which will release easily once the upper retaining clip is loose. At reassembly and using a plastic trim tool, make sure the inner lip of the door weatherstrip overlaps the outer fabric edge of the trim panel to help secure it.

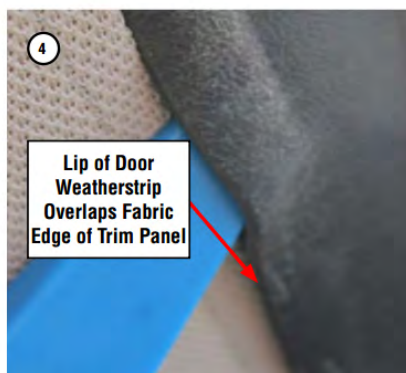
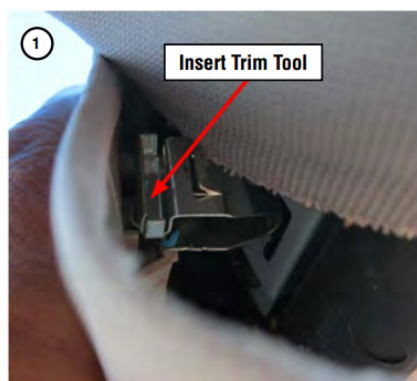

Once the instrument panel assembly has been removed from the vehicle, **CAREFULLY** release the retaining claws and separate the airbag bag module.

*Continued...*

**REMINDER:** It is **STRONGLY RECOMMENDED** the removed airbag module **ALWAYS** be mounted to the Airbag Deployment Fixture (part number J-39401-B and file photo shown below) to better secure it during the inflator replacement procedure. When mounting the module to the fixture, pay close attention to the harness routing. Always perform this work in an area away from others to reduce chances of inadvertent injury should any deployment occur. Take your surroundings into account to avoid possible hazards should an inadvertent deployment occur or sources of static or other electricity that could potentially induce such a deployment.



**STEP 3-** Remove the harness tube from the retainer bracket holders.

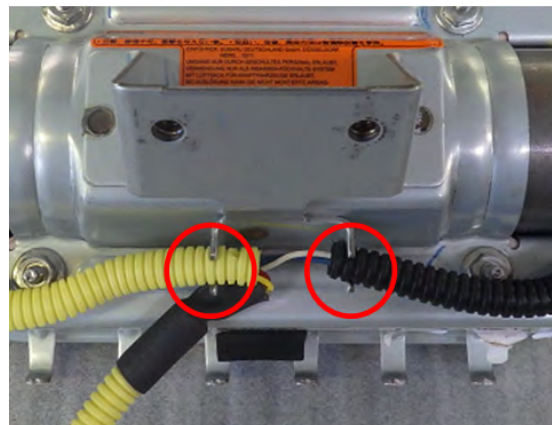

**STEP 4-** Using a scissor or wire cutter (no knives or razors) **CAREFULLY** cut the black harness cover tube (approximately 1 1/2 inches) enough to expose the blue and white wires inside and provide enough room to install the Electro-Tap (shorting) connector.

**TAKE YOUR TIME AND BE CAREFUL TO NOT CUT THE 2 WIRES!**

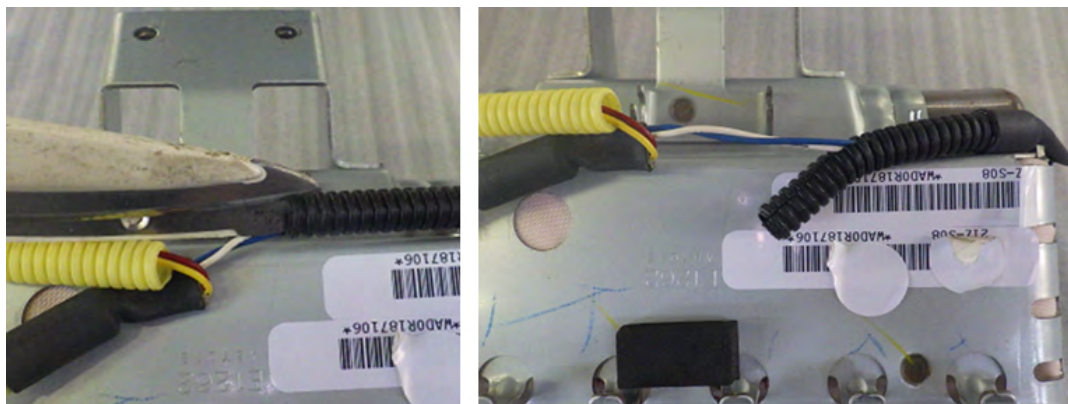

*Continued...*

**STEP 5-** Short the white and blue wires together by installing the Electro-Tap connector. The connector creates a short circuit which acts as a safeguard to prevent against static discharge that may deploy the removed inflator. The tab portion of the Electro-Tap connector **MUST** be cut off prior to use to insure a good short-circuit is made as shown in the illustration below. **Follow the sequence below** for installing the Electro-Tap connector. Use pliers to squeeze closed the two sections of the connector together, **one section at a time**.

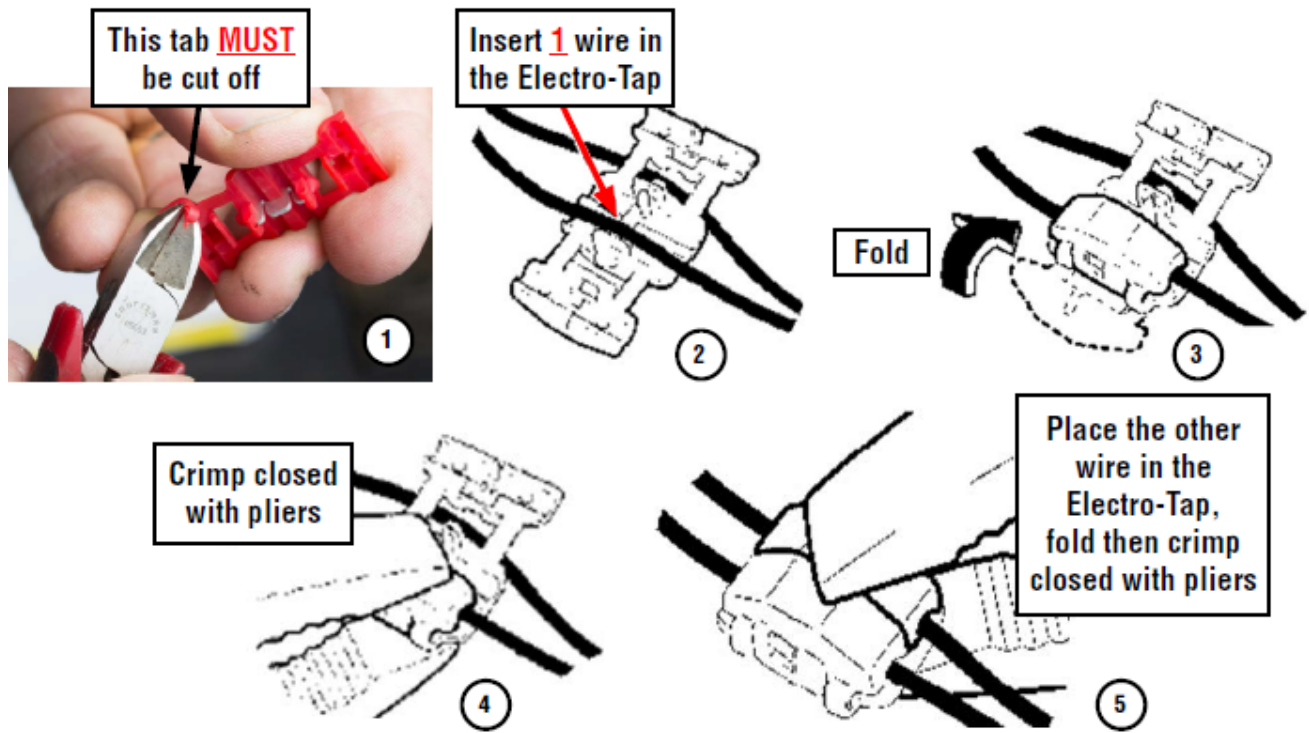

**STEP 6-** Once the Electro-Tap connector is fully crimped in place, cut the white and blue wires **on the body harness connector side** of the Electro-Tap connector.

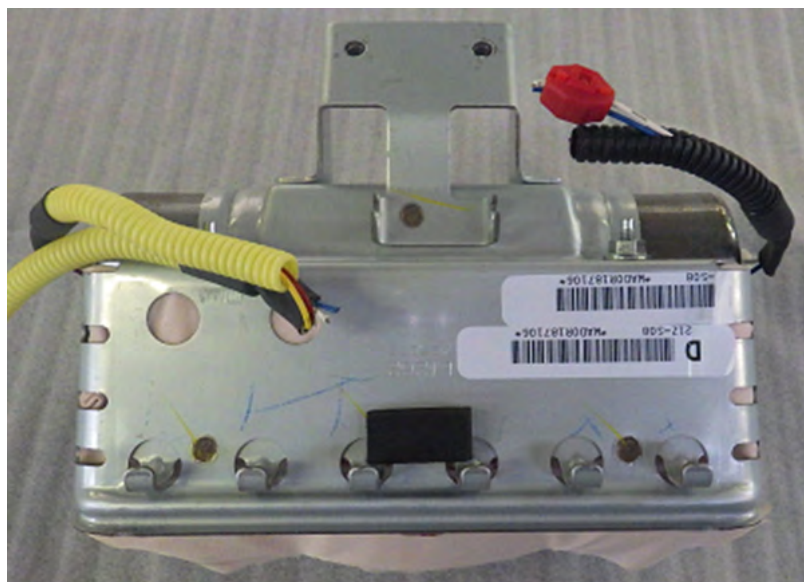

*Continued...*

**STEP 7-** Loosen and remove the four (4) 10mm self-locking nuts and discard them.

**VERY IMPORTANT: Under no circumstances should any impact or power tools be used when performing these procedures. HAND TOOLS ONLY!**

**NOTE: NEVER ATTEMPT TO REMOVE THE HARNESS CONNECTORS FROM THE INFLATOR!**

**STEP 8-** With the self-locking nuts removed, slide the original inflator out of the mounting bracket. Place the removed original air bag inflator back into the “cradle” of the Kit Box insert.

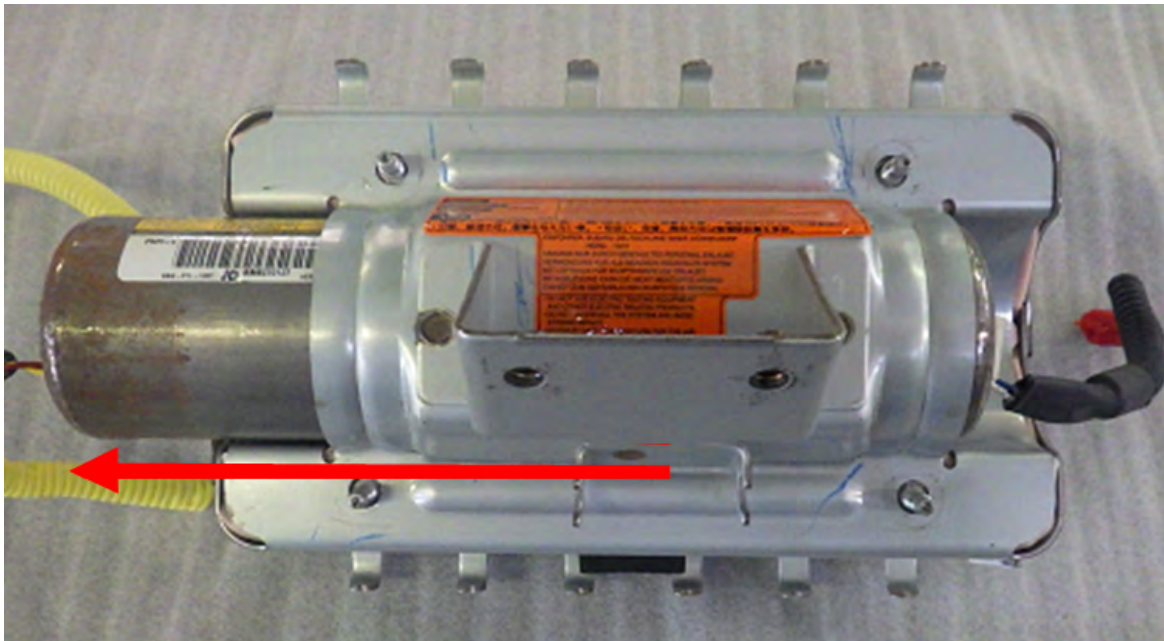

**STEP 9 - VERY IMPORTANT:** Record the **11-digit alpha-numeric serial number** for both the **new Type 2** and the **original Type 1 inflators** on the hard copy of the Repair Order. For **SOA and SDC Retailers ONLY**, this information will be required for claim approval. For **SNE retailers**, this information will be required for completion of the Part Return Notice which will be forwarded by the retailer to the PCC.

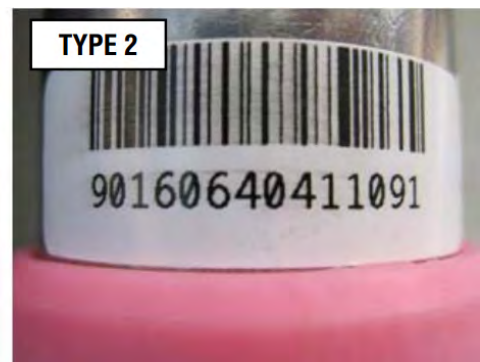

*Continued...*



**STEP 10-** CAREFULLY remove the airbag from the mounting bracket (case).

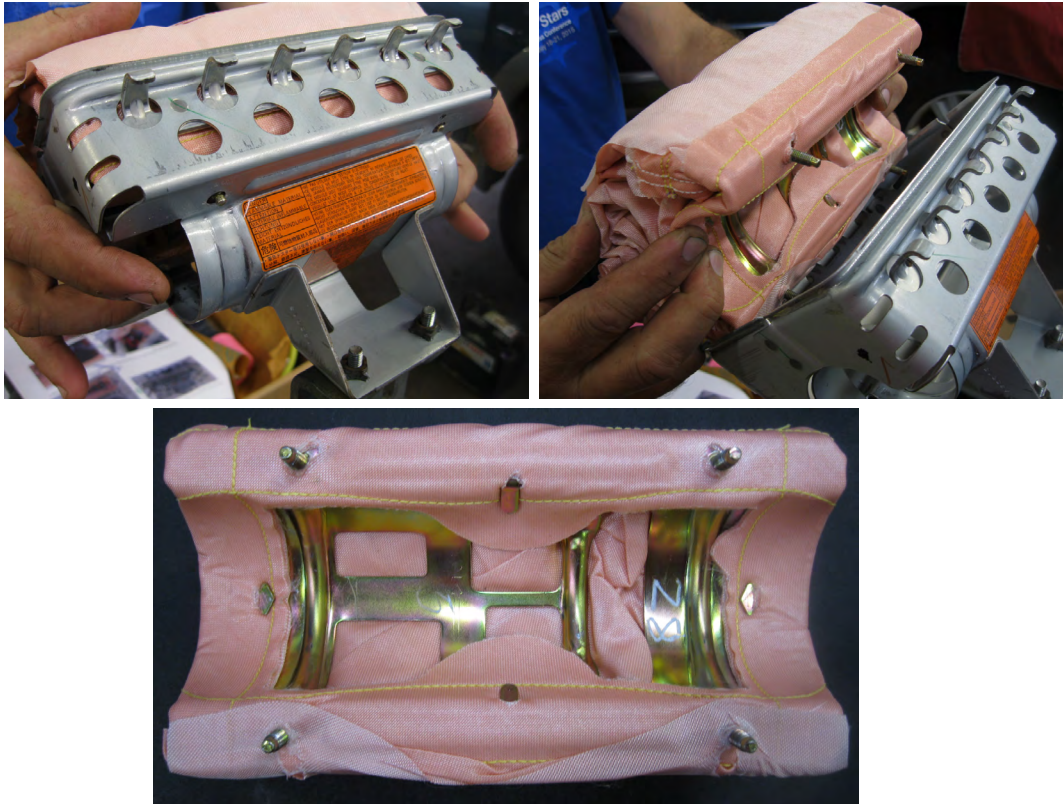

**STEP 11-** CAREFULLY Install the heat insulating plate into the back (inflator) side of the airbag as shown in photo 1 below. **The plate can only be installed in one direction.** Make sure the 2 retaining claws come through the corresponding holes in the insulator plate as shown in photo 2. The airbag is ready to refit to the mounting bracket in photo 3 and is being reinstalled in photo 4.

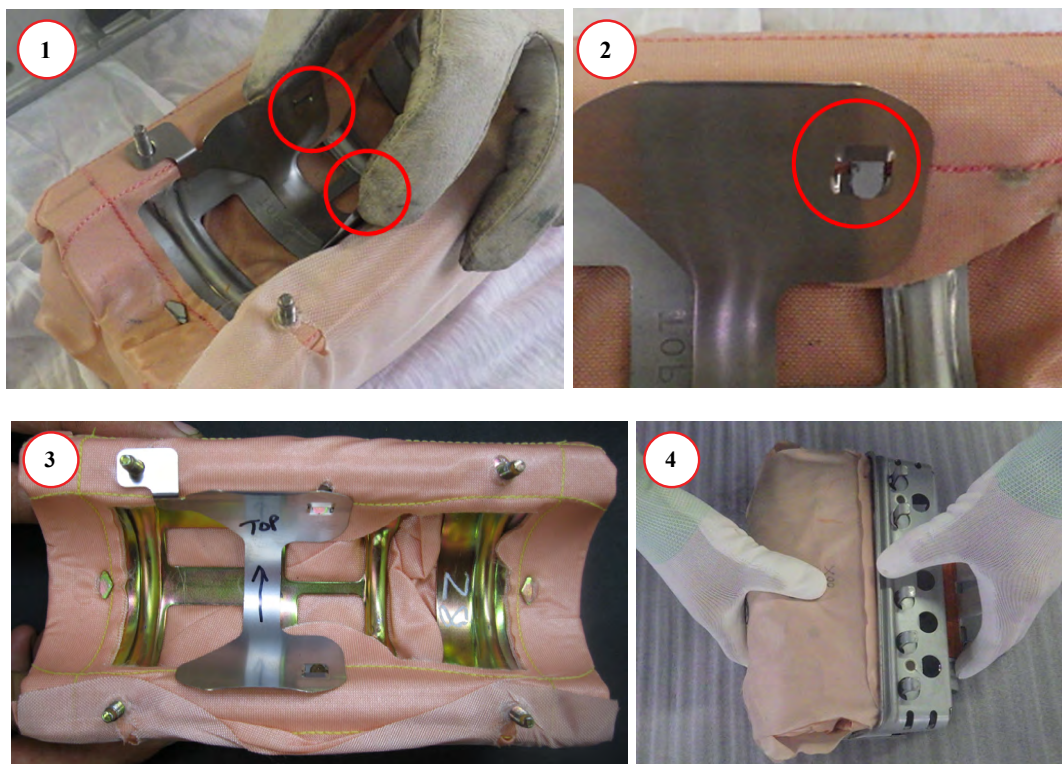

*Continued...*

**STEP 12-** Install the new Stopper Plate (A) onto the mounting bracket.

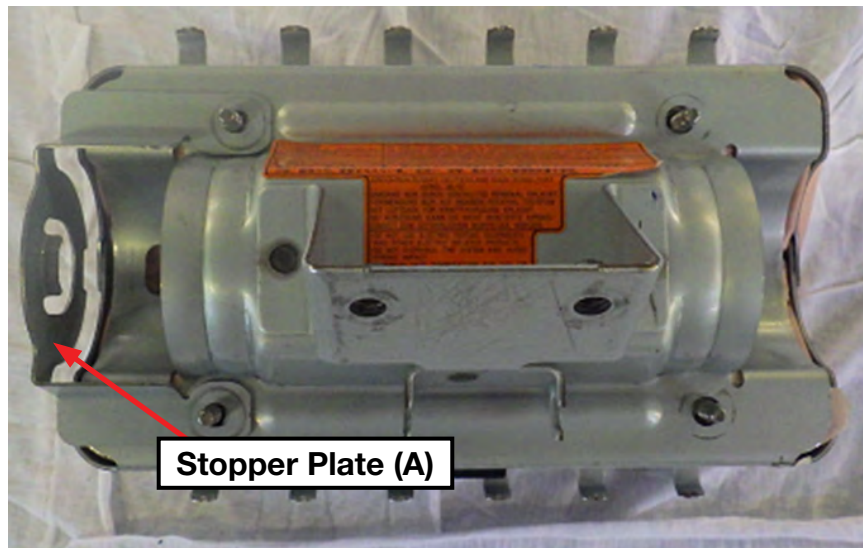

**STEP 13-** Install the new inflator into the mounting bracket with the short pink collar end toward the new Stopper Plate (A). Align the protrusion on the end of the collar with the notch in the stopper plate. There is also a tab on the inside of Stopper Plate (A) which will align with the notch in the end of the collar. When properly installed the collar will be tight against the plate with no gap.

**IMPORTANT: Do not peel the white harness connection dust cover at this time.**

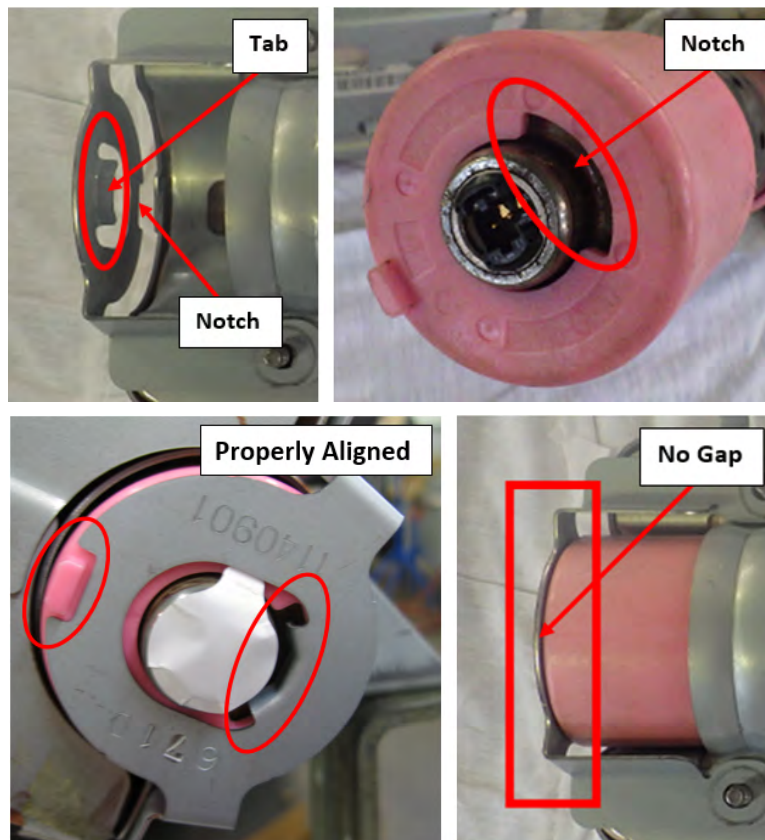

*Continued...*

**STEP 14-** Install the original stopper plate onto the opposite end of the mounting bracket / inflator in the same manner as described in STEP 13 above. Rotate the inflator as needed to insure there is no gap between the collar and stopper plate. **NOTE:** Stopper plates only fit one way as their holes are offset.



**STEP 15-** Reinstall the 4 **NEW** self-locking nuts. **SLOWLY** tighten (to prevent over-tightening) then torque the nuts to 31-38 inch-pounds. When complete, use a marker to indicate they have been fully tightened.



**STEP 16-** The new inflator wiring harness has 2 “sides” with 2-pin connectors on both ends. The side with the black harness tube goes with the black inflator connector and the other side (yellow harness tube) will connect to the orange connector. The end of the inflator aligned with the new Stopper Plate (A) will have a black harness connector while the connector on the opposite end of the inflator will be orange. This makes it impossible to install the harness backwards as the tangs (shown in Step 17) are also in different positions.

**BEFORE** connecting the harness to the inflator, make sure the harness is not twisted as shown below.

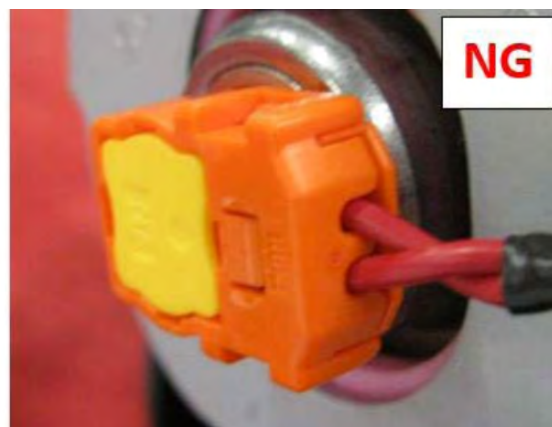

*Continued...*

**STEP 17-** Peel off **one** white dust cover and **CAREFULLY** align the tang of the new harness connector with the receiving slot in the inflator connector. This assures proper routing of the harness in relation to the airbag assembly mounting bracket.

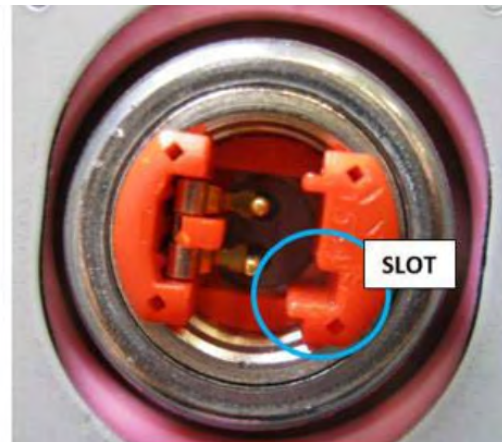

**IMPORTANT: NEVER PEEL BOTH THE WHITE DUST COVERS OFF AT THE SAME TIME!**



Once alignment is confirmed, push down firmly to engage the connector. When fully seated, press down on the yellow tab locking the connector to the inflator.

**STEP 18-** After connecting both sides of the harness, refit the harness cover tube back into the mounting brackets.

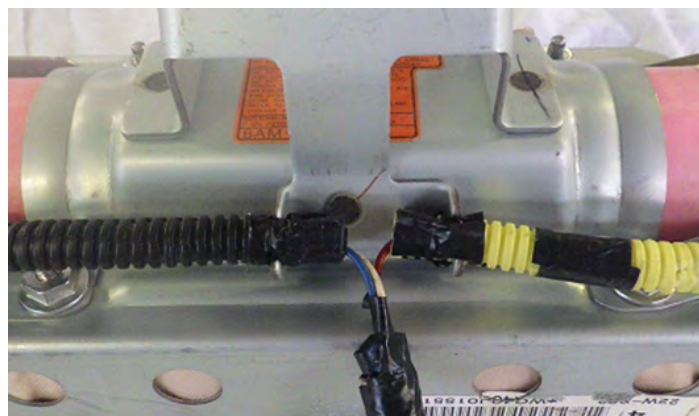

**VERY IMPORTANT:** After connecting the new harness to the inflator, **both sides MUST be routed as shown** in the “New Harness Properly Installed” photo below.

*Continued...*

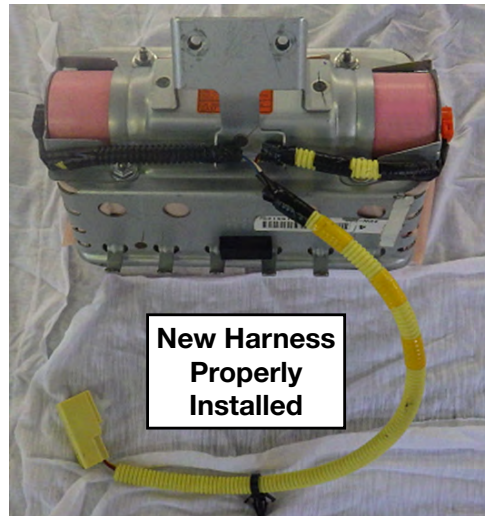

**STEP 19-** Refit the airbag module to the instrument panel.

**TIP:** To eliminate a possible source of a rattling sound from the dash, wrap the 2 hooks and locator pin with non-woven material, p.n. SOA963W110 (or an equivalent self-adhesive foam) as shown below.

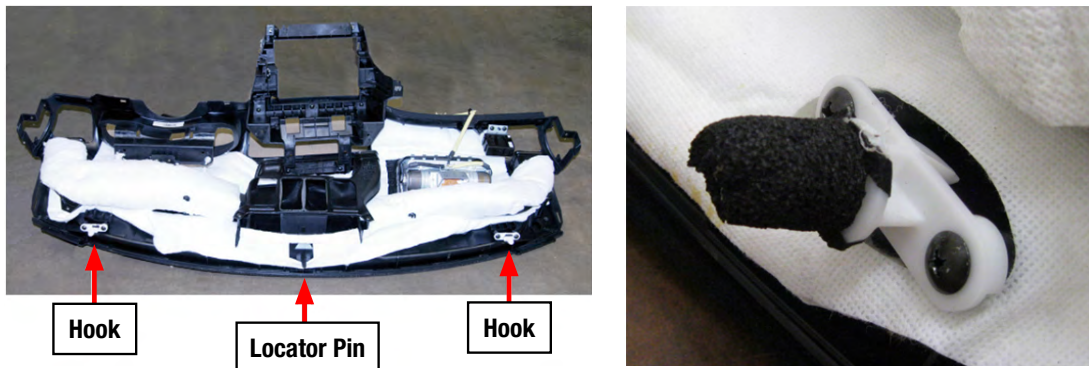

**REMINDER:** One sheet of the SOA963W110 non-woven material is enough for approximately 8 vehicles.

**STEP 20-** Reinstall the instrument panel assembly into the vehicle in reverse order of disassembly. Once the negative battery cable has been reconnected, turn the ignition key “ON” and confirm the AIRBAG warning light comes on then cycles off properly. Once proper warning light operation is confirmed, reinstall the remaining components and reset the radio station presets (and Navigation favorites where applicable) to complete the procedure.

**STEP 21-** If not already done, place the removed original air bag inflator in the “cradle” of the Kit Box insert, with a completed SOA warranty parts tag (MSA5W1901A) attached to it. The tag must contain the following information: **Claim Number, Repair Date, 17-digit VIN, and vehicle mileage.** Refer to the “PART RETURN PROCEDURES” section of this bulletin for further return shipping instructions and information. **Ensure both the removed and installed inflator serial numbers have been recorded correctly as previously instructed on the repair order hard copy before returning the removed part to your Parts Department.**

**IMPORTANT: UNDER NO CIRCUMSTANCES SHOULD ANY AIR BAG INFLATORS BE RETURNED TO SUBARU OF AMERICA, INC.**

**\*SERVICE PROCEDURE FOR 2004-2005MY IMPREZA, WRX AND STI MODELS\***  
**Inflator Type 2, Part Number 98279FE070\***

**CAUTION: Refer to the “CAUTION” section in the General Description portion of Airbag System AB in the Body Section of the Service Manual before handling or servicing the airbag module!**

**STEP 1- PREPARATION:**

- Turn the ignition “OFF”.
- Disconnect the Negative (ground) cable from the battery and wait **at least 60 seconds** before proceeding further.
- Remove the glove box assembly following the procedure in the applicable Service Manual.

**IMPORTANT: Whenever beginning to remove (or install) the airbag assembly, and periodically while performing the procedure or after stepping away, remove any possible static charge from your body by momentarily touching a clean, bare metal ground point on the vehicle (e.g. the door striker). Remove from your person all electronic devices including cellphones before proceeding.**

- Disconnect the airbag module harness connector from the support beam bracket.
- Remove the 3 retaining bolts and **CAREFULLY** remove the airbag module from the vehicle and place it on a clean cloth to protect the dash trim surface portion from damage.

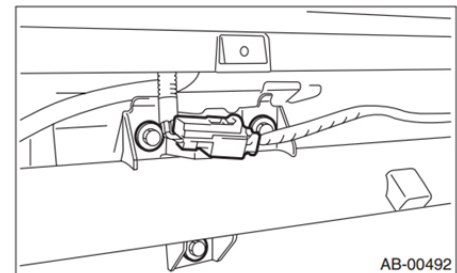

**NOTE:** There may be a Security Module secured with the lower airbag module mounting bolt on some models.

**IMPORTANT: DO NOT destroy or damage the kit box as it MUST be used for the original inflator’s return shipping.**

- Open the Kit Box and confirm all the necessary components are included:
  - 4 Self-Locking nuts
  - New **Type 2** Inflator (pink collars on each end identify it as the replacement part)
  - New Inflator Harness
  - New Stopper Plate
  - Electro-Tap (red shorting crimp connector)
  - 1 ½” X 2 ¼” piece of self-adhesive Sponge Tape
  - Shipping Documentation and Instructions



**IMPORTANT:** The removed airbag module must be mounted to the Airbag Deployment Fixture (part number J-39401-B) as shown in the photo below to better secure it during the inflator and wiring harness component replacement procedures. Always perform this work in an area away from others to reduce chances of inadvertent injury should any deployment occur. Take your surroundings into account to avoid possible hazards should inadvertent deployment occur or sources of static or other electricity that could potentially induce such a deployment.

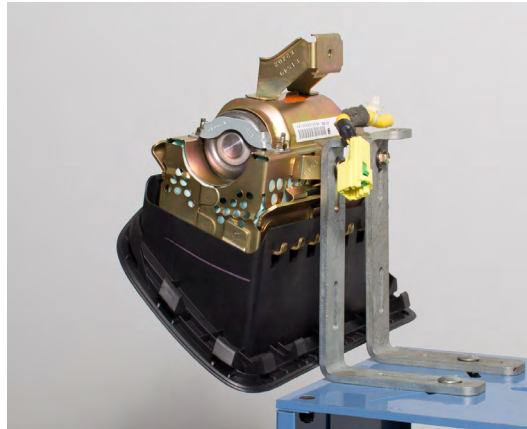

**STEP 2-** Peel the Sponge Tape and remove the harness clip from the retainer bracket by pushing the tangs inward with a flat-blade screwdriver as shown below. Always remove any Sponge Tape adhesive residue from the airbag mounting bracket using mild solvent on a clean shop cloth. **CAUTION:** Never use any silicone-based products for this purpose.

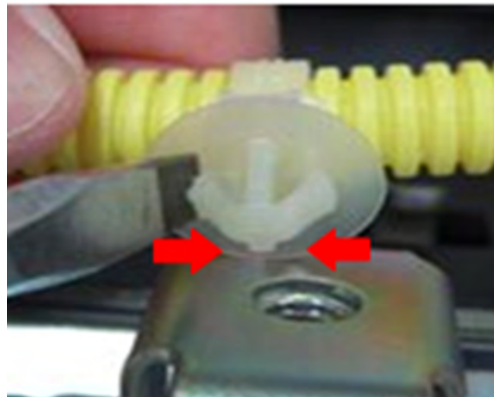

**STEP 3- CAREFULLY** cut the yellow harness cover enough (approximately 2 inches) to expose the 2 red (or yellow) wires inside and provide enough room to install the Electro-Tap (shorting) connector using a wire cutter or scissor (no knives or razors). **TAKE YOUR TIME AND BE CAREFUL TO NOT CUT THE 2 WIRES!**

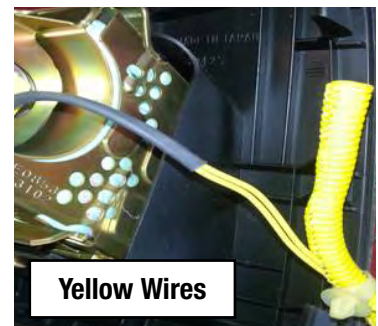
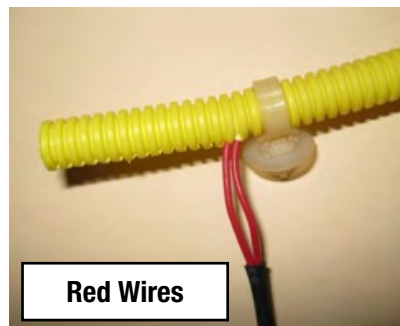

**STEP 4-** Short the 2 wires together by installing the Electro-Tap connector. The connector creates a short circuit which acts as a safeguard to prevent against static discharge that may deploy the removed inflator. The tab portion of the Electro-Tap connector **MUST** be cut off prior to use to insure a good short-circuit is made as shown in the illustration below. **Follow the sequence** below for installing the Electro-Tap connector. Use pliers to squeeze closed the two sections of the connector together, **one section at a time**.

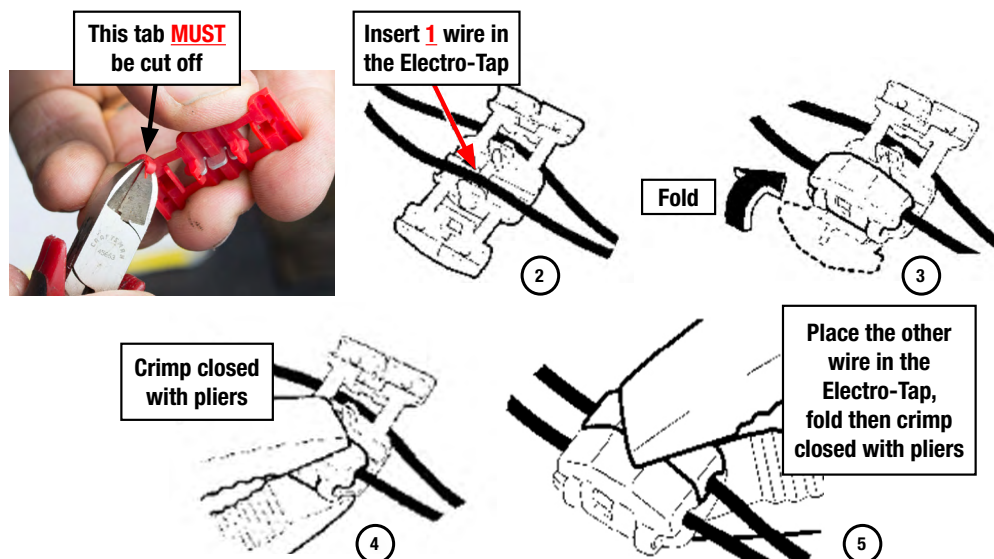

**STEP 5-** Once the Electro-Tap connector is fully crimped in place, cut the 2 wires on the **body harness connector side** of the Electro-Tap connector.

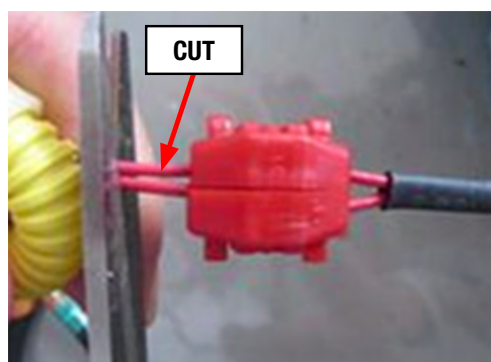

**VERY IMPORTANT: Under no circumstances should any impact or power tools be used when performing these procedures. HAND TOOLS ONLY!**

**STEP 6-** Remove the two 8mm self-locking nuts securing the stopper plate. Loosen but **do not remove** the other two nuts on the mounting bracket as leaving them in place will help keep the airbag assembly together.

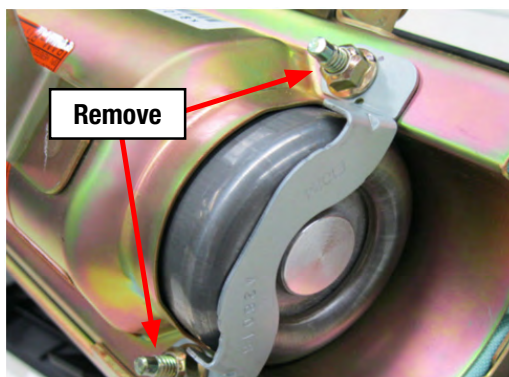



**STEP 7-** With the stopper plate removed and the other 2 self-locking nuts loosened, unseat the inflator off the mounting bracket end plate then rotate it slightly **CLOCKWISE** to make it easier to remove as shown in the photo to the right. Slide the inflator out of its mounting while feeding the cut off portion of the wiring harness through the “D-Shaped” hole in the end of the mounting bracket. **NEVER ATTEMPT TO REMOVE THE HARNESS FROM THE INFLATOR!** Place the removed original air bag inflator in the “cradle” of the Kit Box insert.



**STEP 8- VERY IMPORTANT:** Record the **11-digit alpha-numeric serial number for both the removed (Type 1) and 14-digit numeric serial number for the new (Type 2) inflator** on the Repair Order hard copy. For **SOA and SDC Retailers ONLY**, this information will be required for claim approval. For **SNE retailers**, this information will be required for completion of the Part Return Notice which will be forwarded by the retailer to the PCC.

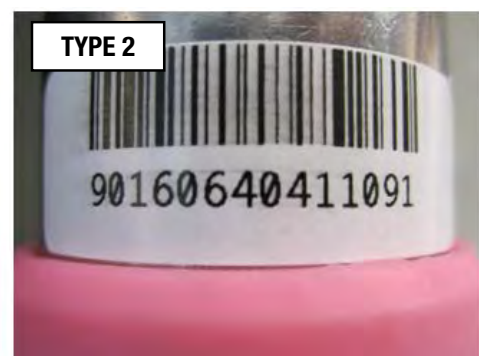

**STEP 9-** Inspect the new **Type 2** inflator to confirm the locating protrusions on each of the pink collar portions are aligned as shown below. The “short” collar can be rotated as needed to align it with the protrusion on the “long” collar if necessary.

**NOTE:** The **Type 2** inflator is installed in the opposite direction of the original. This change puts the connector on the other end. The new harness has been extended approximately 2” to compensate.

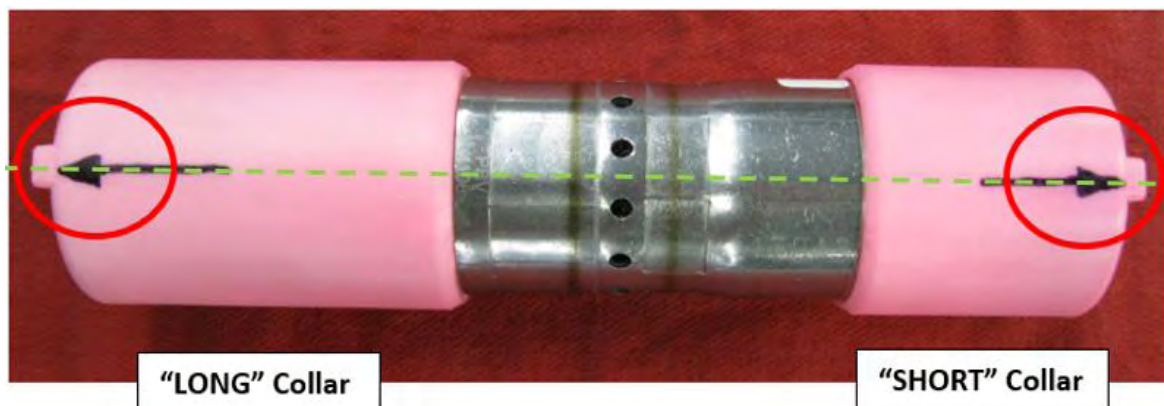

**STEP 10-** Install the new inflator into the mounting bracket, short collar with the “blank” (no harness connector) end going in first. The protrusion on the short collar will fit in the gap at the bottom of the fixed stopper plate portion. At the same time, the ridge portion of the inflator side of the stopper plate will fit into the “notch” in the end of the collar. When properly installed, the end of the inflator will be seated tight against the mounting bracket with NO gap. DO NOT peel the white harness connection dust cover at this time.

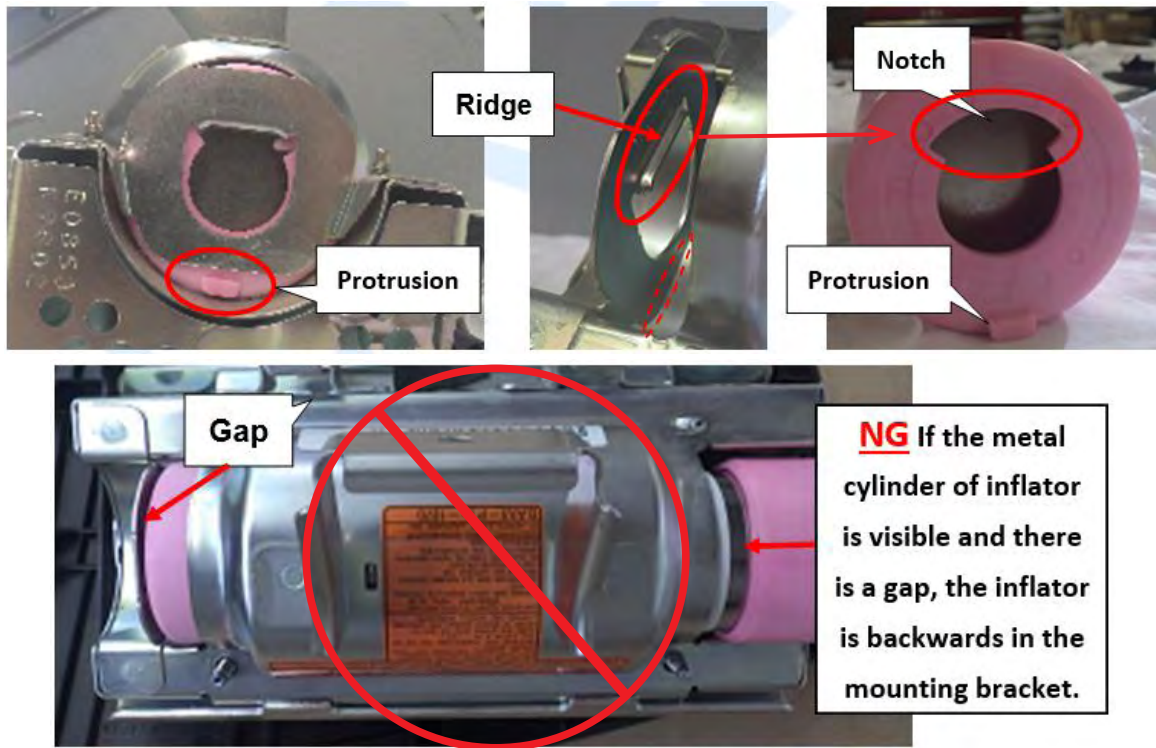

**STEP 11-** Install the new stopper plate over the harness connector end of the new inflator.

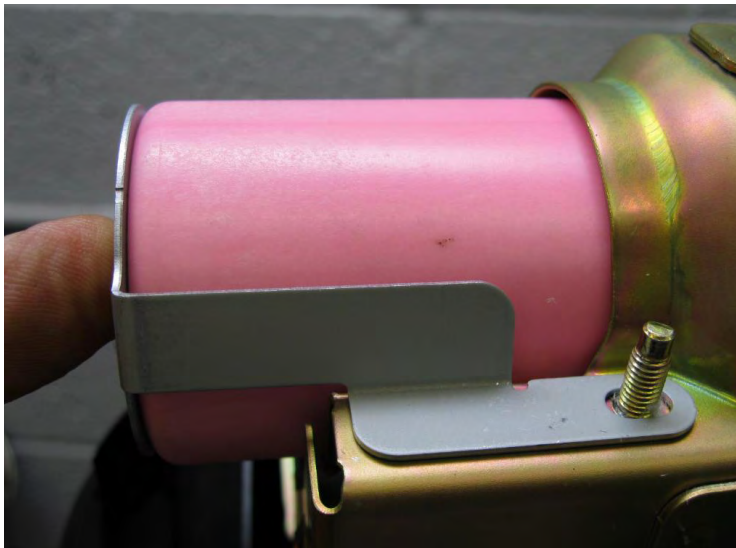

**Always hold the stopper plate tight against the inflator as shown when installing and tightening the NEW self-locking nuts. NEVER reuse the original nuts.**

Remove the 2 nuts still installed on the mounting bracket and replace them with 2 **NEW** self-locking nuts. Once all 4 **NEW** nuts are in place, torque to 31 - 38 inch pounds in the new sequence shown below. Use a marker to mark the nuts after torquing indicating they have been fully tightened.



**STEP 12-** Peel off the white dust cover and **CAREFULLY** align the tang of the new harness connector with the receiving slot in the inflator connector. This assures proper routing of the harness in relation to the airbag assembly mounting brackets.

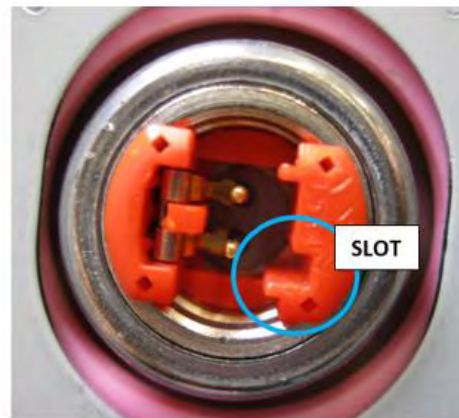

Once alignment is confirmed, push down firmly to engage the connector. When fully seated, press down on the yellow tab locking the connector to the inflator.

**STEP 13-** Reinstall the wiring harness retaining clip into its position on the mounting bracket.  
**IMPORTANT:** Confirm the harness is not twisted at the inflator connector as shown below.

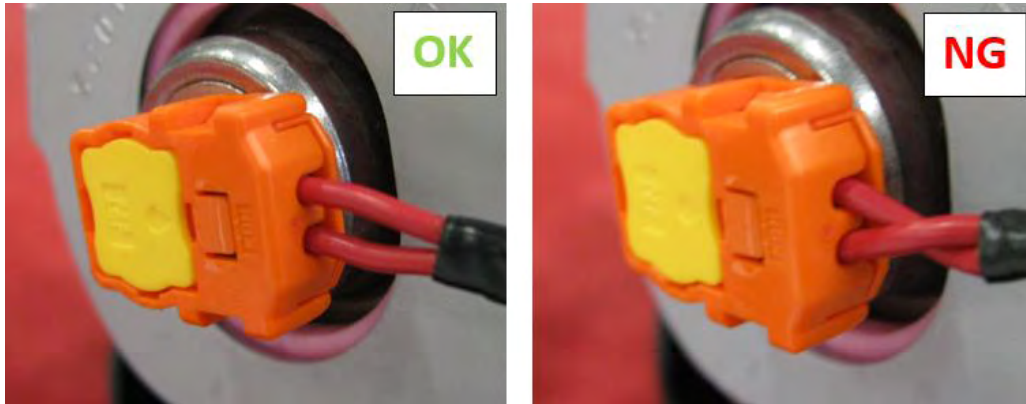

**STEP 14-** Peel the adhesive backing and install the new Sponge Tape onto the yellow harness tube first then adhere it to the airbag mounting bracket as shown in the illustrations below.

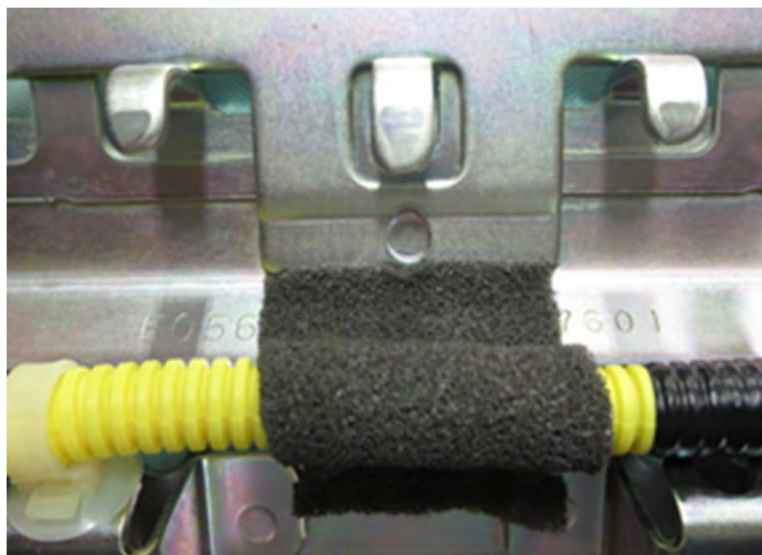

**Placement of Sponge Tape**

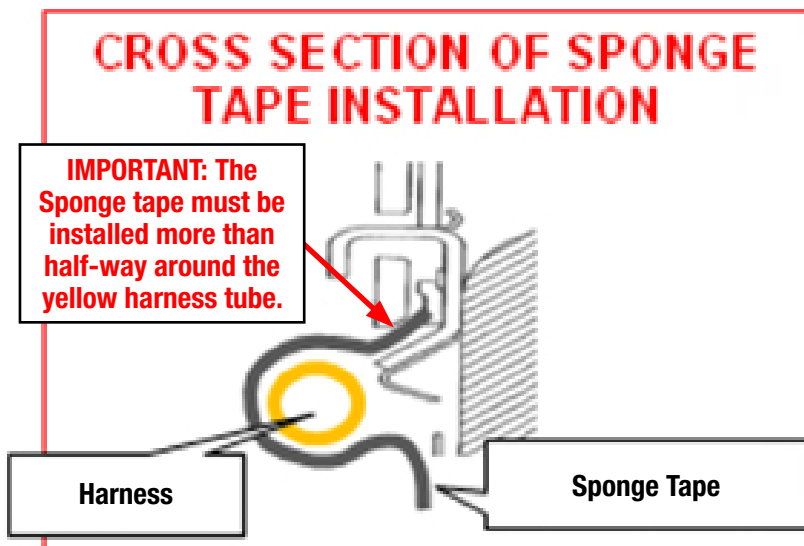

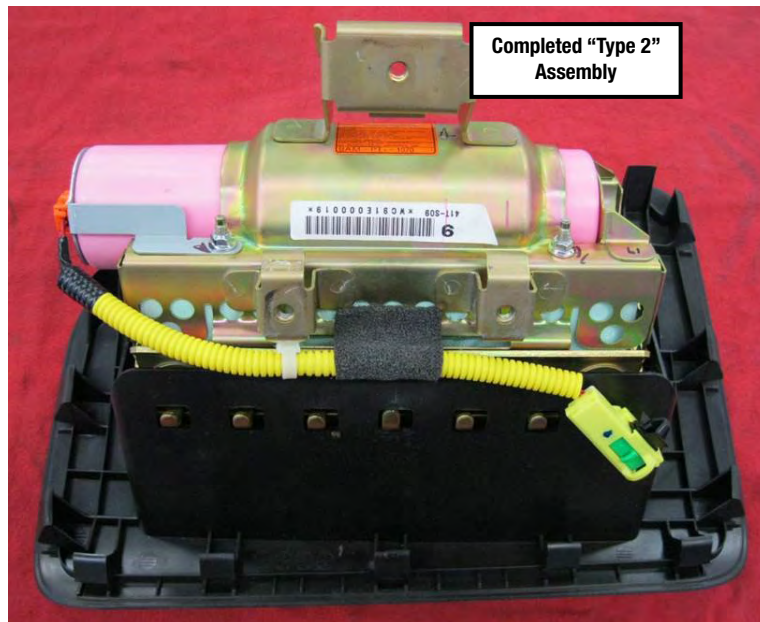

**STEP 15-** Reinstall the airbag assembly into the vehicle in reverse order of disassembly. **NOTE:** If the accessory security module is installed to one of the airbag module mounting bolts, torque that specific bolt to 7.5 +/-1ft. lb. rather than the normal 5.4 ft. lb. specified in the Service Manual. Before installing the glove box assembly, reconnect the negative battery cable. Turn the ignition key “ON” and confirm the AIRBAG warning light comes on then cycles off properly. Once proper warning light operation is confirmed, reinstall the glove box assembly while making sure the cord loop for the opening dampener (if equipped) stays connected to complete the procedure.

**STEP 16-** Place the removed air bag inflator in the “cradle” of the Kit Box insert, with a completed SOA warranty parts tag (MSA5W1901A) attached to it. The tag must contain the following information: **Claim Number, Repair Date, 17-digit VIN, and vehicle mileage.** Refer to the “PARTS RETURN PROCEDURES” section of this bulletin (page 4) for further return shipping instructions and information.

**IMPORTANT: UNDER NO CIRCUMSTANCES SHOULD ANY AIR BAG INFLATORS BE RETURNED TO SUBARU OF AMERICA, INC.**

**\*SERVICE PROCEDURE FOR 2006-2007MY IMPREZA, WRX and STI MODELS\***

**Replacement Airbag Module Assembly Part Number: 98279FE12A**

**IMPORTANT NOTES:**

The new module assembly does not include the lid (outer trim cover). In this procedure, the lid is transferred to the new module from the original. In an extremely rare case where a lid gets damaged during the transfer, the part number for a replacement lid is 98279FE19AOE.

**CAUTION: Refer to the “CAUTION” section in the General Description portion of Airbag System AB in the Body Section of the Service Manual before handling or servicing any airbag module!**

**STEP 1- PREPARATION:**

- Turn the ignition “OFF”.
- Disconnect the Negative (ground) cable from the battery and wait at least 60 seconds before proceeding further.
  - Remove the glove box assembly following the procedure in the applicable Service Manual and using the tips below. The glove box is held in place by 7 screws.

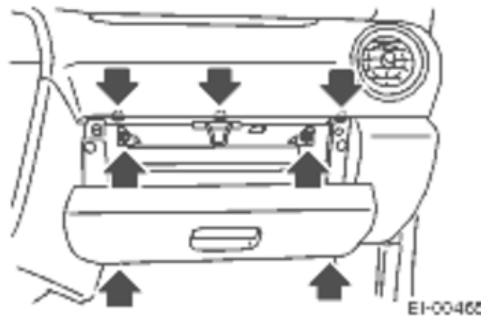

**IMPORTANT: Whenever beginning to remove (or install) the airbag assembly, and periodically while performing the procedure or after stepping away, remove any possible static charge from your body by momentarily touching a clean, bare metal ground point on the vehicle (e.g. the door striker). Remove from your person all electronic devices including cell phones before proceeding.**

- Disconnect the airbag module harness connector (A) and release it from the support beam bracket.

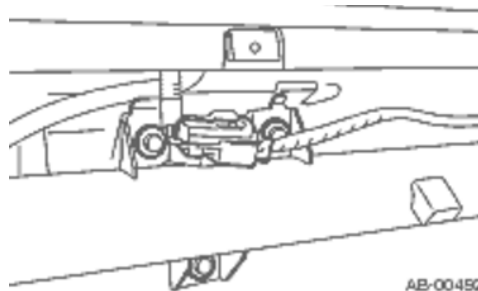

- Remove the 3 retaining bolts and CAREFULLY remove the airbag module from the vehicle and place it on a clean cloth to protect the dash trim outer surface portion from damage.

## STEP 2- TRIM COVER REMOVAL

- Using a trim clip removal tool and starting on the harness-side of the module assembly as shown in photos and sequence below, **CAREFULLY** insert the tool and twist **ONLY AS MUCH AS IS REQUIRED** to release the slightly longer center retaining claw from the trim cover. Once released with the tool, the other 6 claws will release easily by hand.
- Rotate the inflator portion of the assembly outward from the cover to release the 7 label-side claws and separate the cover from the module. No tool is required as all the 7 label-side claws are the same size.

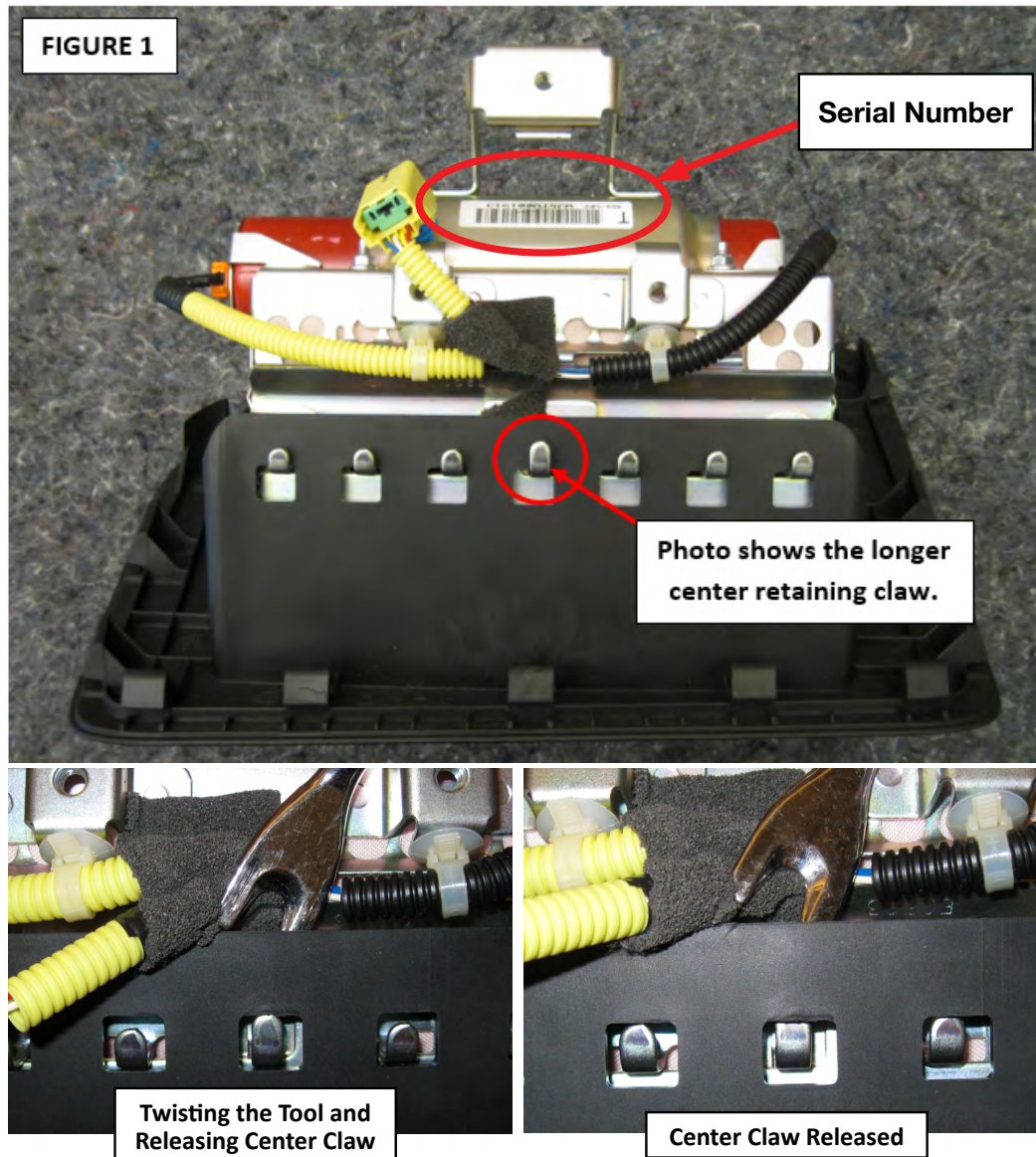

- Once all the harness-side retaining claws are released (EASILY done once the center claw is released), **CAREFULLY** separate the inflator module from the cover. After the harness-side of the module is free from the cover (2), simply rotate it to unhook the label-side retaining claws. Remove the cover completely as shown in (3) below.

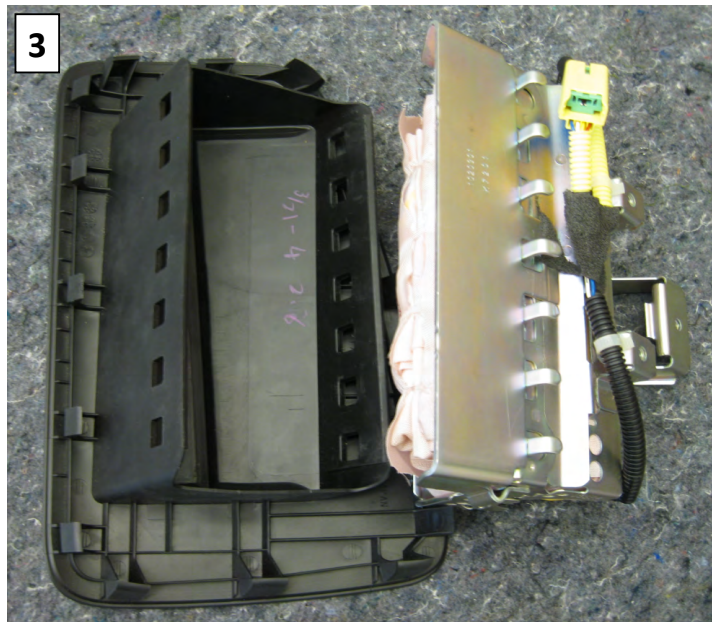
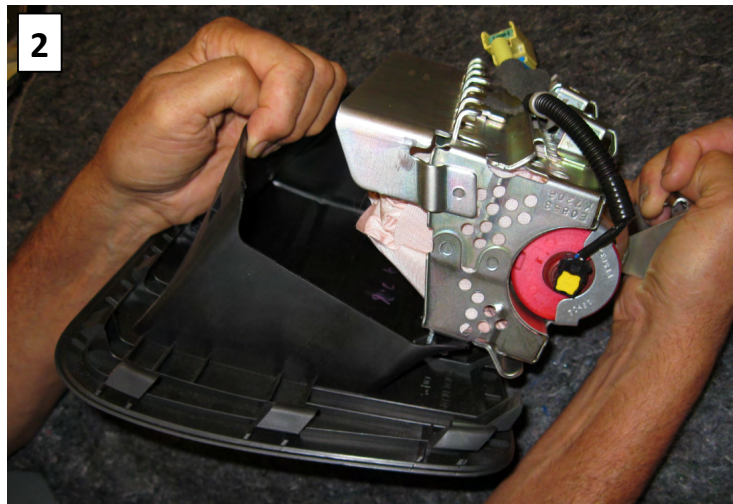
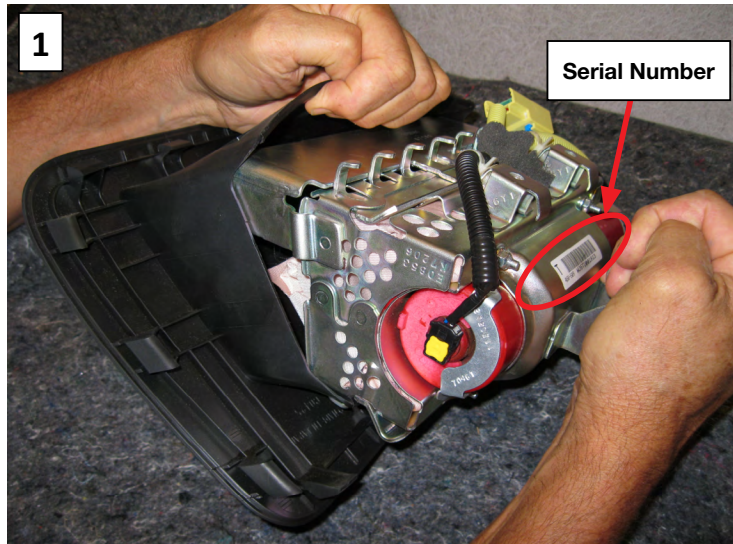



- Inspect the claw openings on the outside and inside of the cover for damage. If any found to look like the NG example photo below, the cover must be replaced.



**Step 3-** Refit the cover onto the replacement module assembly, making sure all the claws are fully engaged (see **Figure 1** above). For this application, the cover will only fit on the module one way. When properly installed, the cover should feel loose with a small amount of freeplay. If the cover is tight (no freeplay or looseness), it most likely is not fully engaged onto the claws.

**Step 4- VERY IMPORTANT:** Record the alpha-numeric serial numbers for **BOTH** the original and the replacement module assemblies on the hard copy of the Repair Order. See page 39 & 40 for serial number location photos. **For SOA and SDC Retailers ONLY**, this information will be required for claim approval. **For SNE retailers**, this information will be required for completion of the Part Return Notice which will be forwarded by the retailer to the PCC.

**Step 5-** Place the removed module assembly into the returnable shipping box. Refer to the **SHIPPING DOCUMENTATION AND INSTRUCTIONS: (Appendix A)** found toward the end of this bulletin.



**Step 6-** After confirming the cover is properly fitted to the module, reinstall the module assembly in reverse order of disassembly. The retaining tabs around the perimeter of the cover must also be fully seated so it sits flush with the surrounding dash pad surface. Before installing the glove box assembly, reconnect the negative battery cable. Turn the ignition key “ON” and confirm the AIRBAG warning light comes on then cycles off properly. Once proper warning light operation is confirmed, reinstall the glove box assembly to complete the procedure.

**IMPORTANT: UNDER NO CIRCUMSTANCES SHOULD ANY AIRBAG MODULES BE RETURNED TO SUBARU OF AMERICA, INC.**

## RECALL IDENTIFICATION LABEL

Type or print the necessary information on a Recall Identification Label. The completed label should be attached to the vehicle's upper radiator support.

Additional labels are available through normal parts ordering channels. The part number is MSA6P1302, which comes as one sheet of 20 labels.

<b>SUBARU</b>
Campaign Code
<b>TKA-20</b>
COMPLETED
DIST./DEALER NO.
SERIAL NO.
<b>DO NOT REMOVE</b>

<b>SUBARU</b>
Campaign Code
<b>TKB-20</b>
COMPLETED
DIST./DEALER NO.
SERIAL NO.
<b>DO NOT REMOVE</b>

<b>SUBARU</b>
Campaign Code
<b>TKC-20</b>
COMPLETED
DIST./DEALER NO.
SERIAL NO.
<b>DO NOT REMOVE</b>

Part Number	Applicability	Description	Order Quantity
MSA6P1302	All models	Campaign Completion Labels (contains one sheet of 20 labels)	1

## CLAIM REIMBURSEMENT AND ENTRY PROCEDURES

Credit to perform this recall will be based on the submission of properly completed repair order information. Retailers may submit claims through 'Vehicle Claim Entry' on Subarunet.com.

Carline/MY Applicability for PASSENGER AIRBAG INFLATOR To be used when claiming for INSPECTION ONLY (Confirming the vehicle is equipped with a ZF / TRW inflator)	Labor Operation #	Labor Time	Fail Code	Claim Type
2003-04MY Legacy / Outback & 2003-06MY Baja**	A182-038	0.3	TKA-20 TKB-20 TKC-20	RC
2005-09MY Legacy / Outback		0.3		
2010-14MY Legacy & Outback		0.3		
2009-13MY Forester		0.3		
2004-07MY Impreza		0.2		
2008-11MY Impreza & 2008-14MY WRX / STI		0.3		

Carline / MY Applicability for PASSENGER INFLATOR / MODULE ASSEMBLY REPLACEMENT (includes Inspection)	Labor Operation #	Labor Time	Fail Code	Claim Type
2003-04MY Legacy / Outback & 2003-06MY Baja (M)	A182-031	0.8	TKA-20 TKB-20 TKC-20	RC
2005-09MY Legacy / Outback (I)		1.8		
2010-14MY Legacy & Outback (M)		3.0		
2009-13MY Forester (M)		1.6		
2004-05MY Impreza, WRX & STI (I)		0.8		
2006-07MY Impreza, WRX & STI (M)		0.8		
2008-11MY Impreza & 2008-14MY WRX / STI (M)		1.6		

(M) = AIRBAG MODULE ASSEMBLY Replacement

(I) = INFLATOR ONLY Replacement

**\*\*NOTE:** On 2003MY **ONLY** Legacy Outback and Baja models, the complete quote "7LF" 11-digit airbag module serial number **MUST** be recorded during inspection and entered into the Miscellaneous Detail field as part of the campaign completion/claim entry process. Refer to Appendix B starting on pg. 47 for more information.

## OWNER NOTIFICATION LETTER

**URGENT**  
**IMPORTANT SAFETY RECALL**  
This notice applies to the VIN below



**Subaru of America, Inc**  
PO Box 9103  
Camden, NJ 08101-9877  
844-373-6614  
www.subaru.com

**SAFETY RECALL NOTICE**  
This is an important Safety Recall.  
The remedy will be performed at no charge to you.  
Recall: **XXX-20** NHTSA ID: **XXX-XXX**

January 2020

**Dear Subaru Owner:**

This notice is sent to you in accordance with the National Traffic and Motor Vehicle Safety Act.

SUBARU OF AMERICA, INC. has decided that a defect, which relates to motor vehicle safety, exists in certain 2003-2014 model year Legacy and Outback vehicles, 2003-2006 model year Baja vehicles, 2009-2013 model year Forester vehicles, 2004-2011 model year Impreza vehicles, and 2004-2014 WRX (including STI) vehicles equipped with a non-desiccated Takata-sourced passenger-side frontal air bag containing the propellant Phase Stabilized Ammonium Nitrate.

Our records indicate that the vehicles included in this safety recall may have had an interim (“like-for-like”) repair performed under a previous air bag recall, to reduce the risk of injury before final remedy parts were available. You received this notice because our records indicate that you own one of these vehicles.

### **DESCRIPTION OF THE SAFETY DEFECT AND SAFETY HAZARD**

Despite the previous recall repair for a “like-for-like” air bag inflator replacement, vehicles containing a Takata-sourced passenger-side frontal air bag inflator remain susceptible to propellant degradation occurring after long-term exposure to high absolute humidity, temperature and temperature cycling. Over time, this could cause the inflator within the air bag to explode when the passenger’s frontal air bag deploys in a crash.

***If the air bag inflator explodes, sharp metal fragments could strike vehicle occupants, potentially resulting in serious injury or death.***

### **WHAT SUBARU WILL DO**

Subaru will inspect your vehicle to confirm the type of replacement front passenger air bag inflator that was installed in your vehicle under the previous recall. The inspection will be performed at no charge to you. If it is confirmed that your vehicle contains a “like-for-like” air bag inflator, Subaru will replace it with a final remedy non-Takata sourced inflator at no charge to you.

### **WHAT YOU SHOULD DO**

You should immediately contact any authorized Subaru retailer (dealer) for an appointment to have this repair performed for free. To minimize your inconvenience while the repair is being performed, please ask your retailer for alternative transportation options.

### **HOW LONG WILL THE AIR BAG INFLATOR REPLACEMENT TAKE?**

The time to replace the front passenger air bag inflator ranges from less than one hour to approximately three hours, depending on the model. Your retailer can provide you with an estimate of the overall time needed for this service visit, as it may be necessary to make your vehicle available for a longer period of time.

*Continued...*

## OWNER INFORMATION

Government regulations require that recall notifications be sent to the last known owner of record. That information is based primarily on state registration and title data. If you are a lessor of this vehicle, federal regulations require you to forward this notice to your lessee within ten days.

If you have moved or sold your vehicle, please update this information online at [www.subaru.com](http://www.subaru.com), select 'Customer Support,' then select 'Address Update' or 'Ownership Update' from the Quick Links menu.

## IF YOU NEED FURTHER ASSISTANCE:

To locate the nearest Subaru retailer, you can access our website at [www.subaru.com](http://www.subaru.com) and select 'Find a Retailer.'

For additional information and the most Frequently Asked Questions, please go to:  
<http://www.subaru.com/vehicle-recalls/airbags.html>, or call 1-844-373-6614.

Para información visite nuestro sitio web específico de Takata en español <http://www.subaru.com/es/vehicle-recalls/airbags.html>, o llame al 1-844-373-6614.

If you need additional assistance, please contact us directly:

- By e-mail: Go to [www.subaru.com](http://www.subaru.com) and select "Customer Support"
- By telephone: 1-844-373-6614  
Monday through Friday between 8:00 a.m. and 7:00 p.m. ET
- By U.S. Postal mail: Subaru of America, Inc.  
Attn: Customer-Retailer Services Department  
P.O. Box 9103, Camden, NJ 08101-9877

To subscribe to the NHTSA Recall Notification email System, please go to:  
<https://www-odi.nhtsa.dot.gov/nhtsa/subscriptions>.

Please contact us immediately if the Subaru retailer fails or is unable to make the necessary repairs free of charge.

You may also contact the Administrator, National Highway Traffic Safety Administration, 1200 New Jersey Ave. SE, West Building, Washington, DC 20590 or call the toll-free Auto Safety Hotline at 1-888-327-4236 (TTY: 1-800-424-9153) or go to <http://www.safercar.gov> if you believe the Subaru retailer has failed or is unable to remedy your vehicle without charge within a reasonable amount of time.

Your continued satisfaction with your Subaru is important to us. Please understand that we have taken this action in the interest of your safety and your vehicle's proper operation. We sincerely apologize for any inconvenience this matter may cause and urge you to schedule an appointment as soon as possible.

Sincerely,  
Subaru of America, Inc.

***Notice to Lessors:*** Under Federal law the lessor of a vehicle who receives this letter must provide a copy of it to the vehicle lessee(s) within 10 business days from receipt. The lessor must also keep a record of the lessee(s) to whom this letter is sent, the date sent, and the applicable vehicle identification number (VIN). (For the purposes of this section, a lessor means a person or entity that in the last twelve months prior to the date of this notification has been the owner, as referenced on the vehicle's title, of any five or more leased vehicles. A leased vehicle is a vehicle leased to another person for a term of at least four months.)

*A subsidiary of Fuji Heavy Industries Ltd.*

*Continued...*

## SHIPPING DOCUMENTATION AND INSTRUCTIONS (Appendix A)

**IMPORTANT NOTE:** There are 2 different sets of instructions supplied in this section. The first page outlines the procedure for INFLATOR returns while the following page provides instructions for returning a COMPLETE MODULE assembly.

### NOTE

#### INFLATOR RETURNS

#### **These Return Instructions are for the Continental US dealerships (48 States).**

**NOTE:** Locations outside of the Continental United States (Hawaii, Alaska, Puerto Rico, Virgin Islands INCLUDING Mexico and Canada) **CANNOT follow below shipping instructions.** Instead, dealerships in these locations **MUST** contact the following Takata/XPO USA representative directly for shipping instructions: Miguel Prigadaa – Tel #: 210-250-5078 or Email: MLGTakataRestrains\_International@menlowworldwide.com

<https://www.subarunet.com/home/content/1505>

*Continued...*

## APPENDIX B

**NOTE: This information is applicable to 2003MY Legacy, Outback, and Baja models ONLY.**

Subaru of America, Inc. (Subaru) has been notified by SUBARU CORPORATION (SBR) that some early production 2003 MY Legacy, Outback, and Baja vehicles may have been incorrectly included in the list of vehicles requiring inflator replacement as part of the on-going Takata recalls listed above.

- These early production 2003 MY vehicles (77,000) were equipped with inflators which do not contain ammonium nitrate.
- These inflators which do not contain ammonium nitrate do not require replacement as part of any Subaru airbag recall.

### Description of the Remedy

The inspection involves lowering of the glovebox to provide enough access to visually inspect the label on the airbag module. Labels containing “7LF” identify inflators WITHOUT ammonium nitrate and those with “7LG” identify inflators WITH ammonium nitrate as shown in the photos below. If the vehicle in question is identified as having an airbag inflator without ammonium nitrate installed, **STOP and note the 11-digit serial number ONLY** as no further action is required other than refitting the glove box. **Only vehicles with airbag inflators containing ammonium nitrate are affected by this campaign.**

See the Claim Reimbursement and Entry Procedures at the end of this announcement for instructions on how to submit a claim for “Inspection Only” when an inflator without ammonium nitrate is identified.

**Inflator WITHOUT Ammonium Nitrate- Serial Number Label Location (2003 Legacy, Outback and Baja models only): Record this 11-digit number for claims purposes.**

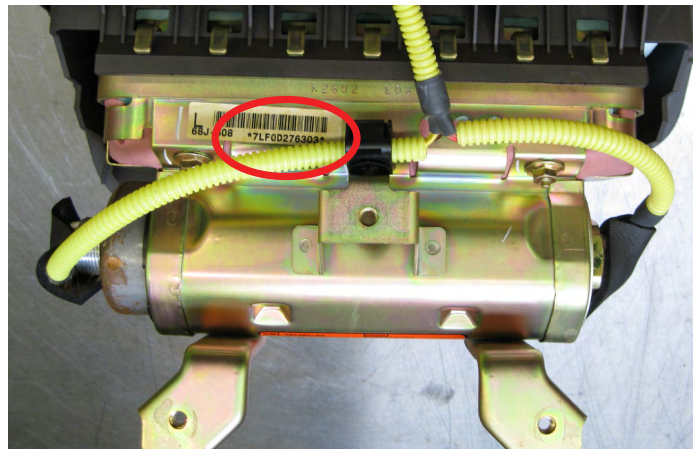

- **Additional 2003 Leg / Obk / Baja Module / Inflator Inspection info to add:**

If the serial number label is missing, illegible or if there is any uncertainty if the airbag module is affected by this Recall Campaign, follow the Counterfeit / Non-Genuine airbag inspection process provided above. Always take photos of the module showing the entire inflator along with an additional photo showing the area where the label should be as seen in the photos below. Next, submit a Quality Monitoring Report (QMR) requesting SOA review. A member of the Claims Team will contact the Retailer following review of the QMR submission with information on how to proceed.

*Continued...*

## Inflator WITH Ammonium Nitrate- Serial Number Label Location

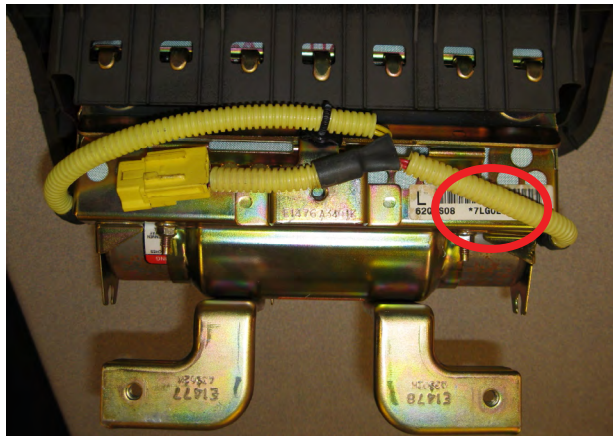

### Label Detail



Labor Description	Labor Operation #	Labor Time	Fail Code	Claim Type
2003MY LEGACY / OUTBACK / BAJA PASSENGER FRONT AIRBAG INFLATOR - INSPECTION ONLY (Vehicles equipped with inflator WITHOUT ammonium nitrate.)	A182-038	0.3	TKA-20 TKB-20 TKC-20 <i>(which ever is applicable)</i>	RC

**IMPORTANT NOTE:** The **complete** 11-digit airbag module Serial Number **MUST** be recorded during inspection and entered into the Miscellaneous Detail field as part of the campaign completion / claim entry process.

If you have any questions, please contact the Claims Helpline at **1-866-782-2782**.