

Subarunet Announcement

To: All Subaru Retailers

From: Subaru of America, Inc.

Date: November 10, 2023

New Safety Recall/STOP SALE: WRP-23 Driveshaft Failure

Subaru of America, Inc. (Subaru) has initiated a safety recall for certain 2023 model year WRX vehicles, certain 2024 model year Crosstrek and Impreza vehicles, and certain 2023-2024 model year Forester vehicles.

Description of the Defect and Safety Risk

The vehicles included in this recall may be equipped with a front drive shaft assembly with an outer race that could crack, due to improper cooling during the manufacturing process.

Over time, a cracked outer race could break, potentially resulting in loss of motive power. Additionally, if the outer race breaks, the vehicle may roll when parked if the parking brake is not applied. Both conditions increase the risk of a crash.

Remedy

For all potentially affected vehicles, Subaru dealers will inspect the left-hand and right-hand front drive shafts and where necessary, replace them with a new one at no cost to the customer.

Affected Vehicles

A total of 3,732 U.S. vehicles will be included in this recall as listed below. Not all vehicles in the production range listed below are affected by this recall. Coverage must be confirmed by using the Vehicle Coverage Inquiry function on subarunet.com prior to repair. This information will be available later today.

Model Year	Carline	Production Date Range
2023	WRX	9/1/2023 – 9/13/2023
2024	Crosstrek	9/5/2023 – 9/13/2023
2024	Impreza	9/6/2023 – 9/7/2023
2023-2024	Forester	9/4/2023 – 9/14/2023

Please be advised that the parts supply for this recall is not yet available. Therefore, the WRP23 recall coverage status for the affected VINs will be 'Open-Remedy not yet available' until the parts are available. We expect parts to be available in December, at which time the VIN status will be updated to allow repairs to begin. Retailers will be notified when this update occurs.

Retailer Responsibility

Please be advised that it is a violation of Federal law for a dealer to deliver a new motor vehicle covered by a recall under a sale or lease until the defect is remedied. Therefore, any Authorized Subaru Retailer failing to perform the applicable service procedures to correct all affected vehicles in their inventory prior to the vehicle being placed in service may be subject to civil penalties of up to \$26,315 per violation (i.e., for each vehicle), as provided in 49 CFR §578.6 and will also be in breach of the Subaru Dealer Agreement.

Any vehicles listed in any recall/campaign that are in retailer stock must be:

- Immediately identified
- Tagged or otherwise marked to prevent their delivery or use prior to repair
- Repaired in accordance with the repair procedures outlined in the Product Campaign Bulletin

Retailers are to promptly perform the applicable service procedures, to correct all affected vehicles in their inventory (used, demo & SSLP). Whenever a vehicle subject to this recall is taken into retailer inventory necessary steps should be taken to ensure the recall correction has been made before selling or releasing the vehicle.

Service, Parts, and Claim Instructions

For stop sale units affected by this recall, please refer to the lot number inspection procedure included at the end of this announcement. If an affected lot number is found during the inspection, the vehicle is to be held under the stop sale until remedy parts are available. Retailers will be advised when parts are available.

Once parts are available, please refer to the WRP-23 Product Campaign Bulletin on STIS for detailed service, parts, and claim instructions.

Owner Notification

Subaru will notify affected vehicle owners by first class mail within 60 days. Retailers will be advised when owner notification is scheduled.

STOP SALE UNITS: LOT NUMBER INSPECTION PROCEDURE PRIOR TO PARTS AVAILABILITY

The vehicles included in this recall may be equipped with a front drive shaft assembly with an outer race (shown below) that could crack, due to improper cooling during the manufacturing process.

Over time, a cracked outer race could break, potentially resulting in loss of motive power. Additionally, if the outer race breaks, the vehicle may roll when parked if the parking brake is not applied. Both conditions increase the risk of a crash.

For stop sale vehicles only, Subaru retailers should inspect the front drive shaft lot numbers. If the affected lot number is found, the vehicle is to remain on HOLD under this stop sale until recall remedy parts are available. A future announcement will be made when parts are available.

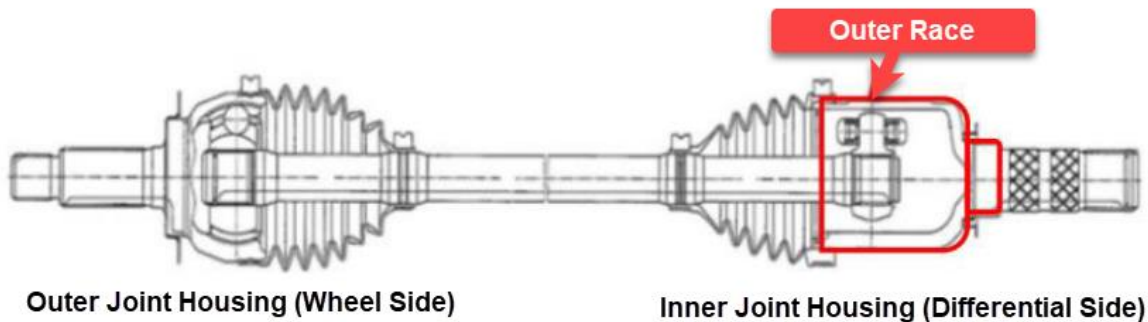

SERVICE PROCEDURE FLOWCHART:

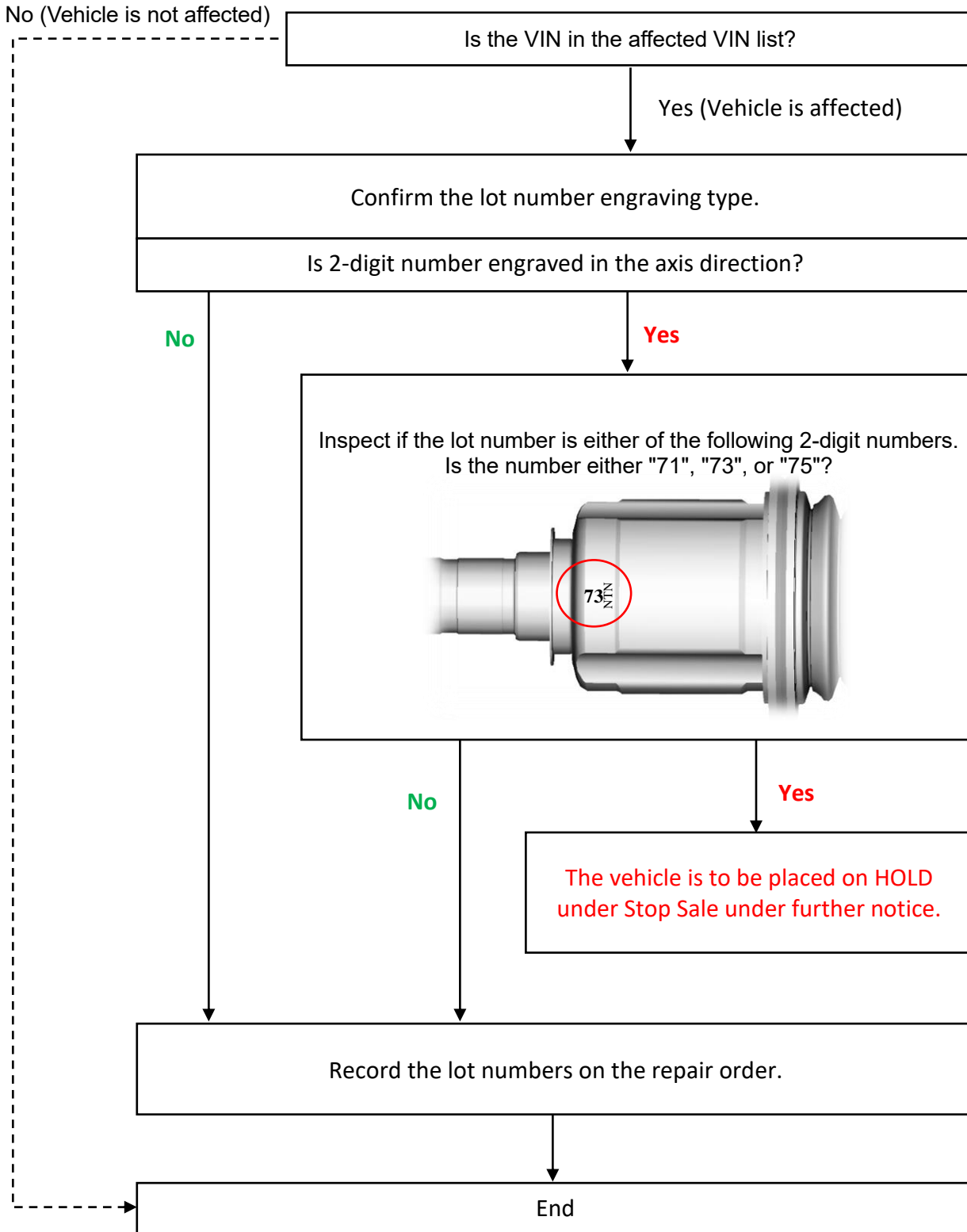

LOT NUMBER INSPECTION PROCEDURE:

STEP 1: Lift the vehicle according to the lift manufacturer's instructions.

STEP 2: Rotate the left/right front wheel to find the 2-Line engraving located on both the left and right outer race portions of the inner drive shaft joints.

CAUTIONS:

- There are three engravings on the drive shaft outer race. One is the lot number, and the others are NOT lot numbers. The lot number engraving is shown in the images below.
- SLOWLY rotate the wheel to find the lot number. Remove dust and/or dirt using a clean cloth to make the numbers more visible. A flashlight will also aid in the reading.

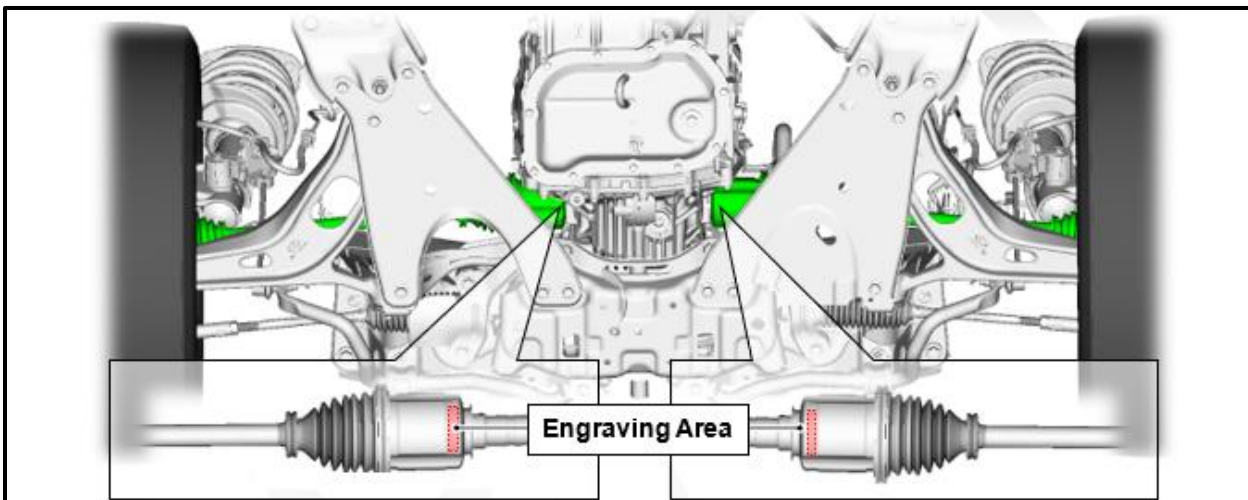

There is one engraving of either of the following types on the outer race. The 2-digit number (followed by a letter) in the red frame below is a lot number.



There are two engravings of the following style on the outer race. However, this 1-line engraving is NOT a lot number.

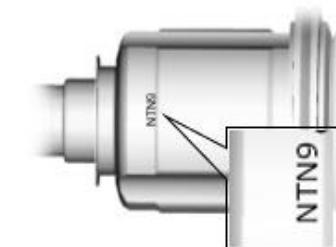

STEP 3: Confirm the lot number engraving type and read the lot number. See the tables below for further detail.

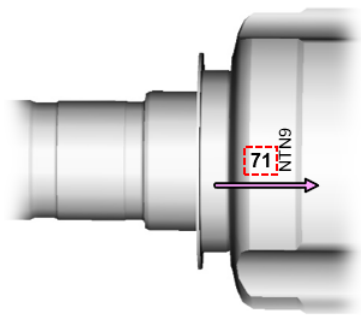
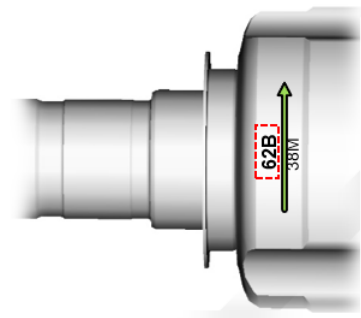
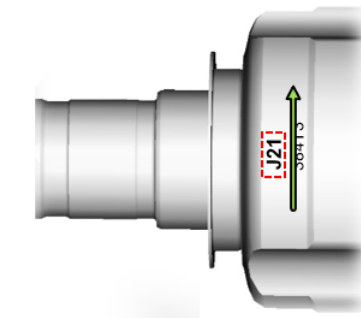
Engraving Type 1	Engraving Type 2	Engraving Type 3
2-digit number is engraved in the axis direction.	3 digit-character starting with a number is engraved in the circumferential direction.	3 digit-character starting with a number is engraved in the circumferential direction.
		
Results		
Engraving style 1	Refer to the table below for further details.	
Engraving style 2 or 3	The drive shaft is a good part. Record and attach the lot number to the repair order.	

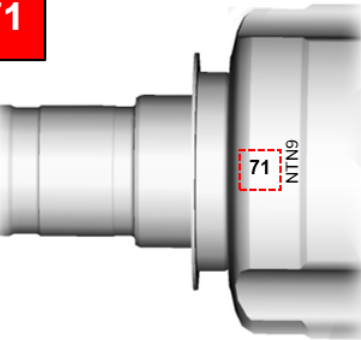
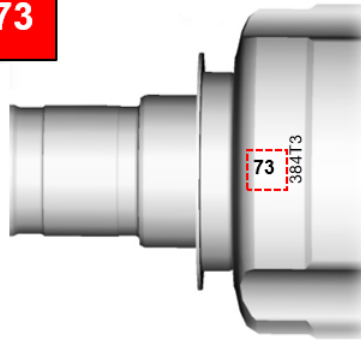
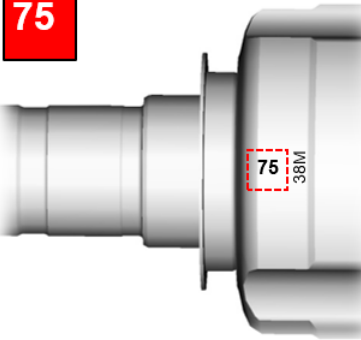
71		73		75	
Results					
71, 73 or 75		The drive shaft is a defective part. The vehicle is to be placed on HOLD under Stop Sale until further notice.			
Other 2-digit numbers		The drive shaft is a good part. Record and attach the lot number to the repair order.			

STEP 4: Do any of the drive shafts require replacement?

YES: The vehicle should remain on HOLD under Stop Sale until remedy parts are available. No claim should be submitted until the affected driveshaft(s) are replaced.

NO: The procedure is complete. Record the lot numbers and include them in the repair order notes, and submit an 'RC' claim for inspection only.

SERVICE PROGRAM IDENTIFICATION LABEL:

If the inspection shows that both the LH and RH front driveshaft lot numbers are OK, type or print the necessary information on a Campaign Identification Label.

The completed label should be attached to the vehicle’s upper radiator support. Additional labels are available through normal parts ordering channels. The part number is **MSA6P1302**, which comes as one sheet of 20 labels.

Part Number	Applicability	Description	Order Quantity
MSA6P1302	All Models	Campaign Completion Labels (contains one sheet of 20 labels)	1

SUBARU
Campaign Code
WRP-23
COMPLETED
DIST./DEALER NO.
SERIAL NO.
DO NOT REMOVE

CLAIM REIMBURSEMENT AND ENTRY PROCEDURES:

If the inspection shows that one or both of the front driveshafts contain an affected lot number (71, 73, or 75), the vehicle should remain on hold under this stop sale until remedy parts are available. **DO NOT SUBMIT A CLAIM UNTIL THE AFFECTED DRIVESHAFT(S) ARE REPLACED.** Further repair, parts, and claim instructions will be included in the WRP-23 Product Campaign Bulletin once remedy parts are available.

If the inspection shows that both the LH and RH front driveshaft lot numbers are OK, credit to perform this recall will be based on properly completed repair order information. Retailers may submit claims through subarunet.com.

Labor Description	Labor Operation #	Labor Time	Fail Code
INSPECTION ONLY OF DRIVESHAFTS (only if both the LH and RH driveshaft lot numbers are OK)	A121-300	0.3	WRP-23

IMPORTANT REMINDERS:

- SOA strongly discourages the printing and/or local storage of service information as previously released information and electronic publications may be updated at any time.
- Always check for any open recalls or campaigns anytime a vehicle is in for servicing.
- Always refer to STIS for the latest service information before performing any repairs.