

September 5, 2023

Version 1

## 2021–23 TLX Popping/Crackling from the Speakers; Display Blank

### AFFECTED VEHICLES

Year	Model	Trim	VIN Range
2021–23	TLX	ALL	ALL

### BACKGROUND

The client may experience a popping or crackling noise from the speakers, a blank display, or no sound from the audio system. They may also see a Network Loss message.

### CORRECTIVE ACTION

Install the FAKRA splice repair service cables and splice boxes.

### PARTS INFORMATION

Part Name	Part Number	Quantity
Splice boxes	39817-THR-305	9 Splice boxes (18 Halves)
FAKRA splice repair service cable (Green)	39165-THR-AB0	4
FAKRA splice repair service cable (Red)	39165-THR-AA0	4
90° FAKRA splice repair service cable (Pink)	39165-TGV-305	1

### TOOLS INFORMATION

Part Name	Part Number	Quantity
Straight FAKRA Puller	07AAC-THRA200	1

**CLIENT INFORMATION:** The information in this bulletin is intended for use only by skilled technicians who have the proper tools, equipment, and training to correctly and safely maintain your vehicle. These procedures should not be attempted by "do-it-yourselfers," and you should not assume this bulletin applies to your vehicle, or that your vehicle has the condition described. To determine whether this information applies, contact an authorized Acura automobile dealer.

## WARRANTY CLAIM INFORMATION

Normal Warranty Applies

Operation Number	Description	Flat Rate Time	Defect Code	Symptom Code	Template ID	Failed Part Number
0101T5	Access the gauge control module, infotainment control unit, stereo amplifier, in-line connector, and tuner unit, then replace the affected FAKRA splice repair service cables, and splice boxes.	1.4hr	03214	03217	B23030A	39540-TGV-A03

### FAKRA CONNECTOR HOUSING DISASSEMBLY/FAKRA SPLICE REPAIR SERVICE CABLE ASSEMBLY PROCEDURE

1. Follow the steps below to better understand the cable and splice box installation instructions.
2. The connectors will either be the original FAKRA housing or the WPC FAKRA service housing.

NOTE:

- There may be multiple components that require the affected FAKRA connectors to be removed.
- Use the straight FAKRA puller to remove the connector from a component.

#### Original FAKRA Housing Removal Procedure

1. Use a small screwdriver, remove the secondary lock, then release the tab as shown.

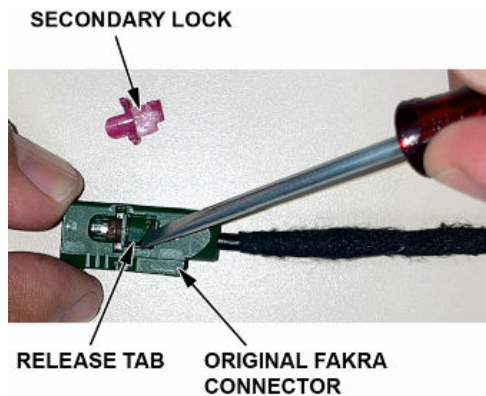

2. Pull to remove the housing from the vehicle harness. Then, **discard** the housing and lock.

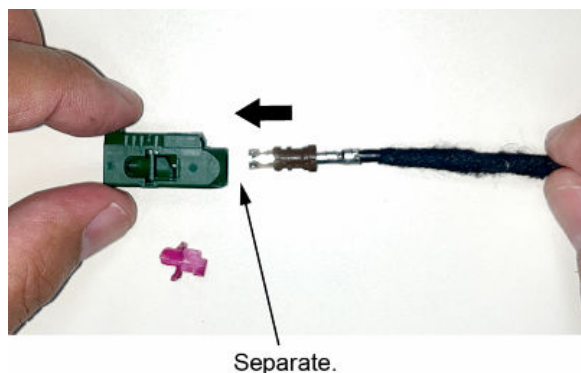

### WPC FAKRA Service Housing Removal Procedure

1. Release the two locking tabs on the WPC FAKRA service housing and remove the housing from the terminal.

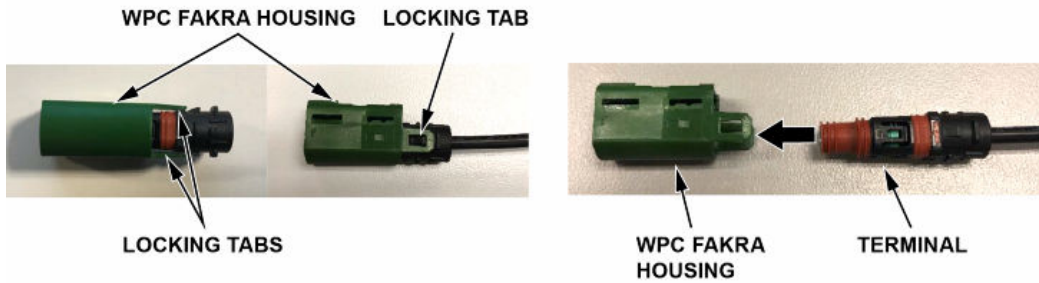

2. Release the lock tab and remove the terminal from the vehicle harness.

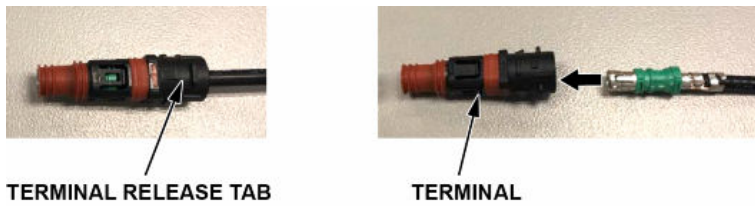

### FAKRA Splice Repair Service Cable Assembly

1. Install the appropriate FAKRA splice repair service cables and splice boxes as shown in the steps that follow.

NOTE:

- The splice box arrow must always point in the direction of either the red flag label or red sleeve on the FAKRA splice repair service cable.
- If the splice box is installed **incorrectly**, the repair **will fail**; MOST Ring failure conditions will still occur.
- Some vehicle trims may not apply the 90° FAKRA splice repair service cables.

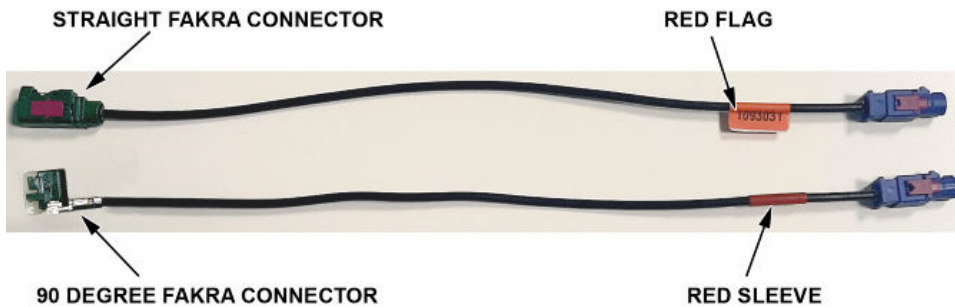

2. Use a small screwdriver to remove the secondary lock, then release the tab.

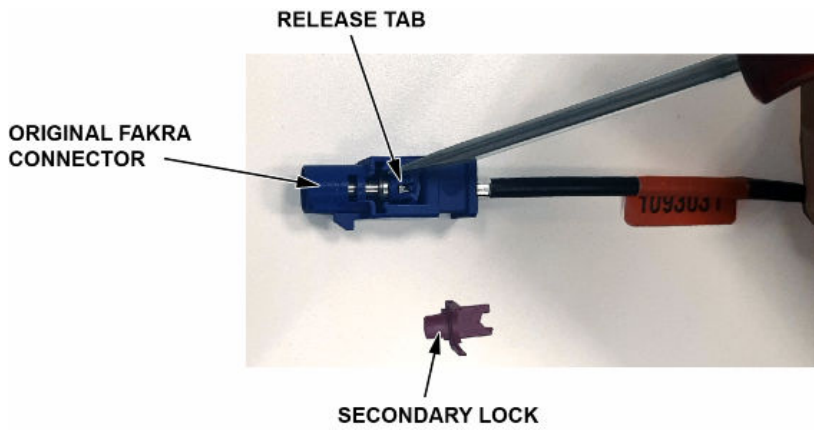

3. Pull to remove the housing from the cable and then discard the housing and secondary lock tab from the FAKRA splice repair service cable.

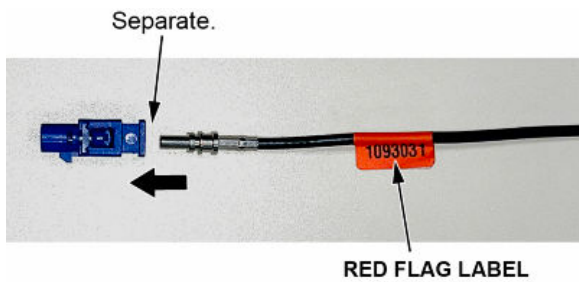

4. Connect the appropriate color FAKRA splice repair service cable to the vehicle harness.

NOTE:

- Make sure the FAKRA service cable is inserted straight into the vehicle harness terminal to avoid damage at the cable connection point.
- Always disassemble the connectors one at a time to avoid swapping the green and red wires.

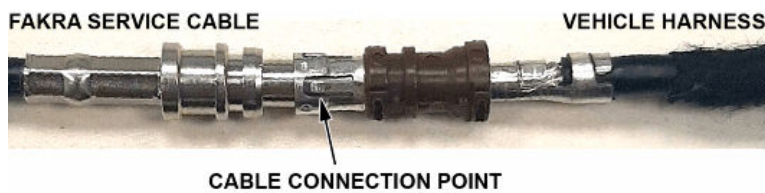

5. Attach the splice box halves to the cable connection.

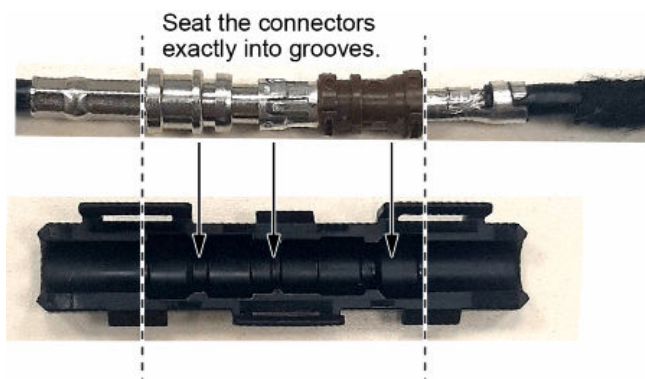

6. When mating the two splice box halves, **make sure** that all **6 lock tabs** are fully engaged. You may hear a click when installing the two halves.

NOTE:

- The splice box arrow must always point in the direction of the red flag label or red sleeve on the FAKRA splice repair service cable.
- The splice box is a **ONE-TIME** use part. Never reuse the splice box after it has been installed.
- If any of the lock tabs break during installation, the splice box half(s) must be replaced.
- If the splice box is installed **incorrectly**, the repair **will fail**; MOST ring failure conditions will still occur.

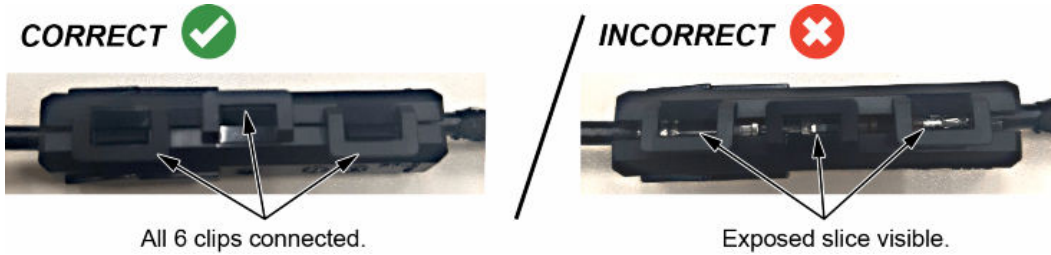

7. Make sure the arrow on the splice box points towards the red flag label.

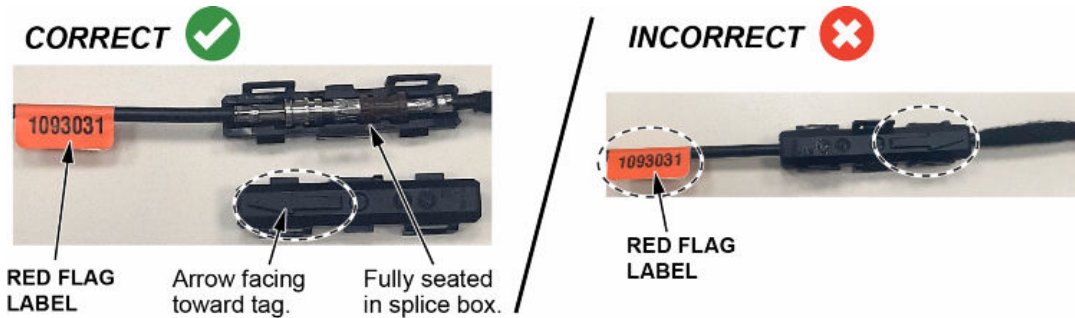

NOTE: Do not spin the splice box or the cables as this can damage the connection point.

- Once the FAKRA splice repair service cables and splice boxes have been attached to the cable connection, tape the splice boxes and FAKRA service cables to the appropriate component harness.

Keep smooth curves with a radius bend greater than 25 mm.



Attach the FAKRA service cables and splice boxes to the appropriate component harness with tape to prevent any rattles.

**CORRECT** ✓



Keep smooth curves with a radius bend greater than 25 mm.



**INCORRECT** ✗



NOTE: Make sure the FAKRA splice repair service cables are not bent at the connector(s), as shown below.

**CORRECT** ✓

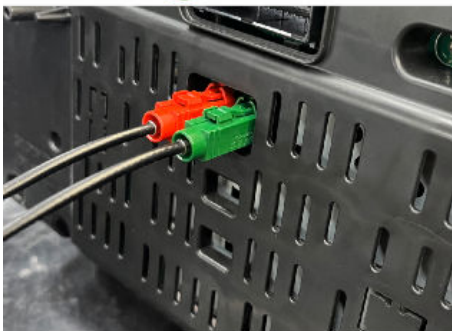

**INCORRECT** ✗

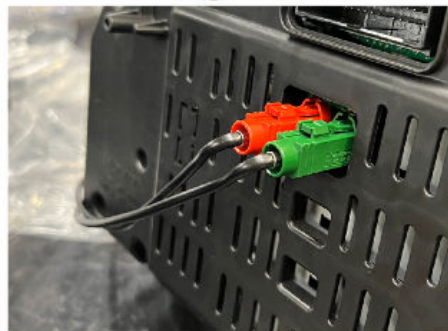

## REPAIR PROCEDURE

1. Remove the following dash components to gain access to the meter.



**B CLIP**  
Release.

**A CLIPS (6)**  
Release.

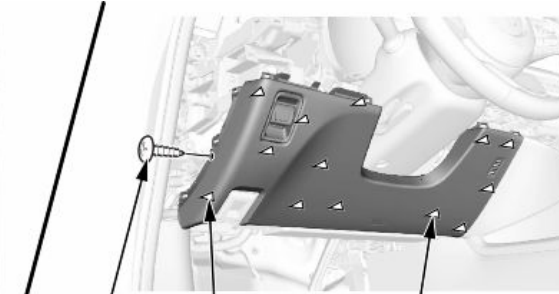

**SCREW**  
Remove.

**B CLIP**  
Release.

**A CLIPS (11)**  
Release.

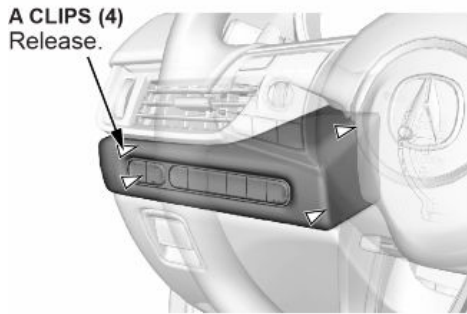

**A CLIPS (4)**  
Release.

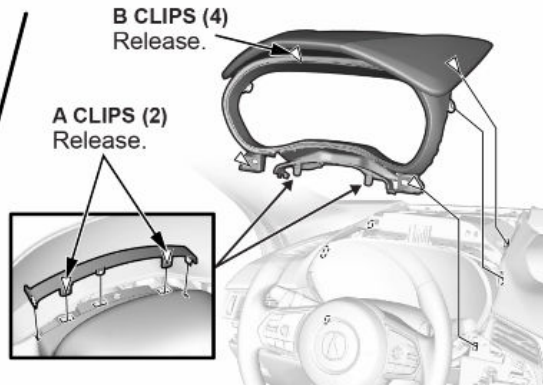

**B CLIPS (4)**  
Release.

**A CLIPS (2)**  
Release.

2. Remove the following components to gain access to the infotainment unit and amplifier.

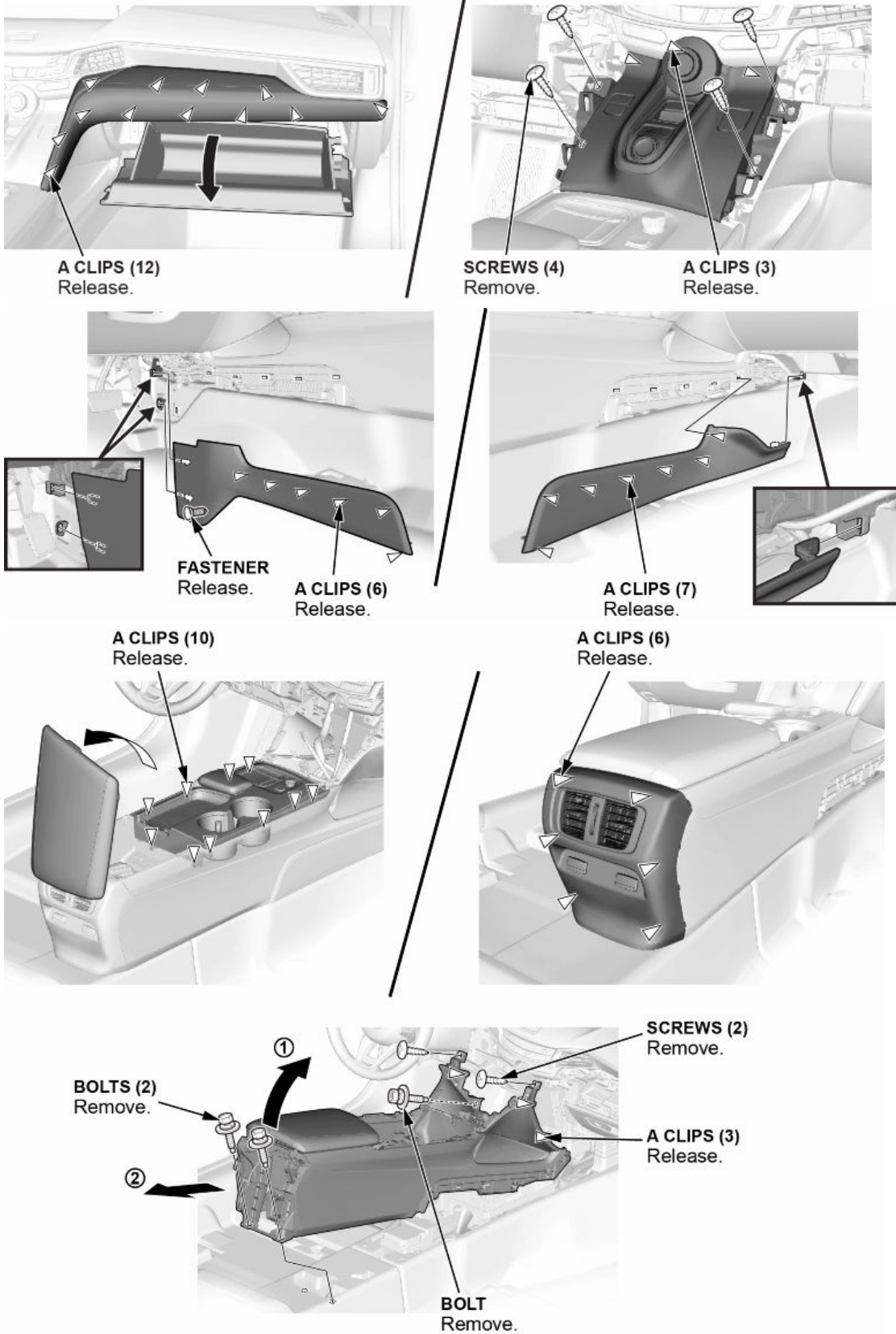

3. Remove passenger's kick panel.



4. Remove the rear trunk floor panels and loosen the right-side liner enough to gain access to the tuner unit.

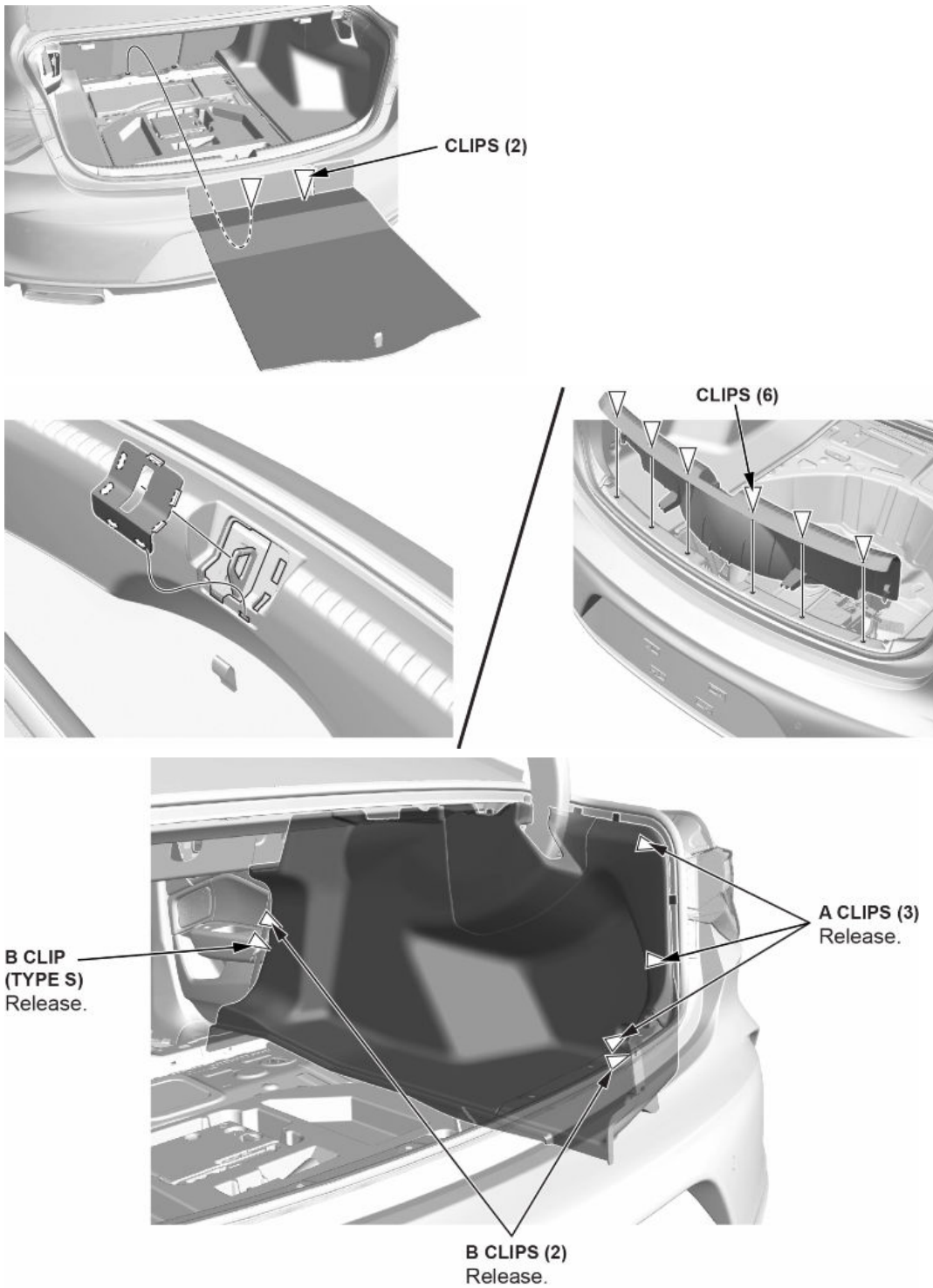

5. Follow the steps below to install the FAKRA splice repair service cables and splice boxes at each component location.

NOTE:

See the **FAKRA Connector Housing Disassembly/FAKRA Splice Repair Service Cable Assembly Procedure** section above for cable and splice box installation instructions.

## GAUGE CONTROL MODULE REPAIR PROCEDURE

1. Locate and turn the gauge control module and remove to access the rear connectors.

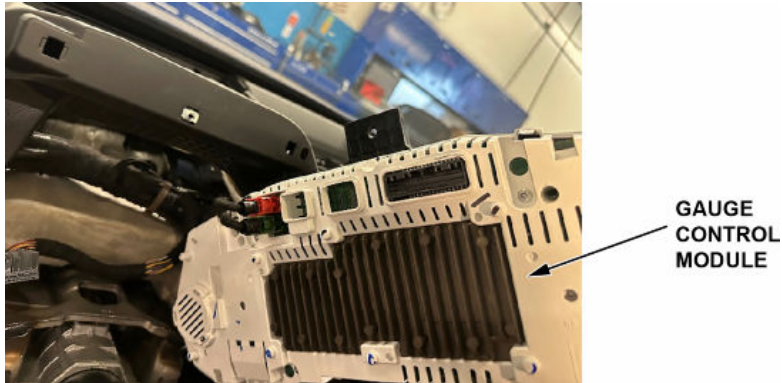

2. Disconnect the red and green FAKRA connectors and any other related connectors from the gauge control module.  
NOTE: Disassemble the connectors one at a time to avoid swapping the green and red wires.

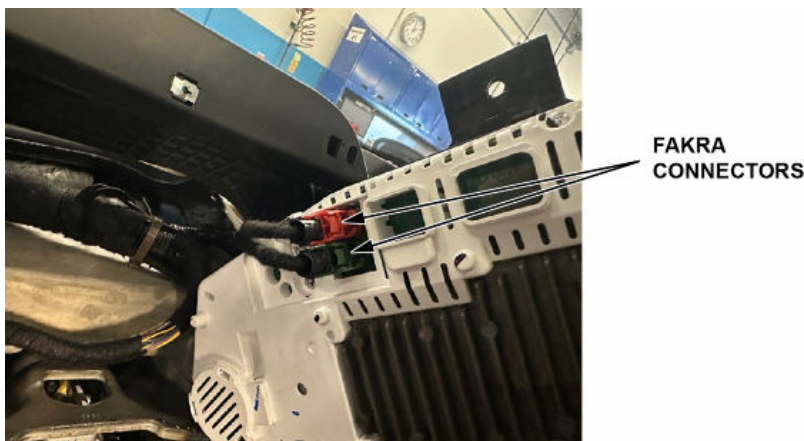

3. Install the matching color FAKRA splice repair service cables and splice boxes.

NOTE:

- See the above section **FAKRA Connector Housing Disassembly/FAKRA Splice Repair Service Cable Assembly Procedure** section for detailed instructions.
- **The splice box arrow must always point in the direction of the red flag label or red sleeve on the FAKRA splice repair service cable.**
- The splice box is a **ONE-TIME** use part. Never reuse the splice box after it has been installed.
- If any of the lock tabs break during installation, the splice box half(s) must be replaced.
- If the splice box is installed **incorrectly**, the repair **will fail**; MOST Ring failure conditions will still occur.

4. Tape both FAKRA splice repair cables and splice boxes to the gauge control module harness.

NOTE: Make sure the FAKRA service cables are routed on top of the 32-pin gray connector harness to prevent improper cable routing.

Keep smooth curves with a radius bend greater than 25 mm.

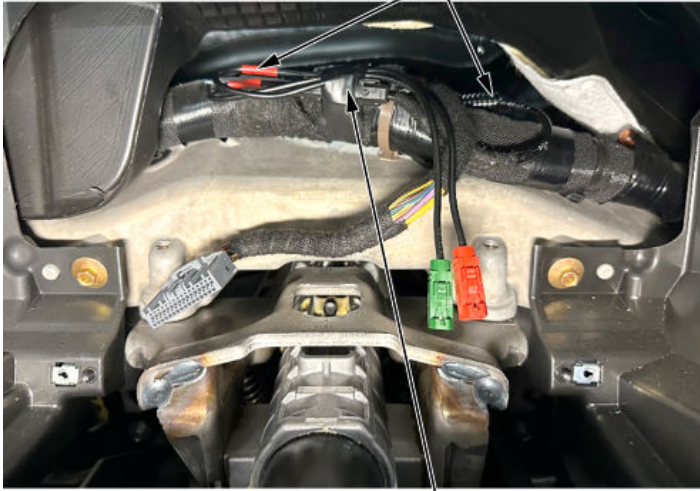

Attach the FAKRA service cables and splice boxes to the appropriate component harness with tape to prevent any rattles.

5. Reconnect the FAKRA connectors and any other related connectors to the gauge control module.

#### INFOTAINMENT CONTROL UNIT REPAIR PROCEDURE

1. Remove the telematics control unit.



TELEMATICS  
CONTROL UNIT

2. Disconnect the gray UG USB cable from the telematics control unit and set the unit off to the side.



3. Disconnect the red and green FAKRA connectors and any other related connectors at the infotainment control unit.  
NOTE: Disassemble the connectors one at a time to avoid swapping the green and red wires.

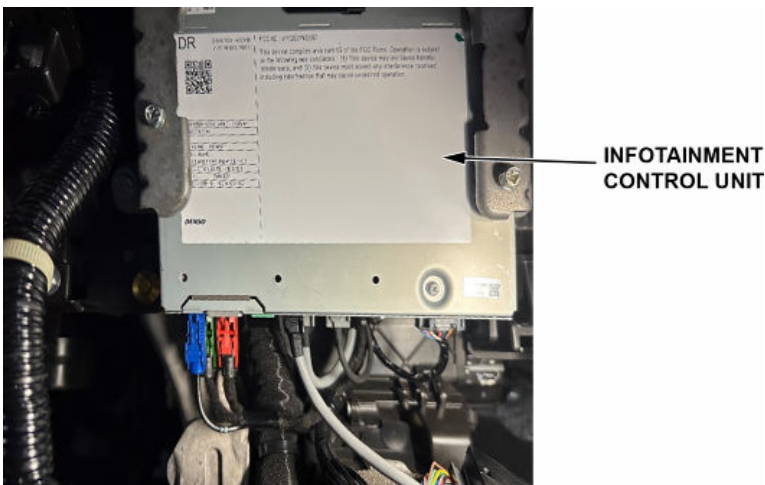

4. Install the matching color FAKRA splice repair service cables and splice boxes.

NOTE:

- See the above section **FAKRA Connector Housing Disassembly/FAKRA Splice Repair Service Cable Assembly Procedure** section for detailed instructions.
- **The splice box arrow must always point in the direction of the red flag label or red sleeve on the FAKRA splice repair service cable.**
- The splice box is a **ONE-TIME** use part. Never reuse the splice box after it has been installed.
- If any of the lock tabs break during installation, the splice box half(s) must be replaced.
- If the splice box is installed **incorrectly**, the repair **will fail**; MOST Ring failure conditions will still occur.

5. Carefully cut and remove the harness tape.



Cut and remove tape.

6. Tape both FAKRA splice repair cables and splice boxes to the infotainment control unit harness.

Attach the FAKRA service cables and splice boxes to the appropriate component harness with tape to prevent any rattles.

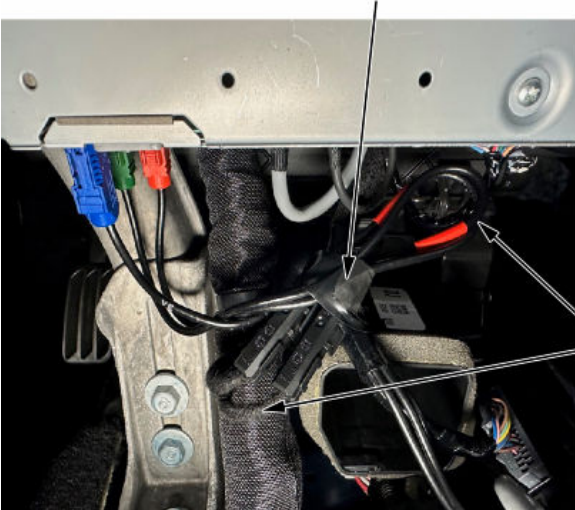

Keep smooth curves with a radius bend greater than 25 mm.

7. Reconnect the FAKRA connectors and any other related connectors to the infotainment control unit.
8. Reconnect the gray UG USB cable to the telematics control unit.
9. Reinstall the telematics control unit.

## STEREO AMPLIFIER REPAIR PROCEDURE

1. Disconnect the red and green FAKRA connectors at the stereo amplifier.

NOTE: Disassemble the connectors one at a time to avoid swapping the green and red wires.

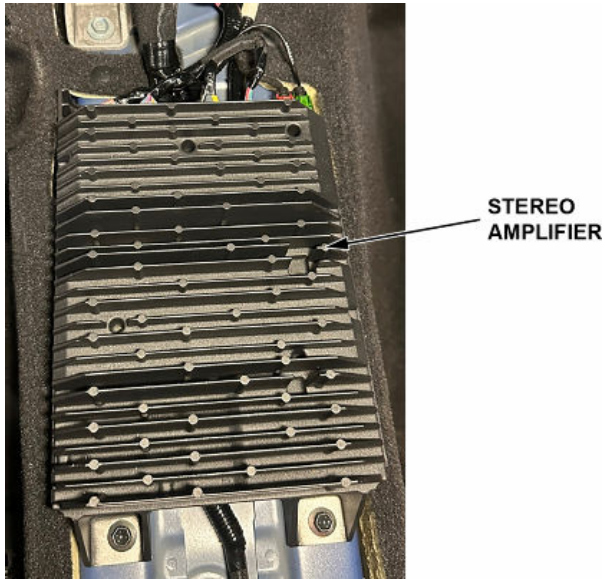

2. Install the matching color FAKRA splice repair service cables and splice boxes.

NOTE:

- See the above section **FAKRA Connector Housing Disassembly/FAKRA Splice Repair Service Cable Assembly Procedure** section for detailed instructions.
- The splice box arrow must always point in the direction of the red flag label or red sleeve on the FAKRA splice repair service cable.
- The splice box is a **ONE-TIME** use part. Never reuse the splice box after it has been installed.
- If any of the lock tabs break during installation, the splice box halve(s) must be replaced.
- If the splice box is installed **incorrectly**, the repair **will fail**; MOST Ring failure conditions will still occur.

3. Tape both FAKRA splice repair cables and splice boxes to the stereo amplifier harness.

Keep smooth curves with a radius bend greater than 25 mm.



Attach the FAKRA service cables and splice boxes to the appropriate component harness with tape to prevent any rattles.

4. Reconnect the FAKRA connectors and any other related connectors to the stereo amplifier.

#### PASSENGER KICK PANEL IN-LINE CONNECTOR REPAIR PROCEDURE

1. Disconnect the pink FAKRA connector at the passenger side kick panel.

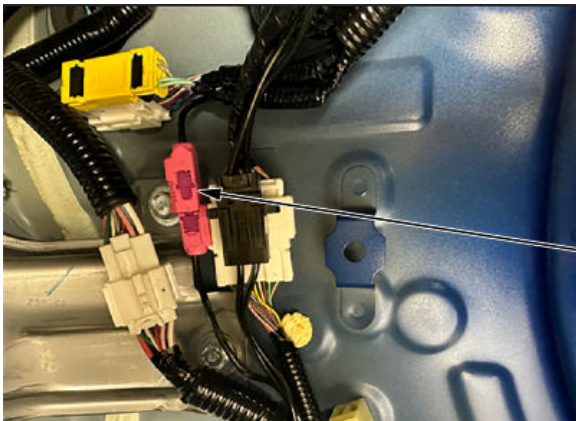

IN-LINE  
CONNECTOR

2. Install the matching pink FAKRA 90° splice repair service cable and splice box.

NOTE:

- See the above section **FAKRA Connector Housing Disassembly/FAKRA Splice Repair Service Cable Assembly Procedure** section for detailed instructions.
- The splice box arrow must always point in the direction of the red flag label or red sleeve on the FAKRA splice repair service cable.
- The splice box is a **ONE-TIME** use part. Never reuse the splice box after it has been installed.
- If any of the lock tabs break during installation, the splice box half(s) must be replaced.
- If the splice box is installed **incorrectly**, the repair **will fail**; MOST Ring failure conditions will still occur.

3. Tape the pink FAKRA 90° splice repair cable and splice box to the in-line harness.

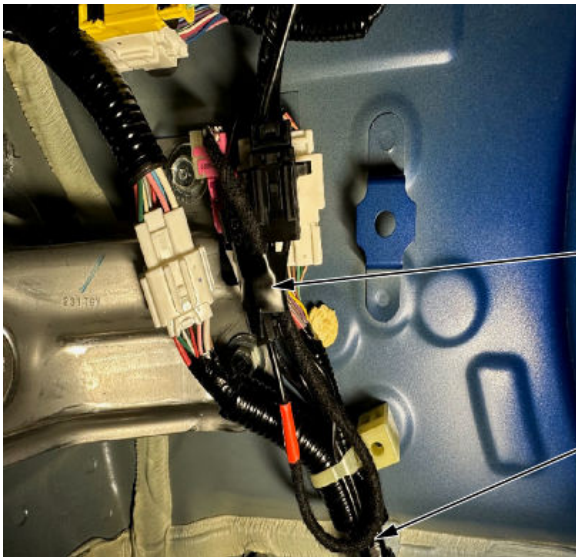

Attach the FAKRA service cable and splice box to the appropriate component harness with tape to prevent any rattles.

Keep smooth curves with a radius bend greater than 25 mm.

4. Reconnect the pink 90° in-line FAKRA connector.



## TUNER UNIT REPAIR PROCEDURE

1. Disconnect the red and green FAKRA connectors at the tuner unit.

NOTE:

Disassemble the connectors one at a time to avoid swapping the green and red wires.

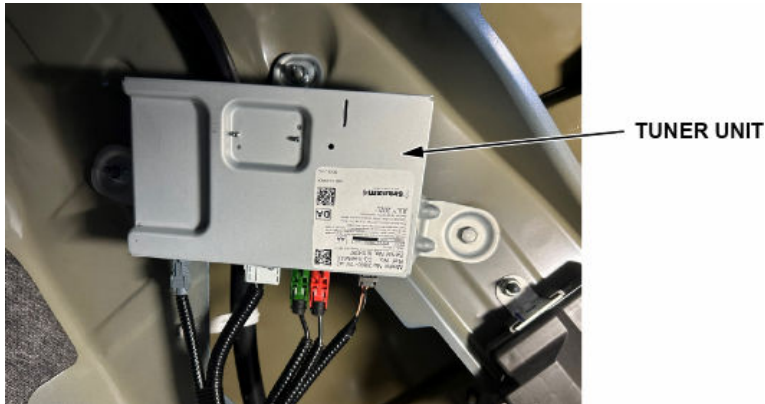

2. Install the matching color FAKRA splice repair service cables and splice boxes.

NOTE:

- See the above section **FAKRA Connector Housing Disassembly/FAKRA Splice Repair Service Cable Assembly Procedure** section for detailed instructions.
  - The splice box arrow must always point in the direction of the red flag label or red sleeve on the FAKRA splice repair service cable.
  - The splice box is a **ONE-TIME** use part. Never reuse the splice box after it has been installed.
  - If any of the lock tabs break during installation, the splice box half(s) must be replaced.
  - If the splice box is installed **incorrectly**, the repair **will fail**; MOST Ring failure conditions will still occur.
3. Tape both FAKRA splice repair cables and splice boxes to the tuner unit harness.

Keep smooth curves with a radius bend greater than 25 mm.



Attach the FAKRA service cables and splice boxes to the appropriate component harness with tape to prevent any rattles.

4. Reconnect the FAKRA connectors and any other related connectors to the tuner unit.

## REPAIR VERIFICATION PROCEDURE

1. Install all of the removed parts in the reverse order of removal.

### NOTE:

- When reinstalling components, make sure the harness is routed correctly. A misrouted harness can put pressure on the wires and connectors causing connection issues.
  - **Do not pull** on the units or MOST cables while the FAKRA connectors are connected to help prevent communication issues.
2. Start the vehicle and verify that the gauge control module and infotainment control module are operating normally. Then, push the power button to OFF mode. Open and close the driver's door, then restart the vehicle. Reverify the gauge control module and the infotainment control module are operating normally. If all systems operate normally, the repair is complete.
  3. If components do not operate as intended, reinspect FAKRA splice repair service cables, splice box connections, and routing. Make sure the splice box arrow is pointing to the red flag label or red sleeve on the FAKRA splice box service cable.

**NOTE: If all FAKRA splice repair service cables, splice box connections, and routing are correct, follow normal troubleshooting procedures per a Service Information search on iN.**

END