



Stacy L. Balzer
Operating Director
Service Engineering Operations
Ford Customer Service Division

Ford Motor Company
P. O. Box 1904
Dearborn, Michigan 48121

June 8, 2023

TO: All U.S. Ford and Lincoln Dealers

**SUBJECT: RECOMMENDED NEW VEHICLE DEMONSTRATION / DELIVERY HOLD
Customer Satisfaction Program 22B39
Certain 2022 Maverick HEVs
Maverick No-start Condition**

PROGRAM TERMS

This program will be in effect through June 30, 2024. There is no mileage limit for this program.

URGENCY / EXPIRATION DATE

This Customer Satisfaction Program has an expiration date of June 30, 2024, to encourage dealers and customers to have this service performed as soon as possible.

We recommend dealers utilize their FSA VIN Lists' names and address to contact customers with affected vehicles. This will help minimize the number of vehicles that may experience a no-start condition, which requires a more extensive repair. FSA VIN Lists are expected to be available by June 8, 2023.

AFFECTED VEHICLES

Vehicle	Model Year	Assembly Plant	Build Dates
Maverick	2022	Hermosillo	26-Jul-2021 through 13-May-2022

US population of affected vehicles: 21,513. Affected vehicles are identified in OASIS and FSA VIN Lists.

REASON FOR THIS PROGRAM

In some of the affected vehicles, a no crank/no start condition may occur. This may be due to a loose or detached eyelet solder connection C1617E in the battery cable assembly at the battery junction box.

SERVICE ACTION

Before demonstrating or delivering any new in-stock vehicles involved in this program, dealers are to install a new 12V battery cable overlay and disable the current battery cable. This service must be performed on all affected vehicles at no charge to the vehicle owner.

OWNER NOTIFICATION MAILING SCHEDULE

Owner letters are expected to be mailed the week of June 19, 2023. Dealers should repair any affected vehicles that arrive at their dealerships, whether or not the customer has received a letter.

ATTACHMENTS

Attachment I: Administrative Information
Attachment II: Labor Allowances and Parts Ordering Information
Attachment III: Technical Information
Attachment IV: Mobile Service Repair Assessment
Owner Notification

QUESTIONS & ASSISTANCE

For questions and assistance, contact the Special Service Support Center (SSSC) via the SSSC Web Contact Site. The SSSC Web Contact Site can be accessed through the Professional Technician System (PTS) website using the SSSC link listed at the bottom of the OASIS VIN report screen or listed under the SSSC tab.

Sincerely,

A handwritten signature in black ink that reads "Stacy L. Balzer". The signature is written in a cursive style with a large, stylized 'S' and 'B'.

Stacy L. Balzer

RECOMMENDED NEW VEHICLE DEMONSTRATION / DELIVERY HOLD
Customer Satisfaction Program 22B39
Certain 2022 Maverick HEVs
Maverick No-start condition

MOBILE SERVICE REPAIR ASSESSMENT LEVEL

All repairs in this program have the following assessment level.

 - Not Mobile Service Capable

OASIS ACTIVATION

OASIS will be activated on June 8, 2023.

FSA VIN LISTS ACTIVATION

FSA VIN Lists will be available through <https://web.fsavinlists.dealerconnection.com> on June 8, 2023. Owner names and addresses will be available by July 7, 2023.

NOTE: Your FSA VIN Lists may contain owner names and addresses obtained from motor vehicle registration records. The use of such motor vehicle registration data for any purpose other than in connection with this program is a violation of law in several states, provinces, and countries. Accordingly, you must limit the use of this listing to the follow-up necessary to complete this service action.

SOLD VEHICLES

- Owners of affected vehicles will be directed to dealers for repairs.
- Immediately contact any of your affected customers whose vehicles are not on your VIN list but are identified in OASIS. Give the customer a copy of the Owner Notification Letter (when available) and schedule a service date.
- Correct other affected vehicles identified in OASIS which are brought to your dealership.
- Dealers are to prioritize repairs of customer vehicles over repairs of new and used vehicle inventory.

**RECOMMENDED NEW VEHICLE RECOMMENDED DEMONSTRATION / DELIVERY HOLD
Customer Satisfaction Program 22B39
Certain 2022 Maverick HEVs
Maverick No-start condition**

STOCK VEHICLES

- Correct all affected units in your new vehicle inventory before delivery.
- Use OASIS to identify any affected vehicles in your used vehicle inventory.

TITLE BRANDED / SALVAGED VEHICLES

- Affected title-branded and salvaged vehicles are eligible for this service action.

OWNER REFUNDS

- Refunds are not approved for this program.

RENTAL VEHICLES

- Rental vehicles are not approved for this program.

TOWING

- If towing is required, dealers are authorized to claim up to a maximum value of \$250 to provide towing services for this program.

PICK-UP AND DELIVERY- Participating Dealers

Dealers participating in the Remote Experience Program:

- Refer to EFC12071, 2023 Remote Experience Program, Pickup & Delivery (PDL) Offset section for additional details.
- All customers affected by this program have the option of complimentary Vehicle Pick-up & Delivery service.

ADDITIONAL REPAIR (LABOR TIME AND/OR PARTS)

Additional repairs identified as necessary to complete the FSA should be managed as follows:

- For related damage and access time requirements, refer to the Warranty and Policy Manual / Section 6 – Ford & Lincoln Program Policies / General Information & Special Circumstances for FSAs / Related Damage.
- For vehicles within new vehicle bumper-to-bumper warranty coverage, no SSSC approval is required, although related damage must be on a separate repair line with the “Related Damage” radio button checked.
 - Ford vehicles – 3 years or 36,000 miles
- For vehicles outside new vehicle bumper-to-bumper warranty coverage, submit an Approval Request to the SSSC Web Contact Site before completing the repair.

RECOMMENDED NEW VEHICLE DEMONSTRATION / DELIVERY HOLD
Customer Satisfaction Program 22B39
Certain 2022 Maverick HEVs
Maverick No-start condition

CLAIMS PREPARATION AND SUBMISSION

- **Claim Entry:** Enter claims using Dealer Management System (DMS) or One Warranty Solution (OWS) online.
 - When entering claims:
 - Claim type 31: Field Service Action
 - Sub Code: 22B39
 - Customer Concern Code (CCC): C27
 - Condition Code (CC): X4
 - Causal Part Number: 14290, Quantity 0
 - For additional claims preparation and submission information, refer to the Recall and Customer Satisfaction Program (CSP) Repairs in the OWS User Guide.
- **Related Damage/Additional labor and/or parts:** Must be claimed as Related Damage on a separate repair line from the FSA with the same claim type and subcode as described in Claim Entry above.

IMPORTANT: Click the Related Damage Indicator radio button.
- **Pickup & Delivery:**
 - Dealers participating in the Remote Experience Program –
 - Refer to EFC12071, 2023 Remote Experience Program, Pickup & Delivery (PDL) Offset section for additional details.
- **Provision for Locally Obtained Supplies:** Includes additional tie straps for securing the wire harness further. Submit on the same line as the repair.
 - Program Code: 22B39
 - Misc. Expense: OTHER
 - Misc. Expense: Claim up to \$5.00 (up to \$255 total for Misc. Expense: Other)
- **Provision for Towing:** Dealers are authorized to claim up to a maximum value of \$250 to provide towing services for completing this program. Submit on the same line as the repair.
 - Program Code: 22B39
 - Misc. Expense: OTHER
 - Misc. Expense: Claim up to \$250.00 (up to \$255 total for Misc. Expense: Other)

**RECOMMENDED NEW VEHICLE DEMONSTRATION / DELIVERY HOLD
Customer Satisfaction Program 22B39
Certain 2022 Maverick HEVs
Maverick No-start condition**

LABOR ALLOWANCES

Description	Labor Operation	Labor Time
Confirm VIN and install replacement 12V battery cable	22B39B	3.7 Hours

PARTS REQUIREMENTS / ORDERING INFORMATION

Part Number	Description	Order Quantity	Claim Quantity
NZ6Z-14300-D	Wire harness-overlay	1	1
W716053-S451	Interior Side Trim Clip	As required	
W710338-S403	Right Floor Storage Bin Clips	As required	
HU5Z-14A163-C	Tie Strap	11	11

Order your parts requirements through normal order processing channels. To guarantee the shortest delivery time, an emergency order for parts must be placed.

DEALER PRICE

For the latest prices, refer to DOES II.

EXCESS STOCK RETURN

The excess stock returned for credit must have been purchased from Ford Customer Service Division by Policy Procedure Bulletin 4000.

RECOMMENDED NEW VEHICLE DEMONSTRATION / DELIVERY HOLD
Customer Satisfaction Program 22B39
Certain 2022 Maverick HEVs
Maverick No-start condition

REPLACED FSA PARTS INSPECTION AND SIGN OFF

Effective March 1st, 2021, all parts replaced as part of an FSA repair with a repair order open date of March 1st, 2021, or later must be inspected and signed off on the repair order by a member of your dealer's fixed operations management team or an employee the task has been delegated to. If the task is to be delegated to a non-management employee, the employee needs to be someone other than the technician who completed the repair and needs to understand the importance of completing this task consistently and accurately.

- All parts replaced as part of an FSA repair should be returned to the parts department following the Warranty Parts Retention and Return Policies.
- Inspect the replaced parts to verify the FSA repair was completed.
- If the FSA repair is found to be complete, the designated employee signs the repair order line or parts return stamp area (electronic or hand signed) for the FSA repair indicating the parts were inspected and validated to have been replaced.
- After the parts have been inspected, they should be handled based on the guidance in the parts status report in the Online Warranty System (Hold, Return, CORE, Scrap, etc.).
- This process is subject to review during warranty audits for FSA repairs with a repair order open date of March 1st, 2021, or later. Any eligible FSA claims requiring parts replacement found not to have been inspected and signed off during a warranty audit will be subject to chargeback and consideration for enrollment into the Dealer Incomplete Recall Repair Process.

Note: Other approvals (electronic or handwritten) for add-on repair lines, dealer-owned vehicle repairs, and repeat repairs do not qualify as FSA parts inspection approvals. The post-repair FSA parts inspection process (electronic or handwritten) is independent of other warranty approval requirements. The approval by the designated employee implies that the FSA parts were found to be replaced and must be able to be identified on the Repair Order. If multiple FSAs require approval on a single Repair Order, each applicable occurrence will require individual post-repair approval by the designated employee.

RECOMMENDED NEW VEHICLE DEMONSTRATION / DELIVERY HOLD
Customer Satisfaction Program 22B39
Certain 2022 Maverick HEVs
Maverick No-start condition













Mobile Service Repair Assessment

Assessment levels have been identified to help determine the ease of performing eligible mobile service repairs for a Field Service Action (FSA) outside of the dealership service facility.

Dealer Bulletin



Within Attachment I of the dealer bulletin, mobile service repair assessment levels will be provided. These assessment levels have been determined using the amount of time, equipment and labor identified to perform the intended service action.

Assessment Levels



-  - Mobile Reprogramming
-   - Light Mobile Service
-    - Enhanced Mobile Service
-     - Advanced Mobile Service
-  - Wheel and Tire Mobile Service
-  - Not Mobile Service Eligible

Description of each level that is used to determine the overall assessment.

-  – Mobile Reprogramming
 - Module Programming or similar type services
 - Minimum tools maybe required other than an **IDS/FDRS** setup
 - FDRS programming that requires internet connection (wi-fi or mobile hotspot)
 - Make sure vehicle has a charge port to ensure battery voltage is maintained during flashing of the module(s)
 - Repairs not greater than 1 hour in length (including time to wait for programming)

Note: The location will need a charging station or wall box to maintain the 12-volt battery.
-   – Light Mobile Service
 - Interior repair procedures that do not require seat, dash, or headliner removal
 - Under hood repairs that do not require large component removal
 - Exterior repairs that do not require large component/panel removal
 - Repairs may require standard hand tools (Access to a Technician starter kit or similar)

RECOMMENDED NEW VEHICLE DEMONSTRATION / DELIVERY HOLD
Customer Satisfaction Program 22B39
Certain 2022 Maverick HEVs
Maverick No-start condition

   – Enhanced Mobile Service

- ***A two-person process is required anytime a procedure requires work under the vehicle***
 - Brake Inspection and Brake Repair/Replacement
 - Limited Suspension Component replacement (no alignment)
 - Under Vehicle access for limited repairs (no large component removal)
 - Vehicle Check Up - VCU
 - Pre-Delivery Inspection - PDI
 - Used Car Inspection/Presale Inspection
 - May require floor jack, jack stands, and impact tools
- Note: Wheel lock may be required.*

    – Advanced Mobile Service

- Fluid Exchange/Oil Change
- Light Repairs
- Brake Hydraulic Repairs

 – Wheel and Tire Mobile Service

- Tire Removal from Wheel
- Tire Balancing
- Tire Repair

Note: Specialized Mobile Service unit and equipment including Tire balancer and Tire Changer required.

 – Not Mobile Service Repair Eligible

- Large component removal
- BEV Battery Replacement
- Requires a vehicle hoist – to complete the repair (more than inspection)
- Required vehicle alignment
- Requires significant vehicle disassembly
- Repairs greater than 2-3 hours
- Any repairs that require M-Time
- Includes a service procedure where the vehicle owner may be distressed about the state of their vehicle



Ford Motor Company
Ford Customer Service Division
P. O. Box 1904
Dearborn, Michigan 48121

June 2023

Customer Satisfaction Program 22B39

Mr. John Sample
123 Main Street
Anywhere, USA 12345

Your Vehicle Identification Number (VIN): 12345678901234567

At Ford Motor Company, we are committed not only to building high-quality, dependable products but also to building a community of happy, satisfied customers. To demonstrate that commitment, we are providing a no-charge Customer Satisfaction Program for your vehicle with the VIN shown above.

Why are you receiving this notice? On your vehicle, it may be possible a 12V battery connection may become loose, resulting in a no-start condition.

What is the effect? This may result in the inability to start the vehicle.

What will Ford and your dealer do? In the interest of customer satisfaction, Ford Motor Company has authorized your dealer to install a new 12V battery cable overlay free of charge (parts and labor) under the terms of this program.
This Customer Satisfaction Program will be in effect until June 30, 2024 regardless of mileage. Coverage is automatically transferred to subsequent owners.

How long will it take? The time needed for this repair is less than one-half day. However, due to service scheduling requirements, your dealer may need your vehicle for a longer period of time

What should you do? Please call your dealer without delay to schedule a service appointment for Customer Satisfaction Program 22B39. Provide the dealer with your VIN, which is printed near your name at the beginning of this letter.

If you do not already have a servicing dealer, you can access ford.com/support for dealer addresses, maps, and driving instructions.

Ford Motor Company wants you to have this service action completed on your vehicle. The vehicle owner is responsible for making arrangements to have the work completed.

NOTE: You can receive information about Recalls and Customer Satisfaction Programs through our FordPass App. The app can be downloaded through the App Store or Google Play. In addition, there are other features such as reserving parking in certain locations and controlling

**What should you do?
(Continued)**

certain functions on your vehicle (lock or unlock doors, remote start) if it is equipped to allow control.

What if you no longer own this vehicle?

If you no longer own this vehicle and have an address for the current owner, please forward this letter to the new owner.

You received this notice because our records, which are based primarily on state registration and title data, indicate that you are the current owner.

Can we assist you further?

If you have difficulties getting your vehicle repaired promptly and without charge, please contact your dealership's Service Manager for assistance.

RETAIL OWNERS: If you have questions or concerns, please contact our **Ford Customer Relationship Center at 1-866-436-7332** and one of our representatives will be happy to assist you. If you wish to contact us through the Internet, our address is ford.com/support.

For the hearing impaired call 1-800-232-5952 (TDD). Representatives are available Monday through Friday: 8:00 AM – 8:00 PM (Eastern Time).

FLEET OWNERS: If you have questions or concerns, please contact our **Ford Pro Contact Center at 1-800-34-FLEET**, choose Option #1, and one of our representatives will be happy to assist you. If you wish to contact us through the Internet, our address is fleet.ford.com.

Representatives are available Monday through Friday: 7:00 AM – 11:00 PM and Saturday 7:00 AM – 5:00 PM (Eastern Time).

Thank you for your attention to this important matter.

Ford Customer Service Division

CERTAIN 2022 MODEL YEAR MAVERICK VEHICLES EQUIPPED WITH A 2.5L FULL HYBRID ELECTRIC VEHICLE POWERTRAIN — HARNESS LAYOVER

SERVICE PROCEDURE

1. De-energize the high voltage system. Follow Workshop Manual (WSM) procedures in Section 414-03.
2. Disconnect the battery. Follow WSM procedures in Section 414-01.

NOTICE: Before disconnecting the high voltage battery electrical connector, the electrical connector must be cleaned with a nylon brush and free of debris. Blow any dirt or debris from the electrical connector with compressed air before disconnecting or component damage may occur.

WARNING: High voltage electrical connectors may require unique methods to be disconnected. If not properly disconnected, component damage may occur.

3. Clean the high voltage battery electrical connector with a nylon brush. Blow any dirt or debris from the electrical connector with compressed air.
4. Disconnect the high voltage battery electrical connector from the Direct Current/Direct Current (DC/DC) Converter Control Module. See Figure 1.

NOTE: Refer to WSM Section 414-03 (High Voltage Battery, Mounting and Cables, General Procedures, High Voltage Connector Disconnect and Connect).

5. Detach the retainer and position the wire harness aside. See Figure 1.

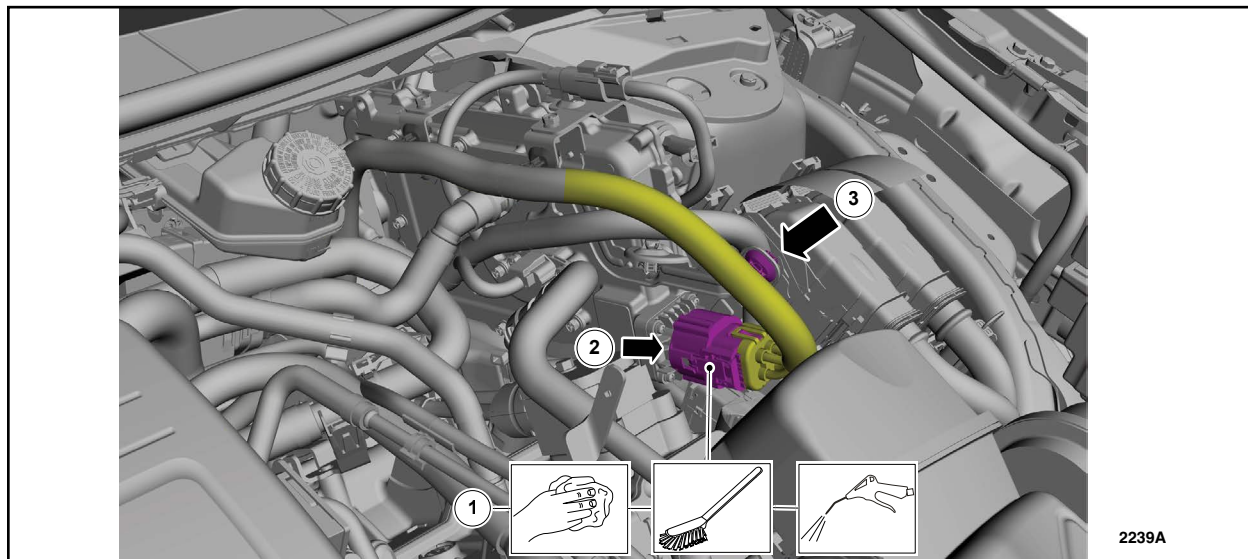

FIGURE 1



6. Release the tabs and battery junction box cover. See Figure 2.

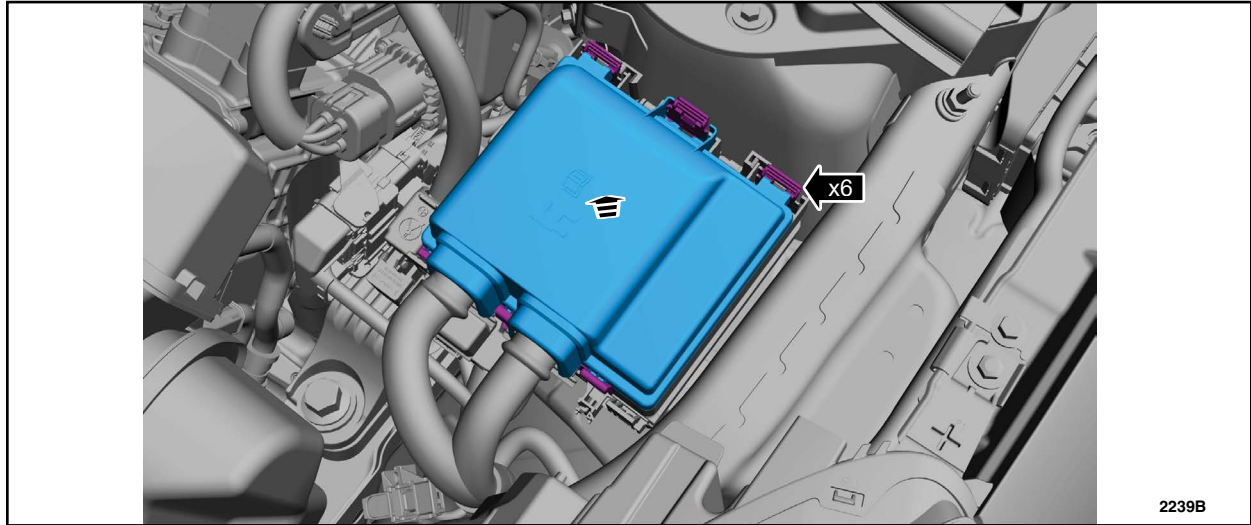

FIGURE 2

7. Disconnect the battery junction box electrical connectors. See Figure 3.

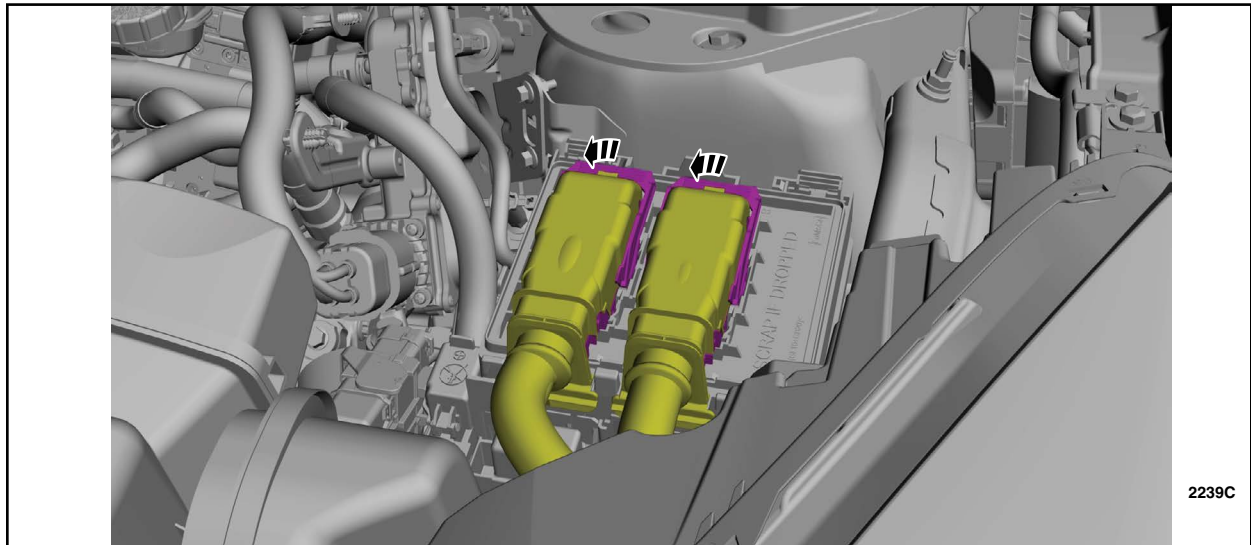

FIGURE 3



8. Release the wire guide from the battery junction box. See Figure 4.

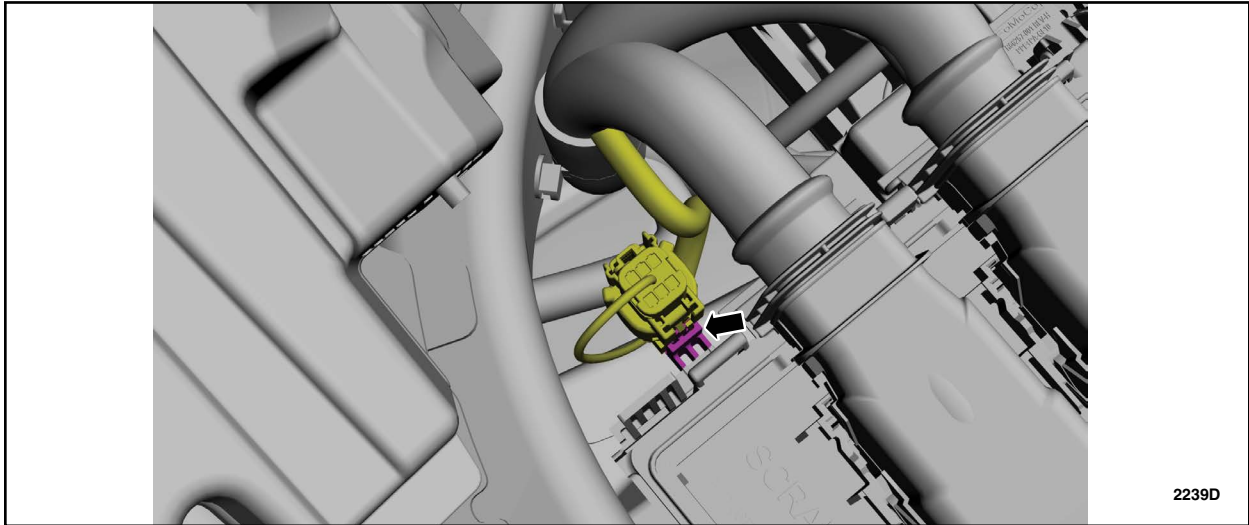

FIGURE 4

9. Release the tabs and remove the power distribution box from the bracket. See Figure 5.

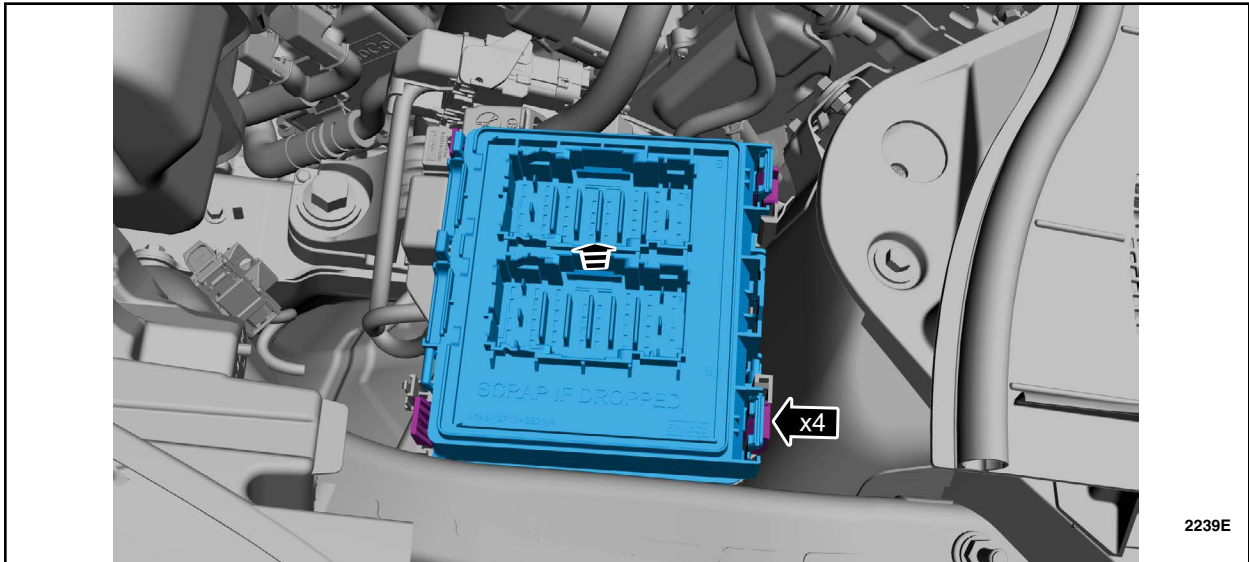

FIGURE 5



10. Remove the power cable terminal cover. See Figure 6.

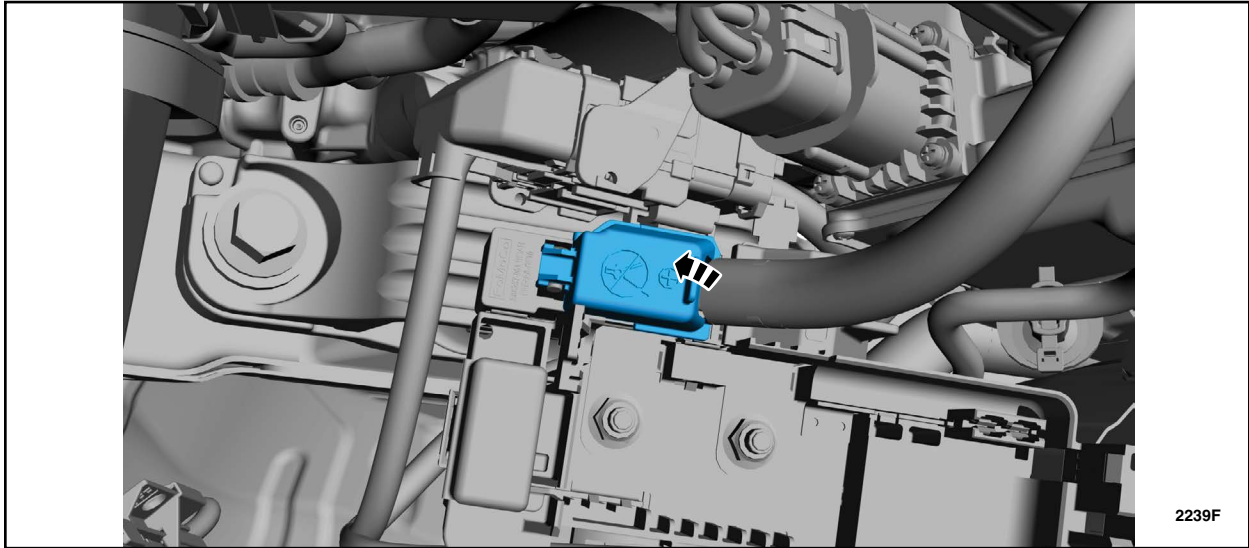

FIGURE 6

11. Remove the nut. See Figure 7.
Torque: 106 lb. in (12 Nm)

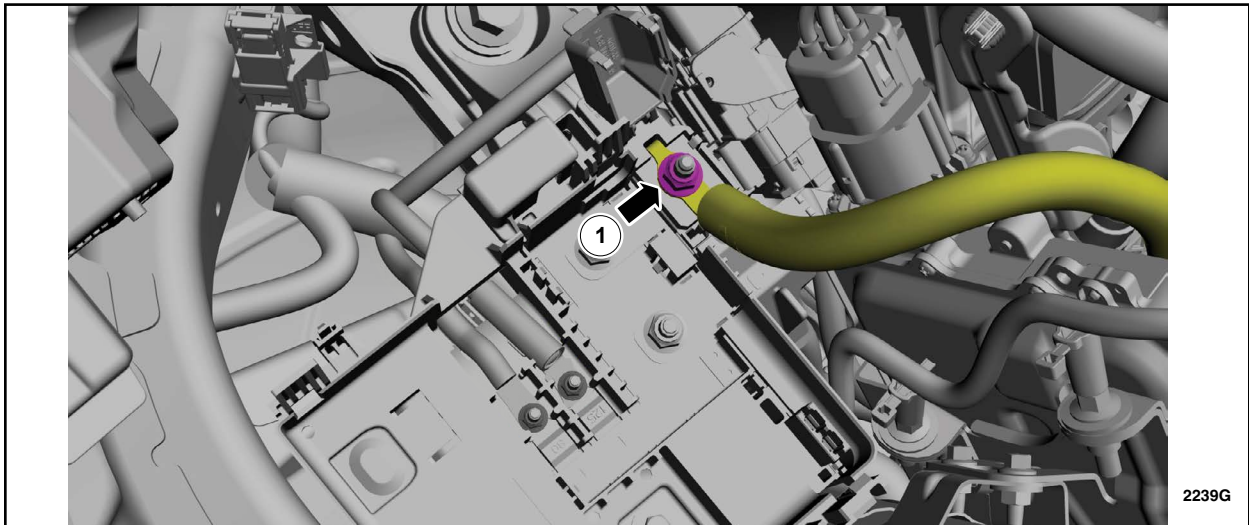

FIGURE 7



12. Disconnect the electrical connector and position aside the wire. See Figure 8.

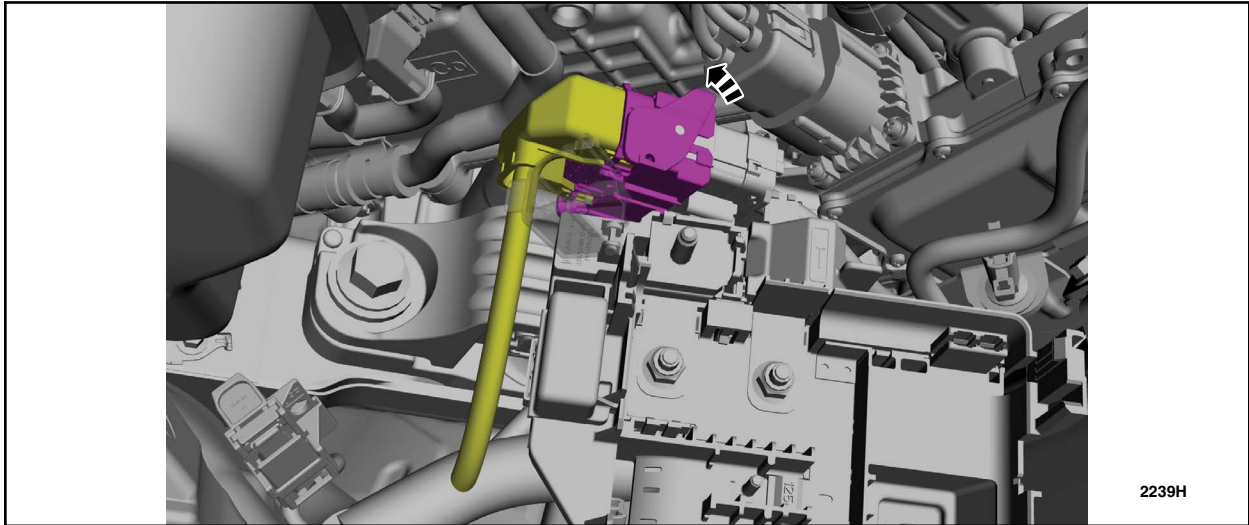

FIGURE 8

13. Release the wire guide from the battery junction box. See Figure 9.

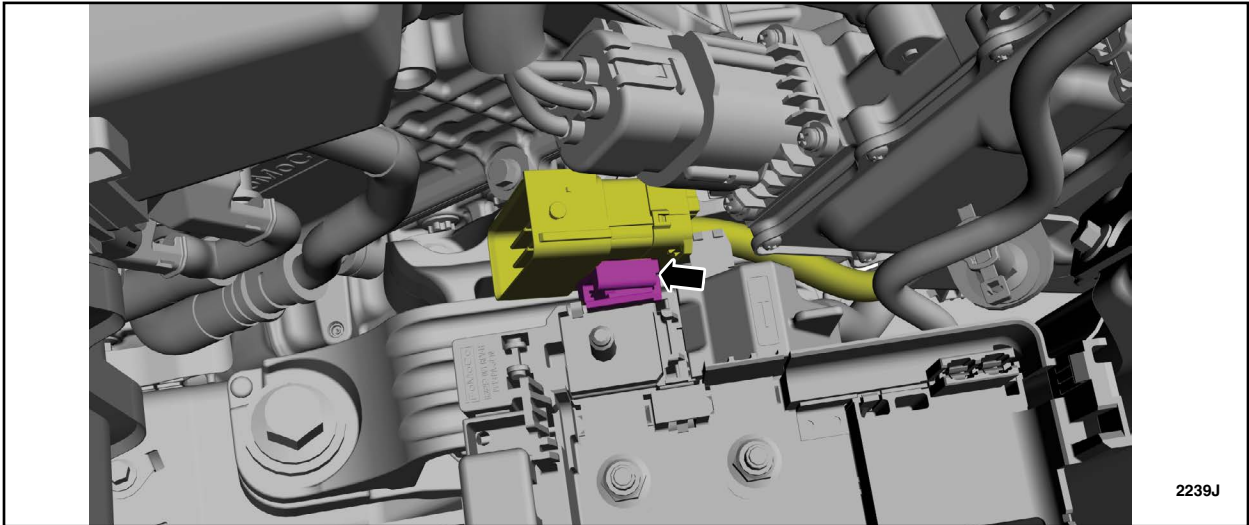

FIGURE 9



14. Remove the power cable terminal cover. See Figure 10.

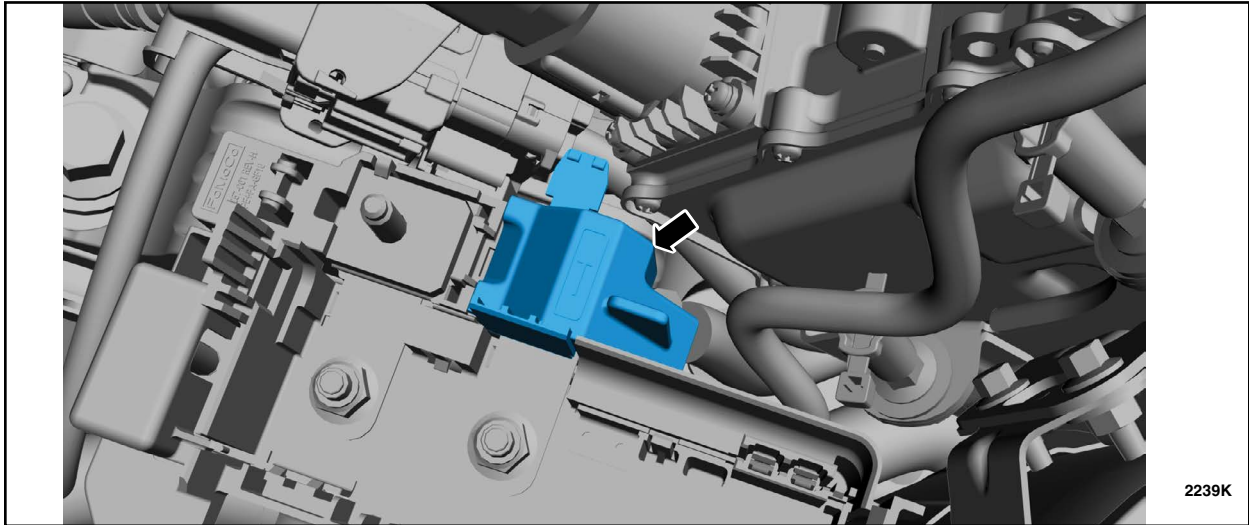

FIGURE 10

15. Remove the nut and position aside the power cable. See Figure 11.
Torque: 106 lb.in (12 Nm)

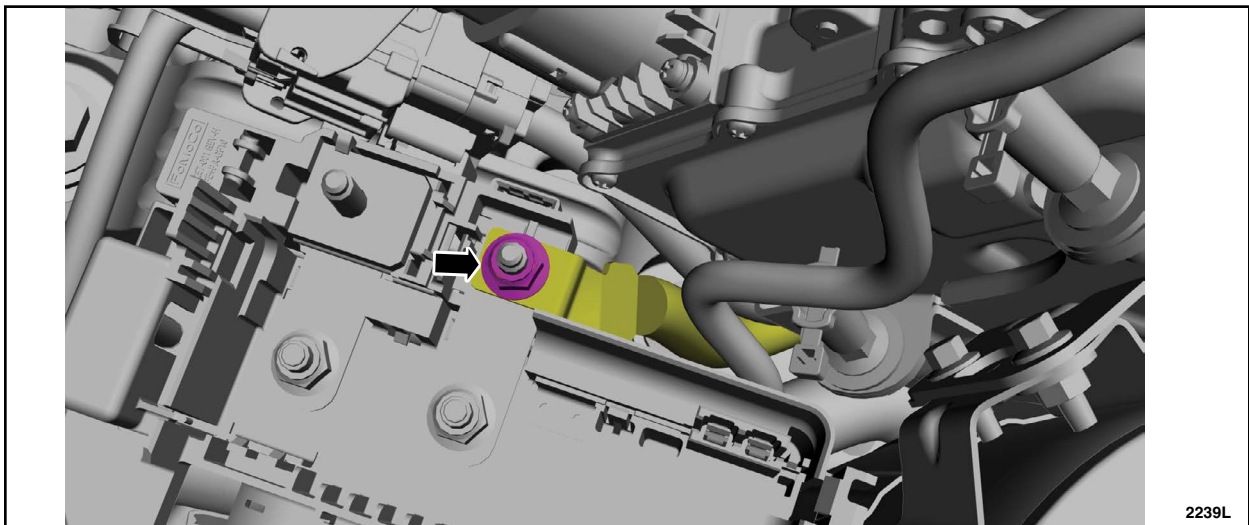

FIGURE 11



16. Remove the bolt and washer. See Figure 12.

Torque: 83 lb. in (10.5 Nm)

Remove the battery junction box bracket retainers. See Figure 12.

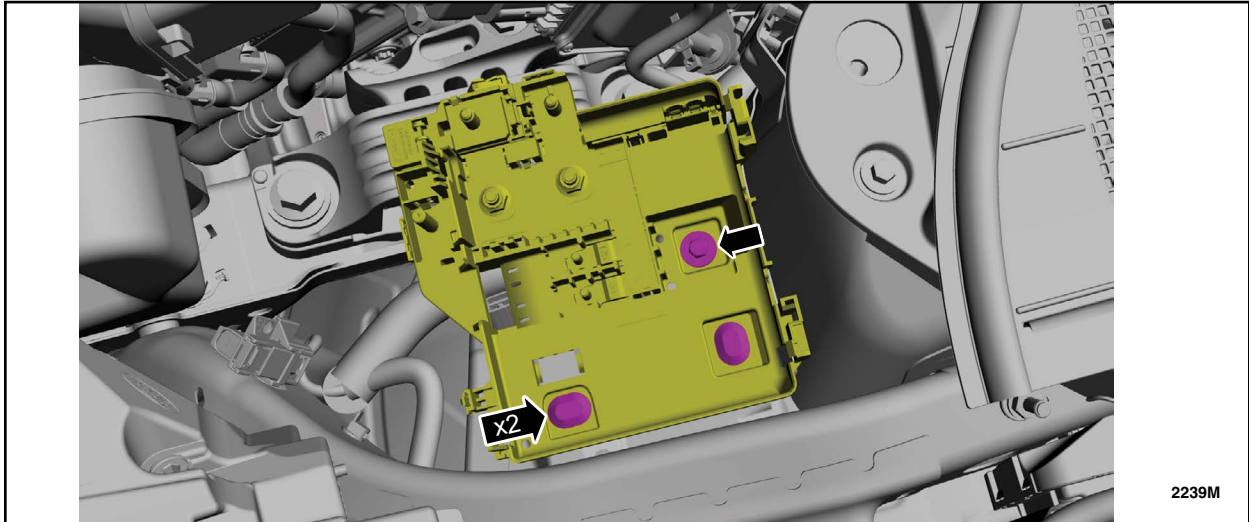

FIGURE 12

17. Remove Left Hand (LH) Lower B Pillar. Follow WSM procedures in Section 501-05.

18. Remove the Rear Floor Storage Bin. Follow WSM procedures in Section 501-05.

19. Access the **clutch port** from the drivers side, under the Instrument Panel. See Figure 13.

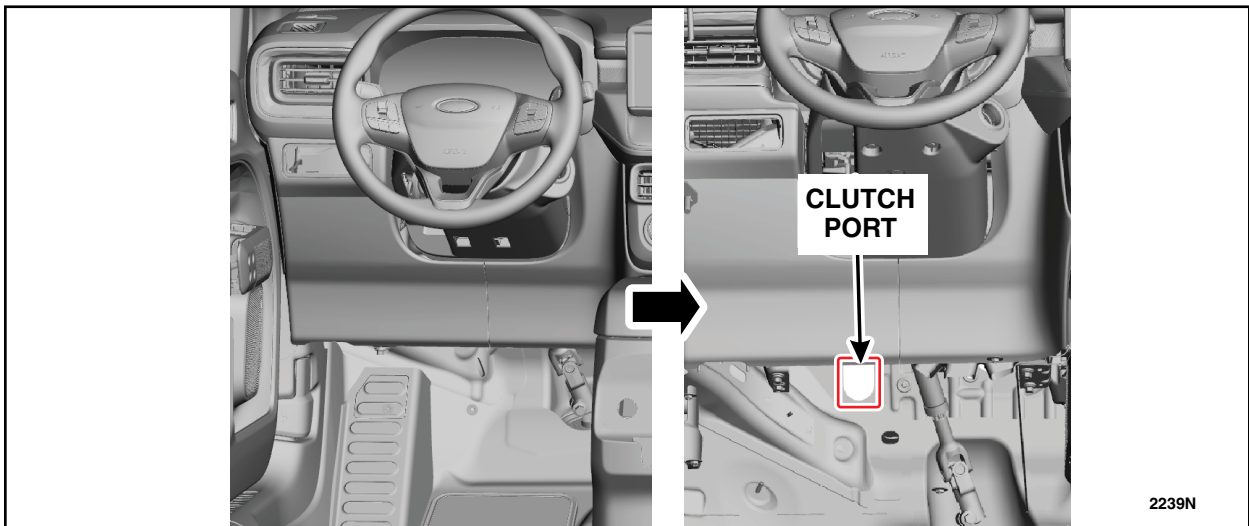

FIGURE 13



20. Remove and discard the grommet. Insert the new wire harness, short side, into this port until it is stopped by the rubber grommet that is installed on the wire harness. See Figure 14.



FIGURE 14

See Figure 15 below for the full routing path of the harness.

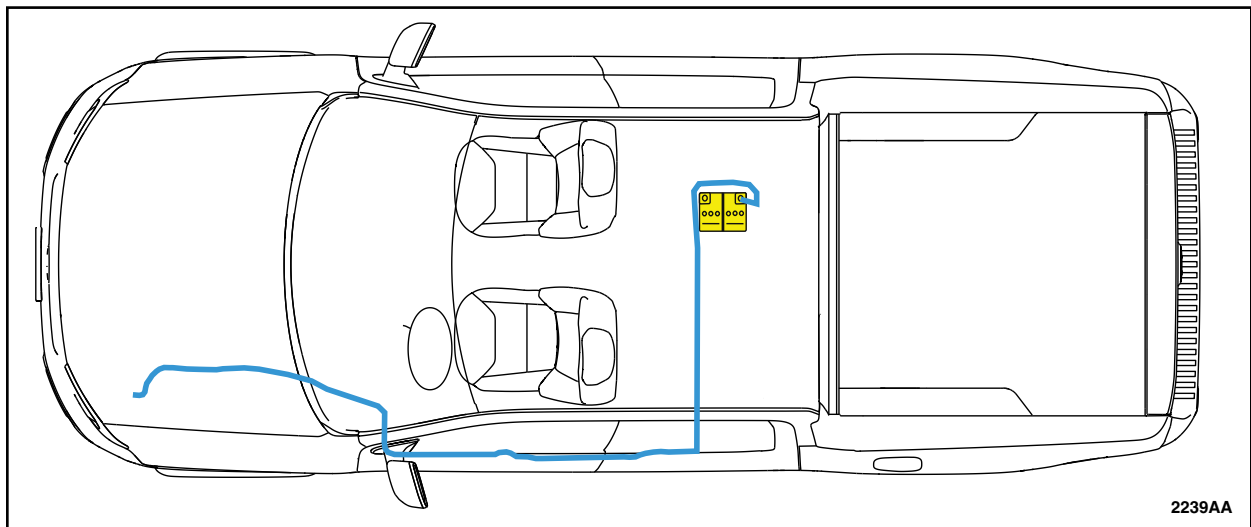

FIGURE 15



21. Route the front portion of the harness through the engine bay as shown in Figure 16. New harness will follow the same path as the old harness.

NOTE: Battery Junction Box and other items have been removed for clarity.

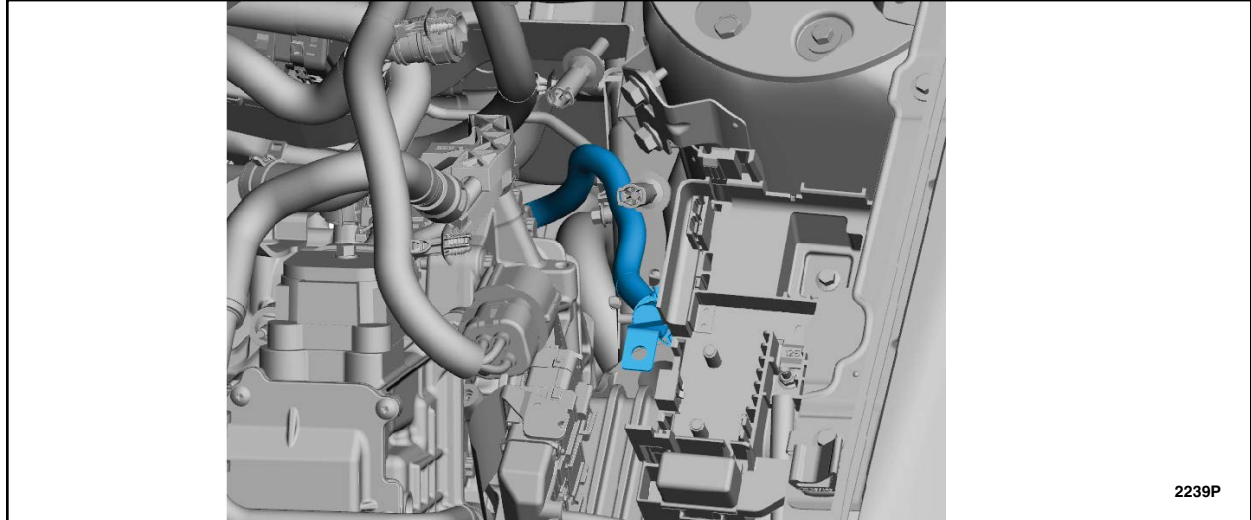

FIGURE 16

22. Secure wire harness to the DC/DC Converter Module stud bolts., with the 2 push pin retainers that are installed on the harness. See Figure 17

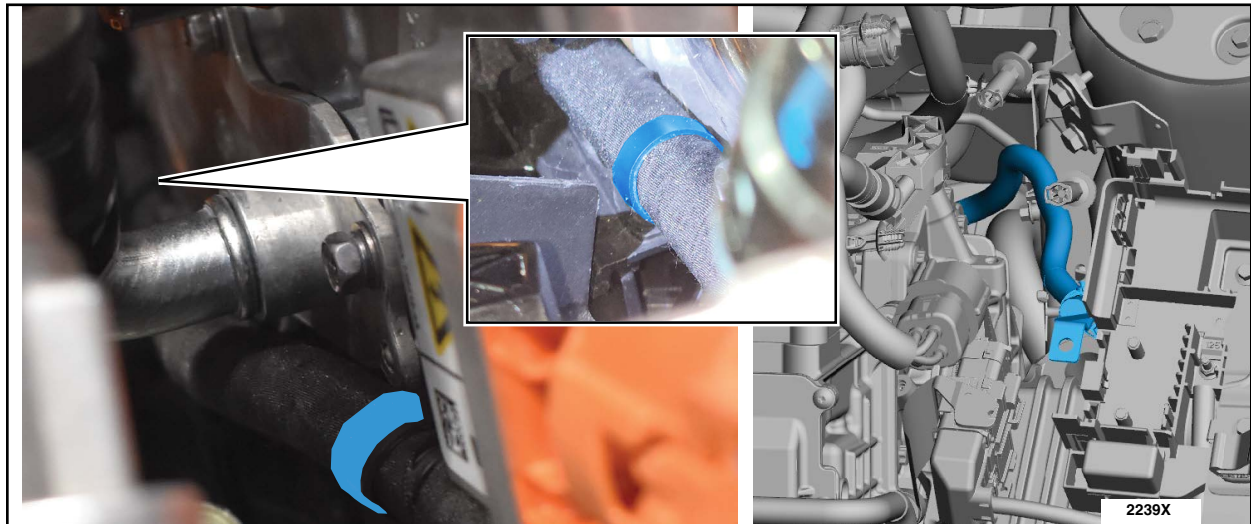

FIGURE 17



23. From inside the vehicle route the harness through the pillar areas. See Figure 18.

NOTE: Place a tie strap at each piece of blue tape found throughout the new harness.

NOTE: It may be necessary to open the harness bundle shield before routing the harness.

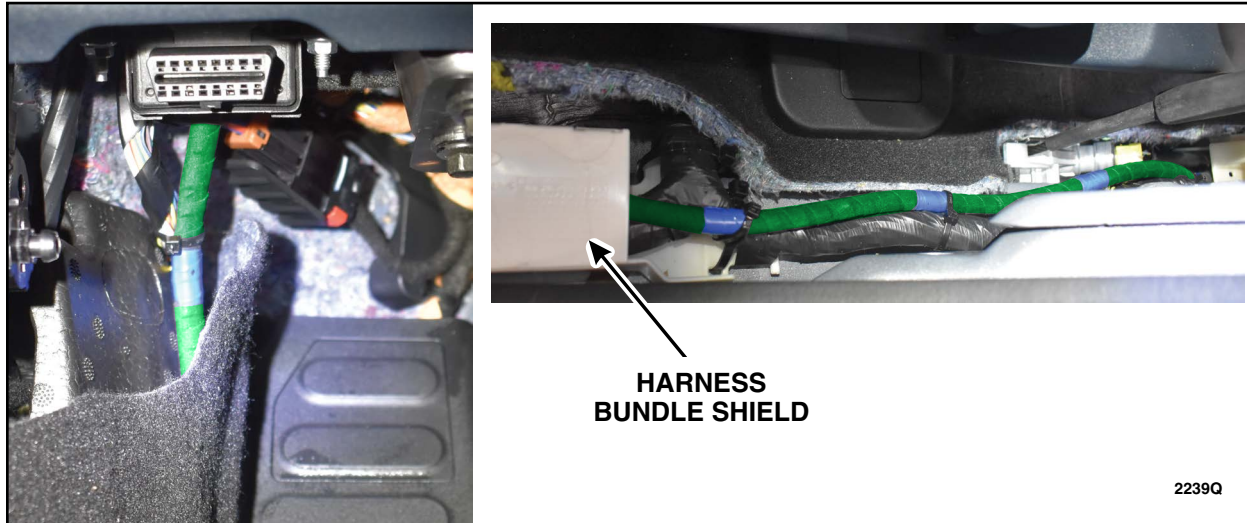

FIGURE 18

24. Continue to route wire harness through the door pillar area, moving towards the rear cargo area. See Figure 19.



NOTICE: Ensure to place a tie strap on the new harness to keep it from touching the airbag connector.

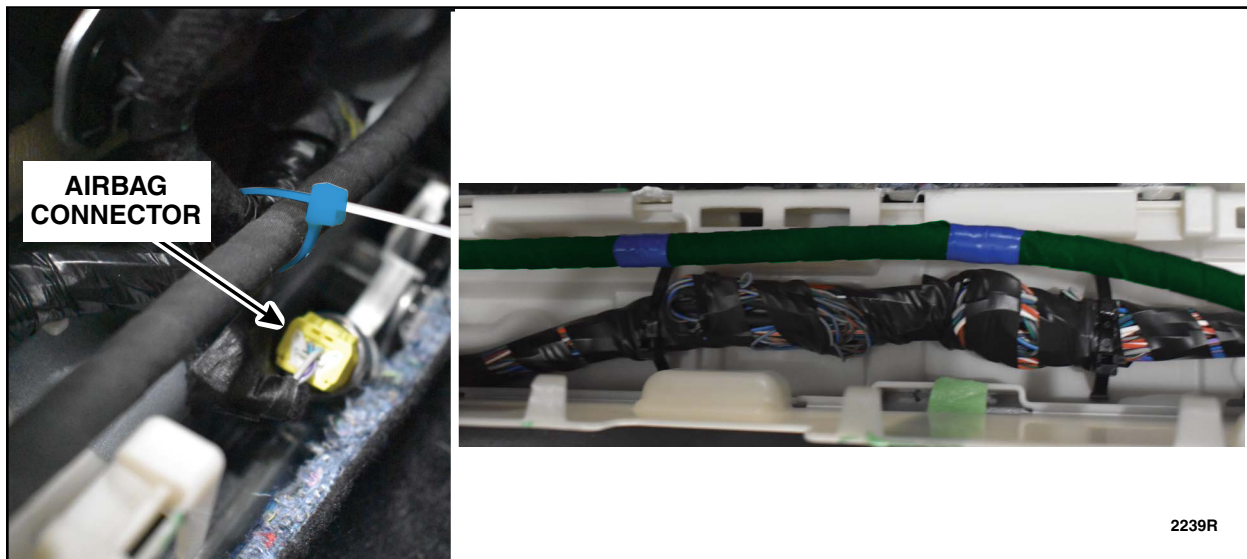

FIGURE 19



25. Position the carpet aside. See Figure 20.



FIGURE 20

26. Route harness underneath the shield. Follow the path until the harness can be routed down along the Rear Floor Storage area. See Figure 21.

NOTE: Make sure to lay out the harness across the Rear Floor Storage area and then apply the adhesive tie straps.

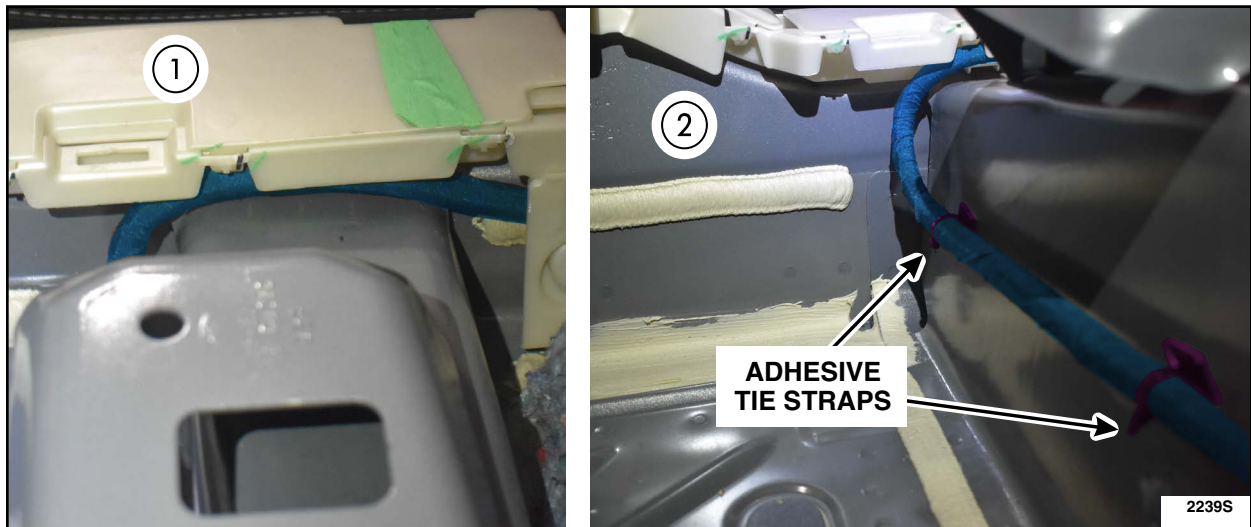

FIGURE 21



27. Route harness as shown in Figure 22, moving towards the battery in the Rear Floor Storage area.

NOTE: Continue to secure harness with the adhesive tie straps.

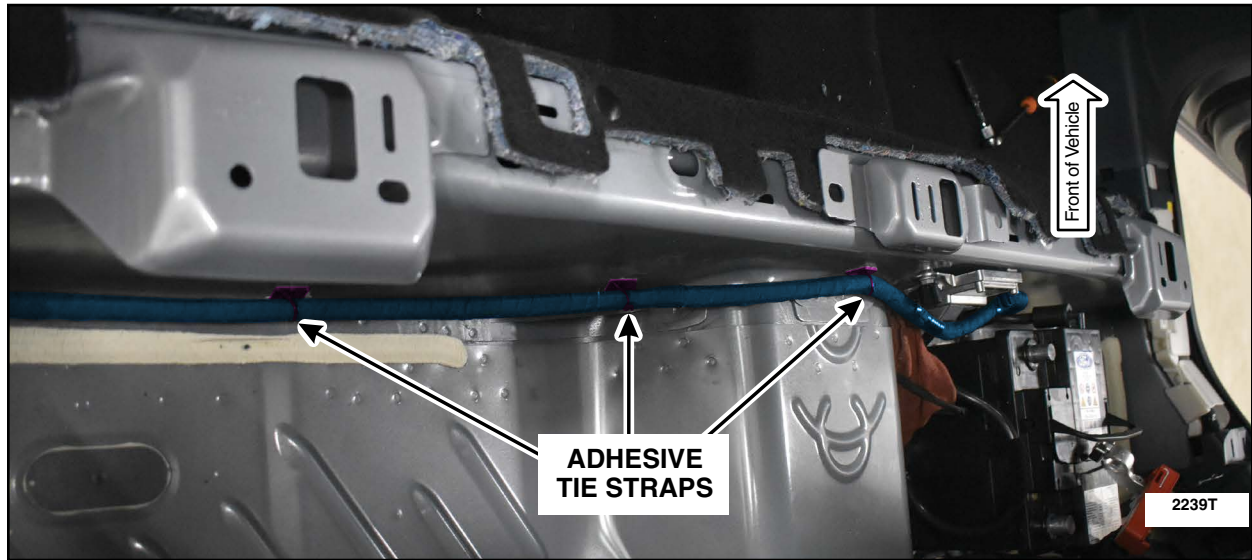

FIGURE 22

28. Install the protective caps while routing the harness. See Figure 23.



FIGURE 23



29. Disconnect the old harness from the positive cable. See Figure 24.

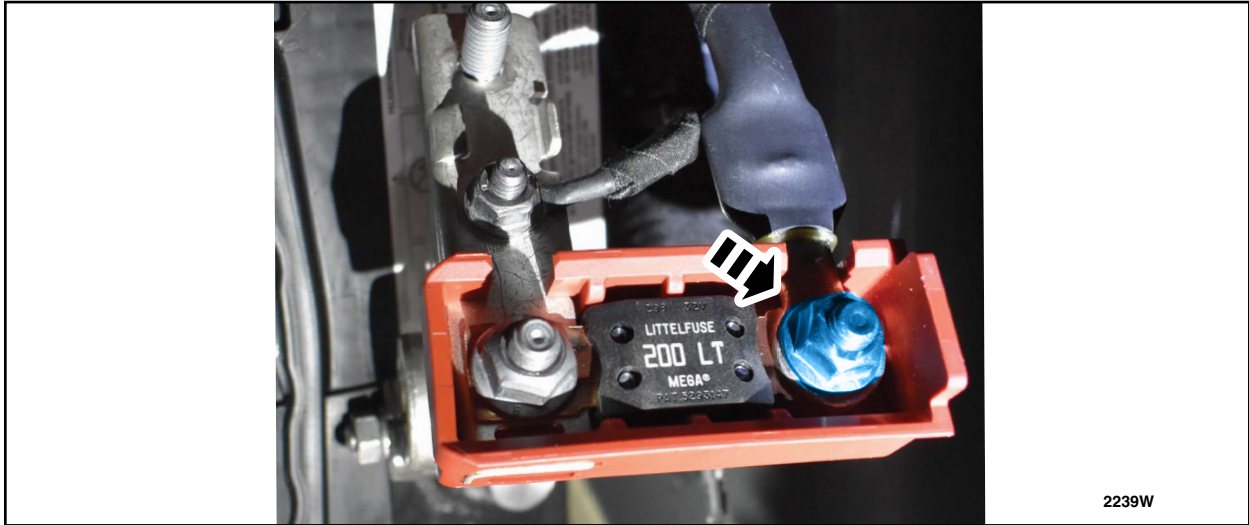

FIGURE 24

30. Cut terminal end off of the old harness. Add Dual Wall Heat Shrink tubing to cover the open end of the wire and secure with tape. Using a zip tie, attach old harness to new harness. See Figure 25.

NOTE: Pinch end of Heat Shrink to ensure that it is properly secured.

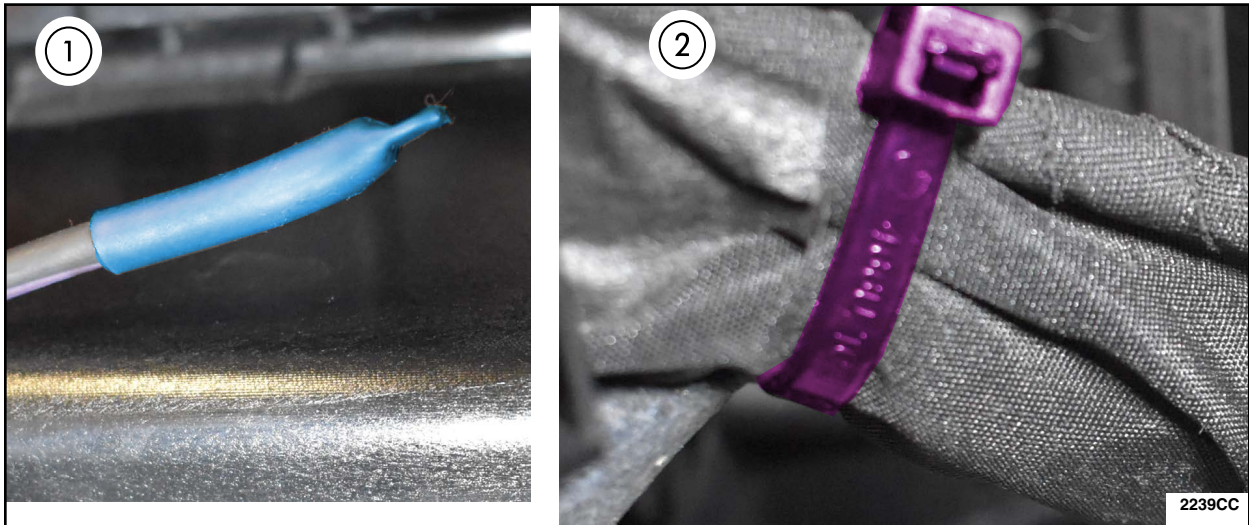

FIGURE 25



31. Route harness, as shown in Figure 26, making sure to secure the end to the battery, in place of the old harness.

Torque: 93 lb.in (10.5 Nm)

NOTE: Be sure to secure the harness with the attached adhesive tie strap as in previous steps, as well as the edge biter clips.

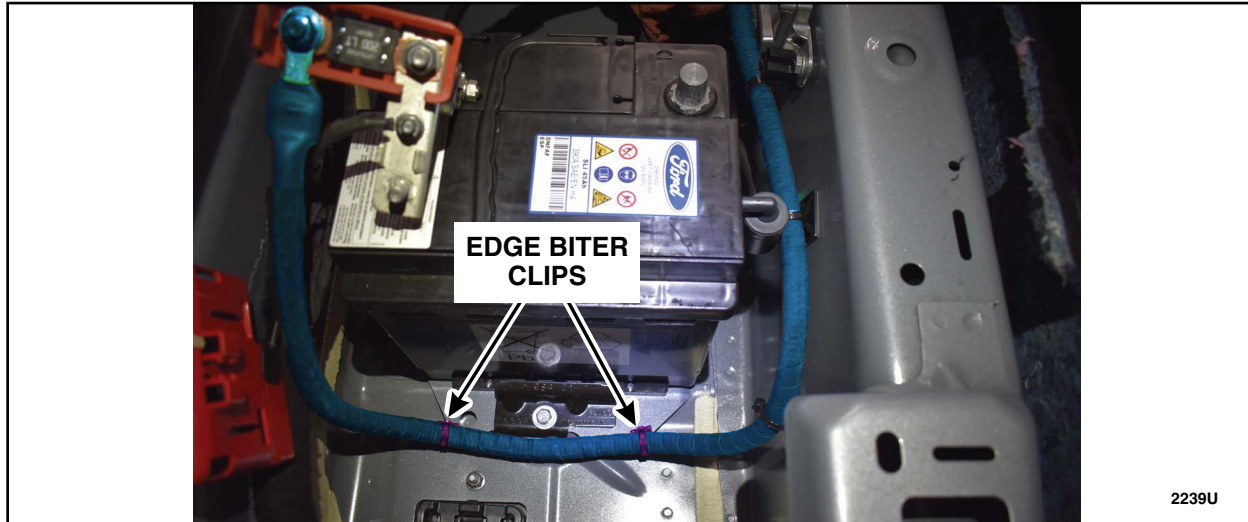

FIGURE 26

32. Under the hood cut terminal end off of the old harness. Add Dual Wall Heat Shrink tubing to cover the open end of the wire and secure with tape. Secure to harness. See Figure 27.

NOTE: Pinch end of Heat Shrink to ensure that it is properly secured.

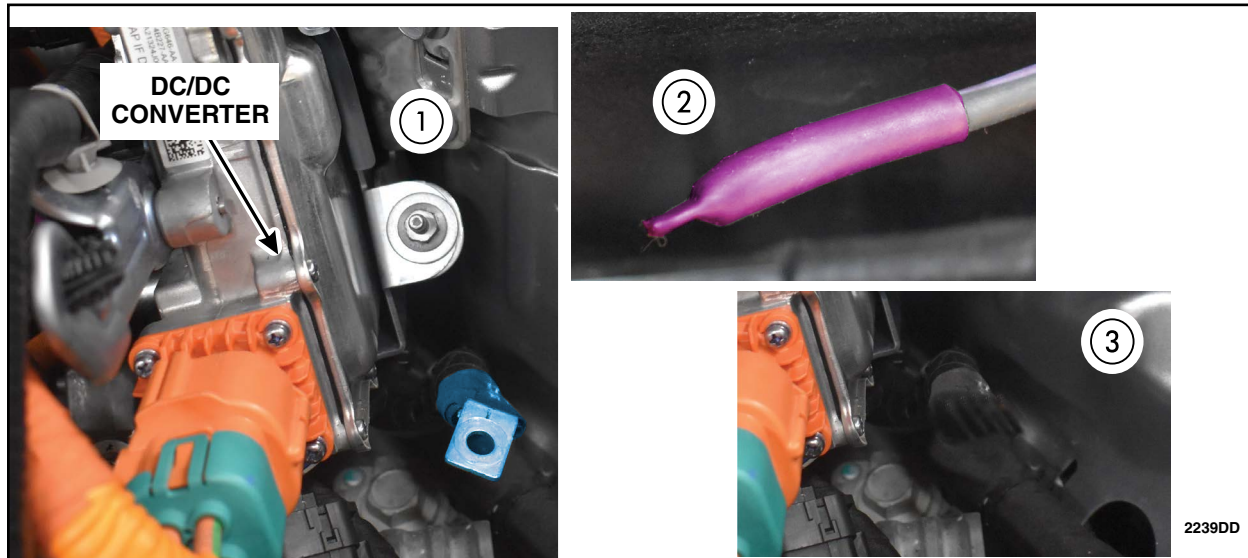

FIGURE 27



33. If there is any excess wire harness left, secure using zip ties underneath the dash area.
See Figure 28.



FIGURE 28

34. Secure the new harness to the terminal.
Torque: 106 lb.in (12 Nm)



FIGURE 29

35. To reassemble vehicle, reverse steps 1-18.

IMPORTANT NOTE: Federal law prohibits selling motor vehicle parts or components that are under safety, compliance, or emissions recall. Unless a part is requested to be returned to Ford, all parts replaced under this FSA must be scrapped in accordance with all applicable local, state and federal environmental protection and hazardous material regulations. Refer to the Parts Retention, Return, & Scrapping section of the FSA dealer bulletin for further information.

