

June 27, 2023

Version 9

## Popping/Crackling from the Speakers; Display Blank

Supersedes 20-031 dated June 23, 2023, to revise the information highlighted in **yellow**.

### AFFECTED VEHICLES

Year	Model	Trim Level	VIN Range
2021	RDX	ALL	ALL

### REVISION SUMMARY

Under WARRANTY CLAIM INFORMATION, the LON number was updated.

### SYMPTOM

There is a popping or crackling from the speakers, a blank display, or no sound from the audio system. You may also see a **Network Loss** message.

### POSSIBLE CAUSE

There is a loose connection in the MOST bus network.

### CORRECTIVE ACTION

Install the FAKRA splice repair service cables and splice boxes.

### PARTS INFORMATION

Part Name	Part Number	Quantity
Splice boxes	39817-THR-305	8 Splice boxes (16 Halves)
FAKRA splice repair service cable (Green)	39165-THR-AB0	3
FAKRA splice repair service cable (Red)	39165-THR-AA0	3
FAKRA splice repair service cable (Blue)	39165-THR-AC0	2
SRS quarter panel C-pillar trim clip	91561-TA5-A11	1

### TOOL INFORMATION

Tool Name	Tool Number	Quantity
Straight FAKRA Puller	07AAC-THRA200	1

NOTE: For more information on using the FAKRA tools see the job aid: *Using the MOST Connector Tools*.

**CLIENT INFORMATION:** The information in this bulletin is intended for use only by skilled technicians who have the proper tools, equipment, and training to correctly and safely maintain your vehicle. These procedures should not be attempted by "do-it-yourselfers," and you should not assume this bulletin applies to your vehicle, or that your vehicle has the condition described. To determine whether this information applies, contact an authorized Acura automobile dealer.

**WARRANTY CLAIM INFORMATION**

<b>Operation Number</b>	<b>Description</b>	<b>Flat Rate Time</b>	<b>Defect Code</b>	<b>Symptom Code</b>	<b>Template ID</b>	<b>Failed Part Number</b>
0101T5	Access the infotainment control unit, in-line connectors, stereo amp, and tuner unit then replace the affected FAKRA Splice repair service cables, and splice boxes.	1.3 hr	03214	03217	B20031C	39540-TJB-A01

Skill Level: Repair Technician

## FAKRA CONNECTOR HOUSING DISASSEMBLY/FAKRA SPLICE REPAIR SERVICE CABLE ASSEMBLY PROCEDURE

1. Follow the below steps to better understand the cable and splice box installation instructions.
2. The connectors will either be the original FAKRA housing or the WPC FAKRA service housing.

### NOTE:

- There may be multiple components that require the affected FAKRA connectors to be removed.
- Use the straight FAKRA puller to remove the connector from a component.

### Original FAKRA Housing Removal Procedure

1. Use a small screwdriver, remove the secondary lock, then release the tab as shown.

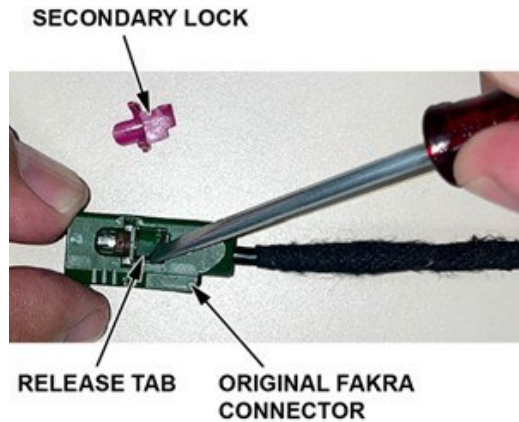

2. Pull to remove the housing from the vehicle harness. Then, **discard** the housing and lock.

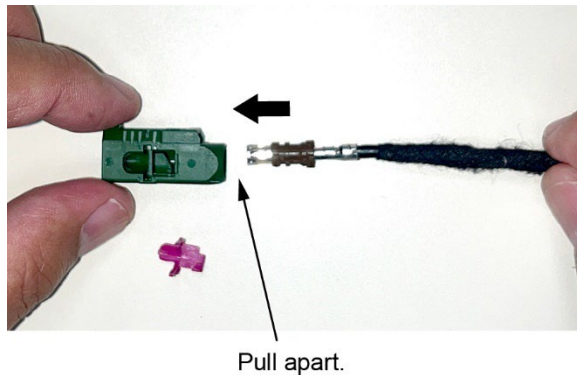

### WPC FAKRA Service Housing Removal Procedure

1. Release the two locking tabs on the WPC FAKRA service housing and remove the housing from the terminal.

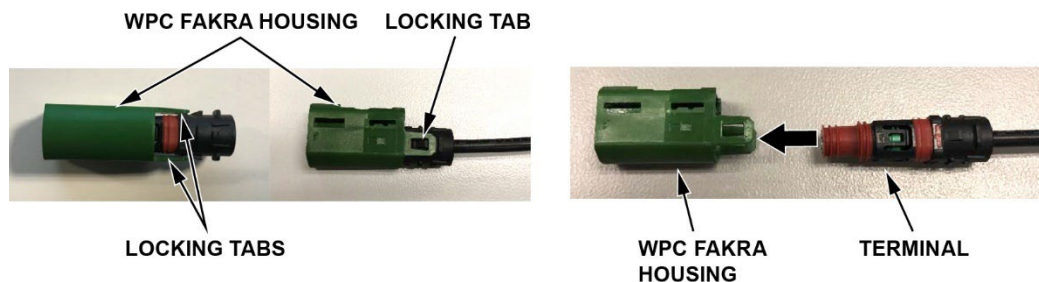

2. Release the lock tab and remove the terminal from the vehicle harness.



TERMINAL RELEASE TAB

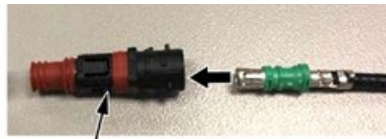

TERMINAL

### FAKRA Splice Repair Service Cable Assembly

1. Install the appropriate FAKRA splice repair service cables and splices boxes as shown in the steps that follow:

NOTE:

- The splice box arrow must always point in the direction of either the red flag label or red sleeve on the FAKRA splice repair service cable.
- If the splice box is installed **incorrectly**, the repair will fail; MOST ring failure conditions will still occur.
- Some vehicles may only use the 90 deg FAKRA splice repair service cables.

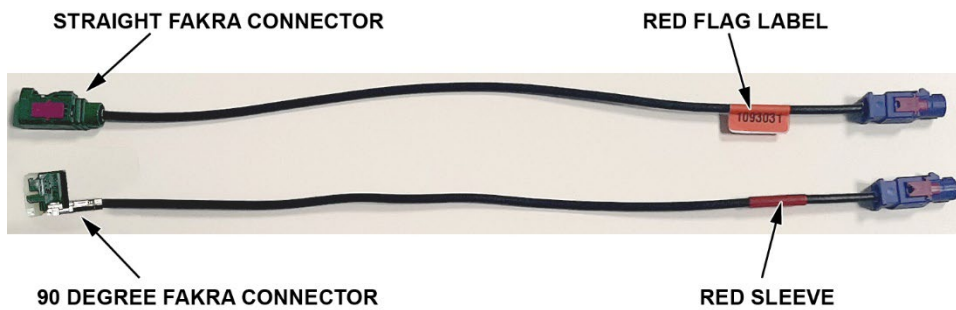

2. Use a small screwdriver to remove the secondary lock and then, release the tab.

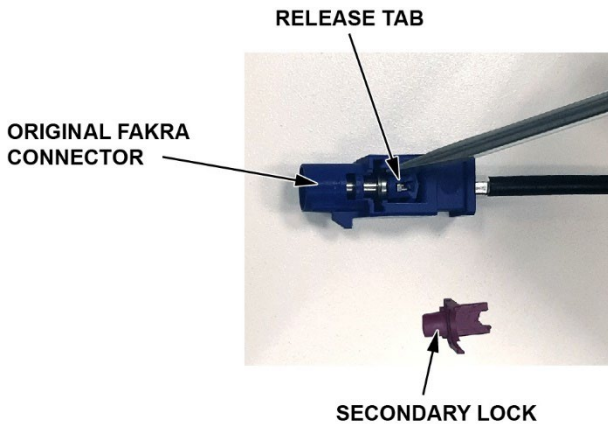

3. Pull to remove the housing from the cable and then discard the housing and secondary lock tab from the FAKRA splice repair service cable.

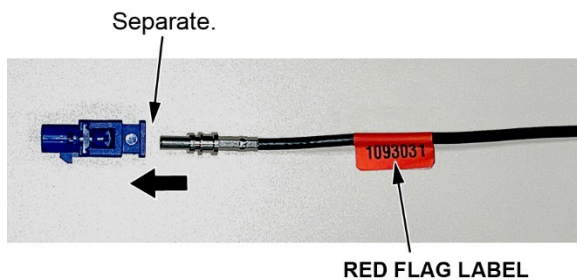

- Connect the appropriate color FAKRA splice repair service cable to the vehicle harness.

NOTE: Always disassemble the connectors one at a time to avoid swapping the green and red wires.

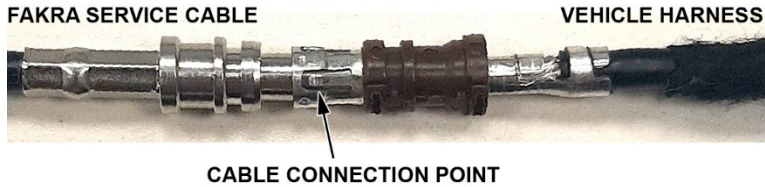

- Attach the splice box halves to the cable connection.

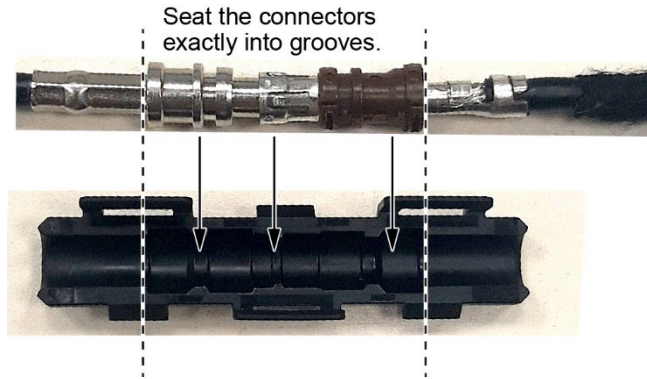

- When mating the two splice box halves, **make sure** that all **6 lock tabs** are fully engaged. You may hear a click when installing the two halves.

NOTE:

- The splice box arrow must always point in the direction of the red flag label or red sleeve on the FAKRA splice repair service cable.
- If any of the lock tabs break during installation, the splice box half(s) must be replaced.
- If the splice box is installed **incorrectly**, the repair **will fail**; MOST Ring failure conditions will still occur.

**CORRECT** ✓

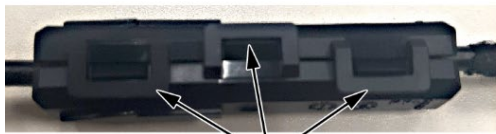

All 6 clips connected.

**INCORRECT** ✗

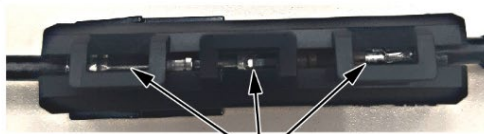

Exposed slice visible.

- Make sure the arrow on the splice box **faces** towards the red flag label.

**CORRECT** ✓



Arrow facing toward red flag label.

Fully seated in splice box.

**INCORRECT** ✗



8. Once the FAKRA splice repair service cables and splice boxes have been attached to the cable connection, tape the splice boxes and FAKRA service cables to the appropriate component harness.

NOTE: Reference below for a correct example of the cable connection routing.

Attach the fakra splice repair service cables to the appropriate component harness with tape to prevent any rattles.



Keep smooth curves with a radius bend greater than 25 mm.

**CORRECT** ✓



Keep smooth curves with a radius bend greater than 25 mm.



**INCORRECT** ✗



NOTE: Make sure the FAKRA splice repair service cables are not bent at connector(s) as shown below.

**CORRECT** ✓

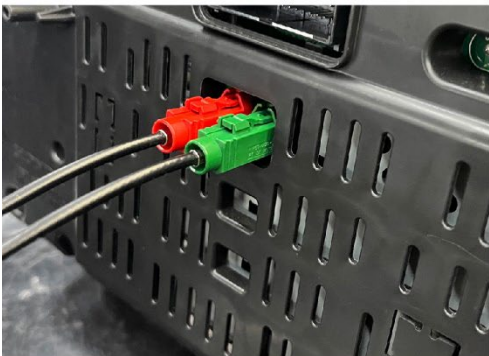

**INCORRECT** ✗

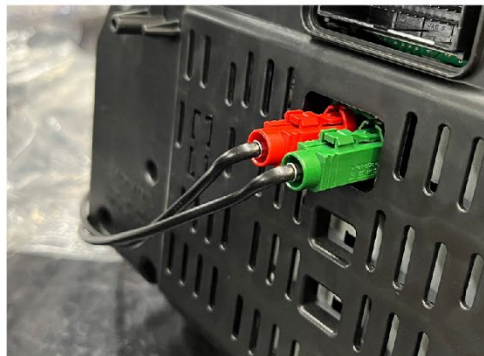

## REPAIR PROCEDURE

### RDX – TRIM REMOVAL PROCEDURE

1. Remove the dash side panel and air vent.

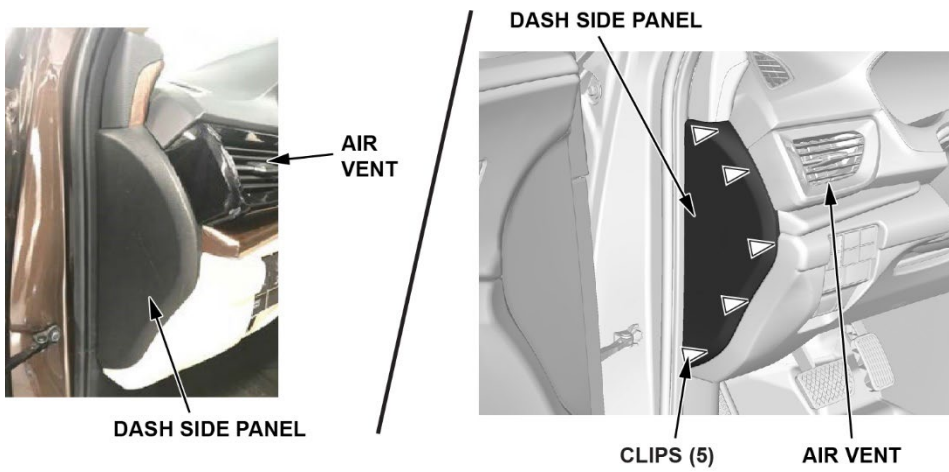

2. Remove the two screws.

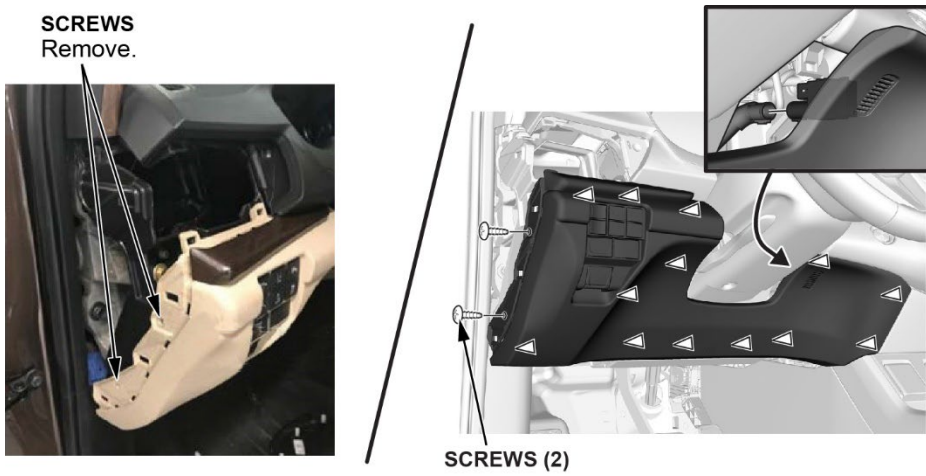

3. Remove the lower trim, and disconnect the switch connectors and in-car temperature sensor.

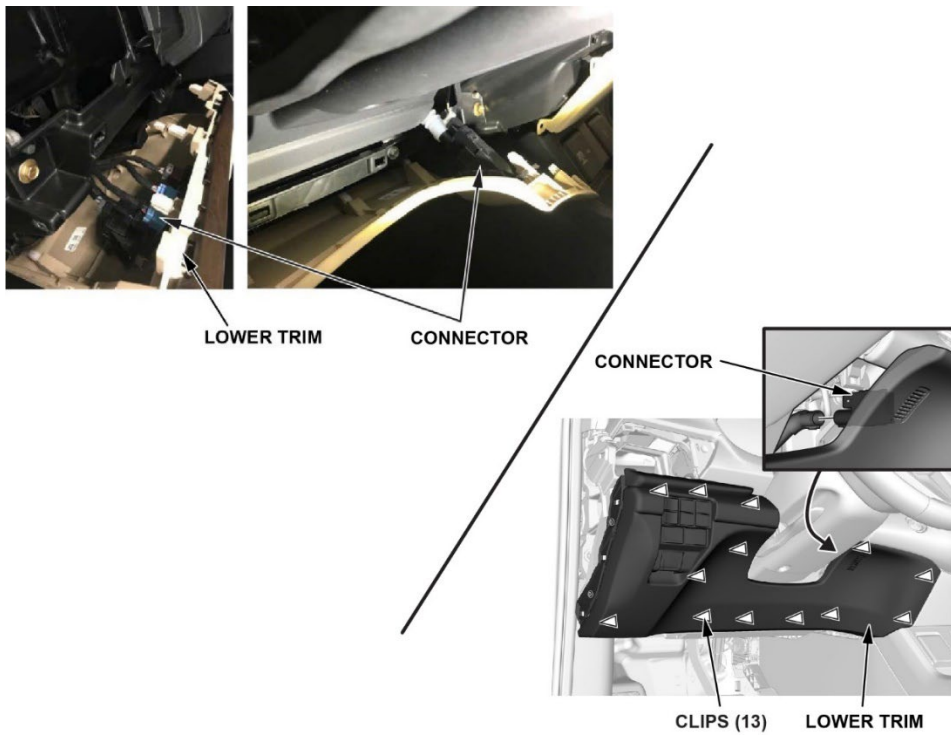

4. Remove driver's side wrapped trim.

*DRIVER'S SIDE*

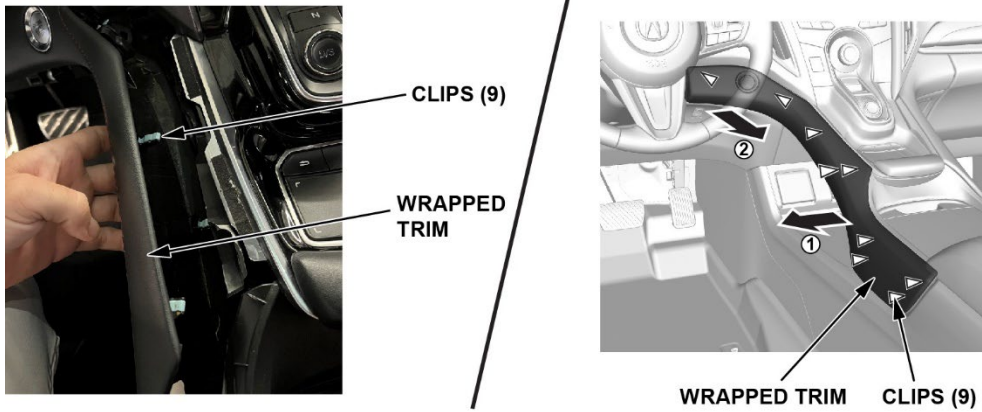



5. Remove the driver side center console panel.

**DRIVER'S SIDE**



**CENTER CONSOLE PANEL**

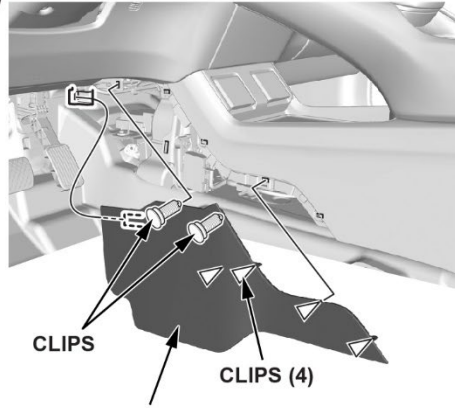

**CENTER CONSOLE PANEL**

6. Remove the lower center cover to expose the infotainment control unit.



**LOWER CENTER COVER**  
(infotainment control unit located behind)

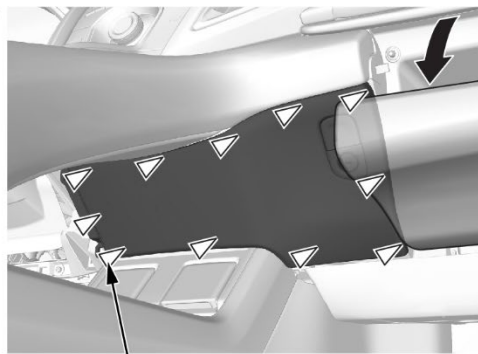

**CLIPS (11)**

7. Remove the passenger kick panel.



**KICK PANEL**

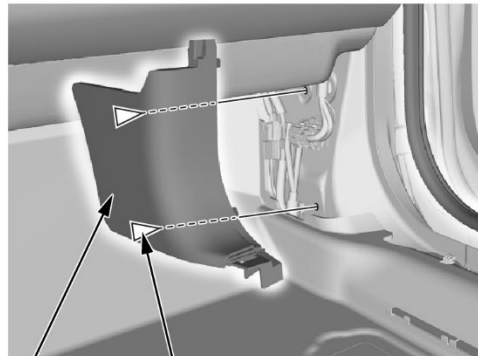

**KICK PANEL**      **CLIPS (2)**

8. Remove the passenger side center console cover.  
**PASSENGER'S SIDE**

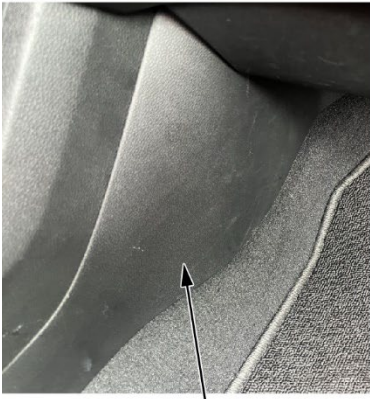

**CENTER CONSOLE COVER**

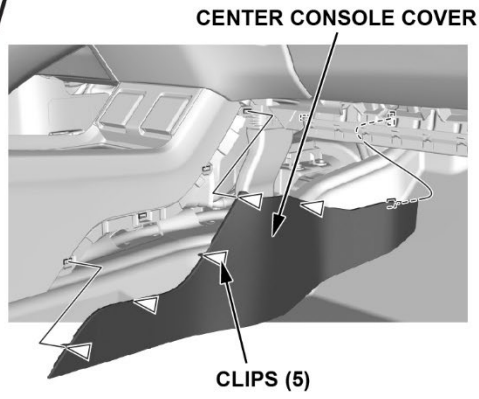

9. Remove the passenger side wrapped trim.  
NOTE: Lower the glove box for removal of trim.

**PASSENGER'S SIDE**



**PASSENGER WRAPPED TRIM**

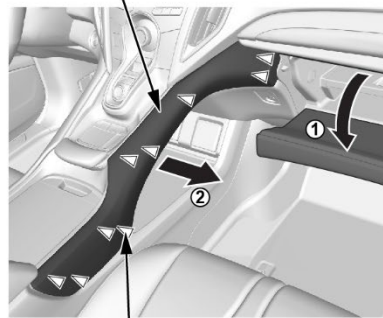

**CLIPS (9)**

10. Remove the center console rear panel.

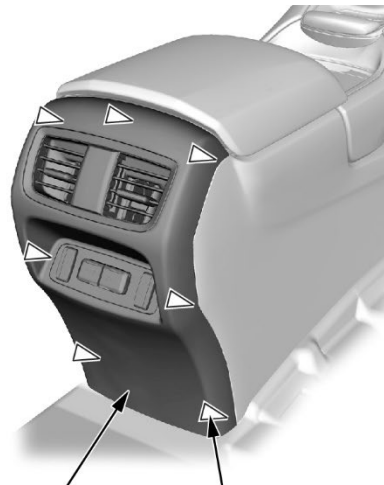

**CENTER CONSOLE REAR PANEL**

**CLIPS (7)**

11. Remove the center console.

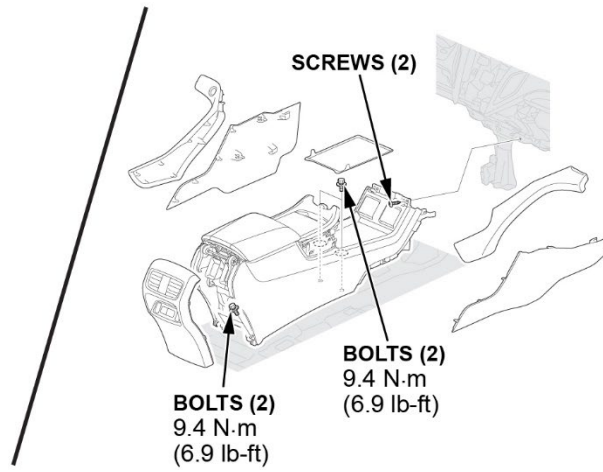

12. Remove the tie down hooks on both the passenger's and driver's side before you can remove the cargo bin.

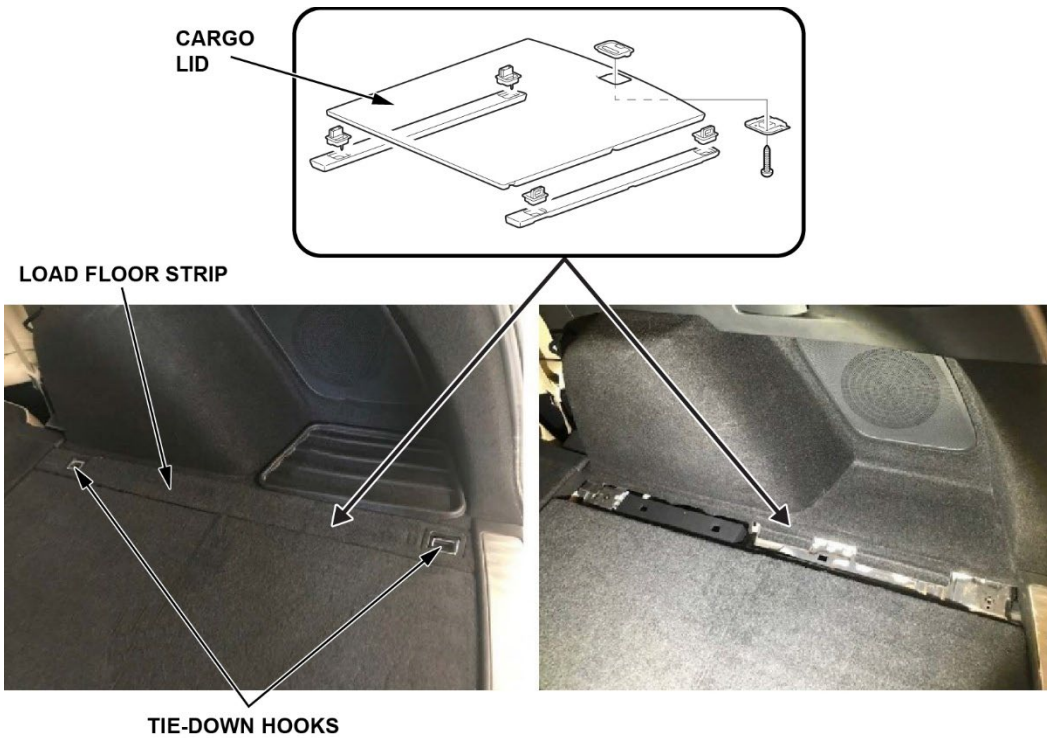

13. Remove the cargo floor lid, cargo bin, then the rear trim panel.



REAR PANEL TRIM    CARGO BIN

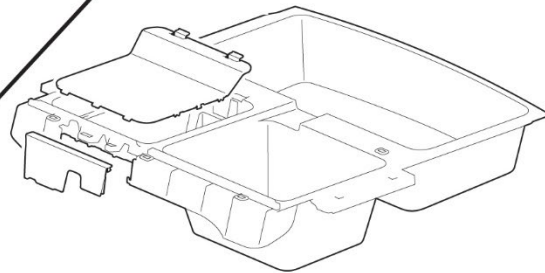

14. Remove the bolt from the rear seat cushion.

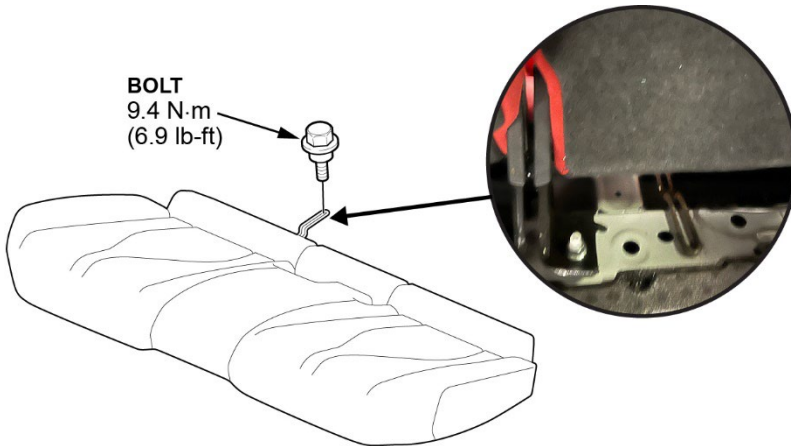

**BOLT**  
9.4 N·m  
(6.9 lb-ft)

15. Pull up the front edge of the seat cushion to slide the seat belt buckles from the slits in the seat cushion.

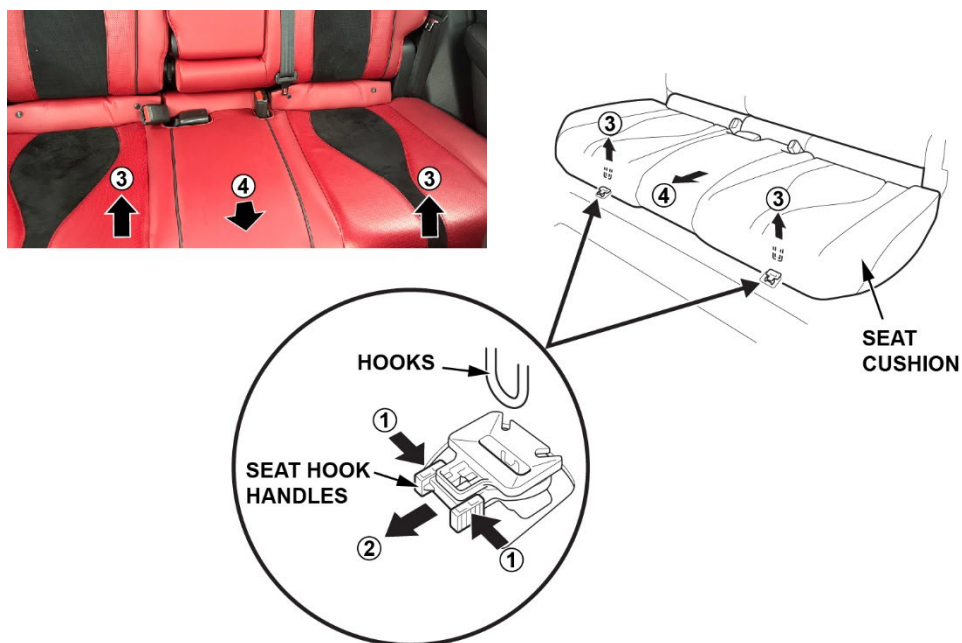

16. While pushing down on the rear seat cushion, pull the seat hook handles to release the hooks.

17. If rear seat heaters are present, disconnect the connectors.

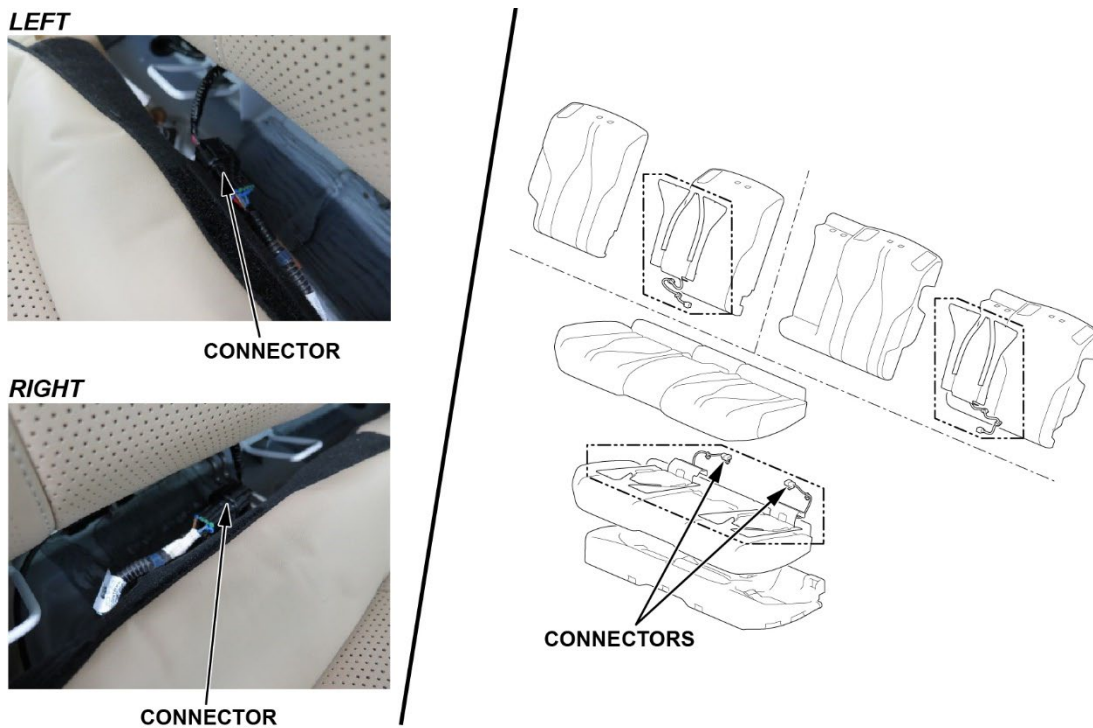

18. Remove the rear seat cushion.

19. Remove the lower trim.



**LOWER TRIM**



20. Remove the rear passenger seat hinge cover by lifting it up.



**SEAT HINGE COVER**  
Lift up.

21. Remove the inner handle cap from the rear lower side trim panel.



**INNER  
HANDLE  
CAP**

22. Remove the two screws.

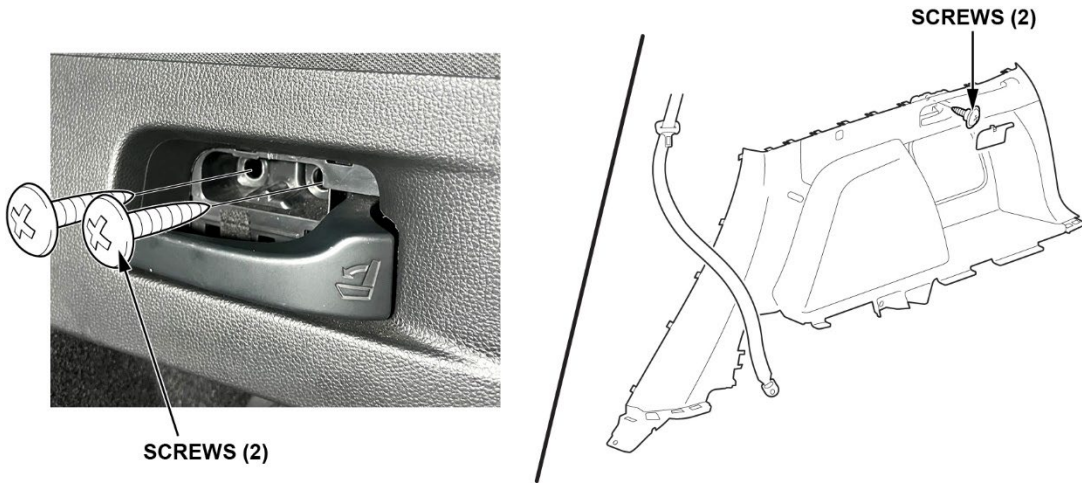

23. Pull back and remove the lower side trim panel.

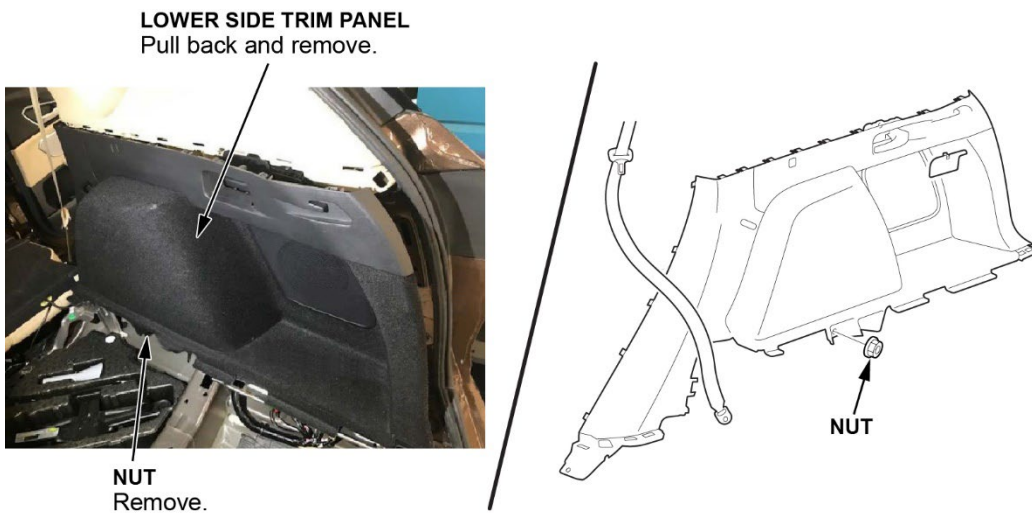

24. Using a rubber mallet, apply a **light strike** to disengage the quarter pillar trim clip (a must-replace part). Then, remove the quarter pillar trim. Once it is removed, install a new quarter pillar trim clip.

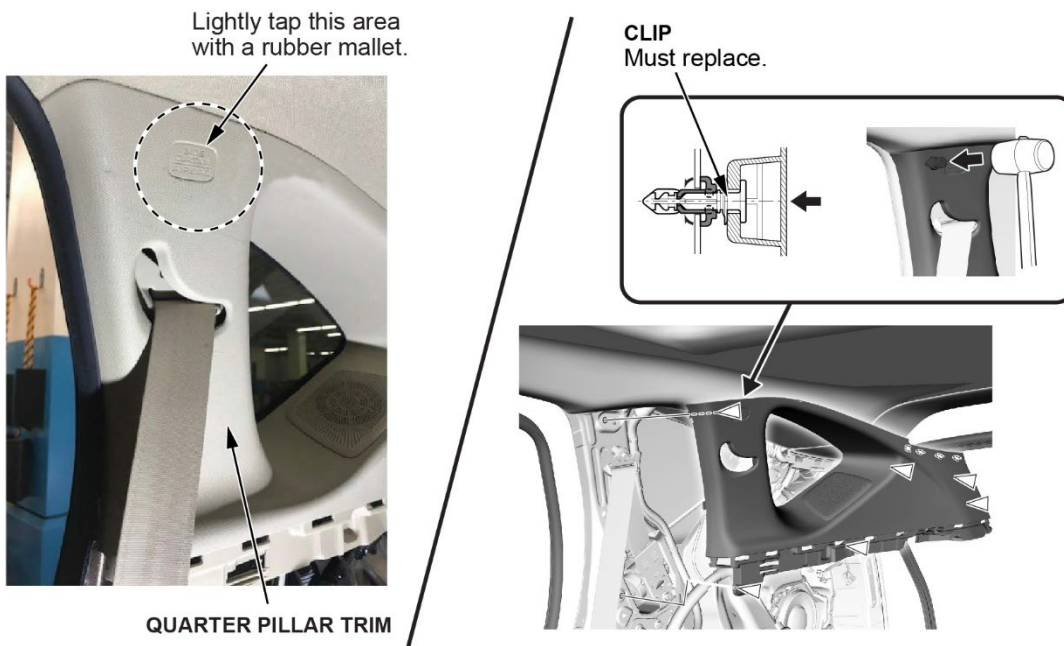

25. If a rear speaker is present, disconnect the rear speaker from the upper quarter pillar trim.



**SPEAKER CONNECTOR**  
Disconnect.

26. Follow the sections below to install the FAKRA splice repair service cables and splice boxes at **each** component location.

**NOTE:** See the **FAKRA CONNECTOR HOUSING DISASSEMBLY/FAKRA SPLICE REPAIR SERVICE CABLE ASSEMBLY PROCEDURE SECTION** above for cable and splice box installation instructions.



## RDX – INFOTAINMENT CONTROL UNIT REPAIR PROCEDURE

1. Disconnect the red and green FAKRA connectors and any other related connectors at the infotainment control unit and then remove the unit.

NOTE: Disassemble the connectors one at a time to avoid swapping the green and red wires.



INFOTAINMENT  
CONTROL UNIT

2. Install the matching color FAKRA splice repair service cables and splice boxes.

NOTE:

- See the above section **FAKRA CONNECTOR HOUSING DISASSEMBLY/FAKRA SPLICE REPAIR SERVICE CABLE ASSEMBLY PROCEDURE SECTION** for detailed instructions.
  - **The splice box arrow must always point in the direction of the red flag label or red sleeve on the FAKRA splice repair service cable.**
  - If any of the lock tabs break during installation, the splice box halve(s) must be replaced.
  - If the splice box is installed **incorrectly**, the repair **will fail**; MOST Ring failure conditions will still occur.
3. Reconnect the FAKRA connectors and any other related connectors to the infotainment control unit.
  4. Tape the FAKRA splice repair cables and both splice boxes to the infotainment control unit harness.

Keep smooth curves  
with radius bend  
greater than 25 mm.

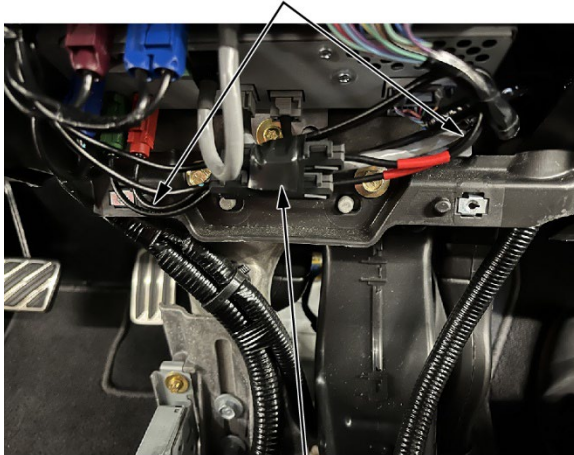

Attach the fakra service cables and splice boxes to the appropriate component harness with tape to prevent any rattles.

5. Reconnect the FAKRA connectors and any other related connectors to the infotainment control unit.

## RDX – CENTER CONSOLE IN-LINE CONNECTOR REPAIR PROCEDURE

1. Disconnect the blue FAKRA connector at the passenger side center console.

BLUE FAKRA  
CONNECTOR



2. Install the matching color FAKRA splice repair service cable and splice box.

NOTE:

- See the above section **FAKRA CONNECTOR HOUSING DISASSEMBLY/FAKRA SPLICE REPAIR SERVICE CABLE ASSEMBLY PROCEDURE SECTION** for detailed instructions.
  - **The splice box arrow must always point in the direction of the red flag label or red sleeve on the FAKRA splice repair service cable.**
  - If any of the lock tabs break during installation, the splice box half(s) must be replaced.
  - If the splice box is installed **incorrectly**, the repair **will fail**; MOST Ring failure conditions will still occur.
3. Tape the FAKRA splice repair cable and splice box to the in-line harness.

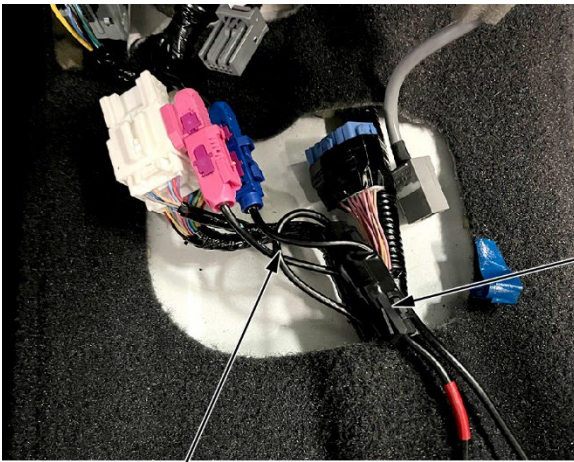

Attach the fakra splice repair  
service cables to the appropriate  
component harness with tape to  
prevent any rattles.

Keep smooth curves with a  
radius bend greater than 25 mm.

4. Reconnect the blue in-line FAKRA connector.

## RDX – PASSENGER KICK PANEL IN-LINE CONNECTOR REPAIR PROCEDURE

1. Disconnect the blue FAKRA connector at the passenger side kick panel.

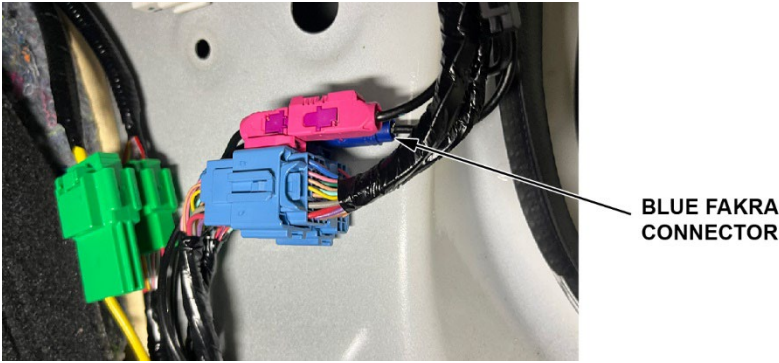

2. Install the matching color FAKRA splice repair service cable and splice box.

NOTE:

- See the above section **FAKRA CONNECTOR HOUSING DISASSEMBLY/FAKRA SPLICE REPAIR SERVICE CABLE ASSEMBLY PROCEDURE SECTION** for detailed instructions.
  - **The splice box arrow must always point in the direction of the red flag label or red sleeve on the FAKRA splice repair service cable.**
  - If any of the lock tabs break during installation, the splice box halve(s) must be replaced.
  - If the splice box is installed **incorrectly**, the repair **will fail**; MOST Ring failure conditions will still occur.
3. Tape the FAKRA splice repair cable and splice box to the in-line harness.

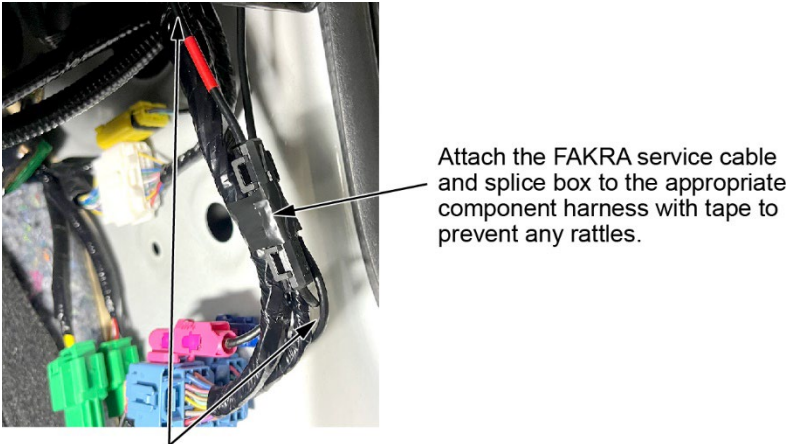

Keep smooth curves with a radius bend greater than 25 mm.

4. Reconnect the blue in-line FAKRA connector.

## RDX – TUNER UNIT REPAIR PROCEDURE

1. Disconnect the red and green FAKRA connectors at the tuner unit and then remove.

NOTE: Disassemble the connectors one at a time to avoid swapping green and red wires.

### FAKRA CONNECTORS

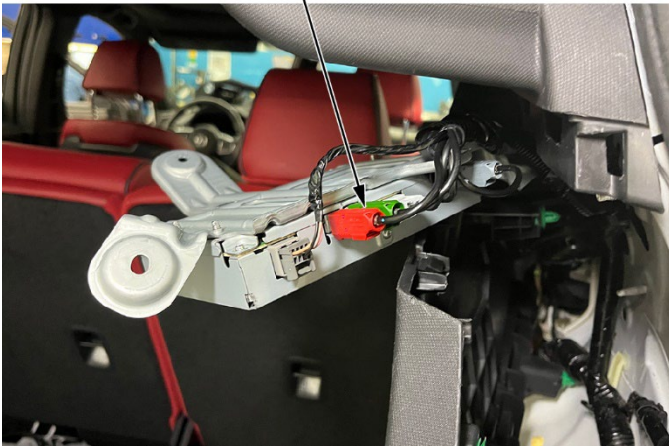

2. Install the matching color FAKRA splice repair service cables and splice boxes.

NOTE:

- See the above section **FAKRA CONNECTOR HOUSING DISASSEMBLY/FAKRA SPLICE REPAIR SERVICE CABLE ASSEMBLY PROCEDURE SECTION** for detailed instructions.
  - **The splice box arrow must always point in the direction of the red flag label or red sleeve on the FAKRA splice repair service cable.**
  - If any of the lock tabs break during installation, the splice box halve(s) must be replaced.
  - If the splice box is installed **incorrectly**, the repair **will fail**; MOST Ring failure conditions will still occur.
3. Tape the FAKRA splice repair cables and splice boxes to the tuner unit harness.

Keep smooth curves with a radius bend greater than 25 mm.



Attach the FAKRA service cables and splice boxes to the appropriate component harness with tape to prevent any rattles.

4. Reconnect the red and green FAKRA connectors at the stereo amplifier and then remove.

## RDX – STEREO AMPLIFIER REPAIR PROCEDURE

1. Disconnect the red and green FAKRA connectors at the stereo amplifier and then remove.

NOTE: Disassemble the connectors one at a time to avoid swapping the green and red wires.

### FAKRA CONNECTORS



2. Install the matching color FAKRA splice repair service cables and splice boxes.

NOTE:

- See the above section **FAKRA CONNECTOR HOUSING DISASSEMBLY/FAKRA SPLICE REPAIR SERVICE CABLE ASSEMBLY PROCEDURE SECTION** for detailed instructions.
  - **The splice box arrow must always point in the direction of the red flag label or red sleeve on the FAKRA splice repair service cable.**
  - If any of the lock tabs break during installation, the splice box half(s) must be replaced.
  - If the splice box is installed **incorrectly**, the repair **will fail**; MOST Ring failure conditions will still occur.
3. Tape the FAKRA splice repair cables and splice boxes to the stereo amplifier harness.

Attach the fakra splice repair service cables to the appropriate component harness with tape to prevent any rattles.

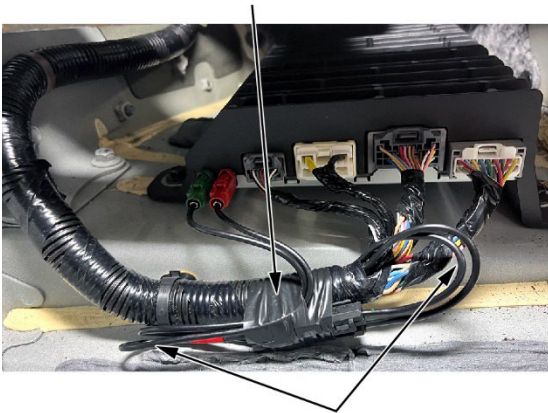

Keep smooth curves with a radius bend greater than 25 mm.

4. Reconnect the FAKRA connectors and any other related connectors to the stereo amplifier.

## RDX – FINISHING REPAIR PROCEDURE

1. Install all of the removed parts in the reverse order of removal.

### NOTE:

- When reinstalling components, make sure the harness is routed correctly. A **misrouted harness** can put pressure on the wires and connectors, causing connection issues.
  - **Do not pull** on the units or MOST cables while the FAKRA connectors are connected to help prevent communication issues.
2. Start the vehicle and verify the gauge control module and the infotainment control unit operates normally, then push the power button OFF. Open and close the driver's door and restart the vehicle. Reverify the gauge control module and the infotainment control unit operates normally. If all systems operate normally, repair is complete.
  3. If components do not operate as intended, reinspect FAKRA Splice repair service cables, splice box connections and routing. Make sure the splice box arrow is pointing to the red flag label or red sleeve on the FAKRA Splice box service cable.

**NOTE: If all FAKRA splice repair service cables, splice box connections, and routing are correct, follow normal troubleshooting procedures per System Information Search on iN.**

END