

Repair Flow Chart

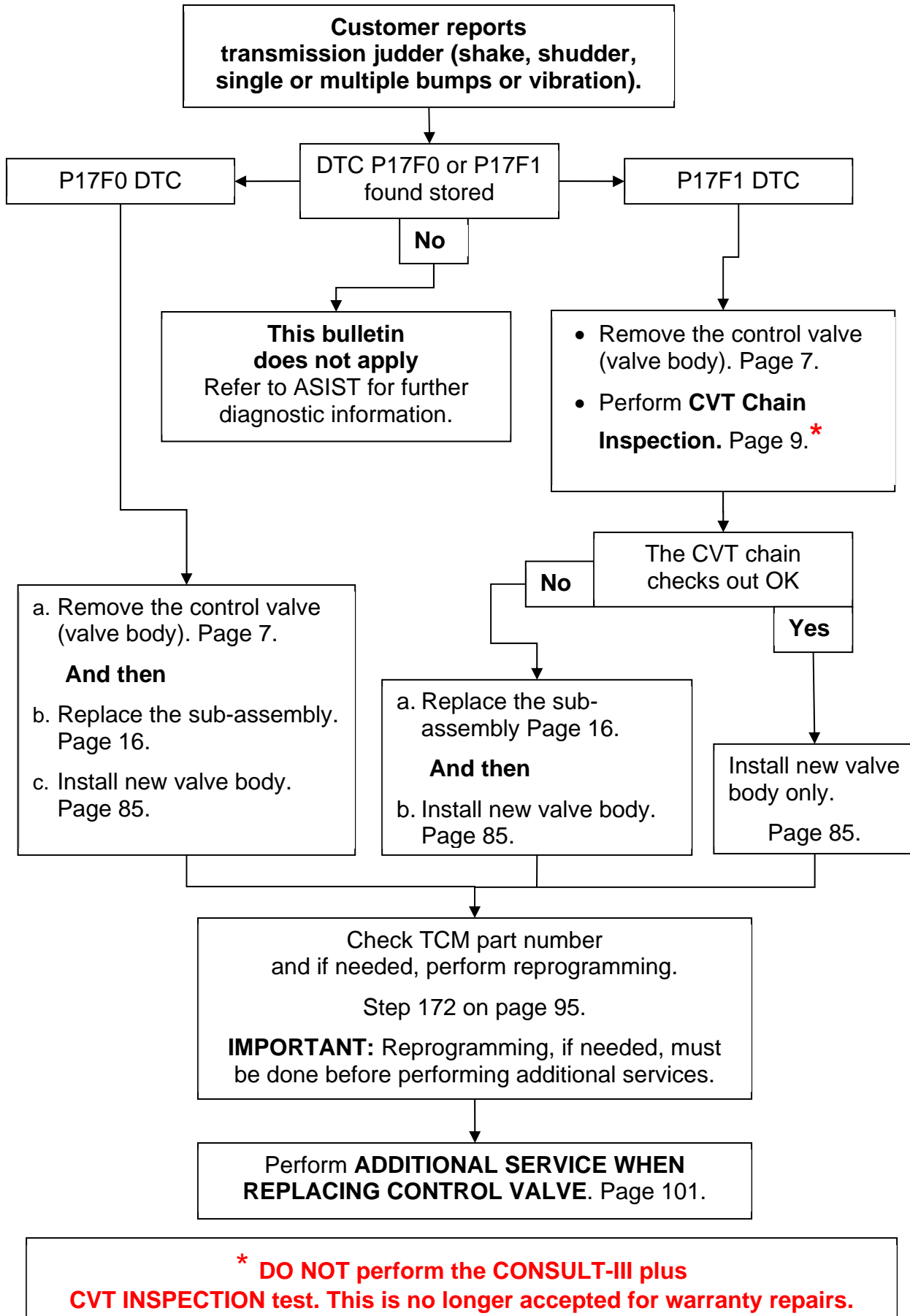

Table of Contents

• Required Tools / Materials.....	page 4
• Essential Tools.....	page 4
• Weights.....	page 5
• Precautions when Disassembling a CVT Assembly.....	page 6
• Control Valve (Valve Body) Removal	page 7
• CVT Chain Inspection.....	page 9
• CVT Assembly Removal.....	page 16
• Remove the Converter Housing, Oil Seals, Oil Pump Cover, Oil Pump and Oil Filter.....	page 19
• Verify Thrust Bearing Type 1 or Type 2.....	page 25
• Clean the CVT Case Surfaces.....	page 28
• Clean the Oil Passages in the CVT Case, Oil Pump Cover, and CVT Filter Area.....	page 29
• New Oil Pump Installation.....	page 31
• Replace the Side Cover – Pulleys and Chain (sub-assembly).....	page 33
• Remove Side Cover and Install Lubrication Caps.....	page 48
• Type 1 CVT: Clutch Total Endplay Adjustment – Thrust Bearing Selection...	page 62
• Type 2 CVT: Clutch Total Endplay Adjustment – Bearing Race Selection.....	page 67
• Clean the Torque Converter Housing, Dummy Cover Passages and Baffle Plates	page 75
• CVT Reassembly.....	page 77
• Control Valve (Valve Body) Strainer and Pan Installation.....	page 85
• Install the CVT Assembly.....	page 91
• TCM Reprogramming.....	page 93
• Troubleshooting.....	page 107
• PARTS INFORMATION	page 109
• Parts Kits Reference Table.....	page 113
• CLAIMS INFORMATION	page 114
• Type 1 and Type 2 Additional Reference Images.....	page 116

Required Tools / Materials

- Cherry picker / engine hoist / lifting arm (never handle replacement CVT sub-assembly by hand)
- Strap or chain to lift / lower CVT and sub-assembly
- Petroleum jelly or equivalent
- Extendable magnet
- Large clean surface / 1 to 2 work tables
- Vernier calipers
- Brake cleaner
- Rubbing alcohol
- Plastic scraper

Essential Tools

Additional Essential Tools are available from Tech•Mate online: <https://techmatetools.com/>, or by phone: 1-833-397-3493.

When ordering, keep in mind that the tool part number prefix has changed from “J” to “NI”. For example, J-52352 is now NI-52352.

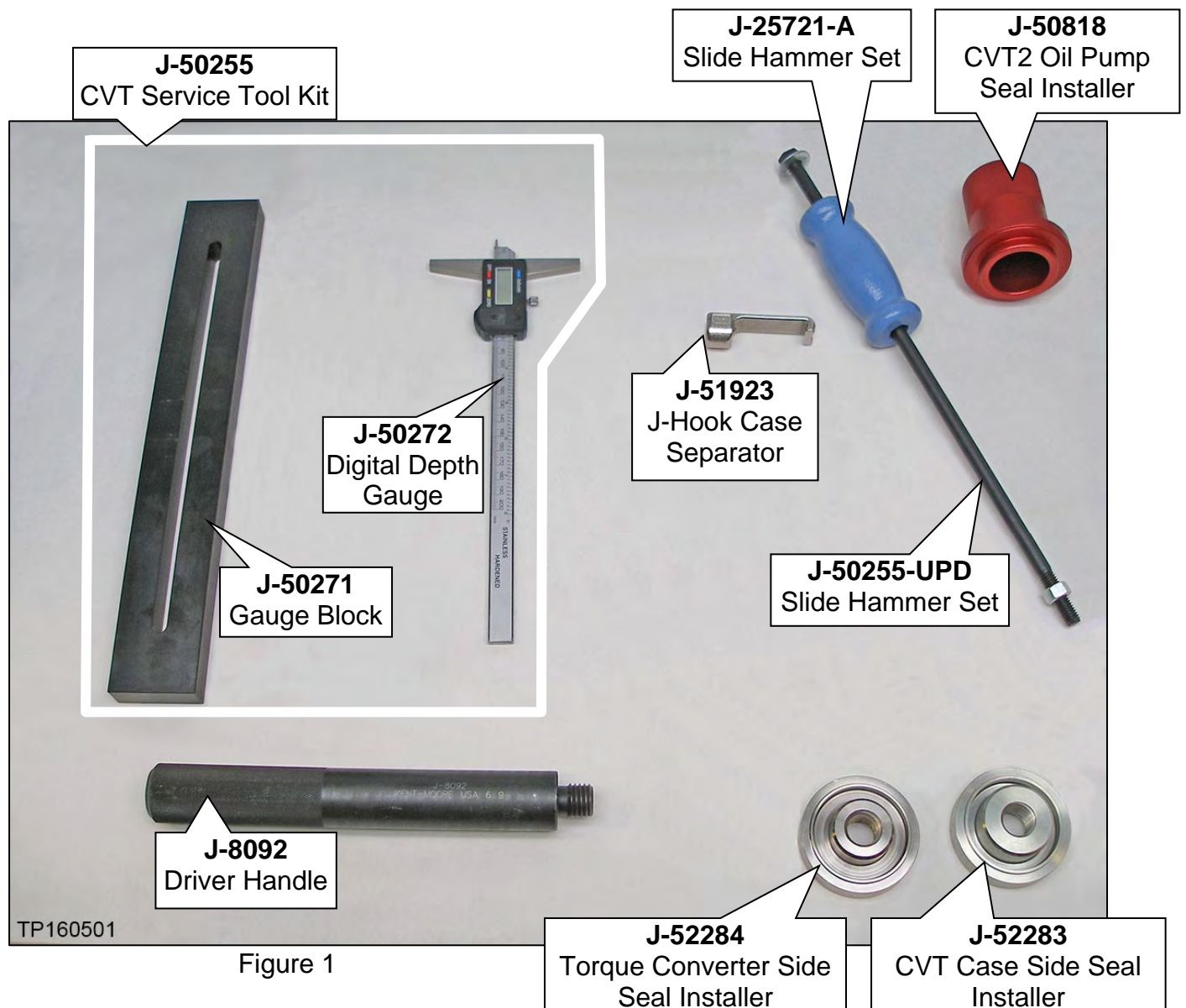

Essential Tools (continued)

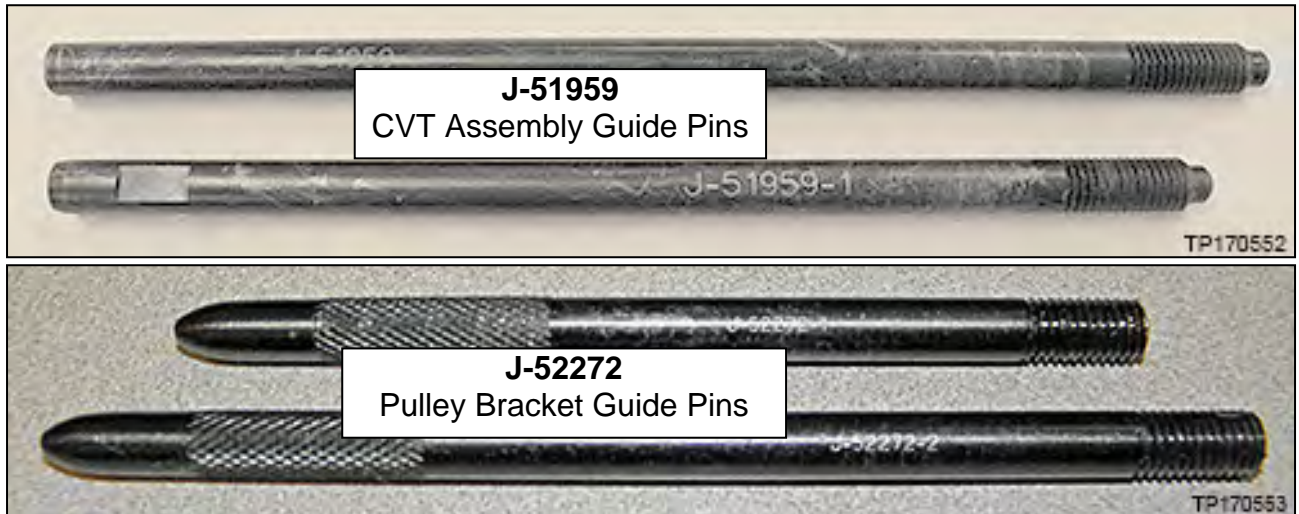

Figure 2

CVT Universal Lifting Fixture

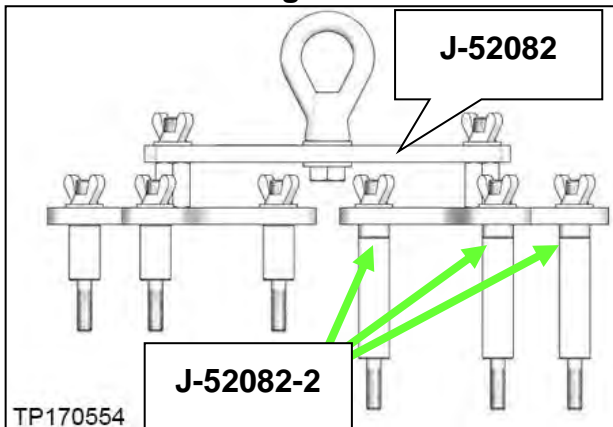

Figure 3

CVT Side Cover Alignment Aid

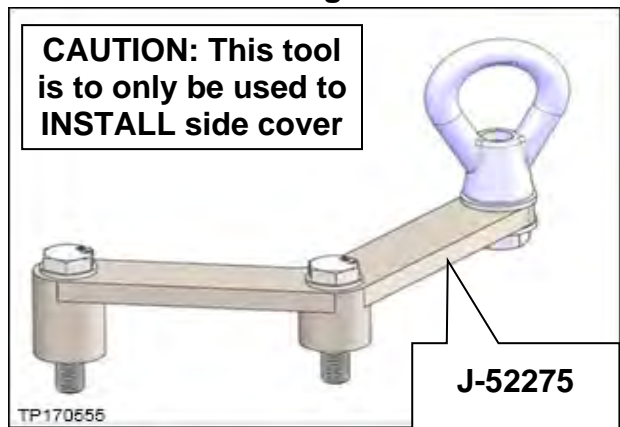

Figure 4

Tech Cam J-51951

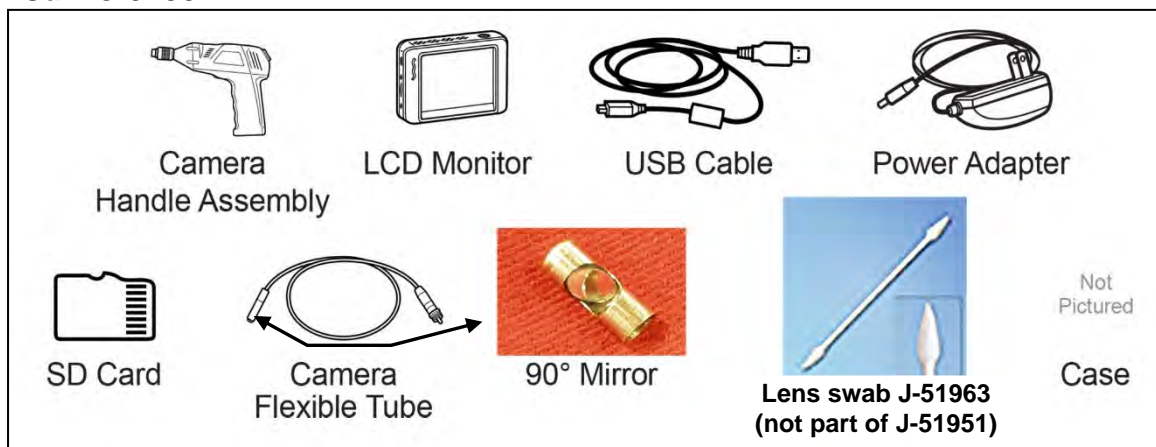

Figure 5

- Additional Tech Cam J-51951 kits or components are available from Tech•Mate.

Weights

- CVT assembly: 300 lbs. approximately
- CVT sub-assembly: 65 lbs. approximately

GENERAL INFORMATION

Precautions when Disassembling a CVT Assembly

Transmissions are vulnerable to particles (dust, metal, lint, etc.).

When disassembling a CVT, make sure your work environment (shop, workbench, etc.), transmission area (sub-frame, oil pan, harness connector, etc.), and your hands are free of contamination.

IMPORTANT:

- Wash and clean the exterior of the CVT assembly prior to disassembling.
CAUTION: Cover all air breather and drive shaft holes to prevent water intrusion.
- Refrigerating oil seals may help in assembly (axle and T/C seals).
- Only disassemble those parts which are mentioned in this bulletin.
- Make sure all parts are clean prior to assembling / installing.
- Apply rust penetrant to locator / dowel pins on torque converter housing and side cover of CVT and allow to soak as needed (Figure 6).

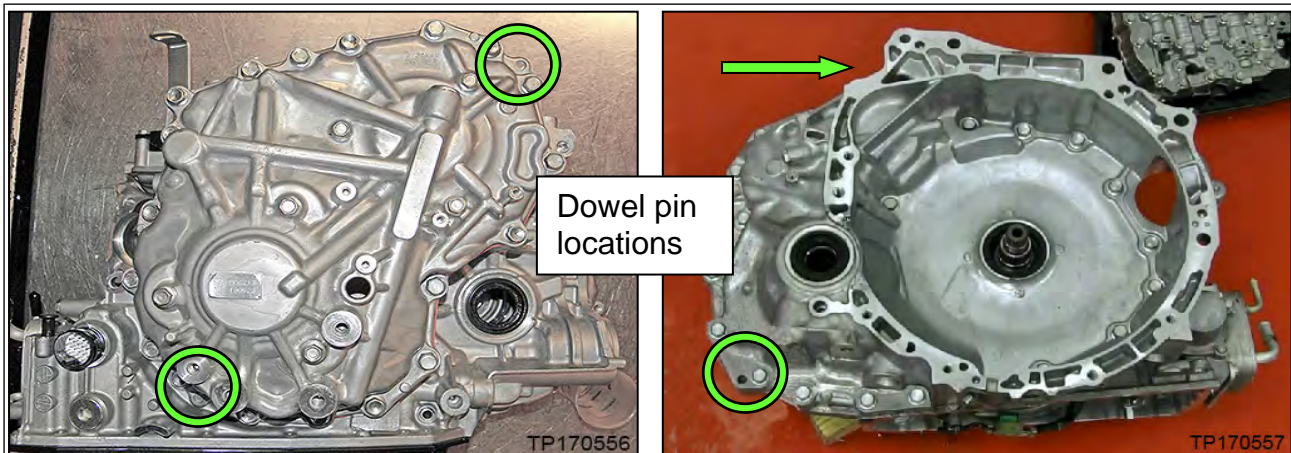

Figure 6

- Unpack service parts just before installation.
- To aid with organization, store related parts that have been removed separately.

IMPORTANT: The CVT unit “wiring harness connector” will be reused during this procedure. The wiring harness can be disconnected from the valve body at the wiring harness connector and remain in the CVT.

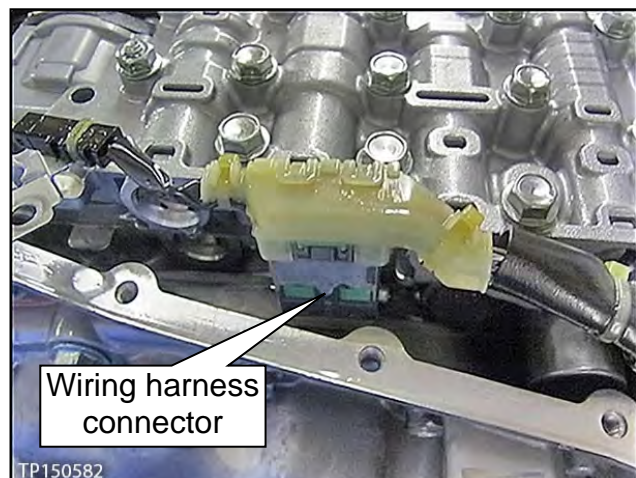

Figure 7

SERVICE PROCEDURE

Control Valve (Valve Body) Removal

1. Write down all radio station presets.

Presets	1	2	3	4	5	6
AM						
FM 1						
FM 2						
SAT 1						
SAT 2/3						
Bass	Treble	Balance	Fade	Speed	Sen.	Vol.

2. Disconnect both battery cables, negative cable first.
3. Was DTC P17F0 found stored?
 - **NO:** Proceed to step 4.
 - **YES:**
 - a. Remove the CVT from the vehicle, place it on a workbench and then remove the valve body.

➤ Refer to the Electronic Service Manual (ESM), section **TM-Transaxle & Transmission** for removal information.

HINT: The number “7” is on the head of all bolts that need to be removed for valve body removal. Do not remove any bolt that does not have the number “7”.

NOTICE For **AWD Vehicles** use extreme care when moving the axle in and out of the transfer assembly to avoid seal damage.

- b. Position the CVT on the workbench with the oil pan side down.

IMPORTANT: Do not hit the manual shaft while flipping the CVT; the manual shaft protrudes past the CVT case. Use a plastic / wooden block to support as needed.

- c. Proceed to step 14 on page 18.

4. Remove the valve body.
 - Before lifting the vehicle place the transmission gear selector in Neutral.
 - Refer to the appropriate ESM, section **TM – Transaxle & Transmission**, for valve body removal.

HINT: The number “7” is on the head of all bolts that need to be removed for valve body removal. Do not remove any bolt that does not have the number “7”.

NOTICE Never allow any chemicals or fluids other than NS-3 CVT fluid or equivalent to enter the CVT assembly. Never allow any foreign debris, dust, dirt, etc. to enter the CVT assembly.

For additional information, see video # 546: “CVT Chain Inspection”. This video is located under the TECH TRAINING GARAGE VIDEOS tab in Virtual Academy.

Exploded View

Example: Exploded View of Control Valve (valve body)

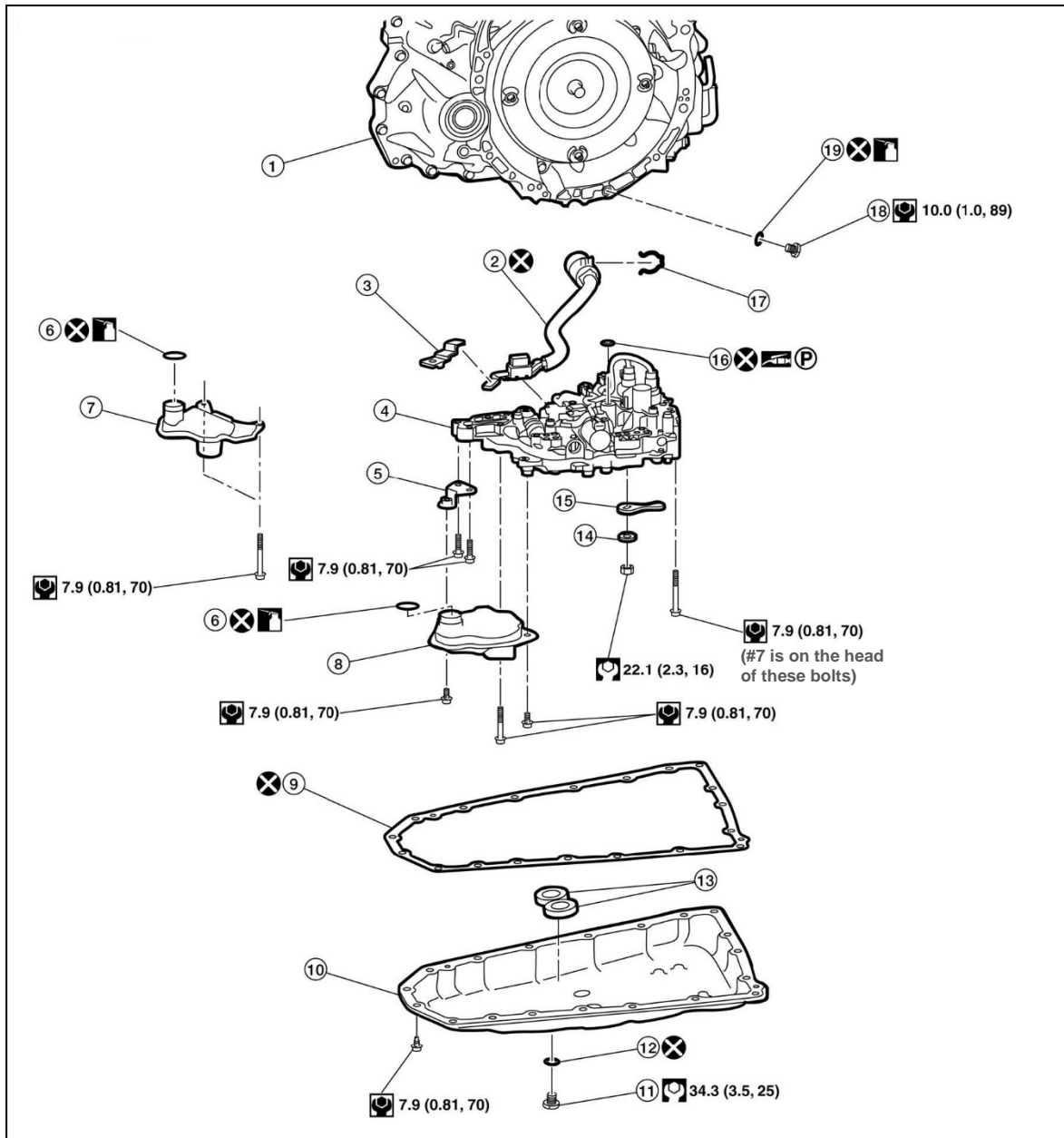





Figure 8

- | | | |
|------------------------------------|------------------------------------|---|
| 1. Transaxle assembly | 2. Terminal cord assembly | 3. CVT fluid temperature sensor bracket |
| 4. Control valve | 5. Bracket | 6. O-ring |
| 7. New-style oil strainer assembly | 8. Old-style oil strainer assembly | 9. Oil pan gasket |
| 10. Oil pan | 11. Drain plug | 12. Drain plug gasket |
| 13. Magnet | 14. Spring washer | 15. Manual plate |
| 16. Lip seal | 17. Snap ring | 18. Overflow plug |
| 19. O-ring : CVT fluid | | |

-  : Always replace after every disassembly.
-  : N·m (kg-m, ft-lb)
-  : N·m (kg-m, in-lb)

CVT Chain Inspection

5. Secure the right front tire with a suitable strap.
6. Mark the left front tire with a suitable marking.
 - This will assure all 360° of the chain is inspected.
7. Using borescope J-51951 with mirror attachment, visually inspect the entirety of the two sides of the chain that come in contact with the pulleys:

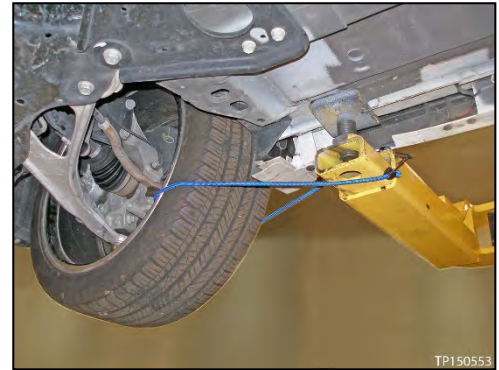

Figure 9

- a. First inspect the entirety (360°) of the driver side of the chain that comes in contact with the pulley (see page 11, Figure 13 and Figure 14, and page 12 Figure 15).
- b. If the inspection result is OK on all 360°, inspect all 360° of the passenger side of the chain.

IMPORTANT:

- Reference the pictures on pages 13-15 for chain image comparison.
- Be sure to remove the protective film from the mirror before the first use.
- Clean the camera lens and mirror before each inspection. Use 90% isopropyl alcohol, and a lens swab from the Lens Swab packet J-51963 listed in **PARTS INFORMATION**.
- Before inspecting, make sure the camera handle's AA batteries are fresh and the LCD monitor's battery is charged.
- Insert the camera lens behind the pulley between the guide rail and the pulley where shown in Figure 10 (also see pages 10-11, Figure 11-Figure 14).
- Insert the lens approximately 8-9 inches, and then view the side of the chain that contacts the pulley.
- Refer to Garage Video #546 if needed for Borescope inspection.

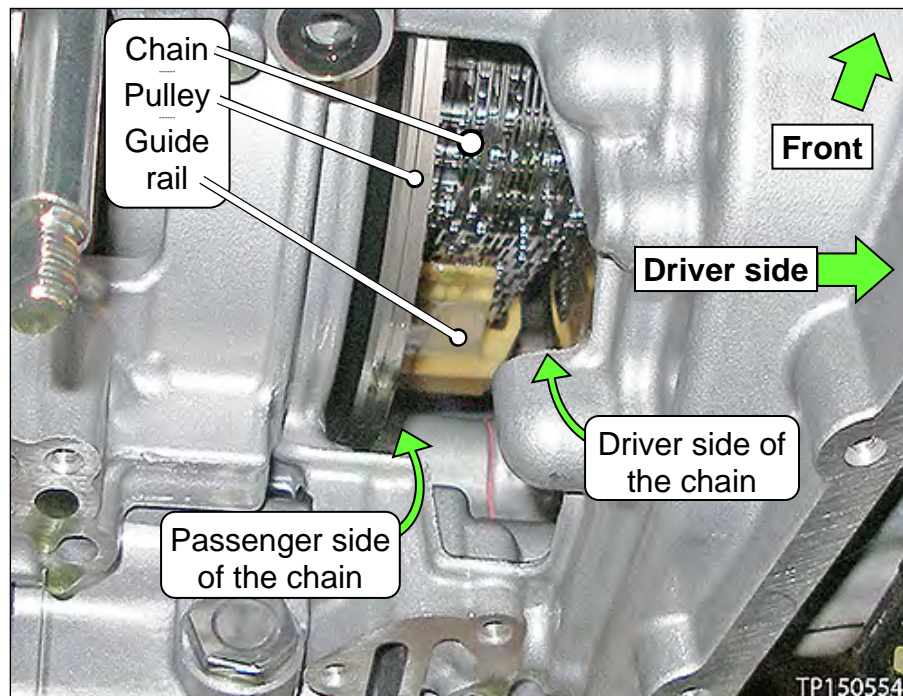

Figure 10

- Figure 11 shows where to insert the camera lens on the driver side of the chain.

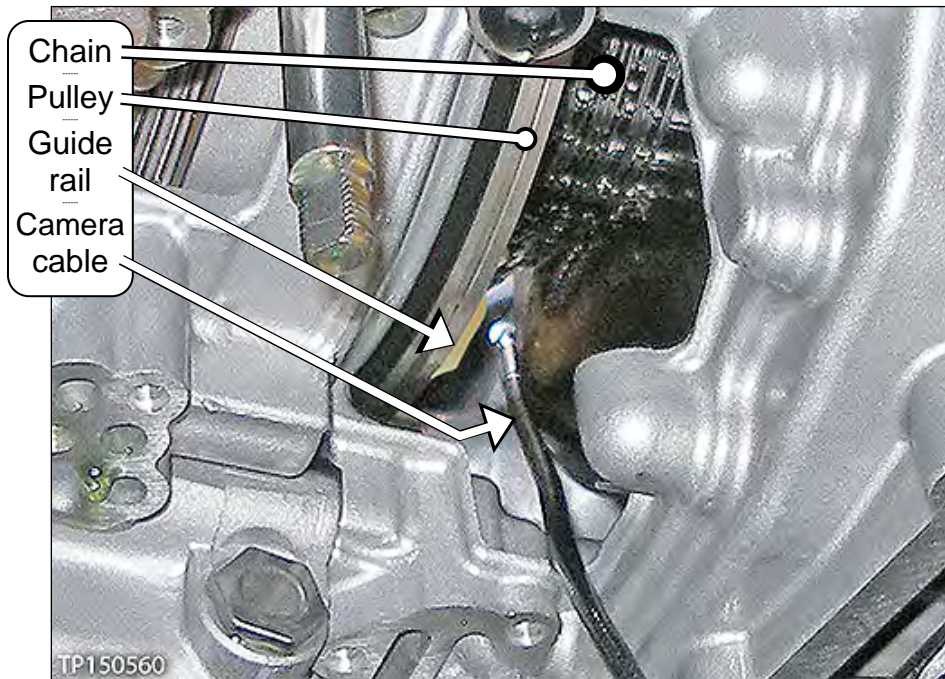

Figure 11

- Figure 12 shows where to insert the camera lens on the passenger side of the chain.

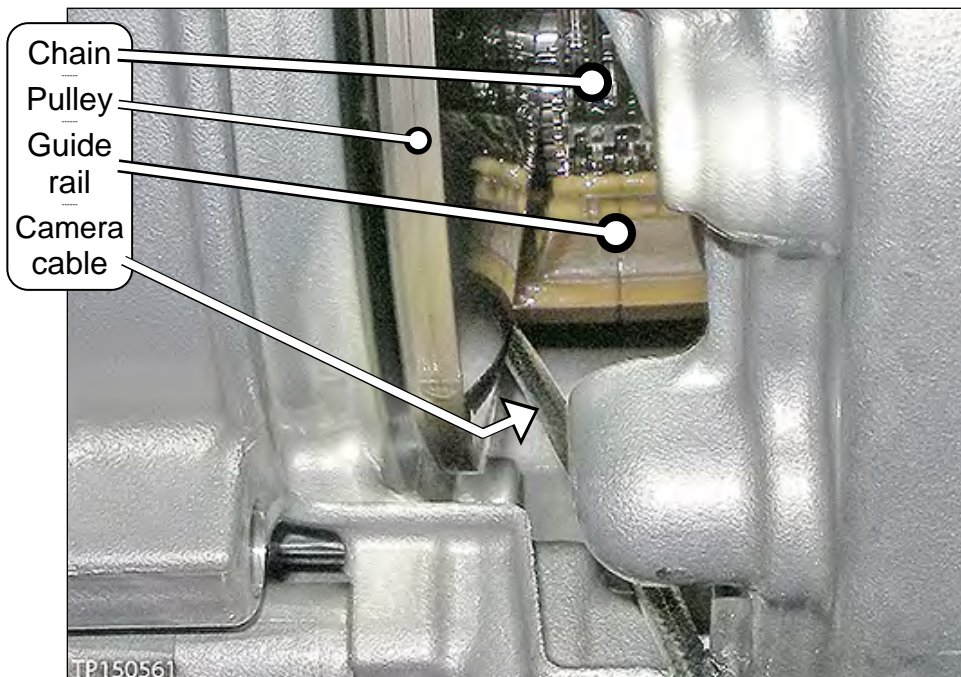

Figure 12

- Figure 13 and Figure 14 shows the routing and location of the camera.

HINT: The CVT's side cover was removed for easier viewing of camera location. **The side cover is not to be removed during borescope inspection.**

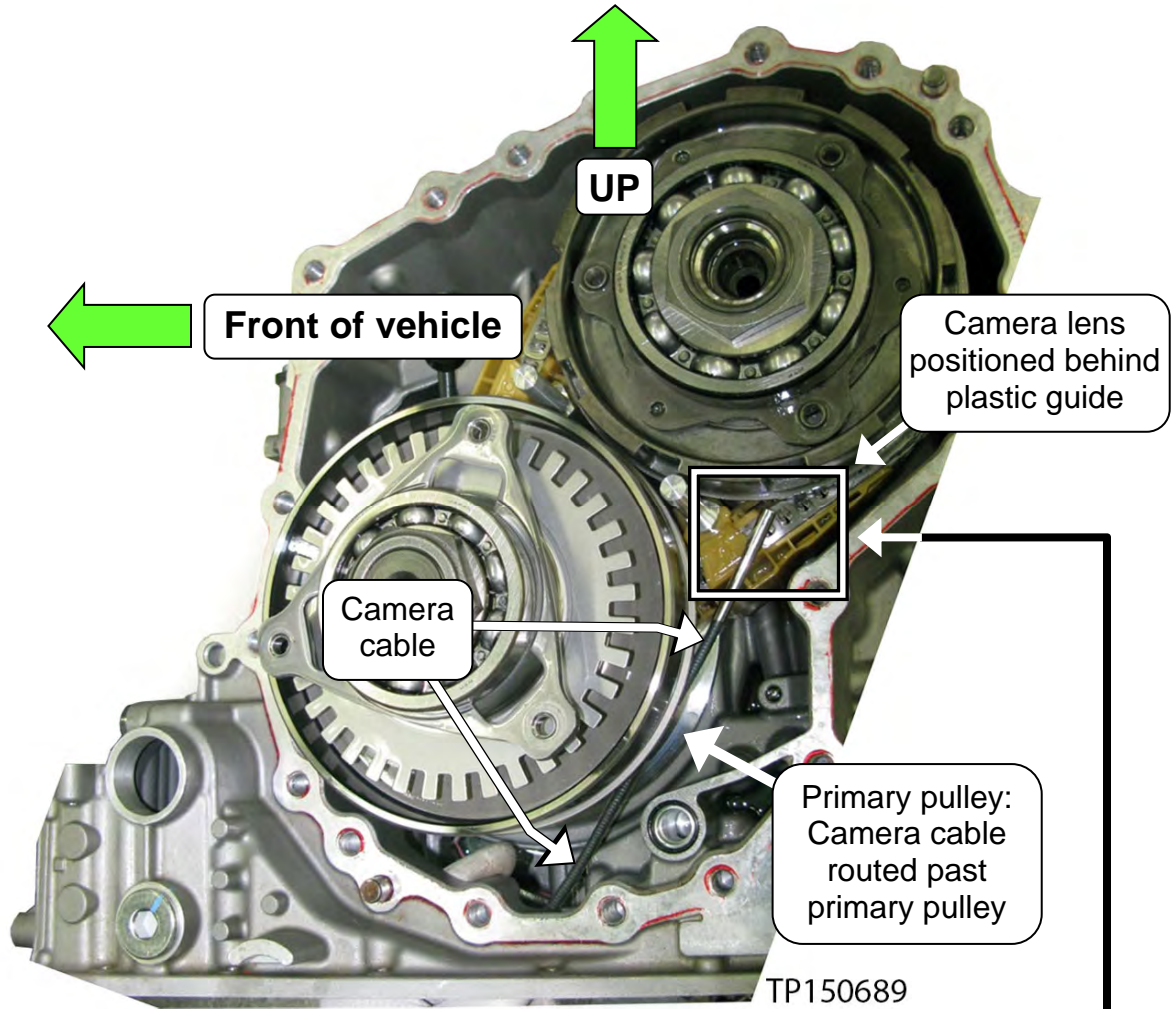

Figure 13

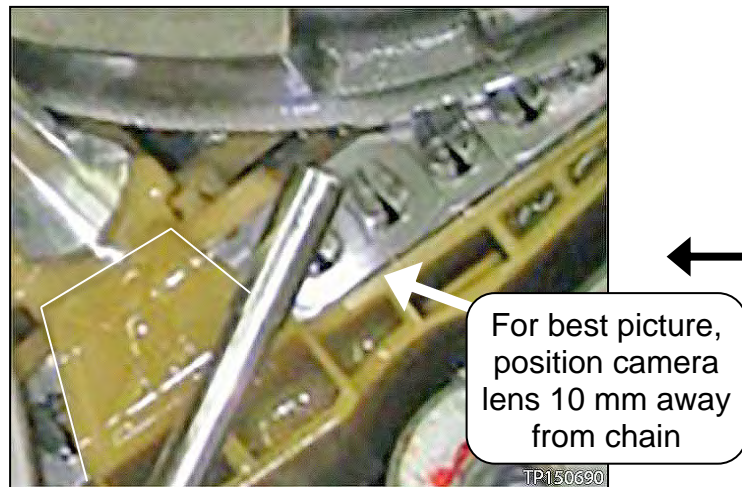

Figure 14

7c. Slowly and carefully turn the left front tire one full turn in the forward rotation to view all of the chain.

- Holding the borescope with one hand allows for turning the tire with the other hand (see Figure 15).

NOTICE If the tire is rotated in the rearward rotation, the camera lens may get caught between the chain and pulley.



Figure 15

d. Is the chain OK on all 360° of both surfaces?

- Refer to Garage Video #546 if needed (see page 7).

YES: Proceed to step 8.

NO: If the chain inspection result is NG, proceed to CVT Assembly Removal on page 16.

NOTICE

To avoid damage to the transaxle, **a cooler flush is required** after a valve body or CVT assembly replacement.

8. Flush the CVT cooler(s). For the procedure to flush the CVT cooler, refer to the ESM:

- For 2013-2014 Altima and 2013-2014 Pathfinder, refer to: **TRANSMISSION & DRIVELINE > TRANSAXLE & TRANSMISSION > CVT: RE0F10E > BASIC INSPECTION > CVT FLUID COOLER SYSTEM > CVT COOLER FLUSH**
- For 2015-2018 Altima and 2016-2022 Maxima, refer to: **TRANSMISSION & DRIVELINE > TRANSAXLE & TRANSMISSION > CVT: RE0F10H > BASIC INSPECTION > CVT FLUID COOLER SYSTEM > CVT COOLER FLUSH / CVT Fluid Cooler Flush**
- For 2015-2022 Murano, 2015-2020 Pathfinder, and 2015-2017 Quest, refer to: **TRANSMISSION & DRIVELINE > TRANSAXLE & TRANSMISSION > CVT: RE0F10E > BASIC INSPECTION > CVT FLUID COOLER SYSTEM > CVT COOLER FLUSH / CVT Fluid Cooler Flush**

OR

TRANSMISSION & DRIVELINE > TRANSAXLE & TRANSMISSION > CVT: RE0F10J > BASIC INSPECTION > CVT FLUID COOLER SYSTEM > CVT COOLER FLUSH / CVT Fluid Cooler Flush

9. Replace the valve body.
- For valve body replacement, go to page 85, **Control Valve (Valve Body) Strainer and Pan Installation.**

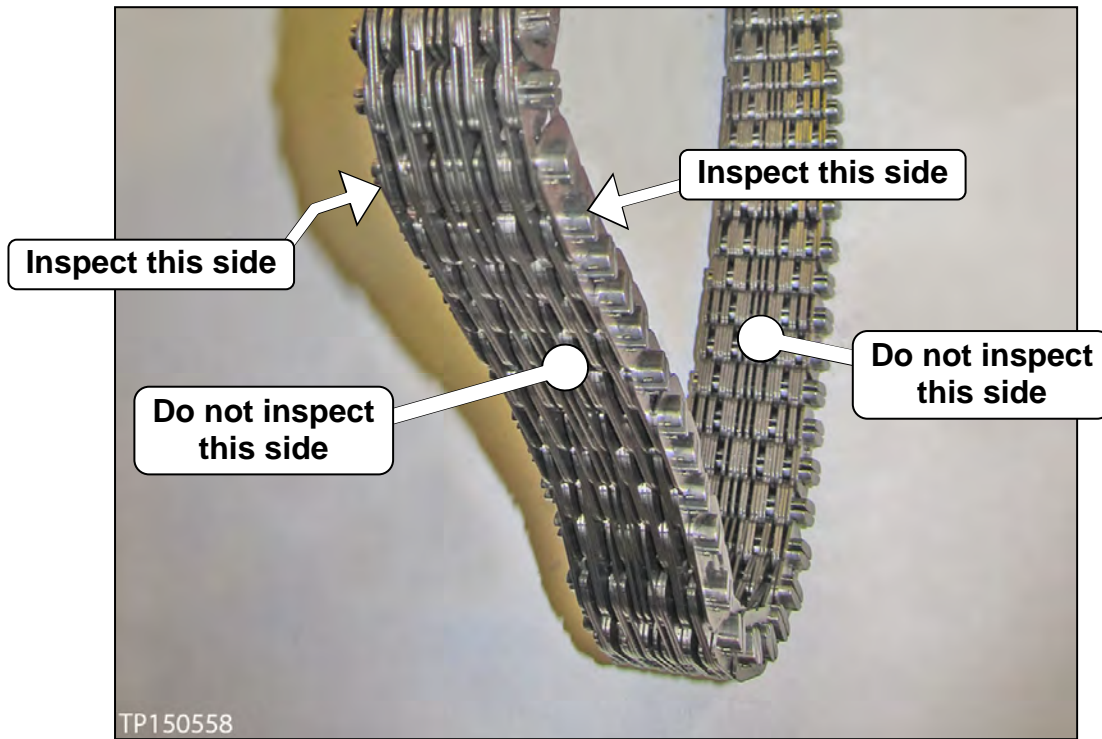

Figure 16



Figure 17

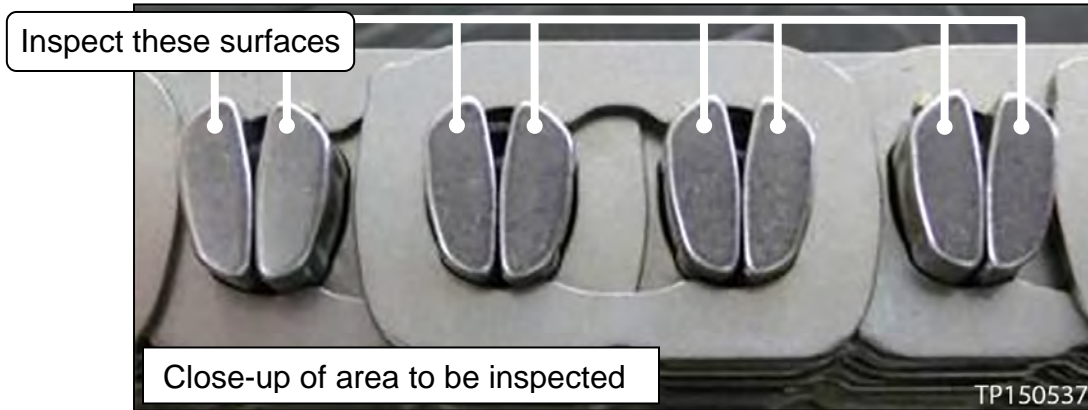

Figure 18

Pictures in Figure 19 and Figure 20 were taken with borescope J-51951.



Figure 19

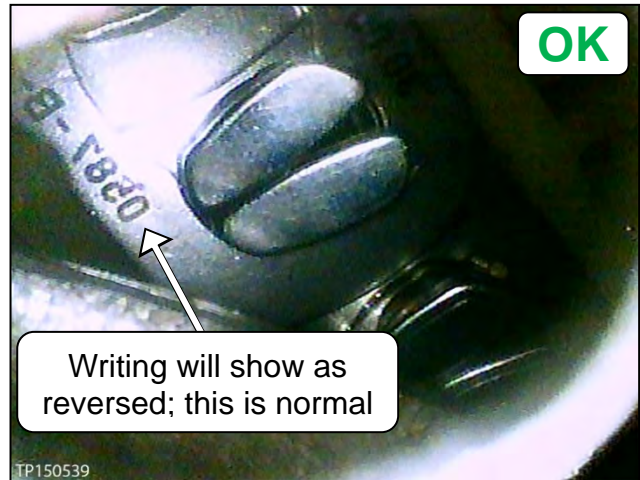

Figure 20



Figure 21



Figure 22

Pictures in Figure 23 and Figure 24 were taken with borescope J-51951.

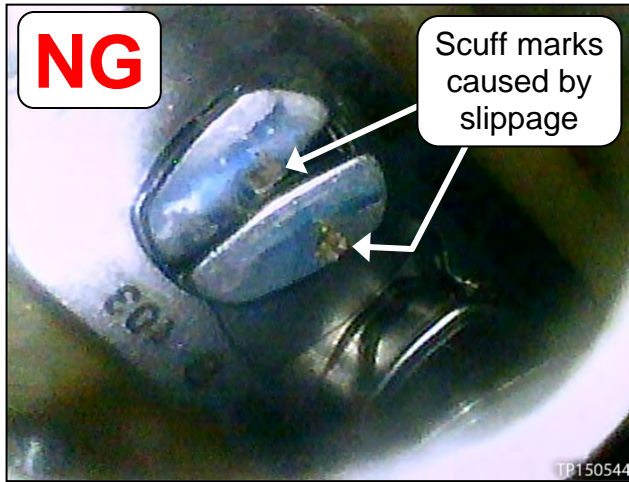

Figure 23

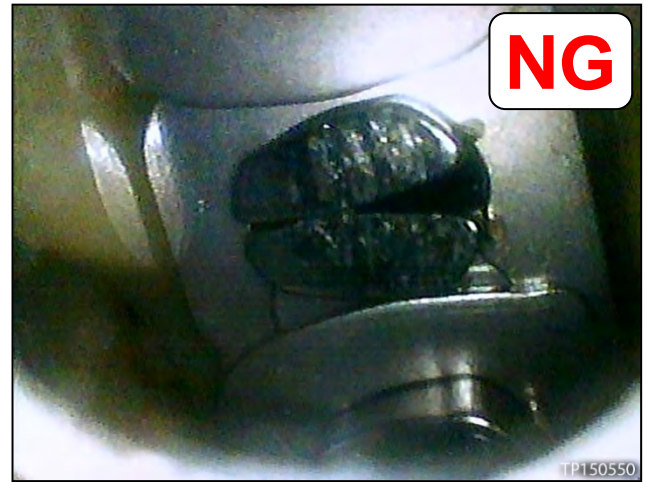

Figure 24



Figure 25



Figure 26

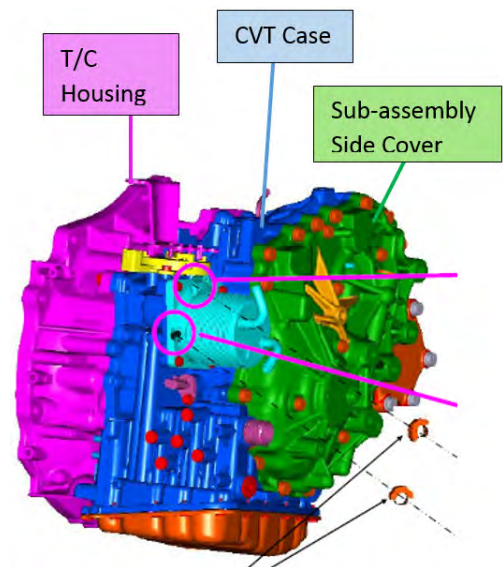

Figure 27

CVT Assembly Removal

Overview of Sub-assembly Repair

1. Precautions When Disassembling a CVT Assembly
2. Remove the CVT
3. Apply rust penetrant to dowel pins
4. Remove Converter Housing, Oil Seals, Oil Pump Cover, Oil Pump, Oil Filter
5. Confirm Thrust Bearing Type
6. Clean the CVT Case Surfaces
7. Clean Oil Passages in CVT Case, Oil Pump Cover, and CVT Filter Area
8. Install New Oil Pump
9. Temporarily Install Dummy cover, Torque Converter Housing and Filter Cover
10. Check Pulley Movement Characteristics
11. Install Sub-assembly – Pulley, Chain and Side Cover
12. Remove Side Cover and Install Lubrication Caps
13. Apply Sealant, Install Side Cover and Bracket Bolts
14. Confirm Parking Rod Operation
15. Check New Pulley Movement Characteristics
16. Torque Bracket Bolts
17. Adjust Total Thrust Bearing End-play
18. Clean Torque Converter Housing, Dummy Cover and Baffle Plates
19. CVT Reassembly
20. Install Valve Body, Strainer, and Pan
21. Install CVT Assembly



Remove the CVT

10. Temporarily install the oil pan gasket and oil pan with four oil pan bolts to corners of the oil pan, hand tight (Figure 28).

HINT: A new valve body will be installed later in this procedure.

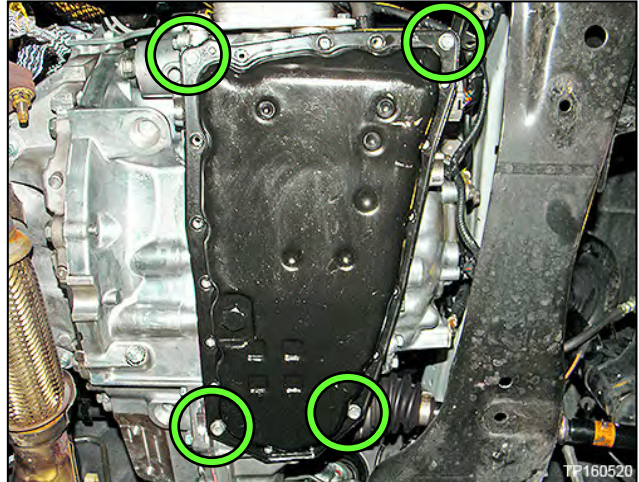

Figure 28

11. Remove the CVT from the vehicle.
 - Refer to the ESM, section **TM-Transaxle & Transmission**, or any applicable TSBs for removal information.

AWD Vehicles

IMPORTANT:

- Use extreme care when moving the axle in and out of the transfer assembly.
- To avoid seal damage or deformation, properly support and guide the axle.

12. Place the CVT on a workbench with the oil pan side down.

- Use wood or plastic blocks to keep the CVT steady.

IMPORTANT: Do not deform the oil Pan.

13. Remove the torque converter.

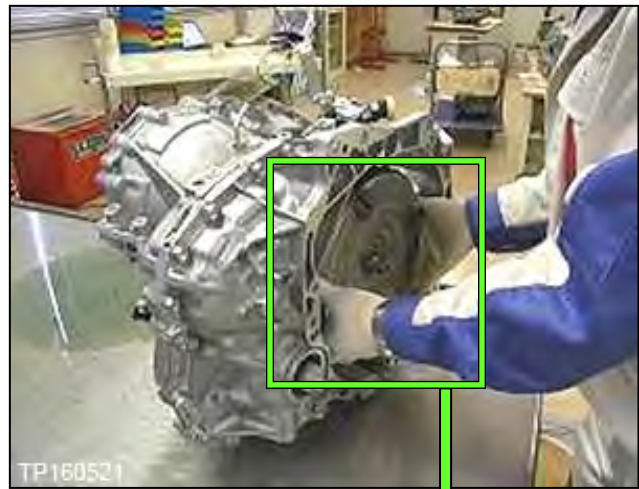

Figure 29

14. Drain CVT fluid out of the torque converter.



Figure 30

15. Remove the primary speed sensor.

IMPORTANT: The speed sensor will be reused.

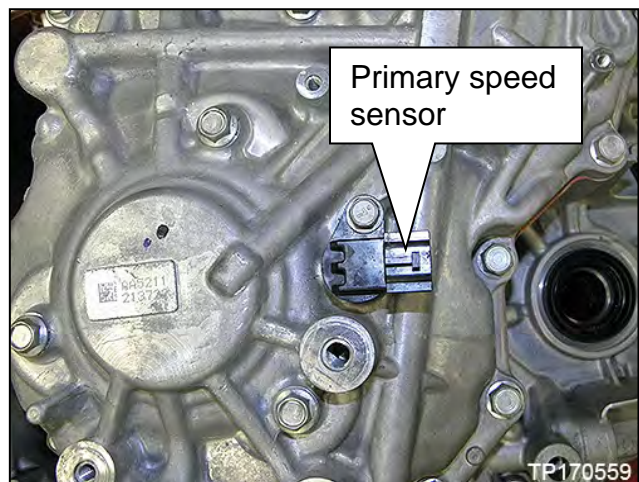

Figure 31

Remove the Converter Housing, Oil Seals, Oil Pump Cover, Oil Pump and Oil Filter

16. Remove all 24 converter housing mounting bolts (Figure 32).

HINT:

- These bolts will be replaced with new ones and will not be reused.
- Apply rust remover to the dowel pins if needed.

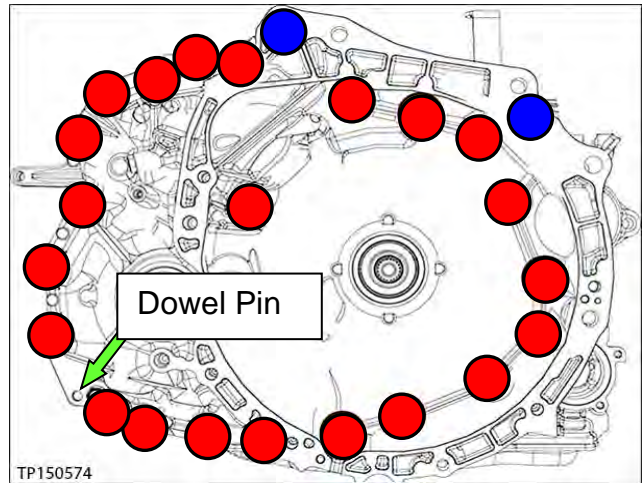

Figure 32

17. Separate and then remove the converter housing from the CVT case.

- Use Slide Hammer J-25721-A and Slide Hammer Bolt J-50255-UPD with J-Hook J-51923 at the cut out areas similar to the one shown in Figure 33 and Figure 34.
- Work around the CVT at specified areas, repeatedly until case halves separate.

IMPORTANT: DO NOT use a pry-bar, chisel, etc. to separate the side cover from the CVT case.

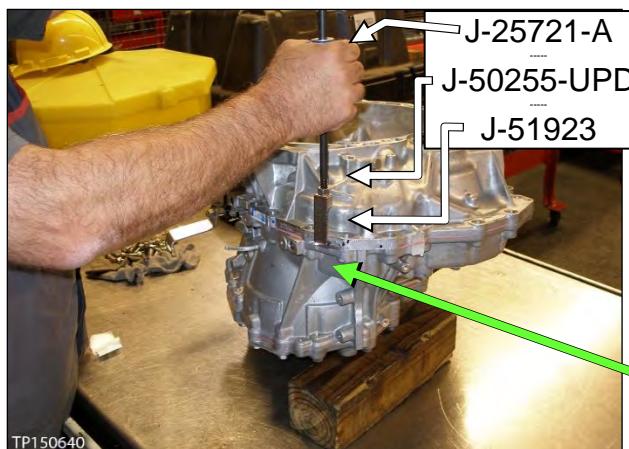

Figure 33

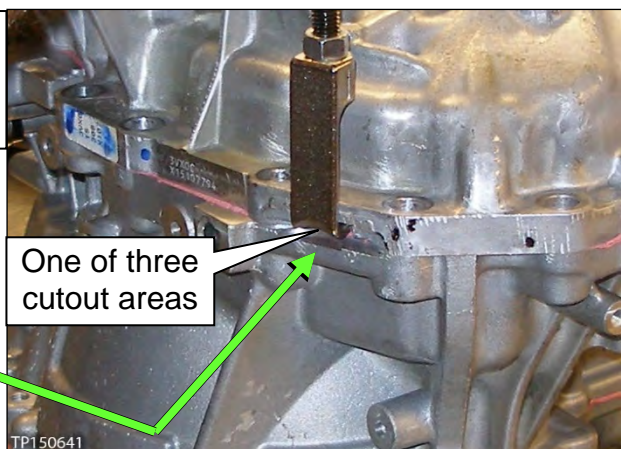

Figure 34

18. Note the location of the pin shown in Figure 35.

HINT: This pin can slip out during movement of the CVT while converter housing is removed.

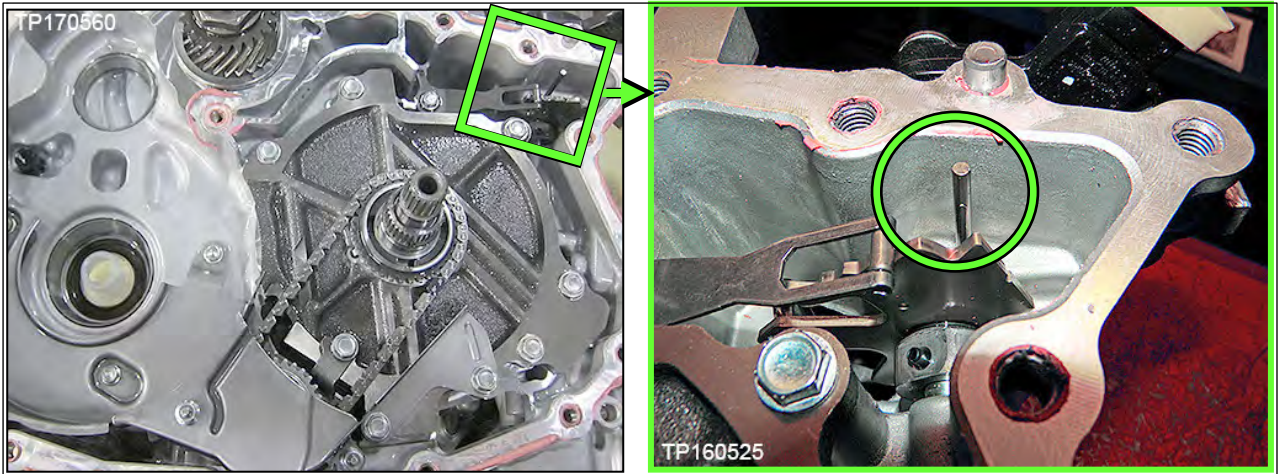

Figure 35

19. Remove the O-ring from the input shaft.

- This O-ring will be replaced with a new one.

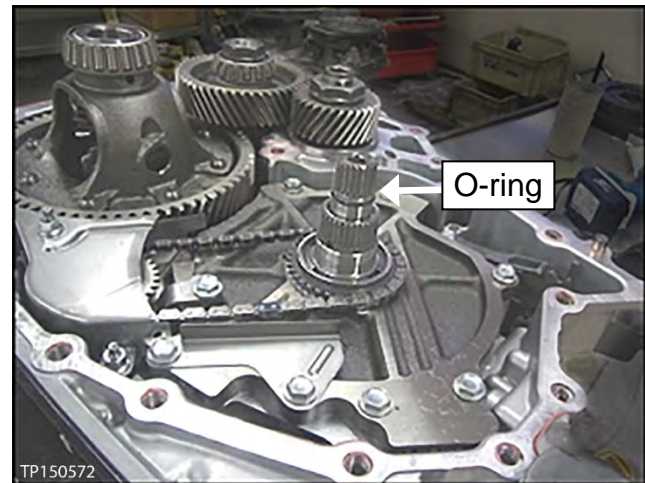

Figure 36

20. Carefully remove the reduction gear assembly (Figure 37).

21. Carefully remove the differential assembly (Figure 38).

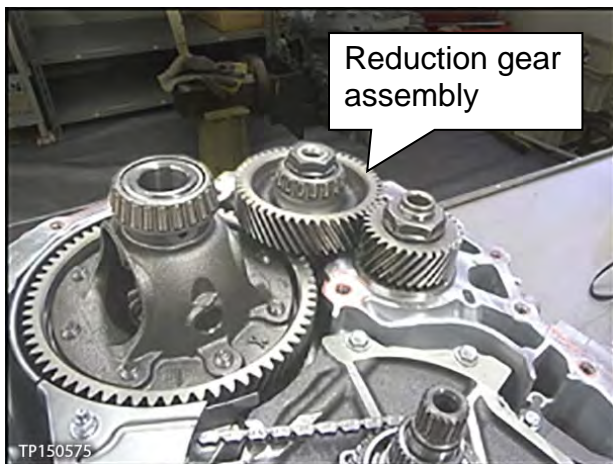

Figure 37

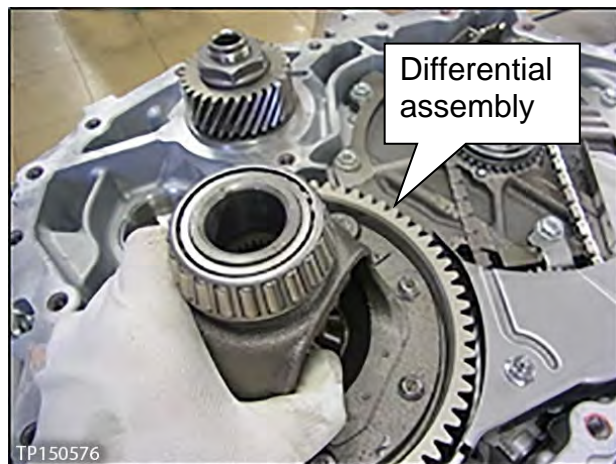

Figure 38

22. Remove the following oil seals using suitable tools:

IMPORTANT: Be careful not to damage any of the seal bore surfaces.

- a. CVT case differential side oil seal (drive shaft seal).
o Figure 39.

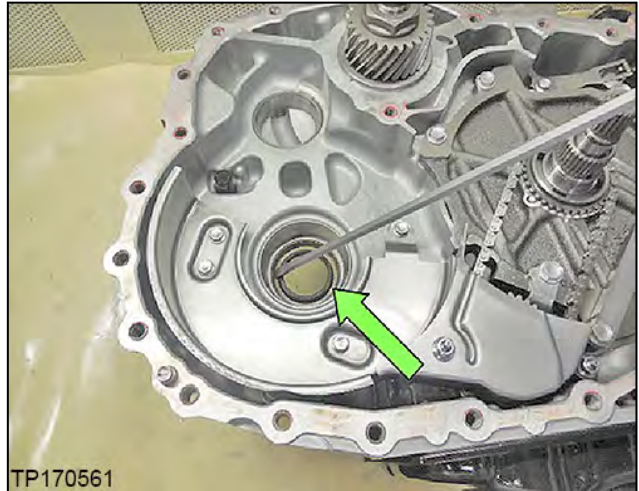

Figure 39

- b. Torque converter seal (Figure 40).

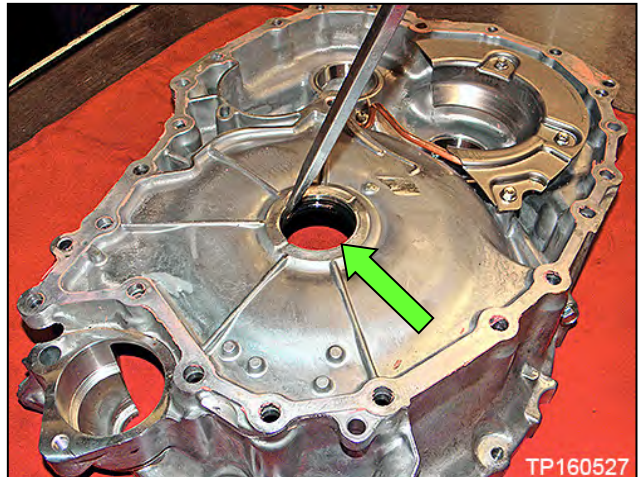

Figure 40

- c. Converter Housing differential side right hand oil seal (drive shaft seal).

- o Figure 41.

HINT: All wheel drive transfer case O-ring will be replaced later in this procedure.

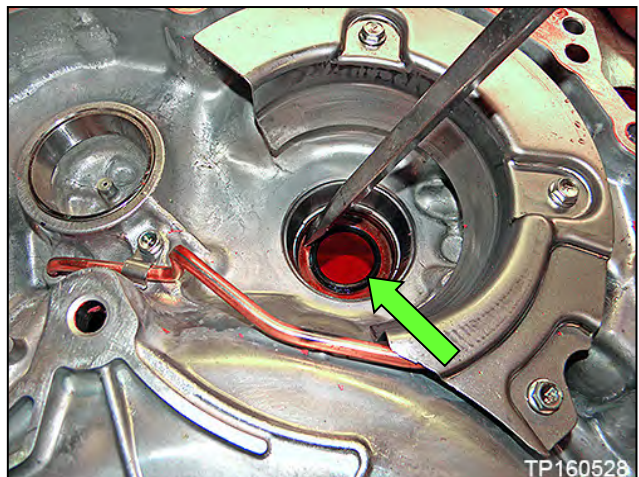

Figure 41

23. Remove the two (2) nuts from baffle plate A, and then remove baffle plate A (Figure 42).

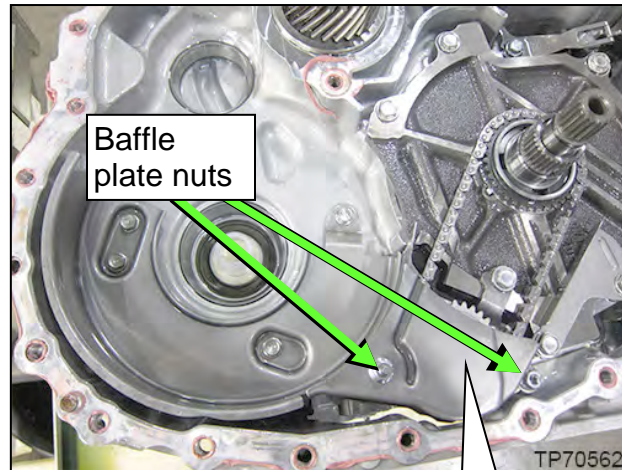

Figure 42

Baffle plate A

24. Remove the oil pump chain, driven and drive sprockets as one assembly (Figure 43).
- Spread the snap ring to remove the sprocket (Figure 44).

IMPORTANT: The drive sprocket has a specific top and bottom. Keep the sprockets and chain together after removal.

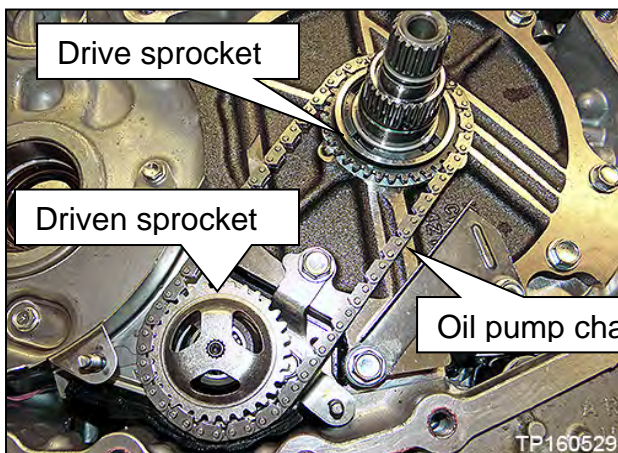

Figure 43

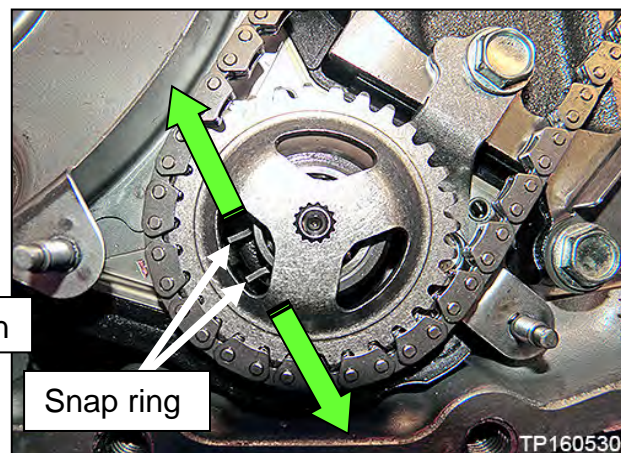

Figure 44

25. Remove the following:

- a. "Pump cover" (dummy cover) thrust washer (Figure 45).
 - This thrust washer will be reused.

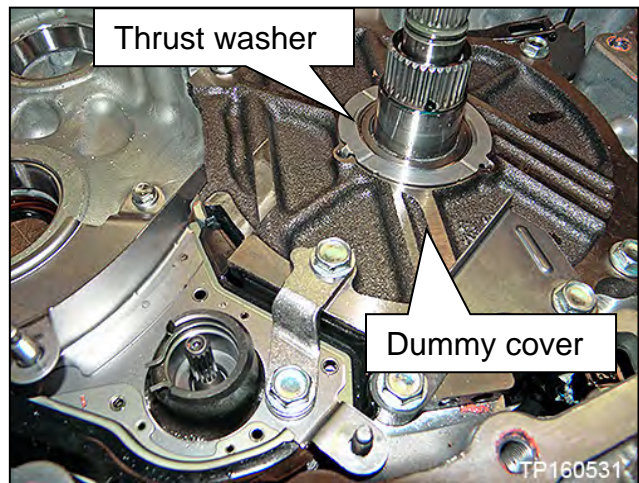

Figure 45

- b. Oil pump snap ring (Figure 46).
 - Lightly push the ends of the snap ring together, rotate one side upwards while pulling the snap ring towards the pump opening.
 - This snap ring will be reused, do not discard.

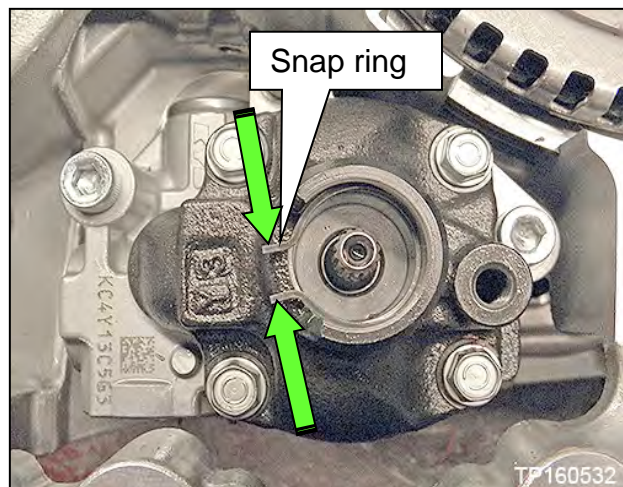

Figure 46

- c. Oil pump bracket (Figure 47).
 - Retained by two bolts.

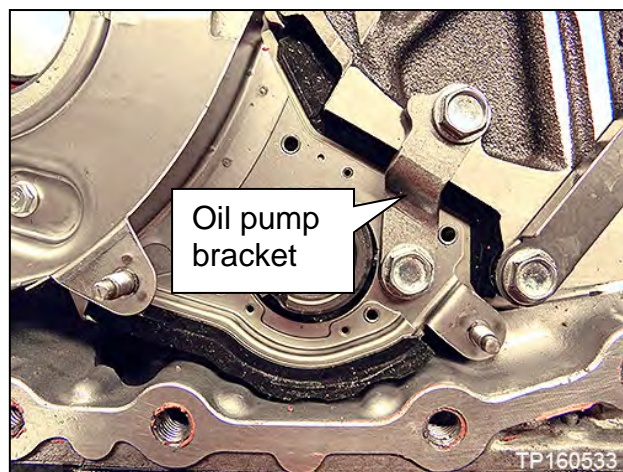

Figure 47

26. Remove the four (4) bolts from baffle plate B, and then remove baffle plate B (Figure 48).

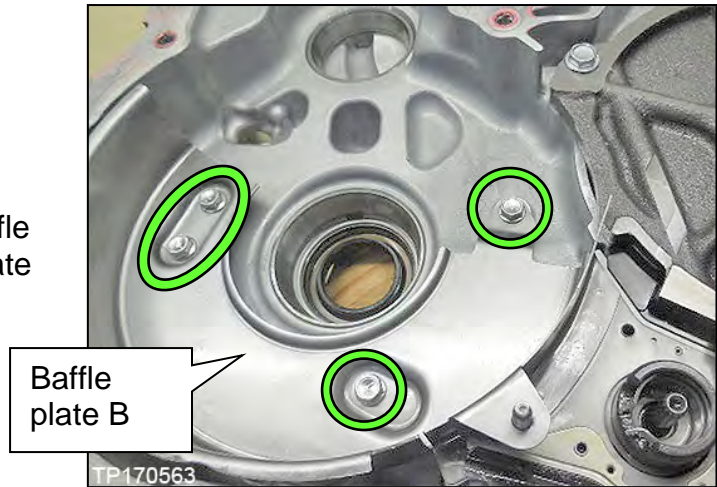

Figure 48

27. Remove the two (2) bolts from baffle plate C, and then remove baffle plate C (Figure 49).

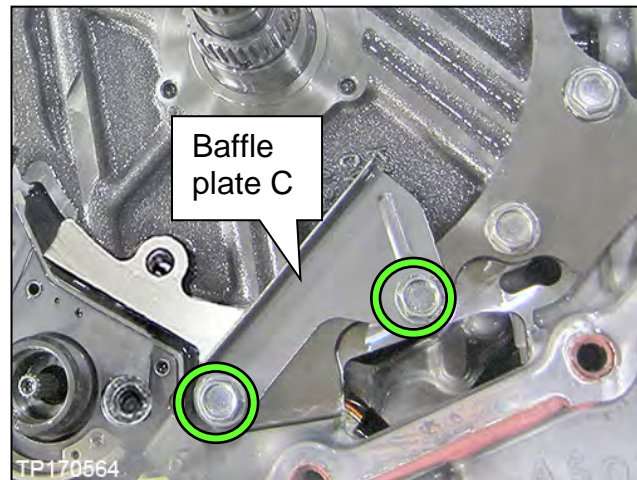

Figure 49

28. Remove the five (5) dummy cover bolts, and then remove the dummy cover. (Figure 50).

HINT: These bolts will be reused.

IMPORTANT:

- Lift the dummy cover from the sides **ONLY**. Do **NOT** lift from the input shaft (Figure 50); this can lift the clutch pack out.
- Confirm that the input shaft O-ring has been removed. If not removed it can cause the clutch pack to lift out.
- Do **NOT** remove the lathe cut seals (white seals), Figure 51 from the dummy cover. These seals will be reused.

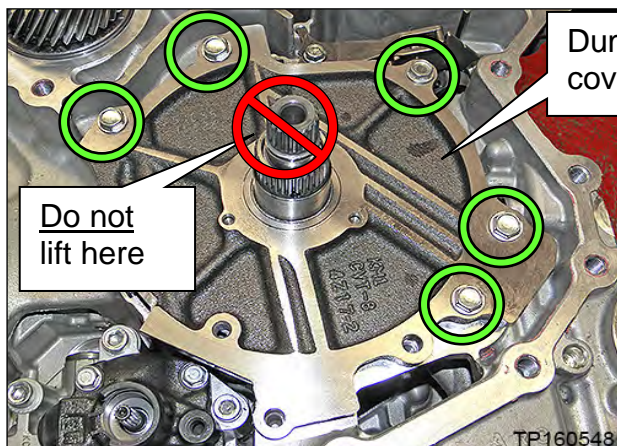

Figure 50

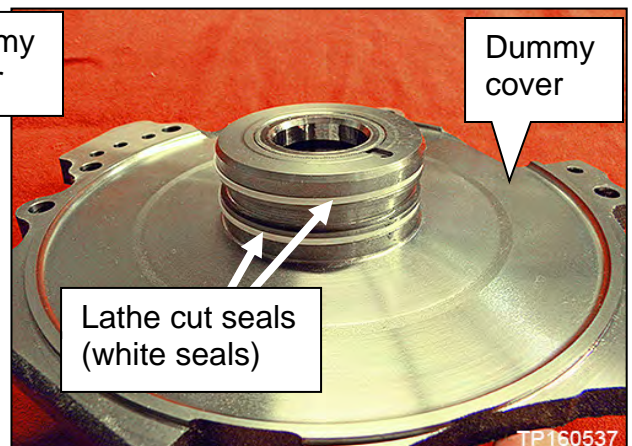

Figure 51

IMPORTANT:

- Depending on the model year and make of the vehicle there will be one of two different dummy covers and corresponding clutch packs; Type 1 (Thrust Bearing) and Type 2 (Thrust Bearing with Bearing Race) – Figure 53 and Figure 54.
 - MY13-14 Pathfinder, MY13-18 Altima, and MY16-22 Maxima use **Type 1** (Thrust Bearing).
 - MY15-20 Pathfinder, MY15-22 Murano and MY15-17 Quest use **Type 2** (Thrust Bearing with Bearing Race).
 - Please see page 115 for **Type 1 and Type 2 Additional Reference Images**.

29. For **Type 1** remove the thrust bearing from the clutch assembly (Figure 52) and then proceed to step 31.
- For Type 2, proceed to step 30.
 - This bearing will not be re-used.

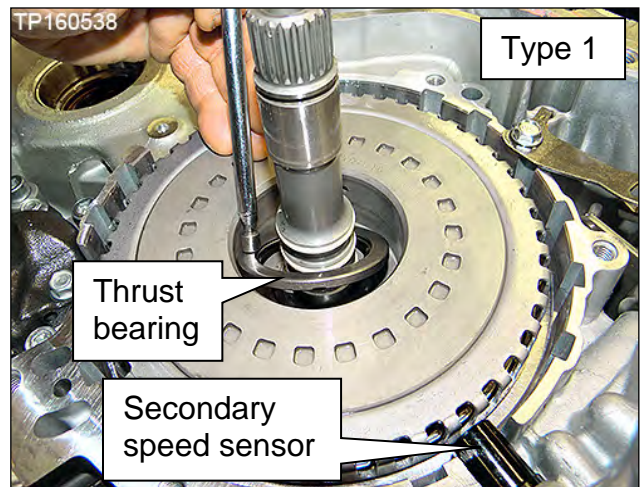

Figure 52

30. For **Type 2**, remove the thrust bearing from clutch assembly (Figure 53) and bearing race from the dummy cover (Figure 54).
- These will be re-used later.
31. Wipe any metallic debris off of the face of the secondary speed sensor (Figure 52).

HINT: The position of the secondary speed sensor is the same for Type 1 or Type 2.

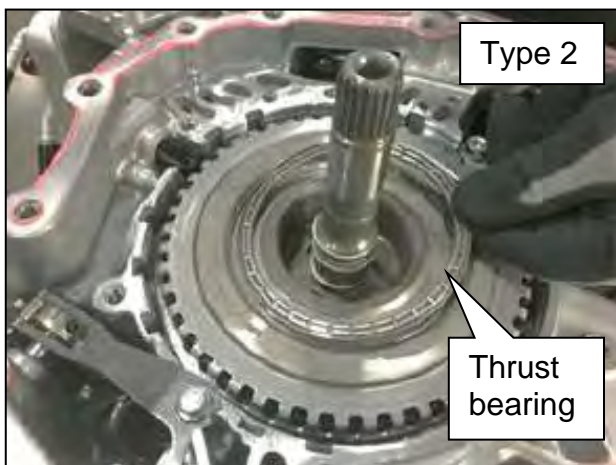

Figure 53

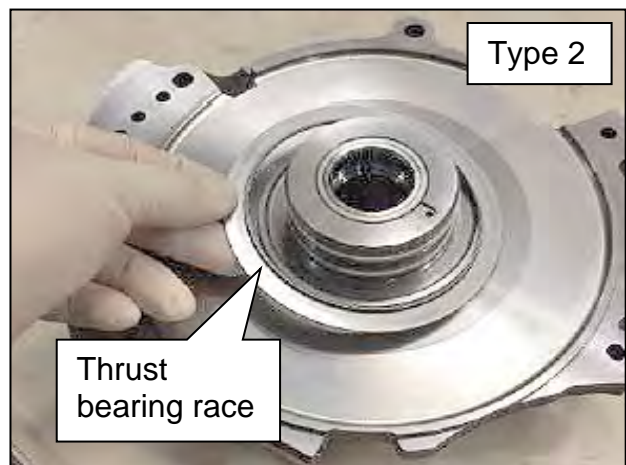

Figure 54

32. Remove the oil pump as follows:
- a. Remove the fitting bolt located above the corner of the oil pan gasket surface (Figure 55).

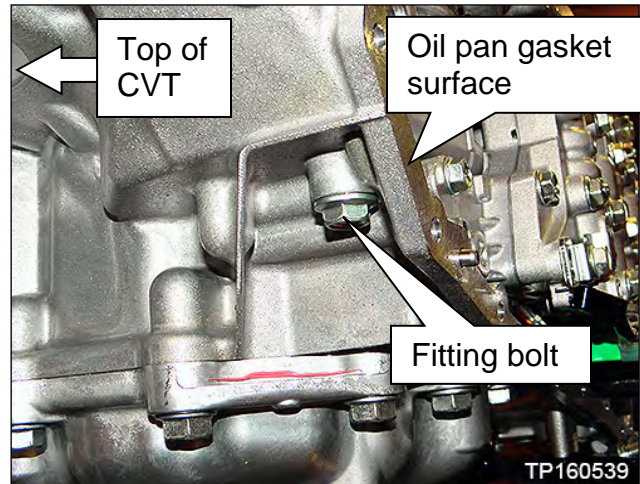

Figure 55

- b. Remove the three oil pump Allen™-head bolts, and remove the oil pump (Figure 56).

HINT:

- o Do NOT discard the Allen™-head bolts. Bolts will be re-used.
- o A new oil pump will be installed at later steps.

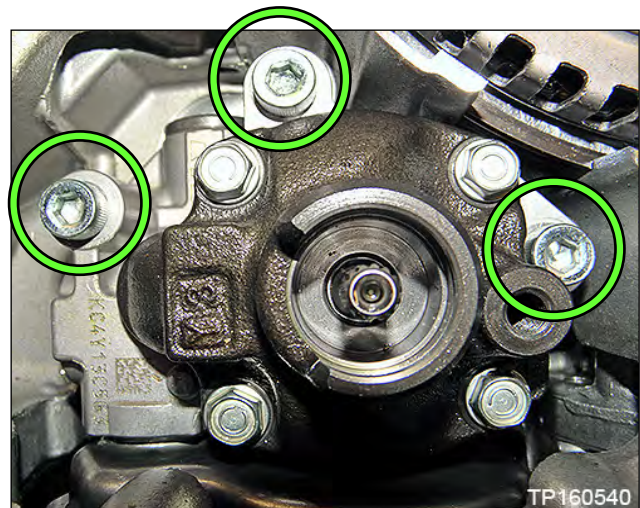

Figure 56

33. Remove CVT fluid filter as follows:

- a. Remove the four (4) bolts and then remove the CVT fluid filter cover (Figure 57).

HINT: Bolts will be reused.

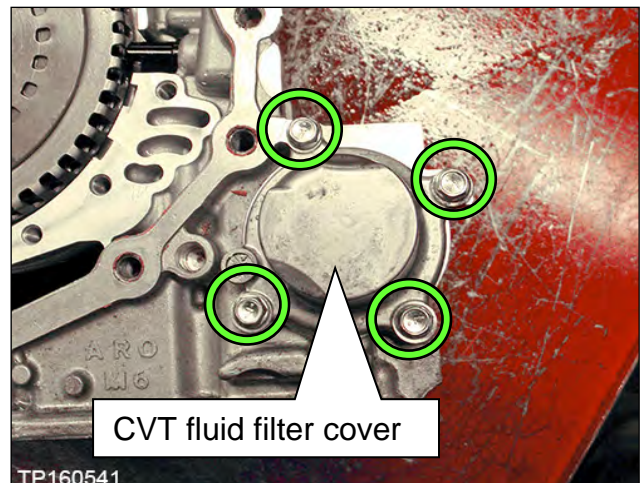

Figure 57

- b. Remove the CVT fluid filter with grommet seal and O-ring seal (Figure 58).
 - o Discard the oil filter and seal. They will be replaced.

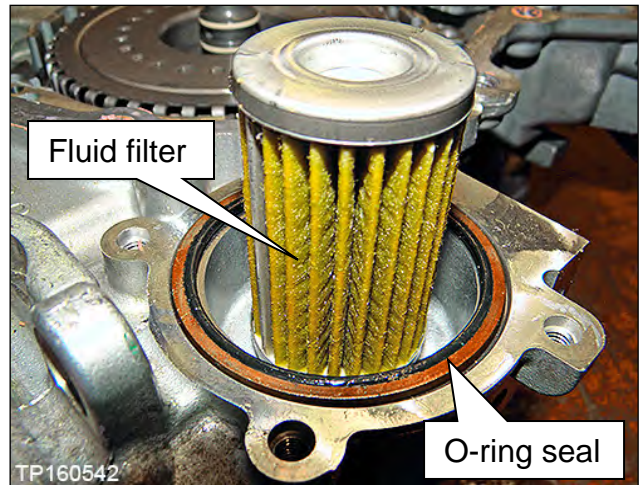

Figure 58

- o Grommet is fitted to the bottom end of the filter and is included with replacement filter (Figure 59).



Figure 59

Clean the CVT Case Surfaces

34. Thoroughly clean the mating surfaces of the CVT case and Torque Converter Housing.

- A plastic scraper can be used.

NOTICE

- DO NOT use sanding discs, similar abrasive tools, or metal blades.
- Use brake spray or equivalent solvent and lint-free towels only.
- Make sure brake spray or solvents used are compatible with local regulations.
- Avoid debris entering into the inside of the CVT.
- Make sure rust and debris have been cleaned off of dowel pins and receiving holes (Figure 60).

35. Clean the dowel pins and dowel pin receiving holes of any rust or debris with emery cloth (Figure 60).

HINT: Use small wire brush or similar tool at the inside surface of dowel pin holes.
DO NOT SCRAPE CVT CASE mating surfaces.

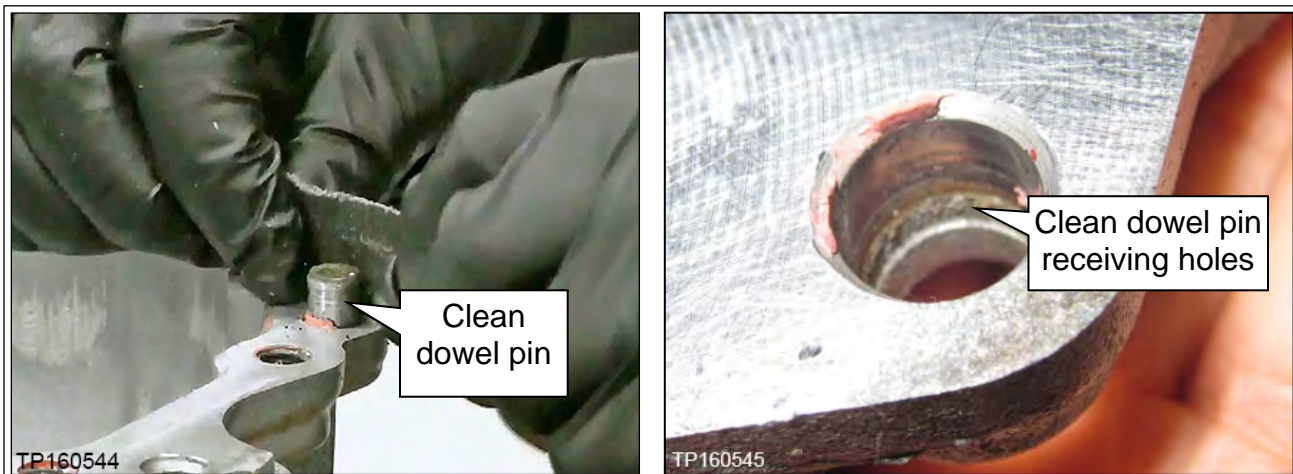

Figure 60

Clean the Oil Passages in the CVT Case, Oil Pump Cover, and CVT Filter Area

In the following steps:

- Brake cleaner and compressed air will be used to clean out oil passages in the CVT assembly.
- Make sure the brake cleaner or solvents are compatible with local regulations.

CAUTION

To avoid the risk of minor personal injury, wear eye / face protection when using compressed air and cleaning fluids.

IMPORTANT:

- Regulate air pressure up to a maximum of 75 PSI.
- Do not use water-based (aqueous) cleaners.

36. Clean the area where the CVT fluid filter fits (Figure 61).

- Make sure the old filter grommet seal is removed.

37. Clean the fluid passages to and from the filter (Figure 61).

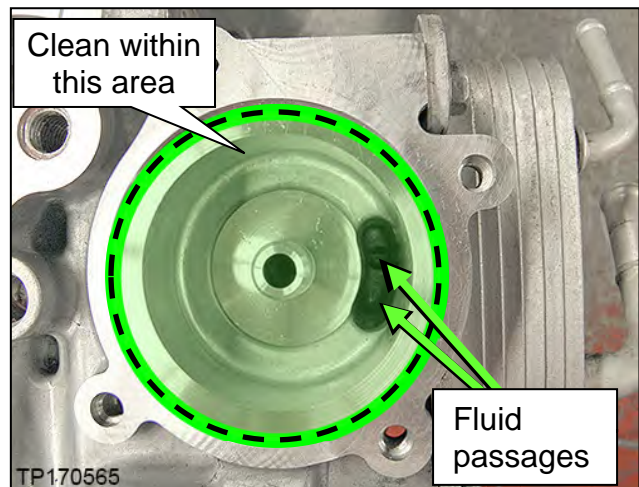

Figure 61

38. Clean filter cover (Figure 62).



Figure 62

39. Spray brake clean in all oil passages of the CVT case where shown in Figure 63 and Figure 64.
40. Remove lip seal if not already removed.
41. Apply compressed air in the same passages.

HINT:

- Do not stand in front of the passages while using compressed air.
- Do not spray brake clean directly into clutch pack.

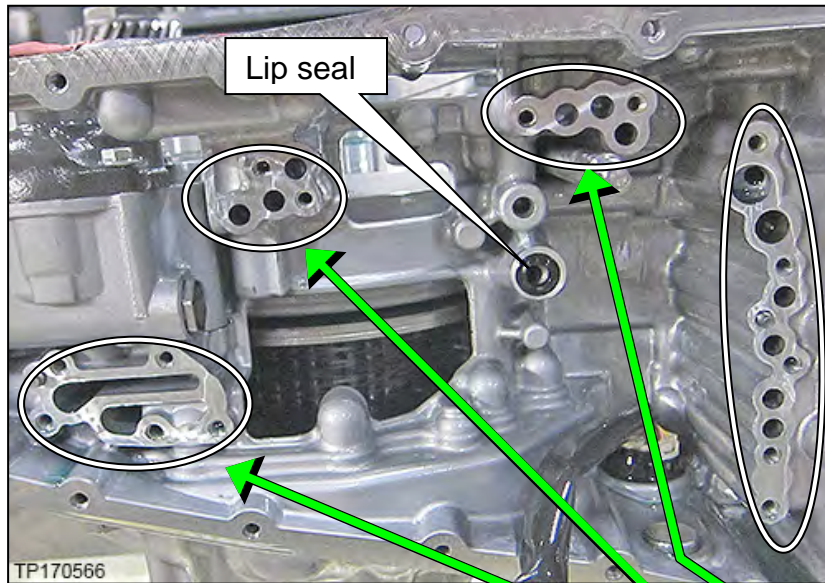

Figure 63

Apply cleaner, and then 75 PSI maximum air pressure in these passages.
Air pressure comes out these passages.

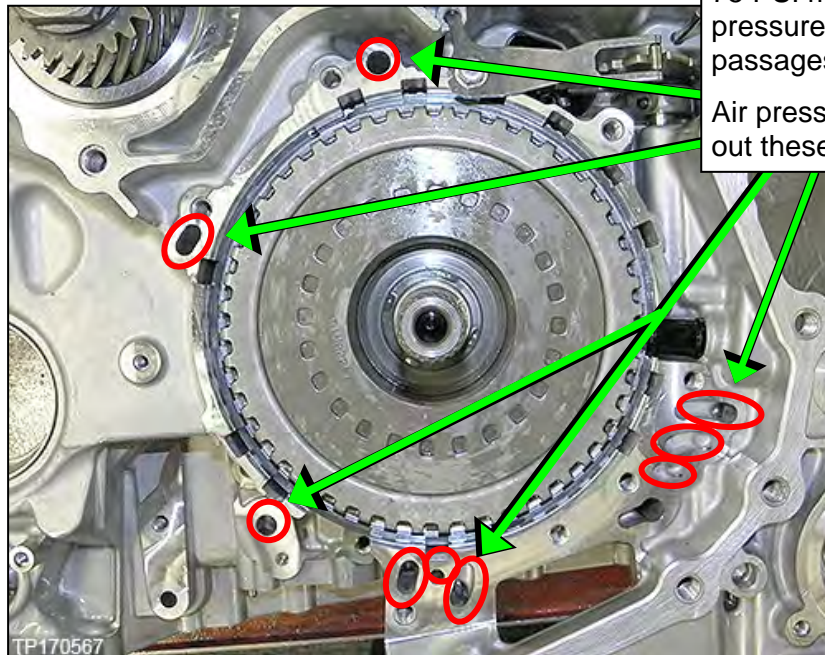

Figure 64

New Oil Pump Installation

42. Install the new oil pump using three (3) original Allen™-head bolts.

HINT: Finger tighten the Allen™-head bolts at this time.

IMPORTANT: A Parts Kits Reference Table is provided on page 113.

- Use the check off column on the left to ensure the correct new part is installed at each step.
- Attach this to the repair order.

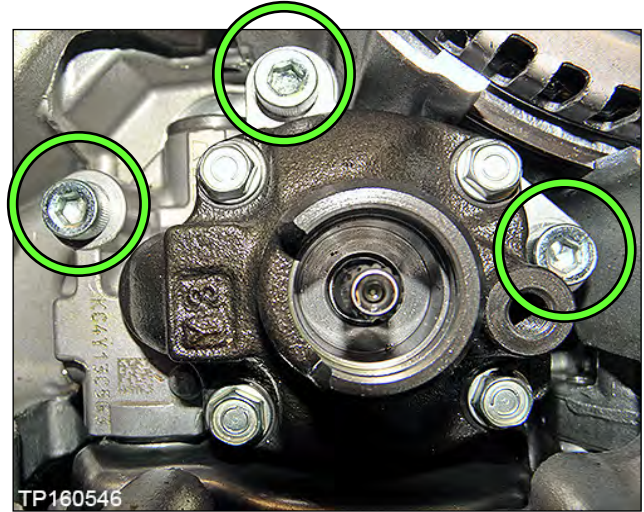

Figure 65

43. Place a new O-ring on the fitting bolt, and coat with CVT fluid (Figure 66).

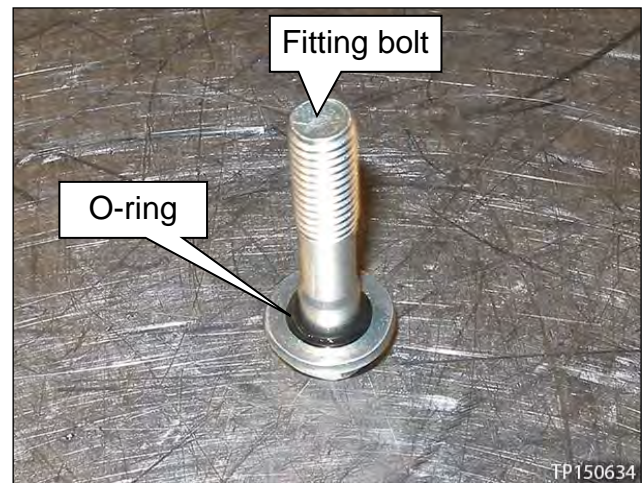

Figure 66

44. Install the fitting bolt finger tight (Figure 67).



Figure 67

45. Torque the three (3) Allen™ head bolts and fitting bolt.
- Allen™ head bolt torque: 17.6 – 20.6 N•m (1.79 – 2.1 kg-m, **13.0 – 15.2 ft-lb**)
 - Fitting bolt torque: 26.0 – 30.0 N•m (2.65 – 3.06 kg-m, **19.2 – 22.1 ft-lb**)

46. Install the original snap ring (Figure 68).

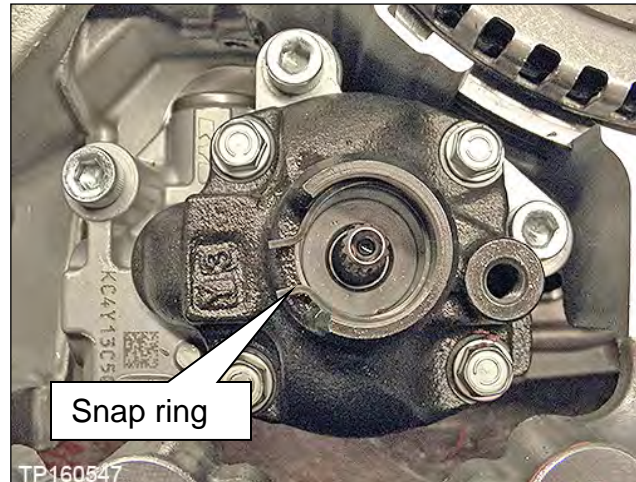

Figure 68

47. Install the CVT fluid filter and components (Figure 69 and Figure 70).
- Install a new filter with grommet (one part).
 - Install a new O-ring.
 - Confirm that all components and areas where components fit are thoroughly clean.
 - Apply CVT fluid to the grommet seal and O-ring before installing.
 - Install the filter cover.
 - Bolt torque 4.2 N•m (0.43 kg-m, **37.2 in-lb.**)

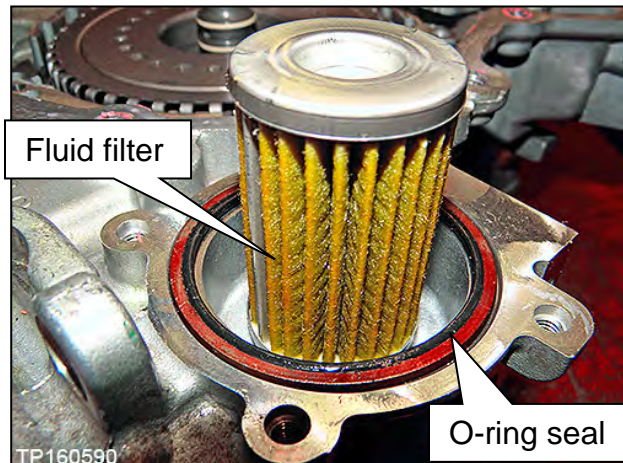

Figure 69

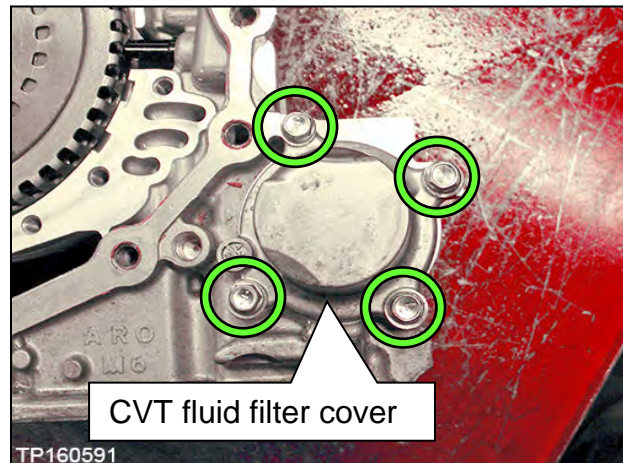

Figure 70

Replace the Side Cover – Pulleys and Chain (sub-assembly)

48. Temporarily install the dummy cover with 3 bolts, finger tight (Figure 71).

IMPORTANT:

- Do not install any thrust bearing to the clutch assembly bore at this time.
- If the cover does not seat flush see **TROUBLESHOOTING The Dummy Cover Will Not Sit Flush** on page 107.

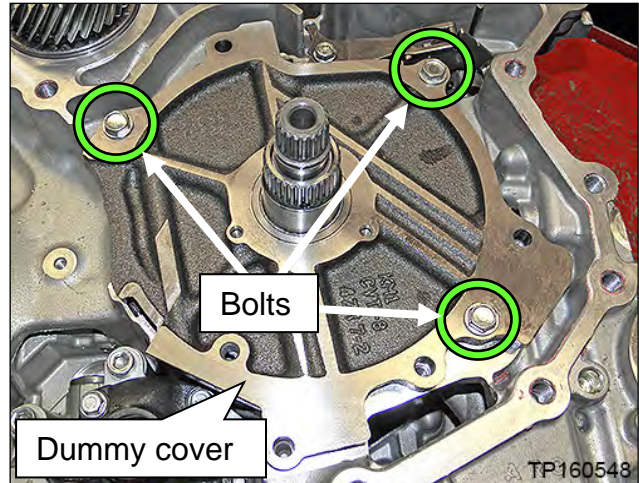

Figure 71

49. Temporarily install the converter housing onto the CVT case with three bolts finger tight (Figure 72).

IMPORTANT:

- When fitting the CVT case surfaces, **DO NOT** use the bolts to draw in the case halves.
- Make sure the case surfaces are flush, and have no gaps prior to installing the bolts.

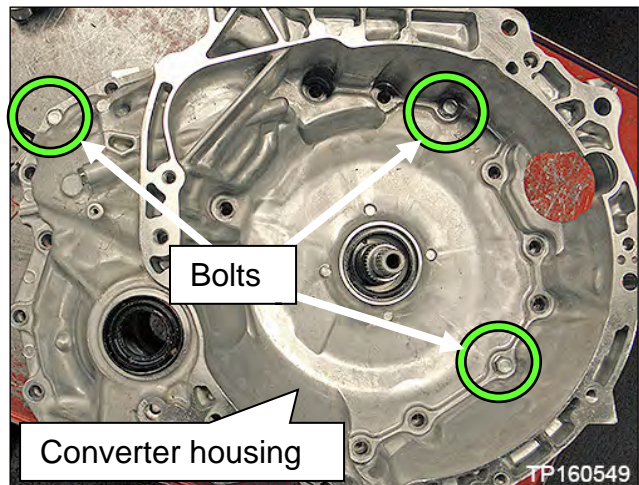

Figure 72

50. Flip the CVT case so that the converter housing faces down and side-cover faces up.

- Lifting fixture J-51595 can be used for this step. This tool is not shown in Required Tools / Materials.

IMPORTANT:

- Do not hit the manual shaft (Figure 73) while flipping the CVT; the manual shaft protrudes past the CVT case. Use a plastic / wooden block to support as needed.
- Note the location of the terminal connector harness. Do not pinch the terminal connector harness between the CVT case and work bench or supporting blocks.

51. Rotate the primary pulley by hand to check the pulley's rotational characteristics.

IMPORTANT:

- Remember the pulley's rotational characteristics. This will be used as a reference after the new side cover-pulleys and belt sub-assembly (sub-assembly) have been installed.
- This will be used as a reference later in the procedure to determine if the sub-assembly installation is successful or not.

NOTICE

Do not place fingers between the pulley and the CVT case.

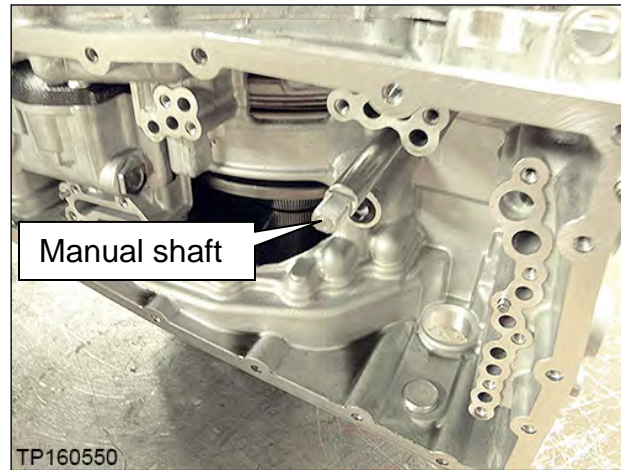

Figure 73

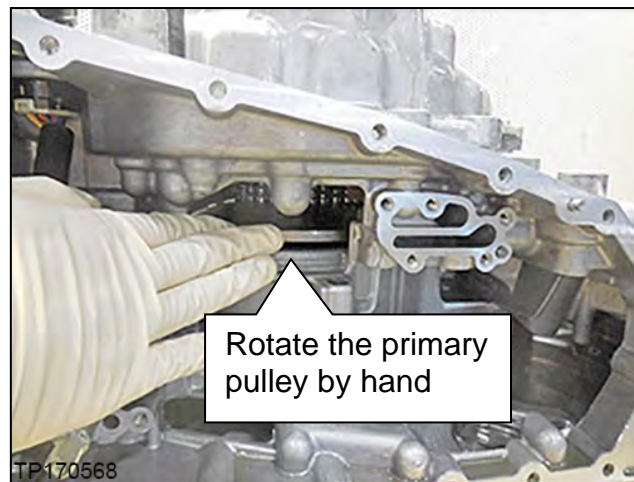

Figure 74

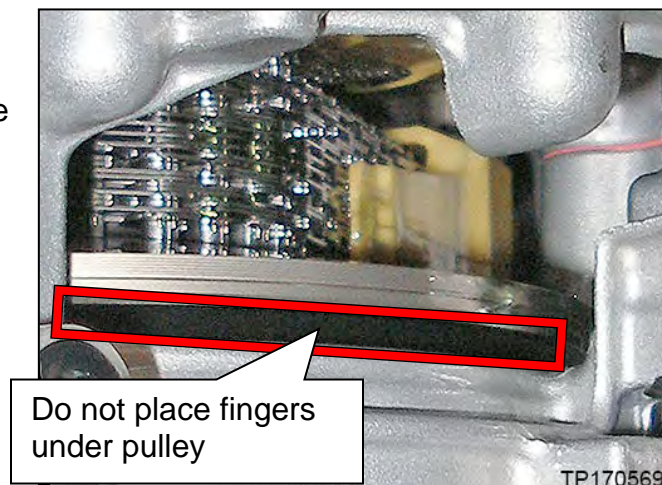

Figure 75

HINT: When working with sub-assembly install, uninstall, and bracket attachment, it is critical that CVT and sub-assembly are level. If not level, the pulleys and bearings can sit slightly at an angle and will hinder installation.

52. Remove the nineteen (19) side cover bolts (Figure 76).

- Loosen the bolts with hand tools only.
- These bolts will be replaced with new ones and will not be reused.

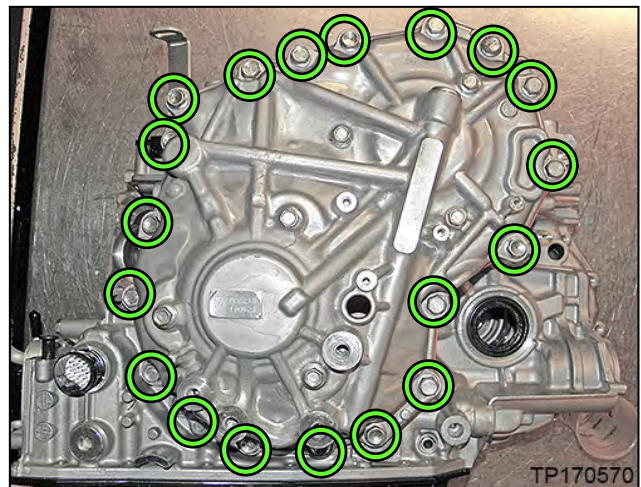

Figure 76

53. Remove the six (6) pulley bracket bolts.

- These bolts will be reinstalled to the original pulley and belt sub-assembly.

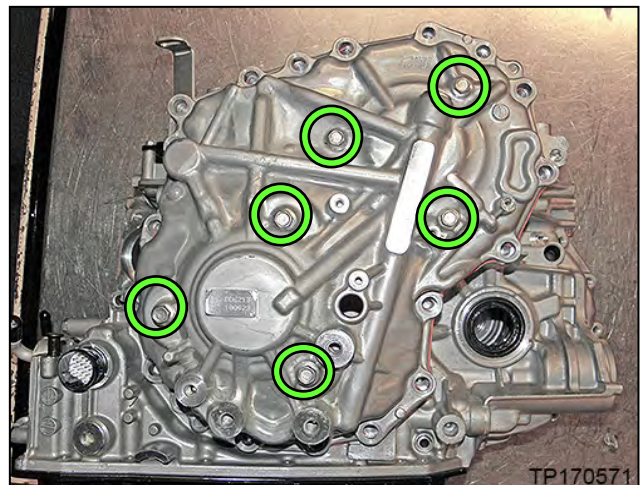

Figure 77

54. Attach universal Lifting Fixture J-52082 with spacers J-52082-2 to the side cover as shown in Figure 78.

HINT: Install and tighten by hand only.

- Loosen all of the wing-nut bolts on the Lifting Fixture.
- Confirm that three (3) spacers (# J-52082-2) are present between the longer legs and triangle bracket as shown in Figure 78.
- Install the Lifting Fixture to the CVT case at the six (6) bolt holes shown in Figure 77 on page 35.
- Tighten the two (2) joints to the triangle brackets.
- Tighten the wing-nut bolts on the Lifting Fixture finger tight.

IMPORTANT: Do not cross-thread the bolts when attaching to the CVT side cover.

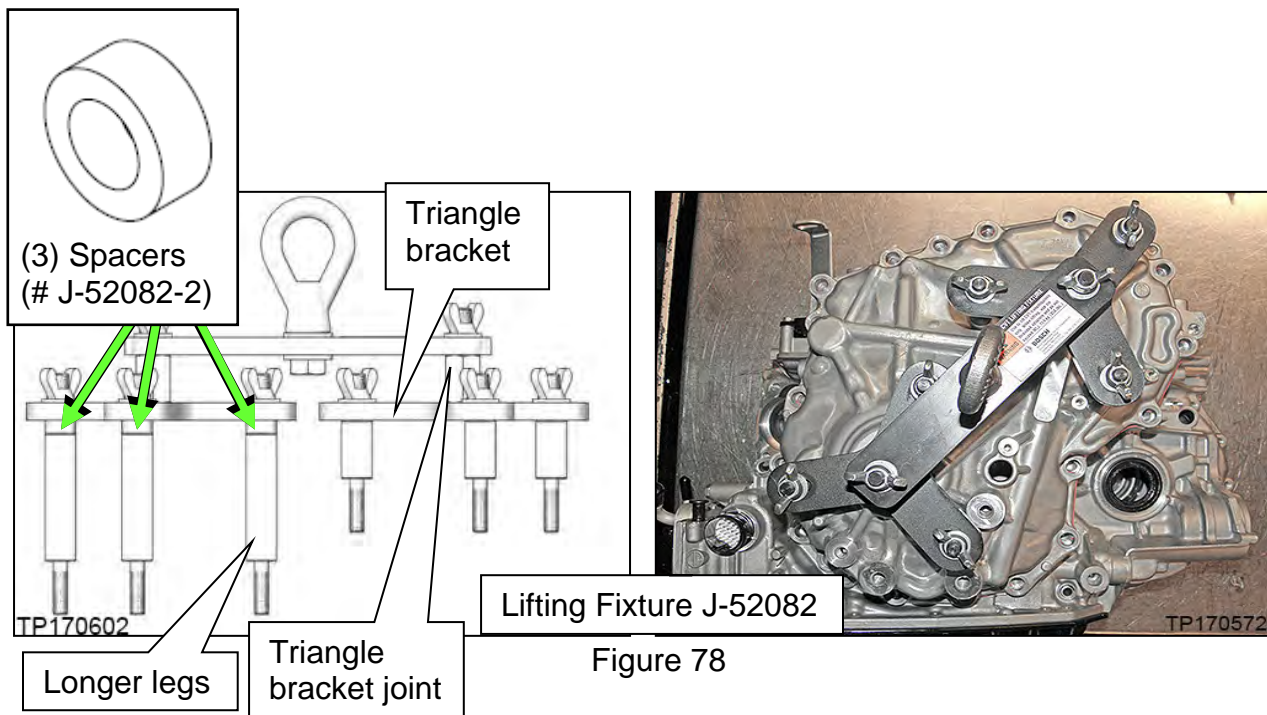

55. Install the two CVT Assembly Guide Pins (J-51959 - Guide Pins) as shown in Figure 79 and Figure 80.

- The Guide Pins must be located next to the dowel pins.

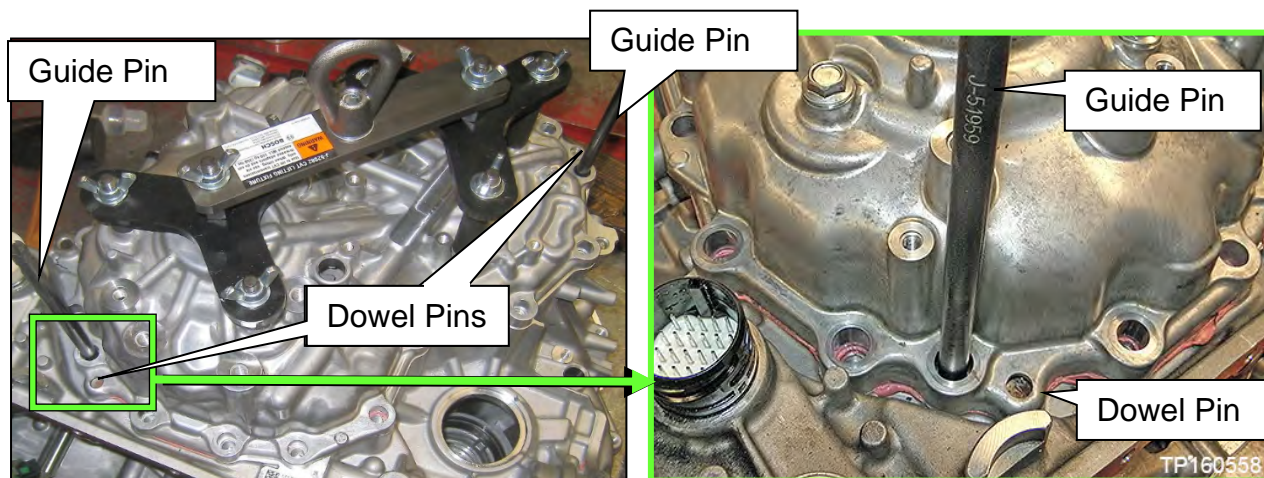

56. Raise the Lifting Fixture so that the CVT assembly weight is mostly supported by the Lifting Fixture and just slightly raised off of the work surface (using Tool #: J-52082).
57. Loosen the side cover with a slide hammer at the 3 points shown in Figure 81.
 - Rotate between the 3 locations on the side cover until the CVT case separates from the sub-assembly; this can take more than one rotation to loosen the sealant.

IMPORTANT: DO NOT use a pry-bar, chisel, etc. to separate the side cover from the CVT case.

HINT: Apply rust penetrant to the two dowel pins as needed.

The following Figure is for reference only and does not show the lifting device attached.

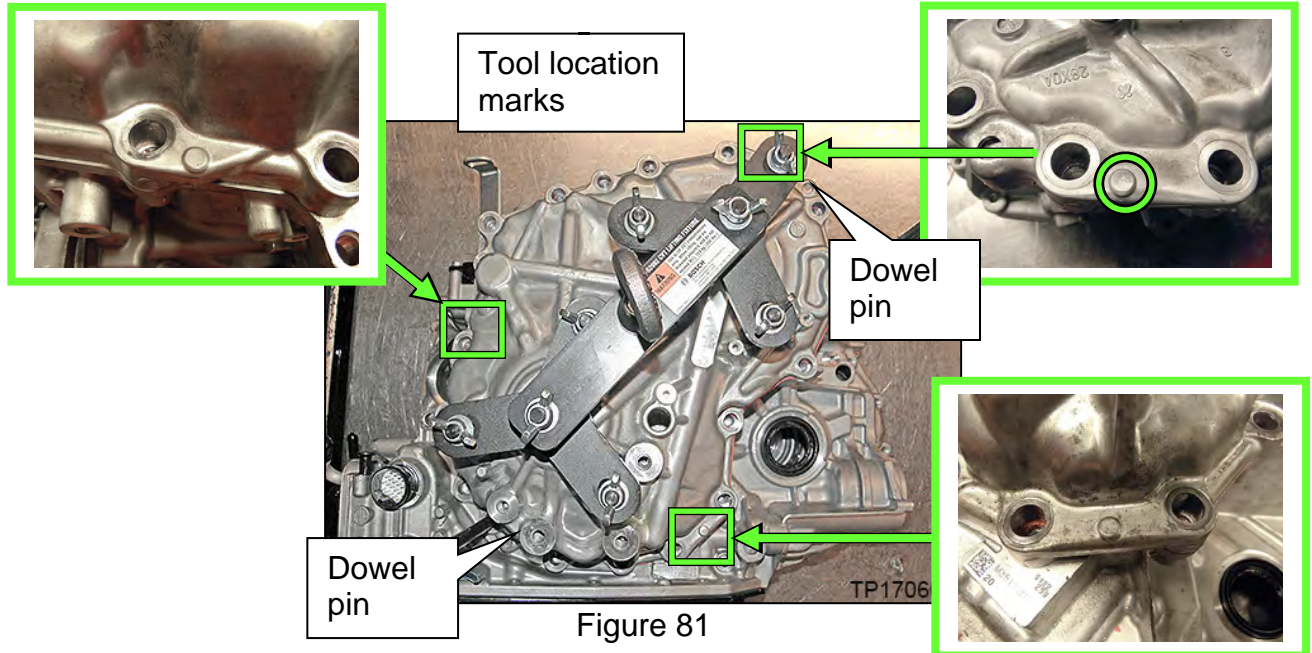

Figure 81

58. Raise the lifting fixture to remove the “side cover with pulleys and chain sub-assembly” (sub-assembly) from the CVT case (Figure 82) and set aside.

IMPORTANT: Make sure the primary speed sensor is removed from the sub-assembly.

 - The speed sensor will be reused.
 - **DO NOT** discard the speed sensor.
 - This sub-assembly will not be reused.
59. Remove the lifting fixture from the sub-assembly and replace all six (6) original bolts.

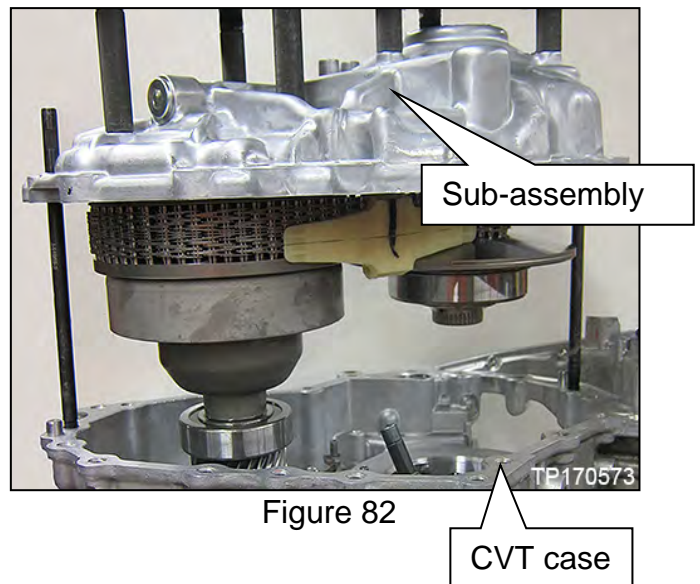

Figure 82

60. Thoroughly clean the mating surfaces of the CVT case (Figure 83) that the sub-assembly was just separated from (a plastic scraper can be used).
- Clean off the dowel pins.
 - Confirm that the dowel pins have remained in the CVT case. If not, remove them from the sub-assembly and relocate back to the CVT case.
 - Reinstall the guide pins if they were removed during case cleaning.

NOTICE

- **DO NOT** use sanding discs, similar abrasive tools, or metal blades.
- Use brake cleaner or equivalent solvent and lint-free towels only.
- Make sure brake spray or solvents used are compatible with local regulations
- Avoid debris entering into the inside of the CVT.
- Make sure rust and debris have been cleaned off of the dowel pins and receiving holes.

61. Remove the O-ring from the CVT case (Figure 84).

- This O-ring will not be reused.

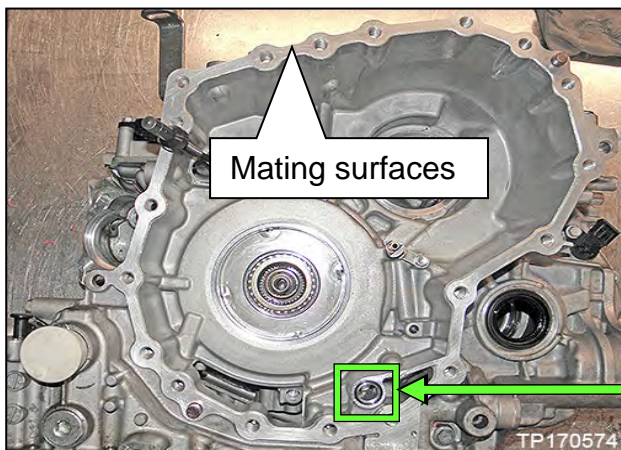

Figure 83

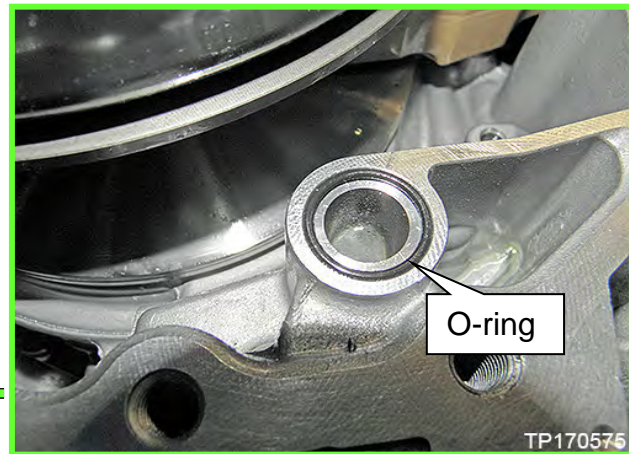

Figure 84

62. Remove the thrust bearing from the planetary carrier plate (Figure 85).

- **The thrust bearing will be re-used. DO NOT discard.**

IMPORTANT: If not found on the planetary carrier plate, the thrust bearing may still be attached to the primary pulley.

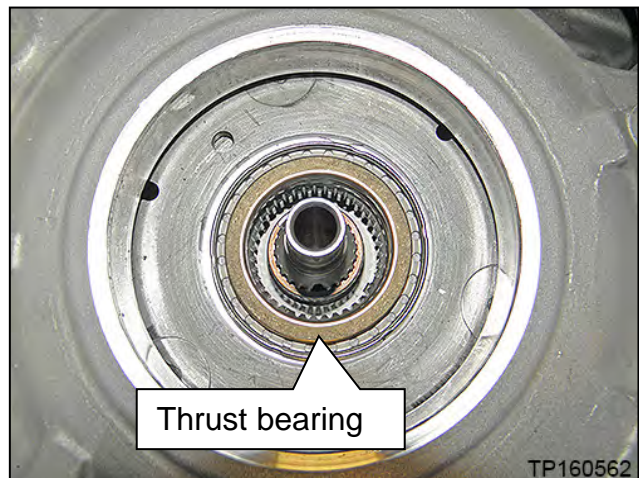

Figure 85

63. Rotate the shift select lever counter clockwise to the “L” range position (Figure 86), so that the parking rod is at its lowest position (Figure 87).

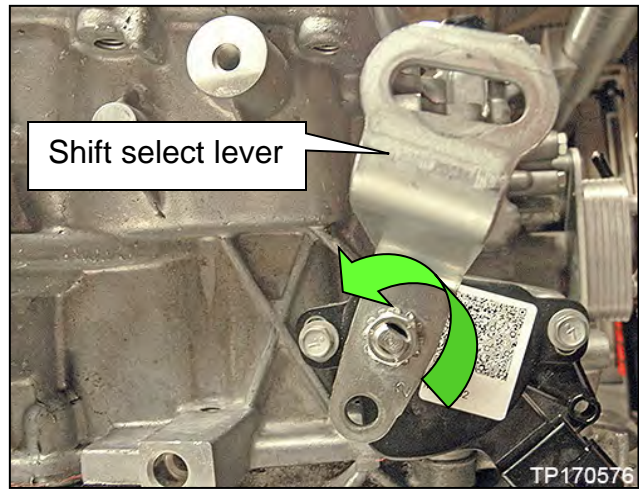

Figure 86

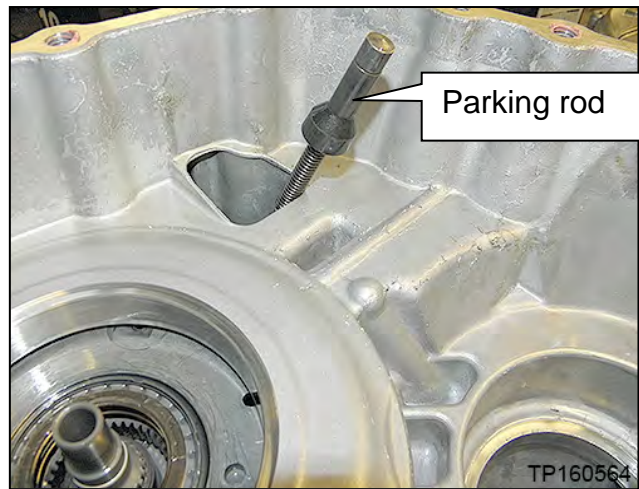

Figure 87

64. Remove the six (6) bolts from the new sub-assembly and then remove their O-rings.
- These bolts will be reused.
 - These O-rings will not be reused.
65. Attach Lifting Fixture to the new sub-assembly, and then raise sub-assembly out of shipping box.

IMPORTANT: Do not cross thread side cover holes when installing the Lifting Fixture. Always start bolts by hand.

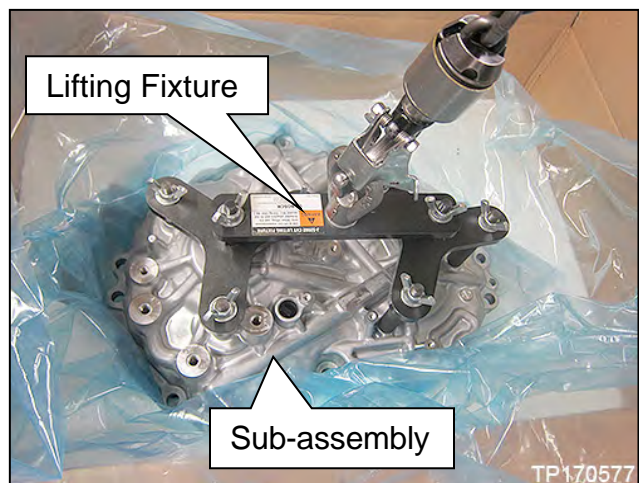

Figure 88

66. Install the original thrust bearing onto the primary pulley of the new sub-assembly (Figure 89).

IMPORTANT: The thrust bearing has two different sides. Reference Figure 89 for correct bearing orientation.

- Apply a thin layer of petroleum jelly or equivalent to the original thrust bearing to hold it in place on the primary pulley.
- The thrust bearing must sit flush with primary pulley surface (Figure 89).
- Reuse the thrust bearing which was removed from the planetary carrier plate.

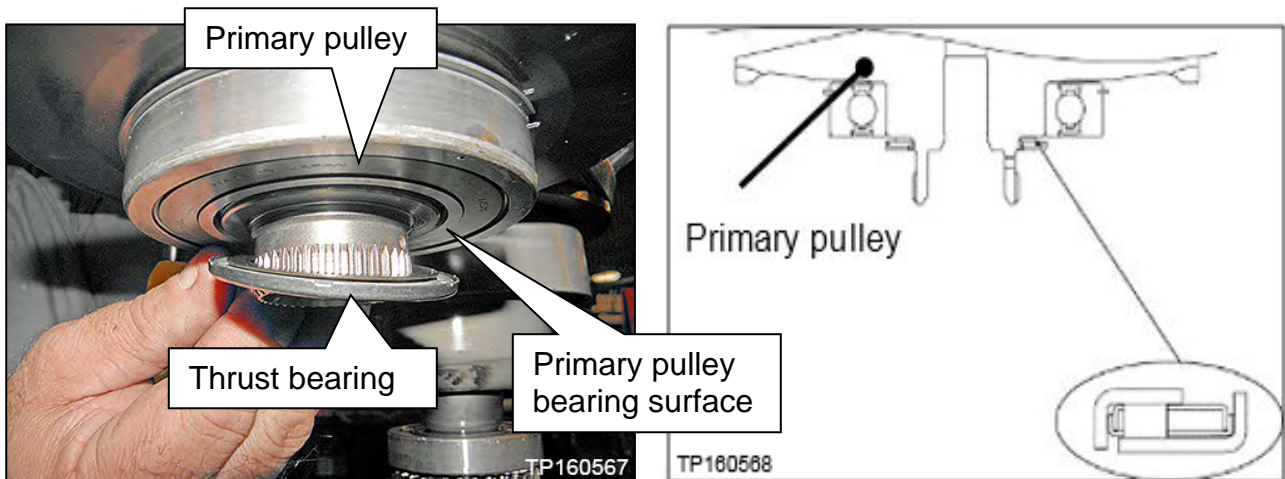

Figure 89

67. Coat the primary pulley bearing, secondary pulley gear teeth and the secondary bearing with CVT fluid prior to installation (Figure 90).

IMPORTANT: Do NOT apply sealant to the case at this time. The sub-assembly will be sealed later in this procedure.

The following Figures are for reference only and may or may not have the sealant in place, or have the old sealant removed. Clean the surfaces and apply sealant when and where instructed.

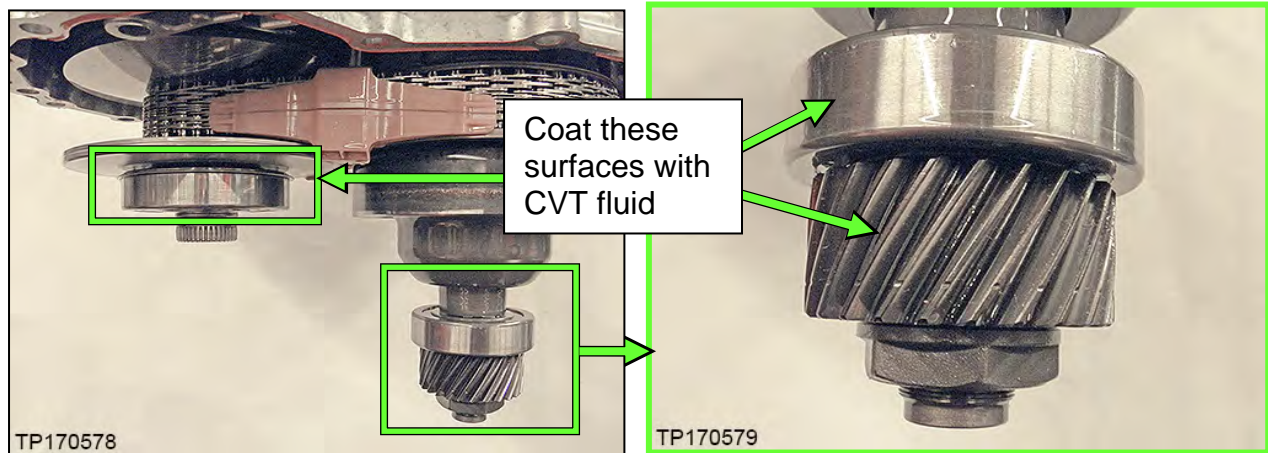

Figure 90

68. Position the new sub-assembly over the CVT case and then lower it just far enough to allow the Guide Pins to be inserted into their appropriate sub-assembly holes (the Guide Pins are different lengths).

IMPORTANT: Do NOT allow the output gear to contact the lubrication tubes when the side cover is positioned over the guide pins.

HINT: Guide pin locations are shown in Figure 79 on page 36.

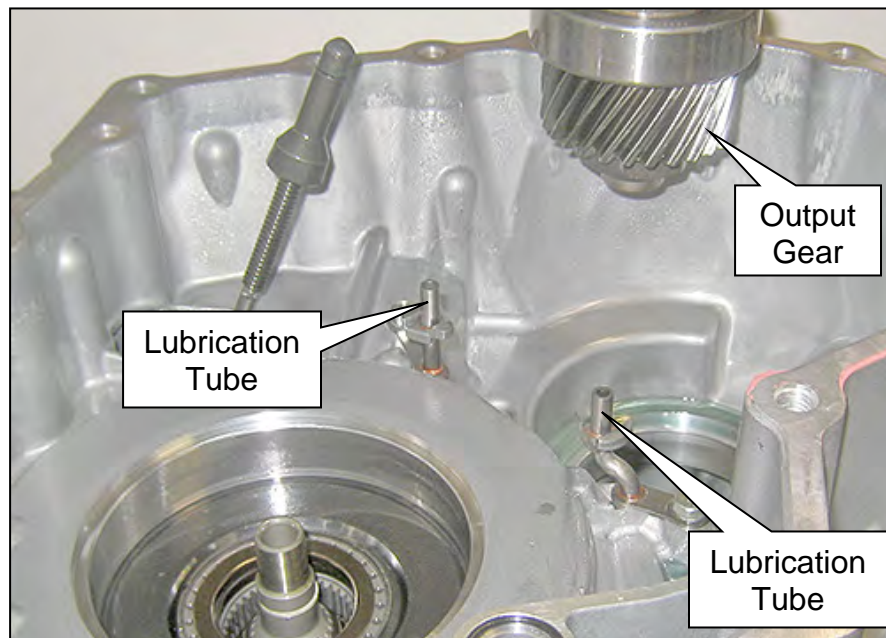



Figure 91

IMPORTANT:

Before continuing, it is recommended that you review and understand the instructions on pages 42 to 47.

- Confirm dowel pins are clean – this will ease installation.
- **The sub-assembly will lower into the CVT case without applying extra vertical force.**
- IF THE SUB-ASSEMBLY DOES NOT LOWER COMPLETELY,  **! PHYSICAL INTERFERENCE IS PRESENT.**

Key Technique: Raise the sub-assembly to remove weight from the interference, adjust as necessary, and then lower again.

Use the “gap size” between the sub-assembly and the CVT case to determine the cause of interference. At any given gap, only 1 item will be the cause of interference.

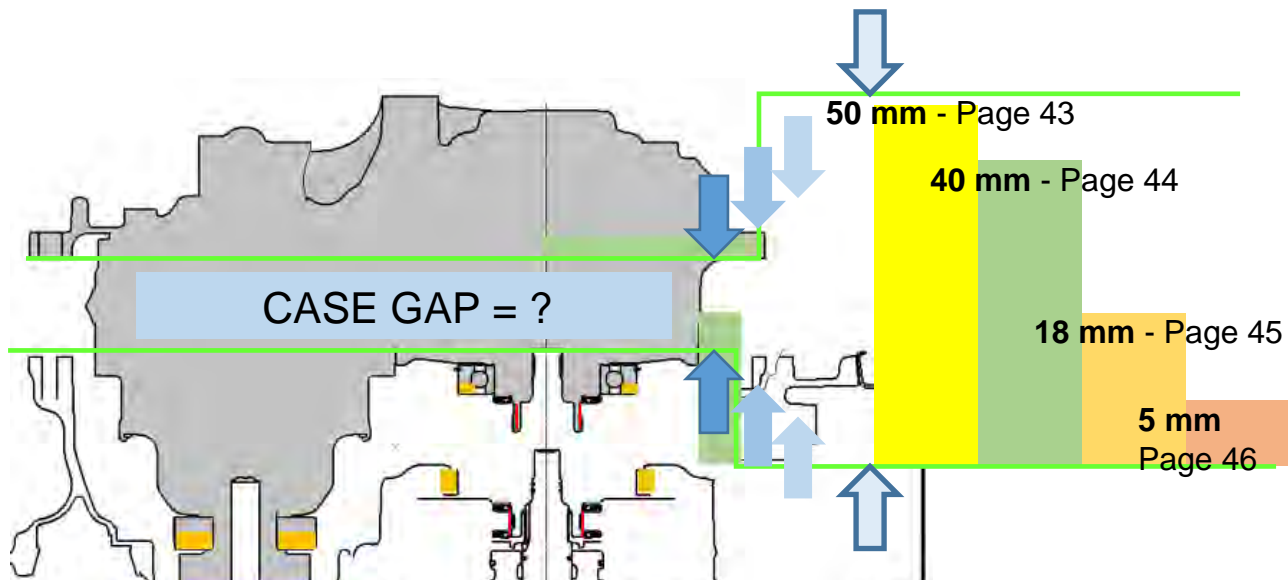

Figure 92

Case gap

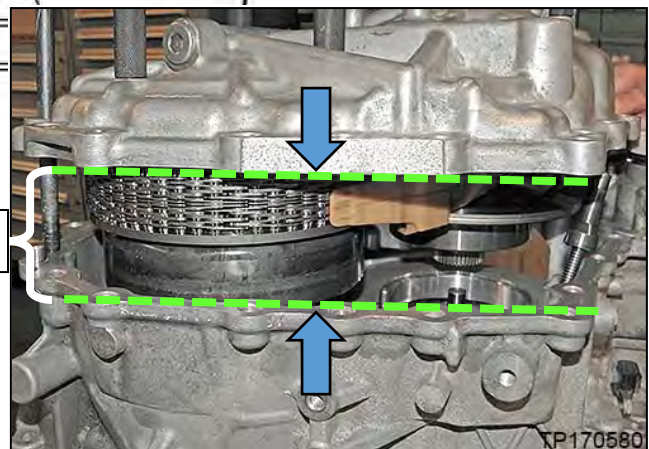

Figure 93

69. Carefully lower the Lifting Fixture to install the sub-assembly into the CVT case as follows:
- While visually looking down into the bore (Figure 95) to confirm that the output gear is clearing the CVT case bearing bore,
 - a. Level the sub-assembly by placing hands on top to guide it into the CVT case.
 - b. Lower the sub-assembly until a gap of **40 mm (1.6 inch)** is present to the CVT case (Figure 98 on page 44) and then proceed to step 70.
 - If the sub-assembly will not lower any farther than 50 mm (2 inches) the output gear has not cleared the bearing bore (Figure 95).

Sub-assembly will not lower past 50 mm (2 inches)?

- Interference is present between the output gear and bearing bore and are highlighted with yellow in Figure 94 and Figure 95.

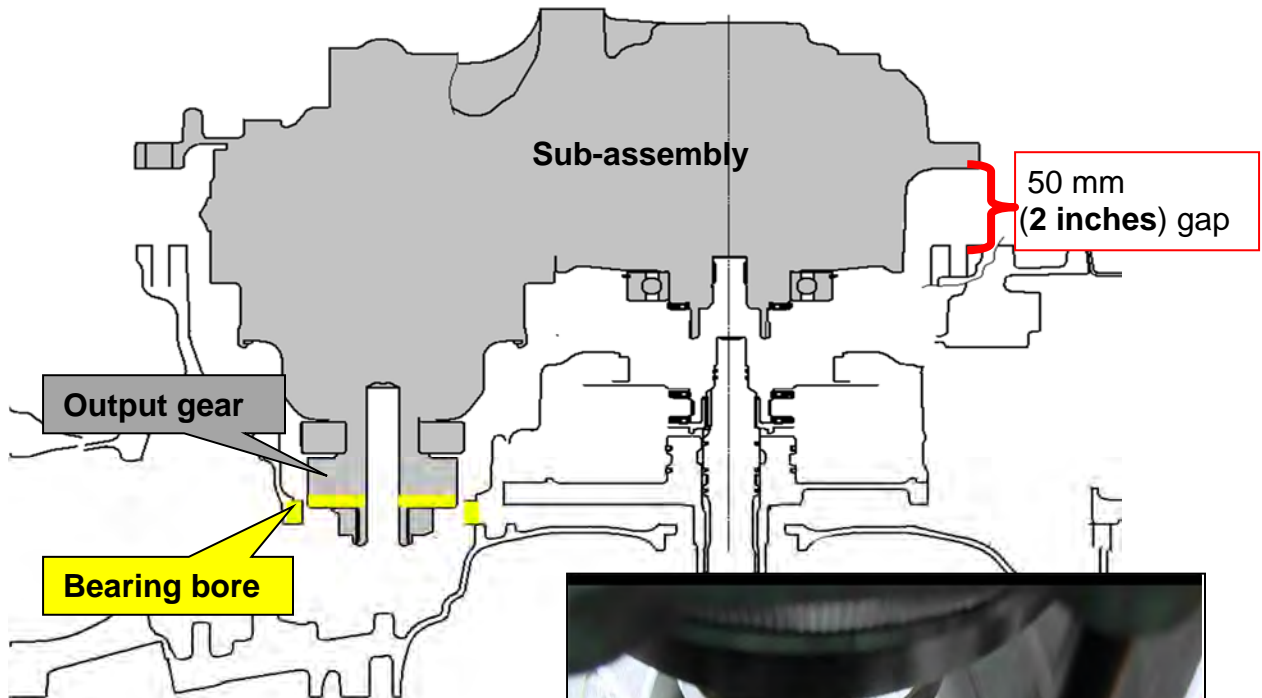

Figure 94

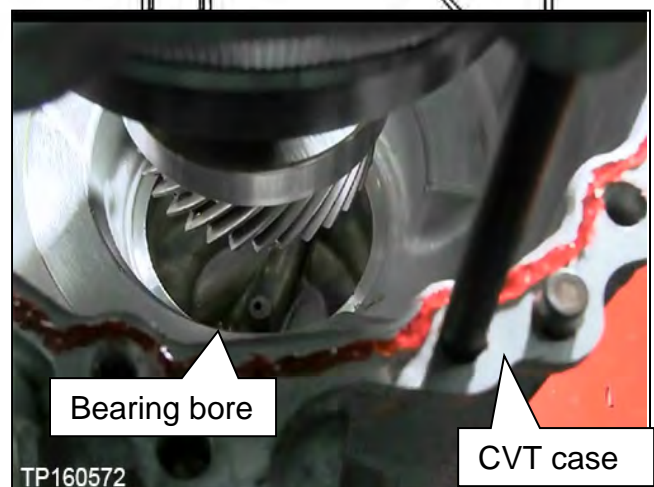



Figure 95

70. Install the parking rod into the parking pawl of the CVT sub-assembly as follows:

IMPORTANT: Perform step 70 while the sub-assembly has a **40 mm gap (1.6 inch)** to the CVT case (Figure 98).

- a. Rotate the shift select lever clockwise on the side of the CVT to adjust the park rod to the highest position.
- b. Use a magnet, or similar tool, to align the parking rod in the CVT case ( in Figure 97) with the opening in the parking pawl ( in Figure 96) in the side cover.

HINT:

- If the parking rod is not located correctly it may keep the case from lowering.
- If the parking rod is not located correctly, the shift select lever will not rotate through all detents (P-R-N-D-L) once the sub-assembly is completely installed.

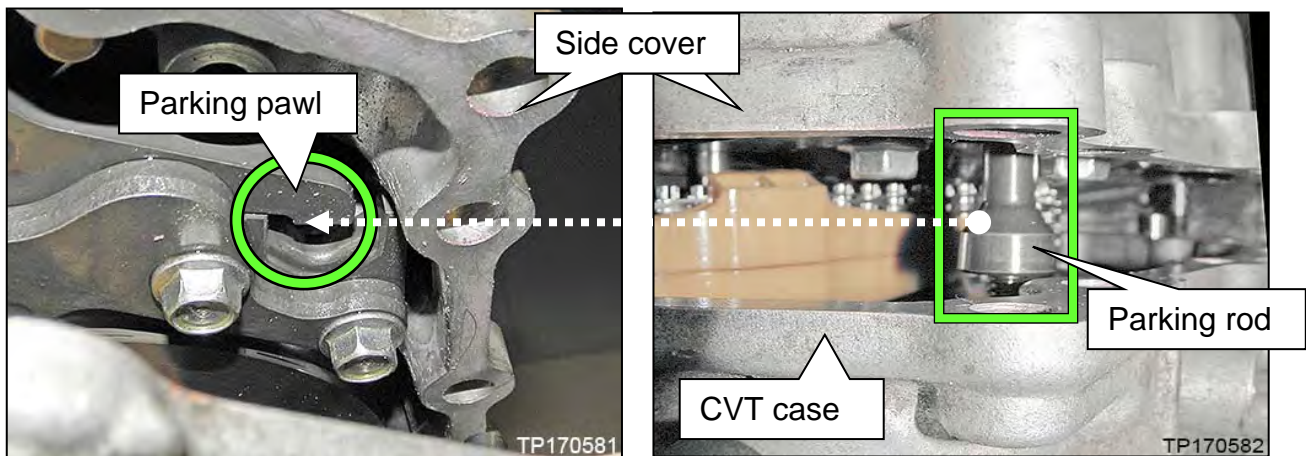

Figure 96

Figure 97

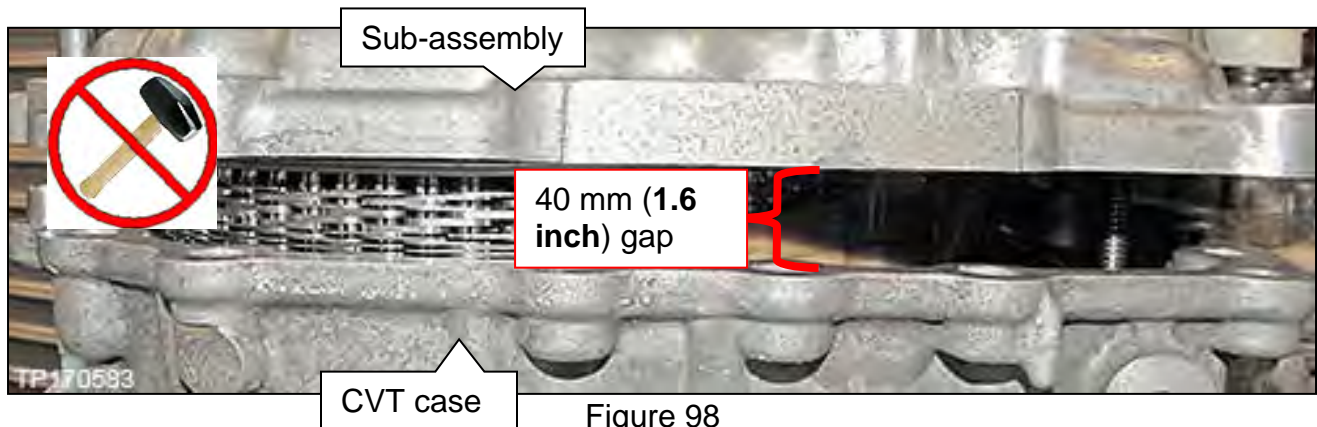

Figure 98

71. Continue to slowly lower the sub-assembly into the CVT case.

- If the primary and the secondary pulley bearings do not align properly with their bores (Figure 99) or are at an angle, a **gap of 18 mm (0.7 inch)** may be present.
- Possible areas of interference are highlighted with orange and tan in Figure 99.
 - As needed, level the sub-assembly as it is lowered into the CVT case to help the primary and the secondary pulley bearings align in their bores.
 - MINOR LEVELING ADJUSTMENTS with limited weight on the sub-assembly will help the installation. **Vertical force is not needed.**
 - Once the sub-assembly is LEVEL the primary and the secondary pulley bearings will smoothly align while lowering.

Sub-assembly will not lower past 18 mm (0.7 inch)?

- If this occurs Do NOT force sub-assembly into case.
 - a. Raise the sub-assembly slightly.
 - b. Level the sub-assembly (visually check the gap between case and sub-assembly side cover and confirm that it is even all around).
 - c. Gently lower the sub-assembly.
 - d. Gently shake the sub-assembly horizontally, lower, raise and repeat as needed to help align.
 - e. Lower to 6 mm (0.25 inch) to clear the dowel pins.

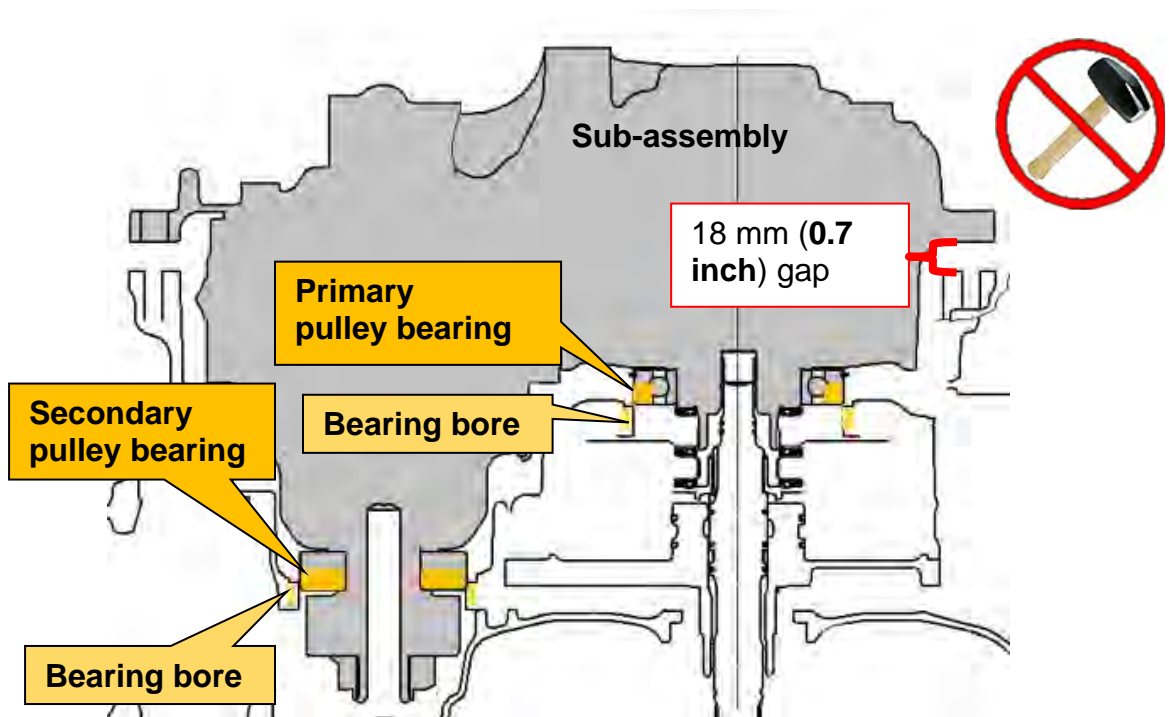

Figure 99

IMPORTANT: In the following steps the case halves must sit flush against each other without a gap before installing the bolts. The bolts CANNOT be used to draw the cases together. DO NOT APPLY VERTICAL FORCE.

72. Once the dowel pins are cleared, ease the sub-assembly down onto the CVT case until the case halves are flush.

- Confirm the dowel pins are clean and aligned and are not catching on the sub-assembly case cover.

NOTICE Be careful not to get fingers caught between the CVT case and sub-assembly when seating.

Sub-assembly will not lower past 5 mm (0.2 inch)?

If the sub-assembly will not lower past **5 mm (0.2 inch)**, the primary pulley splines are interfering with the planetary carrier splines.

- If this occurs Do NOT force sub-assembly into case.
 - a. Raise the sub-assembly slightly to separate the primary pulley and the planetary carrier splines to remove interference.
 - b. Slightly rotate the primary pulley back and forth slowly, through the bottom of the CVT, and then lower the sub-assembly.
 - c. Repeat as needed.

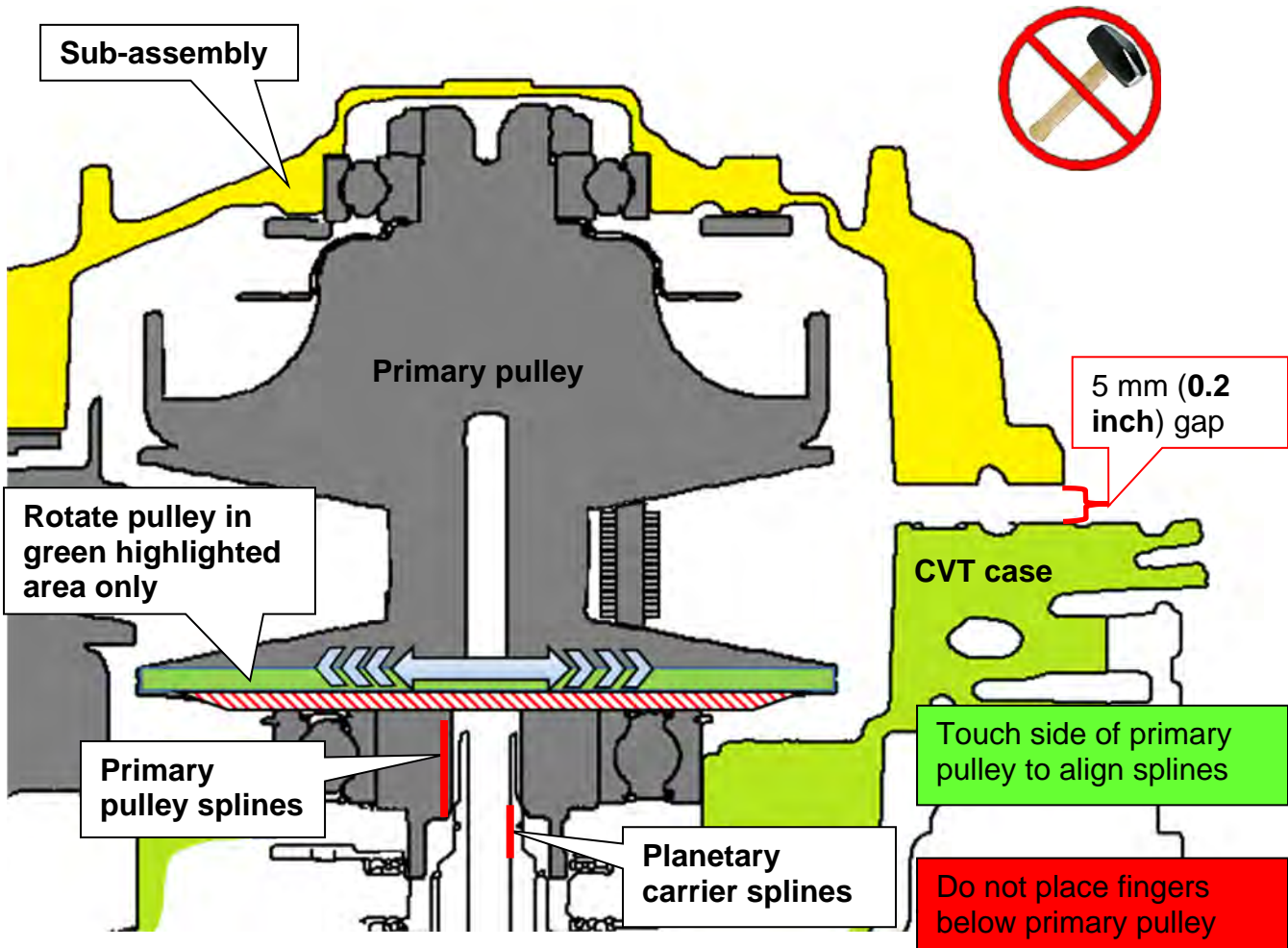

Figure 100

73. Rotate the select lever to “N” range.
- This helps keep the sub-assembly level.

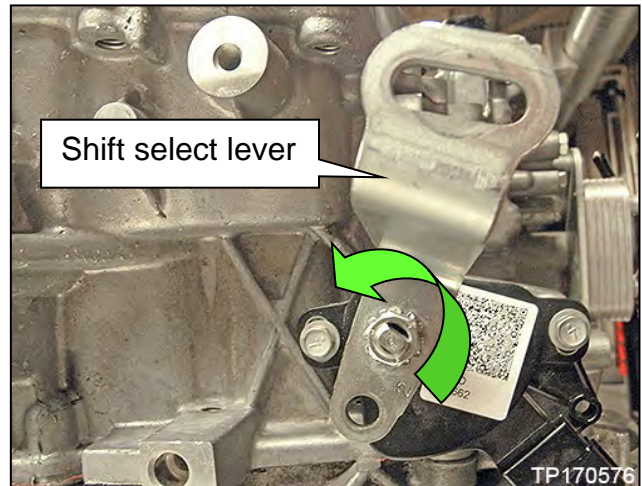

Figure 101

74. Remove the Lifting Fixture from the side cover.
- Loosen the wing nuts.
 - Unthread the tool from the pulley brackets.

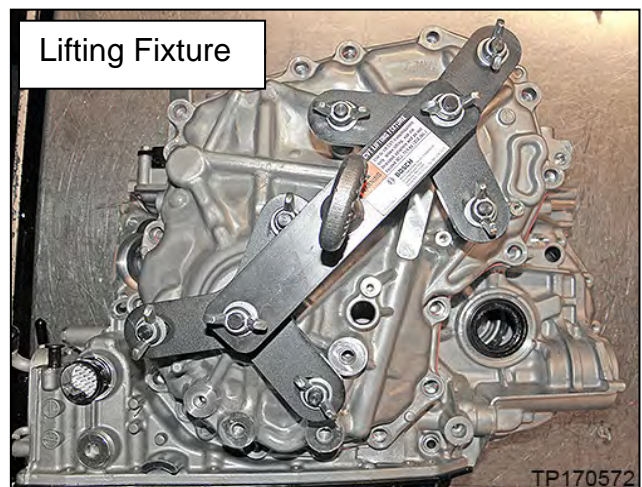

Figure 102

Remove Side Cover and Install Lubrication Caps

IMPORTANT: In the following steps, use only a slide hammer and hands to separate the side cover.

In the following steps, if the side cover does not easily lift off by hand  it is still seated on the pulley bearings and must first be completely separated.

Do NOT use tool J-52275 at this time.

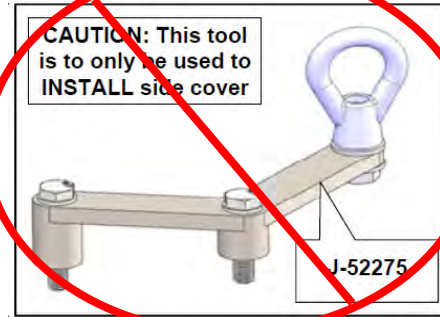

75. Install two Pulley Bracket Guide Pins (J-52272).

- The bracket guide pins will be used as a height marker of the pulleys to ensure they remain seated in the case as the side cover is removed.

76. Use slide hammer (J-25721-A) with J-hook case separator (J-51923) and evenly separate the side cover from the belt and pulley assembly.

- Alternate between the three hooking locations on the side cover until the side cover separates from the pulleys (see page 37 Figure 81).
 - As the side cover is raised up, the exposed height of the pulley guide pins will shorten. This is an indicator that the pulleys are remaining seated in the CVT case.
 - Make sure the side cover is completely separated from the pulley bearings.
 - Once the side cover is separated from pulley bearings, it will rock freely and can be easily lifted by hand.

IMPORTANT: Use only a slide hammer and hands to separate the side cover from the pulleys.

77. Lift off the side cover by hand.

HINT: The side cover weighs 9 lbs.

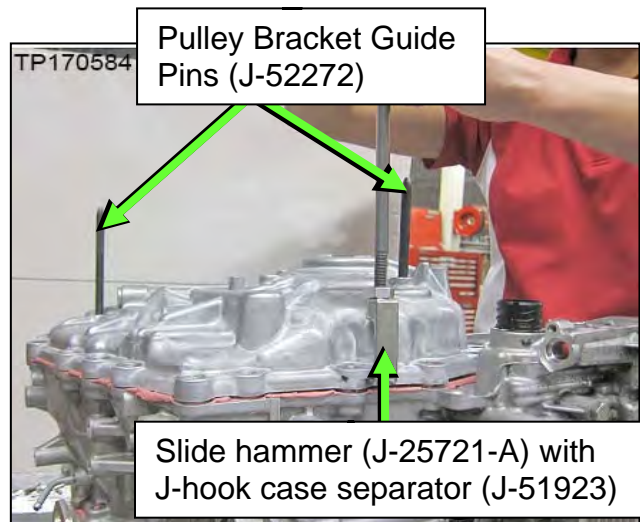

Figure 103

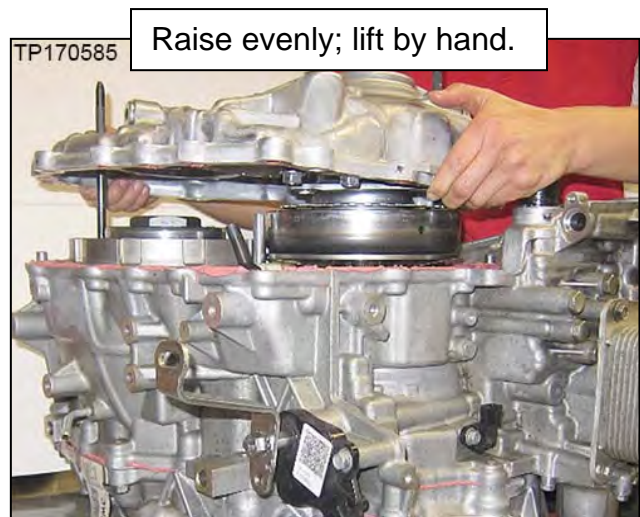

Figure 104

78. Install two (2) new lubrication caps (see **PARTS INFORMATION**) shown in Figure 105 onto the tubes of the CVT case shown in Figure 106 as follows:
- Insert the lubrication caps through the slots in each chain guide.
 - Face the larger side of the “wedge shaped index guide” away from the pulleys.
 - Gently push each lubrication cap down into the square cut seat of the CVT case tubes.

HINT: Slightly rotating the lubrication caps will help in aligning them into the square cut seats.

IMPORTANT: Confirm that the caps are installed in the correct orientation.

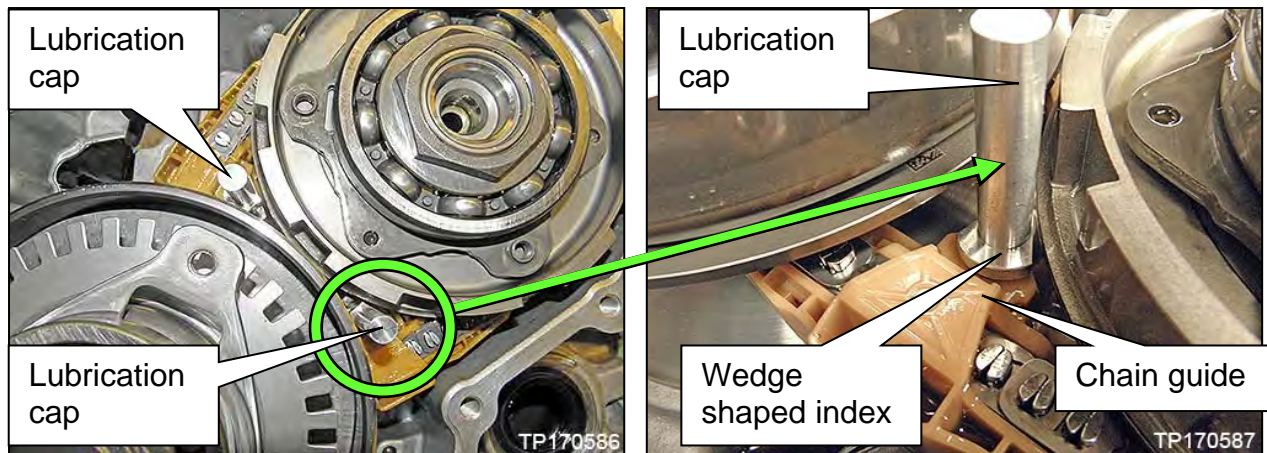

Figure 105

Figure 106 shows the pulleys and chain removed to illustrate how the lubrication caps attach to the CVT case tubes and is for reference only.

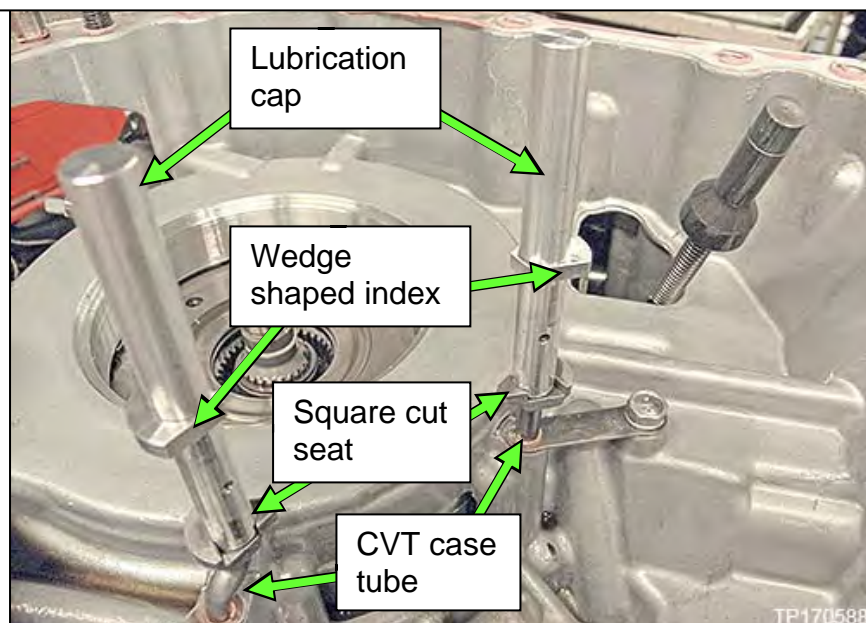

Figure 106

79. Confirm two Pulley Bracket Guide Pins (J-52272) are in place.
- One guide pin to each pulley bracket.
 - The guide pins can be installed into any of the three bolt holes.

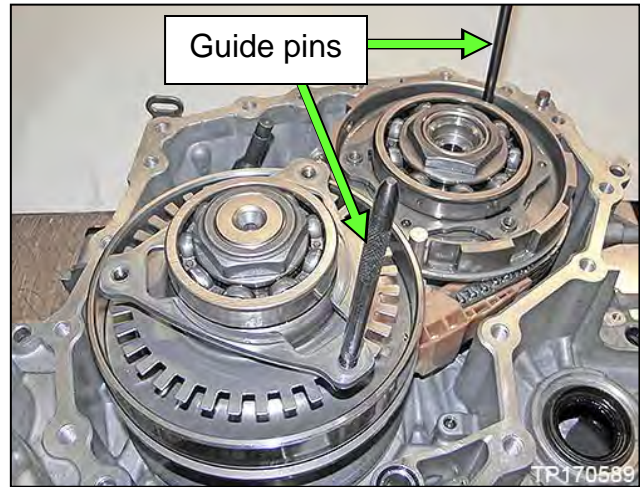

Figure 107

80. Rotate each bracket to align with holes in the case as shown in Figure 108.

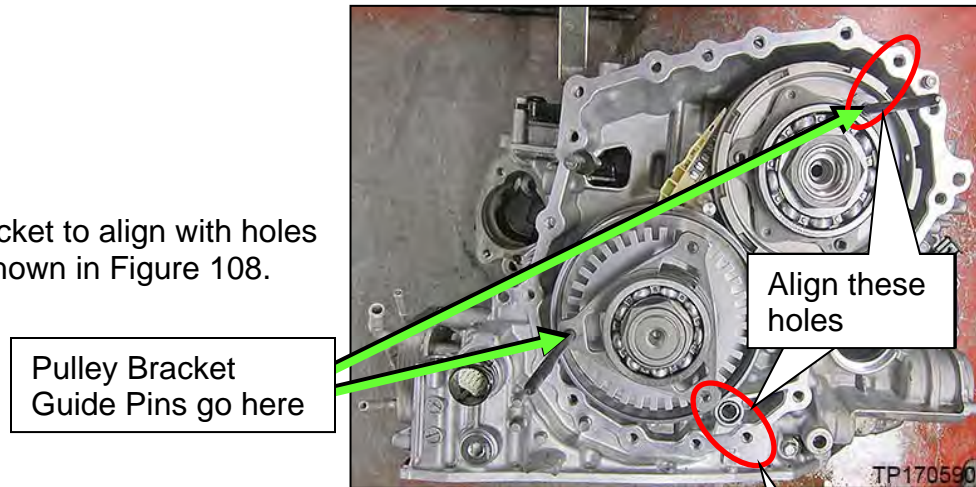

Figure 108

81. Install a new O-ring.
- Apply CVT fluid to the O-ring before installation.
 - Press down completely into the machined groove.
- HINT:** Do not re-use the old O-ring.

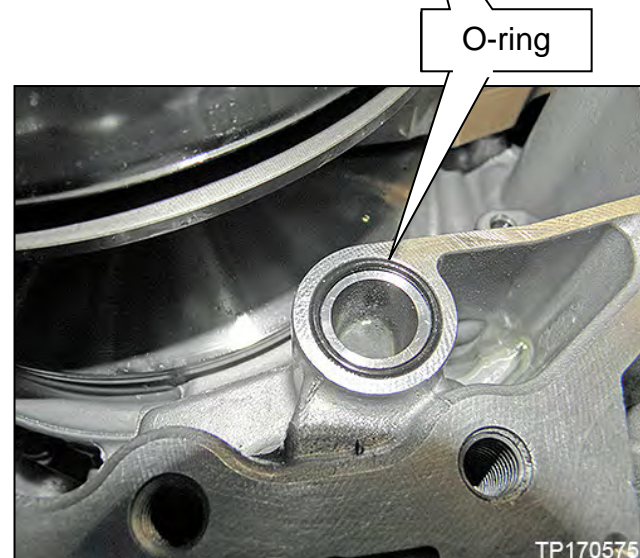

Figure 109

82. Confirm that the shim and the lathe cut seal, on the underside of the side cover, stay in place.

- The shim is located in the secondary pulley bearing bore.
- The lathe cut seal is located in the center of the same bearing bore.

HINT: Apply petroleum jelly or equivalent as needed to keep the shim and lathe cut seal in place while lowering the side cover to the CVT.

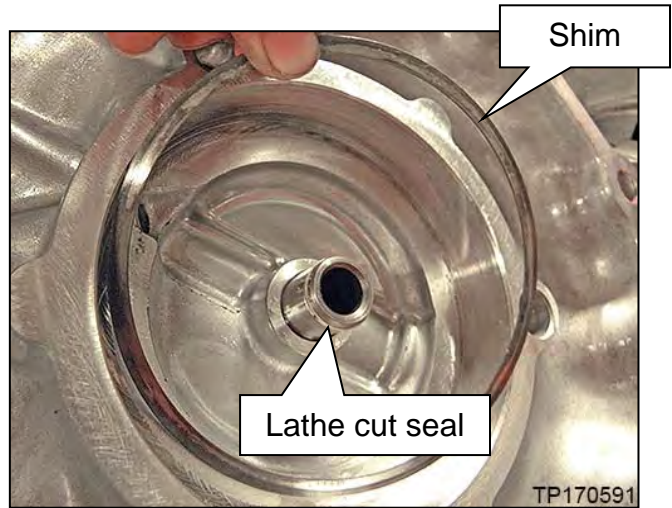

Figure 110

Install Side Cover

83. Install the Side Cover Alignment Aid (#J-52275), with two (2) bolts hand tight.

HINT: The Alignment Aid will assist with level installation and help keep integrity of sealant until the case halves are flush against one another.

84. Lift side cover with suitable lifting tool and confirm that the underside case mating surface is clean.

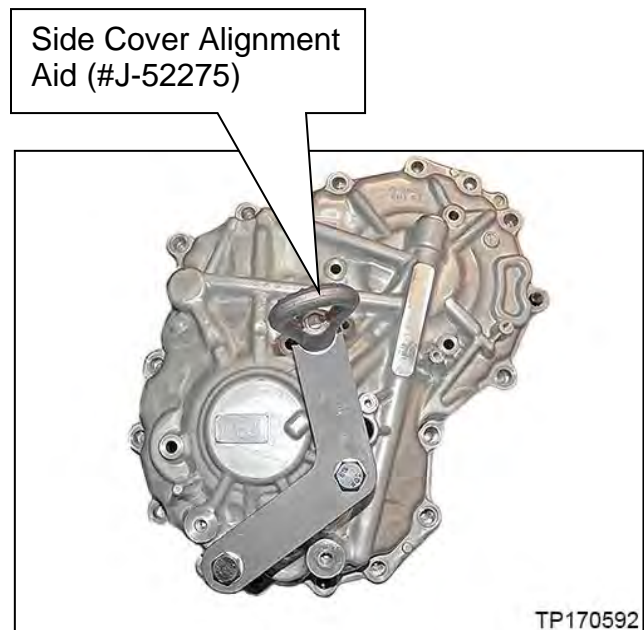

Figure 111

85. Apply one continuous 2.0 mm diameter bead of sealant along the center of the CVT case side mating surface (Figure 112).

Sealant:

- Loctite 5460 (See the **PARTS INFORMATION** section of this bulletin.)
- Color: Pink

IMPORTANT:

- Confirm that the mating surfaces are clean before applying sealant.
- Make sure that the starting point and the ending point of the sealant is between two bolt holes. Overlap both ends of the bead by 3 – 5 mm.
- If the Guide Pins were removed to clean the case surfaces, reinstall them now.

HINT: Be careful not to contact or contaminate the sealant. If the sealant has been disturbed or contaminated in any way before case assembly, remove the sealant completely and re-apply.

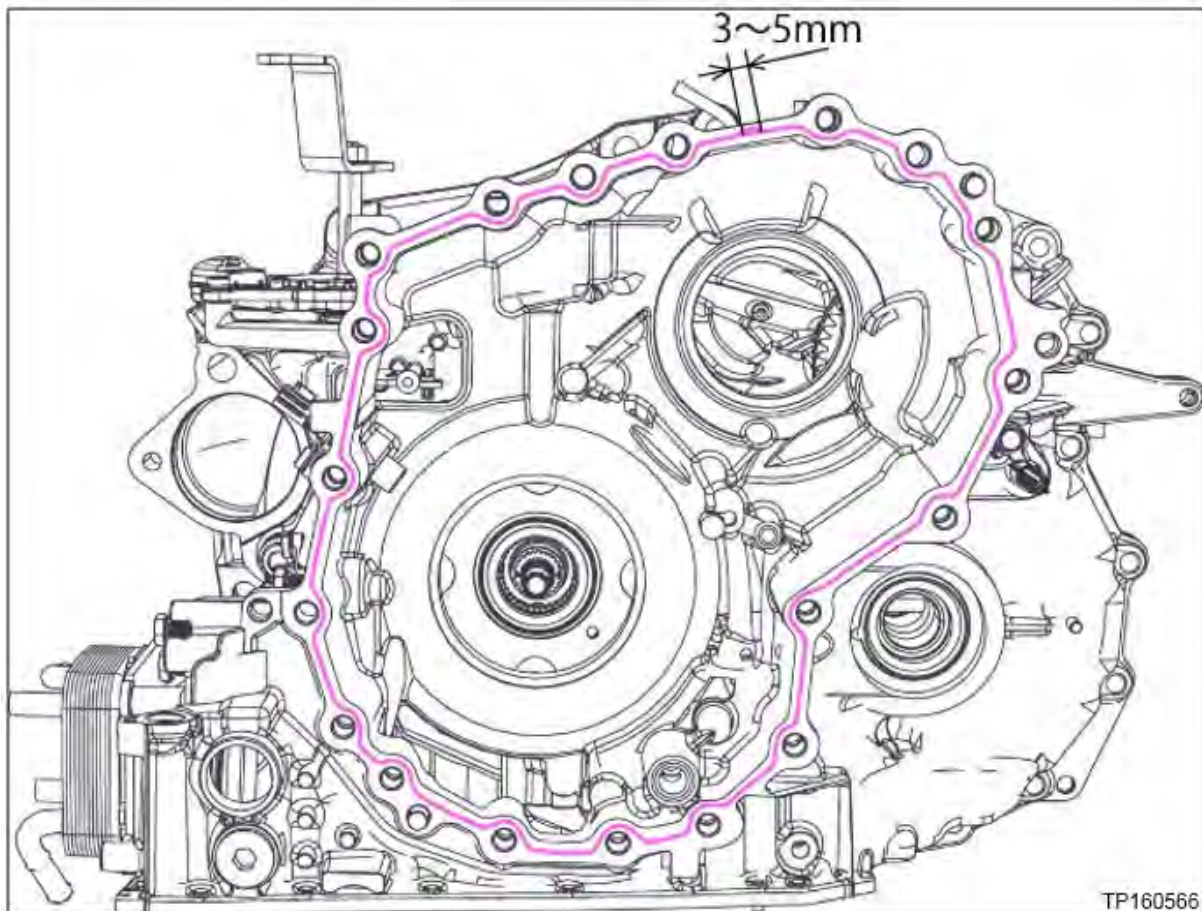

Figure 112

86. Rotate the manual lever clockwise to the “P” range to set the parking rod at the highest position.

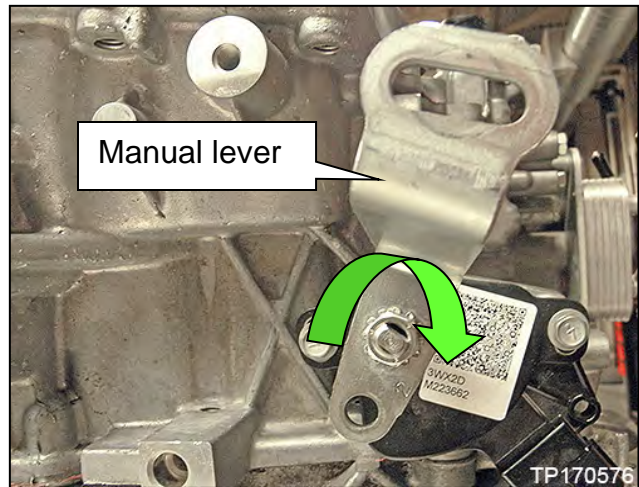

Figure 113

87. Install the CVT Assembly Guide Pins (#J-51959).

IN THE FOLLOWING STEPS IF THE SIDE COVER DOES NOT LOWER COMPLETELY,  PHYSICAL INTERFERENCE IS PRESENT.

HINT: Before installing side cover read steps 88-91.

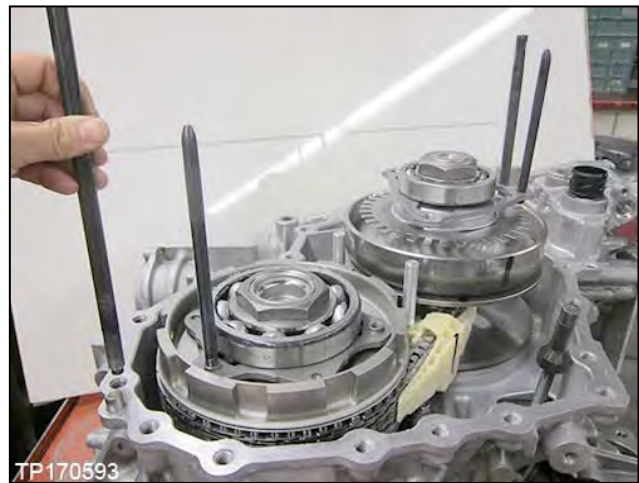

Figure 114

88. Install the side cover to the CVT case.
- Route each of the 4 guide pins from under the side cover through their respective bolt holes.
 - Lower the side cover until the parking rod can be aligned with parking pawl and then proceed to step 89 on the next page.

- See Figure 116 on page 54.

IMPORTANT:

- Keep the side cover as level as possible during installation.
- To assist with proper pulley positioning, confirm the CVT is on a flat surface.
- Do not use excessive vertical force to install.



Figure 115

89. Install the parking rod into the parking pawl of the CVT side cover as follows:

IMPORTANT: Perform step 89 while the side cover has a **38 mm gap (1.5 inch)** to the CVT case (Figure 118).

- a. Rotate the shift select lever clockwise on the side of the CVT to adjust the park rod to the highest position.
- b. Use a magnet, or similar tool, to align the park rod in the CVT case (□ in Figure 117) with the opening in the parking pawl (○ in Figure 116) in the side cover.

HINT:

- If the parking rod is not located correctly it may keep the side cover from lowering.
- If the parking rod is not located correctly, the shift select lever will not rotate through all detents (P-R-N-D-L) once the side cover is completely installed.

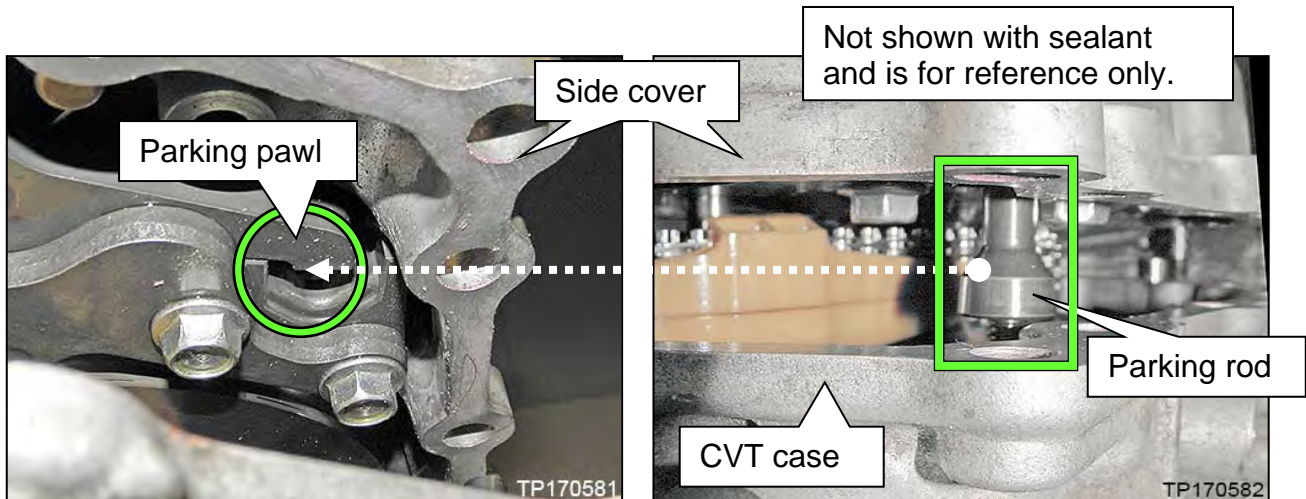
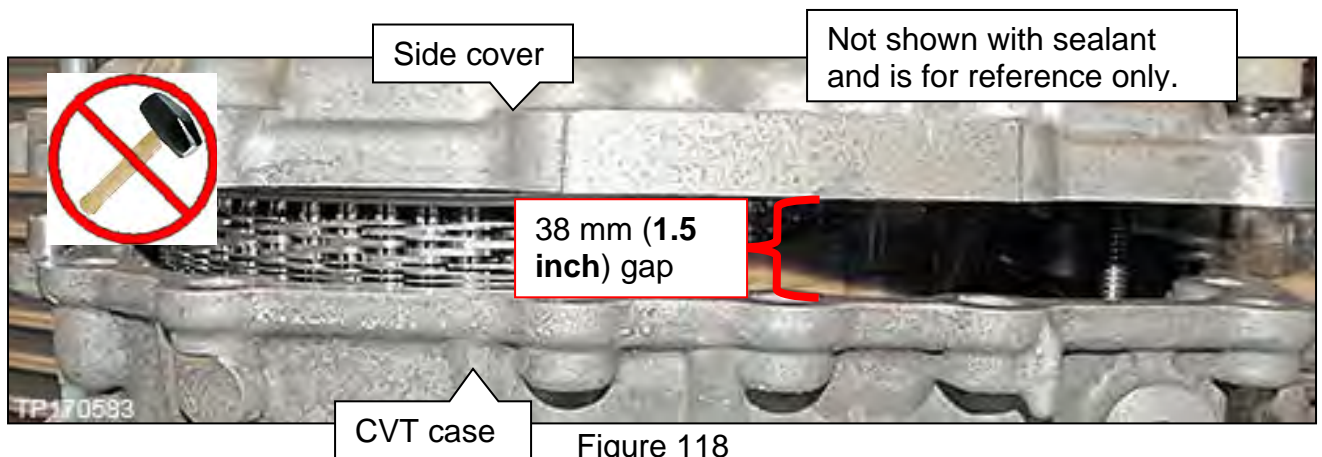

Figure 116

Figure 117



CVT case

Figure 118

90. Using your hand, press down on the side cover over each of the pulley bearings to level and seat the side cover.

IMPORTANT: The side cover will not be fully seated at this step.

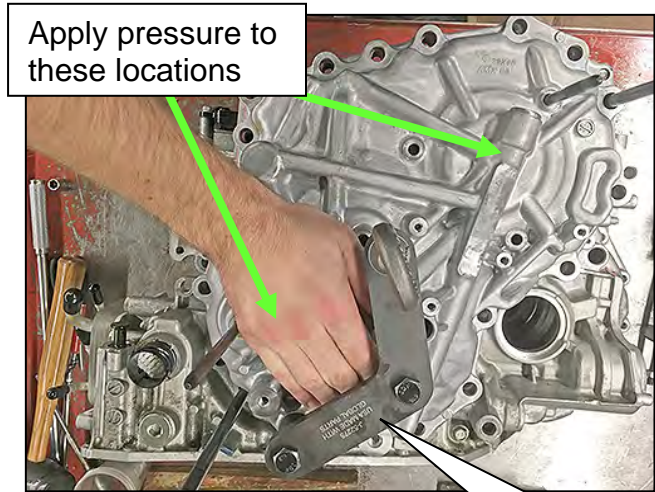

Figure 119

Side Cover Alignment Aid (# J-52275)

91. Rotate the manual lever to the “N” position.

92. Remove the Side Cover Alignment Aid (# J-52275) shown in Figure 119.

HINT: Figure 120 shown with Side Cover Alignment Aid removed.

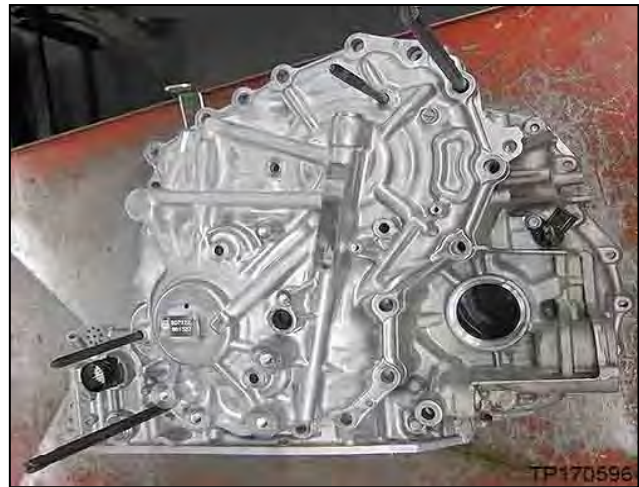

Figure 120

93. Continue to lower the side cover until it is flush with the CVT case.
- Use a plastic hammer or rubber mallet, if the side cover is caught, and gently tap evenly around the top of the side cover to help seat.

IMPORTANT:

- Side cover must be completely seated.
- Bolts cannot be used to draw case halves together.
- Do NOT use metal hammers or mallets.
- If it is necessary to unseat the side cover assembly, use a slide hammer and then restart from step 83 on page 51.
- Do NOT pry with a screw driver.

94. Remove the two (2) CVT Assembly Guide Pins (# J-51959).
- Leave the Pulley Bracket Guide Pins in place.
95. Install the sub-assembly side cover with nineteen (19) new side cover bolts to the CVT case (Figure 121).
- IMPORTANT:** Do not reuse the original side cover bolts.
- Torque the first eight (8) bolts marked as ● in the sequence numbered in Figure 121 below, and then torque the rest of the bolts in a clockwise manner.
 - Bolt torque: 45 N•m (4.6 kg-m, **33 ft-lb**) 19 pieces.

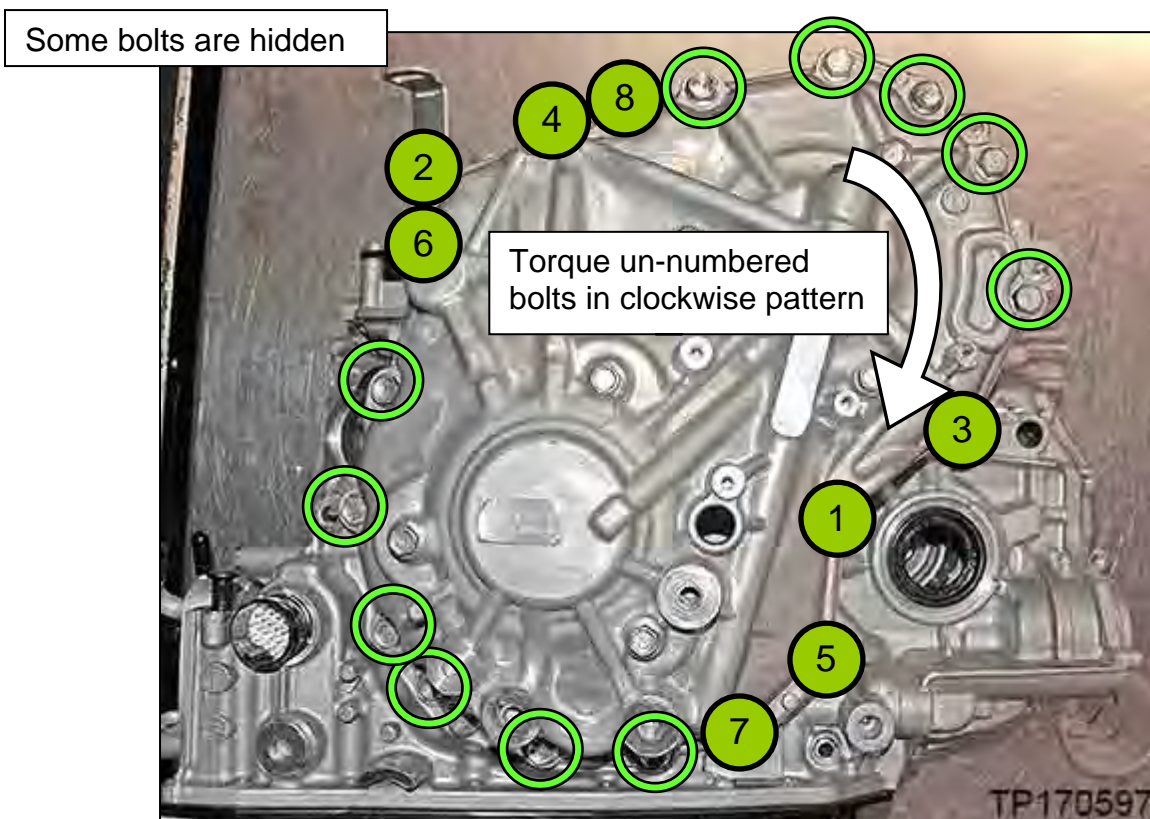

Figure 121

96. Install six (6) new O-rings from **PARTS INFORMATION** to the six (6) new pulley bearing retainer bolts that were removed from the new sub-assembly on page 39, step 64.

97. Install the new pulley bearing retainer bolts to secure the pulleys and side cover.
- Install four (4) bolts first, hand tight.
 - Remove two (2) guide pins from the pulley bracket.
 - Install the last two (2) bolts with O-rings, hand tight.

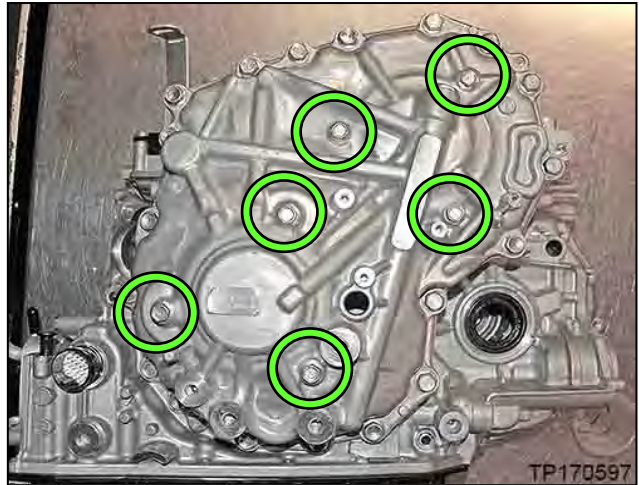

Figure 122

98. Confirm the parking rod operates correctly as follows:
- Rotate the shift select lever counterclockwise and confirm that all detents for each of the P-R-N-D-L are felt.
 - Rotate the lever clockwise to return the rod back to the **P** position.
 - Are all of the detents felt?
 - **YES:** Proceed to step 99.
 - **NO:** If the lever does not rotate or if all detents are not felt:
 - Remove the sub-assembly side cover and then remove sealant.
 - Restart from step 83 on page 51.

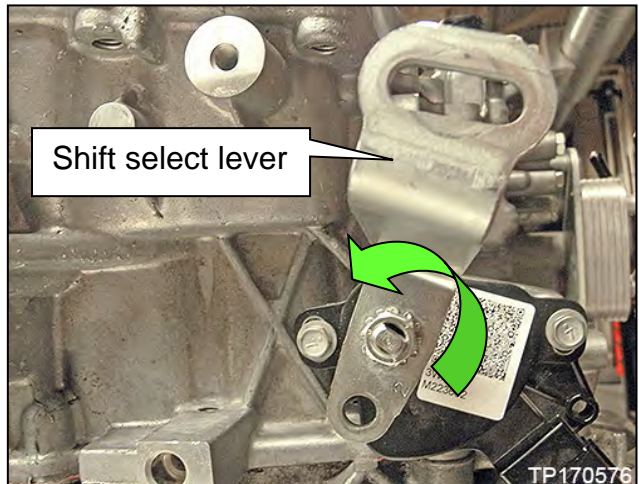

Figure 123

99. Confirm the rotational smoothness of the primary pulley as follows:

- a. With a clean hand, access the primary pulley from the bottom of the CVT to rotate.
- b. Rotate the primary pulley by hand and confirm that the characteristic is the same as previously checked at step 51 (page 34), prior to removing the original sub-assembly.

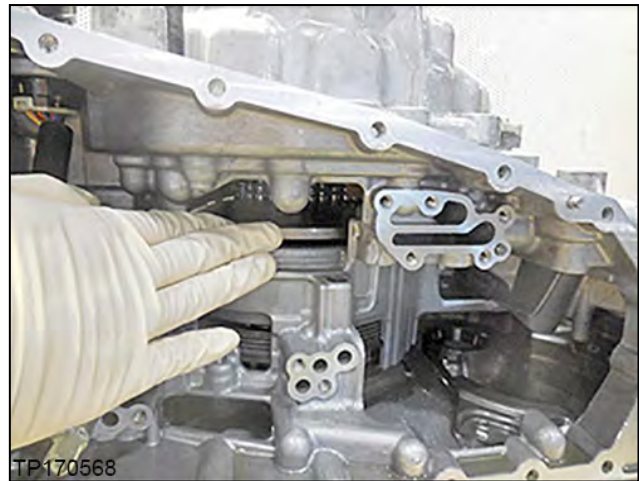

Figure 124

- c. Is the rotational characteristic “the same” (**OK**) or “worse than before the sub-assembly was replaced” (**NG**)?
 - o **OK:** The rotational characteristic is the same or better; proceed to step 100.
 - o **NG:**
 - 1) Remove the 19 case bolts and 6 pulley bracket bolts. Refer to page 35 steps 52 and 53.
 - 2) Install the 2 Pulley Bracket Guide Pins (J-52272). Refer to page 48 step 75.
 - 3) Remove the side cover.
 - 4) Remove the 2 lubricating caps.
 - 5) Remove the silicone from the sealing surfaces.
 - 6) Reinstall the side cover and then remove the Pulley Bracket Guide Pins.
 - 7) Restart sub-assembly installation from Step 54 on Page 36.
 - 8) Recheck rotational characteristics.

100. Torque all six (6) bolts.

- Bolt torque:
28 N•m (2.8 kg-m, **20 ft-lbs**).



Figure 125

101. Install the CVT case side axle seal (Figure 126).

- Use Seal Installer J-52283 and Driver Handle J-8092.
- Apply a light coat of CVT fluid to the seal lip surfaces.

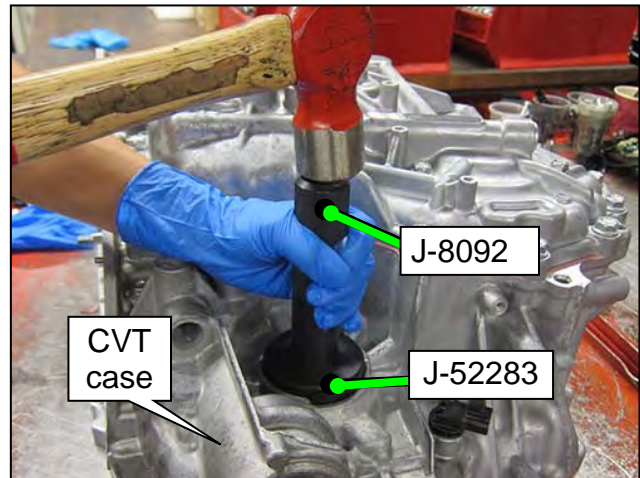

Figure 126

102. Place the CVT on the work bench with the side cover facing down on the bench.

103. Remove the converter housing which was temporarily installed with three bolts.

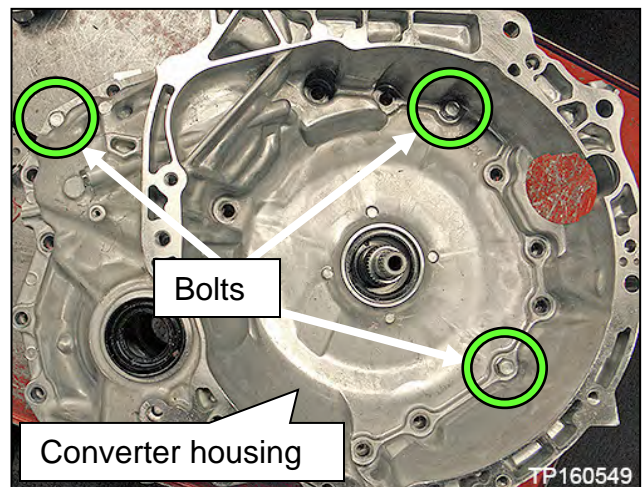

Figure 127

104. Unbolt the three (3) bolts holding the dummy cover and then remove the dummy cover.

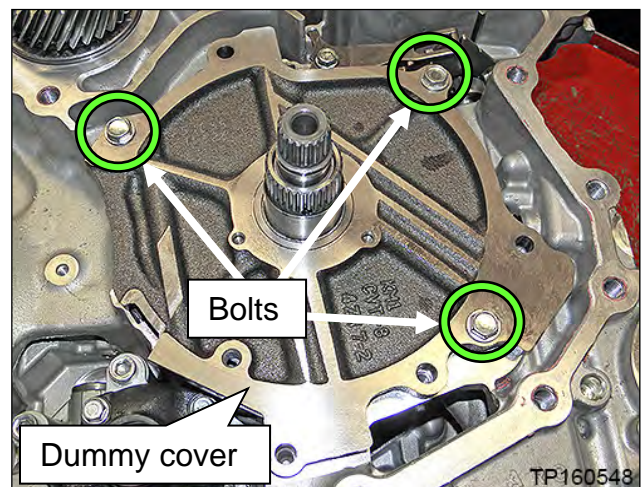

Figure 128

Depth Gauge “Zero” Procedure

IMPORTANT: The Depth Gauge MUST be set to “zero” before performing measurements in the following **SERVICE PROCEDURE**.

Measurement tools:

- Gauge Block (straight bar)
- Depth Gauge (Digital Vernier scale) with a datum level (accuracy: 0.01 mm)

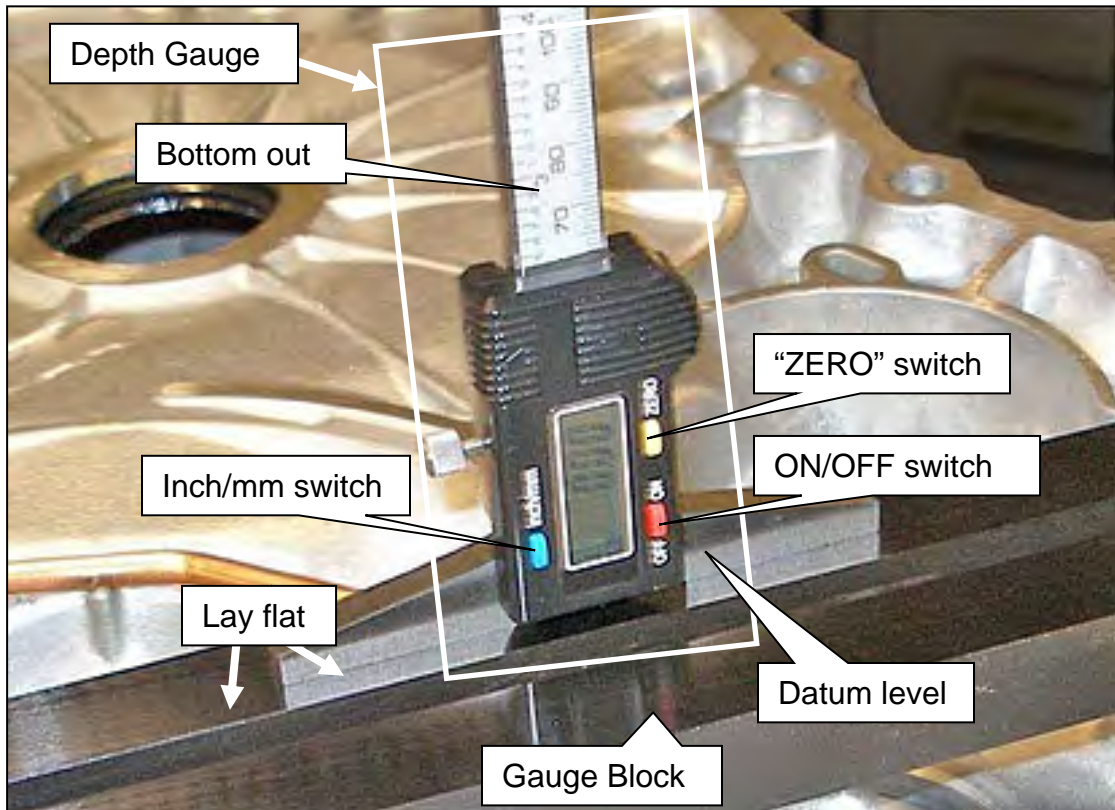

Figure 129

Depth Gauge Calibration

To calibrate the Digital Depth Gauge J-50272:

- a. Turn the Depth Gauge ON and set it to “mm” measurement.
- b. Place the Depth Gauge’s datum level flush on top of the Gauge Block.
- c. Carefully slide the depth marker down until it bottoms out on the Gauge Block.
- d. With the depth marker bottomed out, press the “ZERO” switch.
 - o The Depth Gauge’s display should now read 0.00 mm.

HINT:

- Push (extend) the depth marker to the gauge block to correctly zero.
- Do not use the gauge block to push (retract) the depth marker up to the datum point.

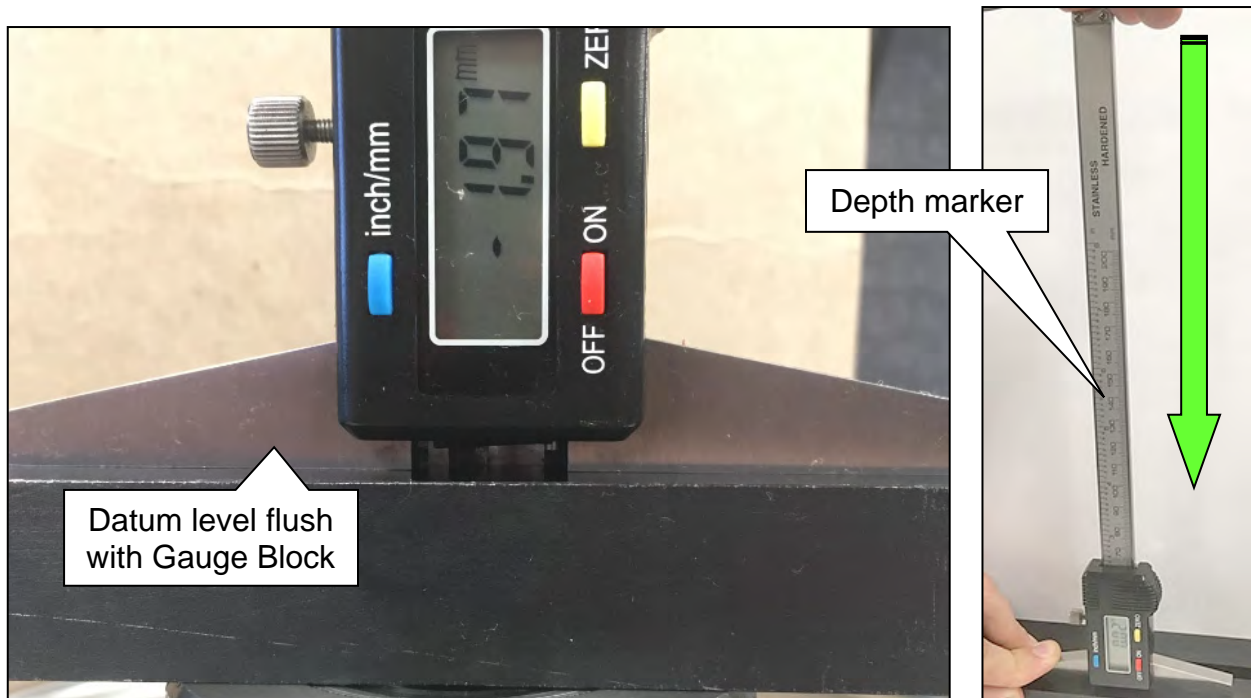

Figure 130

Pages 62-66 are for Type 1 Thrust Bearing ONLY. Proceed to page 67 if working with Type 2 Thrust Bearing (with bearing race).

Type 1 CVT: Clutch Total Endplay Adjustment – Thrust Bearing Selection

IMPORTANT: The clutch total endplay (Figure 131) must always be adjusted when a new sub-assembly is installed.

- The Type 1 CVT uses the thrust bearing thickness between the clutch drum of clutch assembly and the dummy cover to adjust the total endplay.

Thrust Bearing Selection

There are eight (8) thicknesses of thrust bearings available for total endplay adjustment.

- For additional information, see video # 547: “CVT Belt and Pulley Replacement” and fast forward to minute marker 13:10. This video is located under the TECH TRAINING GARAGE VIDEOS tab in Virtual Academy.

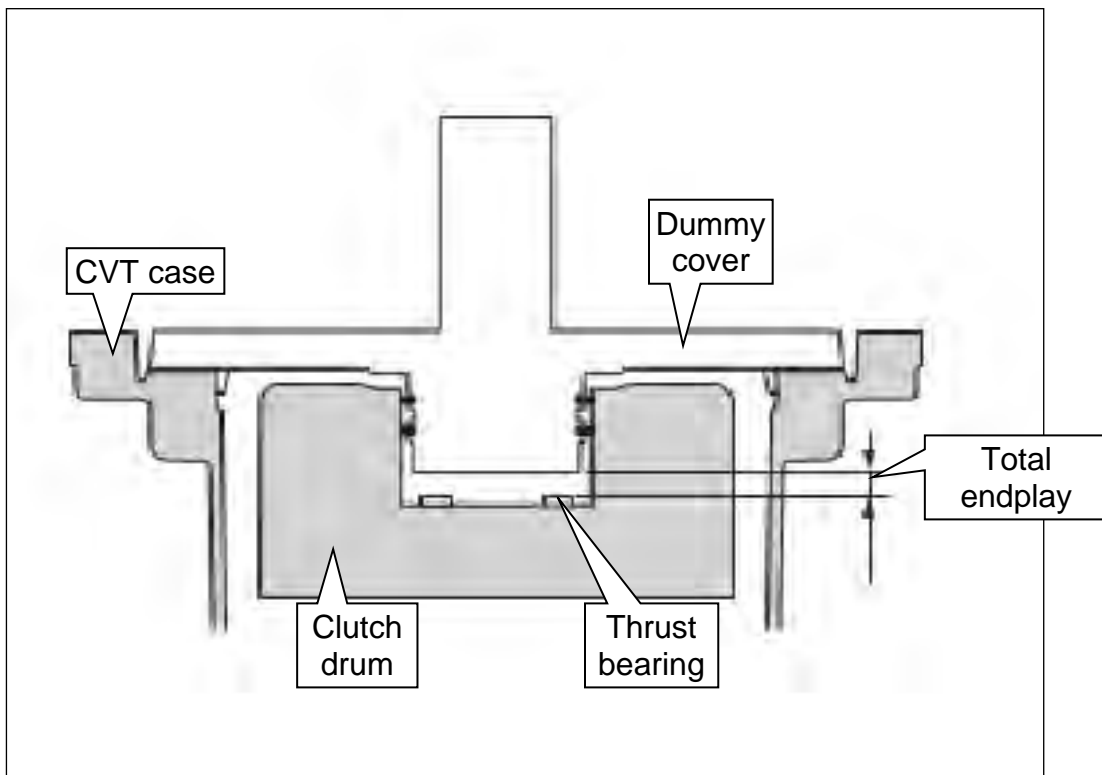

Figure 131

105. Clean and then zero the Digital Depth Gauge (part #: J-50272). See pages 60-61.

- Set Digital Depth Gauge to millimeters.

106. Clean Gauge Block J-50271.

107. Confirm that the CVT case and the dummy cover mating surfaces are clean.

108. Calculate the “average clutch assembly bore depth” (**D**) shown in Figure 132 as follows:

IMPORTANT: Measurements are required from two opposite ends to obtain the average.

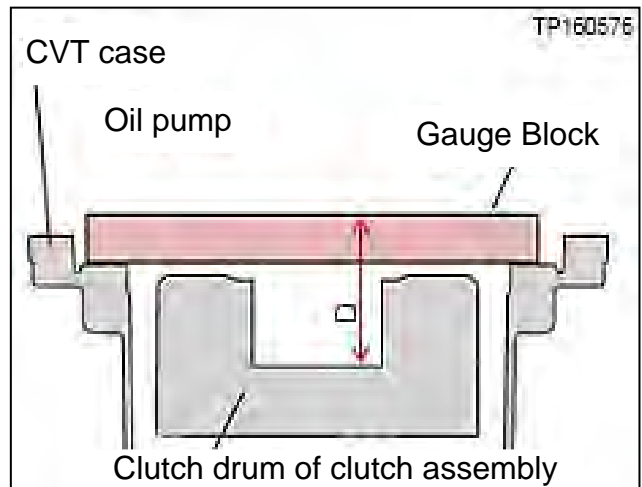

Figure 132

- a. Position the Gauge Block over the clutch assembly bore on the surface where the dummy cover seats (Figure 133).

IMPORTANT: This surface is lower than the CVT case to torque converter housing surface.

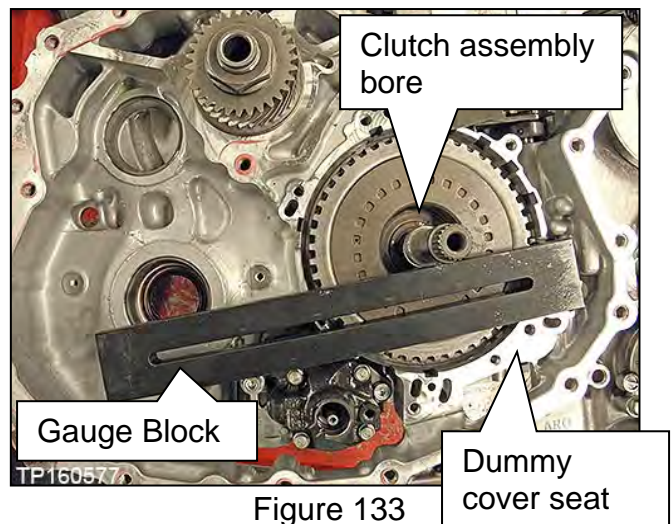

Figure 133

- b. Confirm the Gauge Block is not sitting on the clutch assembly or against the input shaft.

HINT:

- The clutch assembly should sit 1-3 mm lower than the dummy cover seat (Figure 134).
- If the clutch assembly is sitting higher than the dummy cover surface, see **TROUBLESHOOTING The Dummy Cover Will Not Sit Flush** on page 107.

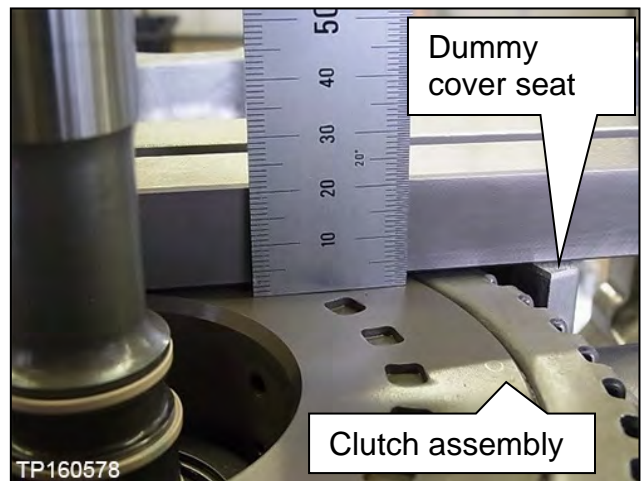

Figure 134

- c. Position the Depth Gauge on the Gauge Block (Figure 135).

HINT: Make sure the Depth Gauge's datum level is flush with the top of the Gauge Block.

- d. Carefully slide the gauge down until it bottoms out on the bottom of the clutch assembly bore. Write this measurement as **D1** (use millimeters).

HINT: Do not measure from the clutch assembly bore shown in red (Figure 136).

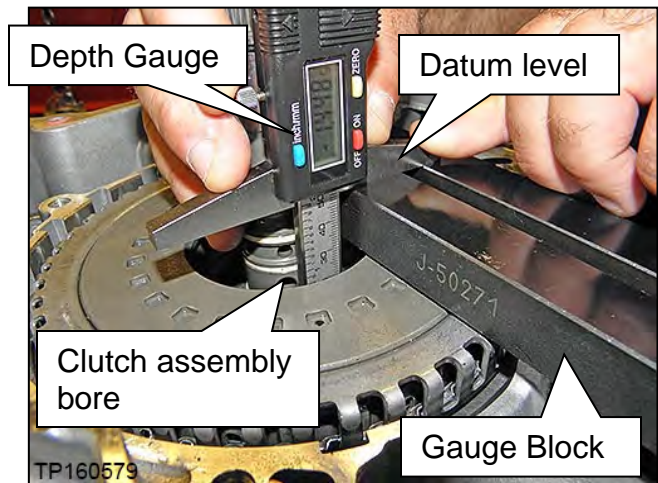

Figure 135

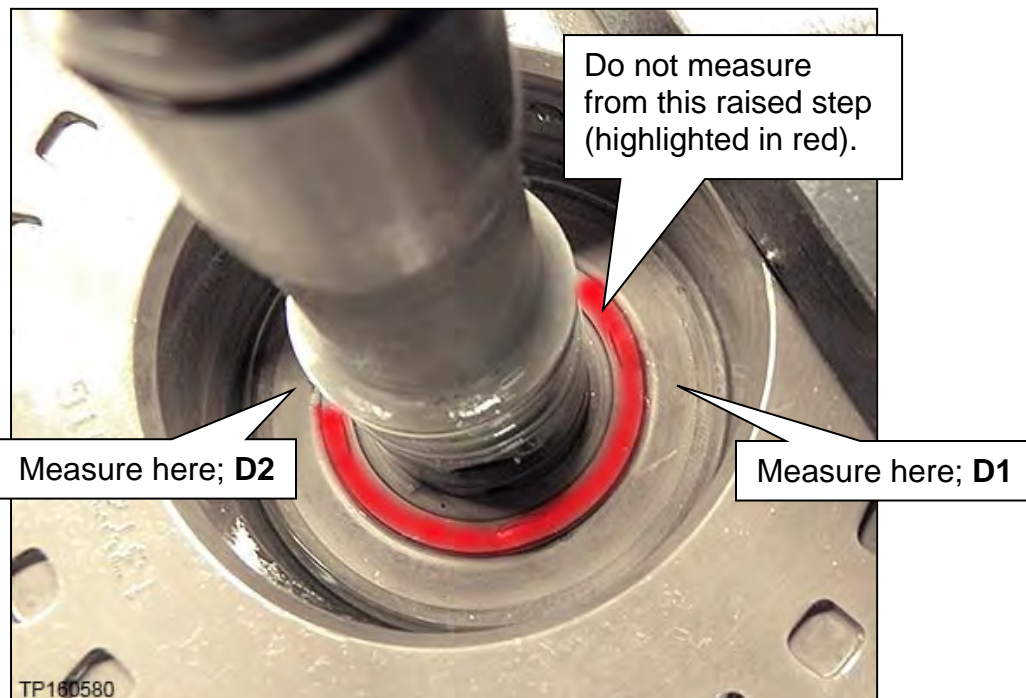

Figure 136

- e. Measure this same distance on the opposite side (180 degrees) of the clutch assembly bore and write it as **D2**.
- f. Using the formula below, calculate the average and write down the calculated value as **D**.

$$D = \frac{(D1 + D2)}{2}$$

Write the measurement for "D" here _____ mm

109. Measure the average (**H**) dummy cover height (Figure 138) as follows:

- a. Clean the dummy cover surfaces that contact the CVT case and thrust bearing (Figure 137).

IMPORTANT: Use brake cleaner (or equivalent) and a lint-free towel only. Make sure the brake spray or solvents used are compatible with local regulations.

- b. Place the dummy cover upside down on a work bench, and place the Gauge Block onto the thrust bearing surface (Figure 138).

- c. Position the Depth Gauge on the Gauge Block over an outer end of the dummy cover (Figure 138).

HINT: Make sure the Depth Gauge's datum level is flush with the top of the Gauge Block.

- d. Carefully slide the Depth Gauge down until it contacts the dummy cover surface that mates with the CVT case. Write this measurement as **H1** (use millimeters).

- e. Measure this same distance on the opposite side of the dummy cover and write as **H2** (Figure 138).

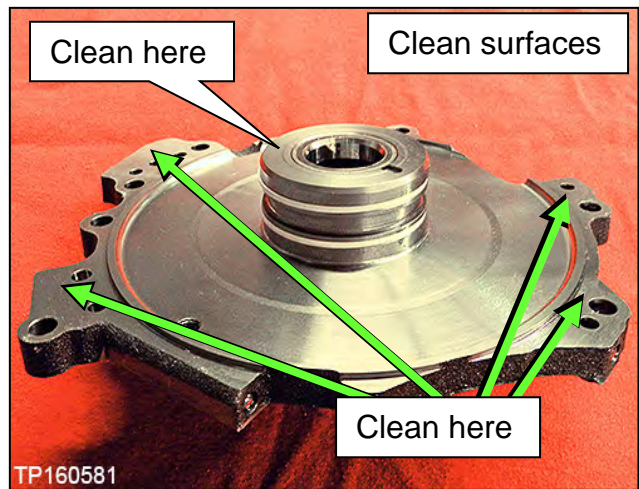

Figure 137

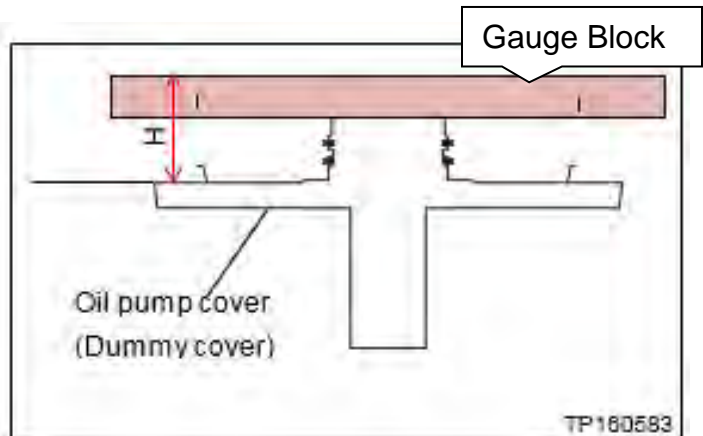
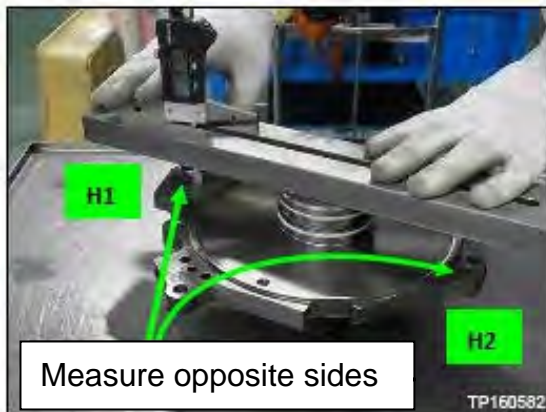

Figure 138

- f. Using the formula below, calculate the average and then write down the calculated value as **H**.

$$H = \frac{(H1 + H2)}{2}$$

Write the measurement for "**H**" here _____ mm

110. Choose the thrust bearing to adjust Clutch Total Endplay (**A**) as follows:

- a. Calculate **A** (Total Endplay):

Total Endplay A = D – H (This will be the thrust bearing thickness).

- o Fill in the measurements below for "**D**" and "**H**" from pages 64 and 65 to calculate for "**A**".

D measurement _____ mm
– H measurement _____ mm
= A _____ mm

Please print this page and attach it to the repair order.

- b. Choose the appropriate bearing from **Table A** below, based on **A** (eight different thicknesses of thrust bearings are available).

Example: If **A** = 4.3 mm, it falls between the lower and upper clearances for bearing thickness 3.93 mm.

- o Refer to **PARTS INFORMATION** for Thrust Bearing part numbers by thickness.
- c. Measure and confirm that the selected thrust bearing is the correct thickness before installing (Figure 139).

Table A

PART #: 31407-	A = D - H CLEARANCE (A)	BEARING THICKNESS
1XZ0B or X270A	3.87 - 4.06 mm	3.57 mm
1XZ0C or X270B	4.07 - 4.22 mm	3.75 mm
1XZ0D or X270C	4.23 - 4.42 mm	3.93 mm
1XZ0E or X270D	4.43 - 4.57 mm	4.1 mm
1XZ1A or X270E	4.58 - 4.77 mm	4.28 mm
1XZ1B or X271A	4.78 - 4.93 mm	4.46 mm
1XZ1C or X271B	4.94 - 5.08 mm	4.61 mm
1XZ1D or X271C	5.09 - 5.29 mm	4.79 mm



Figure 139

111. Install the thrust bearing flush to the clutch assembly bore as shown in Figure 140.

- Install thrust bearing in area shown in green so that it is centered by the four tabs.

HINT: The thrust bearing has two sides. See image below for appropriate orientation.

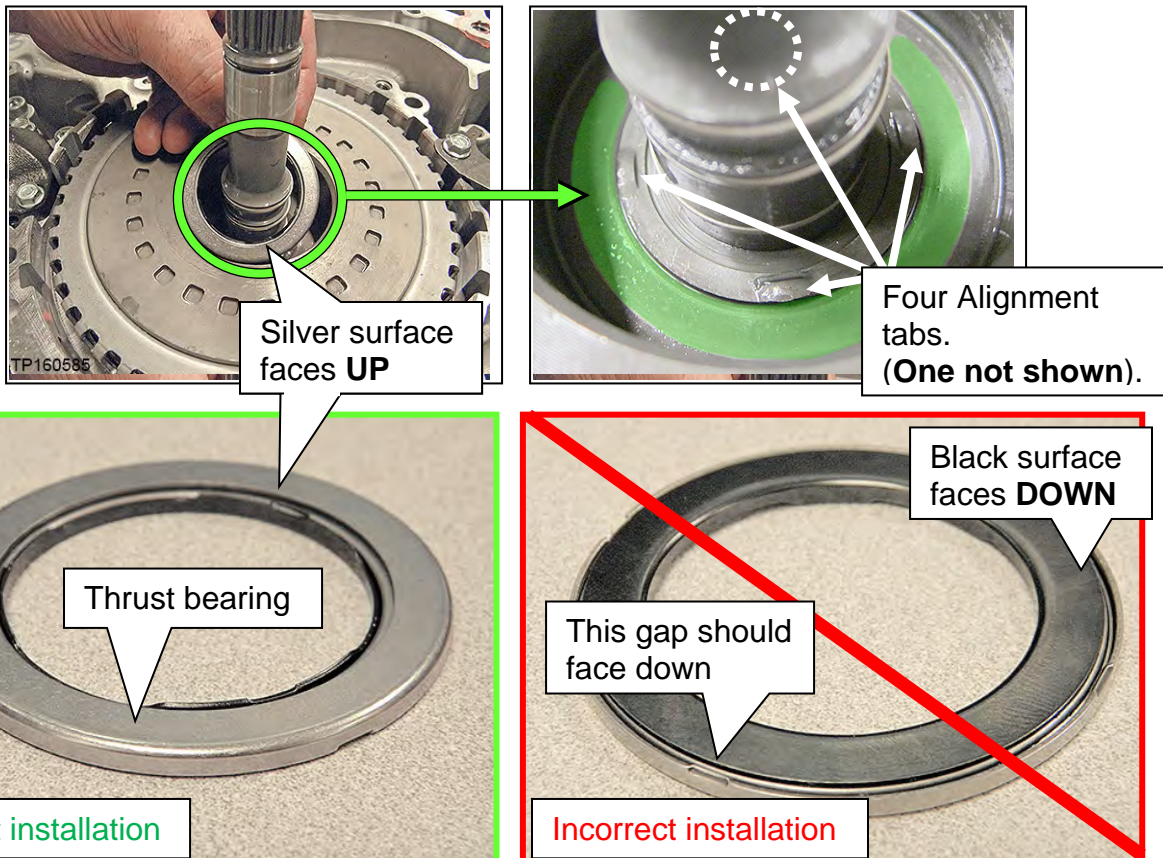

Figure 140

Pages 67-74 are for Type 2 Thrust Bearing (with bearing race) ONLY. Proceed to page 62 if working with Type 1 Thrust Bearing.

Type 2 CVT: Clutch Total Endplay Adjustment – Bearing Race Selection

IMPORTANT: The clutch total endplay (Figure 131) must always be adjusted when a new sub-assembly is installed.

- The Type 2 CVT uses the thrust bearing race thickness between the clutch drum of clutch assembly and the oil pump cover (dummy cover) to adjust the total endplay.

Thrust Bearing Race Selection

There are seven (7) thicknesses of thrust bearing races available for total endplay adjustment.

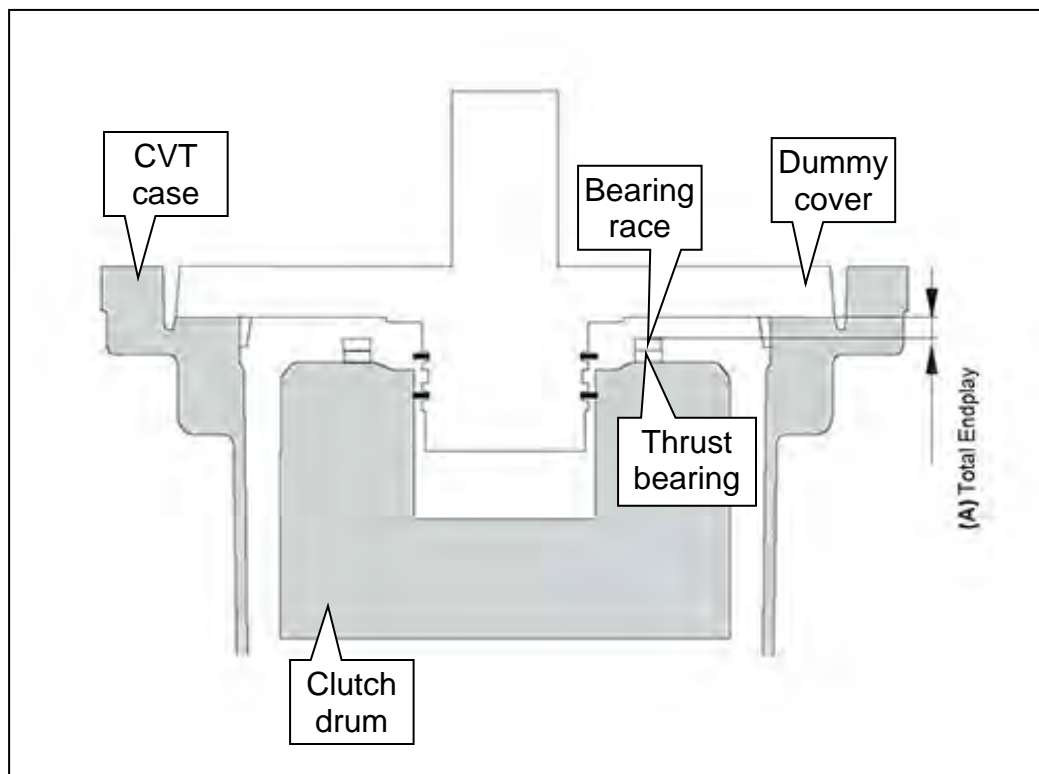

Figure 141

112. Clean and then zero the Digital Depth Gauge (part #: J-50272). See pages 60-61.

- Set Digital Depth Gauge to millimeters.

113. Clean Gauge Block J-50271.

114. Confirm that the CVT case and the dummy cover mating surfaces are clean.

NOTICE Do NOT use sanding discs or similar abrasive tools.

- Use brake spray or equivalent solvent and lint-free towels only.
- Make sure the brake spray or solvents used are compatible with local regulations.

115. Calculate the “average clutch assembly surface depth” (D) as follows:

IMPORTANT: Measurements are required from two opposite ends to obtain the average.

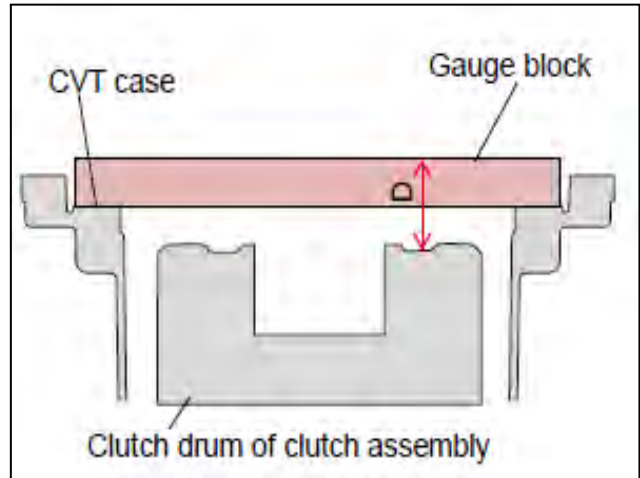

Figure 142

- a. Position the Gauge Block over the clutch assembly on the surface that the dummy cover seats.

IMPORTANT: This surface is lower than the CVT case to torque converter housing.

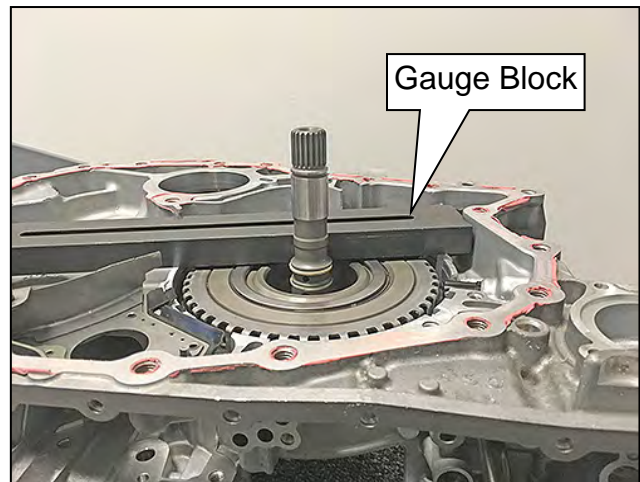

Figure 143

- b. Confirm the Gauge Block is not sitting on the clutch assembly or against the input shaft.

HINT:

- The top surface of the clutch assembly must be 1-3 mm below the CVT case surface, where the dummy cover seats.
- If the clutch assembly is sitting higher than the dummy cover surface, see

TROUBLESHOOTING The Dummy Cover Will Not Sit Flush on page 107.

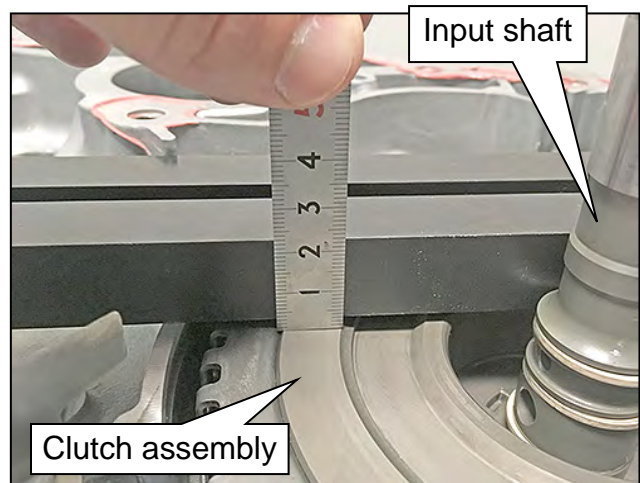

Figure 144

- c. Position the Depth Gauge on the Gauge Block.

HINT: Make sure the depth gauge's datum level is flush on top of the Gauge Block.

- d. Carefully slide the gauge down until it bottoms out on the upper surface of the clutch drum where thrust bearing seats, where shown in Figure 145. Write this measurement as **D1** (use millimeters).

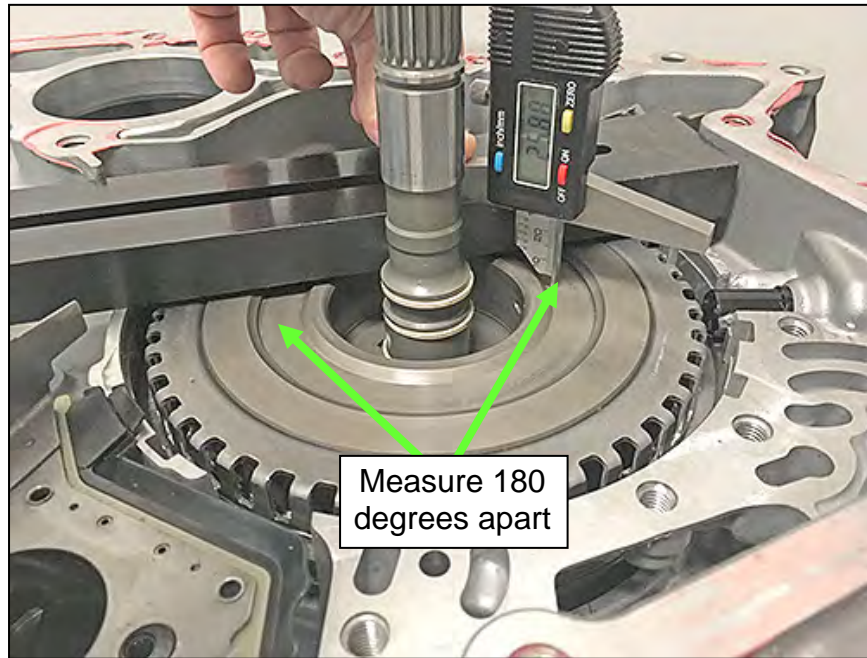

Figure 145

- e. Measure this same distance on the opposite side (180 degrees) of the clutch assembly surface and write it as **D2**.

- f. Using the formula below, calculate the average and write down the calculated value as **D**.

$$D = \frac{(D1 + D2)}{2}$$

Write the measurement for "D" here _____ mm

116. Measure the average (**H**) dummy cover height where case seats as follows;

- a. Clean the dummy cover surface that contact the CVT case and depth gauge.

IMPORTANT: Use brake spray (or equivalent) and lint-free towel only. Make sure the brake spray or solvents used are compatible with local regulations.

- b. Place the dummy cover upside down on a workbench, and place the Gauge Block onto the top surface.

- c. Position the Depth Gauge on the Gauge Block over an outer end of the dummy cover.

HINT: Make sure the Depth Gauge's datum level is flush with the top of the Gauge Block.

- d. Carefully slide the Depth Gauge down until it contacts the dummy cover surface that mates with the CVT case. Write this measurement as **H1** (use millimeters).

- e. Measure this same distance on the opposite side of the dummy cover and write it as **H2**.

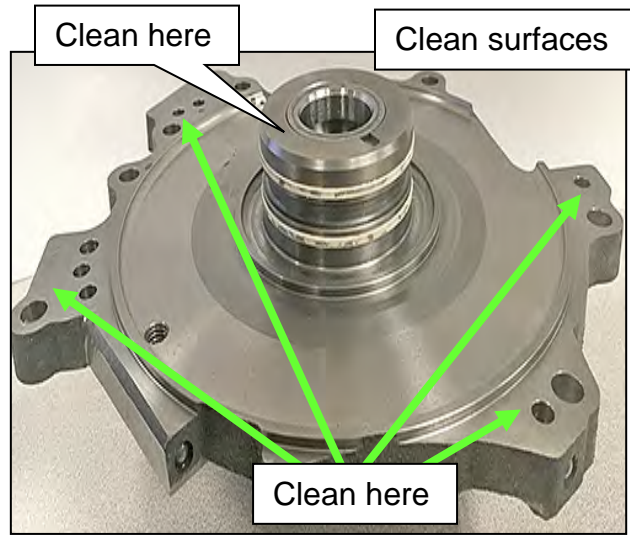

Figure 146

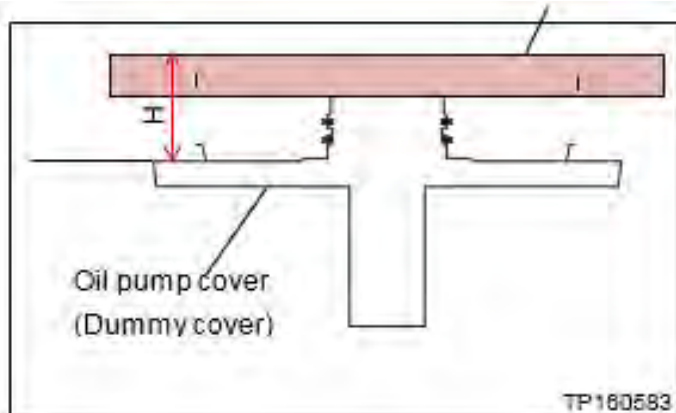
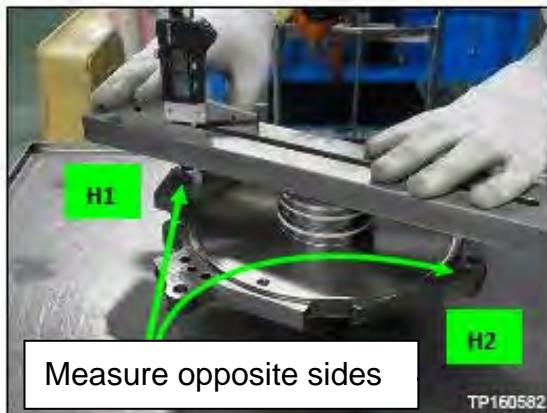

Figure 147

- f. Using the formula below, calculate the average and then write down the calculated value as **H**.

$$H = \frac{(H1 + H2)}{2}$$

Write the measurement for "H" here _____ mm

117. Measure the average (**J**) dummy cover height where thrust race seats as follows:

- a. Carefully slide the Depth Gauge down until it contacts the dummy cover surface that mates with the thrust race. Write this measurement as **J1** (use millimeters).
- b. Measure this same distance on the opposite side (180 degrees) of the dummy cover and then write as **J2**.

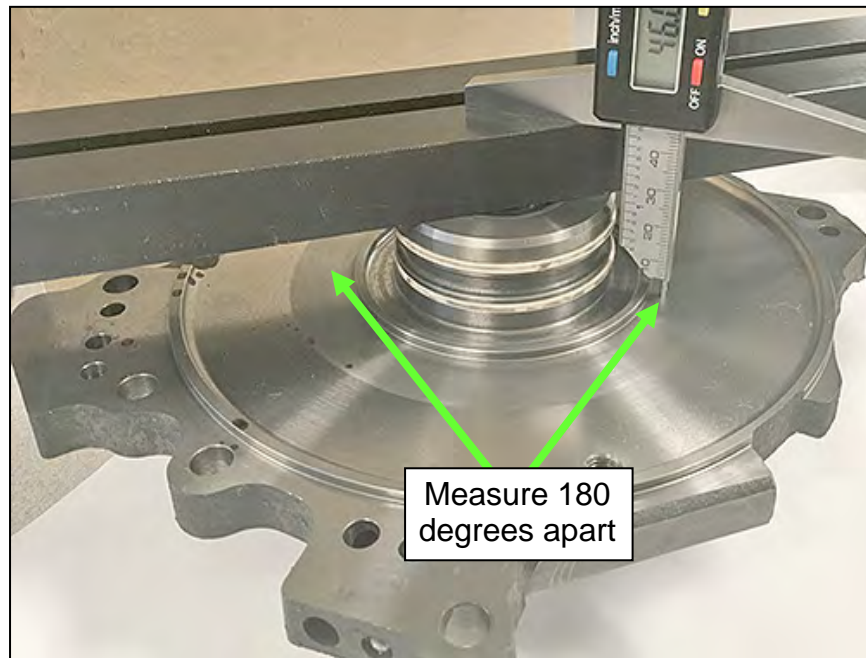

Figure 148

- c. Using the formula below, calculate the average and then write down the calculated value as **J**.

$$J = \frac{(J1 + J2)}{2}$$

Write the measurement for “**J**” here _____ mm

118. Calculate gap **G**.

$$\text{Gap } G = J - H$$

- o Fill in the measurements below for “**J**” and “**H**” to calculate for “**G**”.

$$\begin{array}{r} J \text{ measurement} \quad \underline{\hspace{2cm}} \text{ mm} \\ - H \text{ measurement} \quad \underline{\hspace{2cm}} \text{ mm} \\ = G \text{ -----} \quad \underline{\hspace{2cm}} \text{ mm} \end{array}$$

119. Measure the thickness of the thrust bearing ONLY (without original race) as follows:
- Place the thrust bearing roller side down on the Gauge Block (Figure 149).
IMPORTANT: Roller side of thrust bearing must face down and be flat on the Gauge Block to accurately measure thickness.
 - Measure at two different positions of the thrust bearing that are 180 degrees apart.
 - Add the two measurements, and then divide by two. Write down the calculated value as **E**.

$$E = \frac{(E1 + E2)}{2}$$

Write the measurement for "E" here _____ mm

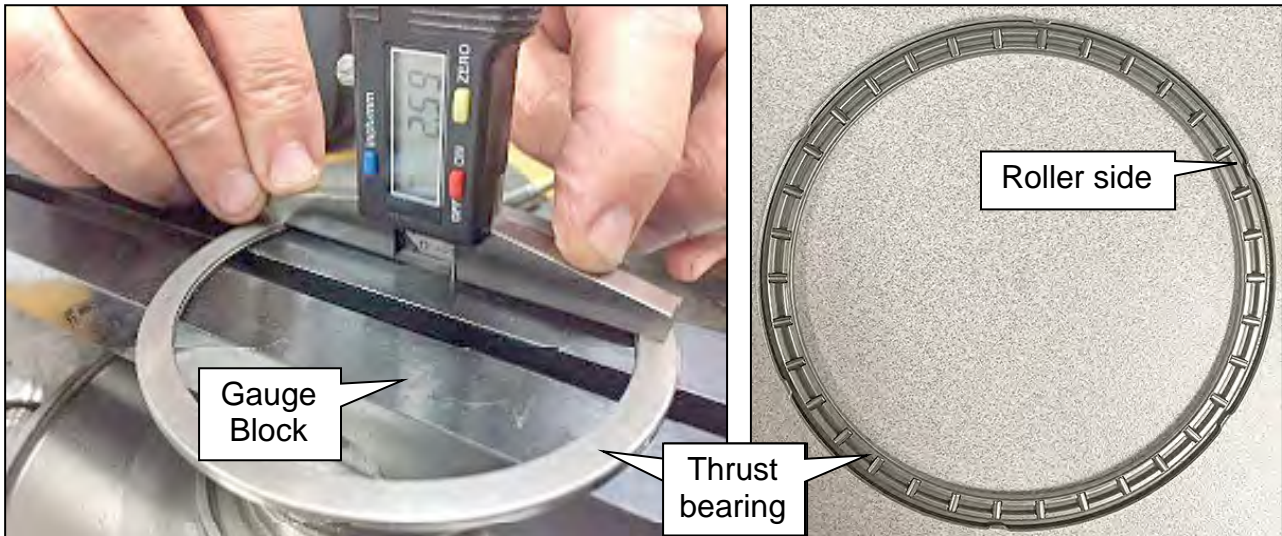

Figure 149

120. Choose the thrust bearing race to adjust Clutch Total Endplay (C) as follows:
- Calculate **C** (clearance).

$$\text{Total Clearance } C = D - T + G - E$$

HINT: "T" is the Thickness of the Gauge Block (J-50271: 20mm).

- Fill in the measurements below for "D", "G" and "E" from pages 69-72 to calculate for "C".

D measurement _____ mm
 - T measurement 20 mm
 + G measurement _____ mm
 - E measurement _____ mm
 = C _____ mm

**Please print this page and
attach it to the repair order.**

EXAMPLE: If **D** = 23.81, **G** = 0.41, **E** = 2.57

$$C = D - 20 + G - E = 23.81 - 20 + 0.41 - 2.57$$

C = 1.65

- b. Choose an appropriate thrust bearing race from **Table B** below based on **C** (seven different thrust bearing “race thicknesses” are available).

Example: If $C = 1.65$ mm, it falls between the lower and upper clearances for race thickness 1.2 mm.

- c. Measure and confirm that the selected thrust bearing race is the correct thickness before installing (Figure 150).

IMPORTANT: Do not measure from the thrust bearing race lip (Figure 151).

Table B

PART #: 31435-	CLEARANCE (C) $C = D - T + G - E$	RACE THICKNESS
3WX0A	0.90 – 1.08 mm	0.6 mm
3WX0B	1.09 – 1.29 mm	0.8 mm
3WX0C	1.30 – 1.50 mm	1.0 mm
3WX0D	1.51 – 1.70 mm	1.2 mm
3WX1A	1.71 – 1.90 mm	1.4 mm
3WX1B	1.91 – 2.10 mm	1.6 mm
3WX1C	2.11 – 2.30 mm	1.8 mm

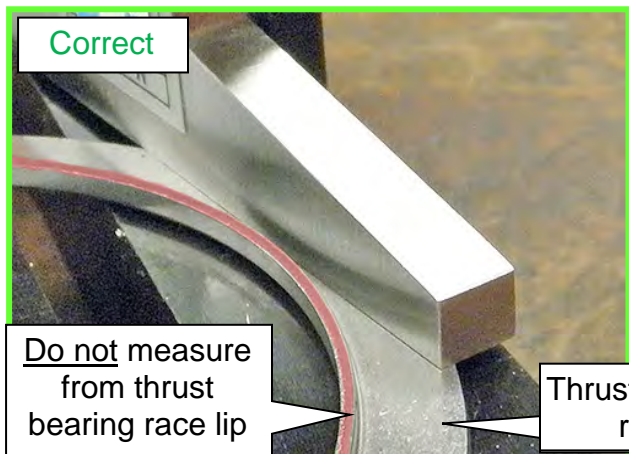

Figure 150

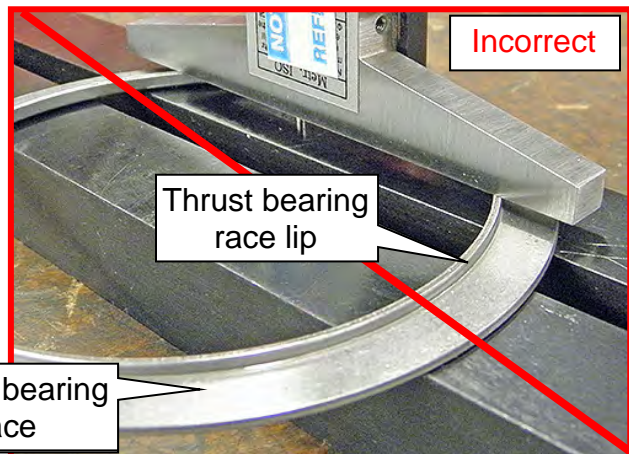

Figure 151

121. Install the thrust bearing onto the clutch drum.

IMPORTANT: The thrust bearing has two sides.

- The needle bearing side is the upper side.
- The race side mates with the clutch drum surface.



Figure 152

122. Install the bearing race onto the dummy cover. Apply petroleum jelly or equivalent to the thrust race to hold in place on the dummy cover.



Figure 153

Clean the Torque Converter Housing, Dummy Cover Passages and Baffle Plates

IMPORTANT: Remove as much of the CVT and cleaning fluids as possible, and clean the related parts in the following steps.

123. Remove the baffle plate and lubrication tube as follows:

a. Remove the three bolts, and then remove the baffle plate from the converter housing (Figure 154).

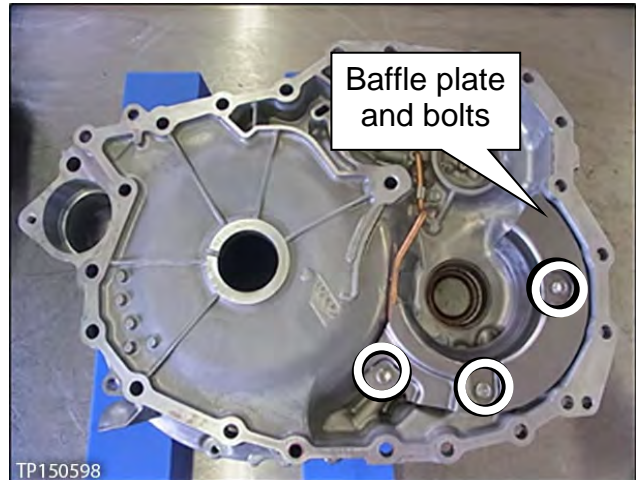

Figure 154

b. Remove the bolt and then remove the lubrication tube and its bracket (Figure 155).

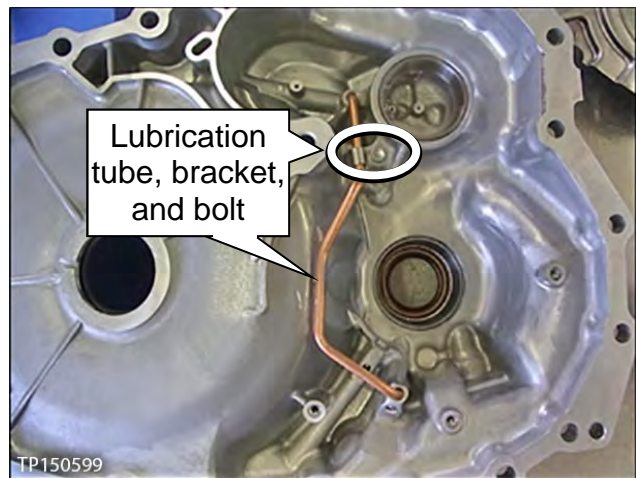
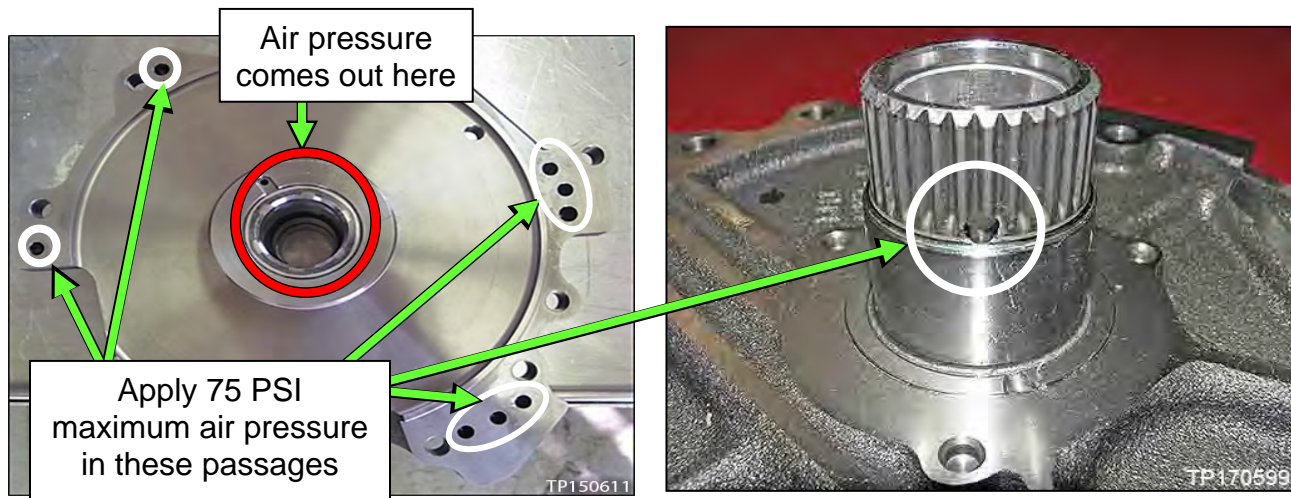
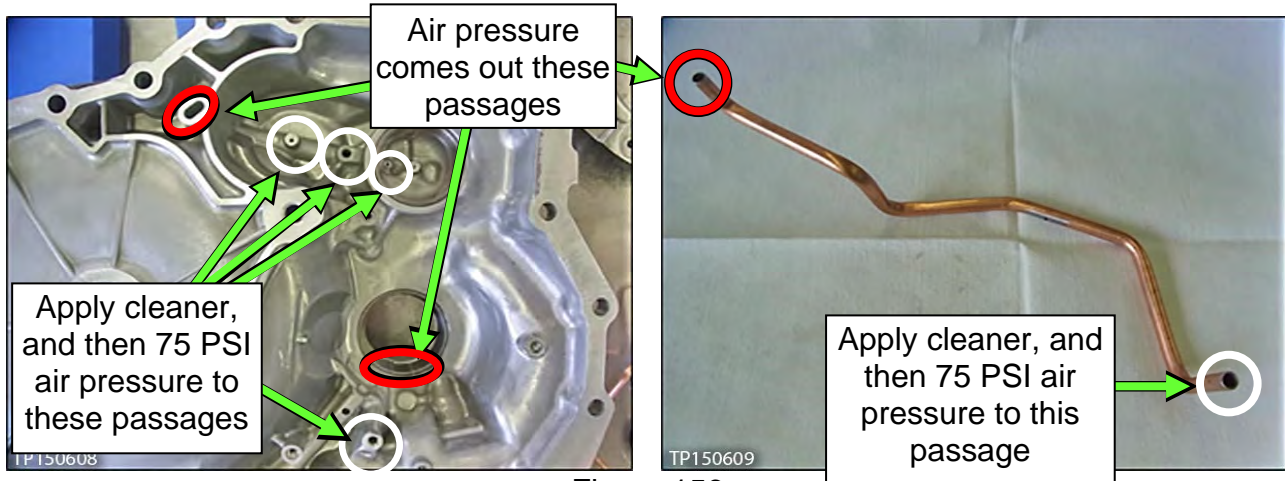

Figure 155

124. Clean all baffle plates.

125. Clean the oil passages of the converter housing, lubrication tube and dummy cover with brake cleaner (or equivalent) where shown in Figure 156 and Figure 157 below.

HINT: Do not stand in front of the passages shown while using compressed air.



126. Install the lubrication tube and bracket, and then the baffle plate with three bolts (Figure 158).

- Bolt torque: 5.9 N•m (0.6 kg-m, 52 in-lb.)

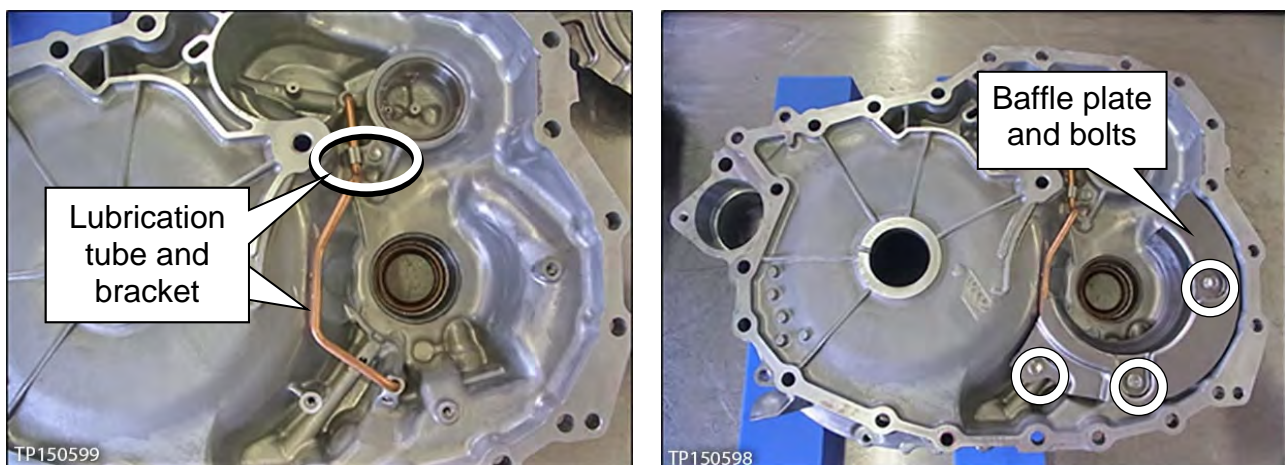

CVT Reassembly

127. Install a new torque converter seal with Seal Installer J-50818 (Figure 159).

- Place the torque converter housing flat during installation.
- Apply a light coat of CVT fluid to the seal lip surfaces.
- The torque converter housing seal will be 0.5 mm (**0.020 inches**) below the bore's surface when the seal installer bottoms out.



Figure 159

128. Is this vehicle an all-wheel drive (AWD)?

YES: Proceed to step 129.

NO: Install the torque converter housing side axle seal (Figure 160).

- Use Seal Installer J-52284 and Driver Handle J-8092.
- Apply a light coat of CVT fluid to the seal lip surfaces.
- Proceed to step 129.

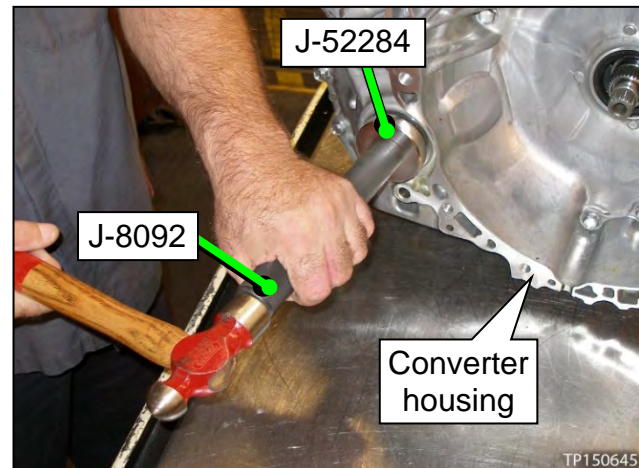

Figure 160

129. Apply petroleum jelly or equivalent to the dummy cover's lathe cut seals (Figure 161) before installing the dummy cover to the CVT case.

IMPORTANT:

- Confirm that the lathe cut seals (white seals) are in their appropriate slots. Carefully reposition seals as necessary.
- **Lathe cut seals must be in correct the positions during final assembly to prevent drivability issues.**

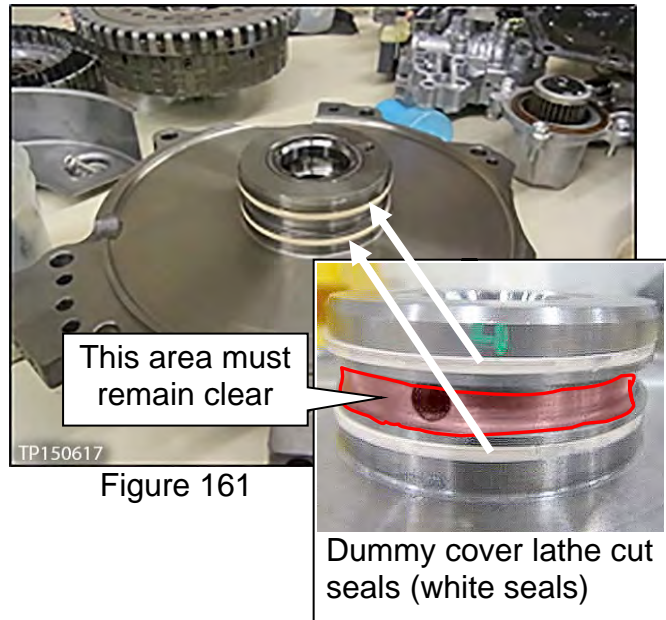

Figure 161

130. Confirm that the input shaft's lathe cut seals are in the correct locations.

IMPORTANT:

- Lathe cut seals (white seals) must be in their appropriate slots. Carefully reposition seals as necessary.
- **Lathe cut seals must be in the correct positions during final assembly to prevent drivability issues.**

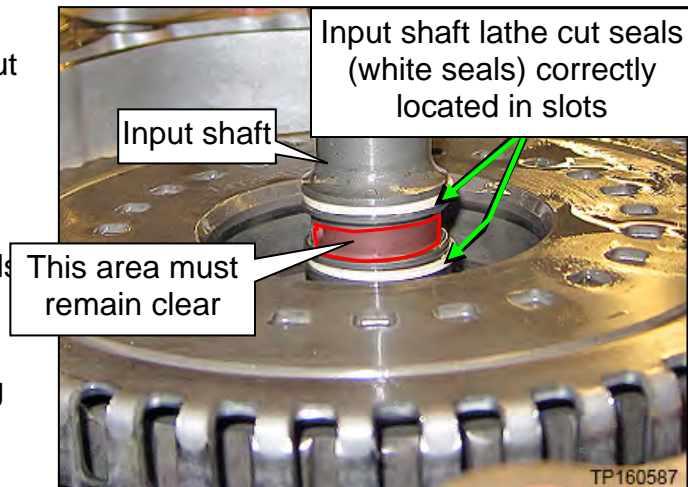

Figure 162

131. Install the dummy cover first, then baffle plate C, and then the related bolts finger tight (Figure 163).

IMPORTANT: Visually check that the dummy cover is fully seated on the CVT case. If it is not, refer to **TROUBLESHOOTING** pages 107-108.

- Do not force the dummy cover into place.
- Make sure the dummy cover is fully seated before installing the bolts.
- Do not torque these bolts at this time.

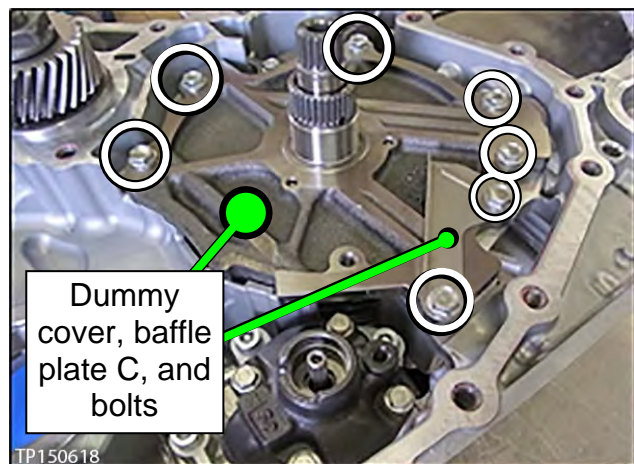

Figure 163

132. Install baffle plate B and “L” bracket with the related bolts finger tight (Figure 164).

133. Torque the bolts from steps 131 and 132 in the following order:

- a. Baffle plate B bolts: 5.9 N•m (0.6 kg- m, **52.2 in-lb.**)
- b. “L” bracket bolts: 25.5 N-m (2.6 kg- m, **19 ft-lb**). Torque **1** and then **2**.
- c. Dummy cover and baffle plate C bolts torque: 19.0 N•m (1.9 kg-m, **14 ft-lb.**)

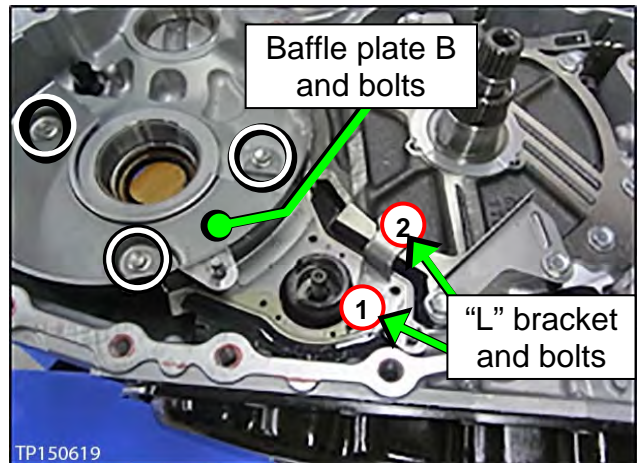

Figure 164

134. Install the thrust washer onto the dummy cover (Figure 165).

- Use petroleum jelly or equivalent to hold the thrust washer in place.
- Make sure the tabs fit into the holes.

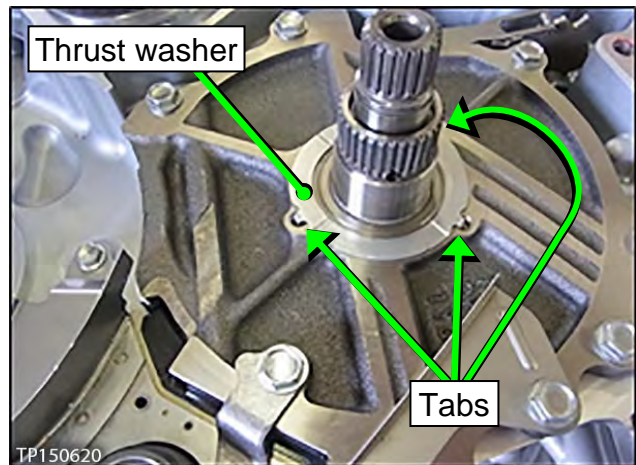

Figure 165

135. Install the drive sprocket, driven sprocket, and chain as an assembly (Figure 166).

- Make sure the raised edge (wider edge) on the drive sprocket is facing up (Figure 167).

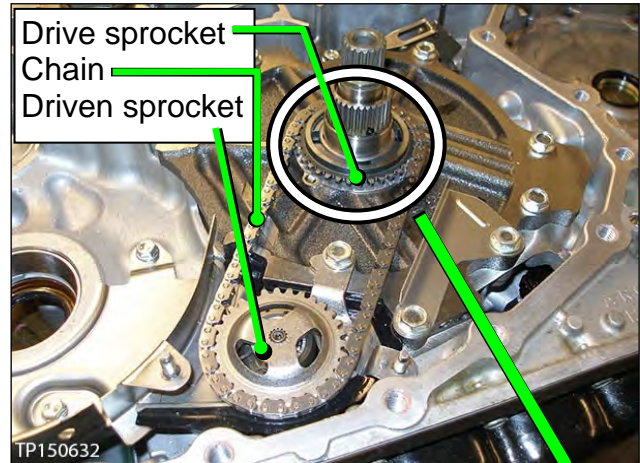

Figure 166

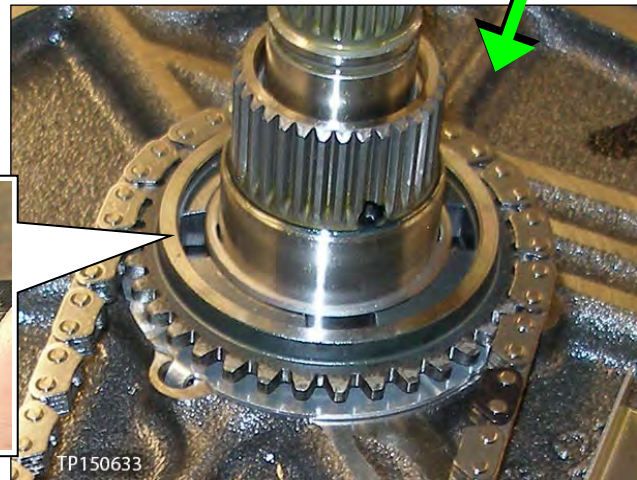
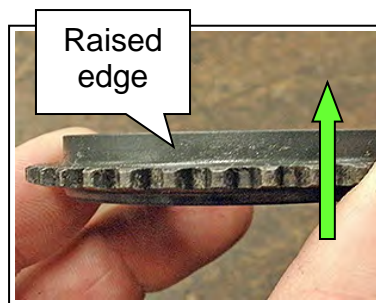

Figure 167

- Expand the snap ring with a suitable tool, and then push down on the driven sprocket until it bottoms out (Figure 168).
- Release the snap ring and then pull up on the driven sprocket until the snap ring locks into its groove.

HINT: A click sound is heard when the snap ring locks in place.

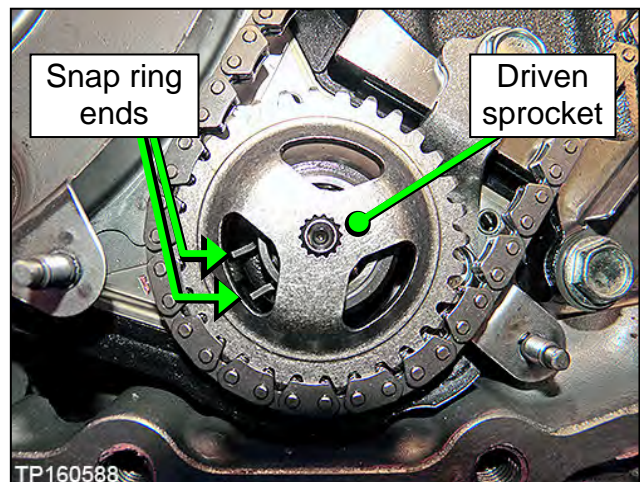

Figure 168

136. Install baffle plate A with two nuts (Figure 169).

- Nut torque:
5.9 N•m (0.6 kg-m, **52.2 in-lb.**)

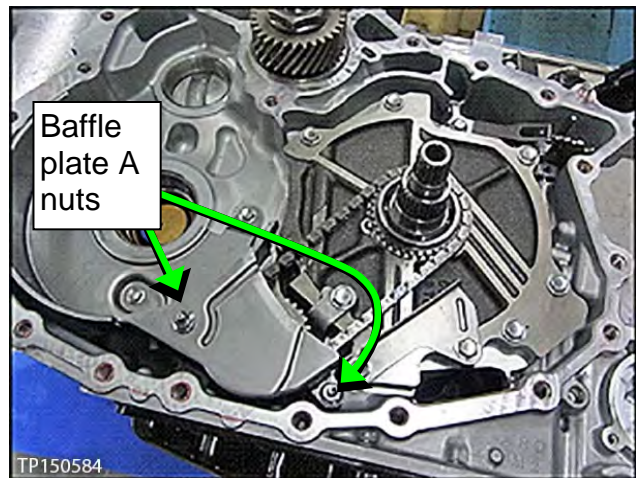

Figure 169

137. Install a new O-ring on the input shaft (Figure 170).

- Apply CVT fluid to the O-ring and O-ring groove before installing.

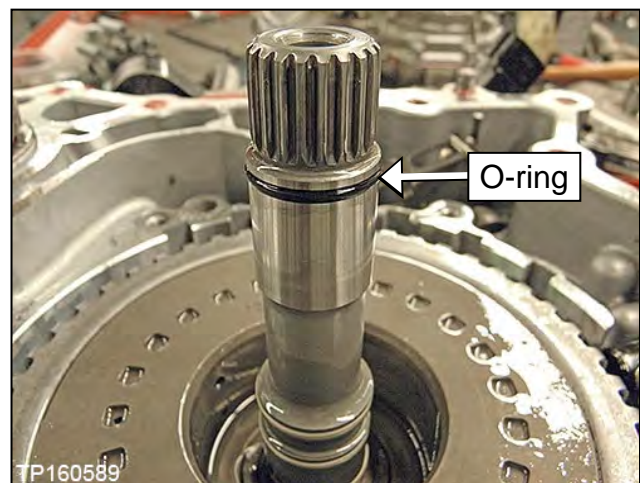

Figure 170

138. Install the differential assembly and the reduction gear assembly into the CVT case (Figure 171).

- Thoroughly clean each assembly before installing.
- Oil the bearings and gear teeth with CVT fluid before installing.

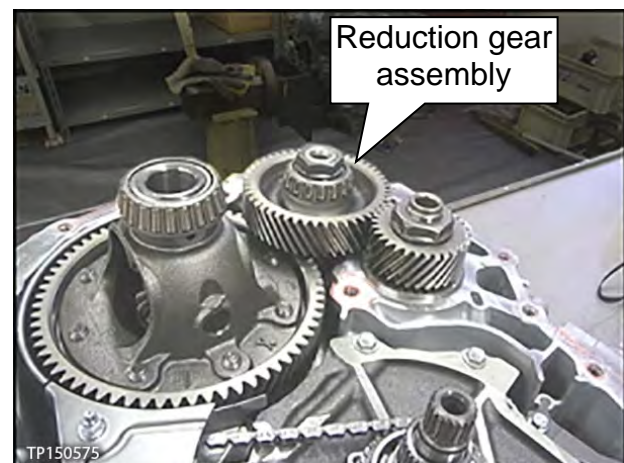
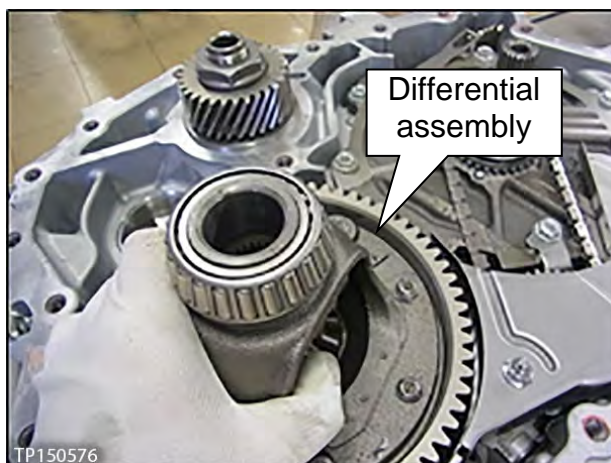

Figure 171

139. Confirm the pin (Figure 172) is located in the CVT case prior to installation of the converter housing.

HINT: If necessary, apply petroleum jelly or equivalent to keep it in place.

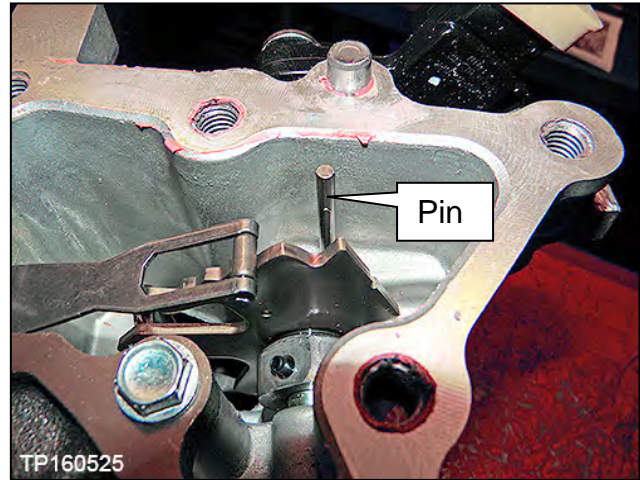

Figure 172

140. Apply one continuous 2.0 mm (**0.8 inches**) diameter bead (Figure 173) of pink colored Loctite 5460 Sealant (see the **PARTS INFORMATION** section of this bulletin).

- Before sealant application, make sure the mating surfaces are clean from oil, dirt, old sealant, etc. (Figure 173).

IMPORTANT: Have the converter housing ready for installation prior to applying the sealant.

HINT:

- Start applying sealant where shown, making sure that the starting point and the ending point are about the middle between the bolt holes.
- Overlap both ends of the bead by 3-5 mm (**0.12-0.20 inches**).
- Make sure to apply sealant around the center bolt hole.

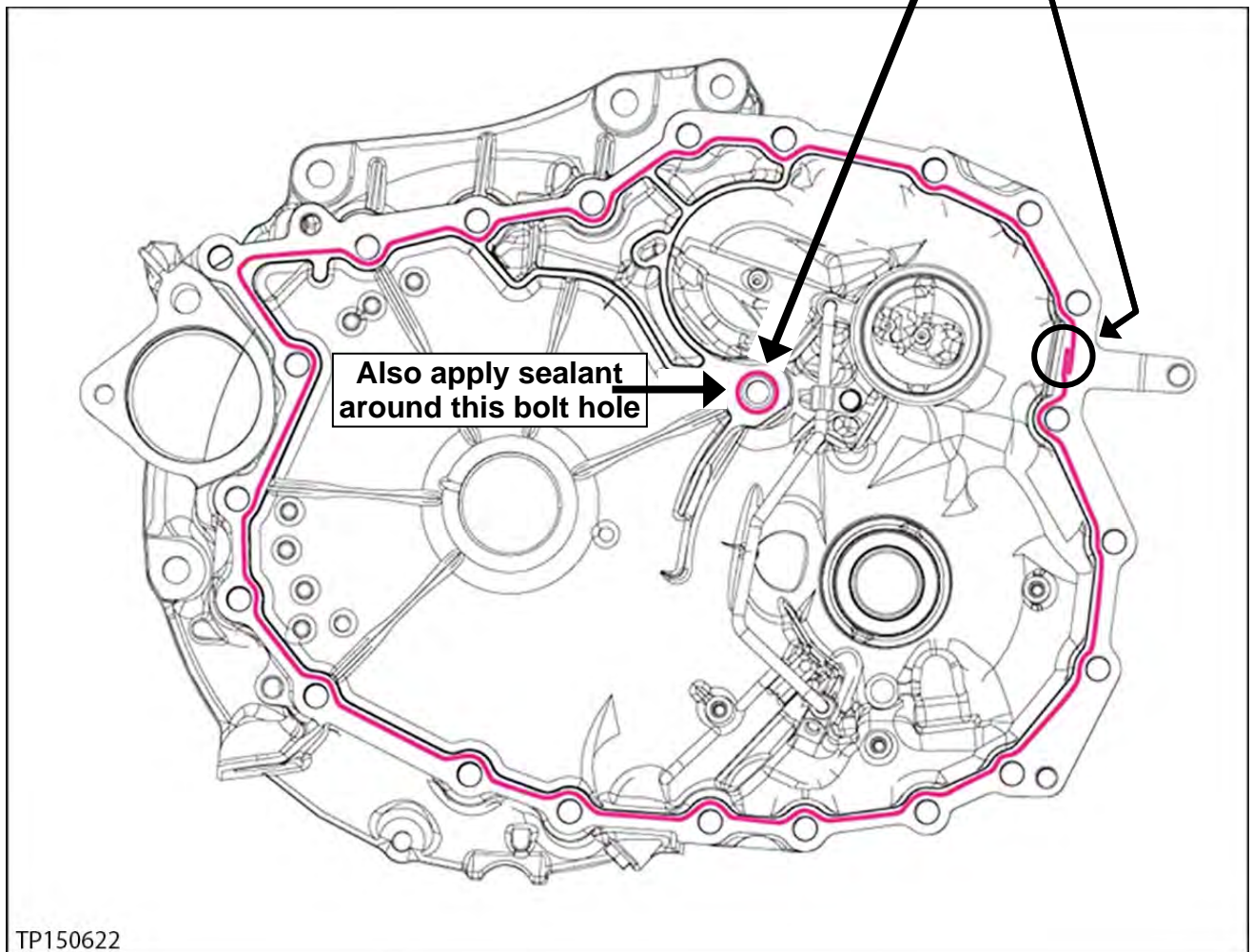



Figure 173

TP150622

141. Install the torque converter housing onto the CVT case (see Figure 174 for torque sequence):

- Install new bolts (24).
 - a. Torque the first six (6) bolts with symbol  in numbered sequence (see below).
 - b. Torque the remaining bolts with symbol  in numbered sequence (see below).
 - All bolts are 30 mm (1.2 inches) in length.
 - Bolt torque: 45.0 N•m (4.6 kg-m, 33.2 ft-lb.)

IMPORTANT: Make sure to torque the bolts in the sequence shown (Figure 174).

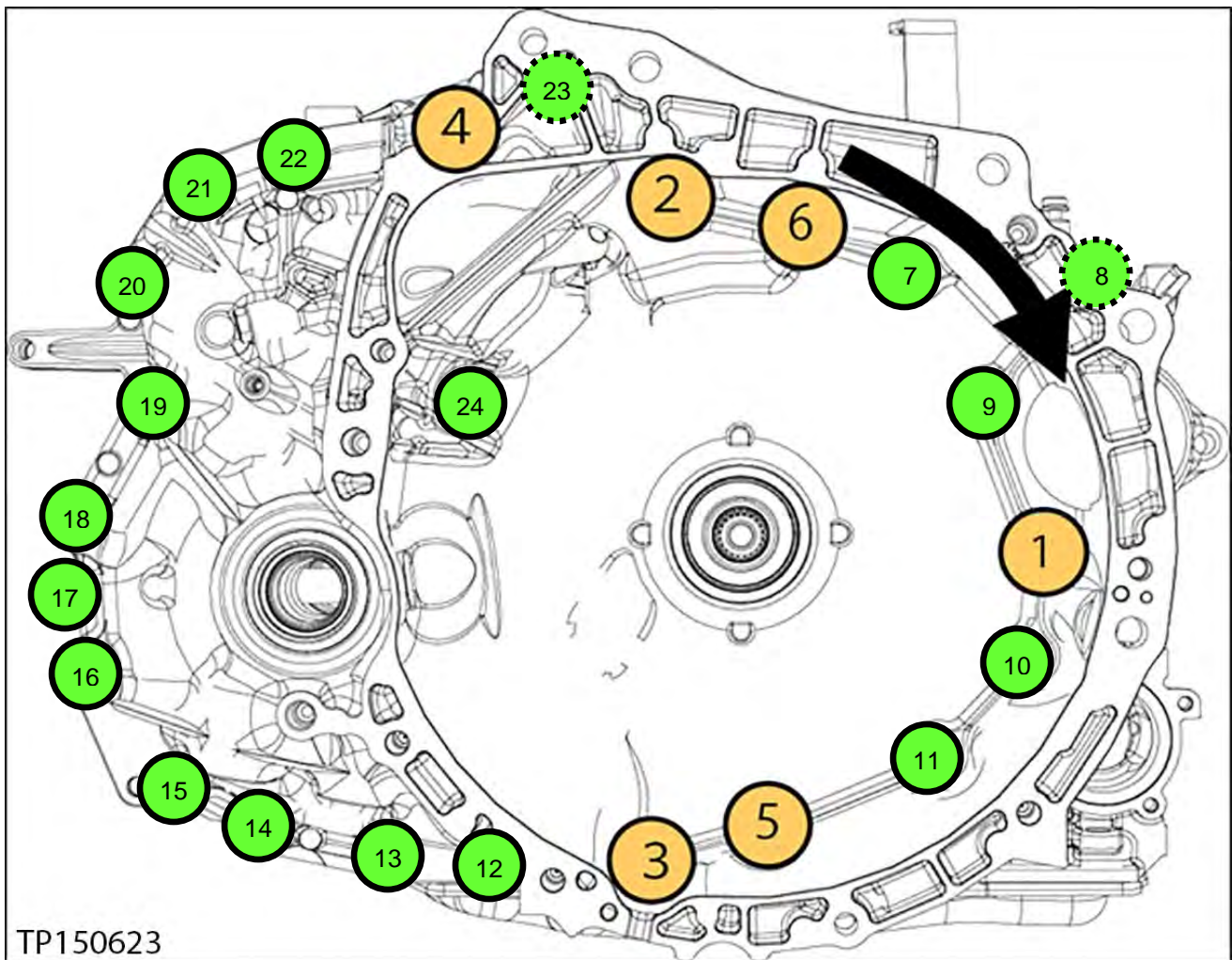

Figure 174

142. Clean off the excess sealant.

Control Valve (Valve Body), Strainer and Pan Installation

IMPORTANT:

- Installation steps in this bulletin may contain different style parts than what were originally installed in the CVT. Pay careful attention, REASSEMBLY MAY NOT BE IDENTICAL TO DISASSEMBLY.
- **Confirm that the QR label, control valve and CD part numbers all match before installing the control valve** (refer to NTB12-103).
- For additional information, see video # 547: “CVT Belt and Pulley Replacement” and fast forward to minute marker 19:52. This video is located under the TECH TRAINING GARAGE VIDEOS tab in Virtual Academy.

IMPORTANT: Handle the valve body carefully.

HINT: If an oil strainer bracket was removed, discard it. An oil strainer bracket (Figure 175) will not be used with the new oil strainer.



Figure 175

143. Install a new lip seal (Figure 176).

- Do NOT reuse the old lip seal.
- Apply a small amount of petroleum jelly or equivalent to the lip seal to keep it in place on the CVT.

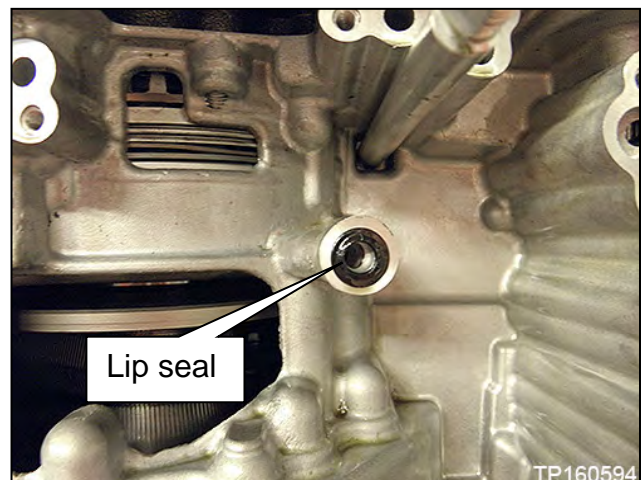

Figure 176

144. Install the Control Valve with eleven (11) mounting bolts (Figure 177).

IMPORTANT: Leave four (4) ✘ bolt holes blank at this step.

Make sure the wiring harness does not get pinched (see Figure 178 and Figure 179 for correct routing).

- 54 mm (2.125 inches) long bolt ●; 7 pieces
- 44 mm (1.73 inch) long bolt ●; 2 pieces
- 25 mm long (1 inch) long bolt ●; 2 pieces

IMPORTANT: The two 25 mm bolts are installed WITHOUT the strainer bracket.

- Bolt torque:
7.9 N•m (0.81 kg-m, 70 in-lb.)

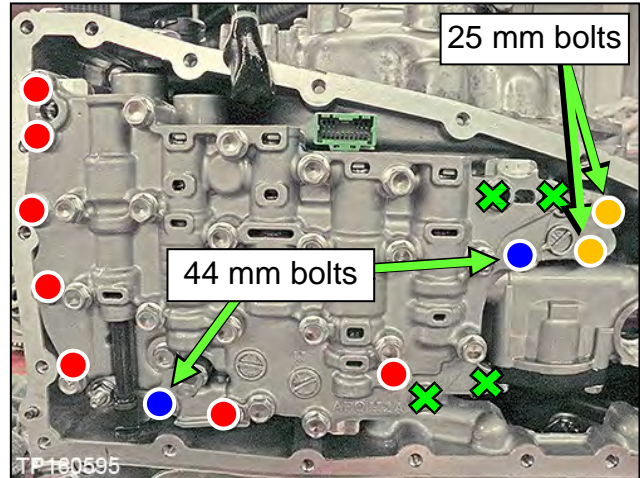

Figure 177

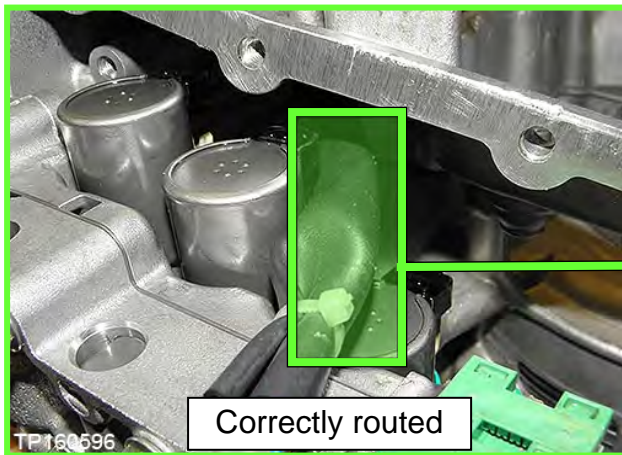

Figure 178

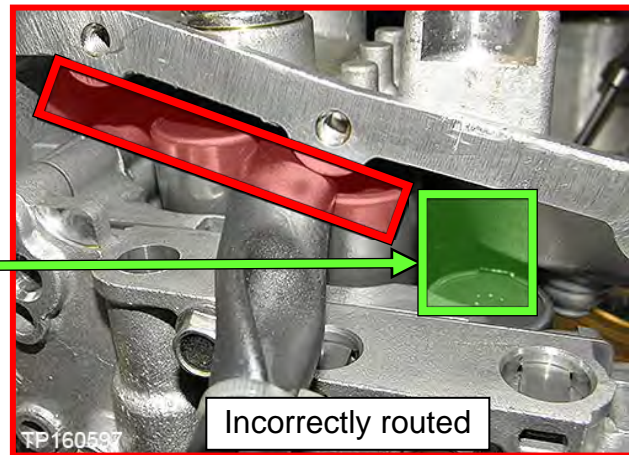

Figure 179

145. Replace the metal bracket of the fluid temperature sensor as follows:

HINT: The new bracket will be oriented the same way the old bracket was.

- a. Cut the old plastic zip tie with an appropriate tool to remove the fluid temperature sensor's metal bracket from the terminal harness assembly (Figure 180 and Figure 181).

NOTICE Cut the plastic zip tie over the metal bracket to avoid damage to the fluid temperature sensor.

- b. Discard the removed metal bracket and plastic zip tie.
- c. Use the new plastic zip tie from the **PARTS INFORMATION** to attach the fluid temperature sensor of the terminal connector harness to the fluid temperature sensor's new metal bracket.

IMPORTANT:

- o Locate the plastic zip tie at the center notch of three notches on the fluid temperature sensor (Figure 181).
 - o Tighten the plastic zip tie so that it is oriented as shown in Figure 181.
- d. Cut off the plastic zip tie excess.

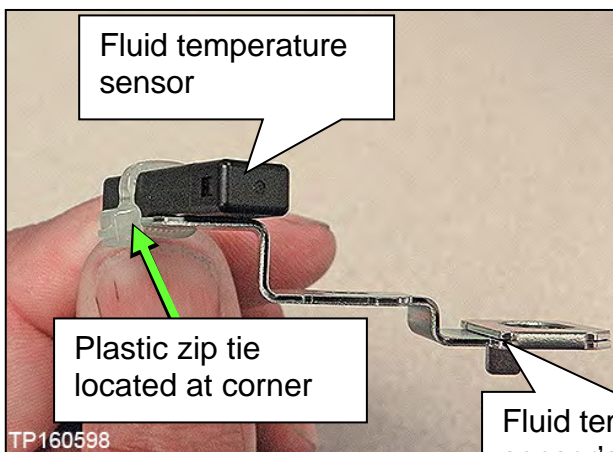

Figure 180

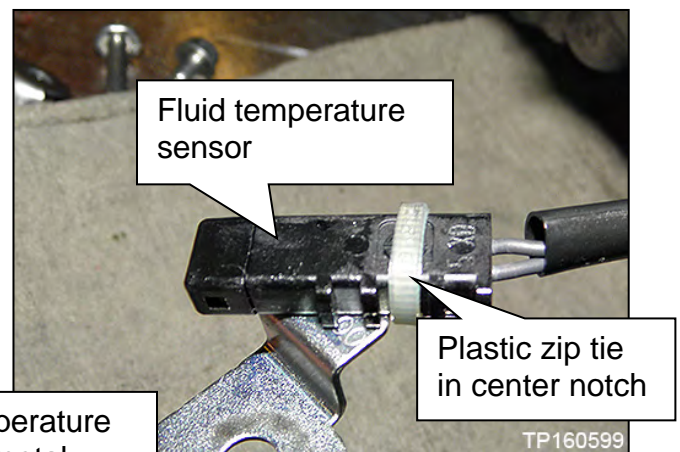

Figure 181

146. Connect the electrical harness connector (Figure 182).

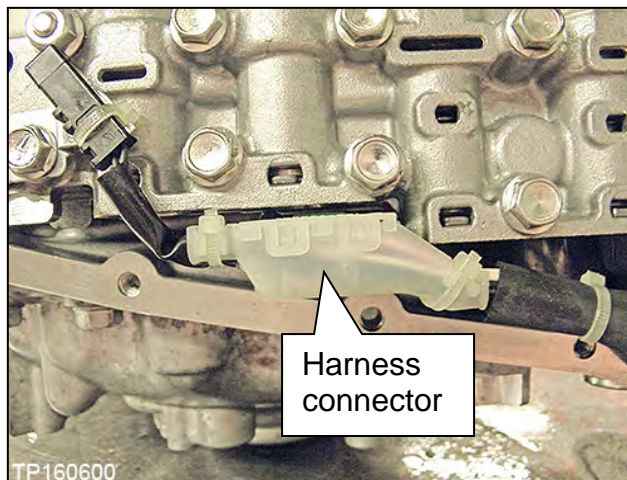

Figure 182

147. Install the CVT fluid temperature sensor bracket to the valve body with one (1) bolt (Figure 183).

HINT: Leave one (1) bolt hole blank as it will be used to secure the oil strainer at a later step.

- 54 mm (2.125 inches) long bolt.
 - Bolt torque:
7.9 N•m (0.81 kg-m, **70 in-lb.**)

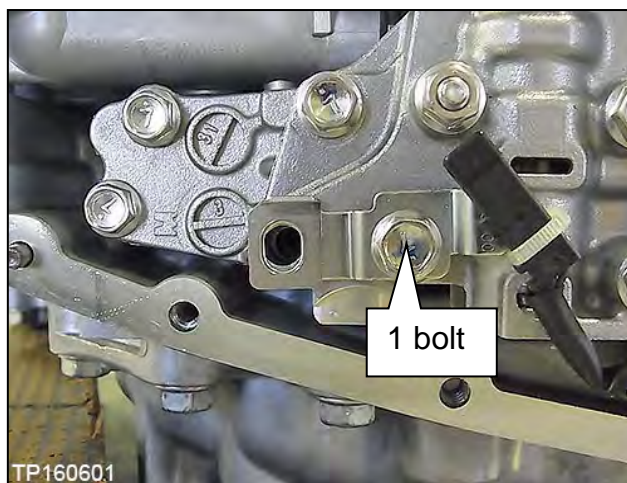



Figure 183

148. Install the new oil strainer with its new O-ring seal with two (2) bolts (Figure 184).

HINT: The replacement strainer maybe a different shape than the original.

- 54 mm (2.125 inches) long bolt ; 2 pieces.
 - Bolt torque:
7.9 N•m (0.81 kg-m, **70 in-lb.**)

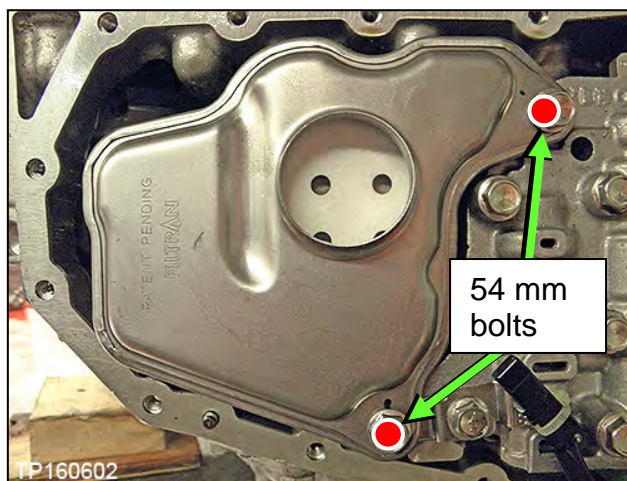

Figure 184

149. Install the manual plate, lock washer, and nut (Figure 185).

HINT: Make sure the manual plate fits into the slot of the manual valve before applying torque to the nut.

- Reuse the existing manual plate, lock washer, and nut.
 - Nut torque:
22.1 N•m (2.3 kg-m, **16 ft-lb.**)

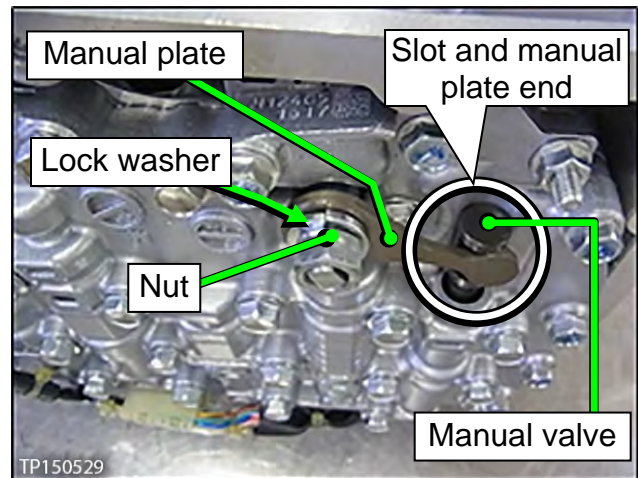

Figure 185

150. Clean the original oil pan and magnets with a suitable cleaner. Visible debris should not be present at re-assembly.

151. Reassemble the original magnets to the pan.

HINT: Return the magnets to their original locations.

152. Install a new oil pan gasket to the pan.

153. Install the oil pan bolts (see Figure 186).

- Reuse the existing pan bolts.
 - Oil pan bolts torque: 7.9 N•m (0.81 kg-m, **70 in-lb.**)

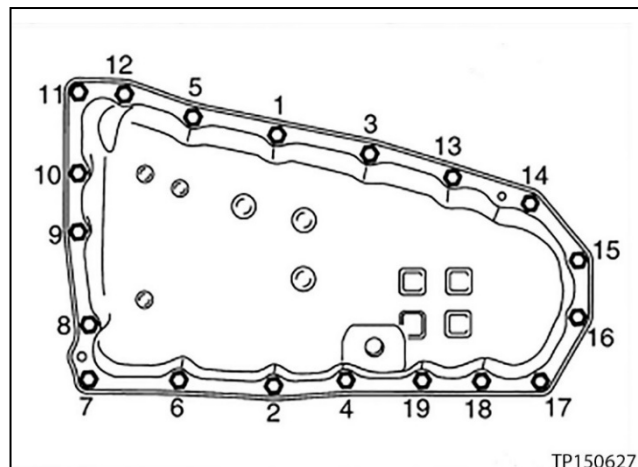

Figure 186

154. Install a new drain washer to the drain plug on the oil pan.

155. Install the primary speed sensor to the CVT assembly. (Perform only if installing CVT assembly.)

IMPORTANT: Install a new O-ring to the speed sensor before installation. DO NOT reuse the old O-ring.

- Bolt torque: 5.9 N•m (0.6 kg-m, 52 in-lb.)

156. Install the torque converter to the CVT assembly (perform only if installing the CVT assembly).

- Verify the torque converter is installed at the proper depth (Figure 187).
- $\textcircled{A} = 14.4 \text{ mm}$

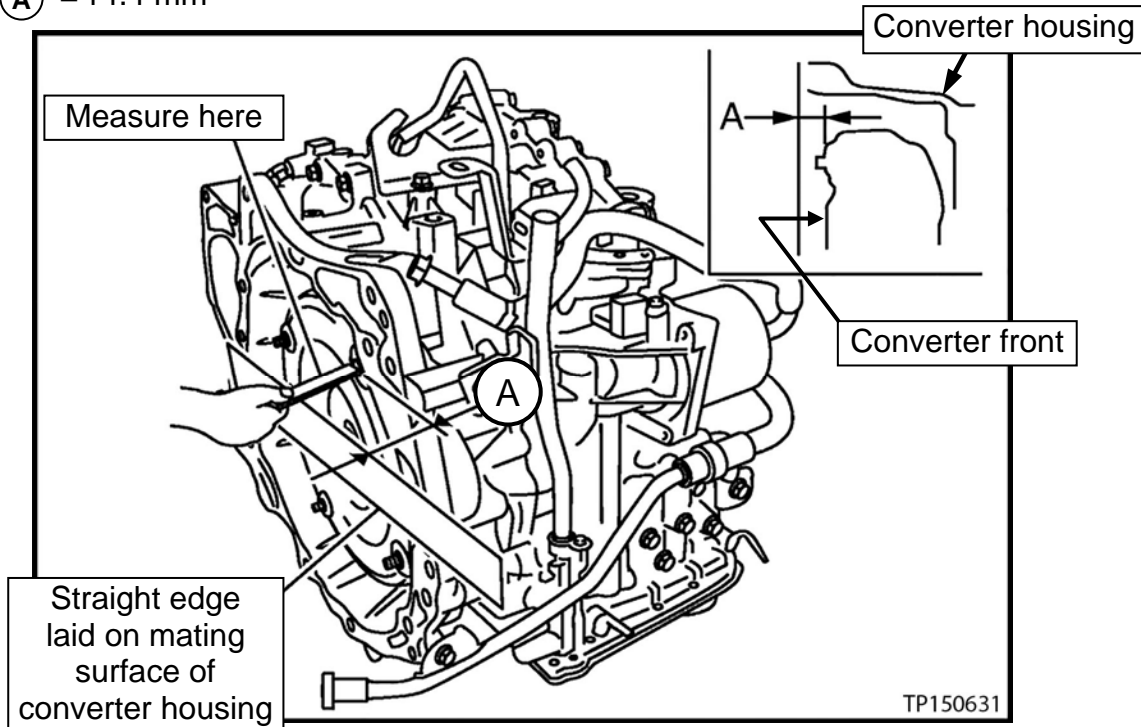

Figure 187

157. Attach the QR label (Figure 188) with the new calibration data onto the transmission range switch (inhibitor switch Figure 189).

- A QR Label and CD-R are included with the new valve body.
- Confirm that the QR label and the CD-R part numbers are the same (Figure 188).

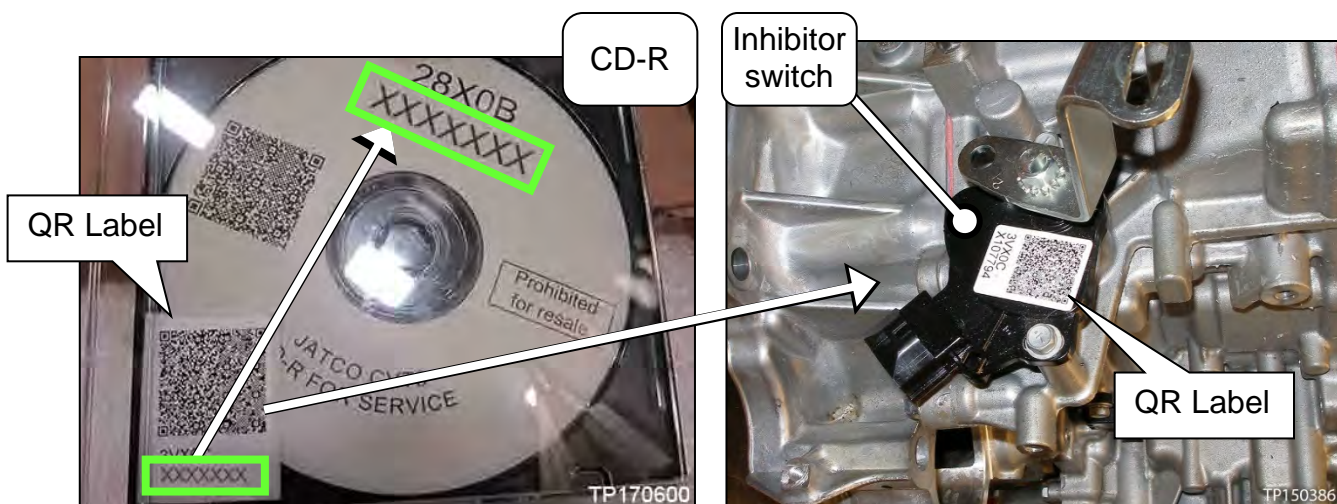

Figure 188

Figure 189

158. If only the valve body (control valve) was replaced, skip to step 159 on page 91.

Install the CVT Assembly

159. Install the CVT assembly into the vehicle.

HINT: Refer to the Electronic Service Manual (ESM), section **TM – Transaxle & Transmission**, for CVT installation.

And then,

- 2WD vehicles skip to step 160 on page 92.
- Vehicles with all-wheel drive, install the transfer case as follows:
 - a. Replace only the external O-ring to the transfer case and then install the transfer case to the CVT.

- Apply CVT fluid to the O-ring.

HINT:

- Refer to the ESM, section **DLN – Driveline**, for the transfer case assembly installation.
- Use extreme caution when installing the axle to the transfer assembly to avoid seal damage or deformation.
- Properly support and guide the axle.

- b. Proceed to step 160 on page 92.

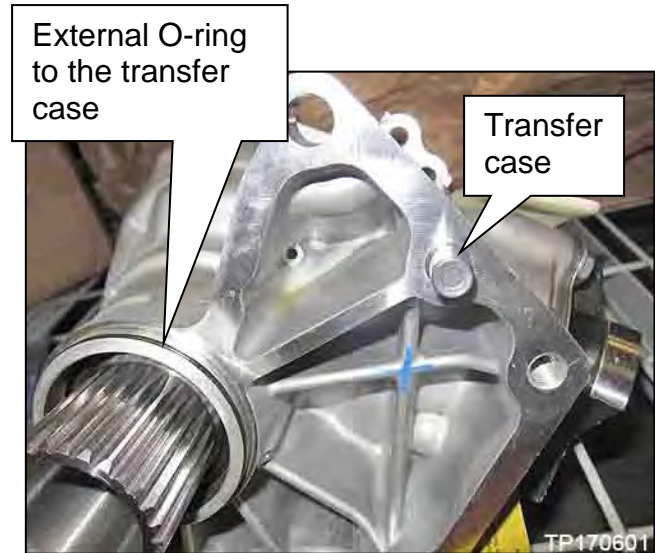

Figure 190

IMPORTANT:

To avoid damage to the transaxle, **a cooler flush is required** after a valve body or CVT assembly replacement.

160. Flush the CVT cooler(s). For the procedure to flush the CVT cooler, refer to the ESM:

- For 2013-2014 Altima and 2013-2014 Pathfinder, refer to: **TRANSMISSION & DRIVELINE > TRANSAXLE & TRANSMISSION > CVT: RE0F10E > BASIC INSPECTION > CVT FLUID COOLER SYSTEM > CVT COOLER FLUSH**
- For 2015-2018 Altima and 2016-2022 Maxima, refer to: **TRANSMISSION & DRIVELINE > TRANSAXLE & TRANSMISSION > CVT: RE0F10H > BASIC INSPECTION > CVT FLUID COOLER SYSTEM > CVT COOLER FLUSH / CVT Fluid Cooler Flush**
- For 2015-2022 Murano, 2015-2020 Pathfinder, and 2015-2017 Quest, refer to: **TRANSMISSION & DRIVELINE > TRANSAXLE & TRANSMISSION > CVT: RE0F10E > BASIC INSPECTION > CVT FLUID COOLER SYSTEM > CVT COOLER FLUSH / CVT Fluid Cooler Flush**

OR

TRANSMISSION & DRIVELINE > TRANSAXLE & TRANSMISSION > CVT: RE0F10J > BASIC INSPECTION > CVT FLUID COOLER SYSTEM > CVT COOLER FLUSH / CVT Fluid Cooler Flush

161. Connect both battery cables, negative cable last.

162. Reset/reinitialize systems as needed.

- Refer to the ESM, section **PG – Power Supply & Ground Elements**, for a listing of systems that require reset/initialization after reconnecting the 12V battery.
- Look in the PG section index for **ADDITIONAL SERVICE WHEN REMOVING BATTERY NEGATIVE TERMINAL**.
- This list often includes items such as radio, power windows, clock, sunroof, etc.

TCM Reprogramming

IMPORTANT: Before starting, make sure:

- ASSIST on the CONSULT PC has been synchronized (updated) to the current date.
- All CONSULT-III plus (C-III plus) software updates (if any) have been installed.

HINT:

- Most instructions for reprogramming with C-III plus are displayed on the CONSULT PC screen.
- If you are not familiar with the reprogramming procedure, [click here](#). This will link you to the "**CONSULT-III PLUS REPROGRAMMING FOR ENGINE OR TRANSMISSION CONTROL MODULE (ECM OR TCM)**" general procedure.

NOTICE

- Connect a battery maintainer or smart charger to the vehicle battery, set to "power supply" mode. If the vehicle battery voltage drops below 12.0V or rises above 15.5V during reprogramming, the TCM may be damaged.
- Be sure to turn OFF all vehicle electrical loads.
If a vehicle electrical load remains ON, the TCM may be damaged.
- Be sure to connect the AC Adapter.
If the CONSULT PC battery voltage drops during reprogramming, the process will be interrupted and the TCM may be damaged.
- Turn OFF all external Bluetooth® devices (e.g., cell phones, printers, etc.) within range of the CONSULT PC and the VI. If Bluetooth® signal waves are within range of the CONSULT PC during reprogramming, reprogramming may be interrupted and the TCM may be damaged.

163. Confirm that the CONSULT PC is connected to Wi-Fi.
164. Connect the Vehicle Interface (VI) to the vehicle.
165. Turn the ignition ON with the engine OFF.
166. Start CONSULT-III plus on the CONSULT PC.
167. If prompted, select **USA/CANADA Dealers** from the drop-down menu, and then select **OK**.
168. Login using your NNAnet credentials.
IMPORTANT: If not prompted to enter your username and password, the CONSULT PC may not be connected to Wi-Fi. Close C-III plus, confirm the CONSULT PC is connected to Wi-Fi, and then reopen C-III plus.
169. Wait for the VI to be recognized (Figure 191).
 - The serial number will be displayed when the VI is recognized.
170. Select **Re/programming, Configuration**.

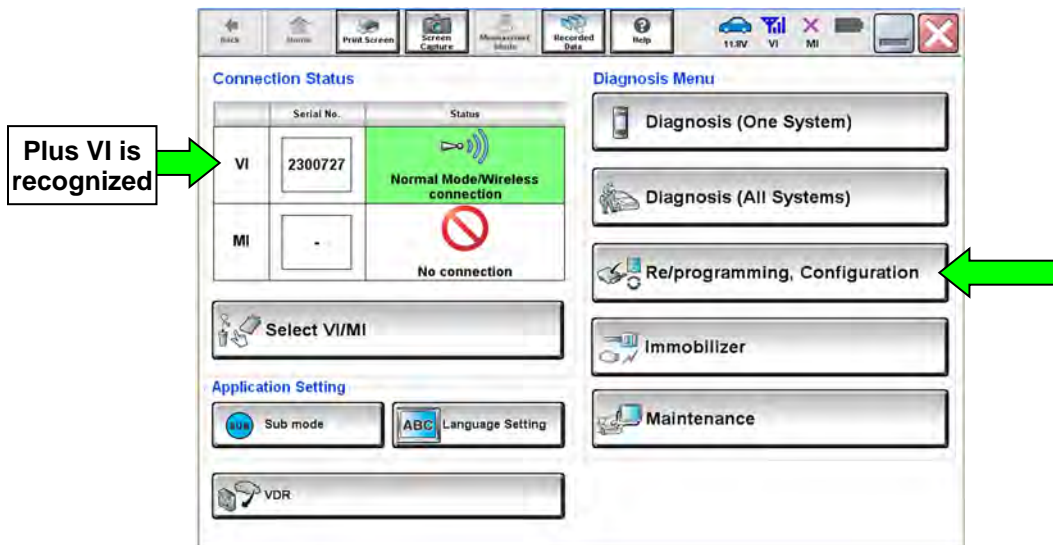

Figure 191

171. Follow the on-screen instructions and navigate the C-III plus to the screen shown in Figure 192.
172. When you get to the screen shown in Figure 192, confirm reprogramming applies as follows.
- A. Find the TCM **Part Number** and write it on the repair order.
- HINT:** This is the current TCM Part Number (P/N).

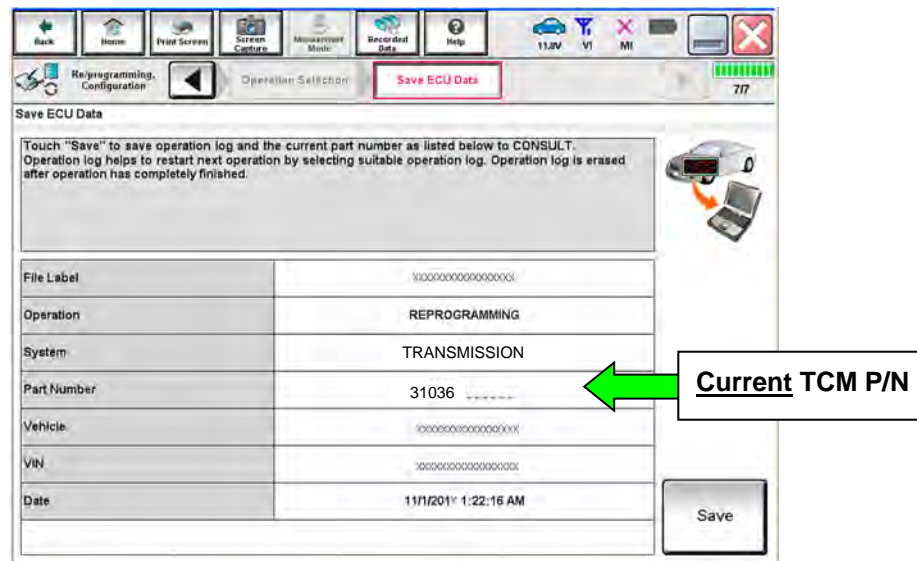

Figure 192

- B. Compare the P/N you wrote down to the numbers in the **Current TCM Part Number Before Reprogramming** column in **Table C** on the next page.
- If there is a match, continue with the reprogramming procedure; step 173 on page 97.
 - If there is not a match, reprogramming is not needed; skip to step 182 on page 101, **Perform ADDITIONAL SERVICE WHEN REPLACING CONTROL VALVE.**

Table C

Model	Model Year	Current TCM Part Number Before Reprogramming: 31036 -
Altima	2013	3NT0A, 3TA6A, 3TA6B, 3TA9E 3TM0A, 3TM1A, 3TM2A, 3TM3A 3TM0D, 3TM0E, 3TM1D, 3TM1E
	2014	9HM2A, 9HM5A, 9HM5B, 9HM5C, 9HM5D
	2015	9HP0A, 9HP0B, 9HP0C, 9HP4C
	2016 - 2017	3TF0A, 3TF0B, 9HS9A
	2018	3TD0A, 9HU0A, 9HU9A
Murano	2015	5AA0A, 5AA1A, 5AA2A, 5AA9A 5AA9B, 5AA0D, 5AA0E
	2016 - 2017	5AG0A, 5AG9A, 5AG0B, 5AG9B, 5AG0C
	2018	5BN0A, 5BN9A
	2019	9UF0A
	2020 - 2022	(1)
Pathfinder	2013	3KA2A, 3KA4A, 3KA5A, 3KA6A 3KA4B, 3KA5B, 3KA6B 3KA4C, 3KA6C 3KA4D, 3KA4E 3KD2A, 3KD4A, 3KD5A 3KD4B, 3KD5B 3KD4C, 3KD4D, 3KD4E
	2014	9PA3A, 9PA7A, 9PA9A 9PA3B, 9PA7B 9PA3C, 9PA7C 9PA3D, 9PA5D, 9PA7D 9PA5E
	2015	9PB0A, 9PB3A, 9PB9A 9PB0B, 9PB0C, 9PB0E
	2016	9PF0A, 9PF1A 9PF1B, 9PF9A
	2017	9PK0B, 9PK0C, 9PK9A
	2018	9PM0A, 9PM0B, 9PM9A
	2019	9PR0A, 9PR0D
	2020	(1)
	2021	(1)
Maxima	2016	4RA0A, 4RA0B, 4RA0C, 4RA0D 4RA1A, 4RA1B
	2017	9DD0A, 9DD0B, 9DD0C, 9DD9A, 9DD9B
	2018	9DE0A, 9DE9A
	2019	9DJ0B
	2020 - 2022	(1)
Quest	2015	4AY0A, 4AY0B, 4AY6A
	2016	6AX0A, 6AX0B, 6AX9A
	2017	6AX2A, 6AX2B, 6AX8A

(1) TCM reprogramming not currently applicable.

173. Follow the on-screen instructions to navigate C-III plus and reprogram the TCM.

HINT:

- In some cases, more than one new P/N for reprogramming is available.
 - If more than one new P/N is available, the screen in Figure 193 displays.
 - Select and use the reprogramming option that does **not** have the message “Caution! Use ONLY with NTBXX-XXX”.
- If you get this screen and it is blank (no reprogramming listed), it means there is no reprogramming available for this vehicle. Close C-III plus and refer back to ASIST for further diagnosis.

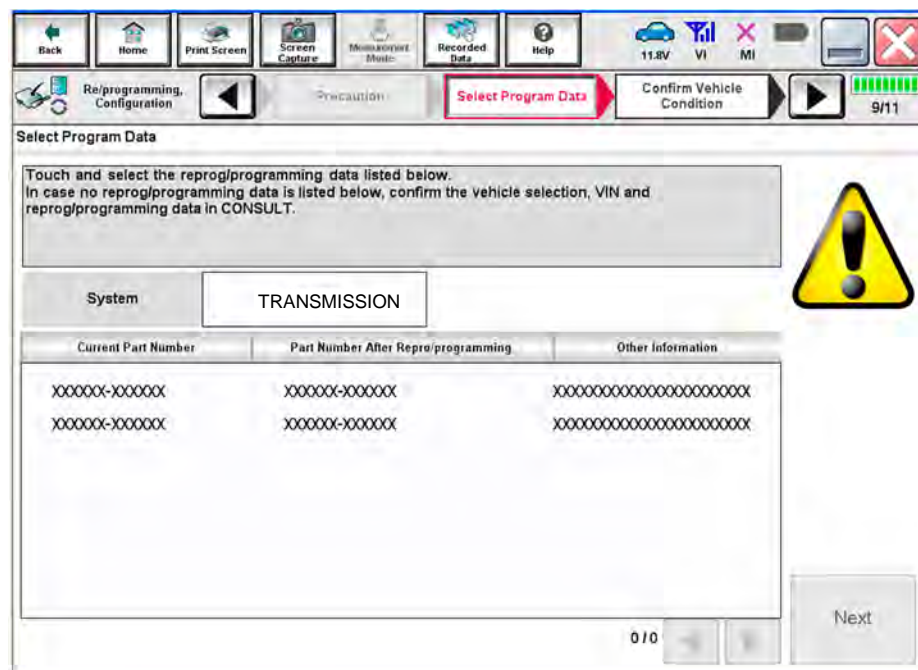

Figure 193

174. When the screen in Figure 194 displays, reprogramming is complete.

HINT: If the screen in Figure 194 does not display (indicating that reprogramming did not complete), refer to the information on the next page.

175. Disconnect the battery charger from the vehicle.

176. Select **Next**.

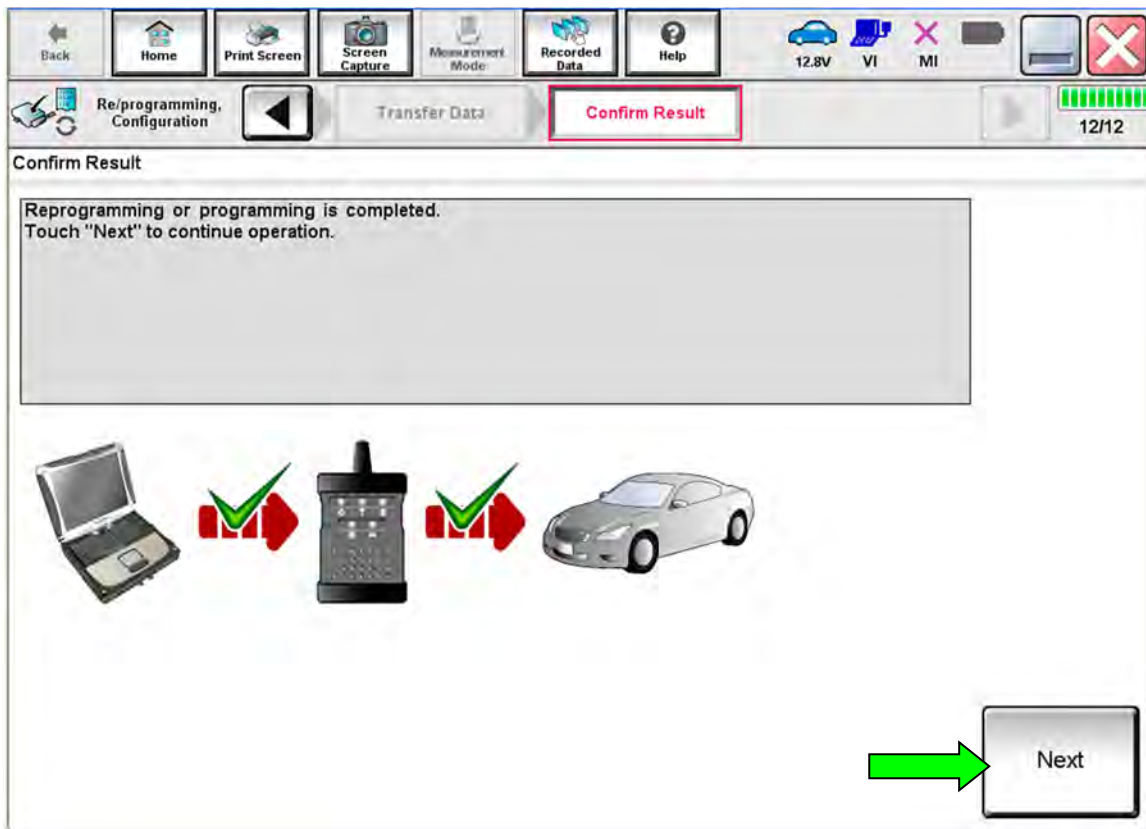

Figure 194

HINT:

- In the next step (page 100) you will perform **Erase All DTCs**.
- DTC erase is required before C-III plus will provide the final reprogramming confirmation report.

TCU Unit Recovery

Do not disconnect the VI or shut down CONSULT if reprogramming does not complete.

If reprogramming does not complete and the “!?” icon displays, as shown in Figure 195:

- Check battery voltage (12.0 - 15.5 V).
- Ignition is ON, engine OFF. Or if EV in Ready Mode.
- External Bluetooth® devices are OFF.
- **All** electrical loads are OFF.
- Select **Retry** and follow the on screen instructions.
- Retry may not go through on first attempt and can be selected more than once.

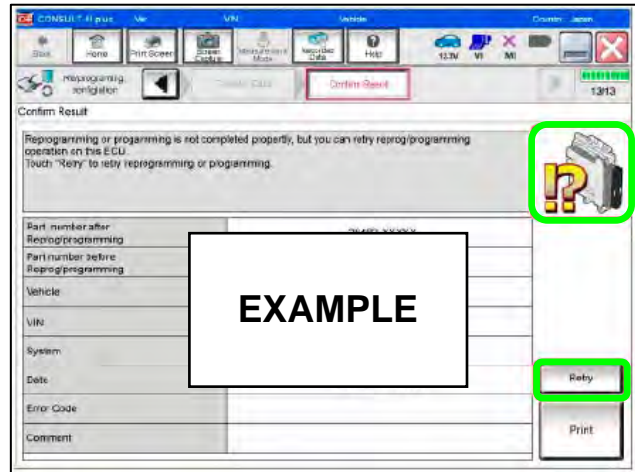

Figure 195

If reprogramming does not complete and the “X” icon displays, as shown in Figure 196:

- Check battery voltage (12.0 - 15.5 V).
- CONSULT A/C adapter is plugged in.
- Ignition is ON, engine OFF. Or if EV in Ready Mode.
- Transmission is in Park.
- All CONSULT VI cables are securely connected.
- All C-III plus updates are installed.
- Select **Home**, and restart the reprogram procedure from the beginning.

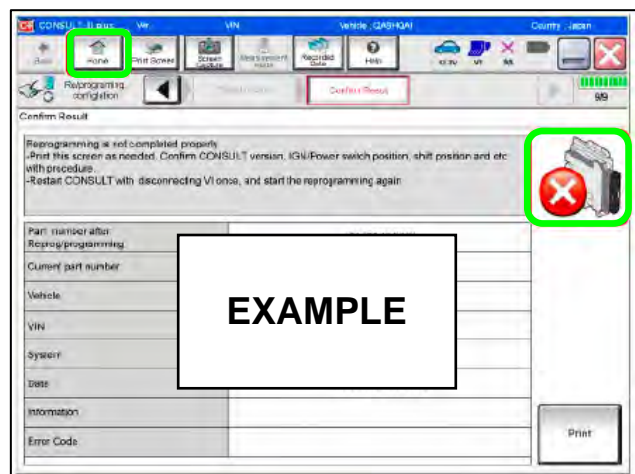

Figure 196

177. Follow the on-screen instructions to **Erase All DTCs**.
178. When the entire reprogramming process is complete, the screen in Figure 197 will display.
179. Verify the before and after part numbers are different.
180. Print a copy of this screen (Figure 197) and attach it to the repair order for warranty documentation.
181. Select **Confirm**.

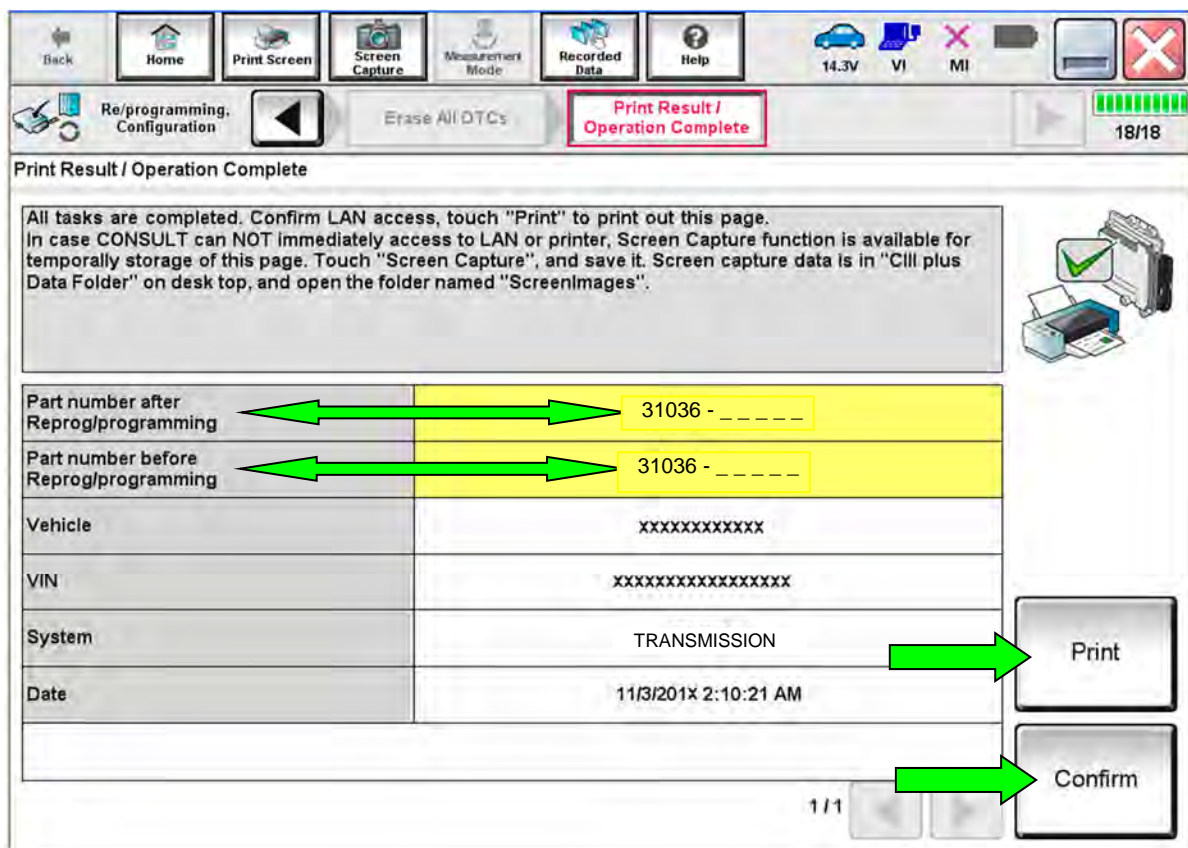

Figure 197

182. Perform **ADDITIONAL SERVICE WHEN REPLACING CONTROL VALVE**.

- Refer to **TM – Transaxle & Transmission / RE0F10E / BASIC INSPECTION**, and perform **ADDITIONAL SERVICE WHEN REPLACING CONTROL VALVE**.
- Erase all DTCs with C-III plus.

IMPORTANT: Check off these additional services as they are completed and attach this to the repair order when finished.

CHECK OFF	ADDITIONAL SERVICE PROCEDURE
	PRINT CURRENT CALIBRATION DATA
	CHECK THE SERIAL NUMBER
	WRITE THE DATA
	PRINT NEW CALIBRATION DATA
	FWD CLUTCH POINT LEARNING (Using procedure starting below)
	PERFORM SELECT LEARNING (DRIVE/REVERSE LEARNING)
	ERASE CVT FLUID DEGRADATION LEVEL DATA
	ERASE ALL DTCS

183. Verify the CVT operates normally and no abnormal noises are heard during a test drive.

FWD CLUTCH POINT LEARNING (using CONSULT-III plus)

184. Apply the vehicle's parking brake.

185. Start the engine and warm up to operating temperature (50-100° C [122-212° F]).

186. Connect the CONSULT PC to the vehicle.

187. Start CONSULT-III plus (C-III plus).

188. Wait for the plus VI to be recognized.

- The serial number will display when the plus VI is recognized.

189. Select **Diagnosis (One System)**.

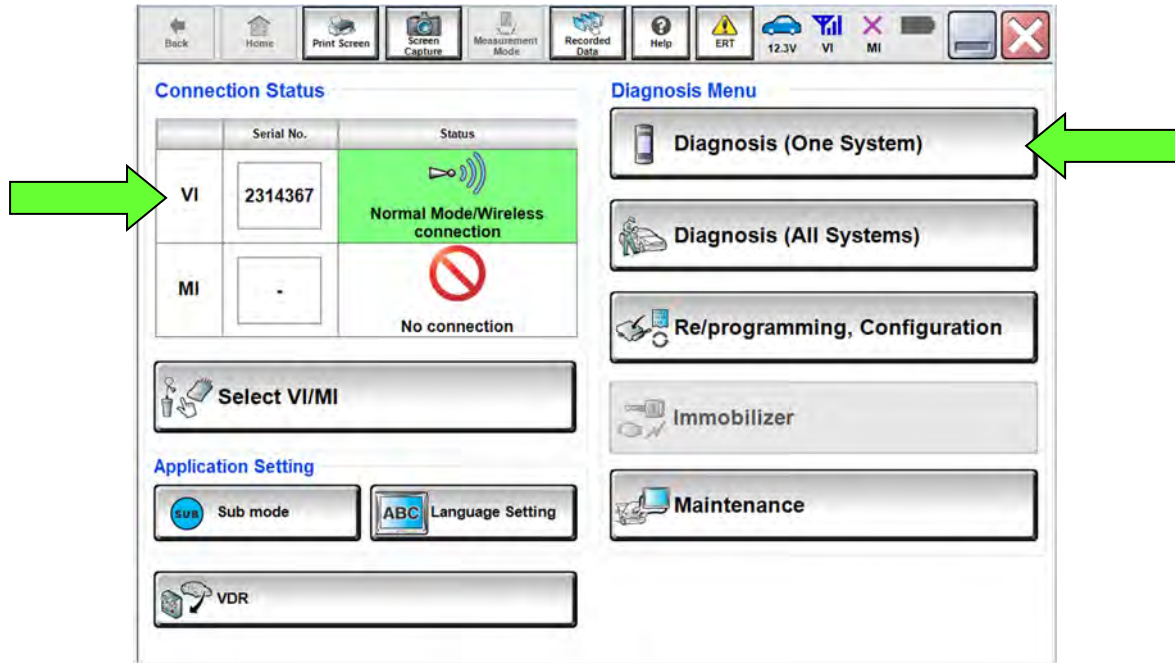

Figure 198

190. Select **Work Support** under **TRANSMISSION**.

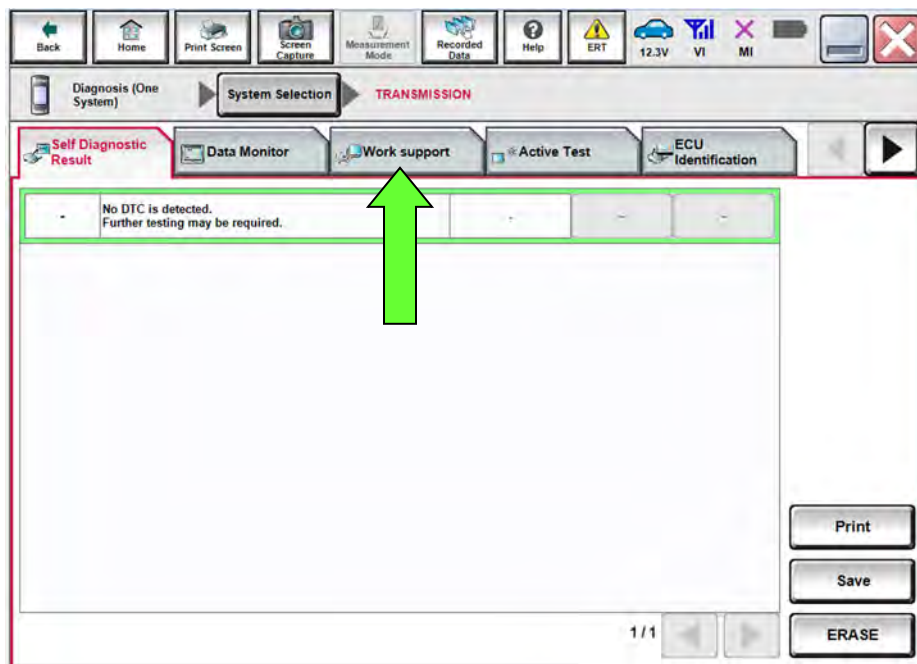

Figure 199

IMPORTANT: The following **FWD CLUTCH POINT LEARNING** will be performed twice. Once in drive (D) and once in reverse (R).

191. Select **FWD CLUTCH POINT LEARNING** and then **Start**.

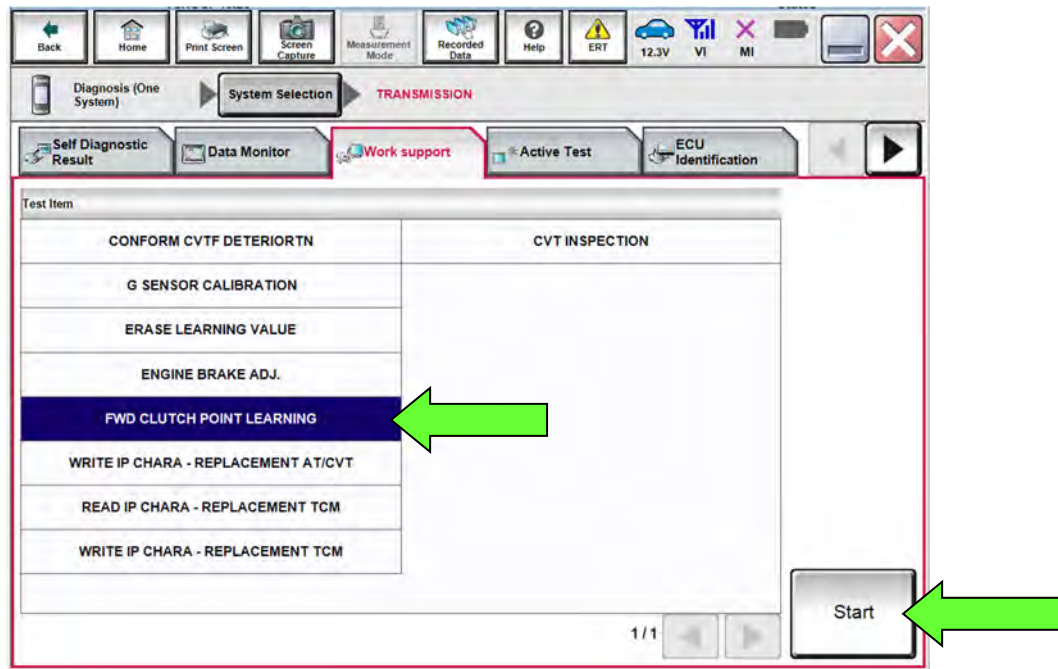

Figure 200

192. With the engine still running and at idle, depress the brake pedal and shift the CVT into neutral (N).

- Confirm that all of the required conditions indicated in Figure 201 are being met.

193. Select **Start**.

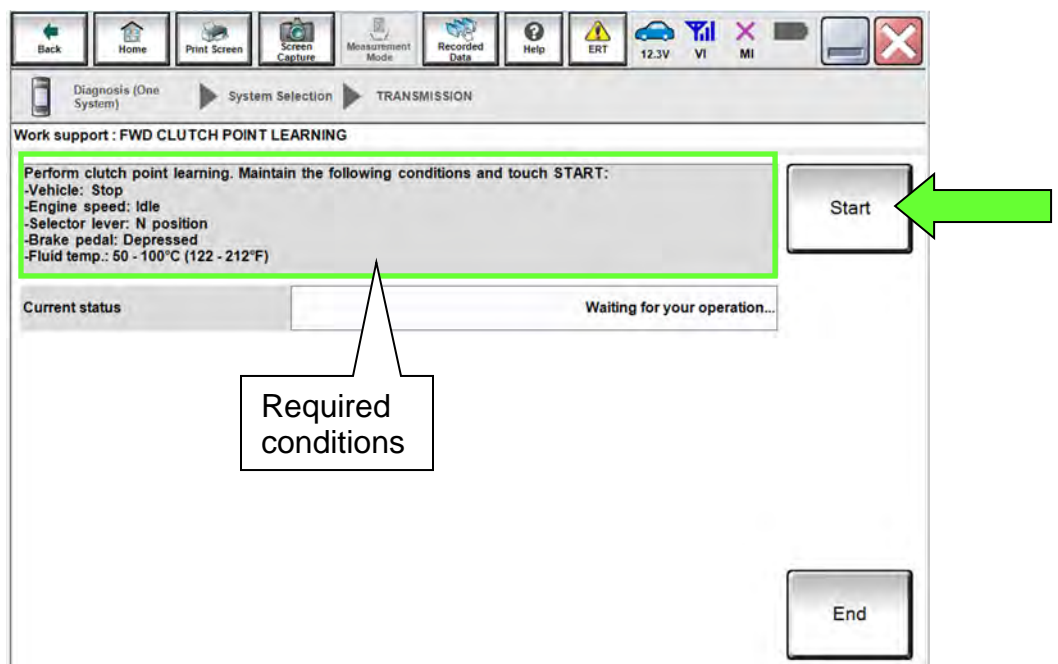

Figure 201

194. While maintaining all conditions shown in Figure 201 and the “Current status” indicates “EXECUTING”, shift the CVT into **D** and then wait until the “Current status” indicates “COMPLETED”.

HINT: This may take up to three (3) minutes to complete.

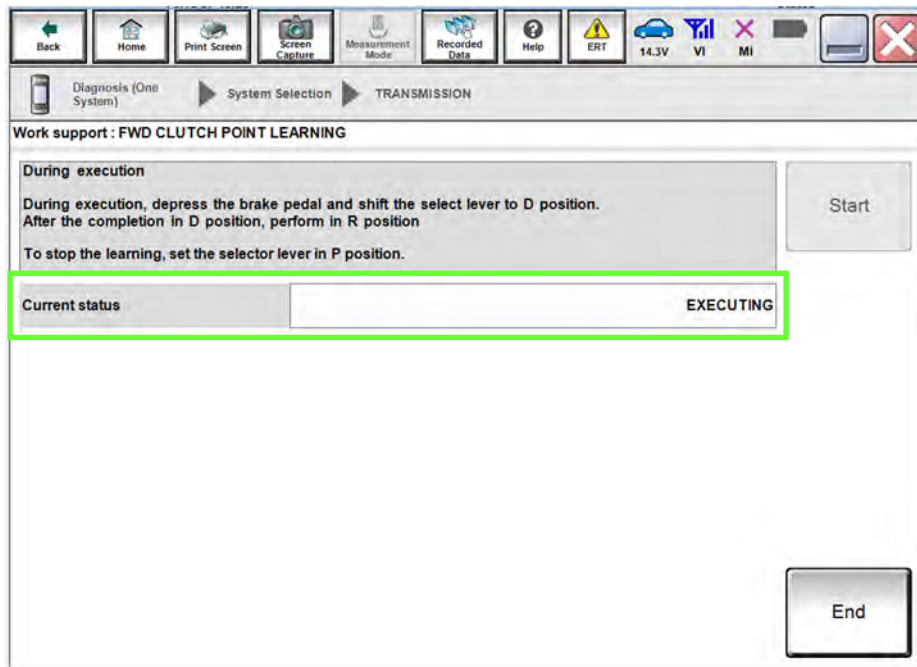

Figure 202

195. When the screen in Figure 203 is displayed, select **End**.

196. Turn the engine OFF and then back ON.

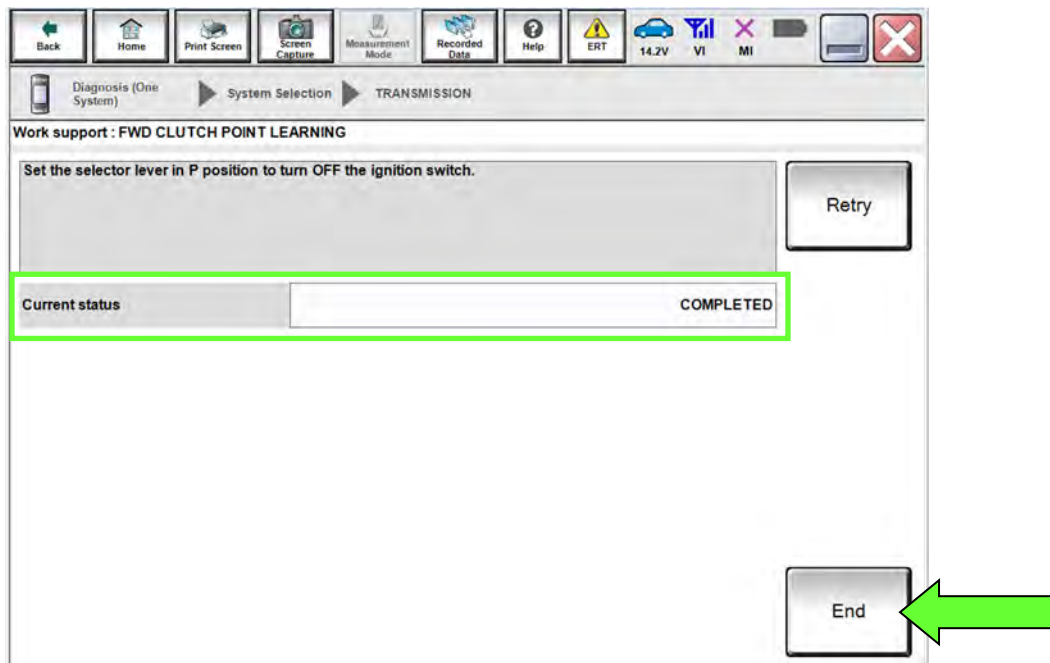

Figure 203

197. Select **FWD CLUTCH POINT LEARNING** and then **Start**.

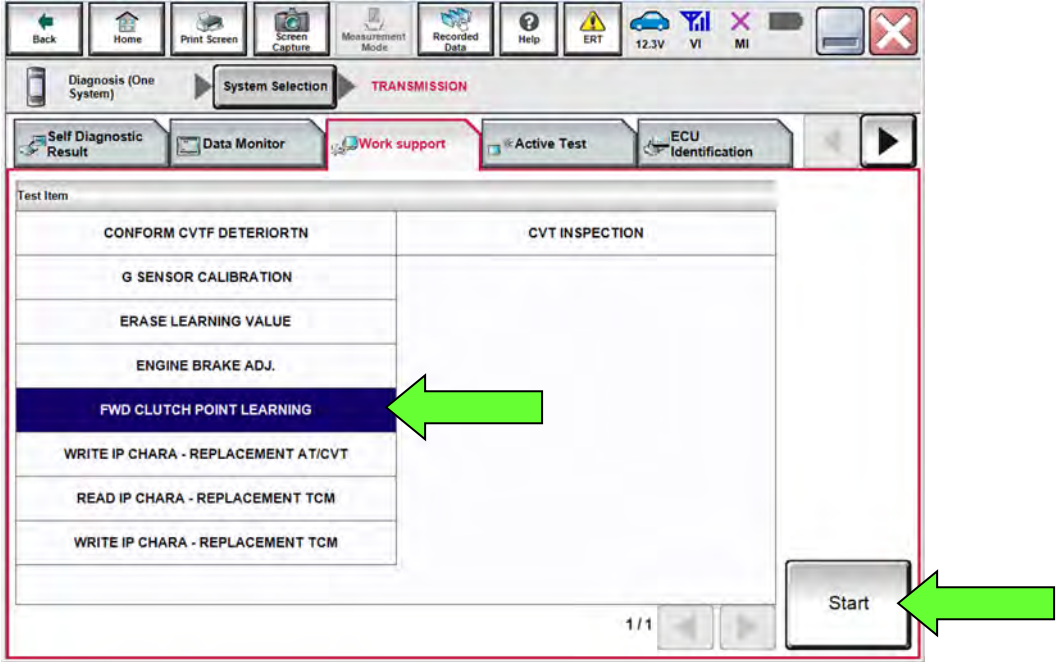

Figure 204

198. With the engine still running and at idle, depress the brake pedal and shift the CVT into neutral (N).

- Confirm that all of the conditions indicated in Figure 205 are being met.

199. Select **Start**.

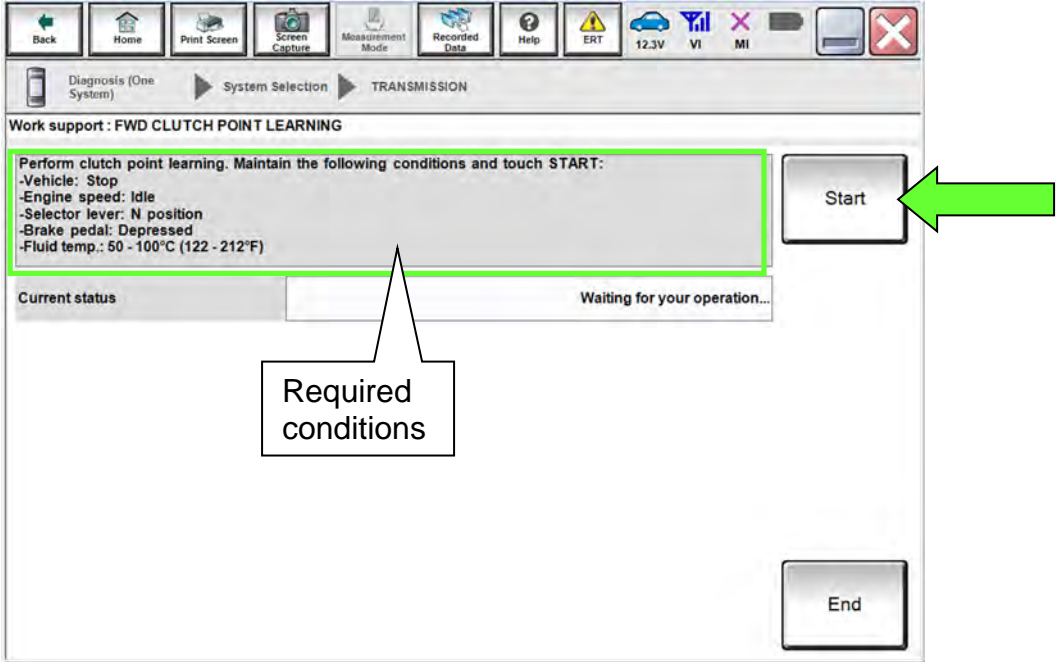

Figure 205

200. While maintaining all conditions shown in Figure 205 and the Current status indicates “EXECUTING”, shift the CVT into **R** and then wait until the Current status indicates COMPLETED.

HINT: This may take up to 3 minutes to complete.

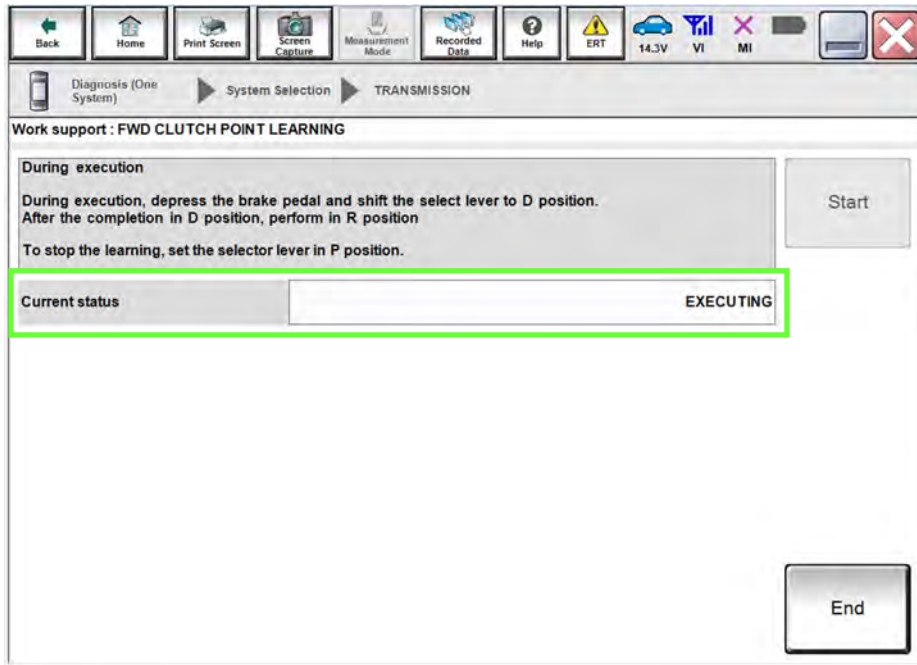

Figure 206

201. When the screen in Figure 207 is displayed, select **End**.

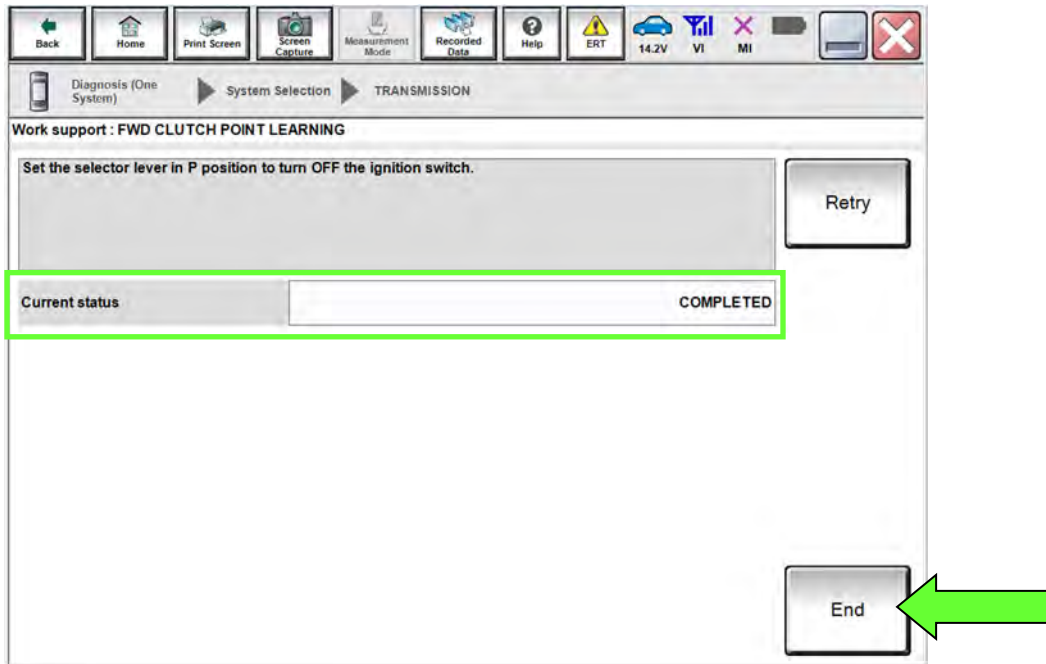

Figure 207

TROUBLESHOOTING

The Dummy Cover Will Not Sit Flush

If the dummy cover does not sit flush, the clutch pack may not be fully seated.

- Figure 208 shows clutch pack fully seated.
- Clutch pack is not fully seated if it is not below the surface that the dummy cover bolts to.
- Use instructions below to fully seat clutch pack.

HINT: Always handle the clutch pack by the input shaft.

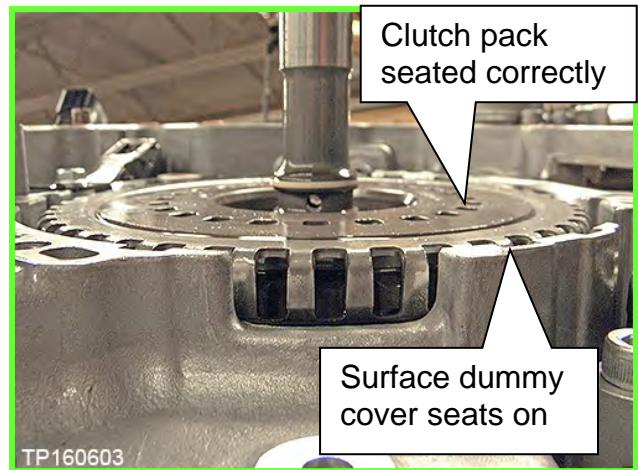

Figure 208

202. Remove the dummy cover.

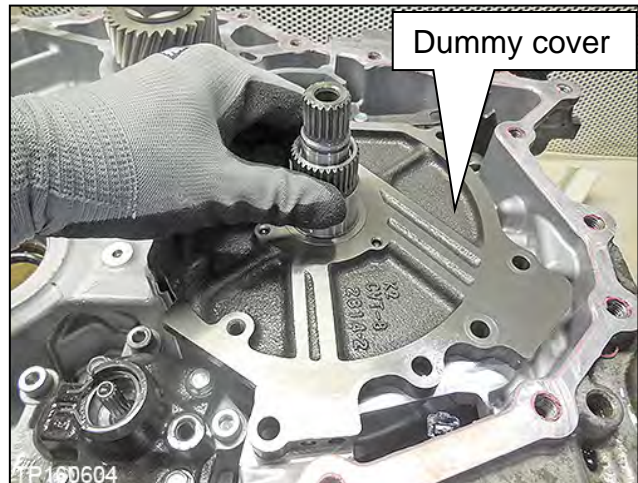

Figure 209

203. Pull up the clutch pack by the input shaft to remove the entire clutch pack.

- Make sure the O-ring is not installed at this time, or it could be damaged during reassembly.

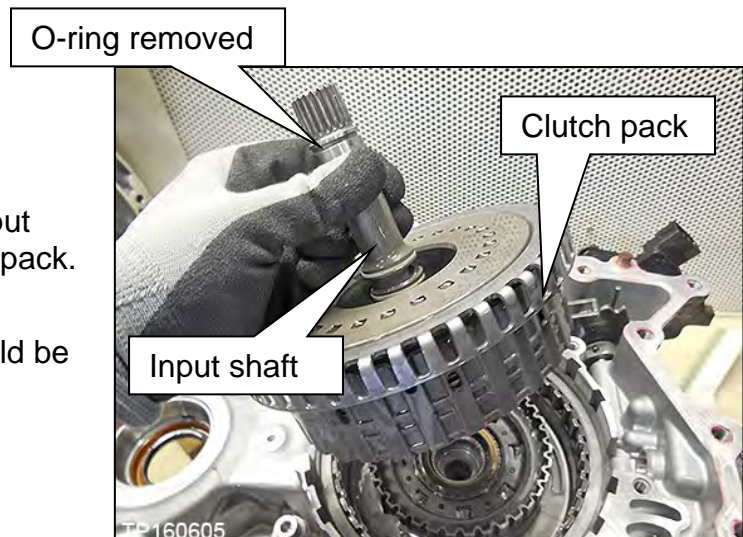

Figure 210

204. Using an appropriate tool, gently align the layers of the clutch pack.

- Bottom of the clutch pack shown in Figure 211.

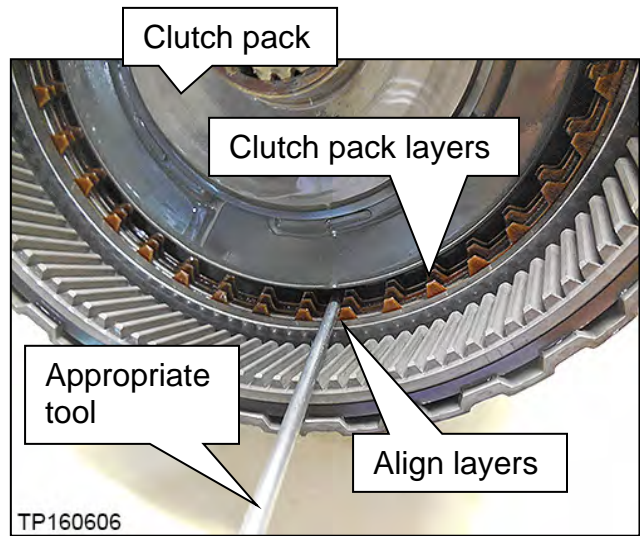

Figure 211

205. Reinsert the entire clutch pack while holding the input shaft.

206. Gently jiggle the input shaft until the clutch pack seats below case lip.

207. If the clutch pack does not seat, rotate back and forth from the input shaft and jiggle.

208. If the clutch pack still does not seat, repeat from step 203.

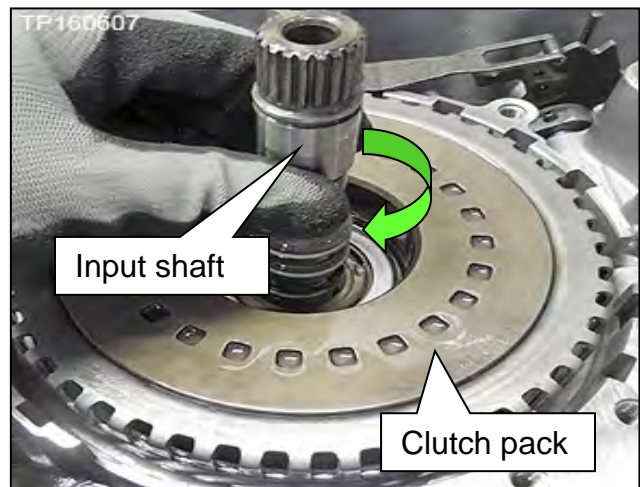

Figure 212

PARTS INFORMATION

SUB-ASSEMBLY REPAIR

HINT: Refer to the following pages for single use parts that are not included in the kits below for Quest. All other models should refer to the Library in the EPC for the Single Use Parts List.

DESCRIPTION	PART #	QUANTITY
KIT-PULLEY (1)	See Table D, below	1
CONTROL VALVE KIT (2)	3170E-29X9C	1
Loctite 5460 Sealant (3) (4)	999MP-LT5460P	(5) (6)

- (1) See the ALL REPAIRS table on page 109 for additional required parts.
- (2) Includes QR label, CD-R, and control valve assembly.
- (3) Loctite 5460 Sealant can be ordered through the Nissan Maintenance Advantage program: Phone: 877-NIS-NMA1 (877-647-6621) or Website: Order via link on dealer portal www.NNAnet.com and click on the "Maintenance Advantage" link.
- (4) For warranty repairs, Loctite 5460 Sealant **must** be used. For customer pay repairs, Loctite 5460 Sealant or its equivalents are recommended.
- (5) One container of Loctite 5460 Sealant is good for approximately 5 repairs. Sealant is not included in the kits.
- (6) Bill out Loctite 5460 Sealant (or equivalent) under **expense code 008**. Do not include the Loctite 5460 Sealant part number on the claim.

Table D

DESCRIPTION	MODEL	MODEL YEAR	PART NUMBER
KIT-PULLEY	Pathfinder	2013-2014	31214-29X7C
		2015-2020	31214-29X9B
	Altima (6 Cylinder)	2013-2014	31214-29X7A
		2015-2018	31214-29X8A
	Maxima	2016-2022	31214-29X8B
	Murano	2015-2022	31214-29X9A
	Quest	2015-2017	31214-29X9A

******Single use parts that are not included in the KIT-PULLEY******

Altima, Maxima, Murano, and Pathfinder:

Refer to the Library in the EPC for the Single Use Parts Lists.

Quest

See the Table on the next page.

SUB-ASSEMBLY REPAIR - CONTINUED******Single use parts that are not included in the kits on page 107********2015-2017 Quest**

DESCRIPTION	PART # PREFIX	QUANTITY
PACKING/SEAL (Radiator drain plug O-ring)	21481	1
SEAL - O RING (Steering high pressure line O-ring to pump)	49745	1
CLAMP (CVT fluid cooler hose clamps)	21639	2
OIL FILTER ASSY (Engine oil filter)	15208	1
WASHER - DRAIN PLUG (Engine oil drain plug washer)	11026	1
RING - RUBBER (Engine oil cooler O-ring)	21304	1
GASKET - EXHAUST (Exhaust ring gaskets to catalyst)	20691	2
BEARING - SEAL, EX (Exhaust seal bearing to center exhaust)	20695	1
NUT (Exhaust nuts to catalyst B1)	01223	3
NUT (Lower strut nuts)	54588	4
PIN - COTTER (Axle Cotter pin)	40073	2
NUT - LOCK, FRONT WHEEL BEARING (Wheel hub lock nut)	40262	2
SEAL - O RING (Steering high pressure line O-ring to steering gear)	49745	1
NUT (Mounting nut b/w transverse link and front suspension member)	54588	4
NUT (Engine mounting insulator [RH] upper nuts)	11258	3
SEAL - O RING (Fill-tube O-ring)	31084	1
CLAMP (CVT water hose clamps)	16439	2
GASKET (CVT drain plug gasket)	11026	1
SEAL - O RING (O-ring: CVT fluid overflow plug)	31526-3VX0B	1

CONTROL VALVE REPLACEMENT

DESCRIPTION	PART #	QUANTITY
CONTROL VALVE KIT (1)	3170E-29X9C	1

(1) See the ALL REPAIRS table on page 109 for additional required parts.

******Single use parts that are not included in the above kit******

DESCRIPTION	PART # PREFIX	QUANTITY
CLAMP (CVT fluid cooler hose clamps)	21639	2
GASKET (CVT drain plug gasket)	11026	1
Pathfinder ONLY O-Ring (External CVT cooler O-rings)	22180-9NB0A	2

ALL REPAIRS

DESCRIPTION	PART #	QUANTITY
Transmission Cooler Cleaner	999MP-AM006P	As needed
Nissan NS-3 CVT Fluid (1) (2)	999MP-NS300P	As needed
Lens Swab packet (3)	J-51963	As needed

- (1) Nissan NS-3 CVT Fluid can be ordered through the Nissan Maintenance Advantage program: Phone: 877-NIS-NMA1 (877-647-6621) or Website: Order via link on dealer portal www.NNAnet.com and click on the "Maintenance Advantage" link.
- (2) For warranty repairs, Nissan NS-3 CVT Fluid **must** be used. For customer pay repairs, Nissan NS-3 CVT Fluid or its equivalents are recommended.
- (3) Shop supplies.

THRUST BEARING (TYPE 1)

DESCRIPTION	PART #: 31407-	BEARING THICKNESS	QTY
THRUST BEARING	1XZ0B or X270A	3.57 mm	1 of each is included in the kit. Select 1 for installation.
	1XZ0C or X270B	3.75 mm	
	1XZ0D or X270C	3.93 mm	
	1XZ0E or X270D	4.1 mm	
	1XZ1A or X270E	4.28 mm	
	1XZ1B or X271A	4.46 mm	
	1XZ1C or X271B	4.61 mm	
	1XZ1D or X271C	4.79 mm	

BEARING RACE (TYPE 2)

DESCRIPTION	PART #: 31435-	BEARING THICKNESS	QTY
RACE – BRG	3WX0A	0.6 mm	1 of each is included in the kit. Select 1 for installation.
	3WX0B	0.8 mm	
	3WX0C	1.0 mm	
	3WX0D	1.2 mm	
	3WX1A	1.4 mm	
	3WX1B	1.6 mm	
	3WX1C	1.8 mm	

PARTS KITS REFERENCE TABLE (Parts are listed in order of installation)

IMPORTANT: Check off parts as they are used and attach this to the repair order when finished.

CHECK OFF	DESCRIPTION	PART #	QUANTITY
	PUMP ASSY-OIL	31340-3WX0A	1
	SEAL-O RING (Pump fitting bolt)	31526-28X0C	1 (of 7)
	SEAL-O RING (Filter cover)	31526-3VX0A	1
	FILTER ASSY-OIL GOVENOR (CVT fluid filter)	31726-28X0A	1
PULLEY ASSY-CVT (Sub-assembly)	MY13-14 Pathfinder	31209-29X8C	1
	MY13-14 Altima	31209-29X8A	
	MY15-18 Altima, MY15-22 Murano & MY15-17 Quest	31209-29X9A	
	MY16-22 Maxima & MY15-20 Pathfinder	31209-29X9B	
	CAP-GUIDE, CHAIN (Lubrication cap)	31268-3WX0A	2
	SEAL-O RING (O-ring between CVT case and side cover)	31526-28X0A	1
	Loctite 5460 Sealant	999MP-LT5460P	As needed
	BOLT (For sub-assembly side cover)	31377-1XZOB	19 (of 43)
	SEAL-O RING (Pulley retainer bolts)	31526-28X0C	6 (of 7)
	SEAL OIL-DIFFER (Differential side oil seal; CVT case side)	38342-3WX0C	1
	THRUST BEARING (Type 1)	See page 62	1
	RACE-BRG (TYPE 2)	See page 67	1
	SEAL ASSY-OIL (Torque converter)	31375-1XF00	1
	SEAL OIL-DIFFER (Torque converter side, front wheel drive only)	38342-3WX0D	1
	SEAL-O RING (Input shaft)	31526-80X01	1
	Loctite 5460 Sealant	999MP-LT5460P	As needed
	BOLT (Torque converter housing)	31377-1XZOB	24 (of 43)
	SEAL-LIP (Between CVT and control valve)	31528-1XZ0A	1
	VALVE ASSY-CONTROL (Valve body)	31705-29X0C	1
	BAND (Zip tie for bracket)	24224-3VX0B	1
	BRACKET (Temperature sensor bracket)	31069-3VX0D	1
	STRAINER ASSY-OIL, AUTO TRANS	31728-29X0D	1
	GSKT-OIL PAN	31397-1XF0D	1
	WASHER-DRAIN (For drain plug)	11026-JA00A	1
	SEAL-O RING (Speed Sensor)	31526-1XG0C	1
	SEAL-O RING (CVT filler plug at converter housing)	31526-3VX0B	1
	Nissan NS-3 CVT Fluid	999MP-NS300P	As needed
	SEAL-O RING (Transfer case to CVT. AWD only)	33118-4BA0A	1
	SEAL-O RING (External Oil Cooler O-ring for Pathfinder only)	22180-9NB0A	2
	Complete CVT Flush Procedure		
	Perform ADDITIONAL SERVICE WHEN REPLACING CONTROL VALVE (page 101)		

CLAIMS INFORMATION

IF DTC P17F1 is stored and Sub-Assembly is replaced

Submit a Primary Part (PP) type line claim using the following claims coding:

OPERATION	PFP	OP CODE	SYM	DIAG	FRT
CVT R&R	(1)	JD01AA	ZE	32	(2)
		JD023A			
Inspect CVT Chain, Chain = NG (Includes control valve R&I)		JX36AA			1.1
Replace CVT Sub-assembly MY13-14 Pathfinder, MY16-22 Maxima or MY13-18 Altima V6		JX45AA			3.2
Replace CVT Sub-assembly MY15-20 Pathfinder or MY15-22 Murano or MY15-17 Quest		JX53AA			3.4
Reprogram TCM		JE99AA			(2)

- (1) Reference the **PARTS INFORMATION** Table (Table D on page 109) and use the applicable Belt and Pulley Assembly Part Number as the Primary Failed Part.
- (2) Reference the current Nissan Warranty Flat Rate Manual and use the indicated Flat Rate Time.

HINT: FRT allows adequate time to access DTC codes. No other diagnostic procedures subsequently required. Do NOT claim any diagnostic OP Codes with this claim.

EXPENSE CODE

EXPENSE CODE	DESCRIPTION	MAX AMOUNT
008	Sealant	\$12.46

OR

IF DTC P17F0 is stored and Sub-Assembly is replaced

Submit a Primary Part (PP) type line claim using the following claims coding:

OPERATION	PFP	OP CODE	SYM	DIAG	FRT
CVT R&R	(1)	JD01AA	ZE	32	(2)
		JD023A			
Replace CVT Sub-assembly (Includes control valve R&I) MY13-14 Pathfinder, MY16-22 Maxima, or MY13-18 Altima V6		JX50AA			4.0
Replace CVT Sub-assembly (Includes control valve R&I) MY15-20 Pathfinder or MY15-22 Murano or MY15-17 Quest		JX54AA			4.2
Reprogram TCM		JE99AA			(2)

- (1) Reference the **PARTS INFORMATION** Table (Table D on page 109) and use the applicable Belt and Pulley Assembly Part Number as the Primary Failed Part.
- (2) Reference the current Nissan Warranty Flat Rate Manual and use the indicated Flat Rate Time.

HINT: FRT allows adequate time to access DTC codes. No other diagnostic procedures subsequently required. Do not claim any diagnostic OP codes with this claim.

Proceed to the next page for additional CLAIMS INFORMATION.

CLAIMS INFORMATION - CONTINUED

EXPENSE CODE

EXPENSE CODE	DESCRIPTION	MAX AMOUNT
008	Sealant	\$12.46

OR

If DTC P17F1 is stored and Control Valve is replaced (chain inspection shows no signs of chain slip, OK):

Submit a Primary Part (PP) type line claim using the following claims coding:

OPERATION	PFP	OP CODE	SYM	DIAG	FRT
Inspect CVT Chain, Chain = OK	(1)	JX37AA	ZE	32	0.4
Replace Valve Body		JD48AA			(2)
Reprogram TCM		JE99AA			(2)

- (1) Reference the **PARTS INFORMATION** Table and use the applicable Control Valve Kit part number (3170E-29X9C) as the Primary Failed Part.
- (2) Reference the current Nissan Warranty Flat Rate Manual and use the indicated Flat Rate Time.
HINT: FRT allows adequate time to access DTC codes. No other diagnostic procedures subsequently required. Do NOT claim any diagnostic OP Codes with this claim.

Type 1 and Type 2 Additional Reference Images

TYPE 1	TYPE 2
2013-2014 Pathfinder	2015-2020 Pathfinder
2016-2022 Maxima	2015-2022 Murano
2013-2018 Altima (6 Cylinder Only)	2015-2017 Quest

Type 1

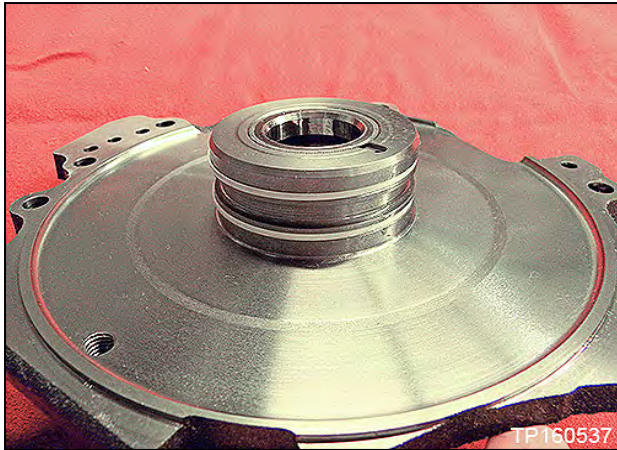

Type 2

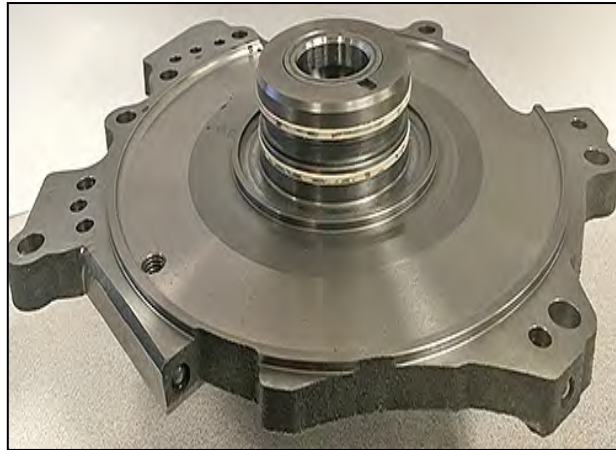

Type 1

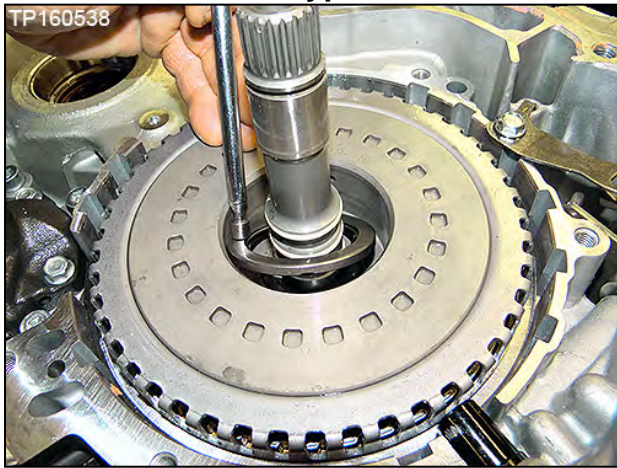

Type 2



Type 1

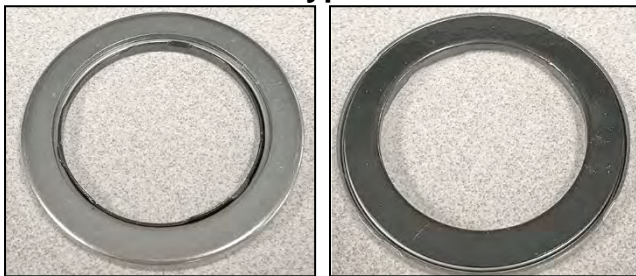

Type 2

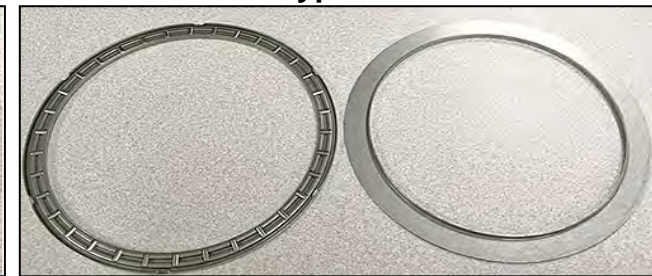

Type 1

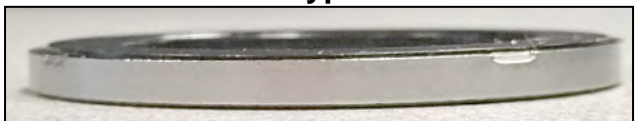

Type 2



REMINDER! Attach the following to the repair order:

- Total EndPlay (A) calculation (page 65)
- Total EndPlay (C) calculation (Page 72)
- C-III plus screen showing the TCM part number before and after the reprogramming (Step 180 on page 100)
- C-III plus screen showing the current calibration data (Step 180 on page 100)
- C-III plus screen showing the new calibration data (Step 180 on page 100)
- Parts Kit Reference Table (Page 113)

AMENDMENT HISTORY

PUBLISHED DATE	REFERENCE	DESCRIPTION
April 27, 2017	NTB17-039	Original bulletin published
May 2, 2017	NTB17-039a	Amended to change information on page 1
June 29, 2017	NTB17-039b	Minor changes made to the PARTS INFORMATION and PARTS KITS REFERENCE TABLE , with related changes throughout the bulletin
October 12, 2017	NTB17-039c	Added models, model year and additional SERVICE PROCEDURE information
October 26, 2017	NTB17-039d	Thrust bearing quantity information clarified in PARTS INFORMATION
March 5, 2018	NTB17-039e	Added Quest to APPLIED VEHICLES and information related to Quest on pages 25, 100, 102, 103 and 105
March 14, 2018	NTB17-039f	CLAIMS INFORMATION added
October 8, 2019	NTB17-039g	TCM reprogramming added
October 30, 2019	NTB17-039h	CLAIMS INFORMATION on page 111 and step reference on page 90 revised
March 11, 2020	NTB17-039i	2018 models added, Table C revised, and single use parts lists added to PARTS INFORMATION
March 25, 2020	NTB17-039j	Complete part number for SEAL - O RING (O-ring: CVT fluid overflow plug) in PARTS INFORMATION added
September 30, 2020	NTB17-039k	2019 models added, Table C revised, revised step 178, revised "Additional SERVICE PROCEDURE " table on page 100
December 23, 2020	NTB17-039l	PARTS INFORMATION updated
February 19, 2021	NTB17-039M	Revised step 8 and step 160
December 7, 2021	NTB17-039N	Thrust bearing part number options added to tables on pages 66 and 111
March 9, 2022	NTB17-039O	APPLIED VEHICLES revised, and changes made on pages 12, 25, 92, 95, 108, 112-115
May 9, 2023	NTB17-039P	APPLIED VEHICLES revised, changes made on pages 4, 12, 25, 93-97, 109, 113, 114, 116 and "NOTE" references changed to "HINT"