

Service Journal

TITLE:

Aftermarket Wiring Diagrams CMA MY24

REF NO: SJ 1001860P	ISSUING DEPARTMENT: Service Operations		
CATEGORY:	SUBCATEGORY:	CAR MARKET: United States and Canada	
REVISIONS:		ISSUE DATE: 2023-04-25	STATUS DATE: 2023-04-25
		Page 1 of 147	

Background:

As a result of delays in the production of aftermarket wiring diagrams, there is a risk of missing or incorrect wiring diagrams for certain customer functions for CMA MY24 (structure week 202317 -).

Temporary Solution:

In cases of missing or incorrect wiring diagrams in VIDA, refer to the cleaned-up system-based wiring diagrams from R&D attached as a PDF.

Final Solution:

Customer function-based wiring diagrams will continuously be updated and released to VIDA once they are finished.

P319/V316/V317

623A_PP | 624A_VP

Sheet Name	Sheet Number	Sheet Name	Sheet Number
0A_P319_V316_V317	1	2P_Supplementary_Restraint_System_Igniters_HEV_PHEV	74
0B1_Overview_LHD	2	2P_Supplementary_Restraint_System_Igniters_N_HEV	75
0B2_Overview_RHD	3	2P_Supplementary_Restraint_System_Igniters_PHEV	76
1A1_Electrical_distribution_CJB_BEV	4	2R_Safety_Belt	77
1A1_Electrical_distribution_CJB_N_BEV	5	2S_Restraint	78
1A1_Electrical_distribution_EJB_BEV	6	3A_3C_Engine_management	79
1A1_Electrical_distribution_EJB_N_BEV	7	3A_3D_Engine_Management_(HEV)	80
1A3_System_relays_control_BEV	8	3A_3D_Engine_Management_VEP4_GEN3_(HEV)	81
1A3_System_relays_control_HEV	9	3A_Engine_Management_GEP3_(HEV)	82
1B1_Grounding_Engine_Body	10	3A_Engine_Management_VEP4_G3_(N_BEV)	83
1B2_Grounding_IP_Roof_Tunnel	11	3B_Management_BEV_Driveline	84
1B3_Grounding_Body_Front	12	3B_Management_Hybrid_Driveline_HEV	85
1B4_Grounding_Body_Rear_Tailgate	13	3D_Engine_thermal_management_BEV	86
1C1_EI_power_generating	14	3D_Engine_thermal_management_HEV	87
1D_Diagnostics	15	3E_Automatic_Gear_Shifting	88
1E_CAN_ABS_Braking	16	3E_Automatic_Gear_Shifting_7DCT	89
1E_CAN_Body	17	3G_4WD_Transmission	90
1E_CAN_Body_Exp	18	3M_Engine_Cranking_Control_(HEV)	91
1E_CAN_Chassie	19	3S_Fuel_Supply_Control	92
1E_CAN_Connectivity_Diagnostics	20	4A_Driver_Information	93
1E_CAN_Engine	21	4J1_Parking_Assistance_FAP	94
1E_CAN_Front_1	22	4J1_Parking_Assistance_NBEV	95
1E_CAN_Front_3	23	4J1_Parking_Assistance_PAS_PAS2	96
1E_CAN_Front_Exposed	24	4J2B_Lane_Change_Aid	97
1E_CAN_Mid_1	25	4J4_PAC_COAX	98
1E_CAN_Propulsion_1A_Front	26	5A_Climate_Control	99
1E_CAN_Propulsion_1B_Front_Hybrid	27	5A_Climate_Control_HEV_PHEV	100
1E_CAN_Propulsion_2_Centre	28	5A_Climate_Control_HVAC_ECC	101
1E_CAN_Rear_1	29	5B_Front_Seat_Comfort	102
1E_CAN_Safety_Exposed_BEV_48V_KERS	30	5B_Front_Seat_Comfort_PHEV	103
1E_CAN_Safety_Exposed_ICE_PHEV	31	5B_Rear_Seat_Comfort	104
1E_CAN_Safety_Protected	32	5F1_Passenger_Compartment_Pre-Conditioning	105
1E_FlexRay_Backbone_BEV_48V_KERS	33	5G_Steering_Wheel_Heating	106
1E_FlexRay_Backbone_ICE_PHEV	34	6A_Locking	107
1E_FlexRay_Front_2	35	6A_Locking_Front_Right	108
1E_FlexRay_Mid_2	36	6A_Locking_Rear_Right	109
1E_LIN_Body	37	6C1_Phone_As_Key	110
1E_LIN_Body_Infotainment_Powertrain	38	6C_Theft_protection	111
1E_LIN_Comfort	39	6D_Window_Manoeuvring	112
1E_LIN_MOST	40	6D_Window_Manoeuvring_Right	113
1E_LIN_POWERTRAIN_N_BEV	41	6F_Roof_Manoeuvring	114
1F1_Accessories_ALCPRP_TOWBAR	42	6K_Tailgate_and_boot_lid_manoeuvring_etc	115
1F2_Accessories_Towing_System_4/7-pole_US	43	6P_Voltage_outlet	116
1F3_Accessories_Rear_Park_Assist_Camera	44	7A_External_Amplifier	117
1F4_Accessories_USB_Hub_Installation_Aftermarket	45	7A_Infotainment	118
1F5_Accessories_Steering_Wheel_Heating	46	7A_Infotainment_N_ICUP	119
1H1_EI_Distribution_High_Voltage_BEV_623A_AWD	47	7B_Telematics_ICUP	120
1H1_EI_Distribution_High_Voltage_BEV_623A_RWD	48	7B_Telematics_N_ICUP	121
1H2_EI_Distribution_High_Voltage_PHEV	49	7C_DSRC	122
1K1_EI_Energy_Management_High_Voltage_BEV_623	50	7C_DSRC_N_ICUP	123
1K2_EI_Energy_Management_High_Voltage_BEV_3X	51	7F_Electronic_Toll_Collection	124
1K3_EI_Energy_Management_High_Voltage_PHEV	52	8A_Exterior_Light_Front	125
1L1_EI_generating_public_network_1X	53	8A_Exterior_Light_LED_Front	126
1L2_EI_generating_public_network_2X	54	8A_Exterior_Light_Rear_V316	127
1L3_EI_generating_public_network_V331_3X-4X_DC	55	8A_Exterior_Light_Rear_V331_V317	128
1L4_EI_generating_public_network_V331_3X_AC	56	8K_8H_8J_Lamp_windscreen_rear_window_cleaning	129
1L5_EI_generating_public_network_V331_4X_AC	57	8K_8H_8J_Lamp_windscreen_rear_window_cleaning_NBEV	130
1L6_EI_generating_public_network_V316_V317_3X-4X_DC	58	8N_8L_Windscreen_rear_window_defroster	131
1L7_EI_generating_public_network_V316_V317_3X_AC	59	8P_Sound_signaling	132
1L8_EI_generating_public_network_V316_V317_4X_AC	60	9A_Interior_Lights	133
1L9_EI_generating_public_network_V316_PHEV	61	9A_Interior_Lights_Doors	134
1M_EI_Distribution_Mid_Voltage	62	9A_Interior_Lights_Doors_Right	135
2A_Braking	63	9H_Instr_Control_Switch_Lighting	136
2A_Braking_48V_KERS	64	10A_Internal_7DCT_Harness	137
2A_Braking_F-TE	65	10A_Driver_Seat_Internal_Harness_High_LHD	138
2A_Braking_Hybrid	66	10A_Driver_Seat_Internal_Harness_High_RHD	139
2E2_Steering	67	10A_Driver_Seat_Internal_Harness_Mech_LHD	140
2E_Power_Steering	68	10A_Driver_Seat_Internal_Harness_Mech_RHD	141
2G_Levelling_control	69	10A_Interior_HVAC_Harness_VCC_2-ZONES_ECC	142
2M_Pedestrian_Protection	70	10A_Passenger_Seat_Internal_Harness_High_LHD	143
2N_Safety_Belt_Reminder	71	10A_Passenger_Seat_Internal_Harness_High_RHD	144
2O_Collision_Avoidance	72	10A_Passenger_Seat_Internal_Harness_Mech_LHD	145
2P_Supplementary_Restraint_System_Igniters	73	10A_Passenger_Seat_Internal_Harness_Mech_RHD	146

<p>The copying, distribution and utilization of this document as well as the communication of its contents to others without expressed authorization is prohibited. Offenders will be held liable for payment of damages. All rights reserved in the event of the grant of a patent, utility model or ornamental design registration.</p> <p>VOLVO VOLVO CAR CORPORATION</p>	Document title 623A_PP_CC_04_06_2023	
	0A_P319_V316_V317	
	Document Type DRAW/ELSY	Release Status RELEASED
	Volvo Document No 33445458	Edited April/21/2023
Issue 035	Page No 1/146	

0B Overview LHD

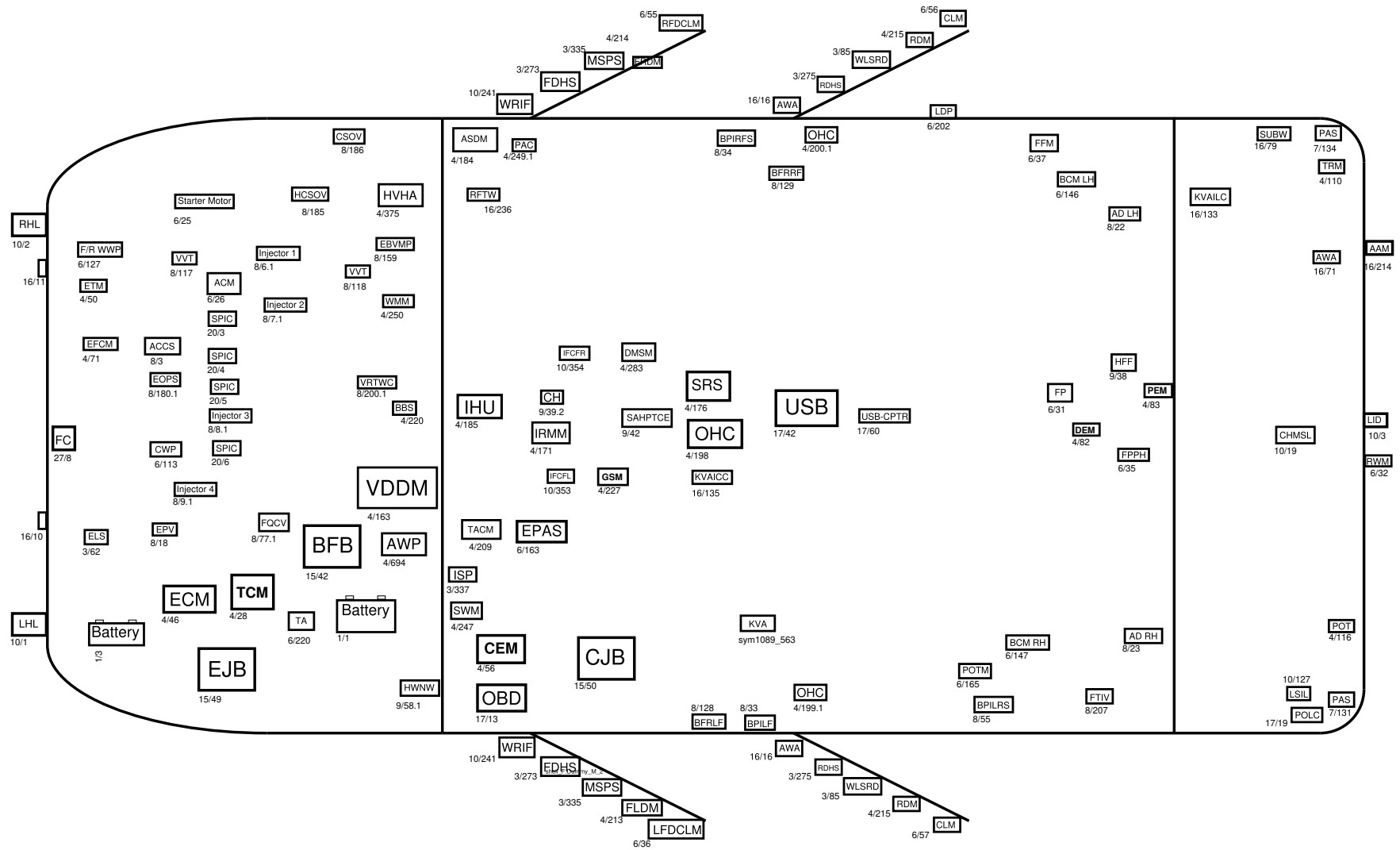

<p>The copying, distribution and utilization of this document as well as the communication of its contents to others without expressed authorization is prohibited. Offenders will be held liable for payment of damages. All rights reserved in the event of the grant of a patent, utility model or ornamental design registration.</p> <p>VOLVO VOLVO CAR CORPORATION</p>		<p>Document title: 623A_PP_CC_04_06_2023 0B1_Overview_LHD</p>	
		<p>Document Type: DRAW/ELSY</p>	<p>Release Status: RELEASED</p>
		<p>Volvo Document No: 33445458</p>	<p>Edited: November/01/2021</p>
		<p>Issue: 035</p>	<p>Page No: 2/146</p>

0B Overview RHD

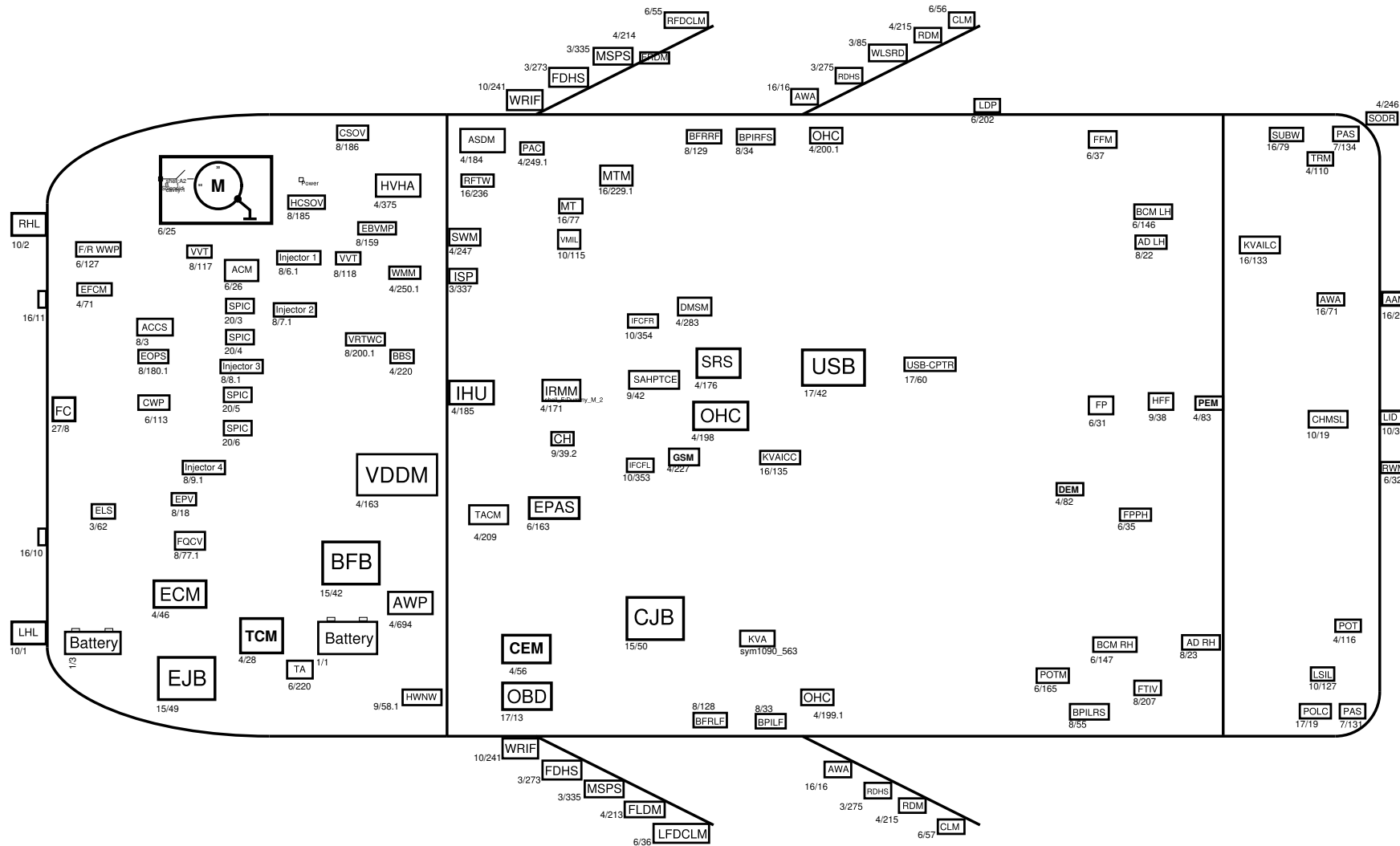

<p>The copying, distribution and utilization of this document as well as the communication of its contents to others without expressed authorization is prohibited. Offenders will be held liable for payment of damages. All rights reserved in the event of the grant of a patent, utility model or ornamental design registration.</p> <p>VOLVO VOLVO CAR CORPORATION</p>	<p>Document title: 0B2_Overview_RHD</p>		<p>623A_PP_CC_04_06_2023</p>
	<p>Document Type: DRAW/ELSY</p>	<p>Release Status: RELEASED</p>	
	<p>Volvo Document No: 33445458</p>		<p>Edited: November/01/2021</p>
	<p>Issue: 035</p>		<p>Page No: 3/146</p>

1A1_Electrical_distribution_CJB_N_BEV

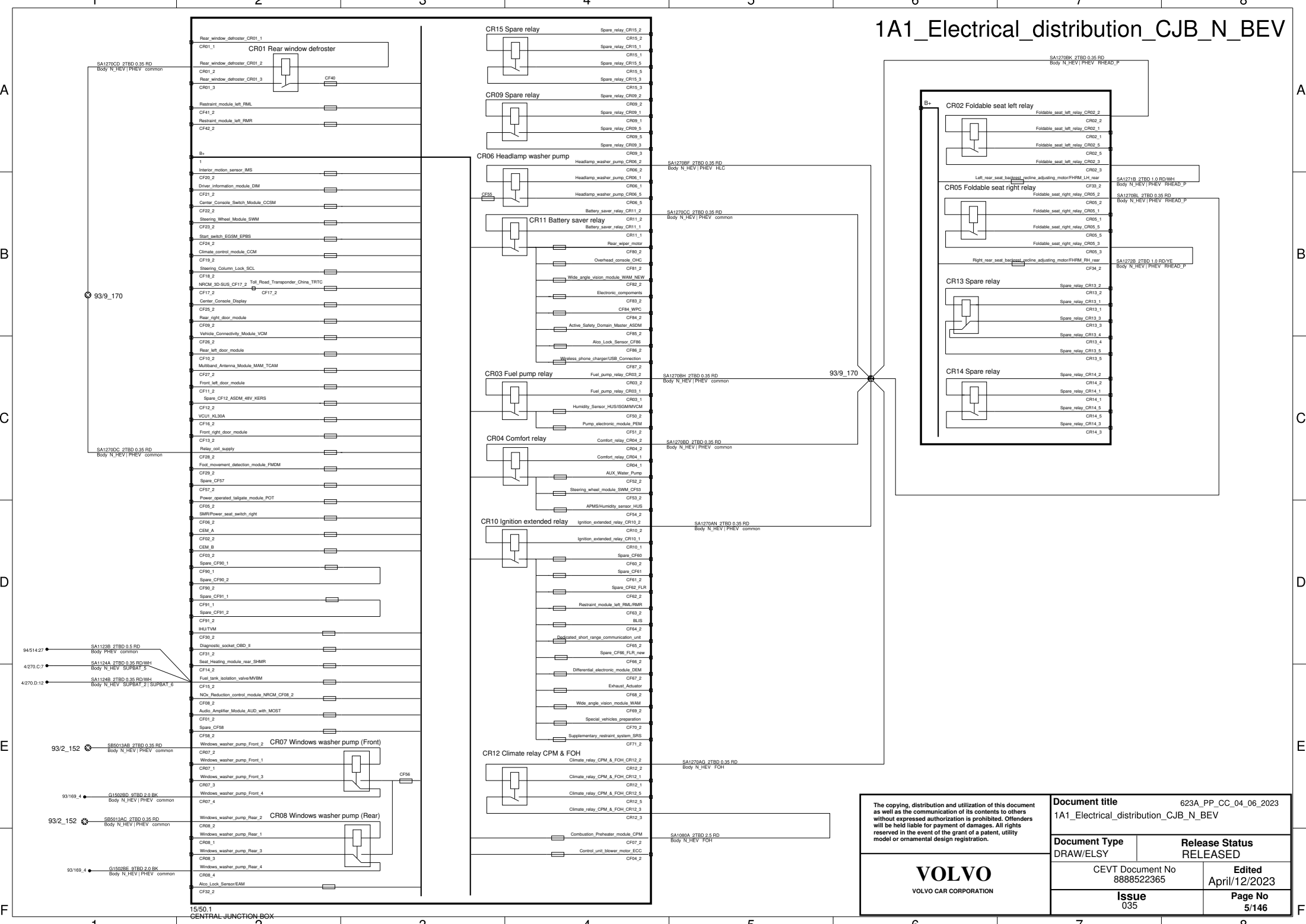

The copying, distribution and utilization of this document as well as the communication of its contents to others without expressed authorization is prohibited. Offenders will be held liable for payment of damages. All rights reserved in the event of the grant of a patent, utility model or ornamental design registration.



Document title		623A_PP_CC_04_06_2023	
1A1_Electrical_distribution_CJB_N_BEV		RELEASED	
Document Type	Release Status	Edited	Page No
DRAW/ELSY	CEVT Document No 8888522365	April/12/2023	5/146
Issue	035		

1A1 Electrical distribution EJB BEV

A
B
C
D
E
F

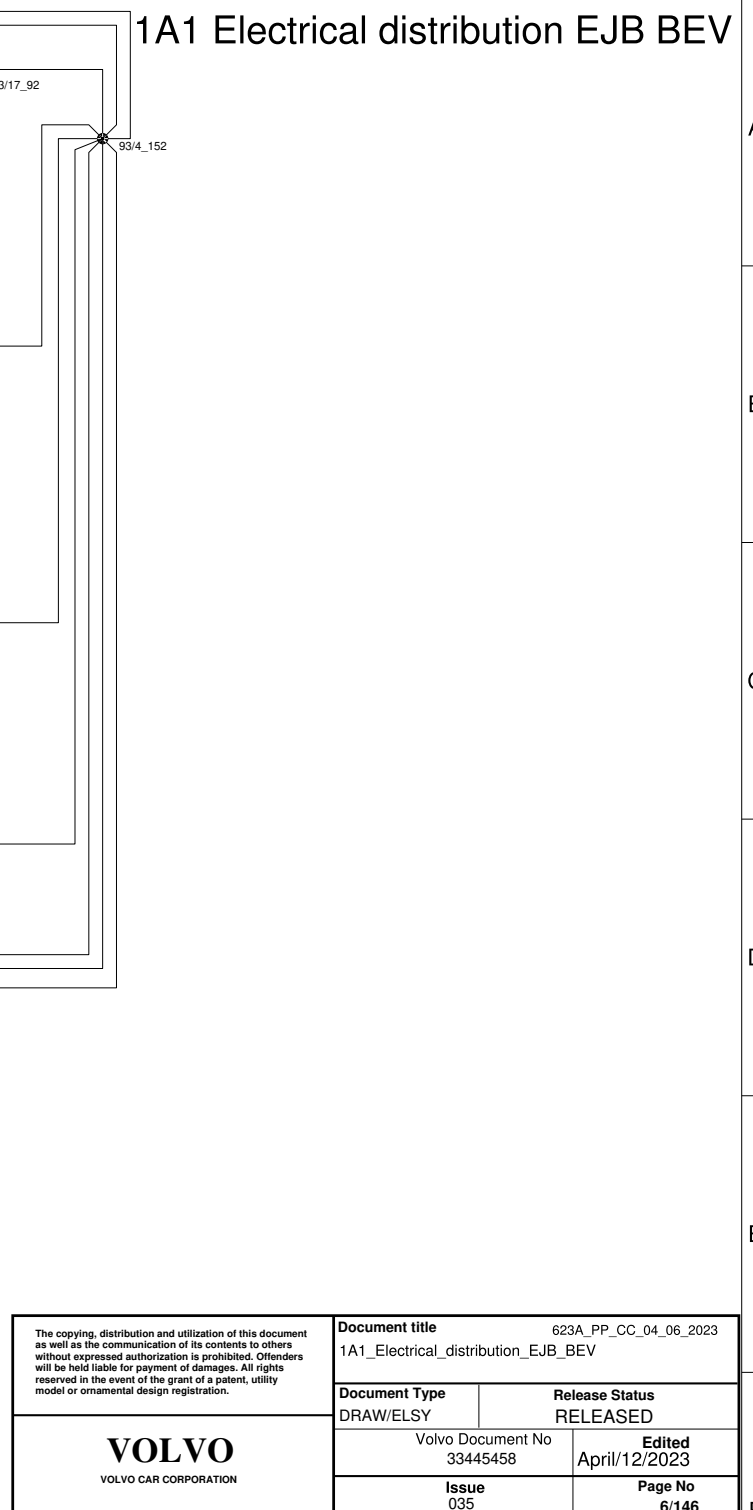
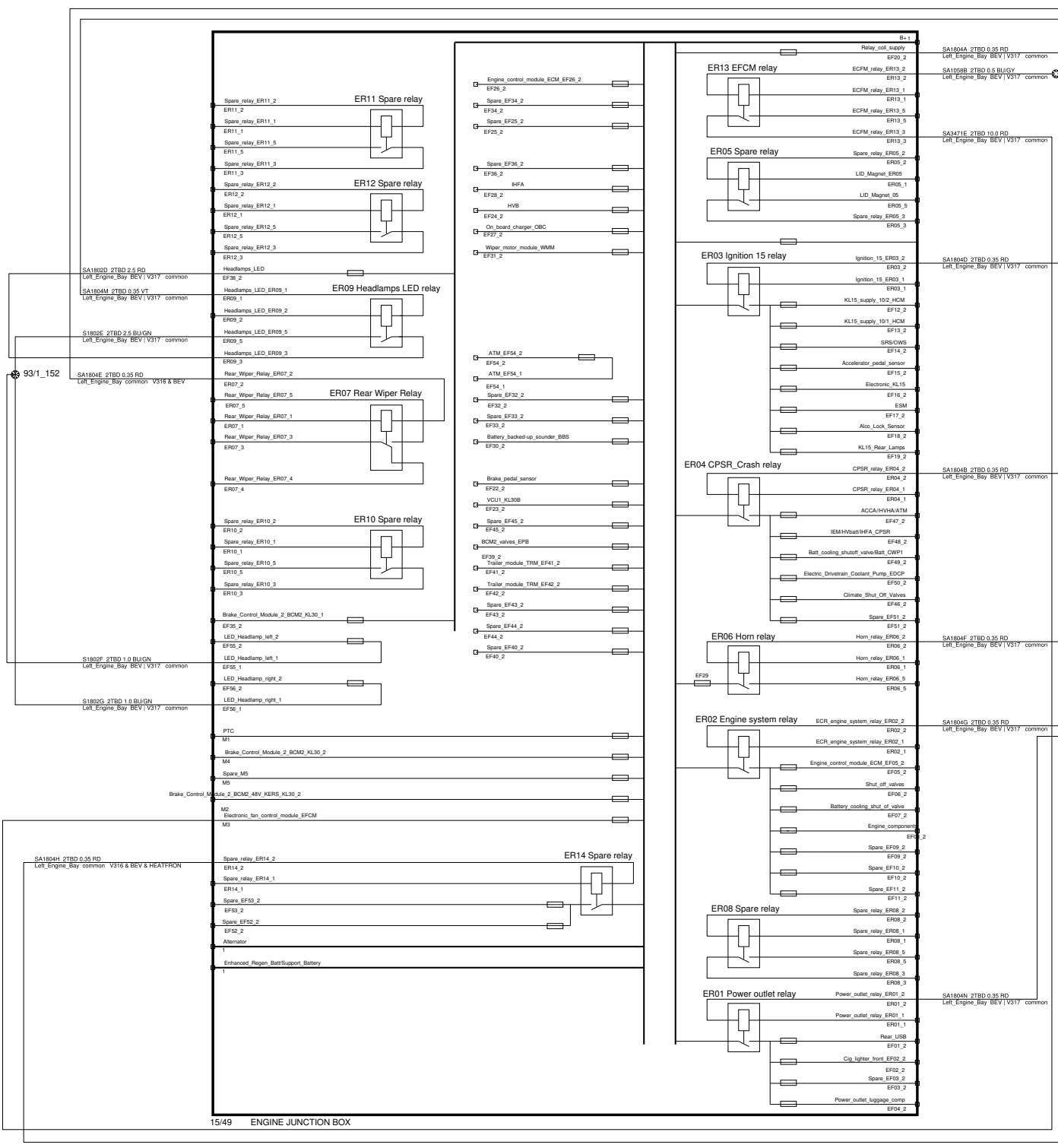

<p>The copying, distribution and utilization of this document as well as the communication of its contents to others without expressed authorization is prohibited. Offenders will be held liable for payment of damages. All rights reserved in the event of the grant of a patent, utility model or ornamental design registration.</p>		<p>Document title 623A_PP_CC_04_06_2023 1A1_Electrical_distribution_EJB_BEV</p>	
		<p>Document Type DRAW/ELSY</p>	<p>Release Status RELEASED</p>
<p>VOLVO VOLVO CAR CORPORATION</p>		<p>Volvo Document No 33445458</p>	<p>Edited April/12/2023</p>
		<p>Issue 035</p>	<p>Page No 6/146</p>

A
B
C
D
E
F

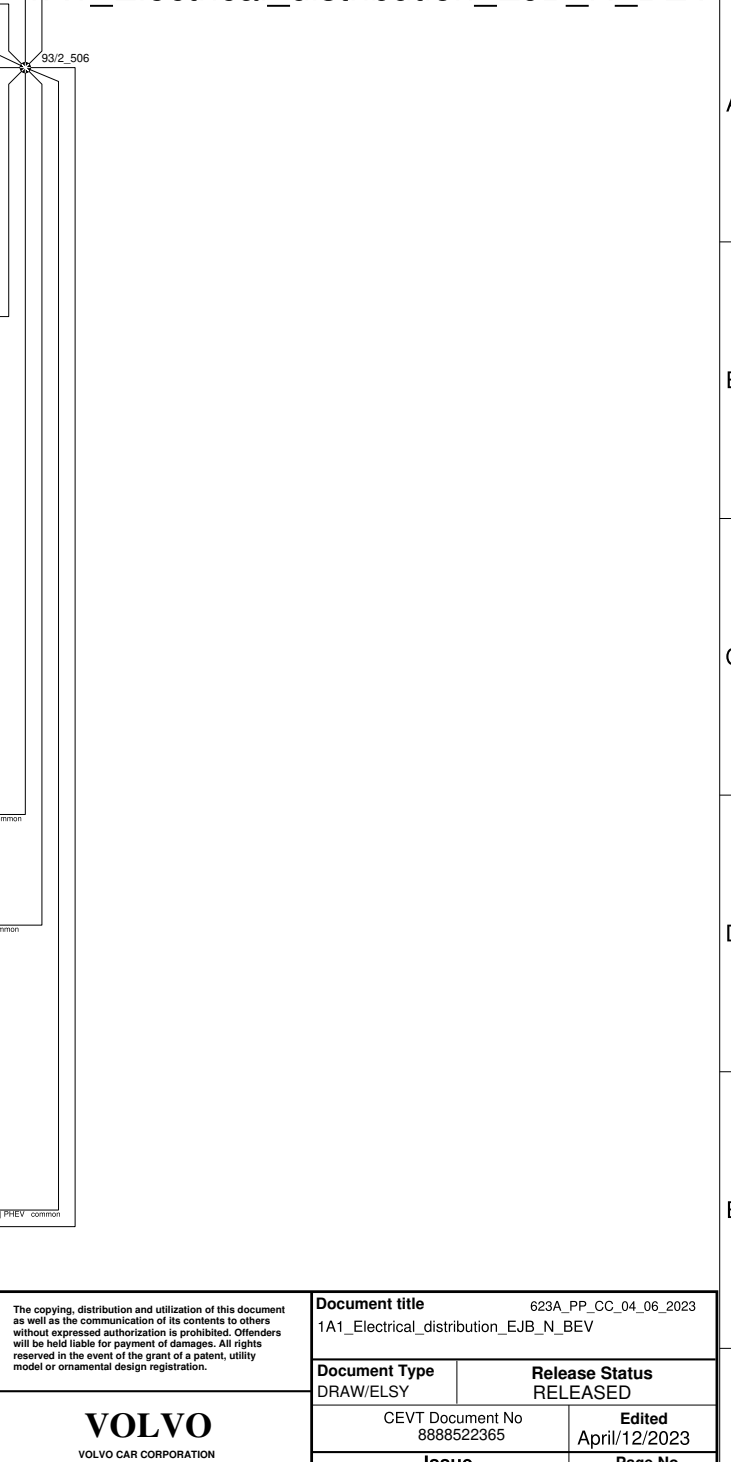
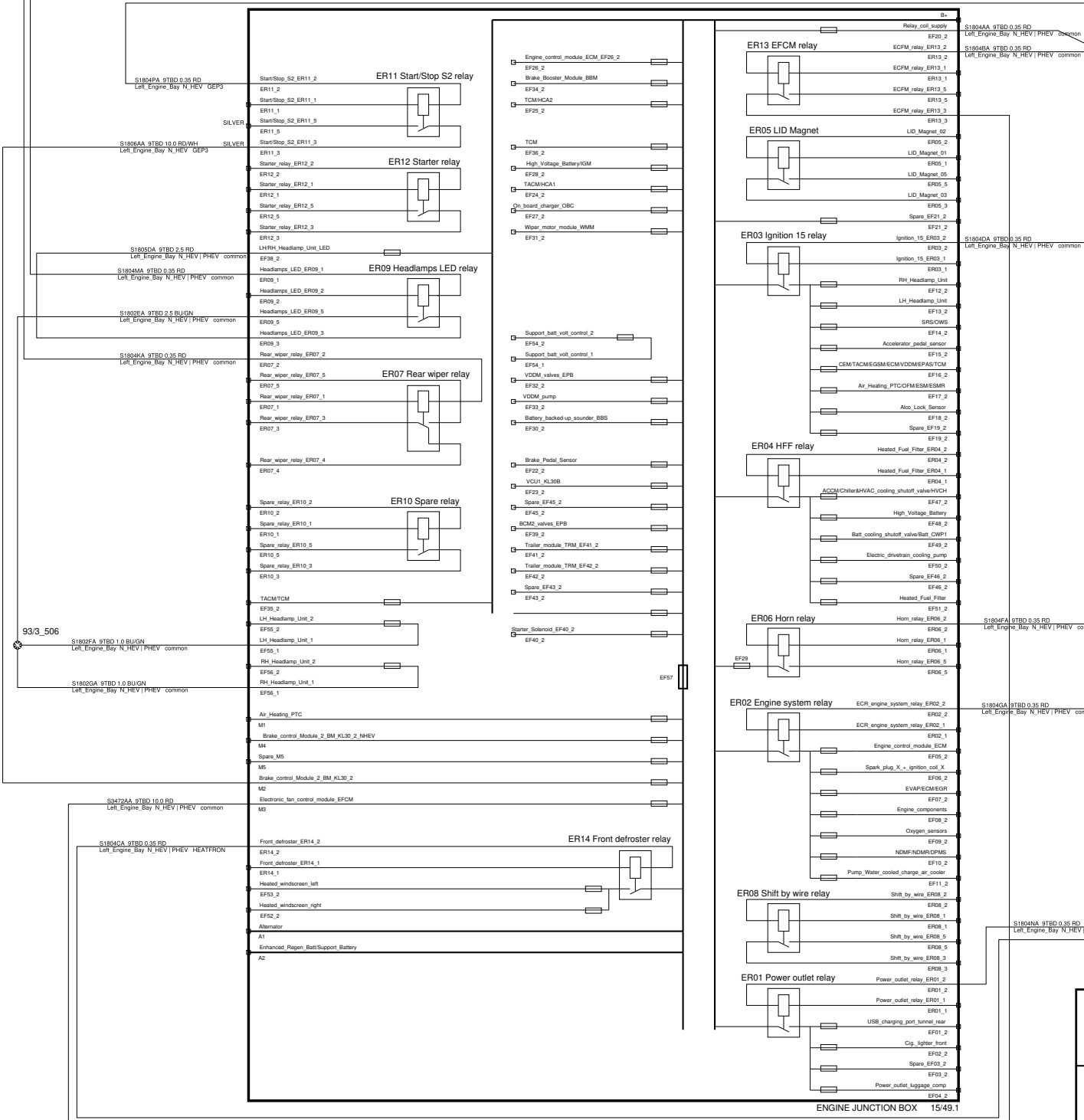

<p>VOLVO VOLVO CAR CORPORATION</p>	<p>Document title 623A_PP_CC_04_06_2023 1A1_Electrical_distribution_EJB_N_BEV</p>	
	<p>Document Type DRAW/ELSY</p>	<p>Release Status RELEASED</p>
	<p>CEVT Document No 8888522365</p>	<p>Edited April/12/2023</p>
	<p>Issue 035</p>	<p>Page No 7/146</p>

1A3 System relays control

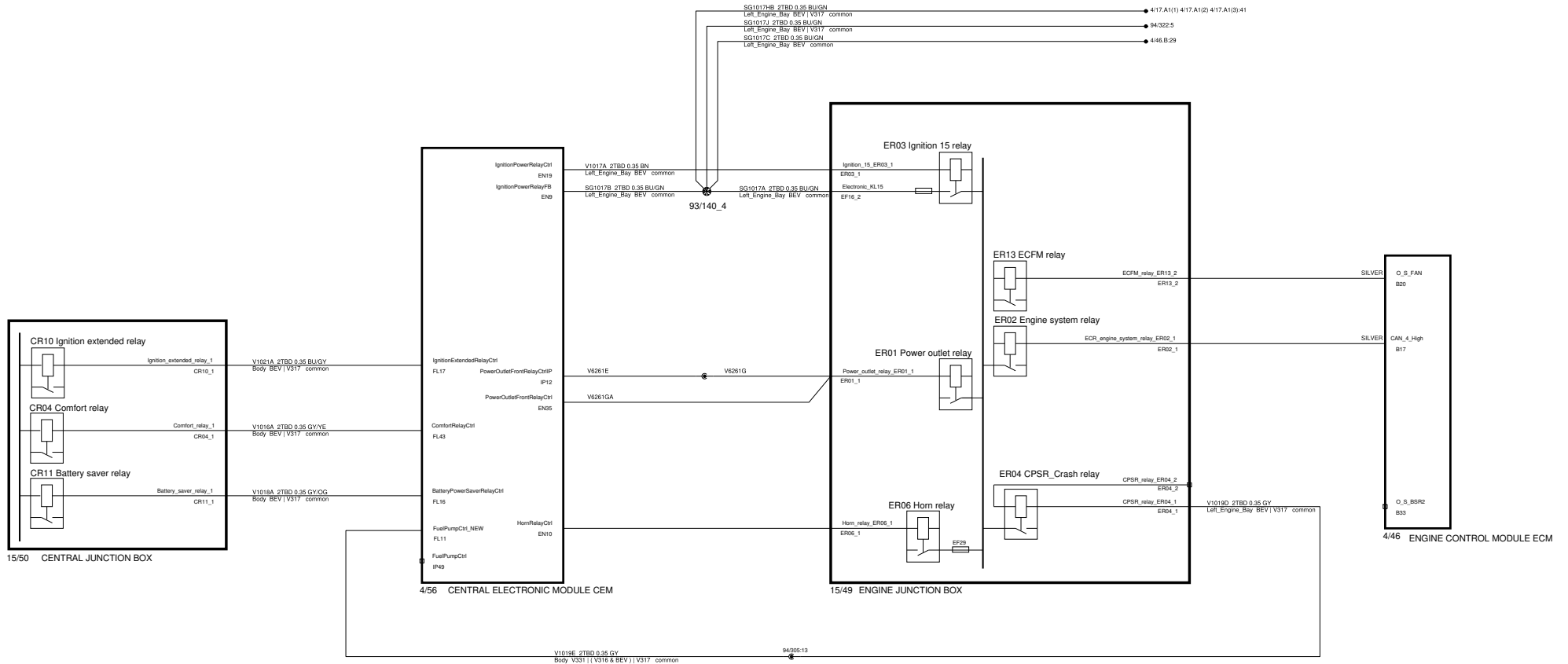

<p>The copying, distribution and utilization of this document as well as the communication of its contents to others without expressed authorization is prohibited. Offenders will be held liable for payment of damages. All rights reserved in the event of the grant of a patent, utility model or ornamental design registration.</p> <p>VOLVO VOLVO CAR CORPORATION</p>	Document title 623A_PP_CC_04_06_2023 1A3_System_relays_control_BEV	
	Document Type DRAW/ELSY	Release Status RELEASED
	Volvo Document No 33445458	Edited April/12/2023
	Issue 035	Page No 8/146

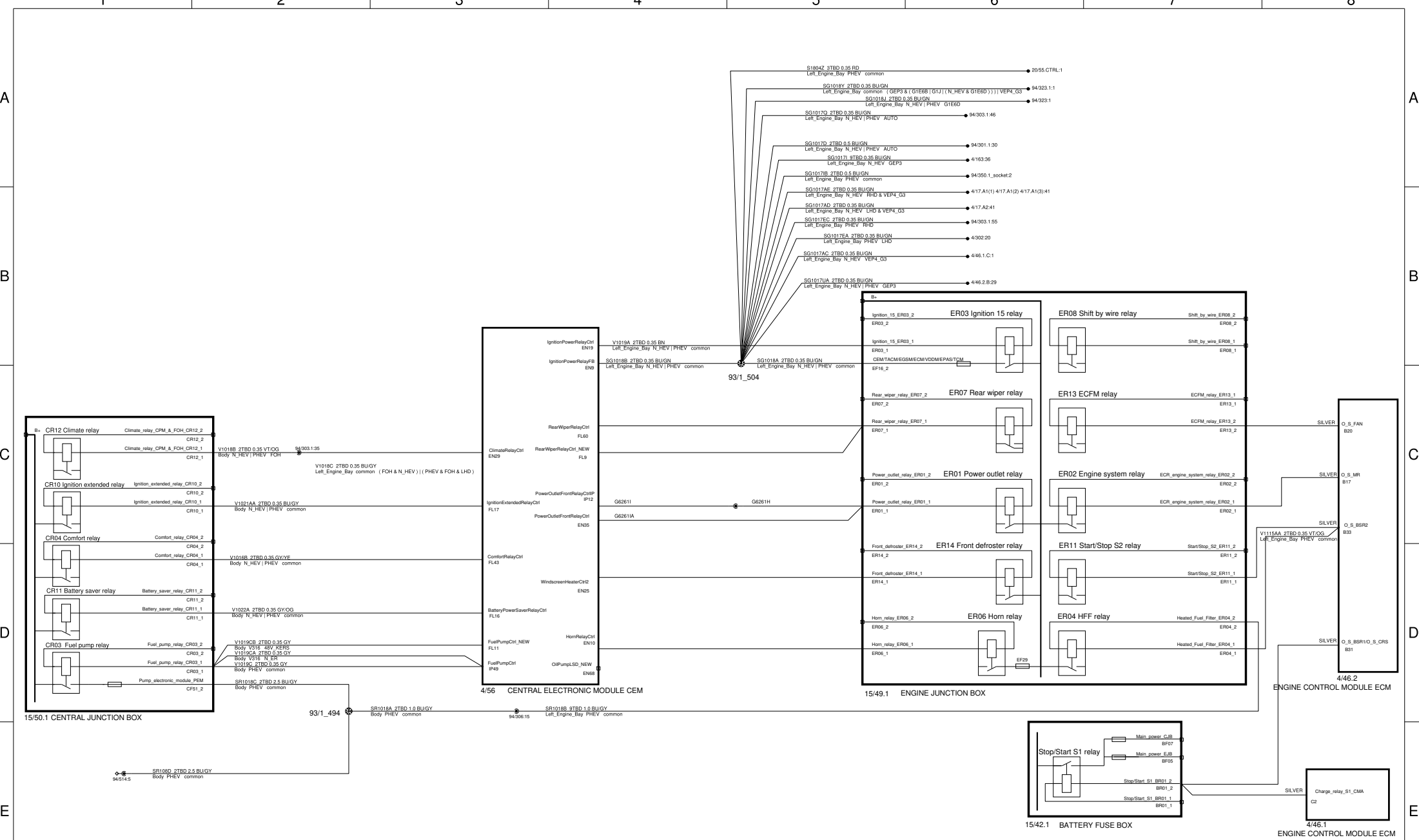

<p>The copying, distribution and utilization of this document as well as the communication of its contents to others without expressed authorization is prohibited. Offenders will be held liable for payment of damages. All rights reserved in the event of the grant of a patent, utility model or ornamental design registration.</p>		<p>Document title 623A_PP_CC_04_06_2023 1A3_System_relays_control_HEV</p>	
		<p>Document Type DRAW/ELSY</p>	<p>Release Status RELEASED</p>
<p>VOLVO VOLVO CAR CORPORATION</p>		<p>CEVT Document No 8888522365</p>	<p>Edited April/12/2023</p>
		<p>Issue 035</p>	<p>Page No 9/146</p>

1B Grounding Engine, Body

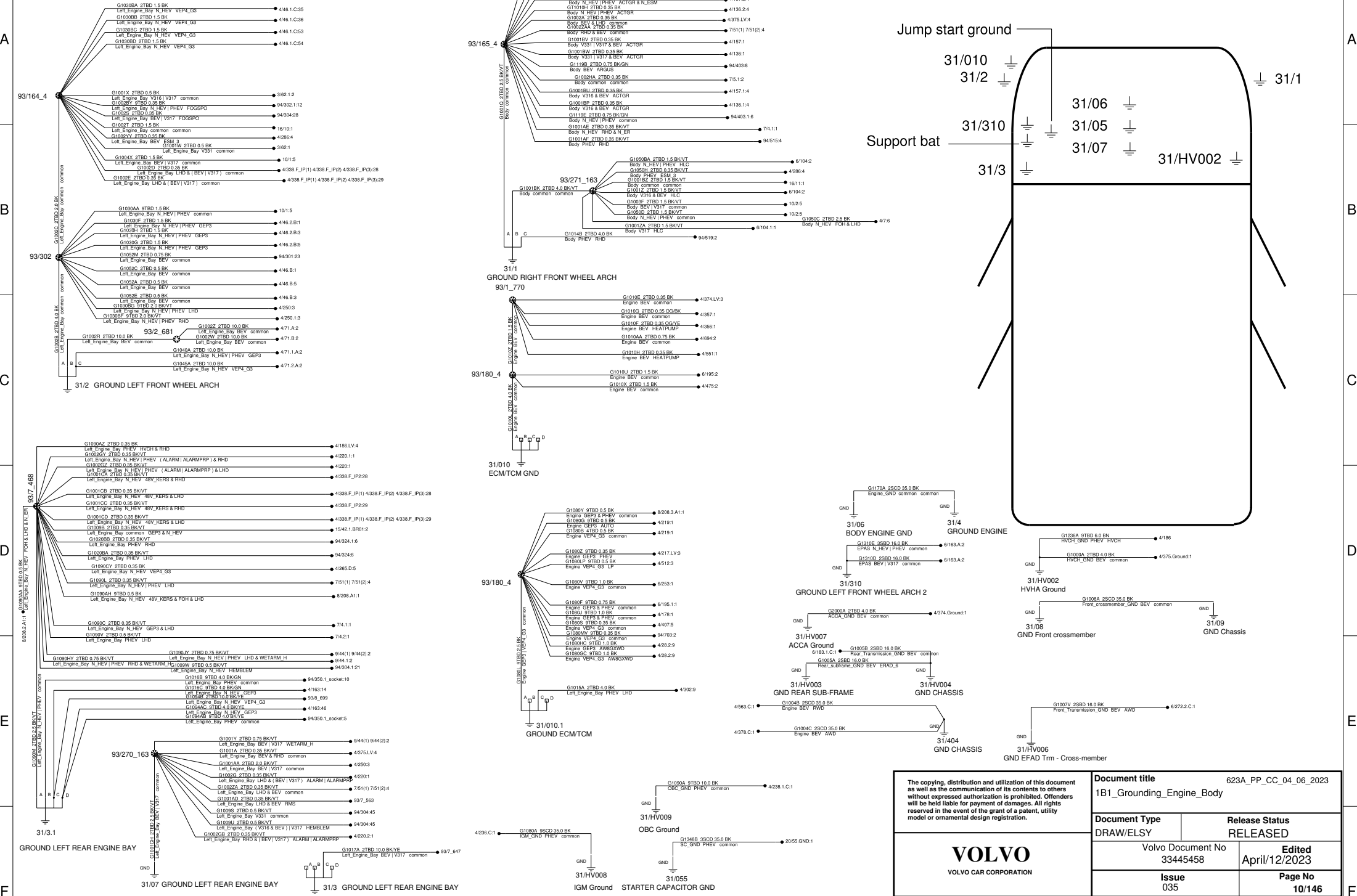

The copying, distribution and utilization of this document as well as the communication of its contents to others without expressed authorization is prohibited. Offenders will be held liable for payment of damages. All rights reserved in the event of the grant of a patent, utility model or ornamental design registration.

VOLVO
VOLVO CAR CORPORATION

Document title		623A_PP_CC_04_06_2023	
1B1_Grounding_Engine_Body		RELEASED	
Document Type	Release Status		
DRAW/ELSY	Volvo Document No 33445458	Edited April/12/2023	
Issue 035	Page No 10/146		

1B Grounding IP, Tunnel & Roof

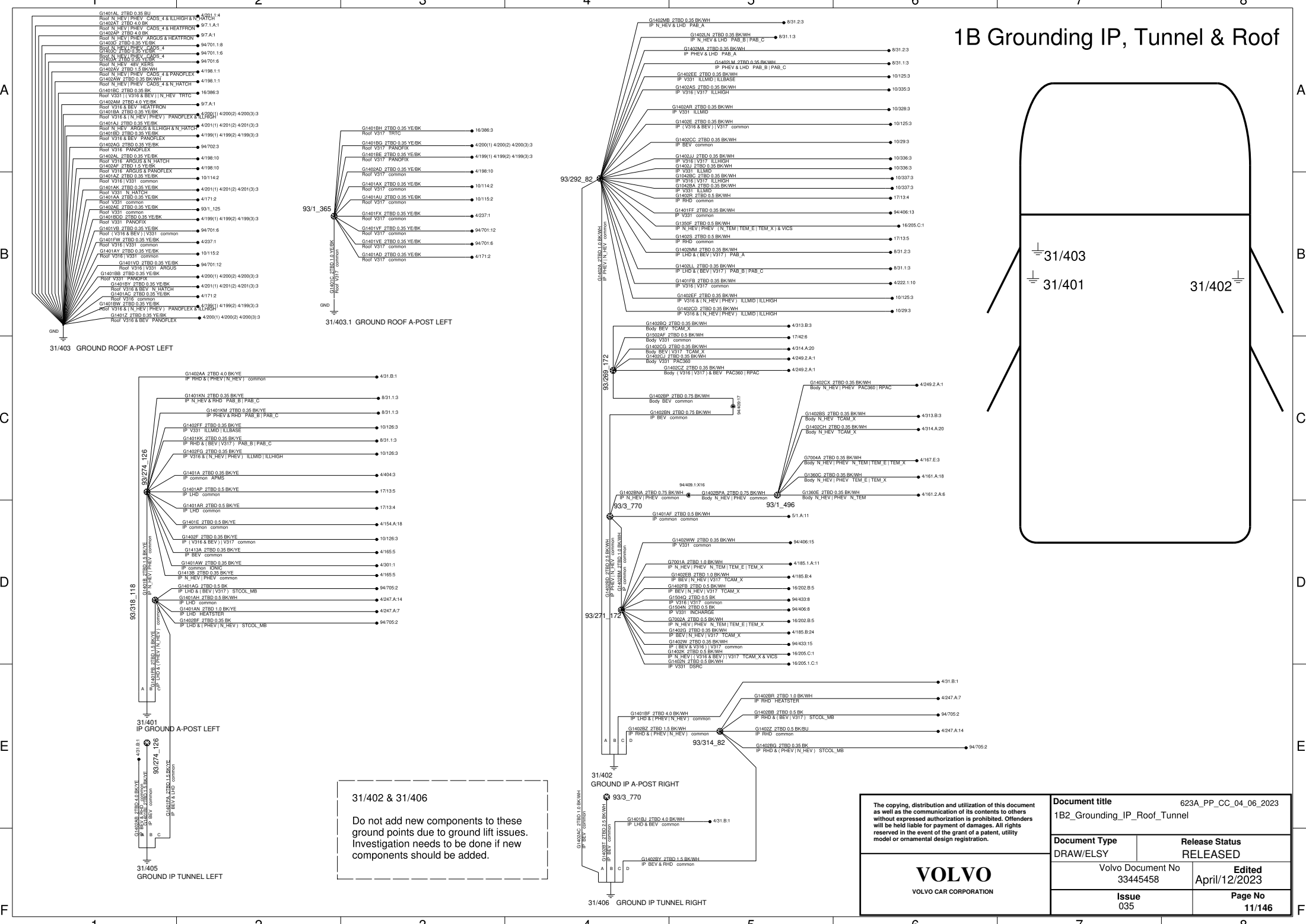

31/402 & 31/406

Do not add new components to these ground points due to ground lift issues. Investigation needs to be done if new components should be added.

The copying, distribution and utilization of this document as well as the communication of its contents to others without expressed authorization is prohibited. Offenders will be held liable for payment of damages. All rights reserved in the event of the grant of a patent, utility model or ornamental design registration.

VOLVO
VOLVO CAR CORPORATION

Document title		623A_PP_CC_04_06_2023	
1B2_Grounding_IP_Roof_Tunnel			
Document Type	Release Status		
DRAW/ELSY	RELEASED		
Volvo Document No 33445458		Edited April/12/2023	
Issue 035	Page No 11/146		

1B Grounding Body Front

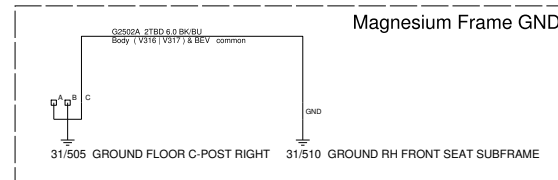
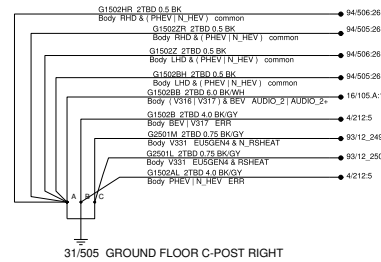
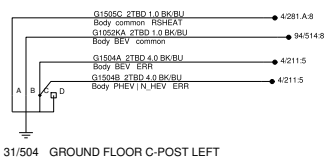
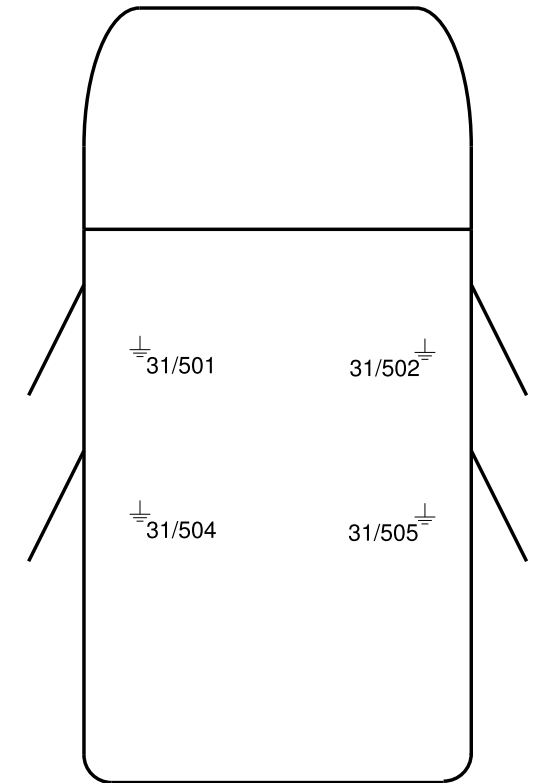
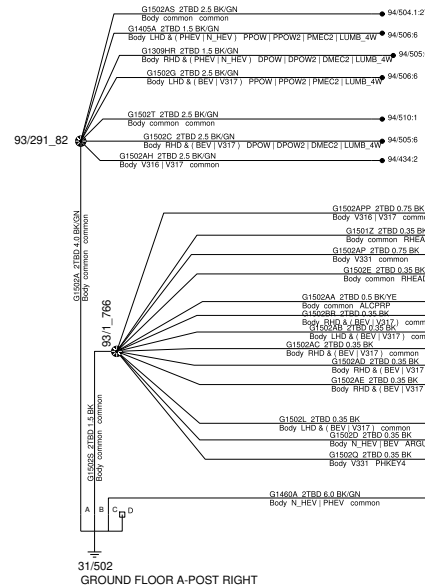
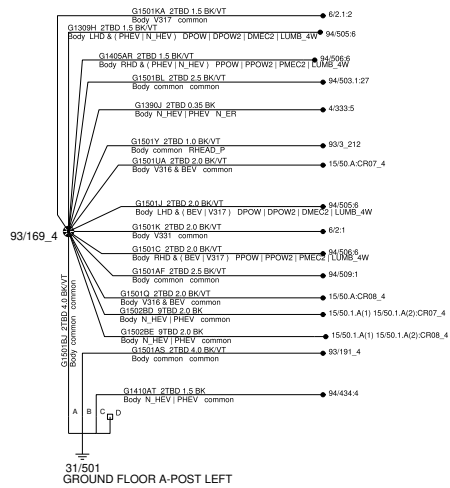

VOLVO VOLVO CAR CORPORATION	Document title 623A_PP_CC_04_06_2023 1B3_Grounding_Body_Front	
	Document Type DRAW/ELSY	Release Status RELEASED
	Volvo Document No 33445458	Edited April/12/2023
	Issue 035	Page No 12/146

1B Grounding Body Rear, Tailgate

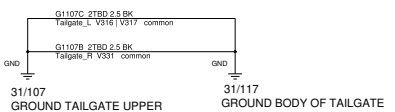
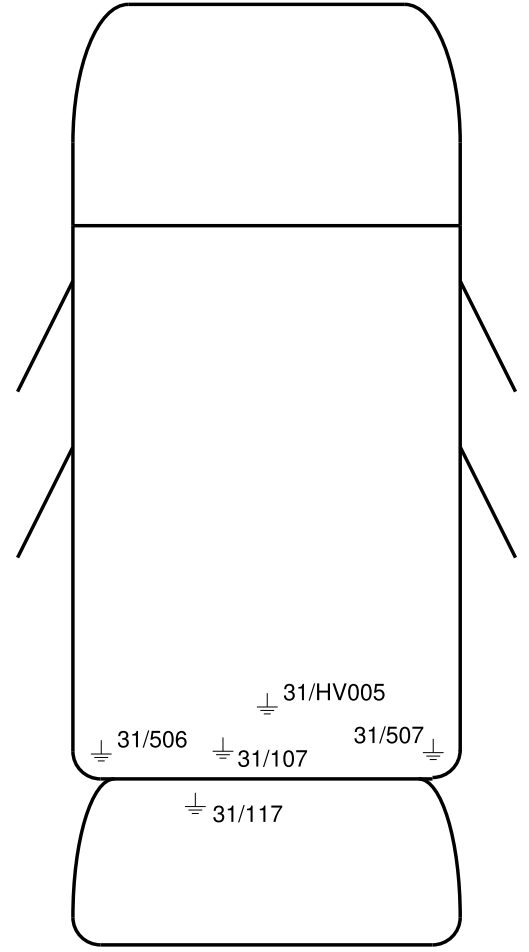
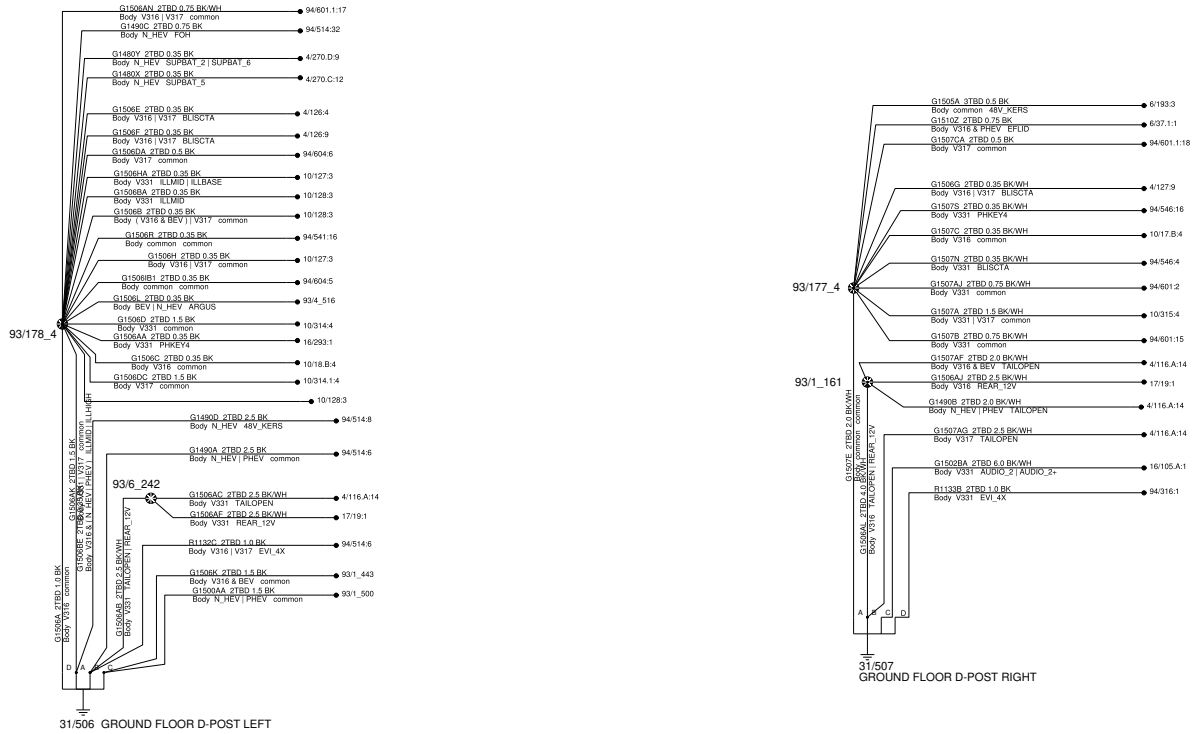

<p>The copying, distribution and utilization of this document as well as the communication of its contents to others without expressed authorization is prohibited. Offenders will be held liable for payment of damages. All rights reserved in the event of the grant of a patent, utility model or ornamental design registration.</p> <p>VOLVO VOLVO CAR CORPORATION</p>	<p>Document title 623A_PP_CC_04_06_2023 1B4_Grounding_Body_Rear_Tailgate</p>	
	<p>Document Type DRAW/ELSY</p>	<p>Release Status RELEASED</p>
	<p>Volvo Document No 33445458</p>	<p>Edited April/12/2023</p>
	<p>Issue 035</p>	<p>Page No 13/146</p>

1C1 EI. Power generating

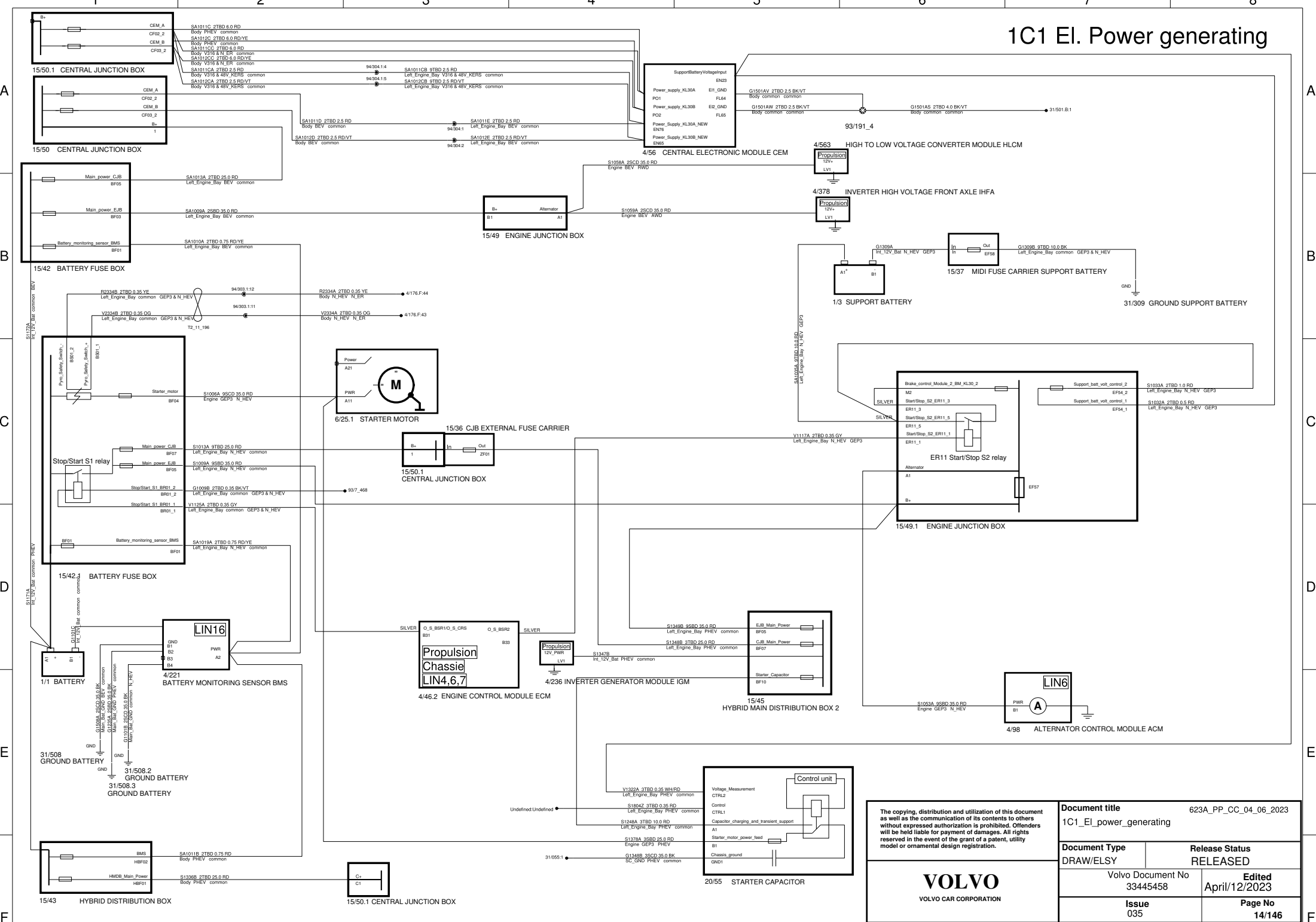

<p>The copying, distribution and utilization of this document as well as the communication of its contents to others without expressed authorization is prohibited. Offenders will be held liable for payment of damages. All rights reserved in the event of the grant of a patent, utility model or ornamental design registration.</p> <p>VOLVO VOLVO CAR CORPORATION</p>		<p>Document title 623A_PP_CC_04_06_2023</p>	
		<p>1C1_EI_power_generating</p>	
<p>Document Type DRAW/ELSY</p>		<p>Release Status RELEASED</p>	
<p>Volvo Document No 33445458</p>		<p>Edited April/12/2023</p>	
<p>Issue 035</p>		<p>Page No 14/146</p>	

1D Diagnostics

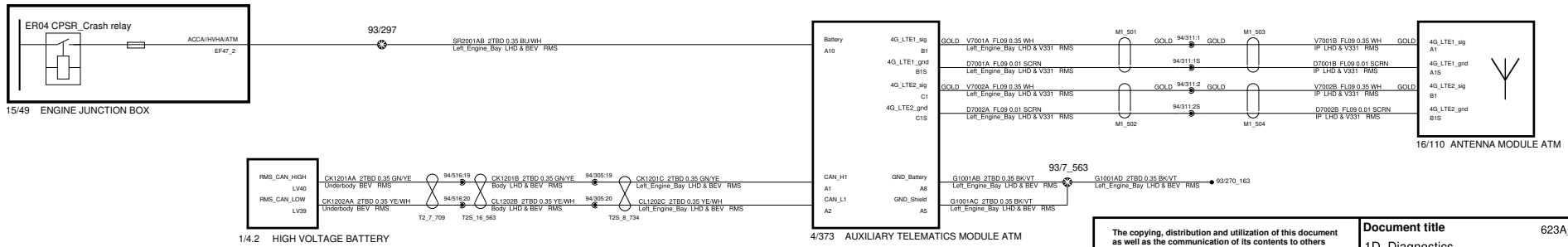
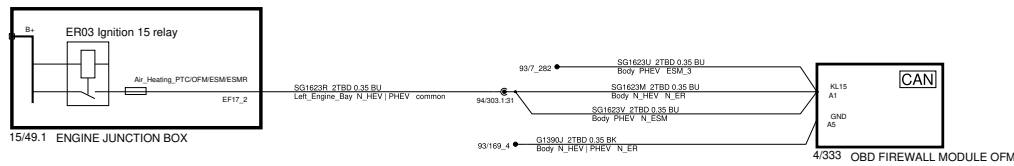
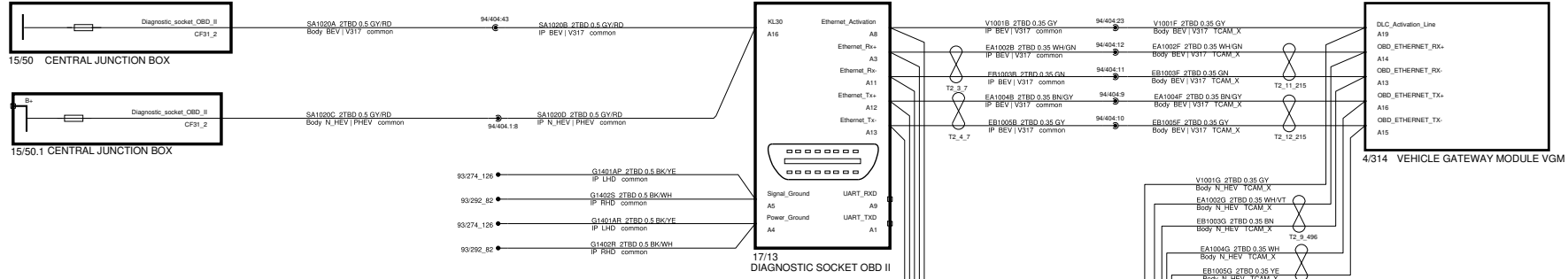

<p>The copying, distribution and utilization of this document as well as the communication of its contents to others without expressed authorization is prohibited. Offenders will be held liable for payment of damages. All rights reserved in the event of the grant of a patent, utility model or ornamental design registration.</p>		<p>Document title 1D_Diagnostics</p>		<p>623A_PP_CC_04_06_2023</p>	
		<p>Document Type DRAW/ELSY</p>		<p>Release Status RELEASED</p>	
<p>VOLVO VOLVO CAR CORPORATION</p>		<p>Volvo Document No 33445458</p>		<p>Edited April/12/2023</p>	
		<p>Issue 035</p>		<p>Page No 15/146</p>	

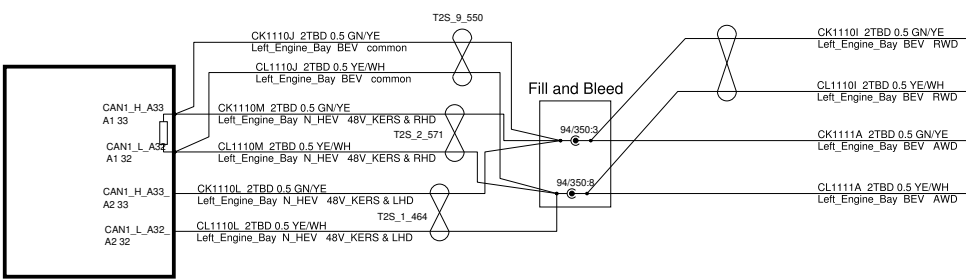
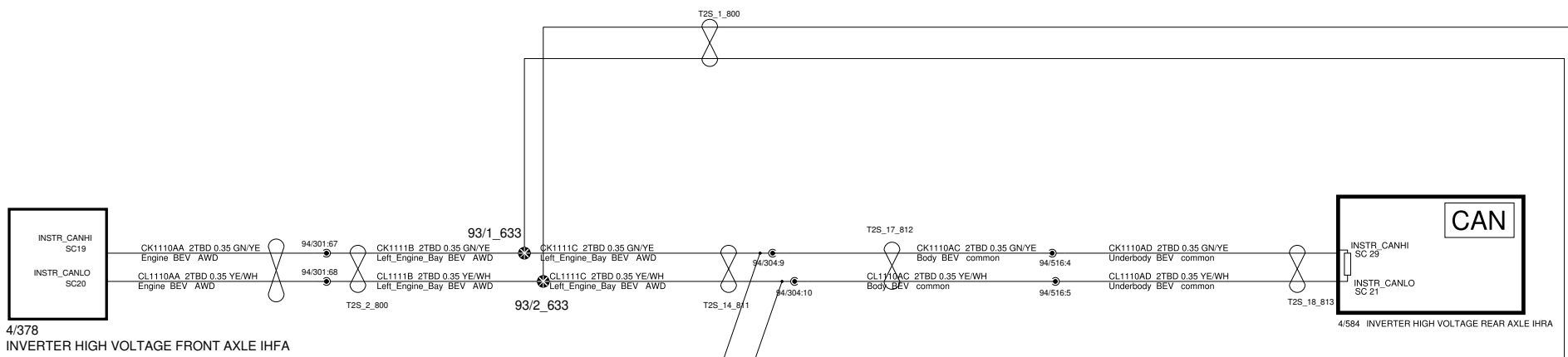

4/378
INVERTER HIGH VOLTAGE FRONT AXLE IHFA

4/584 INVERTER HIGH VOLTAGE REAR AXLE IHRA

4/17
BRAKE CONTROL MODULE 2 BCM2

<p>The copying, distribution and utilization of this document as well as the communication of its contents to others without expressed authorization is prohibited. Offenders will be held liable for payment of damages. All rights reserved in the event of the grant of a patent, utility model or ornamental design registration.</p> <p>VOLVO VOLVO CAR CORPORATION</p>	<p>Document title 623A_PP_CC_04_06_2023 1E_CAN_ABS_Braking</p>	
	<p>Document Type DRAW/ELSY</p>	<p>Release Status RELEASED</p>
	<p>CEVT Document No 8888522365</p>	<p>Edited April/12/2023</p>
	<p>Issue 035</p>	<p>Page No 16/146</p>

1E Body CAN Exp

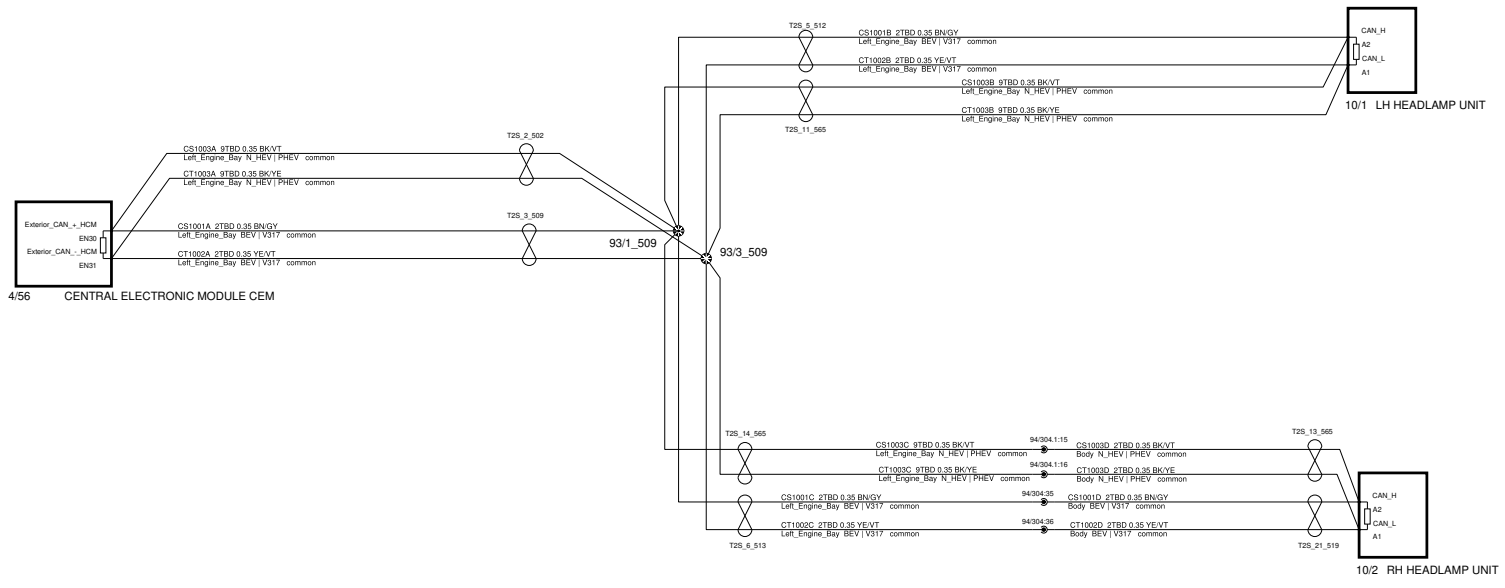

<p>The copying, distribution and utilization of this document as well as the communication of its contents to others without expressed authorization is prohibited. Offenders will be held liable for payment of damages. All rights reserved in the event of the grant of a patent, utility model or ornamental design registration.</p> <p>VOLVO VOLVO CAR CORPORATION</p>	Document title 623A_PP_CC_04_06_2023 1E_CAN_Body_Exp	
	Document Type DRAW/ELSY	Release Status RELEASED
	Volvo Document No 33445458	Edited February/19/2021
	Issue 035	Page No 18/146

1E Body-CAN

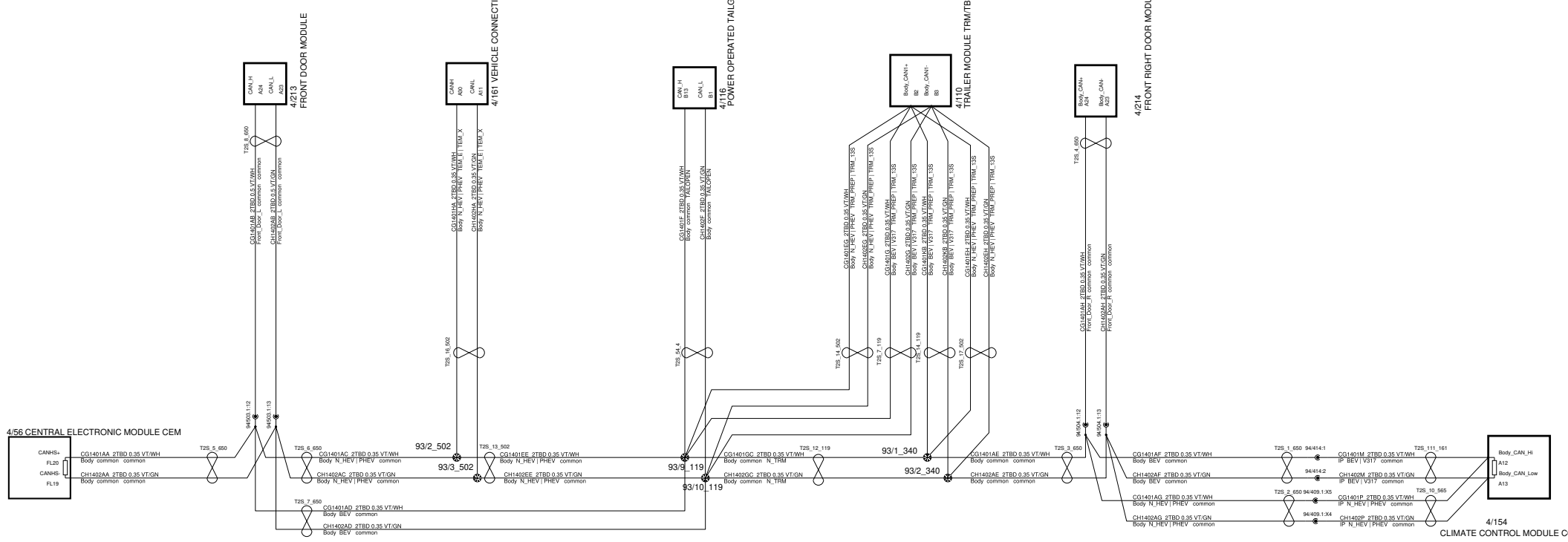

<p>The copying, distribution and utilization of this document as well as the communication of its contents to others without expressed authorization is prohibited. Offenders will be held liable for payment of damages. All rights reserved in the event of the grant of a patent, utility model or ornamental design registration.</p> <p>VOLVO VOLVO CAR CORPORATION</p>	Document title		623A_PP_CC_04_06_2023
	1E_CAN_Body		
	Document Type	Release Status	
	DRAW/ELSY	RELEASED	
	Volvo Document No 33445458	Edited April/12/2023	
	Issue 035	Page No 17/146	

1E Chassie CAN

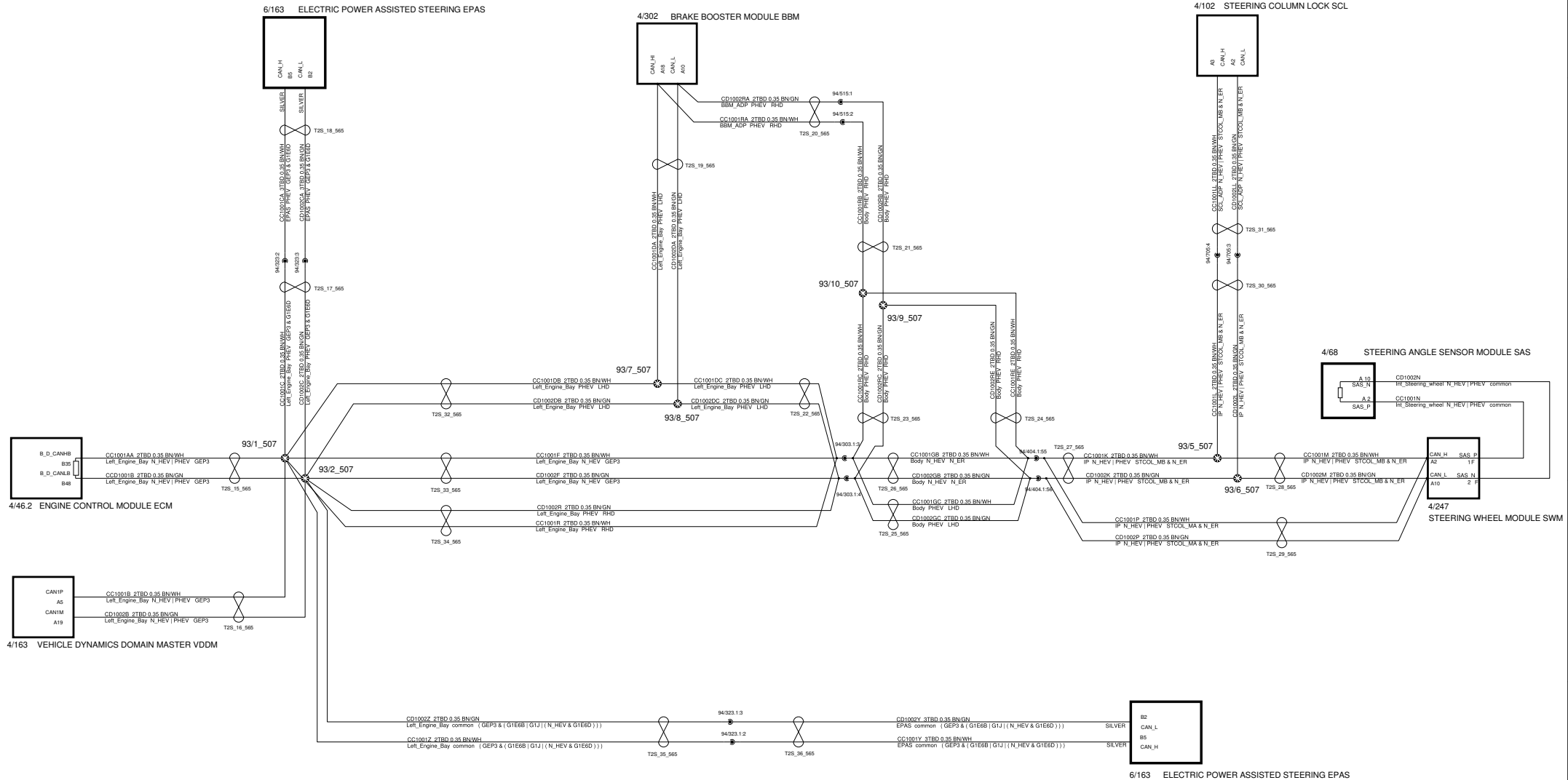

<p>The copying, distribution and utilization of this document as well as the communication of its contents to others without expressed authorization is prohibited. Offenders will be held liable for payment of damages. All rights reserved in the event of the grant of a patent, utility model or ornamental design registration.</p> <p>VOLVO VOLVO CAR CORPORATION</p>	Document title 623A_PP_CC_04_06_2023	
	1E_CAN_Chassie	
	Document Type DRAW/ELSY	Release Status RELEASED
	CEVT Document No 8888522365	Edited April/04/2023
	Issue 035	Page No 19/146

1E Diagnostics and Connectivity CAN

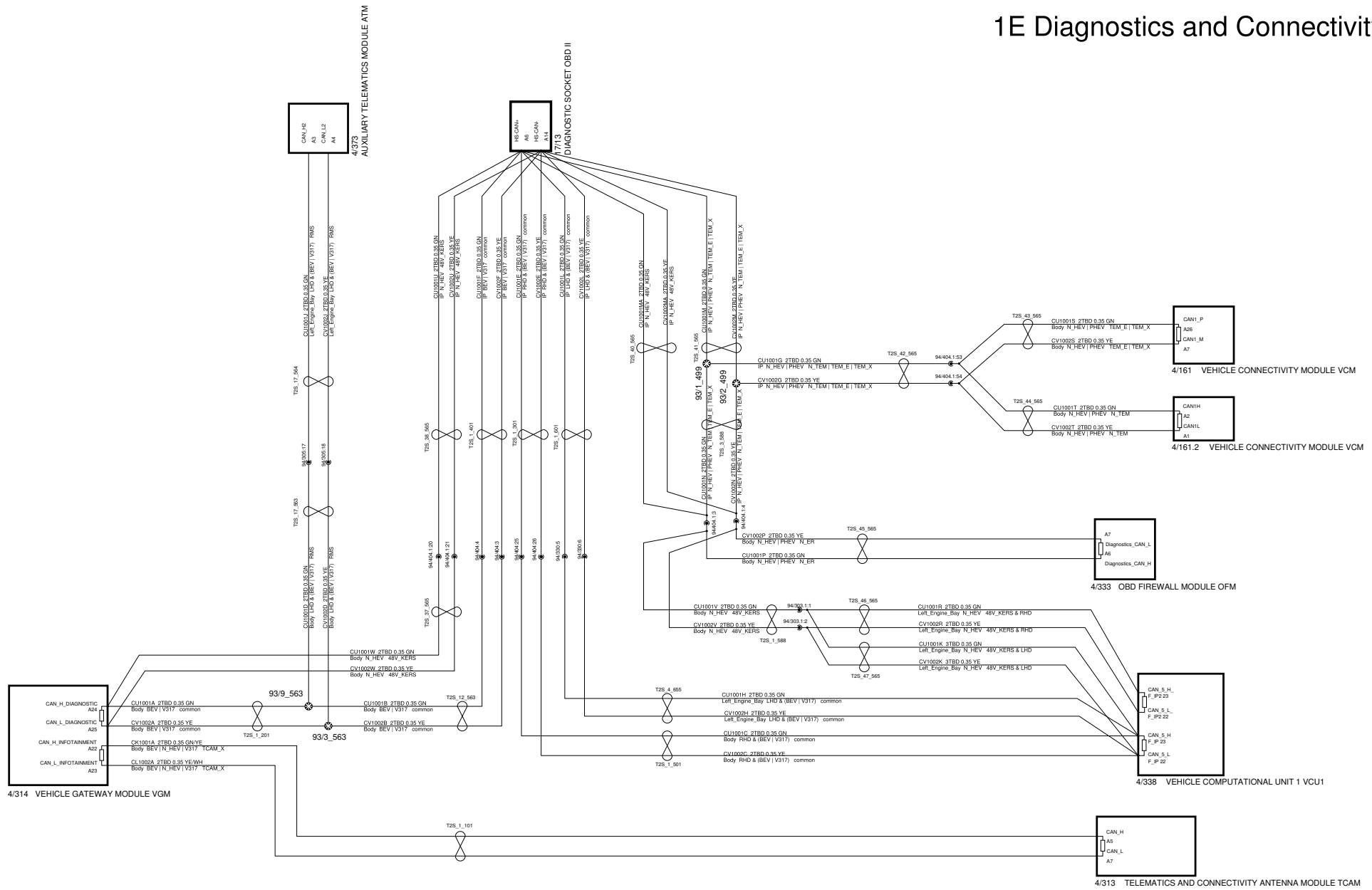

<p>The copying, distribution and utilization of this document as well as the communication of its contents to others without expressed authorization is prohibited. Offenders will be held liable for payment of damages. All rights reserved in the event of the grant of a patent, utility model or ornamental design registration.</p> <p>VOLVO VOLVO CAR CORPORATION</p>		<p>Document title 623A_PP_CC_04_06_2023 1E_CAN_Connectivity_Diagnostics</p>	
		<p>Document Type DRAW/ELSY</p>	<p>Release Status RELEASED</p>
		<p>Volvo Document No 33445458</p>	<p>Edited April/12/2023</p>
		<p>Issue 035</p>	<p>Page No 20/146</p>

1E Engine CAN

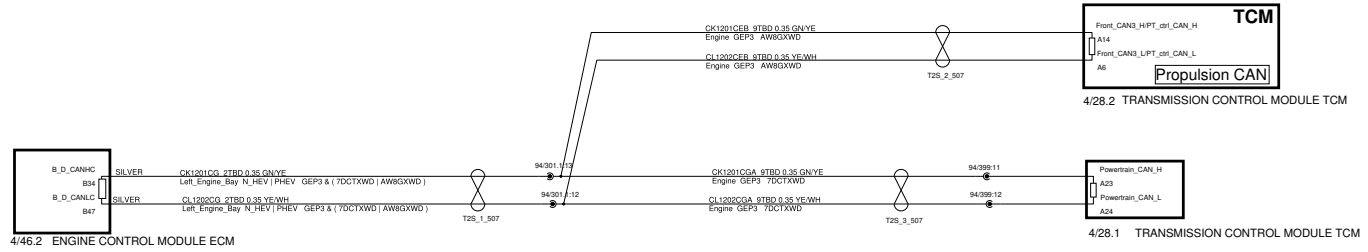

<p>The copying, distribution and utilization of this document as well as the communication of its contents to others without expressed authorization is prohibited. Offenders will be held liable for payment of damages. All rights reserved in the event of the grant of a patent, utility model or ornamental design registration.</p> <p>VOLVO VOLVO CAR CORPORATION</p>	Document title 623A_PP_CC_04_06_2023 1E_CAN_Engine	
	Document Type DRAW/ELSY	Release Status RELEASED
	CEVT Document No 8888522365	Edited February/01/2021
	Issue 035	Page No 21/146

1E Front 1 CAN

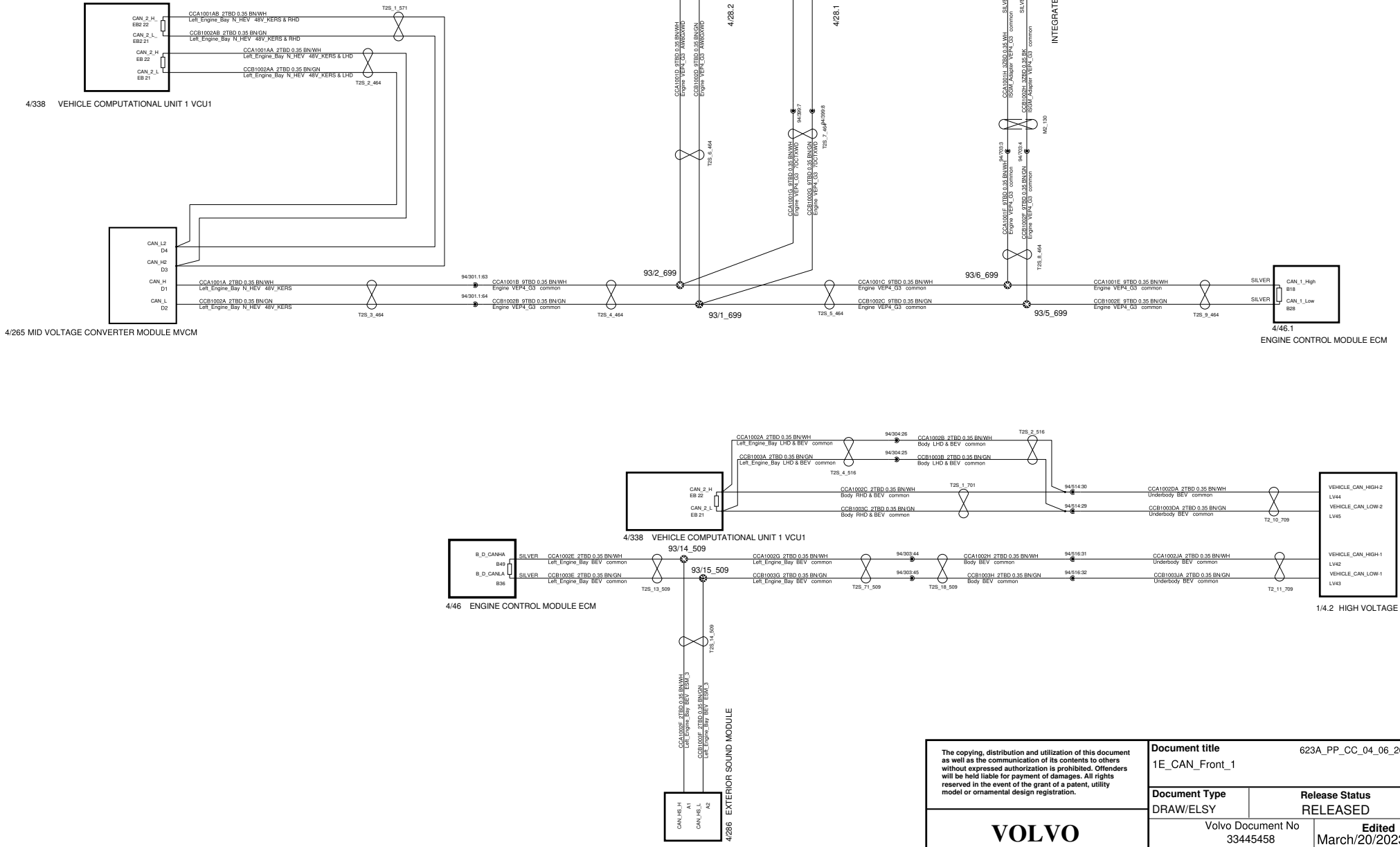

<p>The copying, distribution and utilization of this document as well as the communication of its contents to others without expressed authorization is prohibited. Offenders will be held liable for payment of damages. All rights reserved in the event of the grant of a patent, utility model or ornamental design registration.</p>		<p>Document title 623A_PP_CC_04_06_2023</p>	
		<p>1E_CAN_Front_1</p>	
<p>Document Type</p>		<p>Release Status</p>	
<p>DRAW/ELSY</p>		<p>RELEASED</p>	
<p>Volvo Document No 33445458</p>		<p>Edited March/20/2023</p>	
<p>Issue 035</p>		<p>Page No 22/146</p>	

VOLVO
VOLVO CAR CORPORATION

1E Front 3 CAN

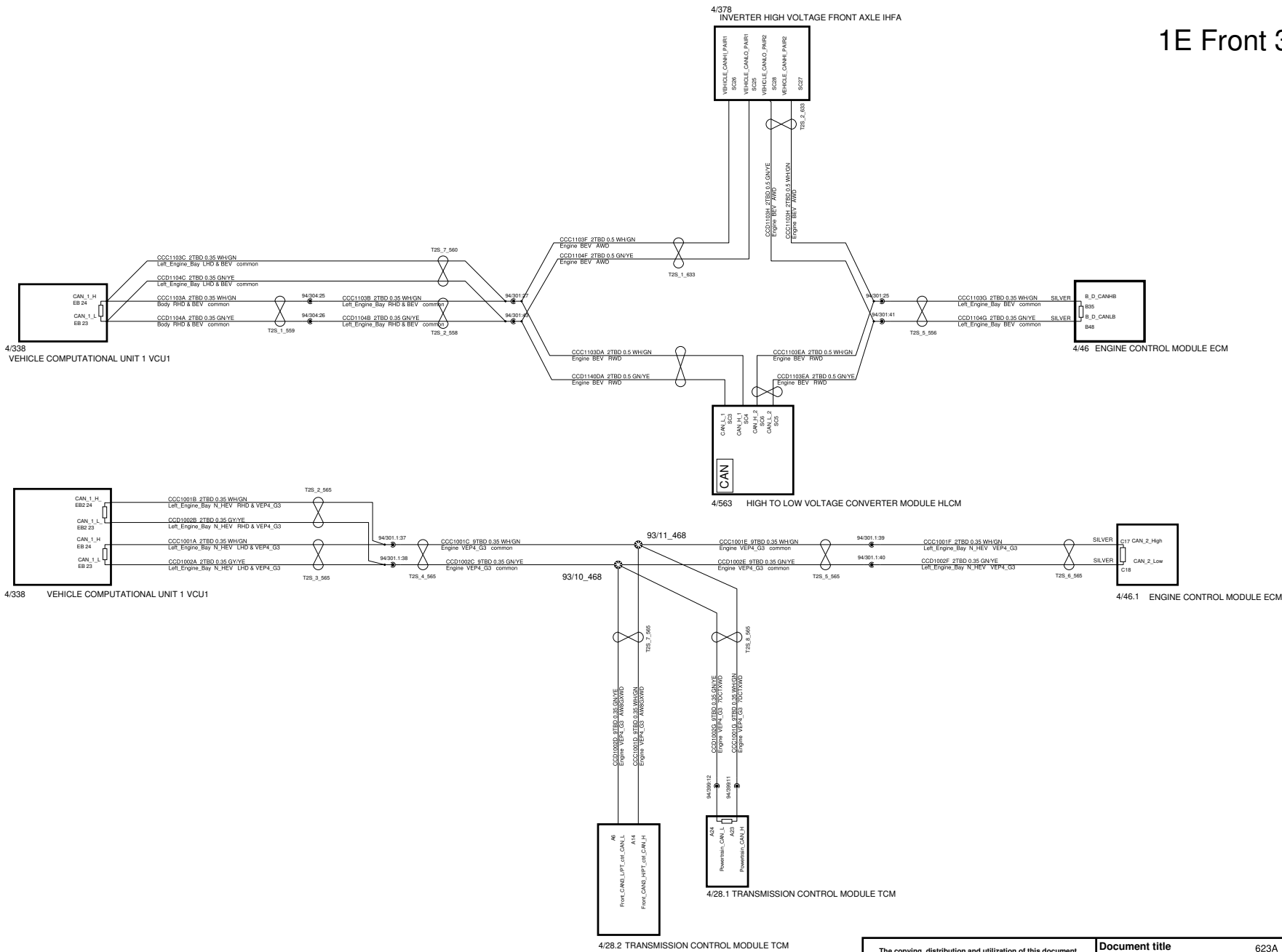

<p>The copying, distribution and utilization of this document as well as the communication of its contents to others without expressed authorization is prohibited. Offenders will be held liable for payment of damages. All rights reserved in the event of the grant of a patent, utility model or ornamental design registration.</p>		<p>Document title 1E_CAN_Front_3</p>		<p>623A_PP_CC_04_06_2023</p>	
		<p>Document Type DRAW/ELSY</p>	<p>Release Status RELEASED</p>		
<p>VOLVO VOLVO CAR CORPORATION</p>		<p>Volvo Document No 33445458</p>	<p>Edited March/21/2023</p>		
		<p>Issue 035</p>	<p>Page No 23/146</p>		

1E Front CAN Exposed

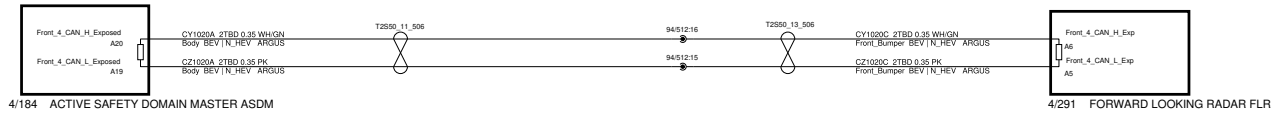

<p>The copying, distribution and utilization of this document as well as the communication of its contents to others without expressed authorization is prohibited. Offenders will be held liable for payment of damages. All rights reserved in the event of the grant of a patent, utility model or ornamental design registration.</p> <p>VOLVO VOLVO CAR CORPORATION</p>	Document title 623A_PP_CC_04_06_2023 1E_CAN_Front_Exposed	
	Document Type DRAW/ELSY	Release Status RELEASED
	Volvo Document No 33445458	Edited September/30/2020
	Issue 035	Page No 24/146

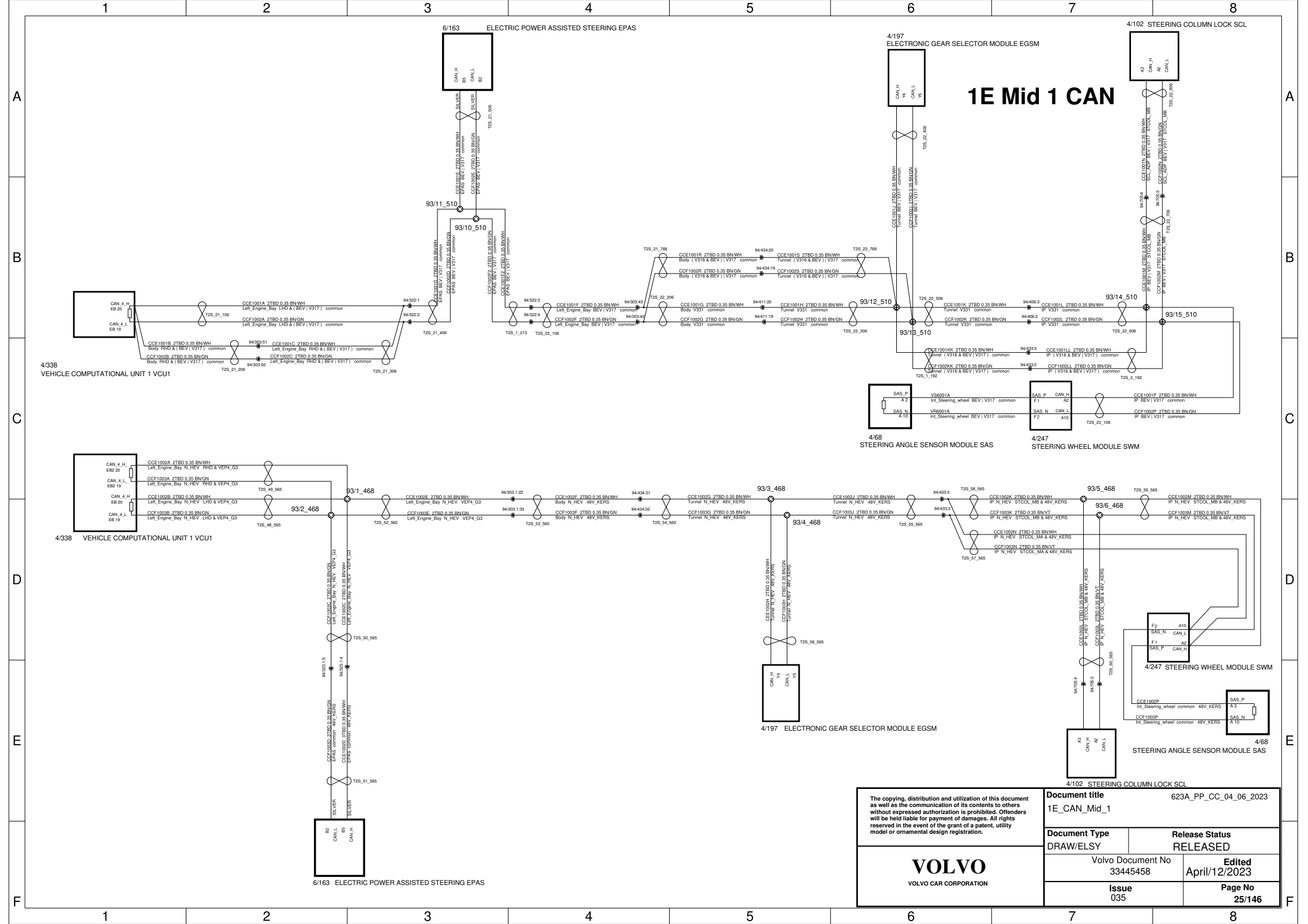

1E Mid 1 CAN

<p>The copying, distribution and utilization of this document as well as the communication of its contents to others without expressed authorization is prohibited. Offenders will be held liable for payment of damages. All rights reserved in the event of the grant of a patent, utility model or ornamental design registration.</p> <p style="text-align: center;">VOLVO VOLVO CAR CORPORATION</p>		Document title	623A_PP_CC_04_06_2023
		Document Type	RELEASED
<p>Volvo Document No 33445458</p>		<p>Edited April/12/2023</p>	
<p>Issue 035</p>		<p>Page No 25/146</p>	

6/163 ELECTRIC POWER ASSISTED STEERING EPAS

4/338 VEHICLE COMPUTATIONAL UNIT 1 VCU1

4/338 VEHICLE COMPUTATIONAL UNIT 1 VCU1

4/68 STEERING ANGLE SENSOR MODULE SAS

4/247 STEERING WHEEL MODULE SWM

4/197 ELECTRONIC GEAR SELECTOR MODULE EGSM

4/68 STEERING ANGLE SENSOR MODULE SAS

4/102 STEERING COLUMN LOCK SCL

1E Propulsion CAN Front

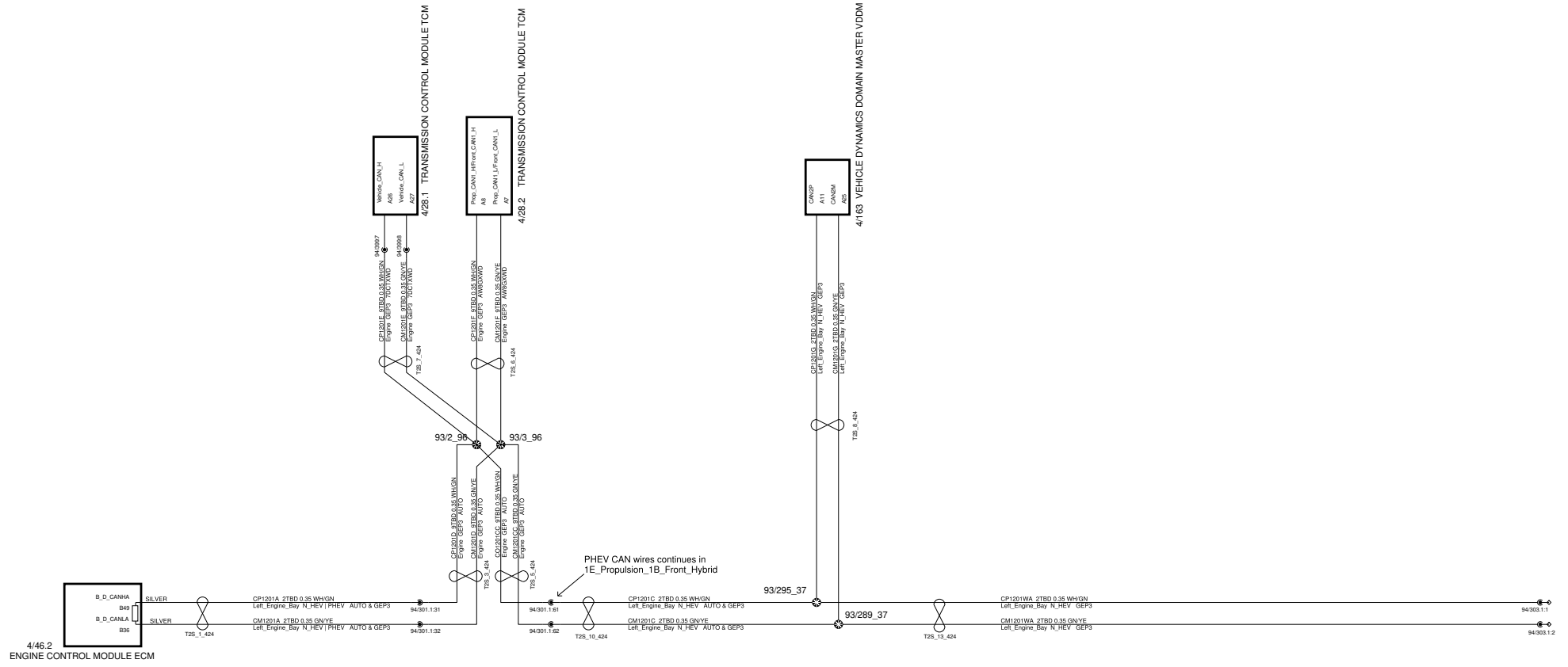

<p>The copying, distribution and utilization of this document as well as the communication of its contents to others without expressed authorization is prohibited. Offenders will be held liable for payment of damages. All rights reserved in the event of the grant of a patent, utility model or ornamental design registration.</p> <p>VOLVO VOLVO CAR CORPORATION</p>	<p>Document title 623A_PP_CC_04_06_2023 1E_CAN_Propulsion_1A_Front</p>	
	<p>Document Type DRAW/ELSY</p>	<p>Release Status RELEASED</p>
	<p>CEVT Document No 8888522365</p>	<p>Edited April/12/2023</p>
	<p>Issue 035</p>	<p>Page No 26/146</p>

1E Propulsion CAN Front Hybrid

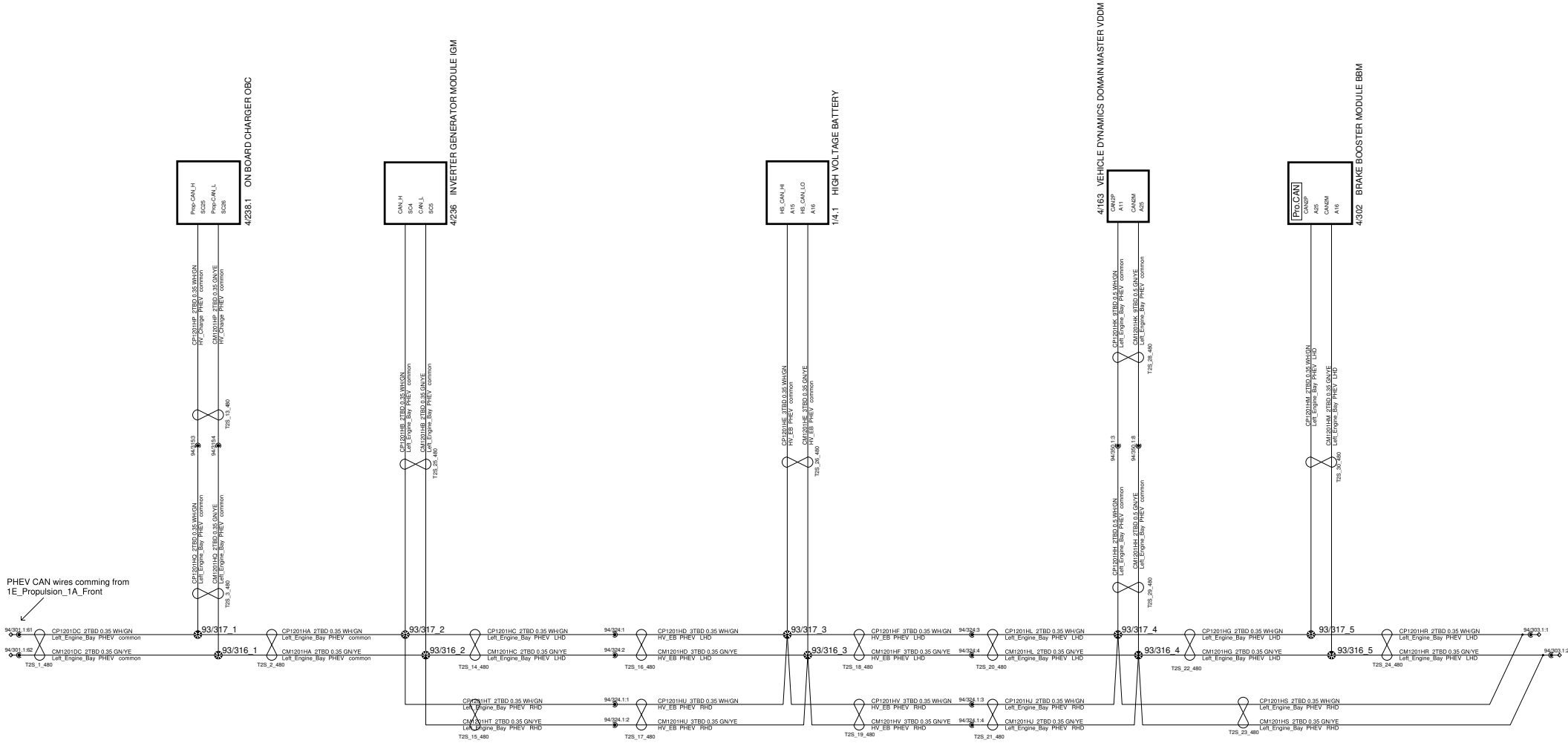

PHEV CAN wires coming from 1E_Propulsion_1A_Front

<p>VOLVO VOLVO CAR CORPORATION</p>	<p>The copying, distribution and utilization of this document as well as the communication of its contents to others without expressed authorization is prohibited. Offenders will be held liable for payment of damages. All rights reserved in the event of the grant of a patent, utility model or ornamental design registration.</p>		<p>Document title 623A_PP_CC_04_06_2023 1E_CAN_Propulsion_1B_Front_Hybrid</p>	
	<p>Document Type DRAW/ELSY</p>		<p>Release Status RELEASED</p>	
	<p>CEVT Document No 8888522365</p>		<p>Edited March/29/2023</p>	
	<p>Issue 035</p>		<p>Page No 27/146</p>	

1E Propulsion CAN Centre

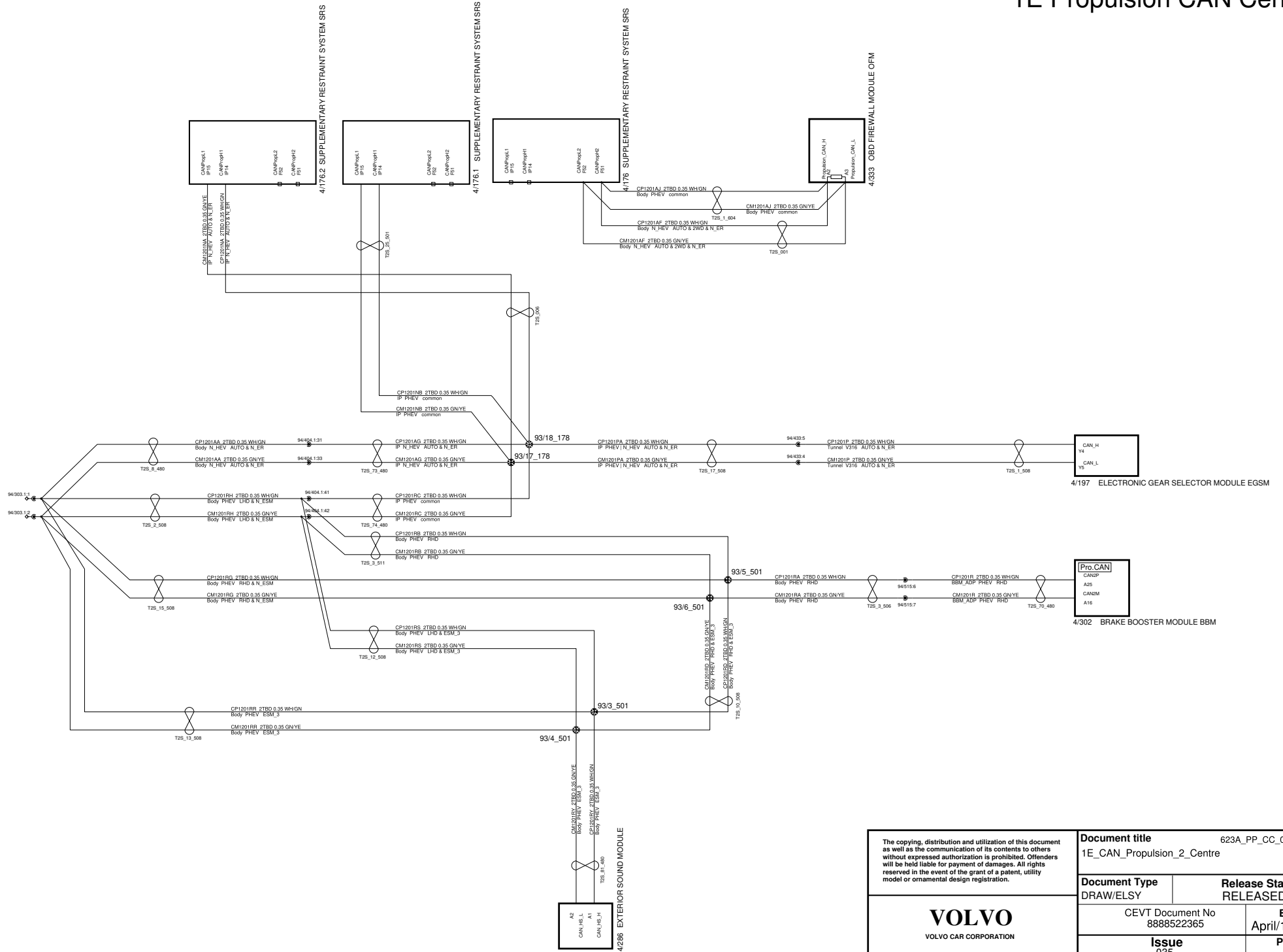

<p>The copying, distribution and utilization of this document as well as the communication of its contents to others without expressed authorization is prohibited. Offenders will be held liable for payment of damages. All rights reserved in the event of the grant of a patent, utility model or ornamental design registration.</p> <p>VOLVO VOLVO CAR CORPORATION</p>	Document title 623A_PP_CC_04_06_2023 1E_CAN_Propulsion_2_Centre	
	Document Type DRAW/ELSY	Release Status RELEASED
	CEVT Document No 8888522365	Edited April/12/2023
	Issue 035	Page No 28/146

1E Rear 1 CAN

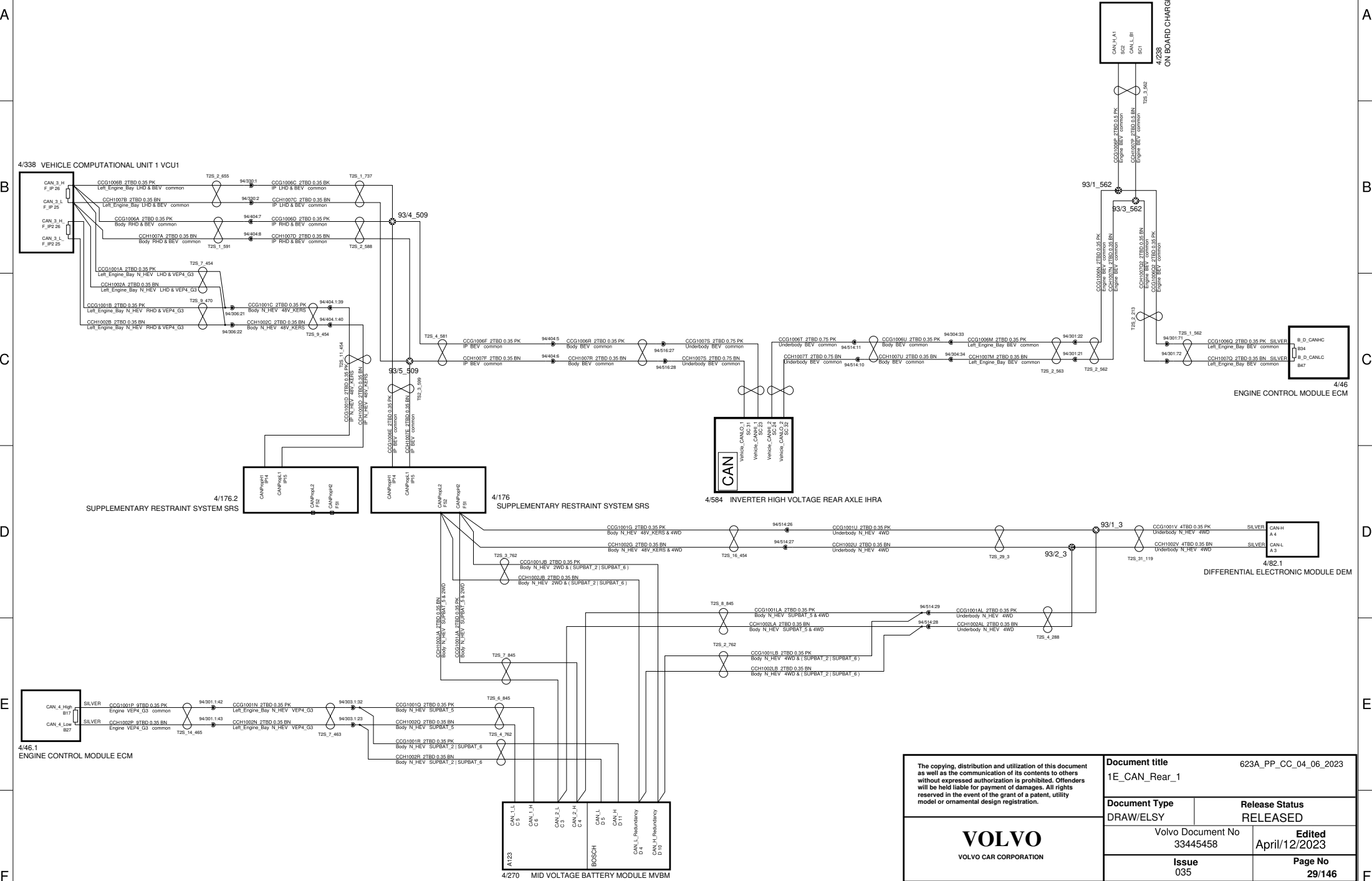

<p>The copying, distribution and utilization of this document as well as the communication of its contents to others without expressed authorization is prohibited. Offenders will be held liable for payment of damages. All rights reserved in the event of the grant of a patent, utility model or ornamental design registration.</p>		Document title	623A_PP_CC_04_06_2023
		1E_CAN_Rear_1	
<p>VOLVO VOLVO CAR CORPORATION</p>	Document Type	Release Status	
	DRAW/ELSY	RELEASED	
	Issue	Volvo Document No 33445458	Edited April/12/2023
	035	Page No 29/146	

1E Safety CAN Exposed BEV 48V KERS

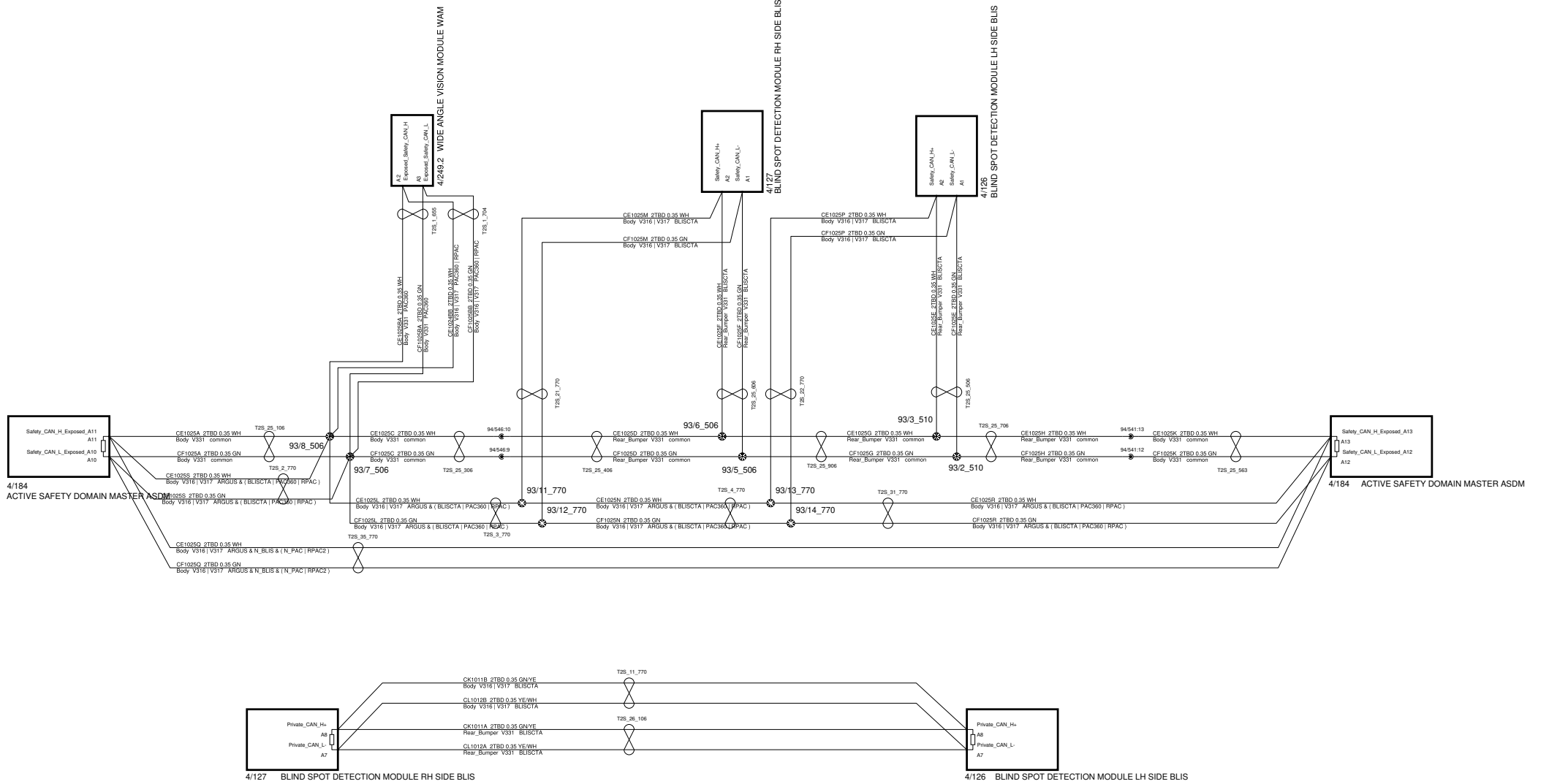

VOLVO VOLVO CAR CORPORATION	Document title 623A_PP_CC_04_06_2023 1E_CAN_Safety_Exposed_BEV_48V_KERS	
	Document Type DRAW/ELSY	Release Status RELEASED
	Volvo Document No 33445458	Edited April/12/2023
	Issue 035	Page No 30/146

1E Safety CAN Exposed ICE PHEV

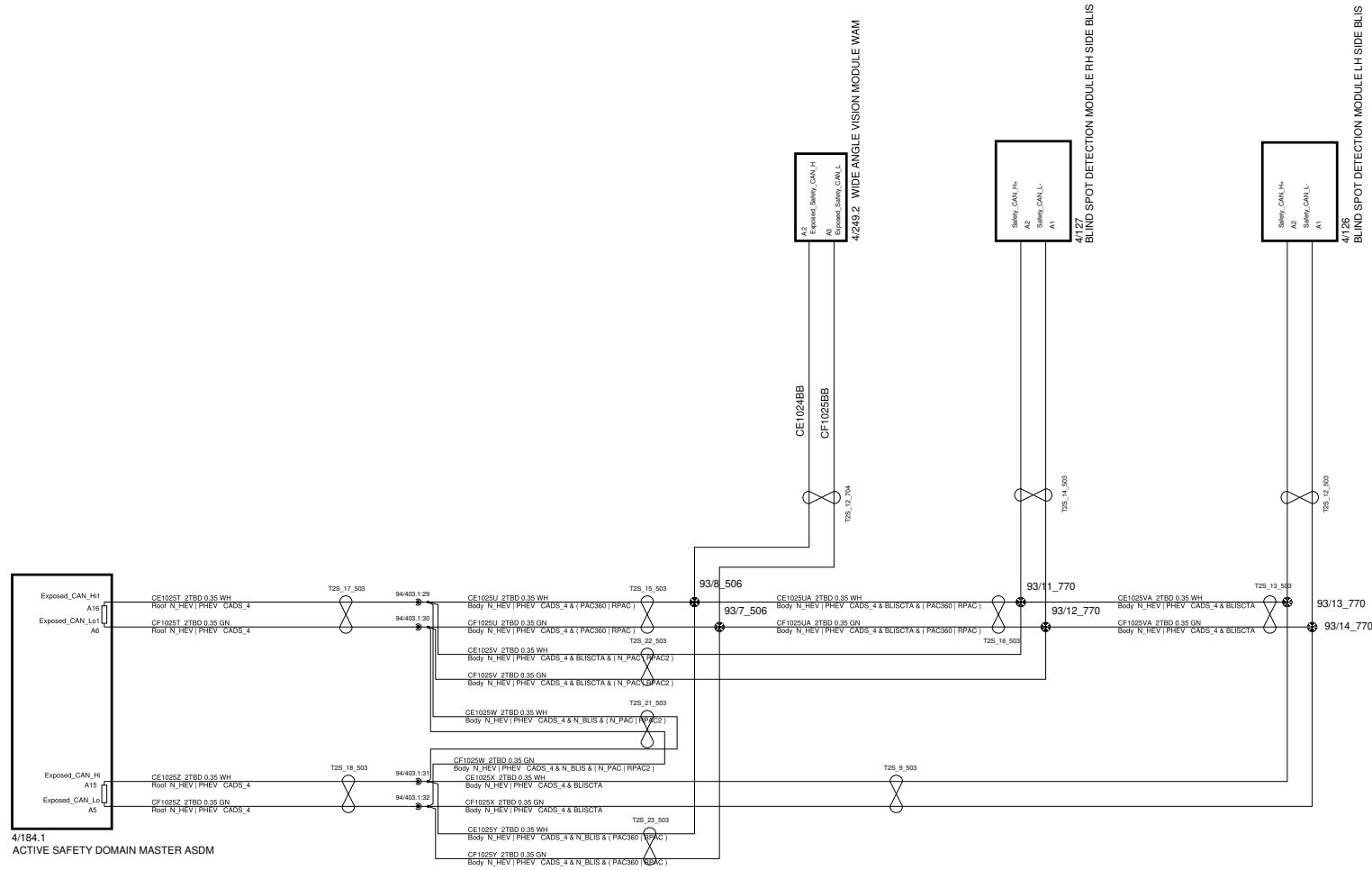

<p>The copying, distribution and utilization of this document as well as the communication of its contents to others without expressed authorization is prohibited. Offenders will be held liable for payment of damages. All rights reserved in the event of the grant of a patent, utility model or ornamental design registration.</p> <p>VOLVO VOLVO CAR CORPORATION</p>	<p>Document title 623A_PP_CC_04_06_2023 1E_CAN_Safety_Exposed_ICE_PHEV</p>	
	<p>Document Type DRAW/ELSY</p>	<p>Release Status RELEASED</p>
	<p>CEVT Document No 8888522365</p>	<p>Edited April/12/2023</p>
	<p>Issue 035</p>	<p>Page No 31/146</p>

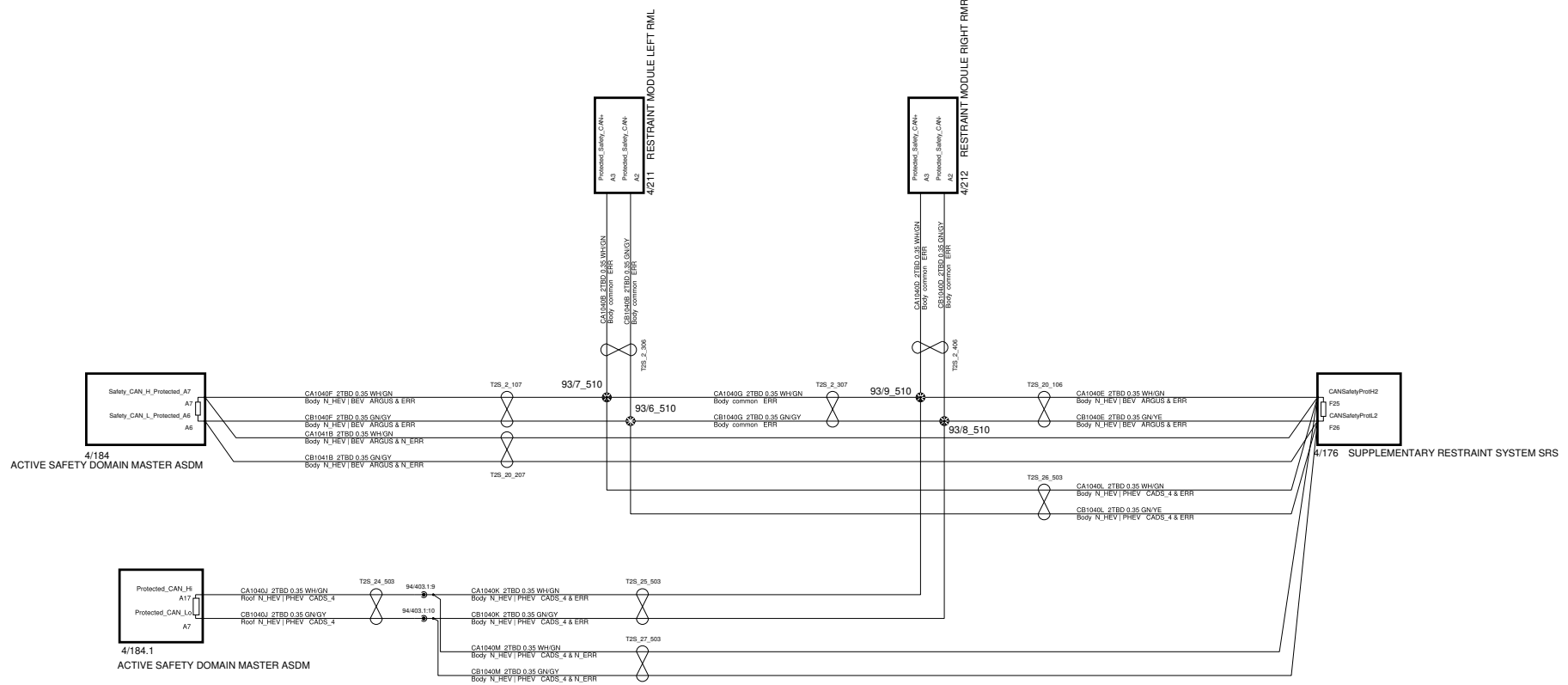

<p>The copying, distribution and utilization of this document as well as the communication of its contents to others without expressed authorization is prohibited. Offenders will be held liable for payment of damages. All rights reserved in the event of the grant of a patent, utility model or ornamental design registration.</p> <p>VOLVO VOLVO CAR CORPORATION</p>	<p>Document title 623A_PP_CC_04_06_2023 1E_CAN_Safety_Protected</p>	
	<p>Document Type DRAW/ELSY</p>	<p>Release Status RELEASED</p>
	<p>Volvo Document No 33445458</p>	<p>Edited March/15/2023</p>
	<p>Issue 035</p>	<p>Page No 32/146</p>

1E_Backbone_FlexRay BEV|48V KERS

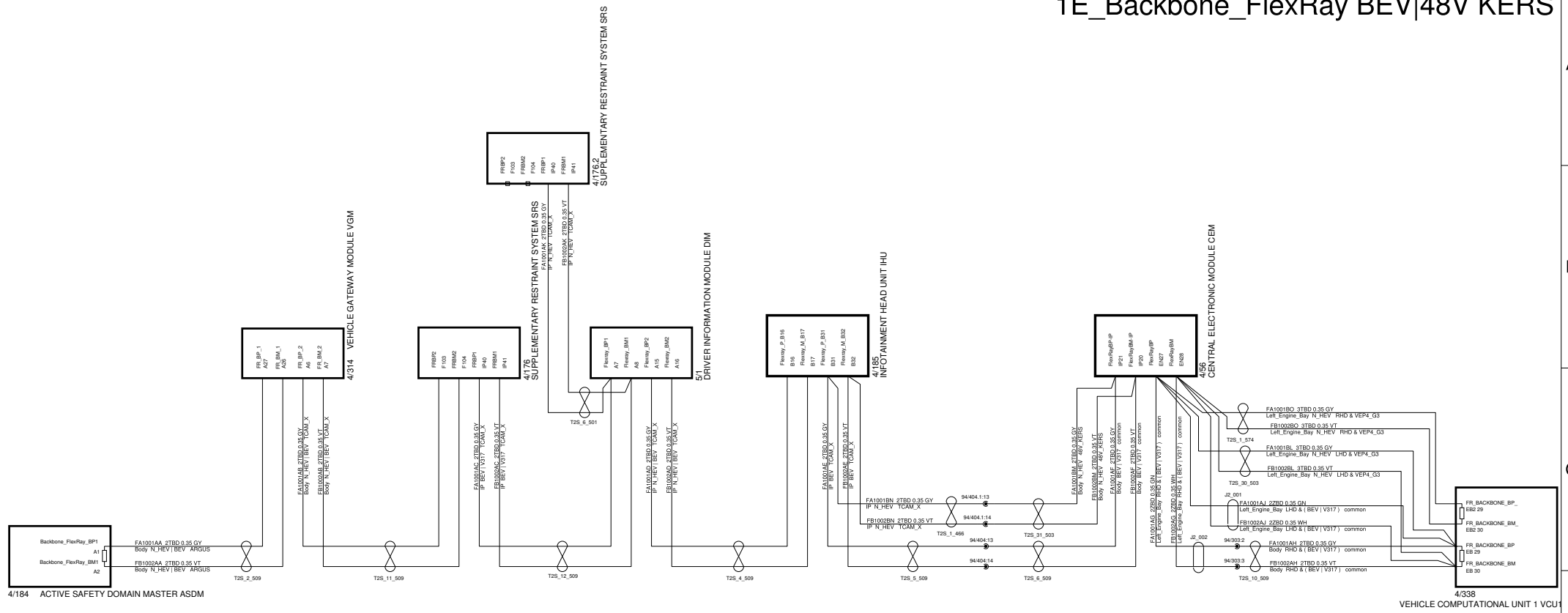

<p>The copying, distribution and utilization of this document as well as the communication of its contents to others without expressed authorization is prohibited. Offenders will be held liable for payment of damages. All rights reserved in the event of the grant of a patent, utility model or ornamental design registration.</p> <p>VOLVO VOLVO CAR CORPORATION</p>	Document title 623A_PP_CC_04_06_2023 1E_FlexRay_Backbone_BEV_48V_KERS	
	Document Type DRAW/ELSY	Release Status RELEASED
	Volvo Document No 33445458	Edited April/12/2023
	Issue 035	Page No 33/146

1E_Backbone_FlexRay_ICE|PHEV

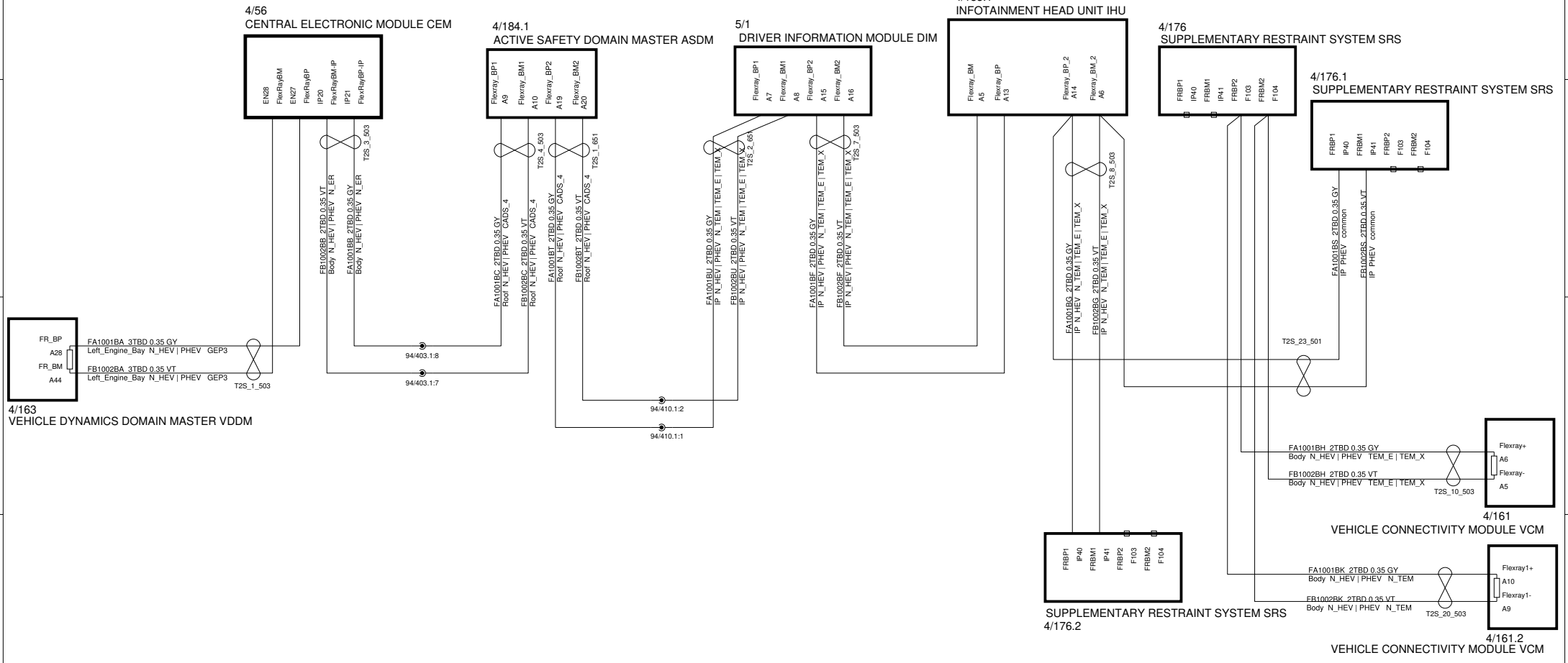

<p>The copying, distribution and utilization of this document as well as the communication of its contents to others without expressed authorization is prohibited. Offenders will be held liable for payment of damages. All rights reserved in the event of the grant of a patent, utility model or ornamental design registration.</p>  <p>VOLVO CAR CORPORATION</p>	Document title 623A_PP_CC_04_06_2023	
	1E_FlexRay_Backbone_ICE_PHEV	
	Document Type DRAW/ELSY	Release Status RELEASED
	CEVT Document No 8888522365	Edited April/12/2023
Issue 035	Page No 34/146	

1E Front 2 FlexRay

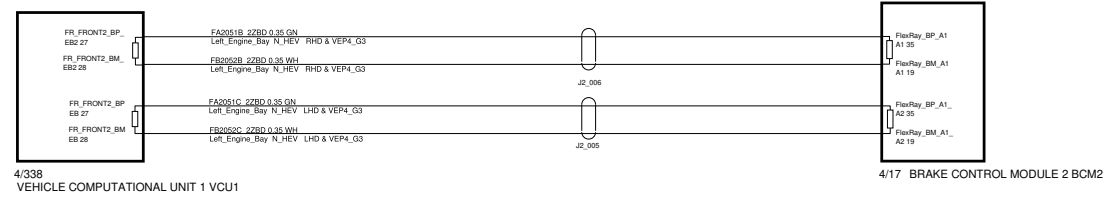
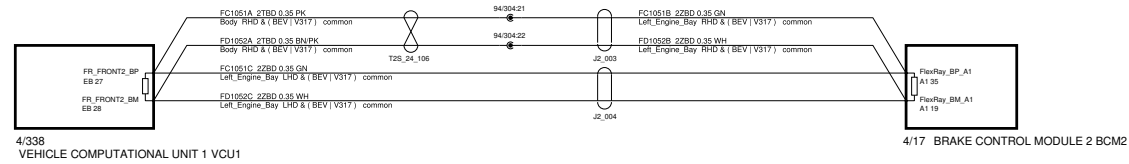

<p>The copying, distribution and utilization of this document as well as the communication of its contents to others without expressed authorization is prohibited. Offenders will be held liable for payment of damages. All rights reserved in the event of the grant of a patent, utility model or ornamental design registration.</p> <p>VOLVO VOLVO CAR CORPORATION</p>	<p>Document title 623A_PP_CC_04_06_2023 1E_FlexRay_Front_2</p>	
	<p>Document Type DRAW/ELSY</p>	<p>Release Status RELEASED</p>
	<p>Volvo Document No 33445458</p>	<p>Edited March/15/2023</p>
	<p>Issue 035</p>	<p>Page No 35/146</p>

1E Mid 2 FlexRay

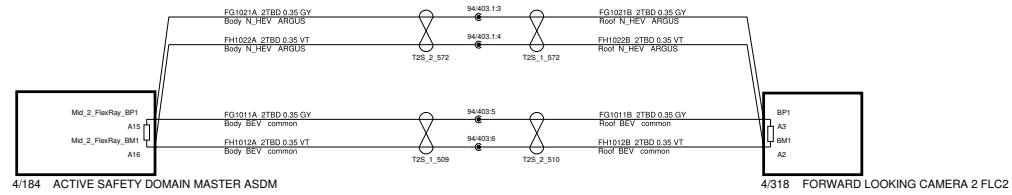

<p>The copying, distribution and utilization of this document as well as the communication of its contents to others without expressed authorization is prohibited. Offenders will be held liable for payment of damages. All rights reserved in the event of the grant of a patent, utility model or ornamental design registration.</p> <p>VOLVO VOLVO CAR CORPORATION</p>	Document title 623A_PP_CC_04_06_2023 1E_FlexRay_Mid_2	
	Document Type DRAW/ELSY	Release Status RELEASED
	Volvo Document No 33445458	Edited March/15/2023
	Issue 035	Page No 36/146

1E LIN Body Infotainment Powertrain

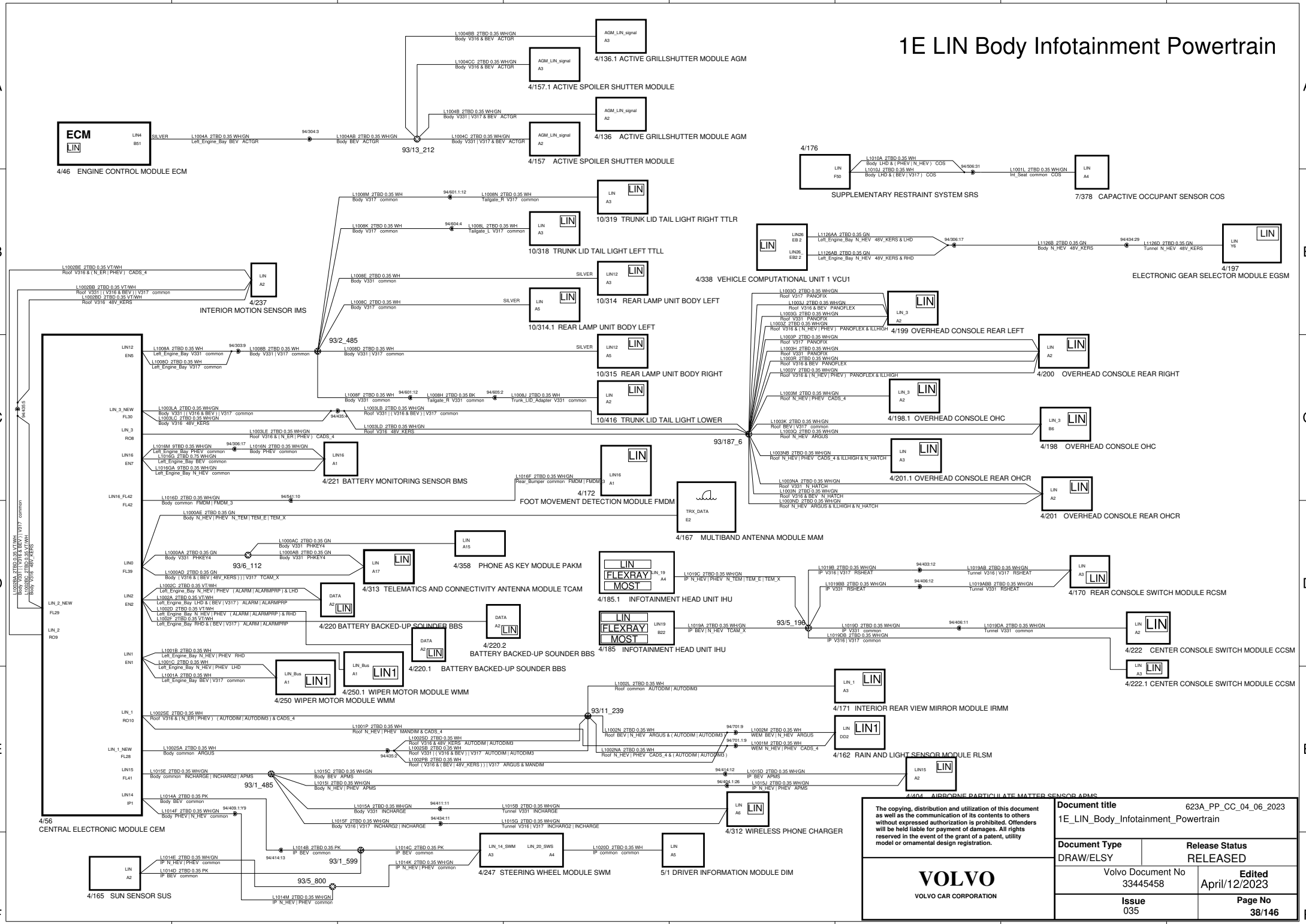

The copying, distribution and utilization of this document as well as the communication of its contents to others without expressed authorization is prohibited. Offenders will be held liable for payment of damages. All rights reserved in the event of the grant of a patent, utility model or ornamental design registration.



Document title		623A_PP_CC_04_06_2023	
1E_LIN_Body_Infotainment_Powertrain			
Document Type	Release Status		
DRAW/ELSY	RELEASED		
Issue	Volvo Document No	Edited	
035	33445458	April/12/2023	
		Page No	
		38/146	

1E LIN Body

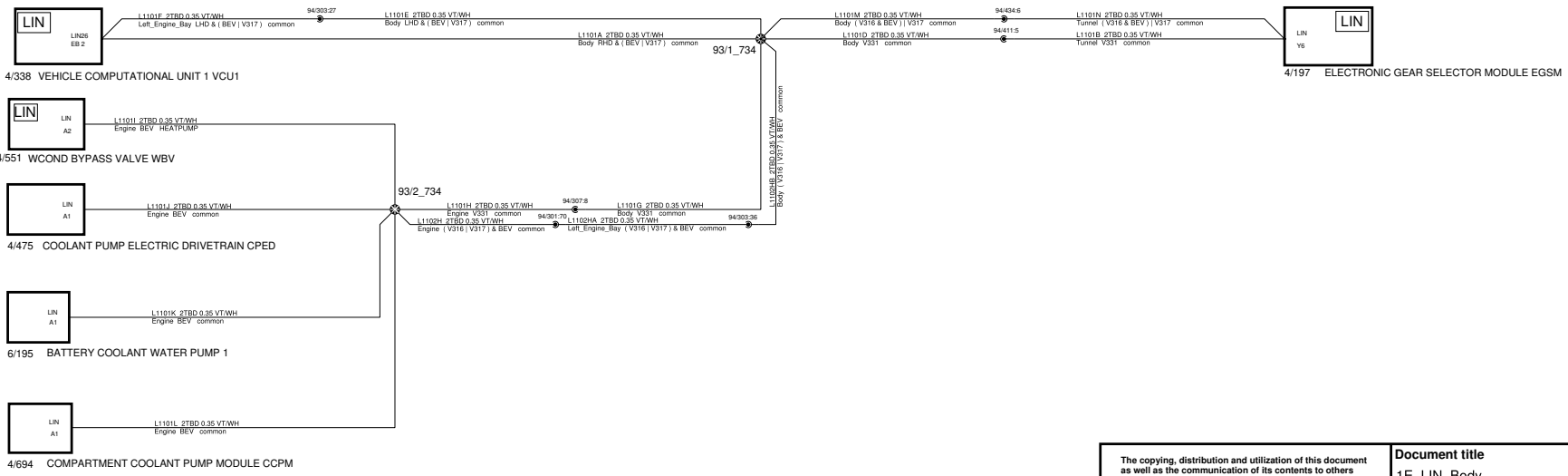
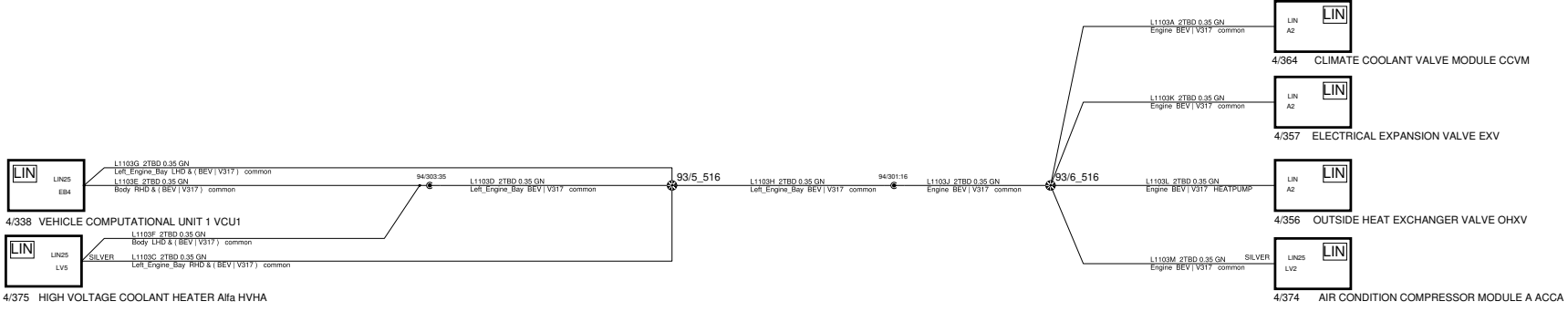

<p>The copying, distribution and utilization of this document as well as the communication of its contents to others without expressed authorization is prohibited. Offenders will be held liable for payment of damages. All rights reserved in the event of the grant of a patent, utility model or ornamental design registration.</p> <p>VOLVO VOLVO CAR CORPORATION</p>		<p>Document title: 623A_PP_CC_04_06_2023 1E_LIN_Body</p>	
		<p>Document Type: DRAW/ELSY</p>	<p>Release Status: RELEASED</p>
		<p>Volvo Document No: 33445458</p>	<p>Edited: April/12/2023</p>
		<p>Issue: 035</p>	<p>Page No: 37/146</p>

1E LIN Comfort

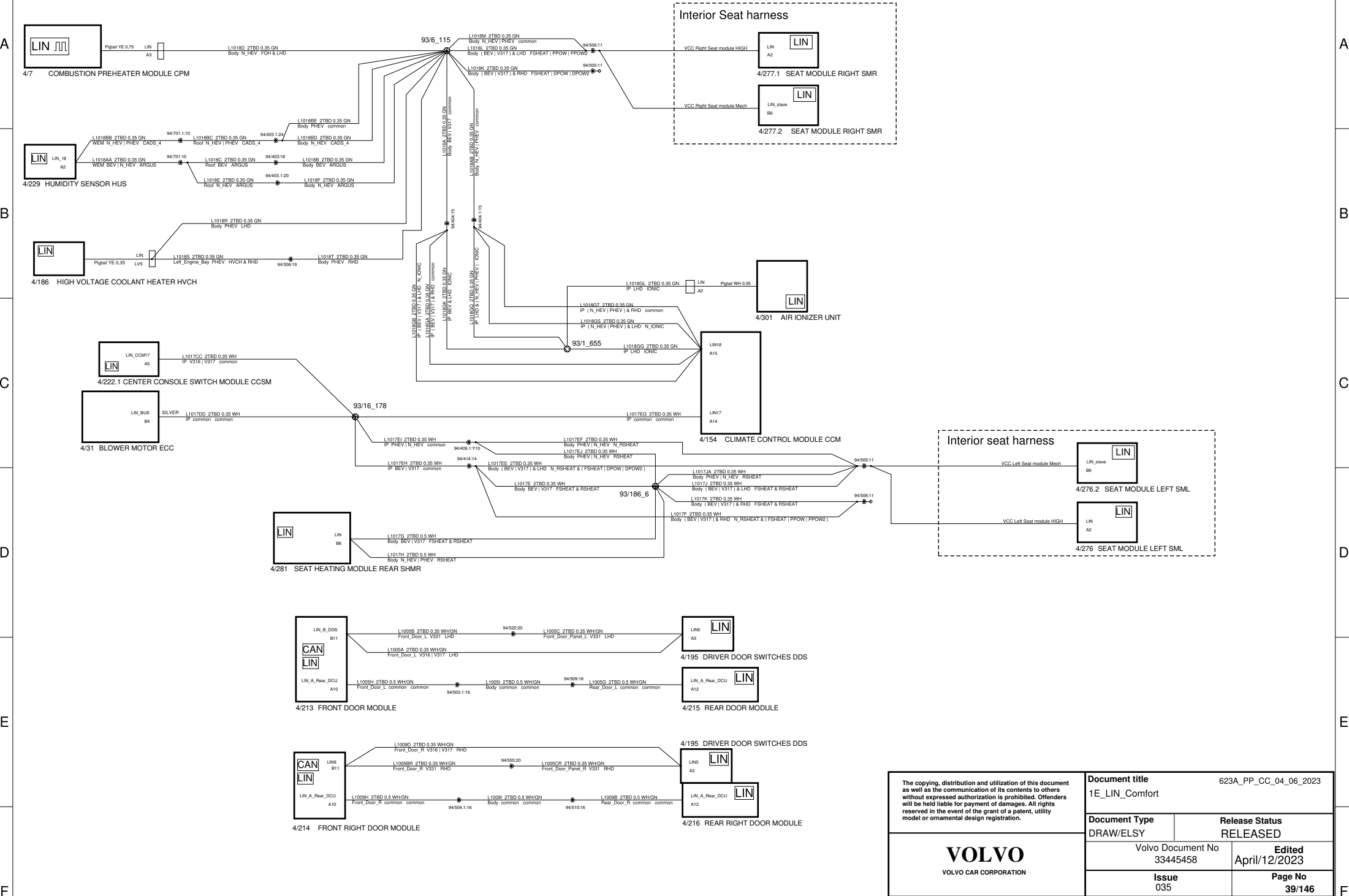

<p>The copying, distribution and utilization of this document as well as the communication of its contents to others without expressed authorization is prohibited. Offenders will be held liable for payment of damages. All rights reserved in the event of the grant of a patent, utility model or ornamental design registration.</p> <p>VOLVO VOLVO CAR CORPORATION</p>	Document title		623A_PP_CC_04_06_2023
	1E_LIN_Comfort		
	Document Type	Release Status	
	DRAW/ELSY	RELEASED	
	Volvo Document No 33445458	Edited April/12/2023	
	Issue 035	Page No 39/146	

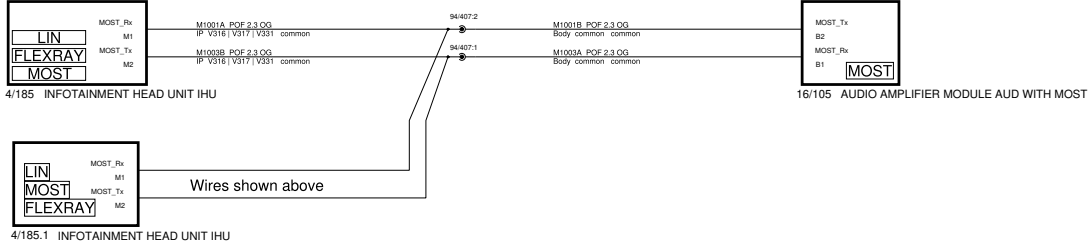

<p>The copying, distribution and utilization of this document as well as the communication of its contents to others without expressed authorization is prohibited. Offenders will be held liable for payment of damages. All rights reserved in the event of the grant of a patent, utility model or ornamental design registration.</p> <p>VOLVO VOLVO CAR CORPORATION</p>	<p>Document title 623A_PP_CC_04_06_2023</p> <p>1E_LIN_MOST</p>	
	<p>Document Type DRAW/ELSY</p>	<p>Release Status RELEASED</p>
	<p>Volvo Document No 33445458</p>	<p>Edited November/01/2021</p>
	<p>Issue 035</p>	<p>Page No 40/146</p>

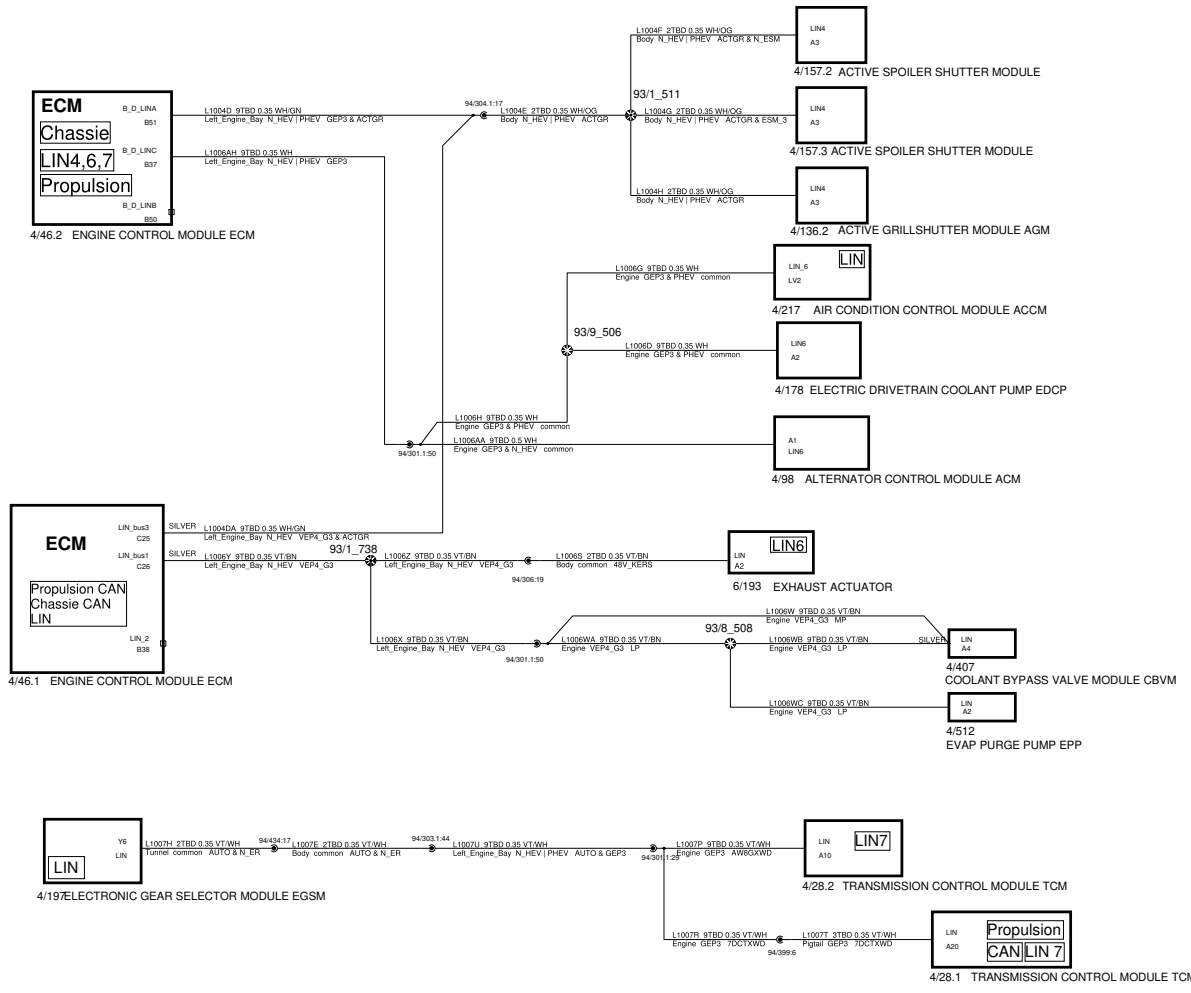

<p>The copying, distribution and utilization of this document as well as the communication of its contents to others without expressed authorization is prohibited. Offenders will be held liable for payment of damages. All rights reserved in the event of the grant of a patent, utility model or ornamental design registration.</p> <p>VOLVO VOLVO CAR CORPORATION</p>	<p>Document title 623A_PP_CC_04_06_2023 1E_LIN_POWERTRAIN_N_BEV</p>	
	<p>Document Type DRAW/ELSY</p>	<p>Release Status RELEASED</p>
	<p>CEVT Document No 8888522365</p>	<p>Edited April/12/2023</p>
	<p>Issue 035</p>	<p>Page No 41/146</p>

1F Accessories Preparation

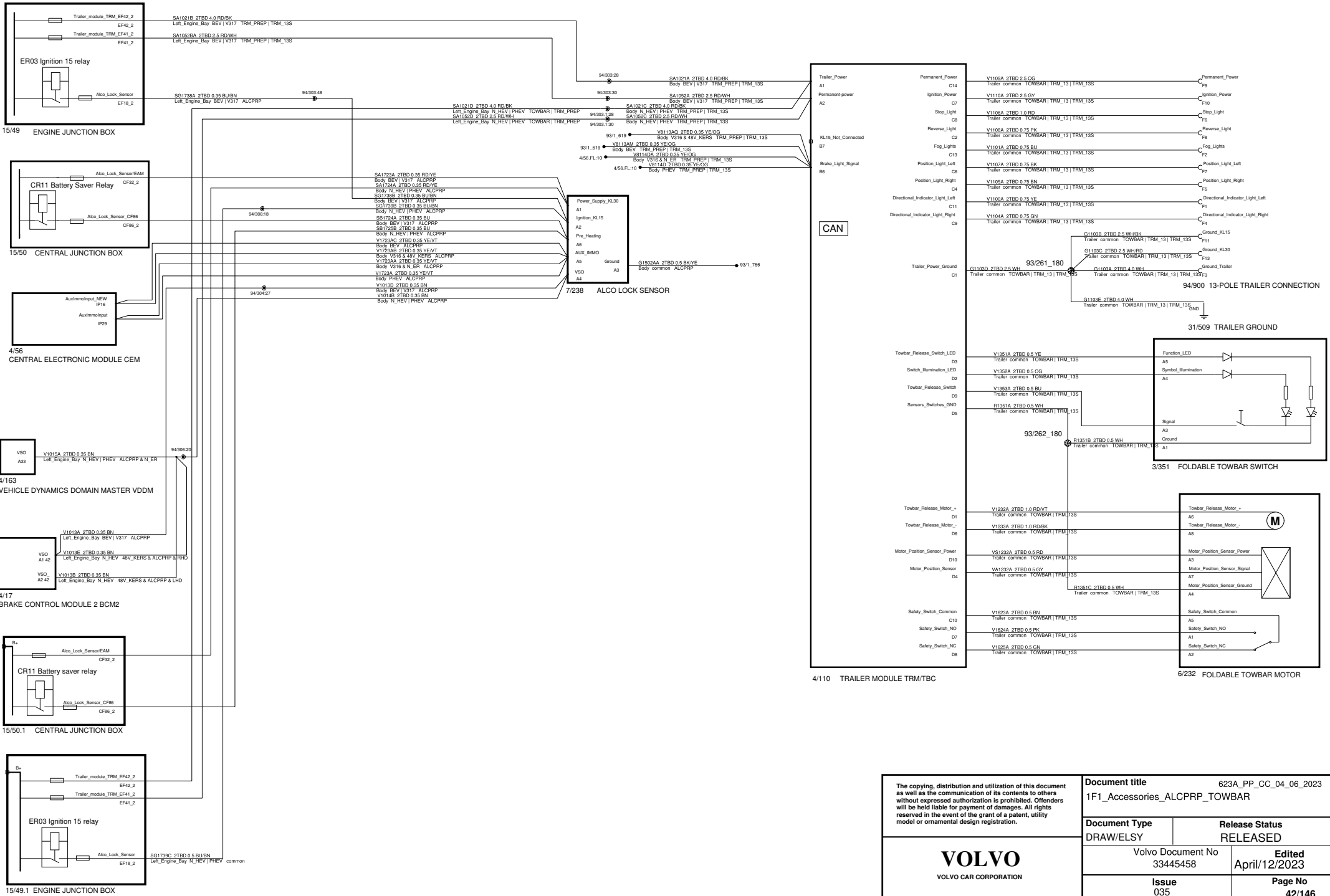

<p>The copying, distribution and utilization of this document as well as the communication of its contents to others without expressed authorization is prohibited. Offenders will be held liable for payment of damages. All rights reserved in the event of the grant of a patent, utility model or ornamental design registration.</p> <p>VOLVO VOLVO CAR CORPORATION</p>		<p>Document title 623A_PP_CC_04_06_2023 1F1_Accessories_ALCPRP_TOWBAR</p>	
		<p>Document Type DRAW/ELSY</p>	<p>Release Status RELEASED</p>
		<p>Volvo Document No 33445458</p>	<p>Edited April/12/2023</p>
		<p>Issue 035</p>	<p>Page No 42/146</p>



15/49 ENGINE JUNCTION BOX

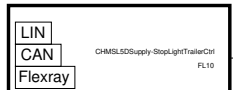

4/56 CENTRAL ELECTRONIC MODULE CEM

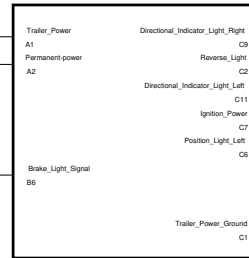

4/110 TRAILER MODULE TRM/TBC

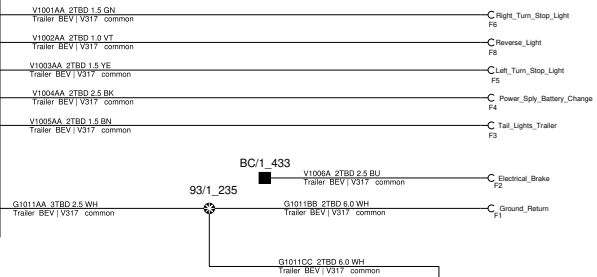

94/900.1
4/7-POLE TRAILER CONNECTION

<p>The copying, distribution and utilization of this document as well as the communication of its contents to others without expressed authorization is prohibited. Offenders will be held liable for payment of damages. All rights reserved in the event of the grant of a patent, utility model or ornamental design registration.</p> <p>VOLVO VOLVO CAR CORPORATION</p>	<p>Document title 623A_PP_CC_04_06_2023 1F2_Assessories_Towing_System_4/7-pole_US</p>	
	<p>Document Type DRAW/ELSY</p>	<p>Release Status RELEASED</p>
	<p>CEVT Document No 8888522365</p>	<p>Edited June/16/2021</p>
	<p>Issue 035</p>	<p>Page No 43/146</p>

1F3 Accessories Rear Park Assist Camera

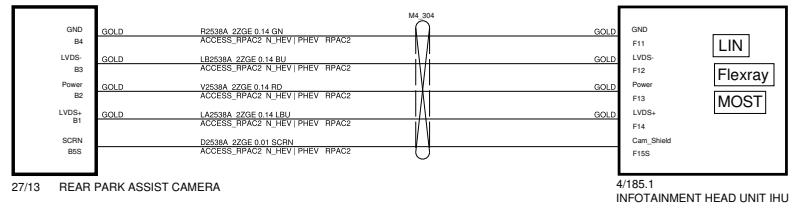

<p>The copying, distribution and utilization of this document as well as the communication of its contents to others without expressed authorization is prohibited. Offenders will be held liable for payment of damages. All rights reserved in the event of the grant of a patent, utility model or ornamental design registration.</p> <p>VOLVO VOLVO CAR CORPORATION</p>	Document title 623A_PP_CC_04_06_2023 1F3_Accessories_Rear_Park_Assist_Camera	
	Document Type DRAW/ELSY	Release Status RELEASED
	CEVT Document No 8888522365	Edited November/01/2021
	Issue 035	Page No 44/146

1F4 Accessories USB Hub Installation Aftermarket

Intended solution to provide USB Hub to replace USB1 functionality
 [Valid up until structure 19W17]

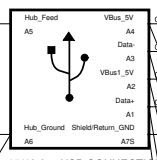
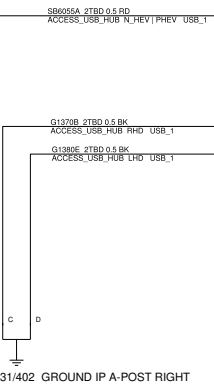
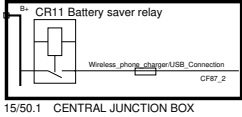

Wires shown on 7A Infotainment page

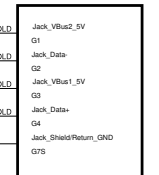
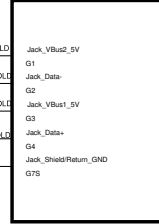

<p>The copying, distribution and utilization of this document as well as the communication of its contents to others without expressed authorization is prohibited. Offenders will be held liable for payment of damages. All rights reserved in the event of the grant of a patent, utility model or ornamental design registration.</p> <p>VOLVO VOLVO CAR CORPORATION</p>	<p>Document title 623A_PP_CC_04_06_2023 1F4_Accessories_USB_Hub_Installation_Aftermarket</p>	
	<p>Document Type DRAW/ELSY</p>	<p>Release Status RELEASED</p>
	<p>CEVT Document No 8888522365</p>	<p>Edited November/01/2021</p>
	<p>Issue 035</p>	<p>Page No 45/146</p>

1F5 Accessories Steering Wheel Heating

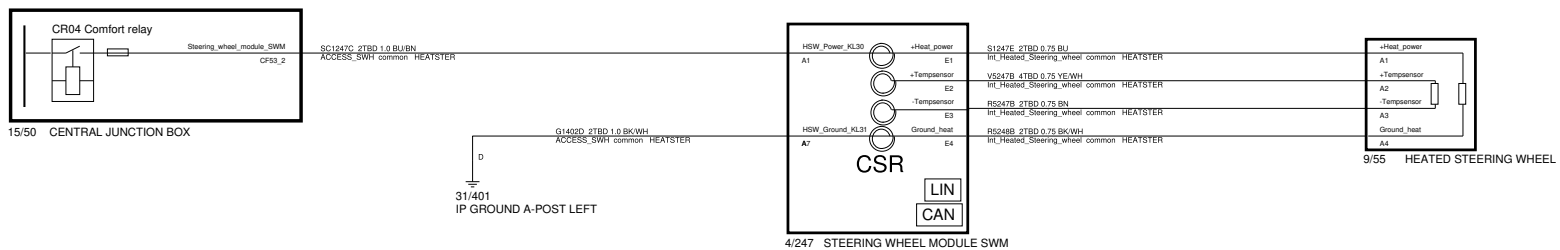

<p>The copying, distribution and utilization of this document as well as the communication of its contents to others without expressed authorization is prohibited. Offenders will be held liable for payment of damages. All rights reserved in the event of the grant of a patent, utility model or ornamental design registration.</p> <p>VOLVO VOLVO CAR CORPORATION</p>	<p>Document title 623A_PP_CC_04_06_2023 1F5_Accessories_Steering_Wheel_Heating</p>	
	<p>Document Type DRAW/ELSY</p>	<p>Release Status RELEASED</p>
	<p>CEVT Document No 8888522365</p>	<p>Edited April/12/2023</p>
	<p>Issue 035</p>	<p>Page No 46/146</p>

1H EI Distribution High Voltage

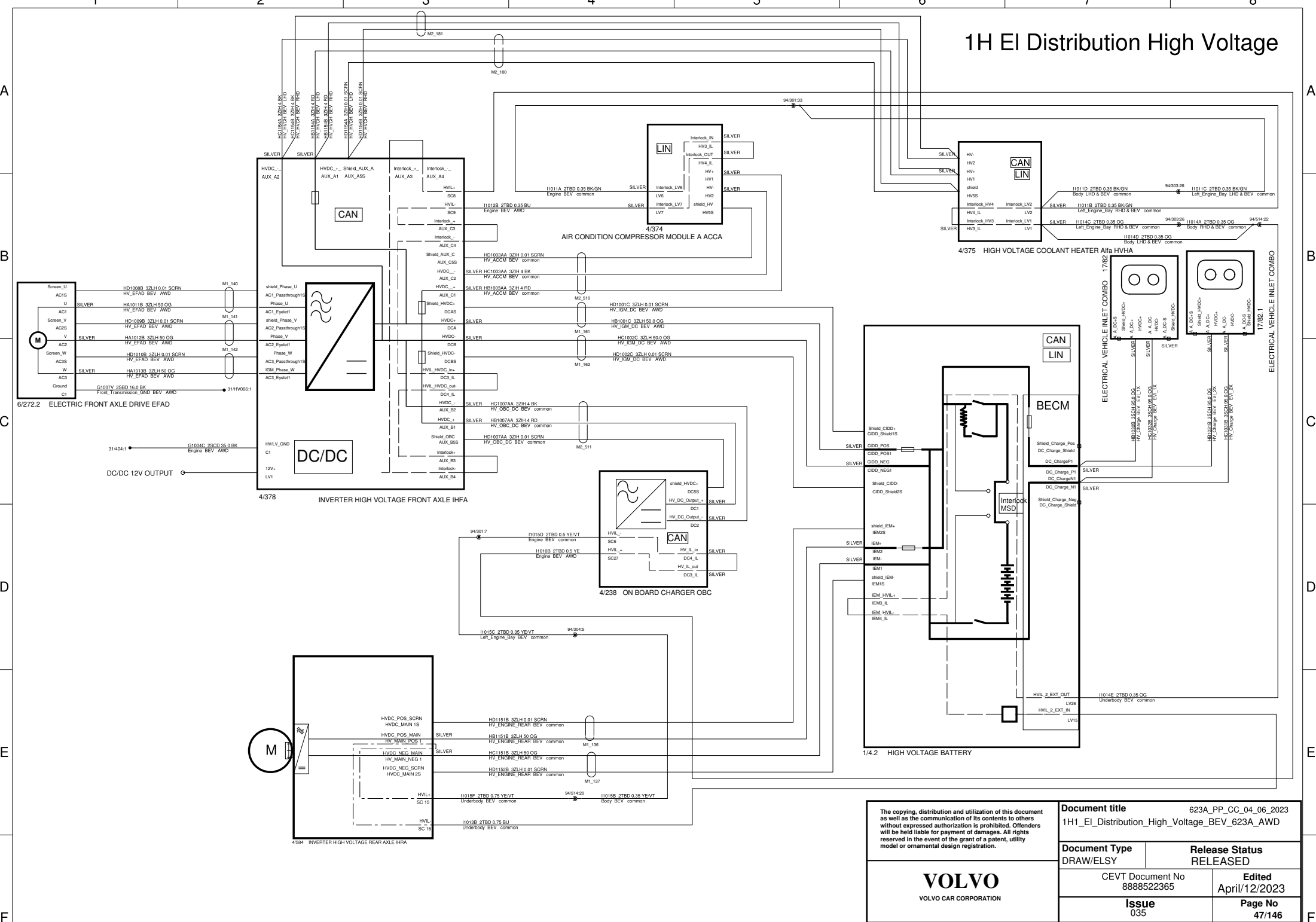

The copying, distribution and utilization of this document as well as the communication of its contents to others without expressed authorization is prohibited. Offenders will be held liable for payment of damages. All rights reserved in the event of the grant of a patent, utility model or ornamental design registration.

VOLVO
VOLVO CAR CORPORATION

Document title 623A_PP_CC_04_06_2023 1H1_EI_Distribution_High_Voltage_BEV_623A_AWD	
Document Type DRAW/ELSY	Release Status RELEASED
CEVT Document No 8888522365	Edited April/12/2023
Issue 035	Page No 47/146

1H EI Distribution High Voltage

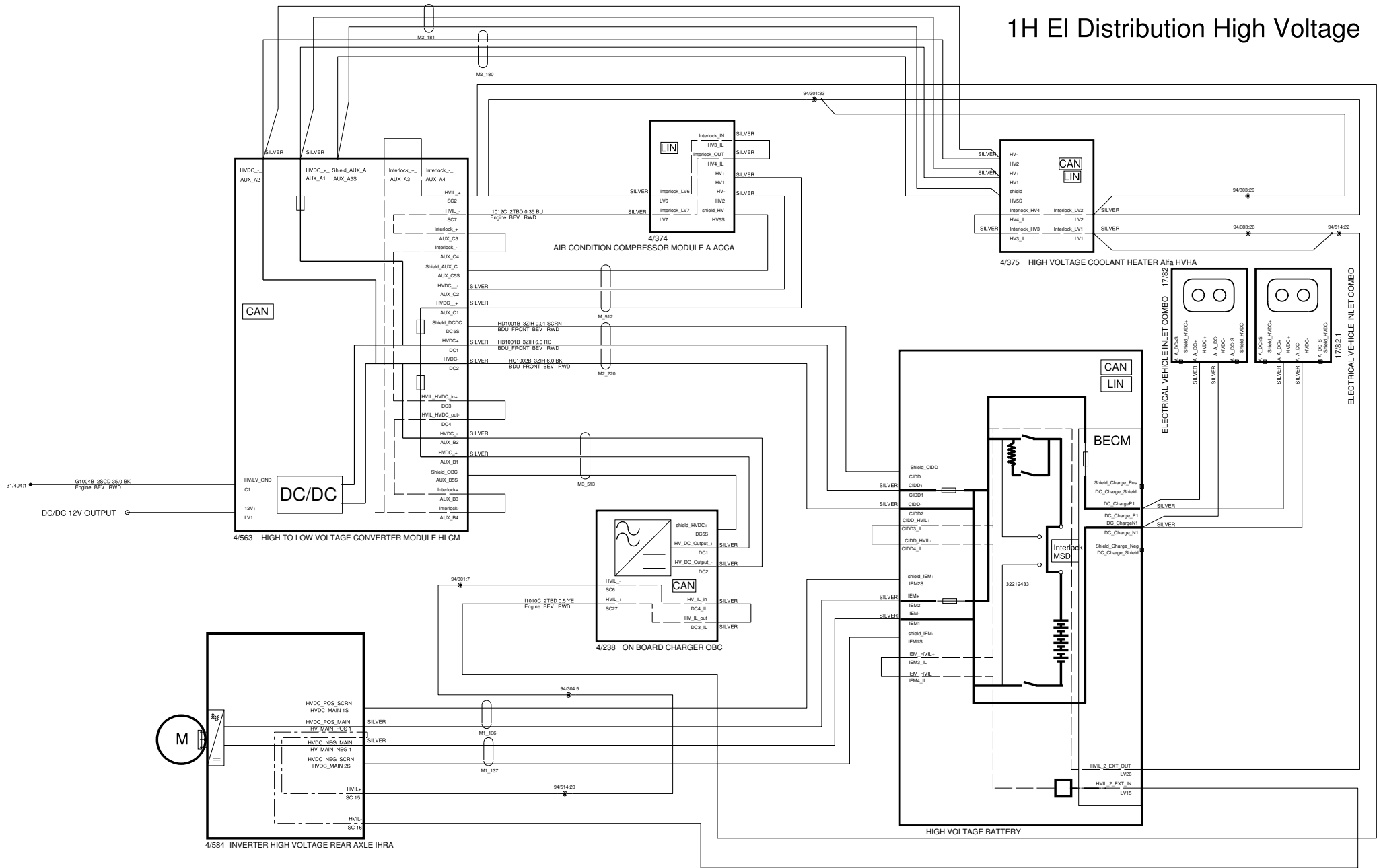

The copying, distribution and utilization of this document as well as the communication of its contents to others without expressed authorization is prohibited. Offenders will be held liable for payment of damages. All rights reserved in the event of the grant of a patent, utility model or ornamental design registration.

VOLVO
VOLVO CAR CORPORATION

Document title 623A_PP_CC_04_06_2023
1H1_EI_Distribution_High_Voltage_BEV_623A_FWD

Document Type DRAW/ELSY
Release Status RELEASED

CEVT Document No 8888522365
Edited April/12/2023

Issue 035
Page No 48/146

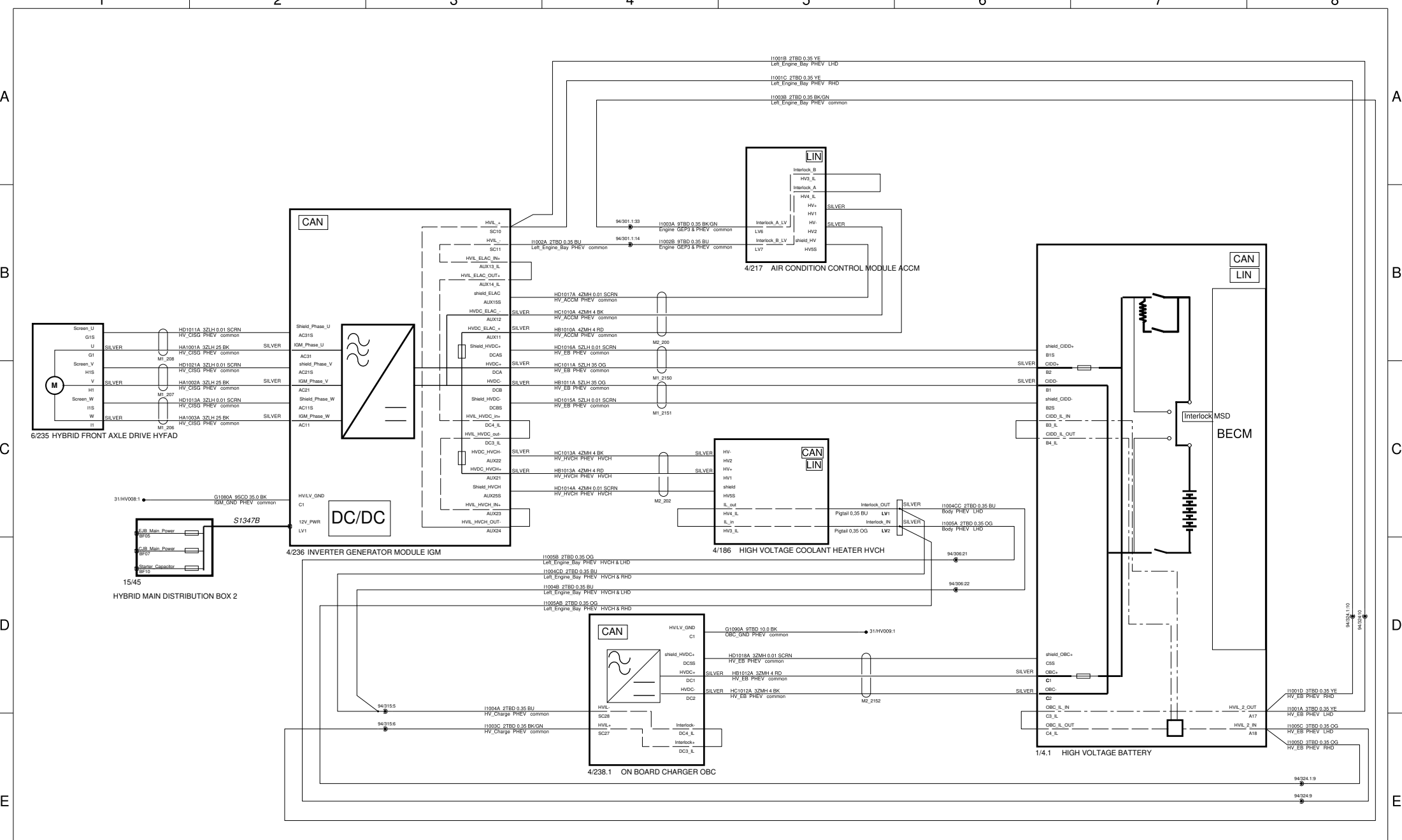

<p>The copying, distribution and utilization of this document as well as the communication of its contents to others without expressed authorization is prohibited. Offenders will be held liable for payment of damages. All rights reserved in the event of the grant of a patent, utility model or ornamental design registration.</p>		<p>Document title 623A_PP_CC_04_06_2023 1H2_EI_Distribution_High_Voltage_PHEV</p>	
		<p>Document Type DRAW/ELSY</p>	<p>Release Status RELEASED</p>
<p>VOLVO VOLVO CAR CORPORATION</p>		<p>CEVT Document No 8888522365</p>	<p>Edited March/30/2023</p>
		<p>Issue 035</p>	<p>Page No 49/146</p>

1K EI Energy Management High Voltage 623

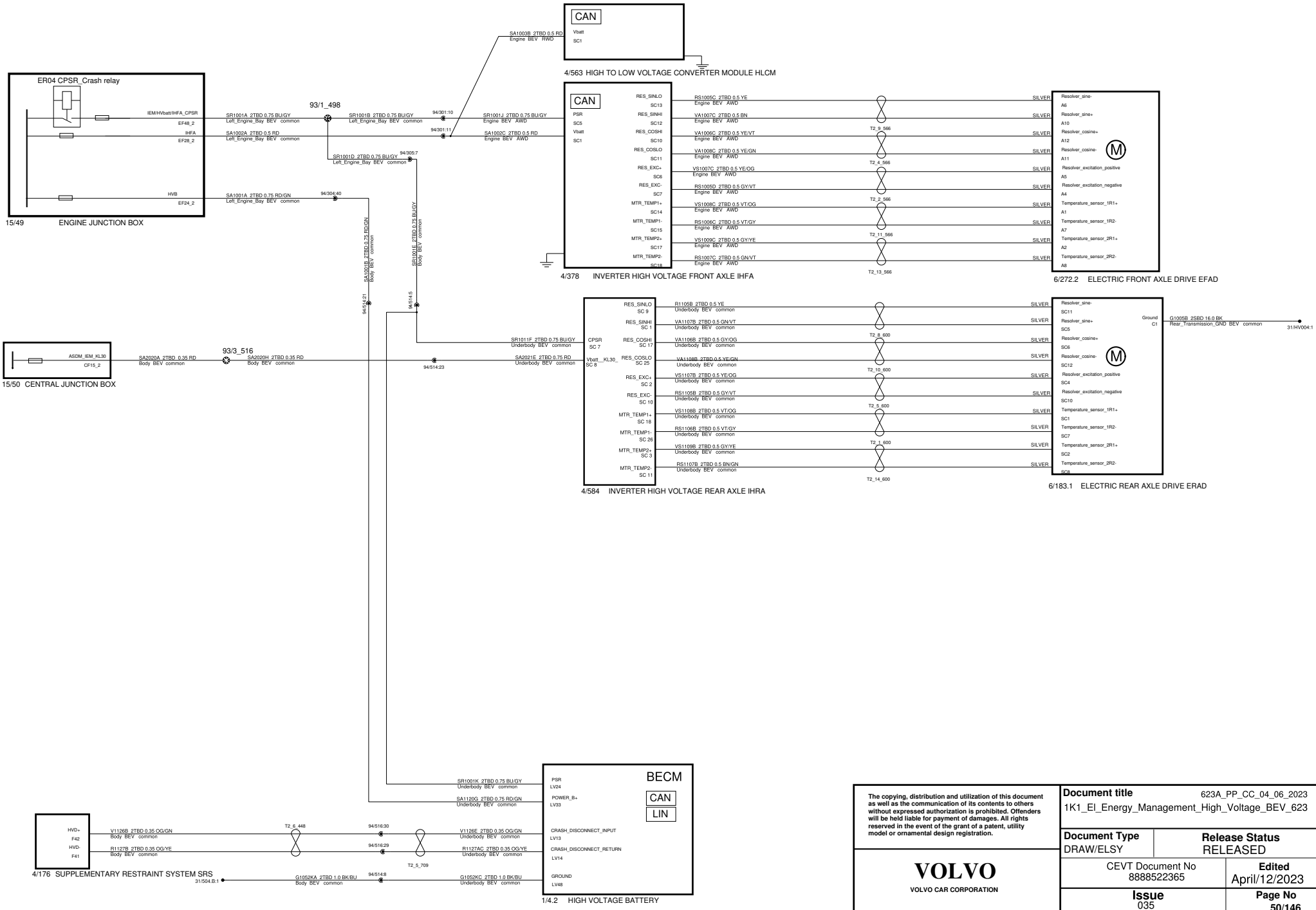

<p>The copying, distribution and utilization of this document as well as the communication of its contents to others without expressed authorization is prohibited. Offenders will be held liable for payment of damages. All rights reserved in the event of the grant of a patent, utility model or ornamental design registration.</p>		<p>Document title 623A_PP_CC_04_06_2023 1K1_EI_Energy_Management_High_Voltage_BEV_623</p>	
		<p>Document Type DRAW/ELSY</p>	<p>Release Status RELEASED</p>
<p>VOLVO VOLVO CAR CORPORATION</p>		<p>CEVT Document No 8888522365</p>	<p>Edited April/12/2023</p>
		<p>Issue 035</p>	<p>Page No 50/146</p>

1K EI Energy Management High Voltage-China Market ARTEI-27579

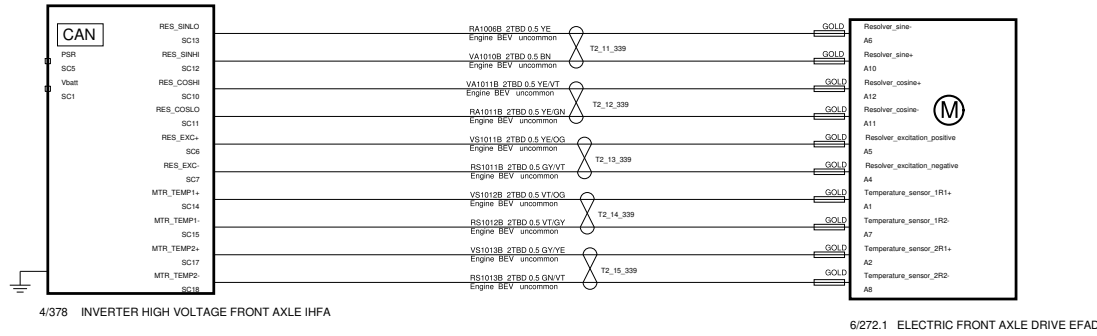

<p>The copying, distribution and utilization of this document as well as the communication of its contents to others without expressed authorization is prohibited. Offenders will be held liable for payment of damages. All rights reserved in the event of the grant of a patent, utility model or ornamental design registration.</p> <p>VOLVO VOLVO CAR CORPORATION</p>	Document title 623A_PP_CC_04_06_2023 1K2_EI_Energy_Managemnet_High_Voltage_BEV_3X	
	Document Type DRAW/ELSY	Release Status RELEASED
	CEVT Document No 8888522365	Edited April/04/2023
	Issue 035	Page No 51/146

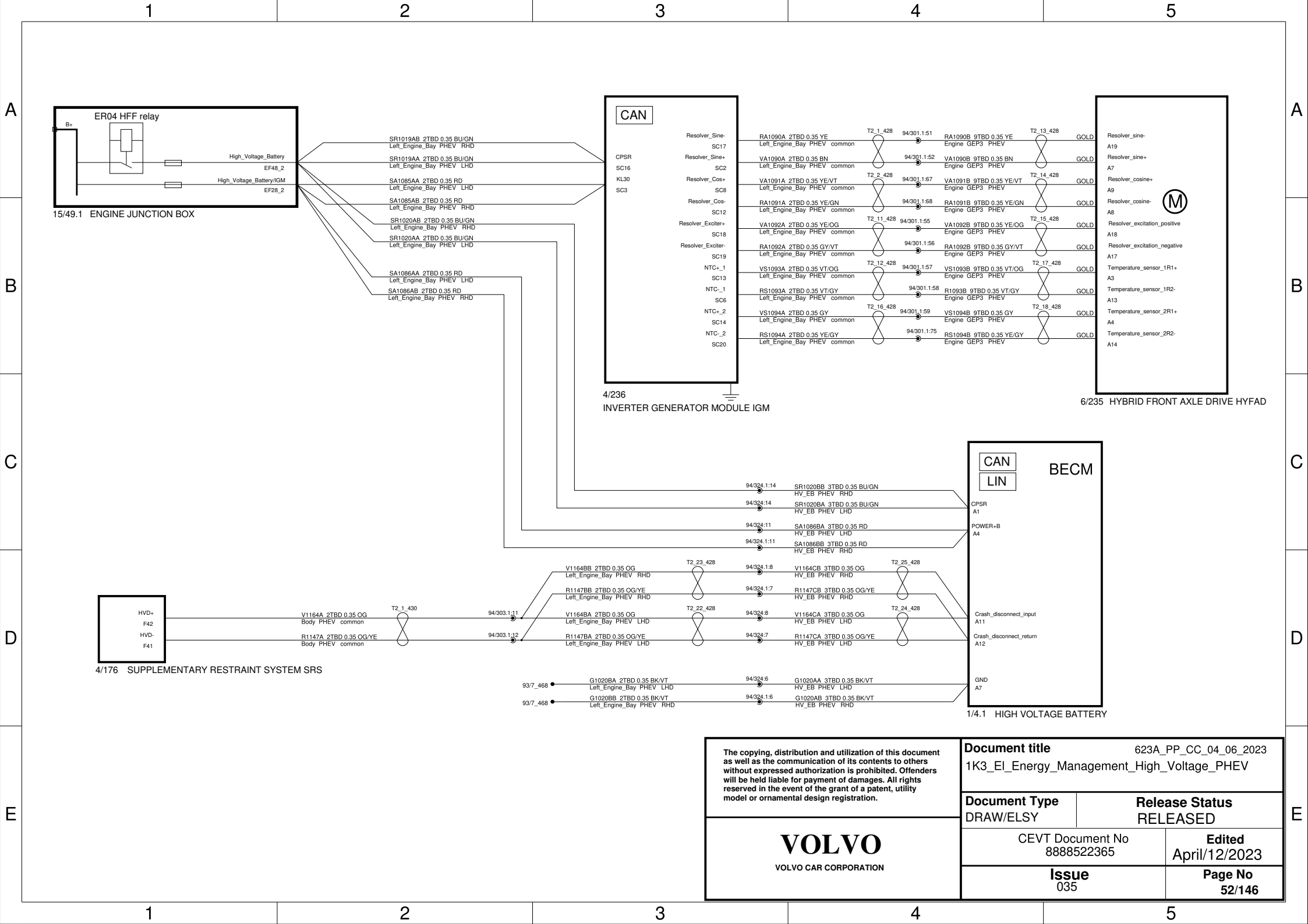

The copying, distribution and utilization of this document as well as the communication of its contents to others without expressed authorization is prohibited. Offenders will be held liable for payment of damages. All rights reserved in the event of the grant of a patent, utility model or ornamental design registration.



Document title		623A_PP_CC_04_06_2023	
1K3_EI_Energy_Management_High_Voltage_PHEV			
Document Type		Release Status	
DRAW/ELSY		RELEASED	
CEVT Document No		Edited	
8888522365		April/12/2023	
Issue		Page No	
035		52/146	

DC Charging wires in sheet 1H

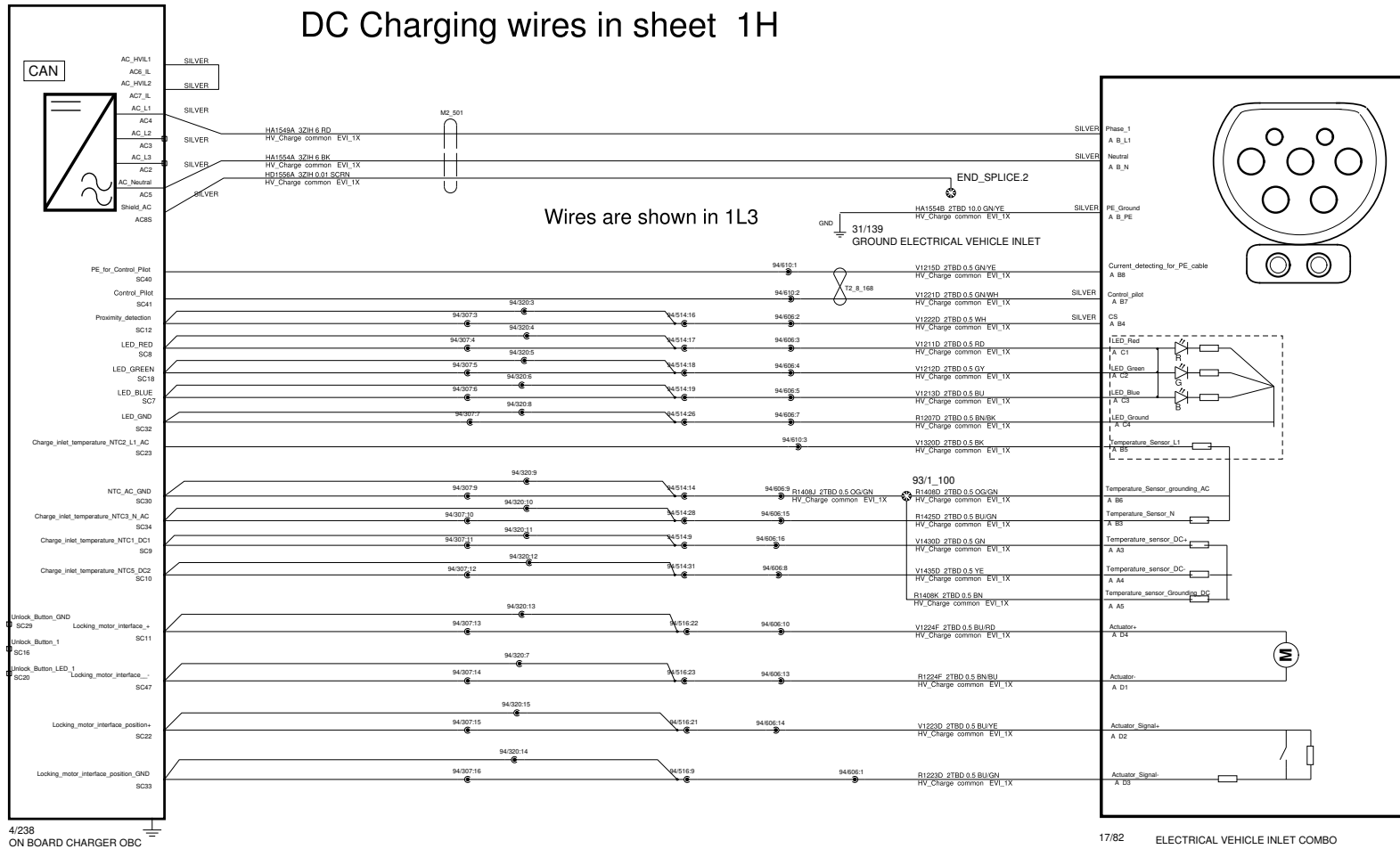

<p>VOLVO VOLVO CAR CORPORATION</p>	<p>Document title 623A_PP_CC_04_06_2023 1L1_EI_generating_public_network_1X</p>	
	<p>Document Type DRAW/ELSY</p>	<p>Release Status RELEASED</p>
	<p>CEVT Document No 8888522365</p>	<p>Edited March/21/2023</p>
	<p>Issue 035</p>	<p>Page No 53/146</p>

1L3 EI generating public network

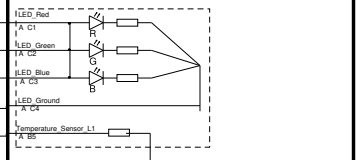
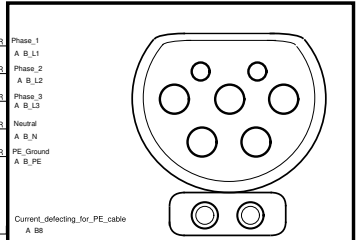
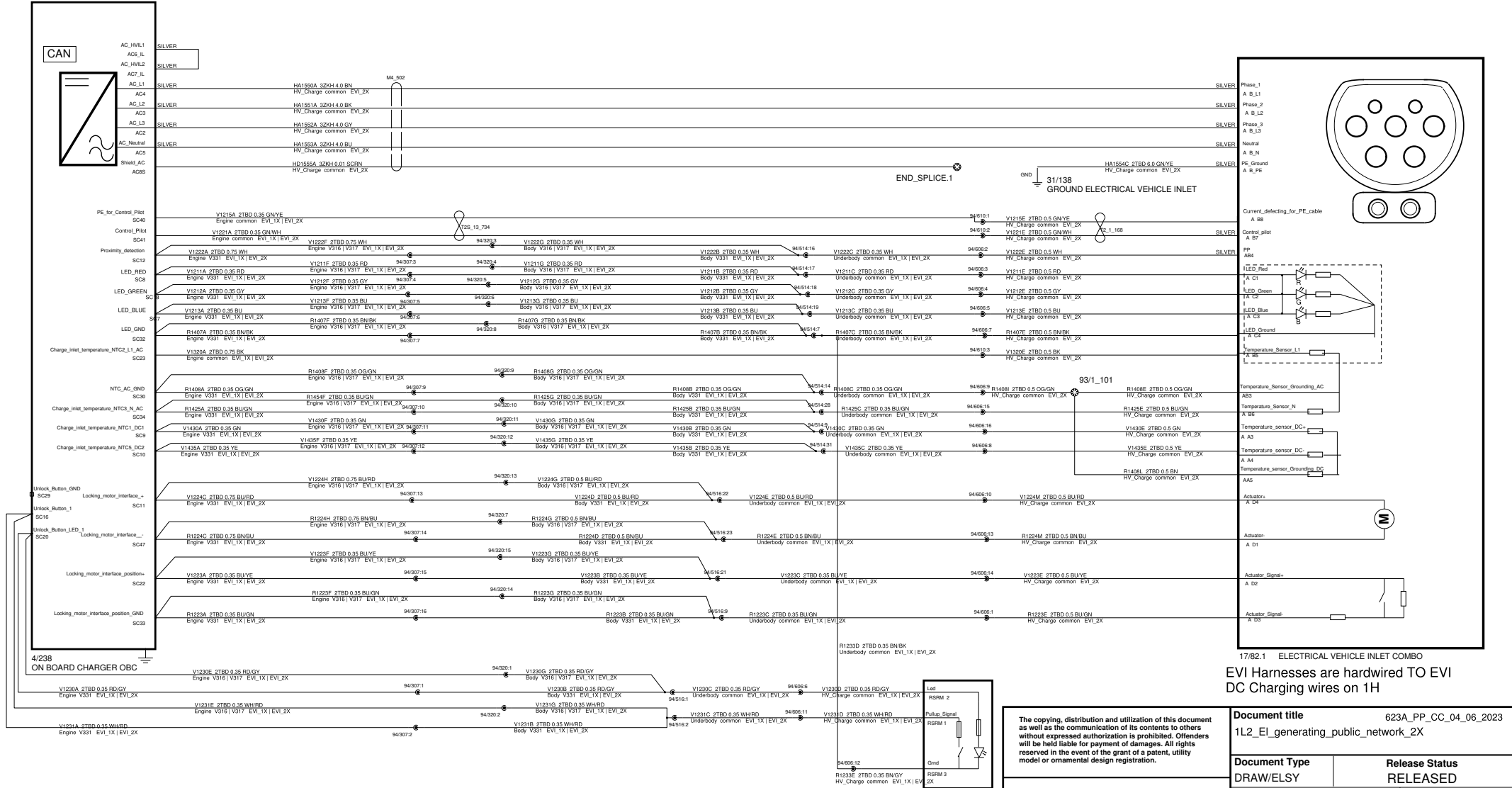

EVI Harnesses are hardwired TO EVI DC Charging wires on 1H

The copying, distribution and utilization of this document as well as the communication of its contents to others without expressed authorization is prohibited. Offenders will be held liable for payment of damages. All rights reserved in the event of the grant of a patent, utility model or ornamental design registration.

Document title: 623A_PP_CC_04_06_2023
1L2_EI_generating_public_network_2X

Document Type	Release Status
DRAW/ELSY	RELEASED
Volvo Document No 33445458	Edited April/12/2023
Issue 035	Page No 54/146

VOLVO
VOLVO CAR CORPORATION

3/447
CHARGE CABLE RELEASE SWITCH

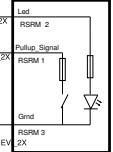

1L4 EI generating public network

EVI harnesses are hardwired to EVI

GROUND ELECTRICAL VEHICAL INLET

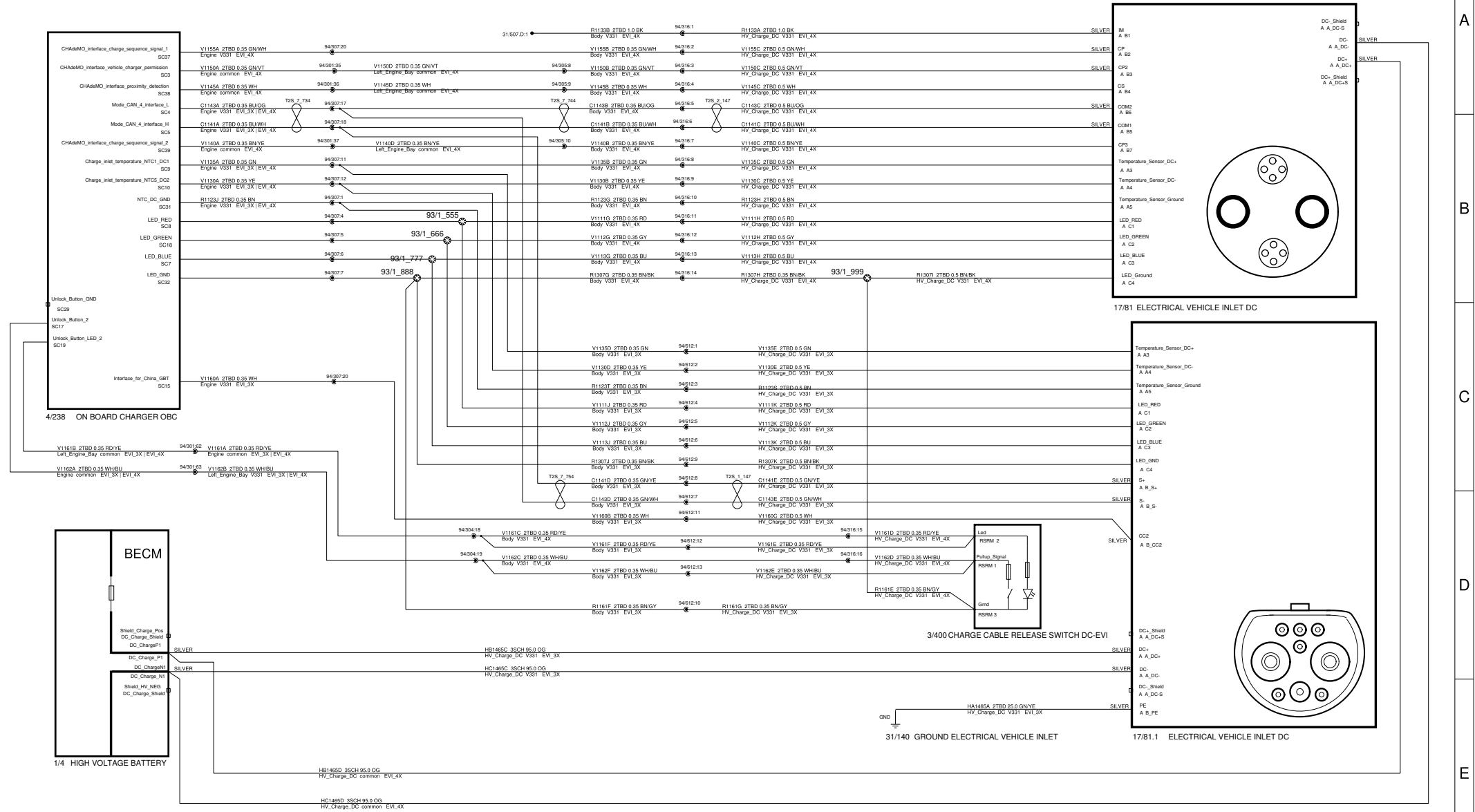

<p>The copying, distribution and utilization of this document as well as the communication of its contents to others without expressed authorization is prohibited. Offenders will be held liable for payment of damages. All rights reserved in the event of the grant of a patent, utility model or ornamental design registration.</p>		<p>Document title 623A_PP_CC_04_06_2023 1L3_EI_generating_public_network_V331_3X-4X_DC</p>	
<p>Document Type DRAW/ELSY</p>		<p>Release Status RELEASED</p>	
<p>CEVT Document No 8888522365</p>		<p>Edited April/12/2023</p>	
<p>Issue 035</p>		<p>Page No 55/146</p>	



1L7 EI generating public network

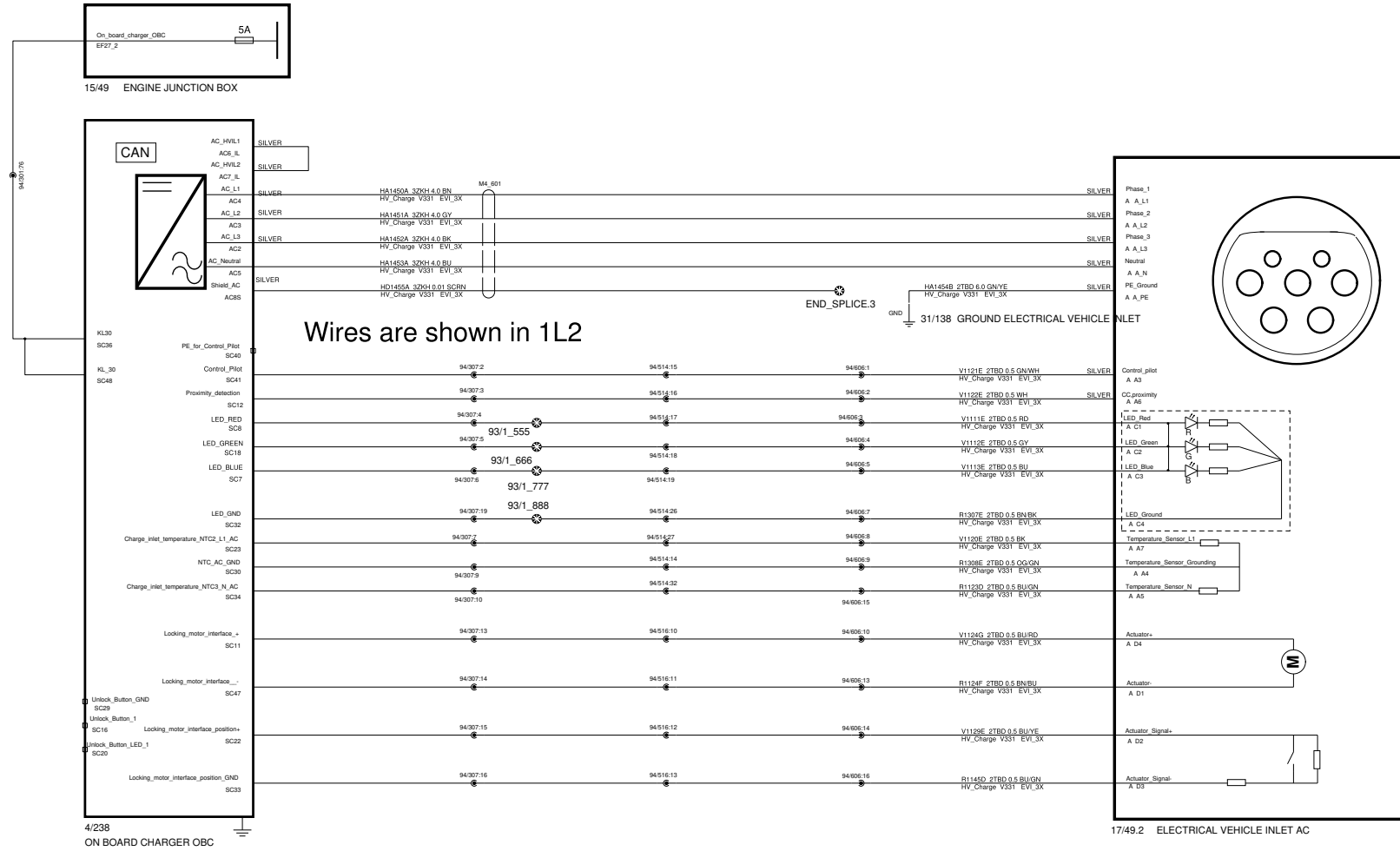

<p>VOLVO VOLVO CAR CORPORATION</p>	<p>The copying, distribution and utilization of this document as well as the communication of its contents to others without expressed authorization is prohibited. Offenders will be held liable for payment of damages. All rights reserved in the event of the grant of a patent, utility model or ornamental design registration.</p>		<p>Document title 623A_PP_CC_04_06_2023 1L4_EI_generating_public_network_V331_3X_AC</p>	
	<p>Document Type DRAW/ELSY</p>		<p>Release Status RELEASED</p>	
	<p>CEVT Document No 8888522365</p>		<p>Edited April/12/2023</p>	
	<p>Issue 035</p>		<p>Page No 56/146</p>	

1L2 EI generating public network

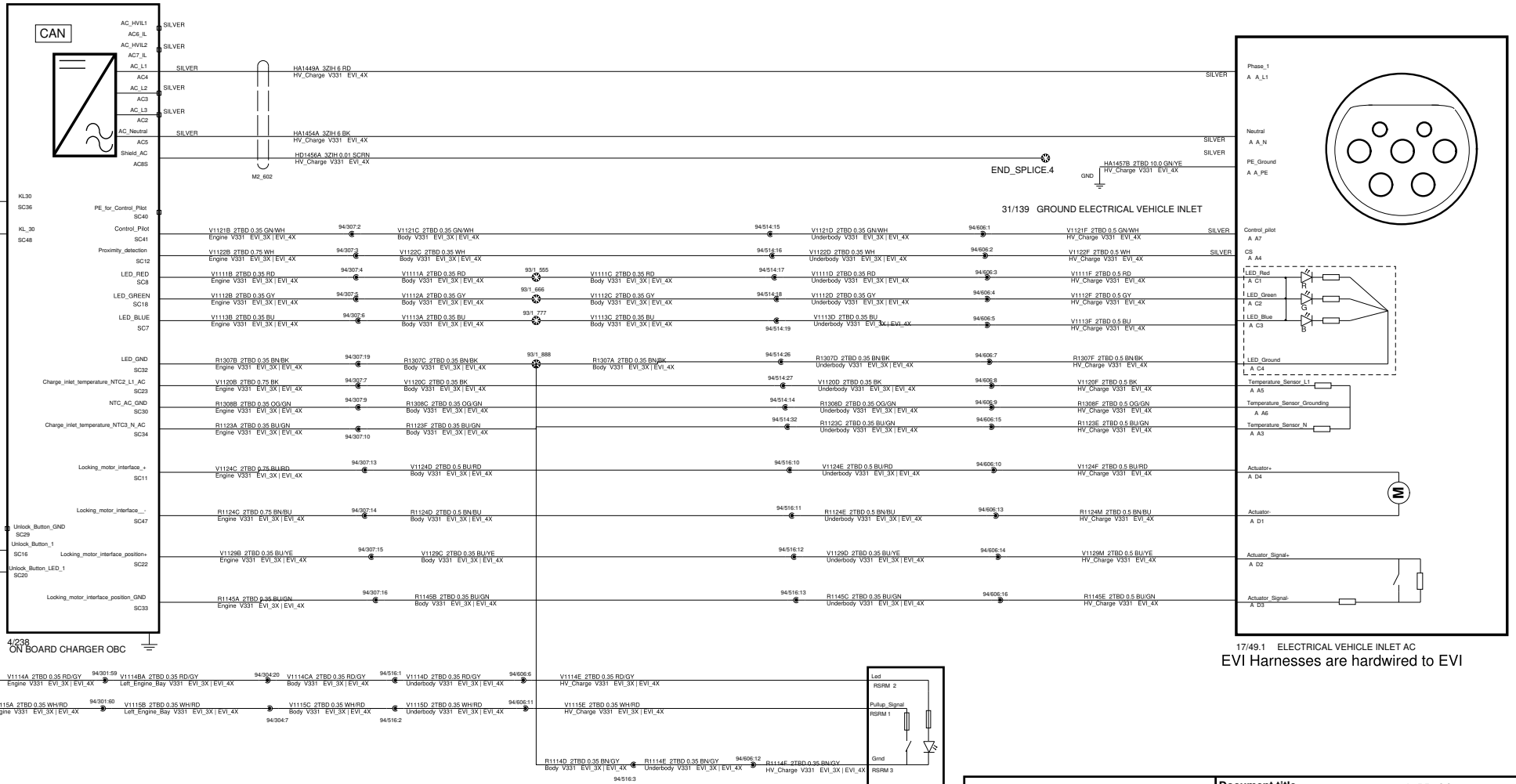
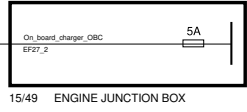

The copying, distribution and utilization of this document as well as the communication of its contents to others without expressed authorization is prohibited. Offenders will be held liable for payment of damages. All rights reserved in the event of the grant of a patent, utility model or ornamental design registration.		Document title 623A_PP_OC_04_06_2023 1L5_Ei_generating_public_network_V331_4X_AC	
Document Type DRAW/ELSY	Release Status RELEASED		Edited April/12/2023
Volvo Document No 33445458		Page No 57/146	
Issue 035			

VOLVO
VOLVO CAR CORPORATION

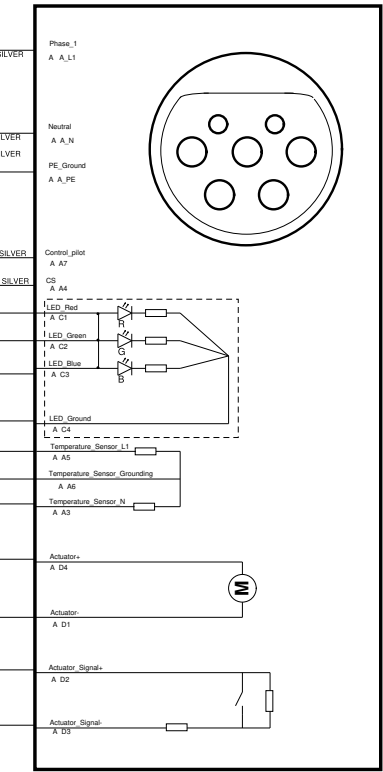

17/49.1 ELECTRICAL VEHICLE INLET AC
EVI Harnesses are hardwired to EVI

1L6 EI generating public network

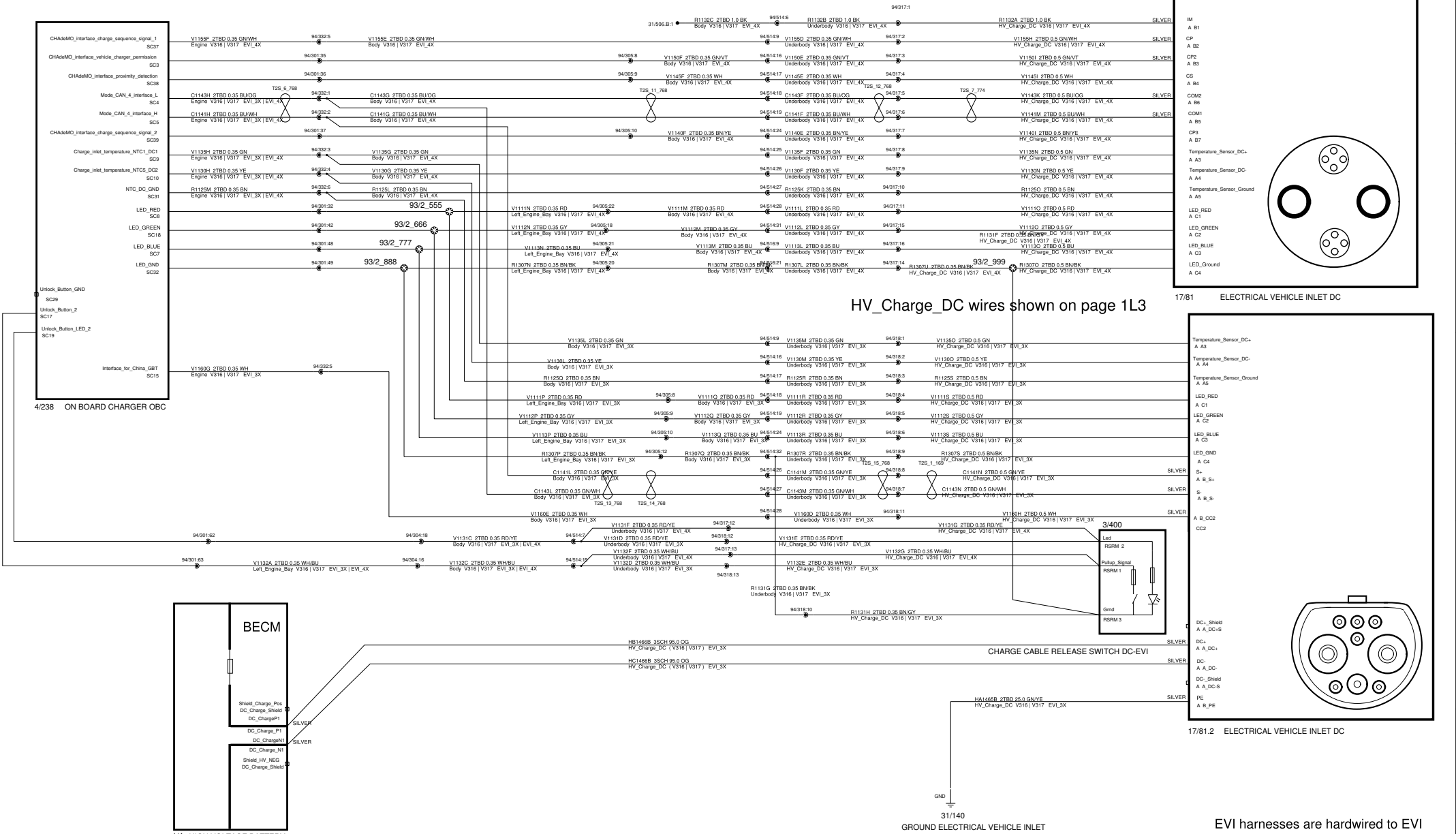

<p>The copying, distribution and utilization of this document as well as the communication of its contents to others without expressed authorization is prohibited. Offenders will be held liable for payment of damages. All rights reserved in the event of the grant of a patent, utility model or ornamental design registration.</p>		Document title	
		623A_PP_CC_04_06_2023	
Document Type		Release Status	
DRAW/ELSY		RELEASED	
CEVT Document No 8888522365		Edited April/12/2023	
Issue 035		Page No 58/146	



EVI harnesses are hardwired to EVI

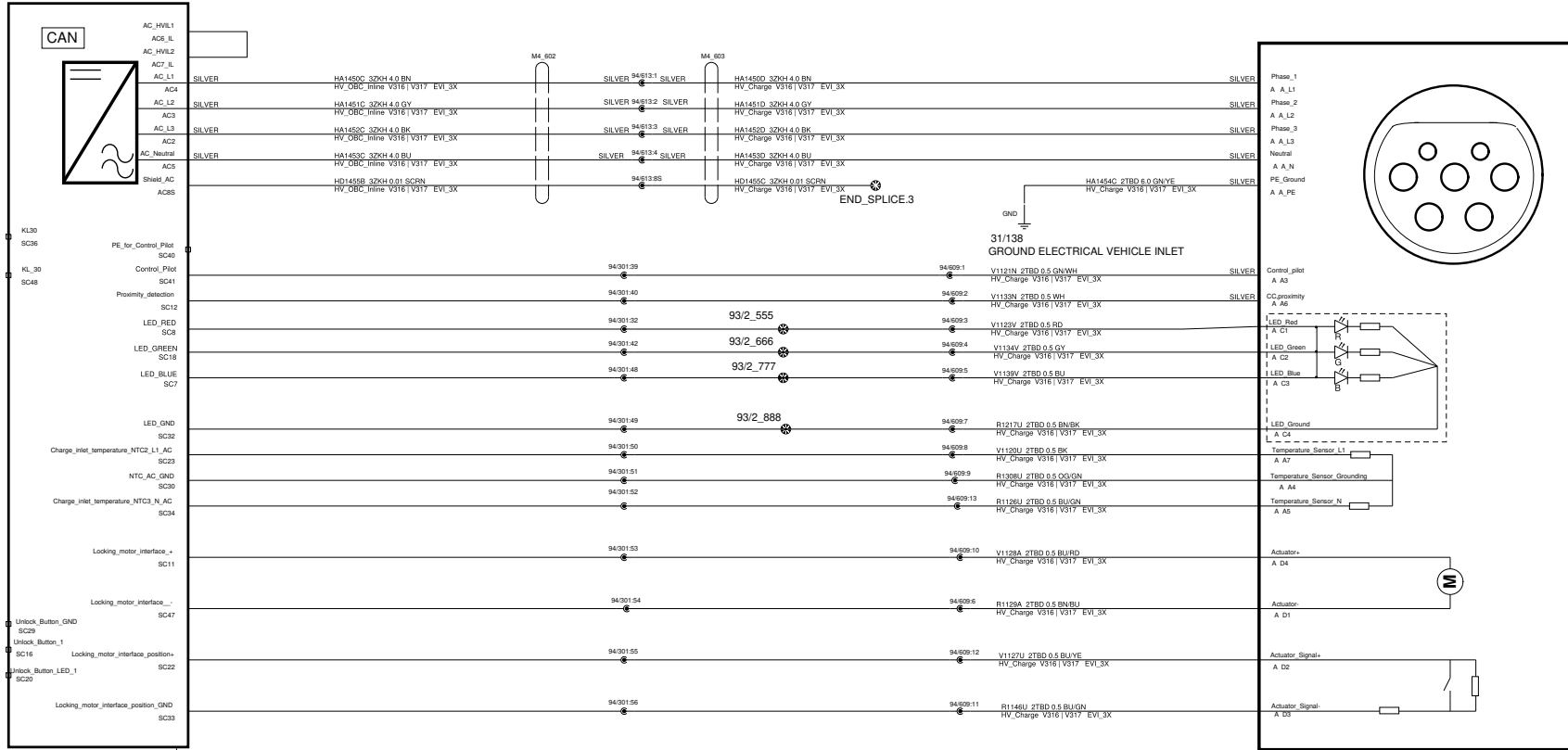

4/238
ON BOARD CHARGER OBC

17/49.3
ELECTRICAL VEHICLE INLET AC

<p>The copying, distribution and utilization of this document as well as the communication of its contents to others without expressed authorization is prohibited. Offenders will be held liable for payment of damages. All rights reserved in the event of the grant of a patent, utility model or ornamental design registration.</p> <p>VOLVO VOLVO CAR CORPORATION</p>	<p>Document title 623A_PP_CC_04_06_2023 1L7_EI_generating_public_network_V316_V317_3X_AC</p>	
	<p>Document Type DRAW/ELSY</p>	<p>Release Status RELEASED</p>
	<p>CEVT Document No 8888522365</p>	<p>Edited April/13/2023</p>
	<p>Issue 035</p>	<p>Page No 59/146</p>

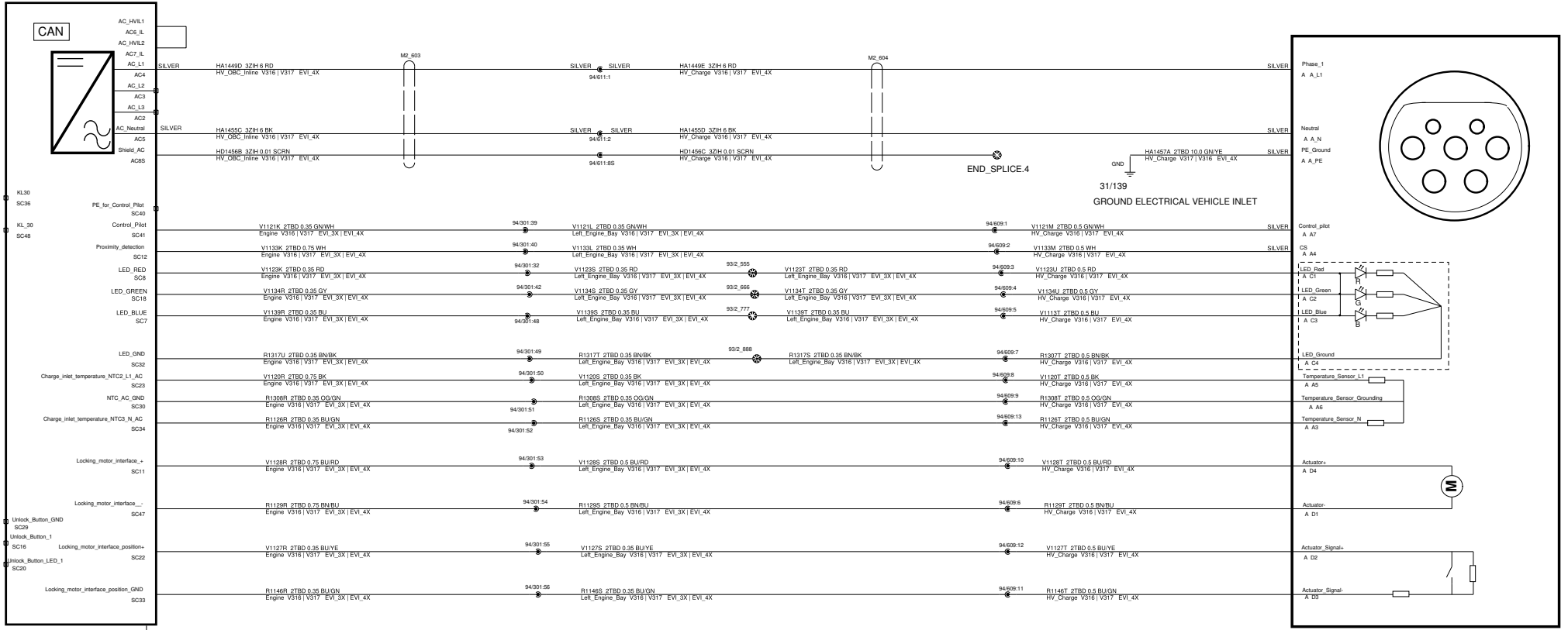

4/238
ON BOARD CHARGER OBC

17/49 ELECTRICAL VEHICLE INLET AC

<p>The copying, distribution and utilization of this document as well as the communication of its contents to others without expressed authorization is prohibited. Offenders will be held liable for payment of damages. All rights reserved in the event of the grant of a patent, utility model or ornamental design registration.</p> <p>VOLVO VOLVO CAR CORPORATION</p>	<p>Document title 623A_PP_CC_04_06_2023 1L8_El_generating_public_network_V316_V317_4X_AC</p>	
	<p>Document Type DRAW/ELSY</p>	<p>Release Status RELEASED</p>
	<p>CEVT Document No 8888522365</p>	<p>Edited April/13/2023</p>
	<p>Issue 035</p>	<p>Page No 60/146</p>

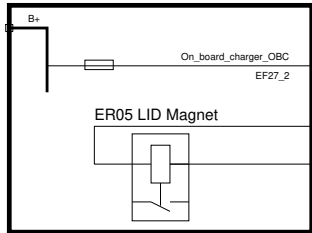

SA1202A 2TBD 0.35 RD Left_Engine_Bay PHEV common
 943151 SA1202B 2TBD 0.5 RD HV_Charge PHEV common

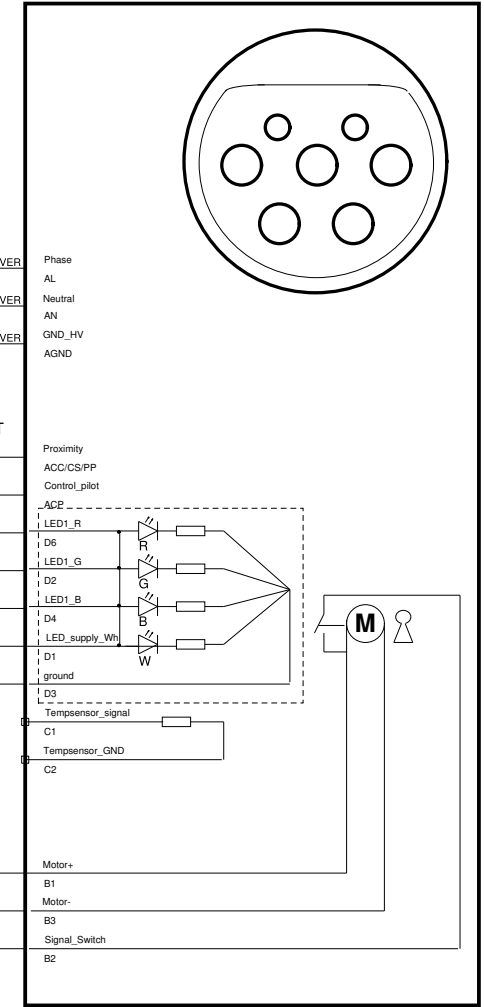
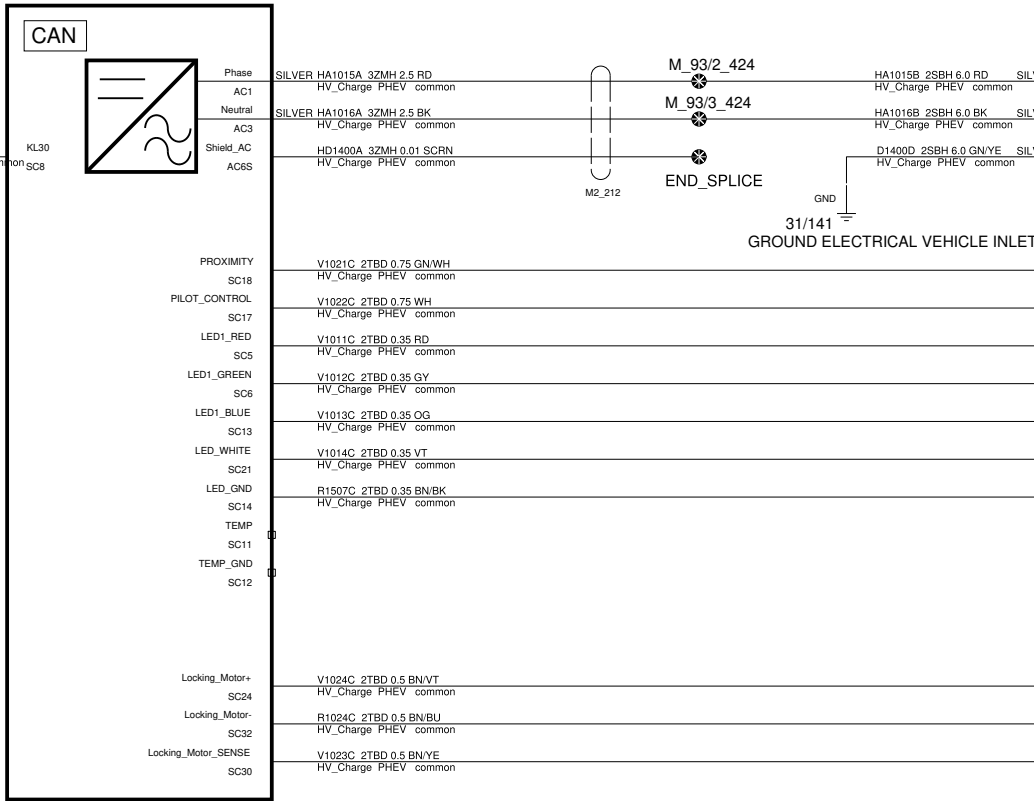
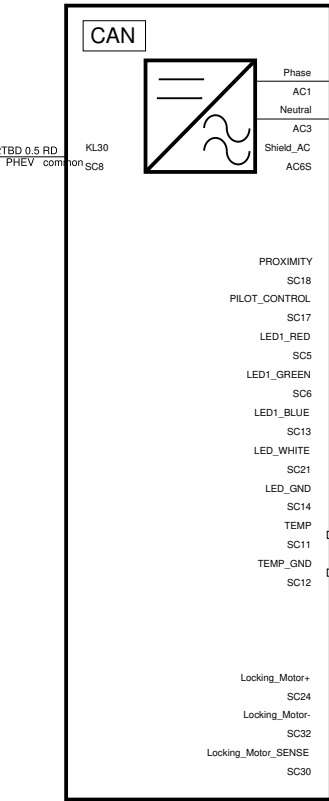

<p>The copying, distribution and utilization of this document as well as the communication of its contents to others without expressed authorization is prohibited. Offenders will be held liable for payment of damages. All rights reserved in the event of the grant of a patent, utility model or ornamental design registration.</p> <p>VOLVO VOLVO CAR CORPORATION</p>	<p>Document title 623A_PP_CC_04_06_2023 1L9_EI_generating_public_network_V316_PHEV</p>	
	<p>Document Type DRAW/ELSY</p>	<p>Release Status RELEASED</p>
	<p>CEVT Document No 8888522365</p>	<p>Edited April/13/2023</p>
	<p>Issue 035</p>	<p>Page No 61/146</p>

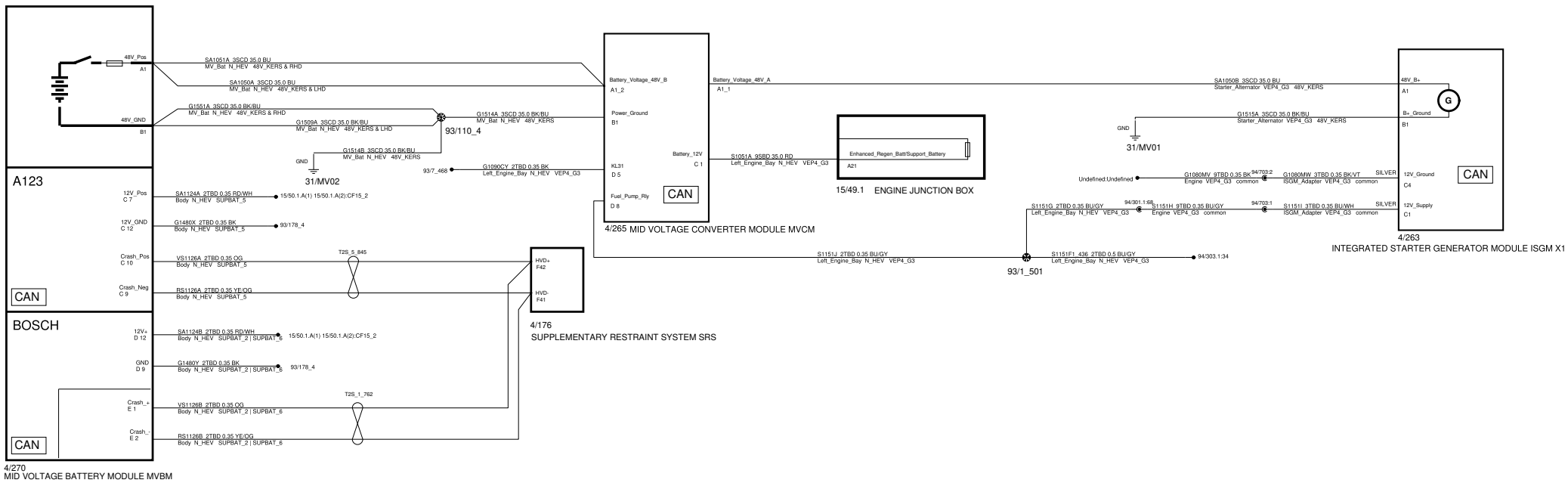

VOLVO VOLVO CAR CORPORATION	Document title 623A_PP_CC_04_06_2023 1M_EI_Distribution_Mid_Voltage	
	Document Type DRAW/ELSY	Release Status RELEASED
	CEVT Document No 8888522365	Edited April/13/2023
	Issue 035	Page No 62/146

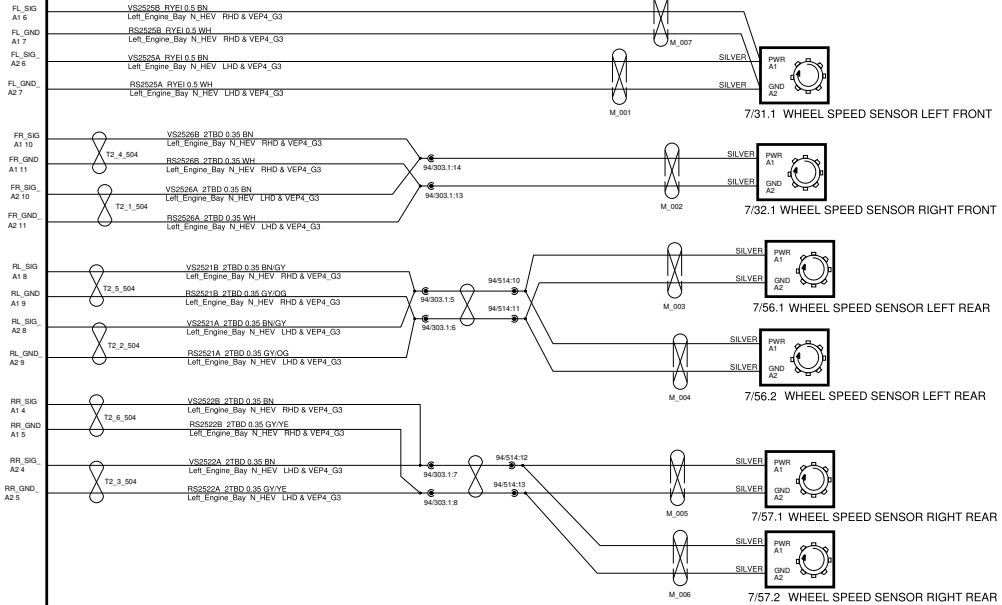
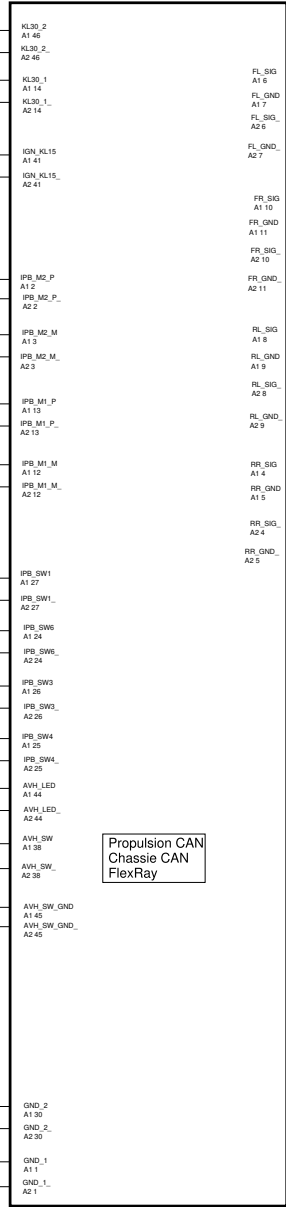
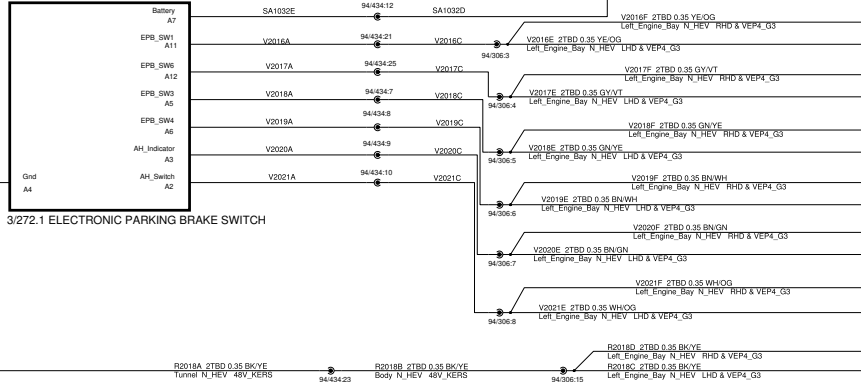
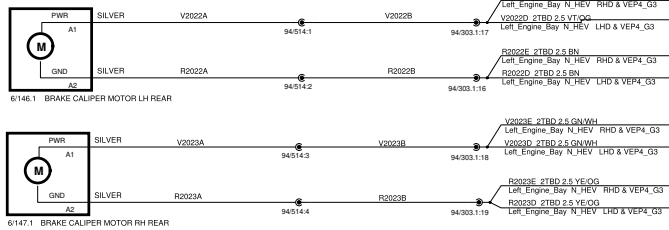
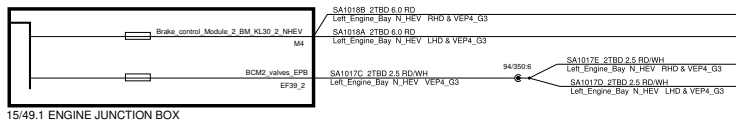

Propulsion CAN
Chassis CAN
FlexRay

<p>The copying, distribution and utilization of this document as well as the communication of its contents to others without expressed authorization is prohibited. Offenders will be held liable for payment of damages. All rights reserved in the event of the grant of a patent, utility model or ornamental design registration.</p>		<p>Document title 623A_PP_CC_04_06_2023</p>	
		<p>2A_Braking_48V_KERS</p>	
<p>Document Type DRAW/ELSY</p>		<p>Release Status RELEASED</p>	
<p>CEVT Document No 8888522365</p>		<p>Edited April/13/2023</p>	
<p>Issue 035</p>		<p>Page No 64/146</p>	

VOLVO
VOLVO CAR CORPORATION

A

B

C

D

E

F

A

B

C

D

E

F

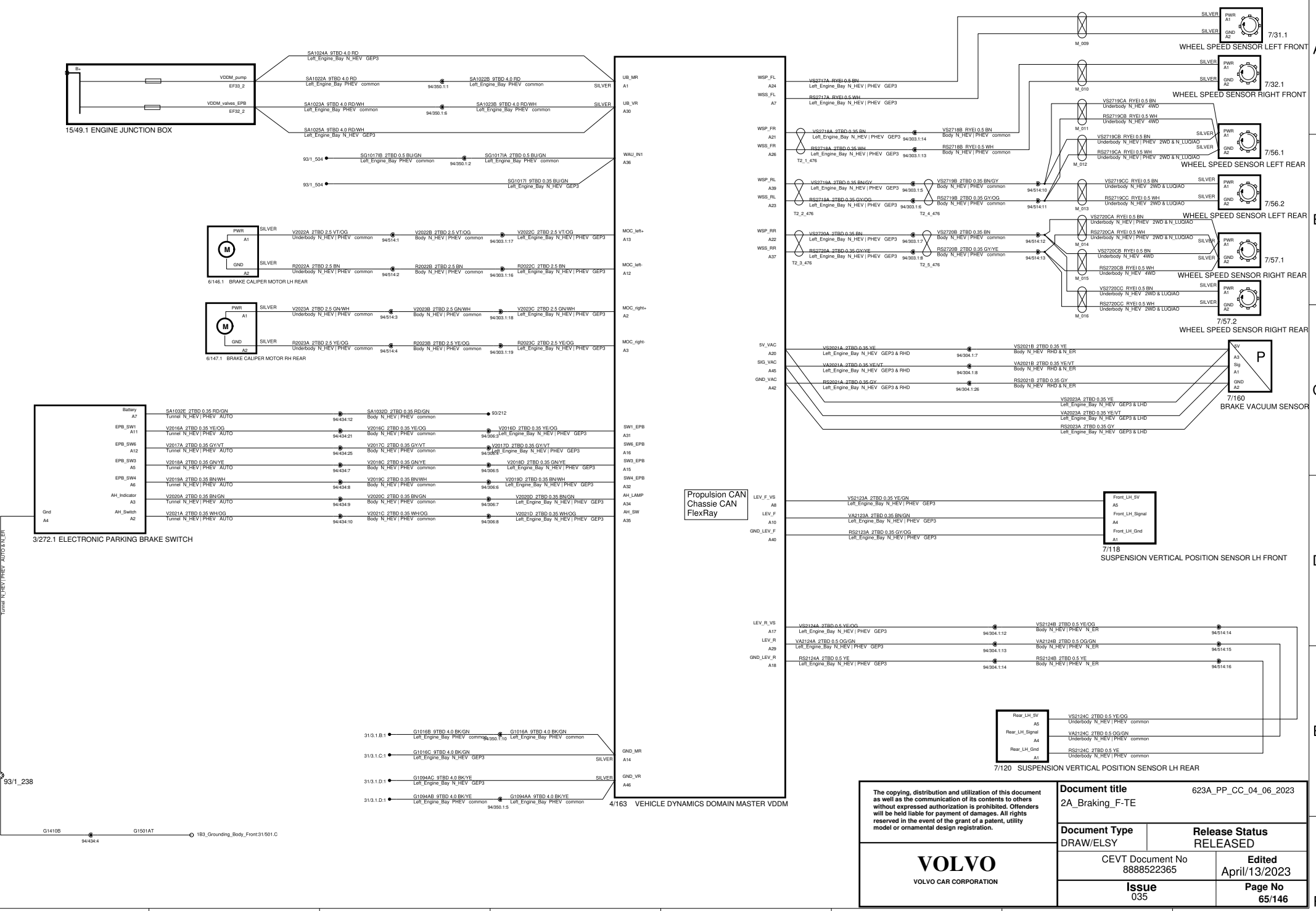

<p>The copying, distribution and utilization of this document as well as the communication of its contents to others without expressed authorization is prohibited. Offenders will be held liable for payment of damages. All rights reserved in the event of the grant of a patent, utility model or ornamental design registration.</p> <p align="center">VOLVO VOLVO CAR CORPORATION</p>		<p>Document title 2A_Braking_F-TE</p>		<p>623A_PP_CC_04_06_2023</p>
		<p>Document Type DRAW/ELSY</p>	<p>Release Status RELEASED</p>	
		<p>CEVT Document No 8888522365</p>	<p>Issue 035</p>	
		<p>Page No 65/146</p>		

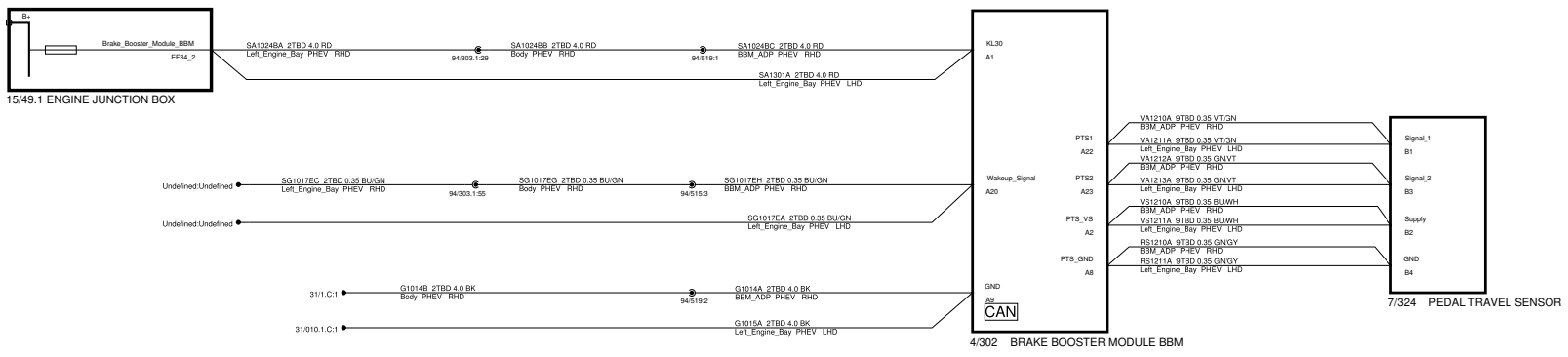

<p>The copying, distribution and utilization of this document as well as the communication of its contents to others without expressed authorization is prohibited. Offenders will be held liable for payment of damages. All rights reserved in the event of the grant of a patent, utility model or ornamental design registration.</p> <p>VOLVO VOLVO CAR CORPORATION</p>	Document title 623A_PP_CC_04_06_2023 2A_Braking_Hybrid	
	Document Type DRAW/ELSY	Release Status RELEASED
	CEVT Document No 8888522365	Edited March/29/2023
	Issue 035	Page No 66/146

2A Braking

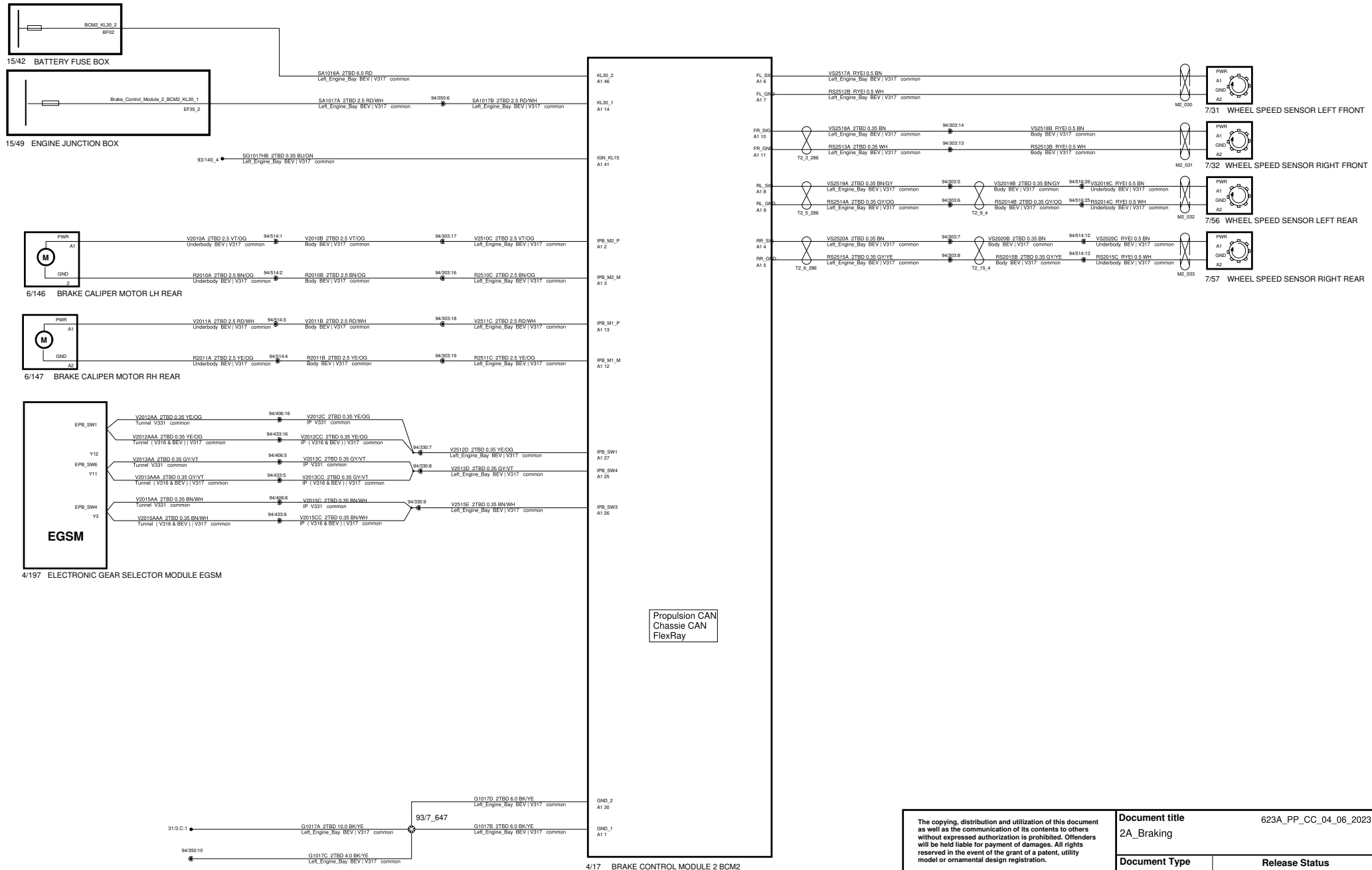

<p>The copying, distribution and utilization of this document as well as the communication of its contents to others without expressed authorization is prohibited. Offenders will be held liable for payment of damages. All rights reserved in the event of the grant of a patent, utility model or ornamental design registration.</p>		Document title 623A_PP_CC_04_06_2023	
		2A_Braking	
Document Type DRAW/ELSY		Release Status RELEASED	
Volvo Document No 33445458		Edited April/13/2023	
Issue 035		Page No 63/146	

VOLVO
VOLVO CAR CORPORATION

4/17 BRAKE CONTROL MODULE 2 BCM2

2E Power Steering

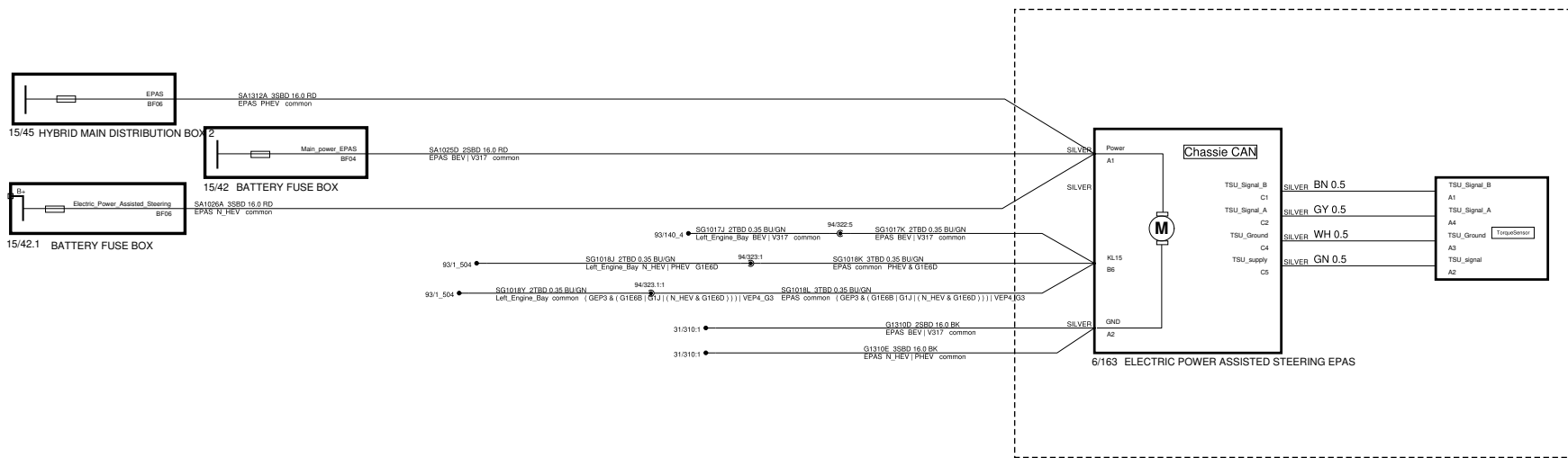

<p>The copying, distribution and utilization of this document as well as the communication of its contents to others without expressed authorization is prohibited. Offenders will be held liable for payment of damages. All rights reserved in the event of the grant of a patent, utility model or ornamental design registration.</p> <p>VOLVO VOLVO CAR CORPORATION</p>	<p>Document title 623A_PP_CC_04_06_2023 2E_Power_Steering</p>	
	<p>Document Type DRAW/ELSY</p>	<p>Release Status RELEASED</p>
	<p>Volvo Document No 33445458</p>	<p>Edited April/13/2023</p>
	<p>Issue 035</p>	<p>Page No 68/146</p>

2E2 Steering

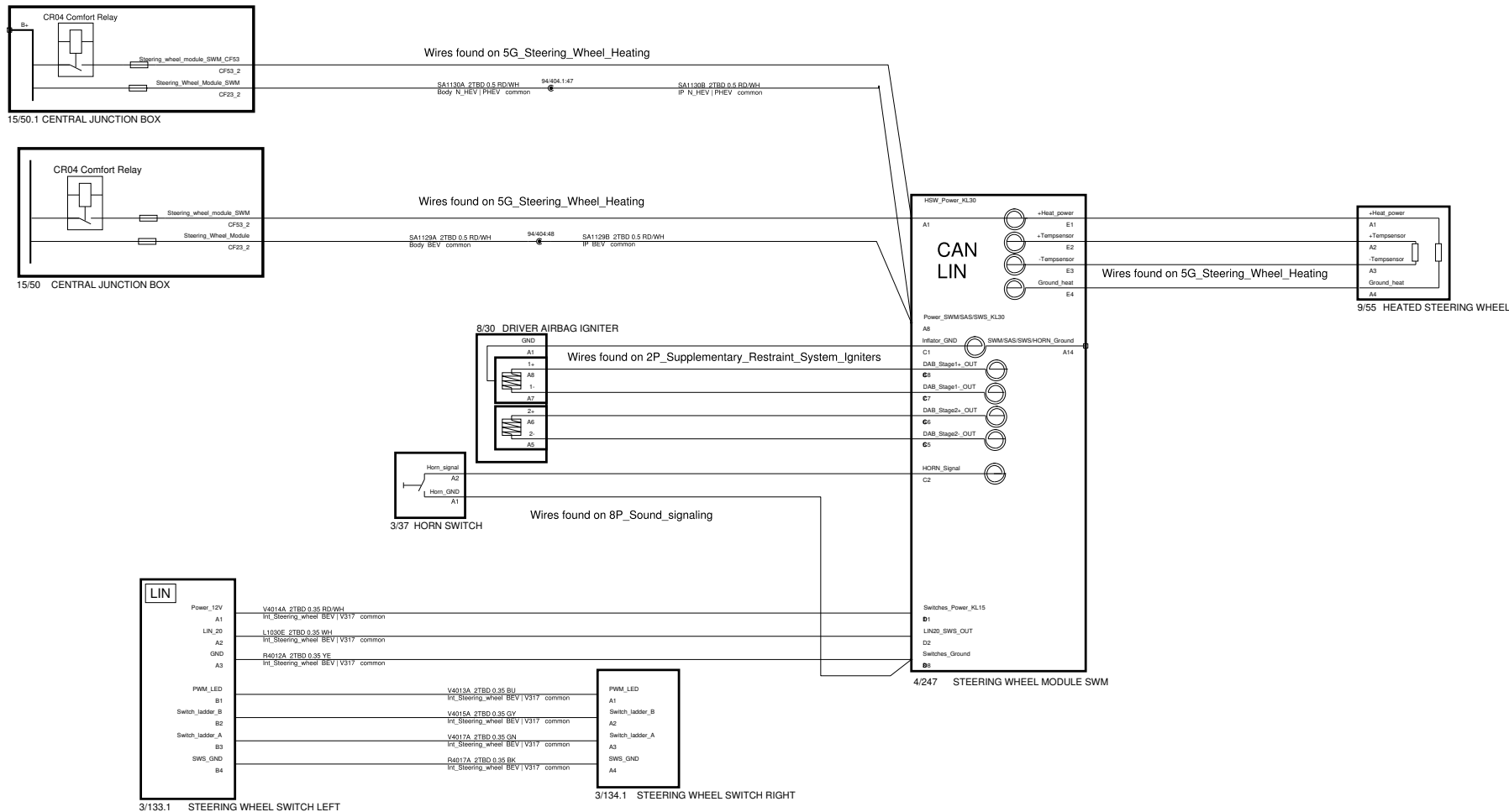

<p>The copying, distribution and utilization of this document as well as the communication of its contents to others without expressed authorization is prohibited. Offenders will be held liable for payment of damages. All rights reserved in the event of the grant of a patent, utility model or ornamental design registration.</p> <p>VOLVO VOLVO CAR CORPORATION</p>	Document title 2E2_Steering		623A_PP_CC_04_06_2023
	Document Type DRAW/ELSY	Release Status RELEASED	
	Volvo Document No 33445458		Edited June/16/2021
	Issue 035	Page No 67/146	

2G Levelling Control

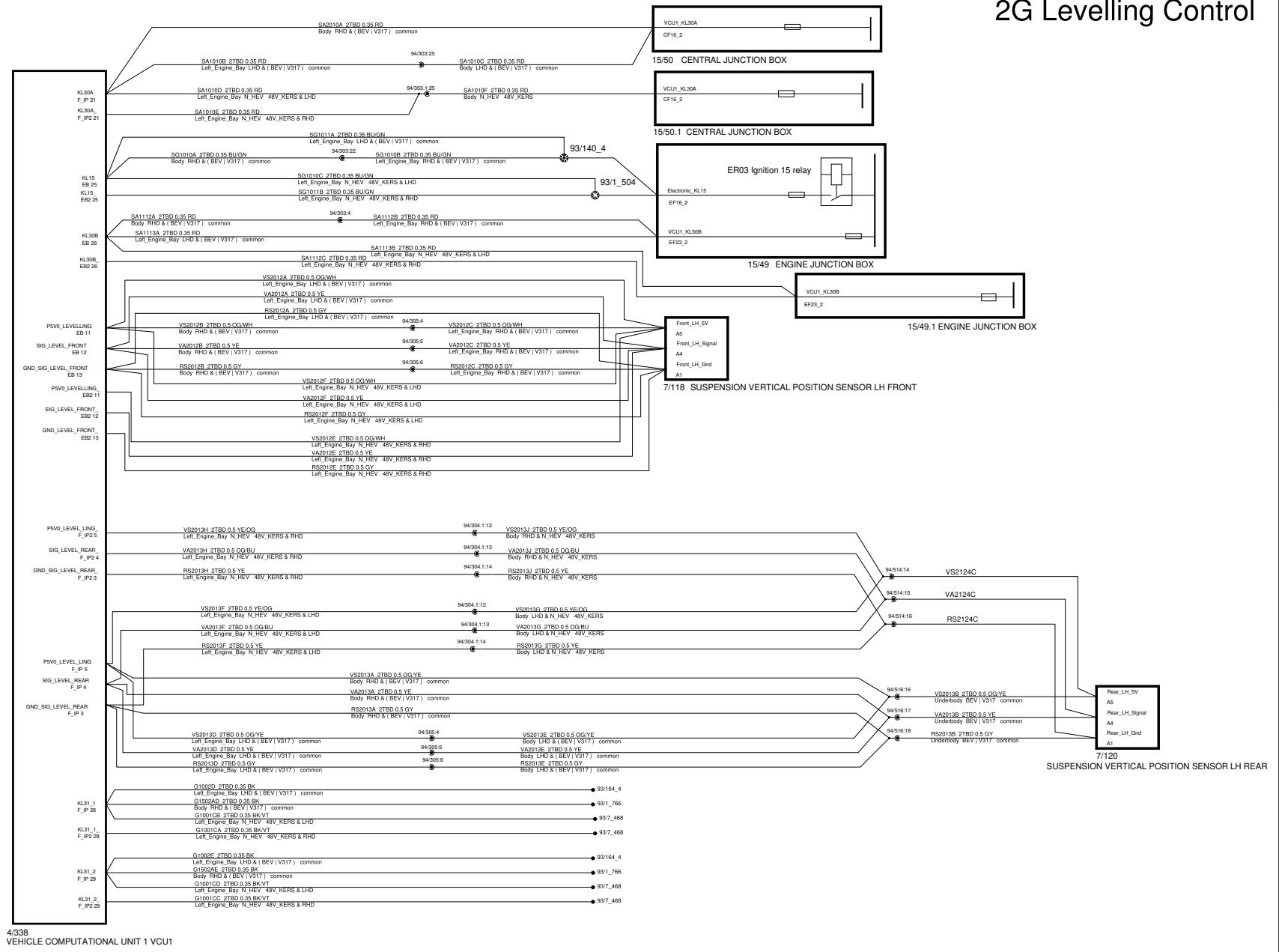

4/338 VEHICLE COMPUTATIONAL UNIT 1 VCU1

<p>The copying, distribution and utilization of this document as well as the communication of its contents to others without expressed authorization is prohibited. Offenders will be held liable for payment of damages. All rights reserved in the event of the grant of a patent, utility model or ornamental design registration.</p> <p>VOLVO VOLVO CAR CORPORATION</p>	<p>Document title: 623A_PP_CC_04_06_2023 2G_Levelling_control</p>	
	<p>Document Type: DRAW/ELSY</p>	<p>Release Status: RELEASED</p>
	<p>Volvo Document No: 33445458</p>	<p>Edited: April/13/2023</p>
	<p>Issue: 035</p>	<p>Page No: 69/146</p>

2M Pedestrian Protection

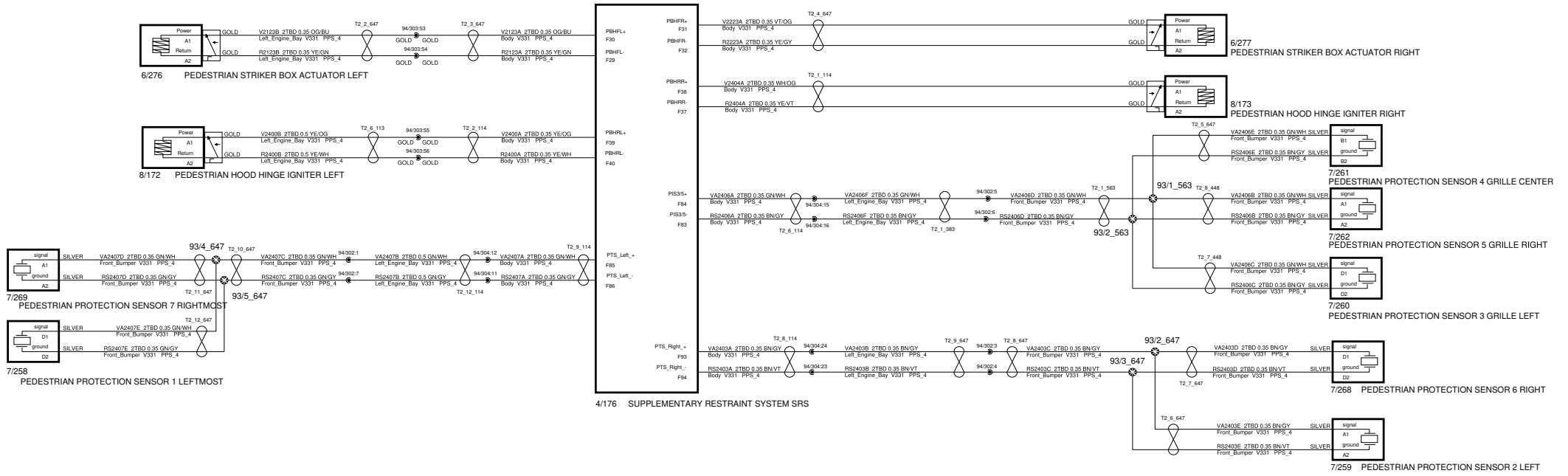

<p>The copying, distribution and utilization of this document as well as the communication of its contents to others without expressed authorization is prohibited. Offenders will be held liable for payment of damages. All rights reserved in the event of the grant of a patent, utility model or ornamental design registration.</p> <p>VOLVO VOLVO CAR CORPORATION</p>	Document title 623A_PP_CC_04_06_2023	
	2M_Pedestrian_Protection	
	Document Type DRAW/ELSY	Release Status RELEASED
	Volvo Document No 33445458	Edited March/21/2023
Issue 035	Page No 70/146	

2N Safety Belt Reminder

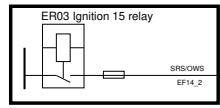

15/49 ENGINE JUNCTION BOX

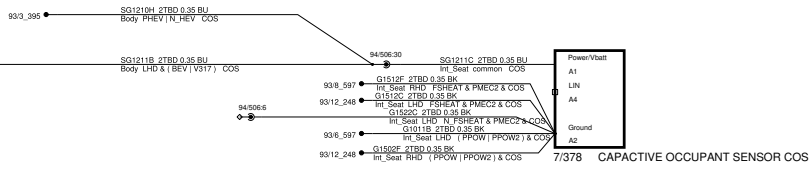

7/378 CAPACITIVE OCCUPANT SENSOR COS

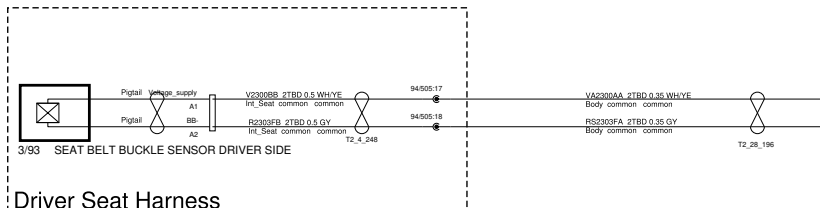

Driver Seat Harness

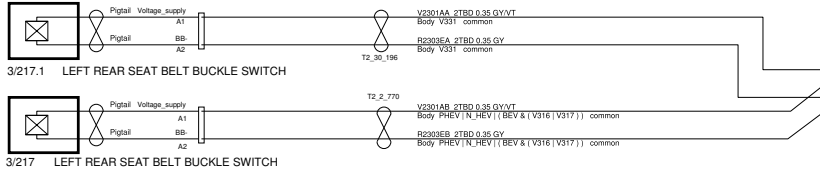

Rear Seat Harness

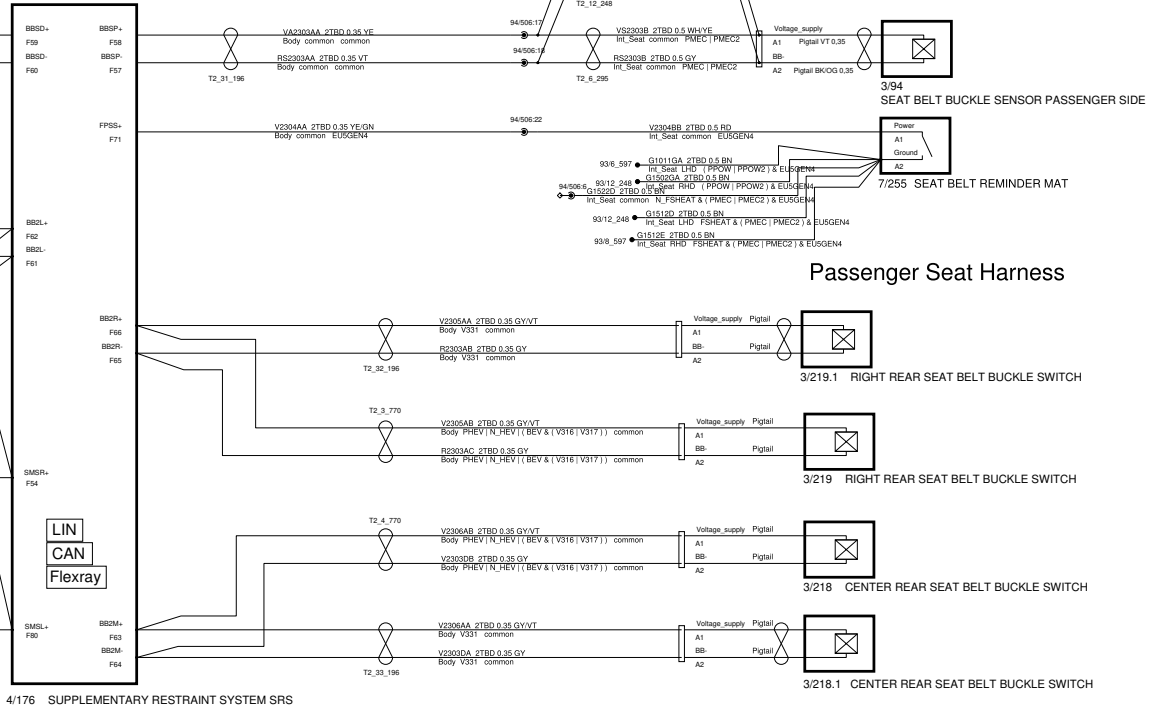

4/176 SUPPLEMENTARY RESTRAINT SYSTEM SRS

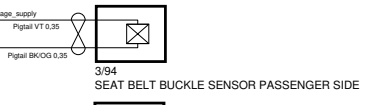

3/94 SEAT BELT BUCKLE SENSOR PASSENGER SIDE

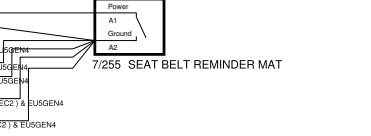

7/255 SEAT BELT REMINDER MAT

Passenger Seat Harness

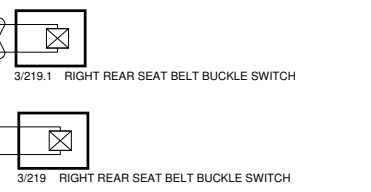

3/219 RIGHT REAR SEAT BELT BUCKLE SWITCH

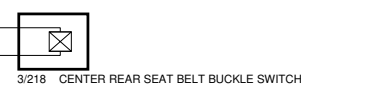

3/218 CENTER REAR SEAT BELT BUCKLE SWITCH

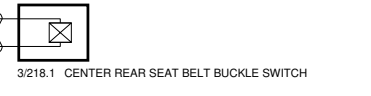

3/218.1 CENTER REAR SEAT BELT BUCKLE SWITCH

<p>The copying, distribution and utilization of this document as well as the communication of its contents to others without expressed authorization is prohibited. Offenders will be held liable for payment of damages. All rights reserved in the event of the grant of a patent, utility model or ornamental design registration.</p>		<p>Document title 2N_Safety_Belt_Reminder</p>		<p>623A_PP_CC_04_06_2023</p>
		<p>Document Type DRAW/ELSY</p>	<p>Release Status RELEASED</p>	
<p>VOLVO VOLVO CAR CORPORATION</p>		<p>Volvo Document No 33445458</p>	<p>Edited April/13/2023</p>	
		<p>Issue 035</p>	<p>Page No 71/146</p>	

20 Collision Avoidance

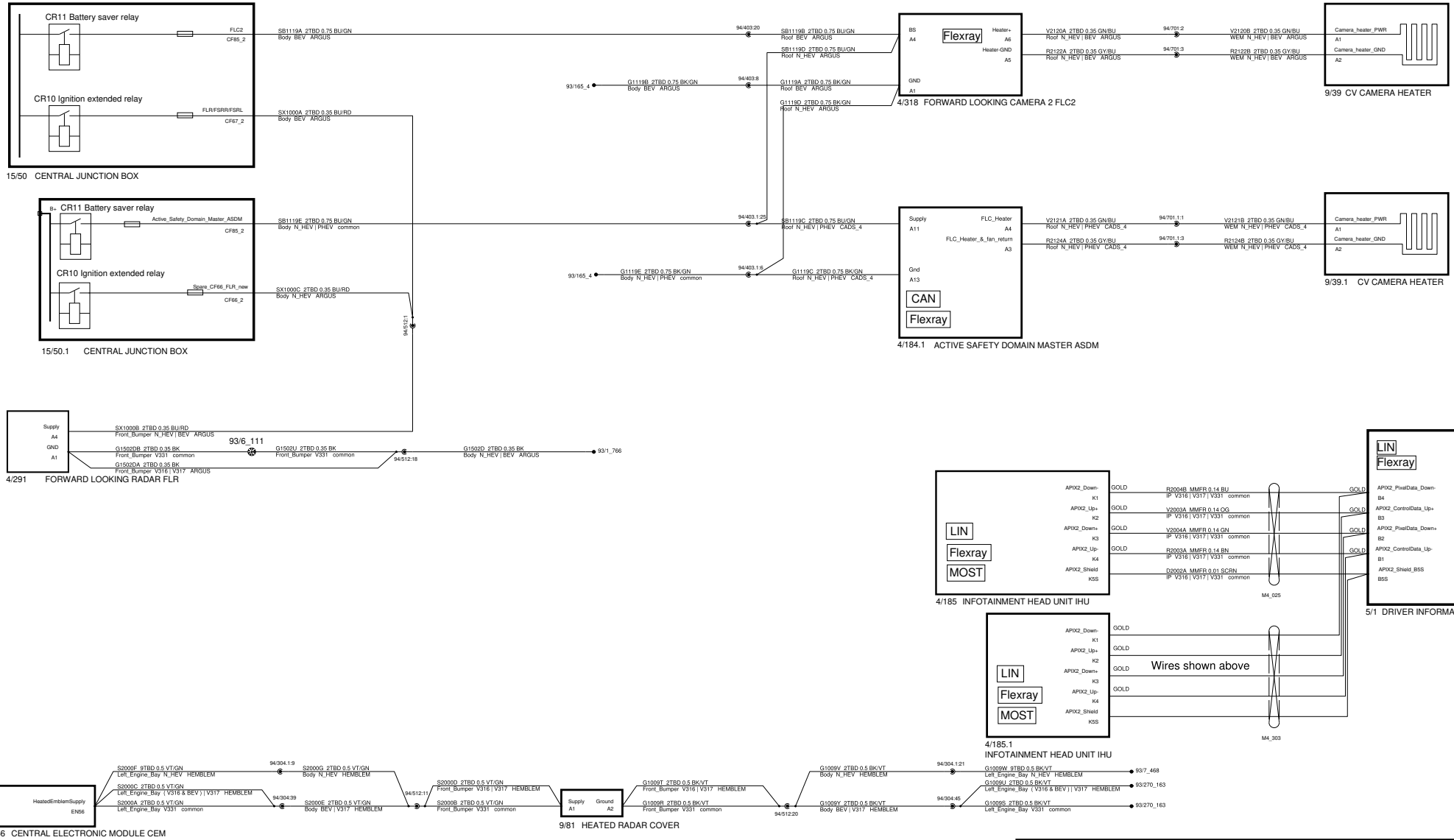

<p>The copying, distribution and utilization of this document as well as the communication of its contents to others without expressed authorization is prohibited. Offenders will be held liable for payment of damages. All rights reserved in the event of the grant of a patent, utility model or ornamental design registration.</p> <p>VOLVO VOLVO CAR CORPORATION</p>		<p>Document title: 623A_PP_CC_04_06_2023 20_Collision_Avoidance</p>	
		<p>Document Type: DRAW/ELSY</p>	<p>Release Status: RELEASED</p>
<p>Volvo Document No: 33445458</p>		<p>Edited: April/13/2023</p>	
<p>Issue: 035</p>		<p>Page No: 72/146</p>	

2P Supplementary Restraint System Igniters N_HEV

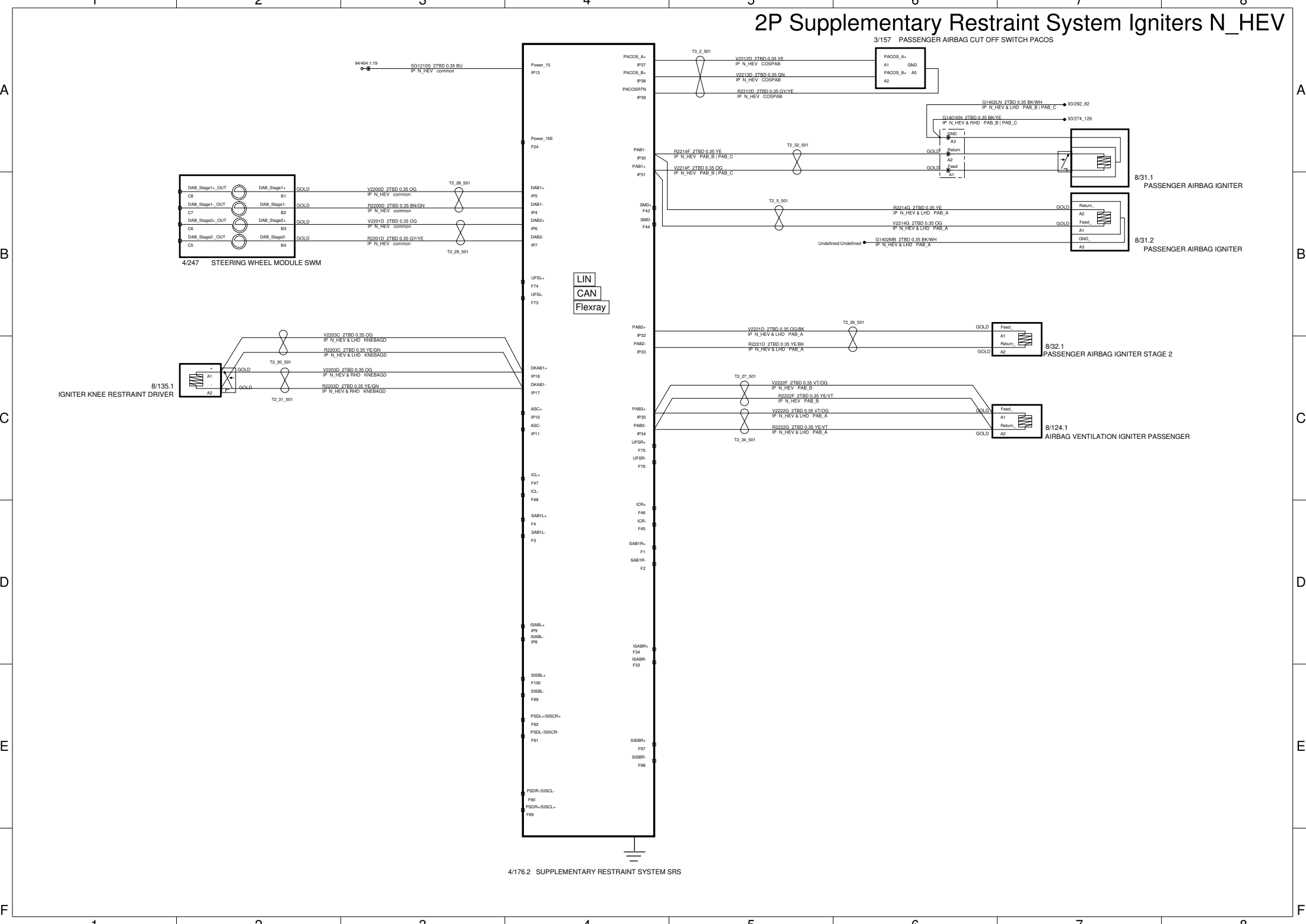

2P Supplementary Restraint System Igniters PHEV

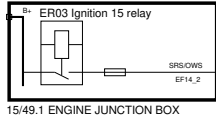

15/49.1 ENGINE JUNCTION BOX

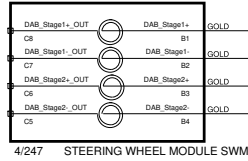

4/176.1 SUPPLEMENTARY RESTRAINT SYSTEM SRS

LIN
CAN
Flexray

3/157 PASSENGER AIRBAG CUT OFF SWITCH PACOS

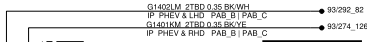

8/31.1 PASSENGER AIRBAG IGNITER

8/31.2 PASSENGER AIRBAG IGNITER

8/32.1 PASSENGER AIRBAG IGNITER STAGE 2

8/124.1 AIRBAG VENTILATION IGNITER PASSENGER

A
B
C
D
E
F

A
B
C
D
E
F

1 2 3 4 5 6 7 8

2P Supplementary Restraint System Igniters

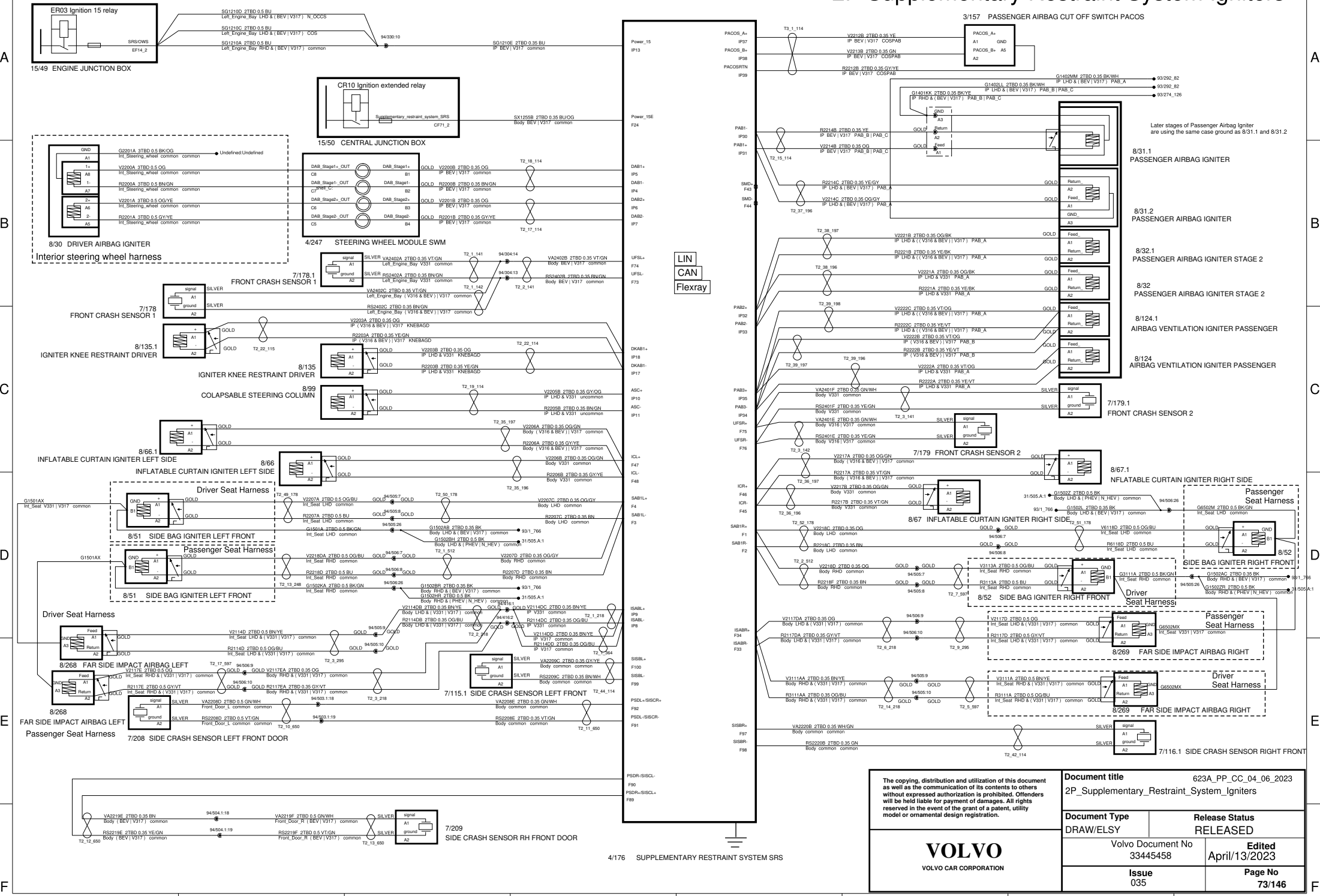

<p>The copying, distribution and utilization of this document as well as the communication of its contents to others without expressed authorization is prohibited. Offenders will be held liable for payment of damages. All rights reserved in the event of the grant of a patent, utility model or ornamental design registration.</p>		<p>Document title 2P_Supplementary_Restraint_System_Igniters</p>		<p>623A_PP_OC_04_06_2023</p>	
<p>Document Type DRAW/ELSY</p>		<p>Release Status RELEASED</p>		<p>Edited April/13/2023</p>	
<p>Volvo Document No 33445458</p>		<p>Issue 035</p>		<p>Page No 73/146</p>	

2R Safety Belt

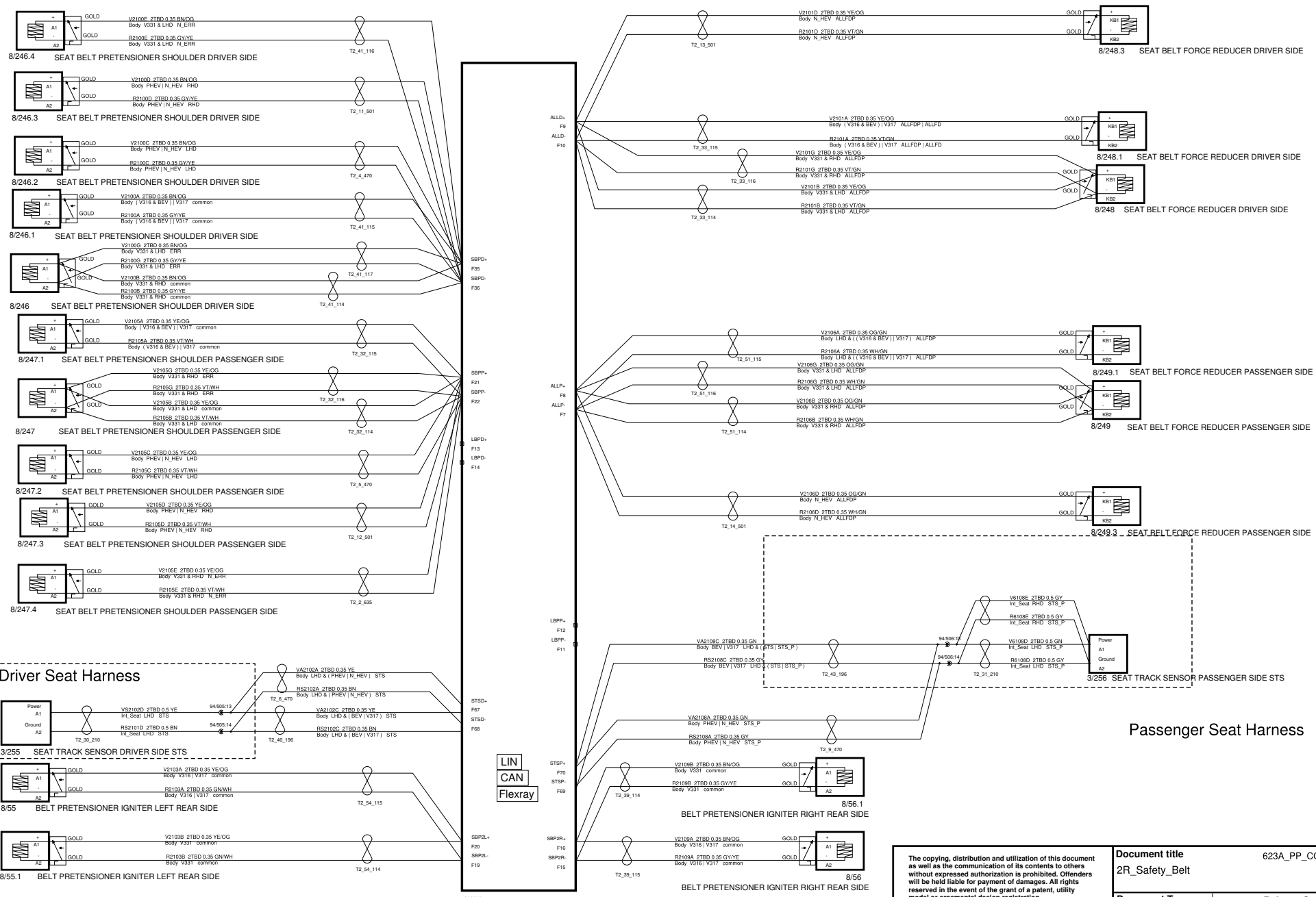

4/176 SUPPLEMENTARY RESTRAINT SYSTEM SRS

The copying, distribution and utilization of this document as well as the communication of its contents to others without expressed authorization is prohibited. Offenders will be held liable for payment of damages. All rights reserved in the event of the grant of a patent, utility model or ornamental design registration.		Document title 2R_Safety_Belt	623A_PP_CC_04_06_2023
Document Type DRAW/ELSY	Release Status RELEASED		
Volvo Document No 33445458	Issue 035	Edited April/13/2023	Page No 77/146

VOLVO
VOLVO CAR CORPORATION

2S Restraint

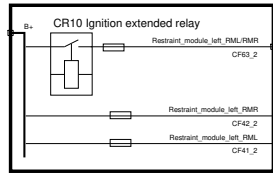

15/50.1 CENTRAL JUNCTION BOX

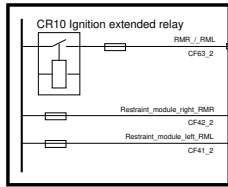

15/50 CENTRAL JUNCTION BOX

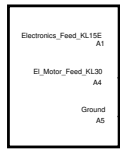

4/211 RESTRAINT MODULE LEFT RML

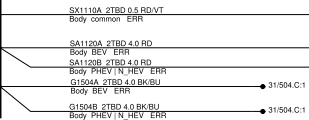

93/1_722

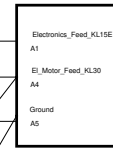
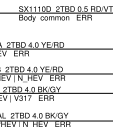

4/212 RESTRAINT MODULE RIGHT RMR

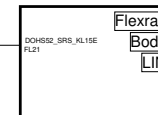

4/56 CENTRAL ELECTRONIC MODULE CEM

<p>The copying, distribution and utilization of this document as well as the communication of its contents to others without expressed authorization is prohibited. Offenders will be held liable for payment of damages. All rights reserved in the event of the grant of a patent, utility model or ornamental design registration.</p> <p>VOLVO VOLVO CAR CORPORATION</p>	<p>Document title 623A_PP_CC_04_06_2023 2S_Restraint</p>	
	<p>Document Type DRAW/ELSY</p>	<p>Release Status RELEASED</p>
	<p>Volvo Document No 33445458</p>	<p>Edited March/21/2023</p>
	<p>Issue 035</p>	<p>Page No 78/146</p>

3A, 3D Engine Management VEP4 GEN3 (HEV)

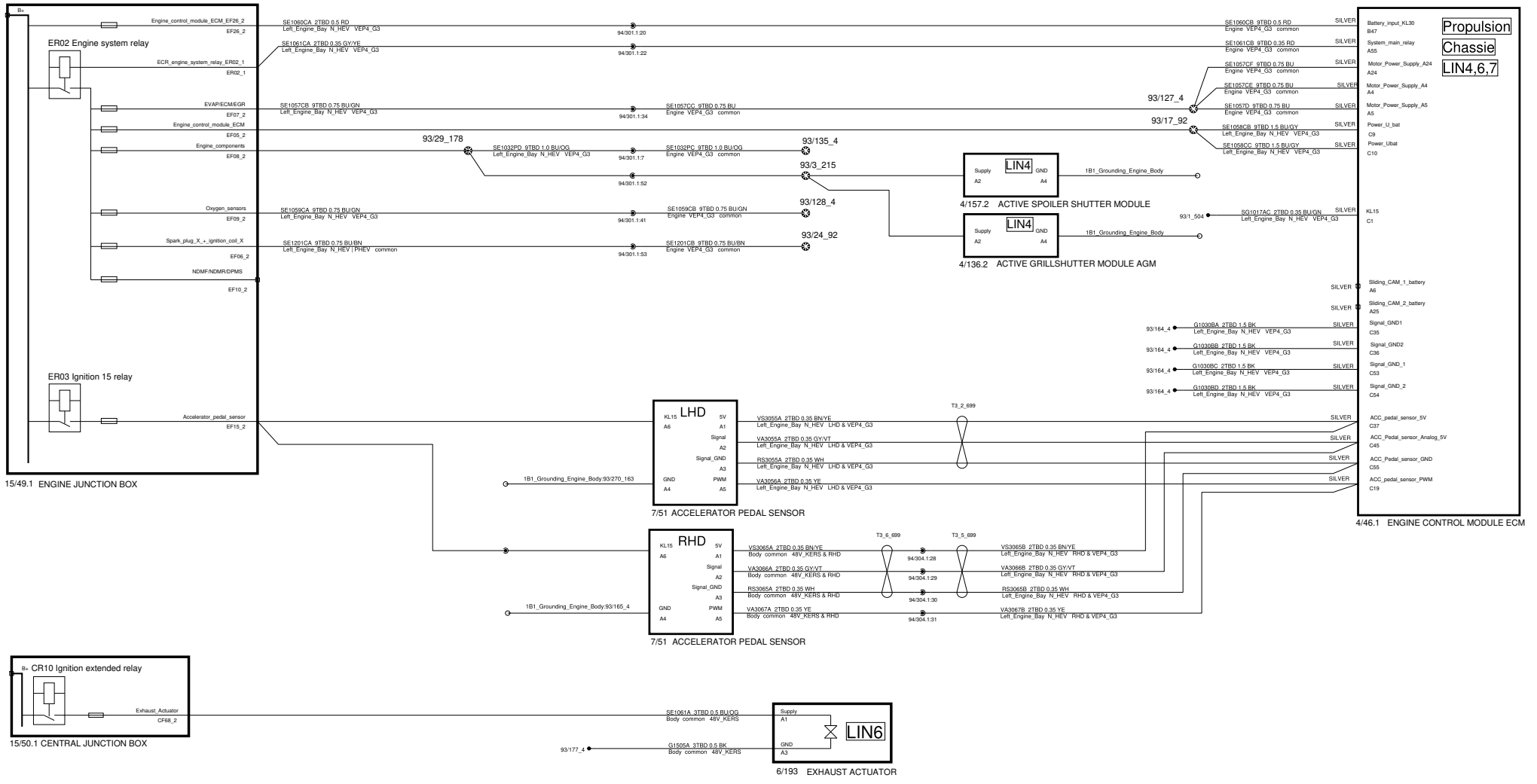

<p>The copying, distribution and utilization of this document as well as the communication of its contents to others without expressed authorization is prohibited. Offenders will be held liable for payment of damages. All rights reserved in the event of the grant of a patent, utility model or ornamental design registration.</p>		<p>Document title 623A_PP_CC_04_06_2023 3A_3D_Engine_Management_VEP4_GEN3_(HEV)</p>	
		<p>Document Type DRAW/ELSY</p>	<p>Release Status RELEASED</p>
<p>VOLVO VOLVO CAR CORPORATION</p>		<p>CEVT Document No 8888522365</p>	<p>Edited April/13/2023</p>
		<p>Issue 035</p>	<p>Page No 81/146</p>

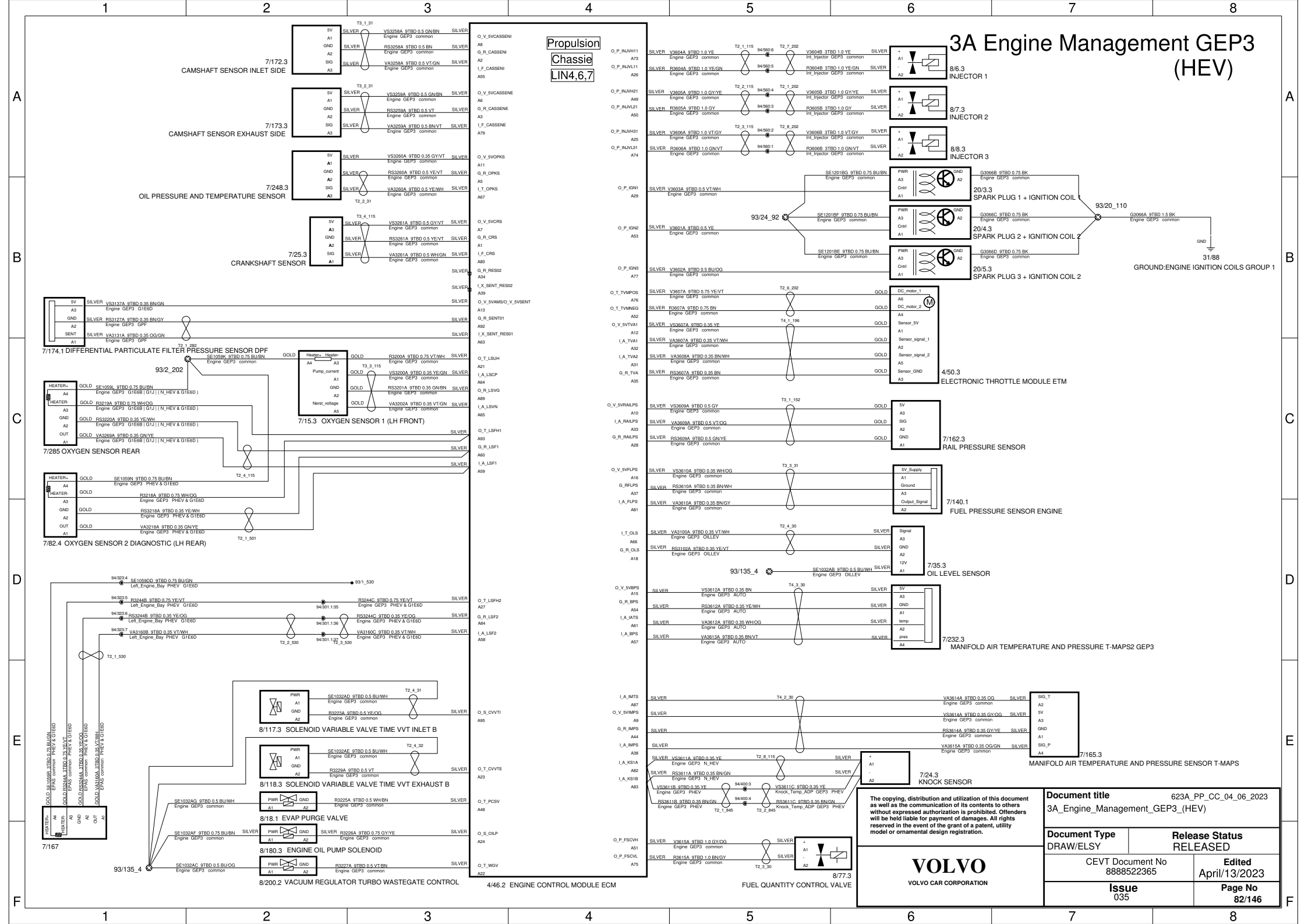

3A Engine Management GEP3 (HEV)

Propulsion
Chassis
LIN4,6,7

Document title		623A_PP_CC_04_06_2023	
3A_Engine_Management_GEP3_(HEV)		Release Status	
DRAW/ELSY		RELEASED	
CEVT Document No	8888522365	Edited	April/13/2023
Issue	035	Page No	82/146

The copying, distribution and utilization of this document as well as the communication of its contents to others without expressed authorization is prohibited. Offenders will be held liable for payment of damages. All rights reserved in the event of the grant of a patent, utility model or ornamental design registration.

VOLVO
VOLVO CAR CORPORATION

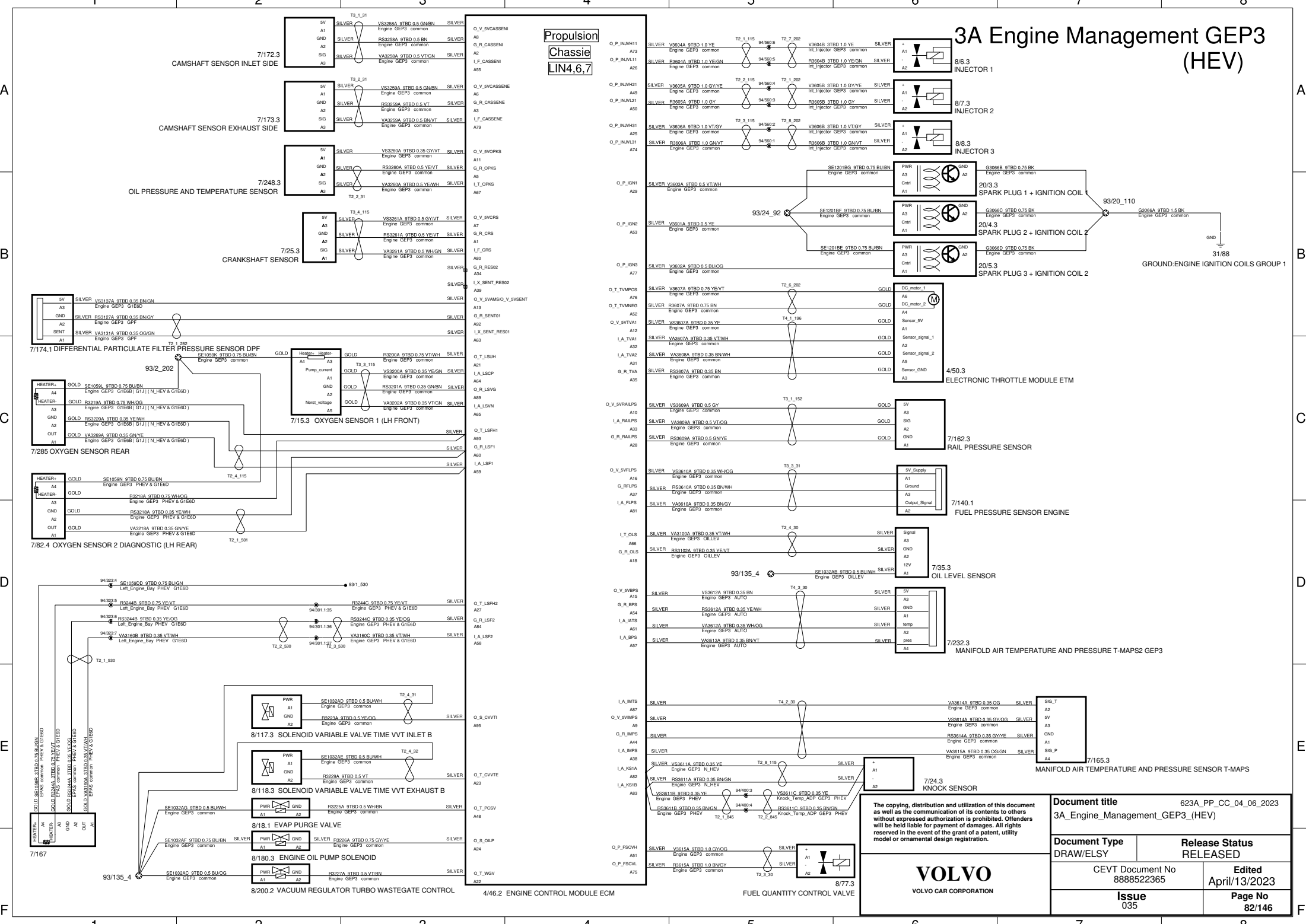

3A Engine Management VEP4_G3 (HEV)

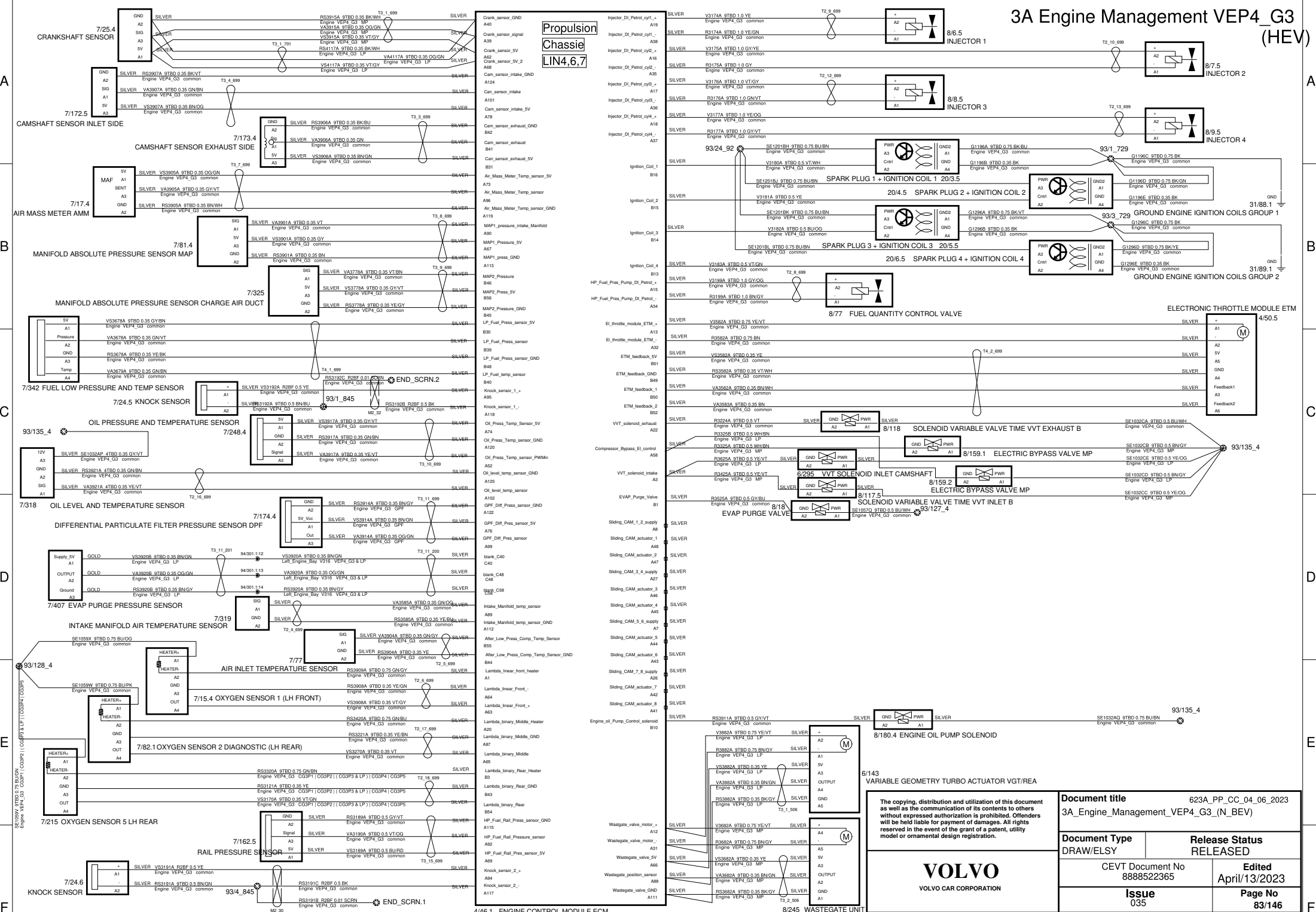

The copying, distribution and utilization of this document as well as the communication of its contents to others without expressed authorization is prohibited. Offenders will be held liable for payment of damages. All rights reserved in the event of the grant of a patent, utility model or ornamental design registration.

Document title		623A_PP_CC_04_06_2023	
3A_Engine_Management_VEP4_G3_(N_BEV)		RELEASED	
Document Type	CEVT Document No	8888522365	Edited
DRAW/ELSY	Issue	035	Page No
			83/146



VOLVO CAR CORPORATION

3B Management BEV Driveline

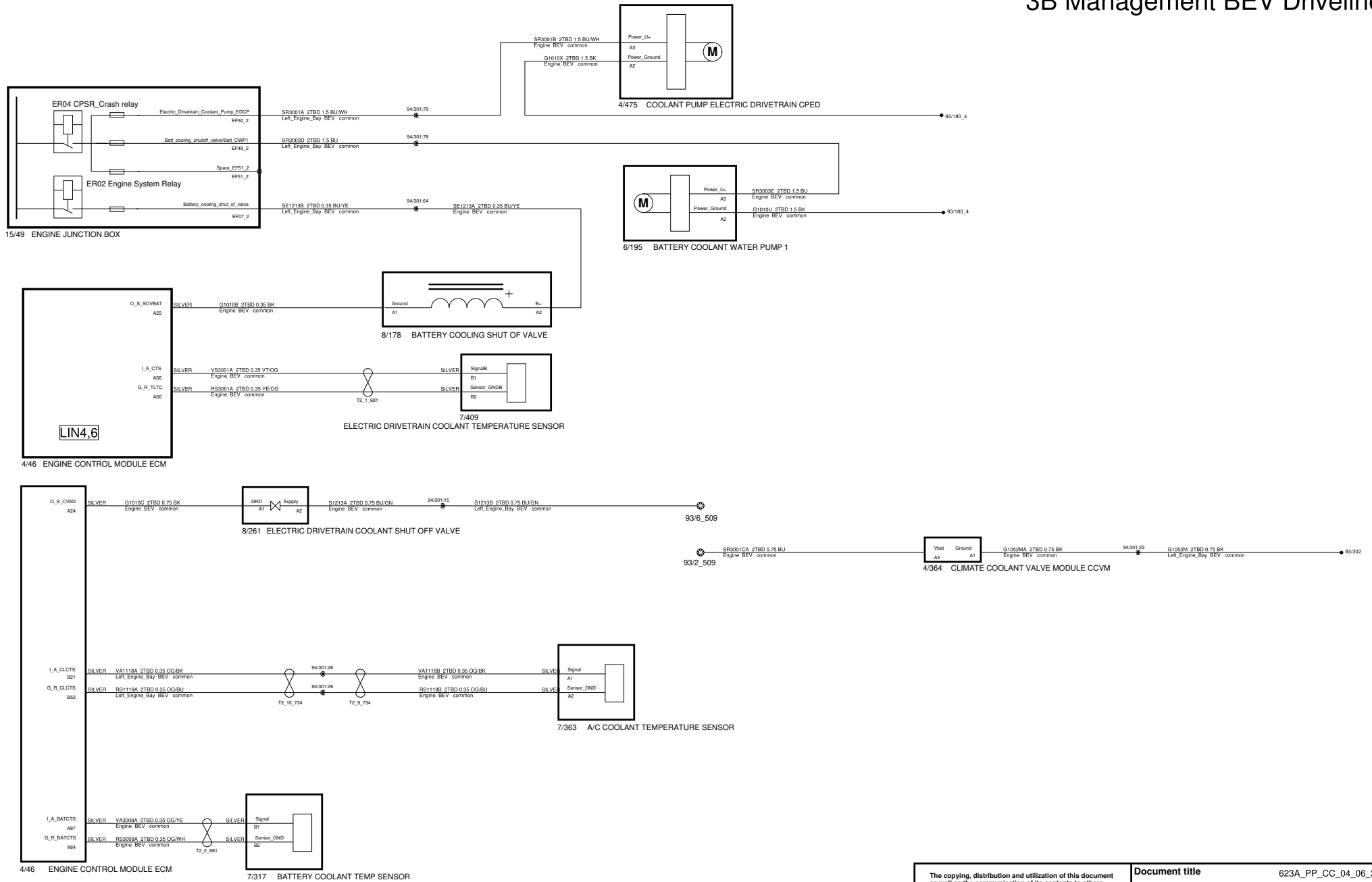

<p>The copying, distribution and utilization of this document as well as the communication of its contents to others without expressed authorization is prohibited. Offenders will be held liable for payment of damages. All rights reserved in the event of the grant of a patent, utility model or ornamental design registration.</p> <p>VOLVO VOLVO CAR CORPORATION</p>		<p>Document title 623A_PP_CC_04_06_2023 3B_Management_BEV_Driveline</p>	
		<p>Document Type DRAW/ELSY</p>	<p>Release Status RELEASED</p>
		<p>Volvo Document No 33445458</p>	<p>Edited April/13/2023</p>
		<p>Issue 035</p>	<p>Page No 84/146</p>

3B Management Hybrid Driveline (PHEV)

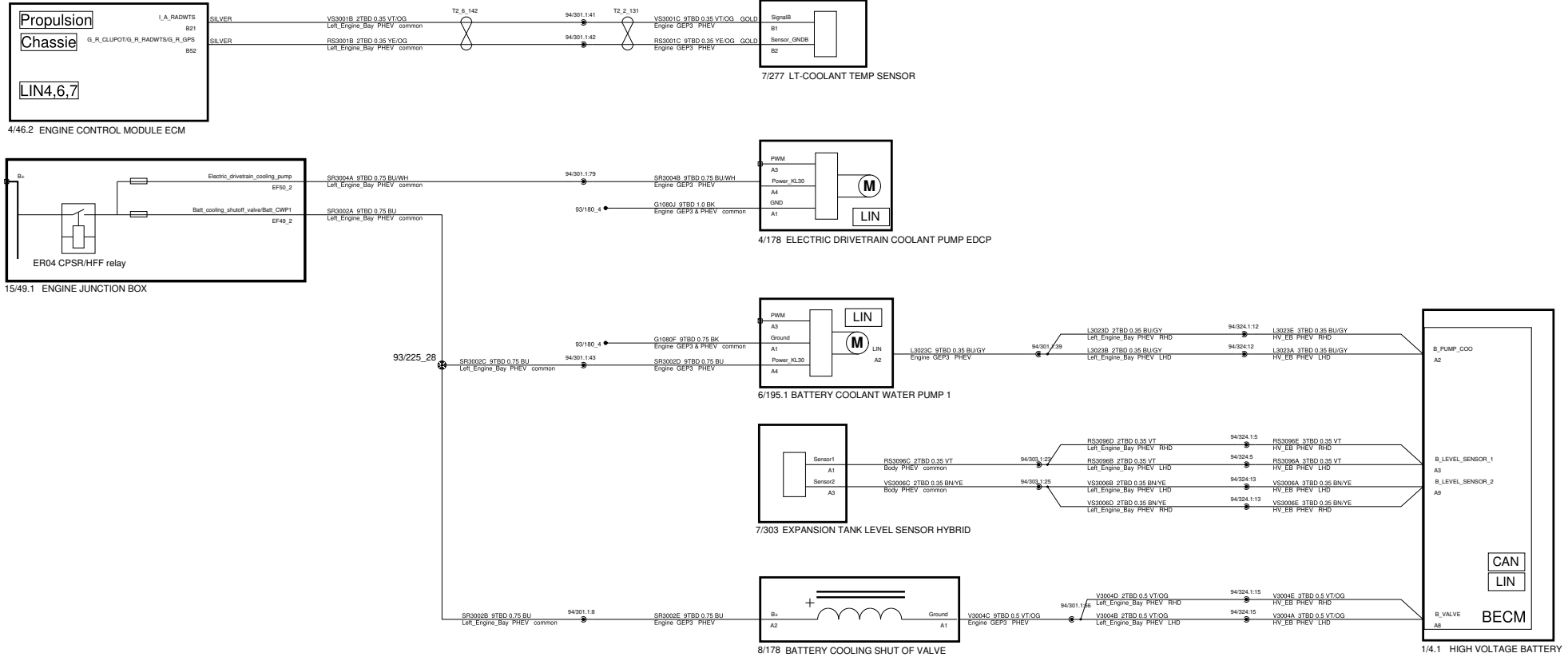

VOLVO VOLVO CAR CORPORATION	Document title 623A_PP_CC_04_06_2023 3B_Management_Hybrid_Driveline_HEV	
	Document Type DRAW/ELSY	Release Status RELEASED
	CEVT Document No 8888522365	Edited April/13/2023
	Issue 035	Page No 85/146

3D Engine Thermal Management

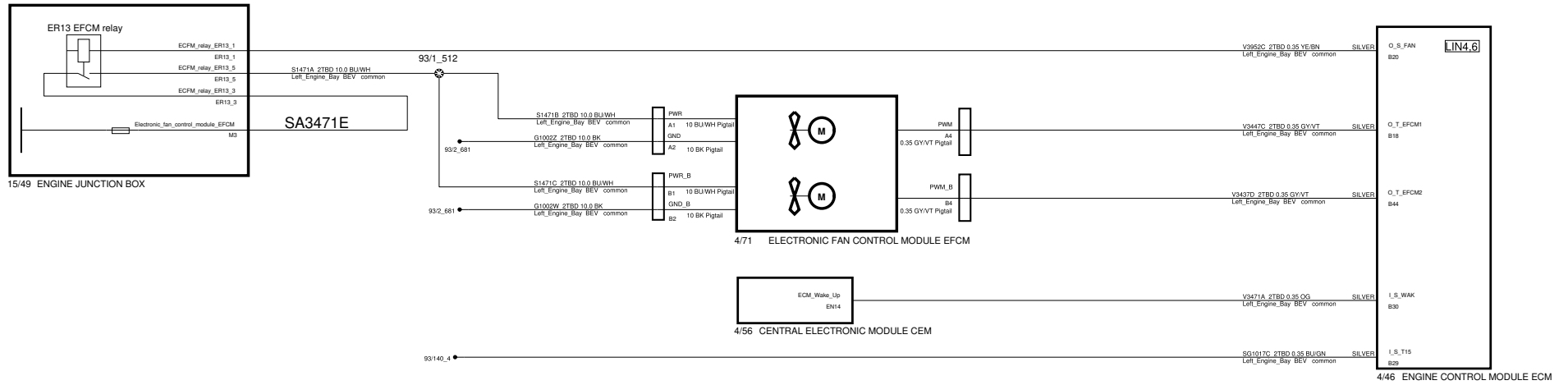

<p>The copying, distribution and utilization of this document as well as the communication of its contents to others without expressed authorization is prohibited. Offenders will be held liable for payment of damages. All rights reserved in the event of the grant of a patent, utility model or ornamental design registration.</p> <p>VOLVO VOLVO CAR CORPORATION</p>	<p>Document title 623A_PP_CC_04_06_2023 3D_Engine_thermal_management_BEV</p>	
	<p>Document Type DRAW/ELSY</p>	<p>Release Status RELEASED</p>
	<p>Volvo Document No 33445458</p>	<p>Edited April/13/2023</p>
	<p>Issue 035</p>	<p>Page No 86/146</p>

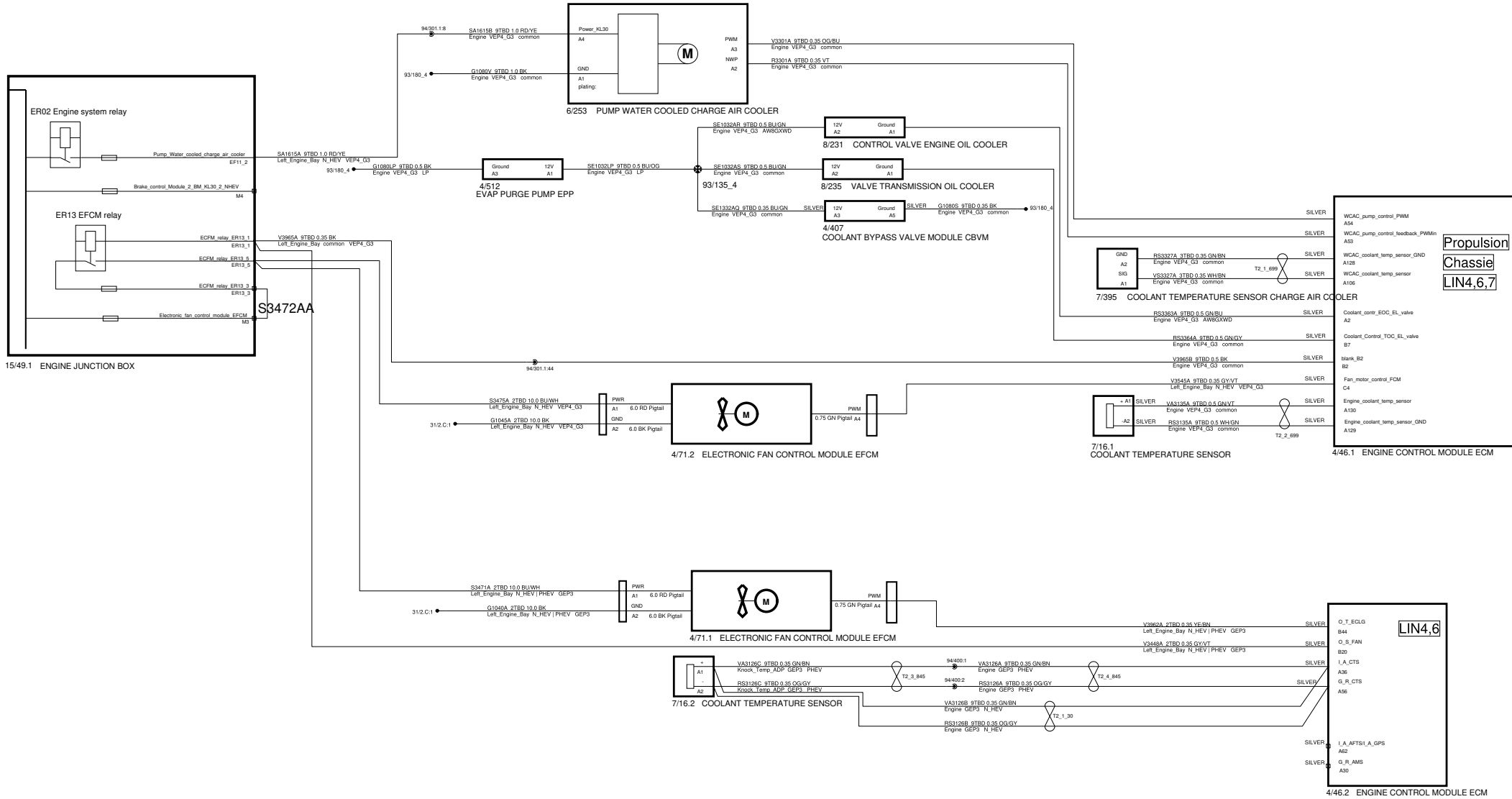

Propulsion
Chassis
LIN4,6,7

LIN4,6

The copying, distribution and utilization of this document as well as the communication of its contents to others without expressed authorization is prohibited. Offenders will be held liable for payment of damages. All rights reserved in the event of the grant of a patent, utility model or ornamental design registration.

VOLVO
VOLVO CAR CORPORATION

Document title 623A_PP_CC_04_06_2023
3D_Engine_thermal_management_HEV

Document Type DRAW/ELSY Release Status RELEASED

CEVT Document No 8888522365 Edited April/13/2023

Issue 035 Page No 87/146

3E Automatic Gear Shifting 7DCT

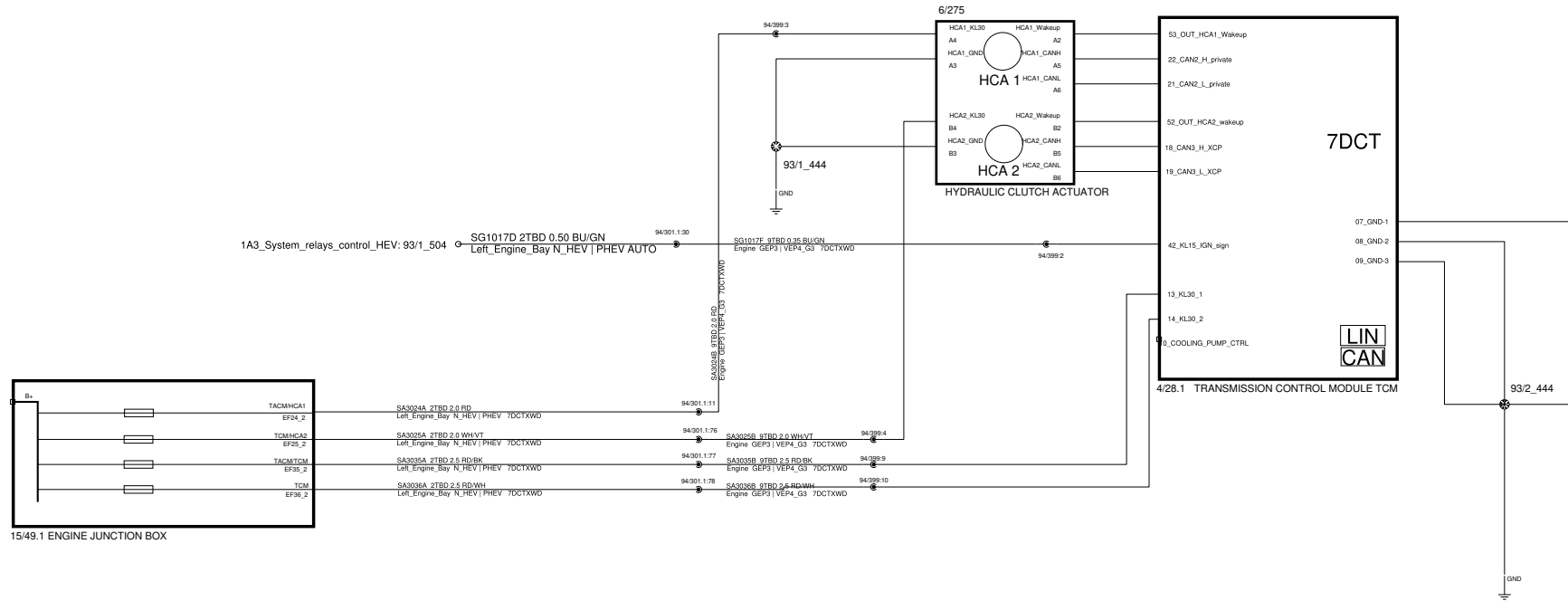

<p>The copying, distribution and utilization of this document as well as the communication of its contents to others without expressed authorization is prohibited. Offenders will be held liable for payment of damages. All rights reserved in the event of the grant of a patent, utility model or ornamental design registration.</p> <p>VOLVO VOLVO CAR CORPORATION</p>	Document title 623A_PP_CC_04_06_2023 3E_Automatic_Gear_Shifting_7DCT	
	Document Type DRAW/ELSY	Release Status RELEASED
	CEVT Document No 8888522365	Edited April/13/2023
	Issue 035	Page No 89/146

3E Automatic Gear Shifting

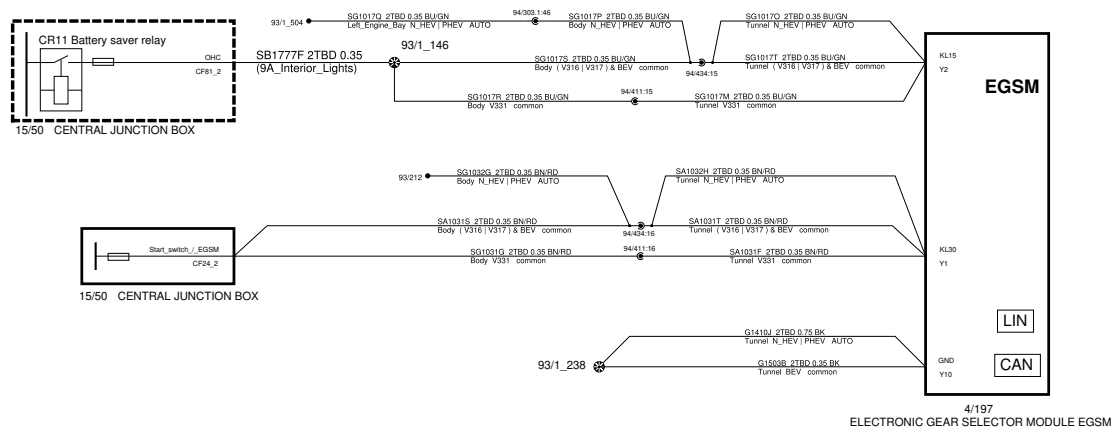
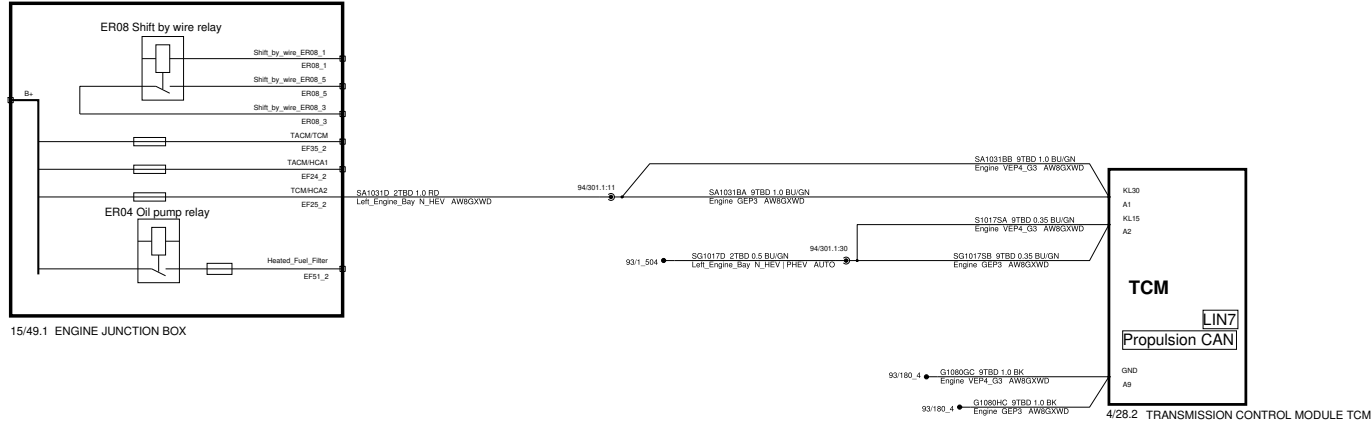

The copying, distribution and utilization of this document as well as the communication of its contents to others without expressed authorization is prohibited. Offenders will be held liable for payment of damages. All rights reserved in the event of the grant of a patent, utility model or ornamental design registration.		Document title 623A_PP_CC_04_06_2023 3E_Automatic_Gear_Shifting	
		Document Type DRAW/ELSY	Release Status RELEASED
VOLVO VOLVO CAR CORPORATION		Volvo Document No 33445458	Edited April/13/2023
		Issue 035	Page No 88/146

3G 4WD Transmission

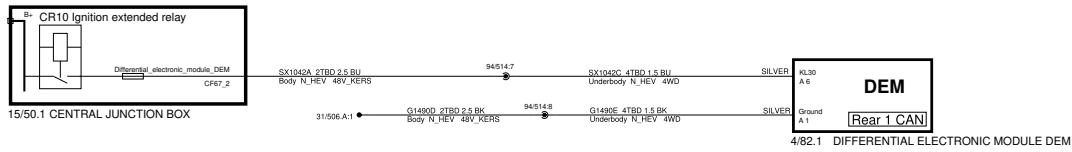

<p>The copying, distribution and utilization of this document as well as the communication of its contents to others without expressed authorization is prohibited. Offenders will be held liable for payment of damages. All rights reserved in the event of the grant of a patent, utility model or ornamental design registration.</p> <p>VOLVO VOLVO CAR CORPORATION</p>	Document title 623A_PP_CC_04_06_2023	
	3G_4WD_Transmission	
	Document Type DRAW/ELSY	Release Status RELEASED
	CEVT Document No 8888522365	Edited April/13/2023
Issue 035	Page No 90/146	

3M Engine Cranking (HEV)

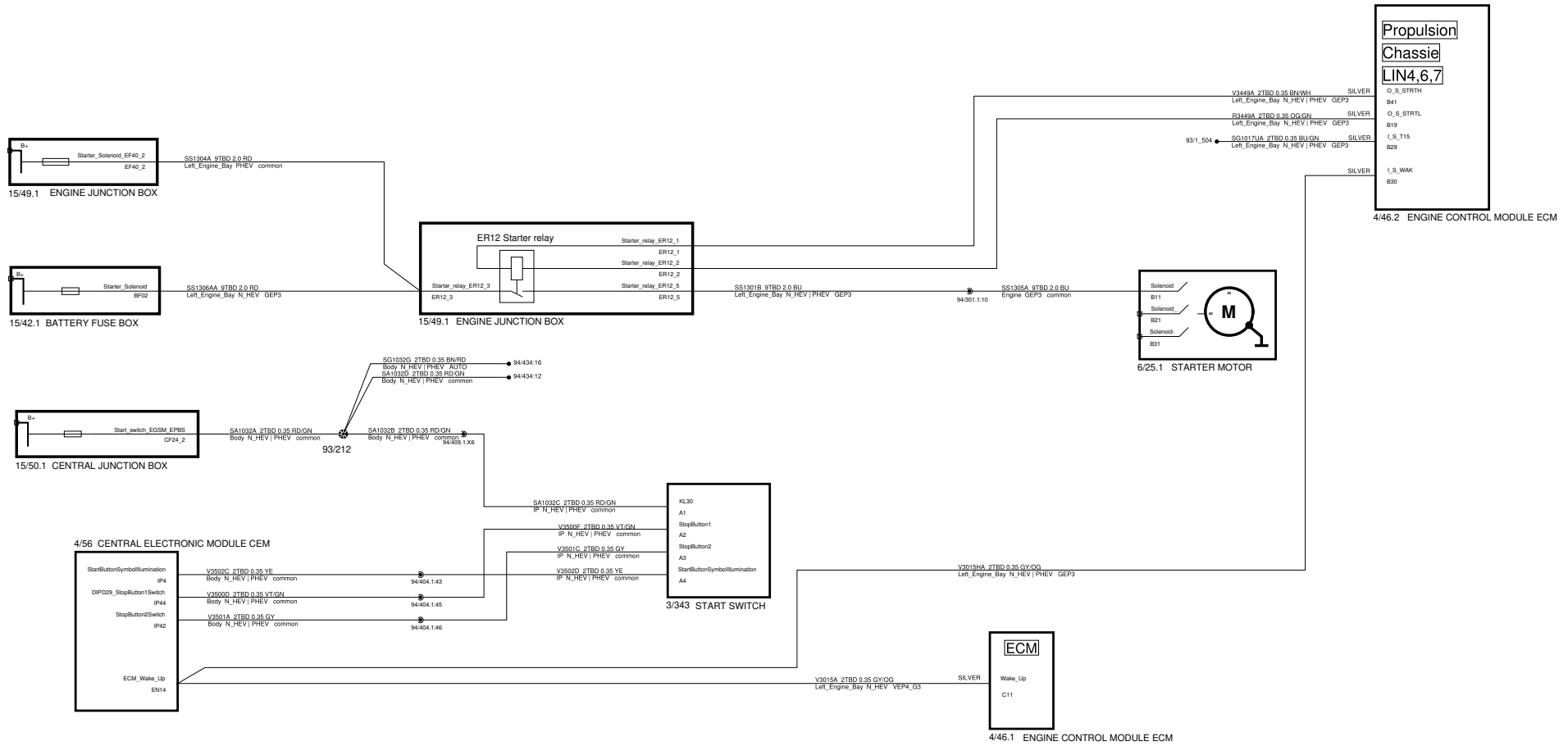

VOLVO VOLVO CAR CORPORATION	Document title 623A_PP_CC_04_06_2023 3M_Engine_Craking_Control_(HEV)	
	Document Type DRAW/ELSY	Release Status RELEASED
	CEVT Document No 8888522365	Edited April/13/2023
	Issue 035	Page No 91/146

The copying, distribution and utilization of this document as well as the communication of its contents to others without expressed authorization is prohibited. Offenders will be held liable for payment of damages. All rights reserved in the event of the grant of a patent, utility model or ornamental design registration.

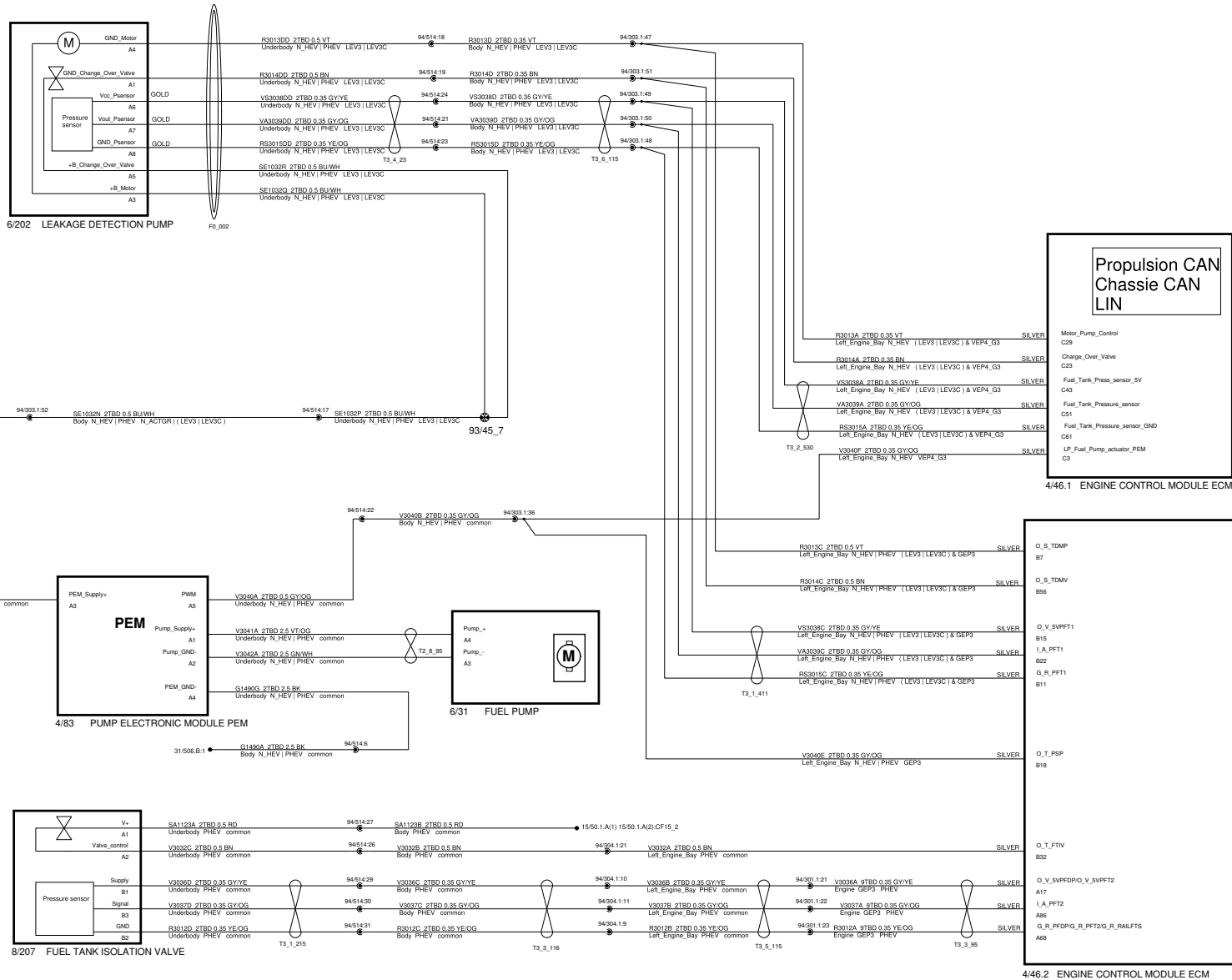

The copying, distribution and utilization of this document as well as the communication of its contents to others without expressed authorization is prohibited. Offenders will be held liable for payment of damages. All rights reserved in the event of the grant of a patent, utility model or ornamental design registration.



Document title 623A_PP_CC_04_06_2023
3S_Fuel_Supply_Control

Document Type	Release Status
DRAW/ELSY	RELEASED
CEVT Document No 8888522365	Edited March/30/2023
Issue 035	Page No 92/146

4A Driver information

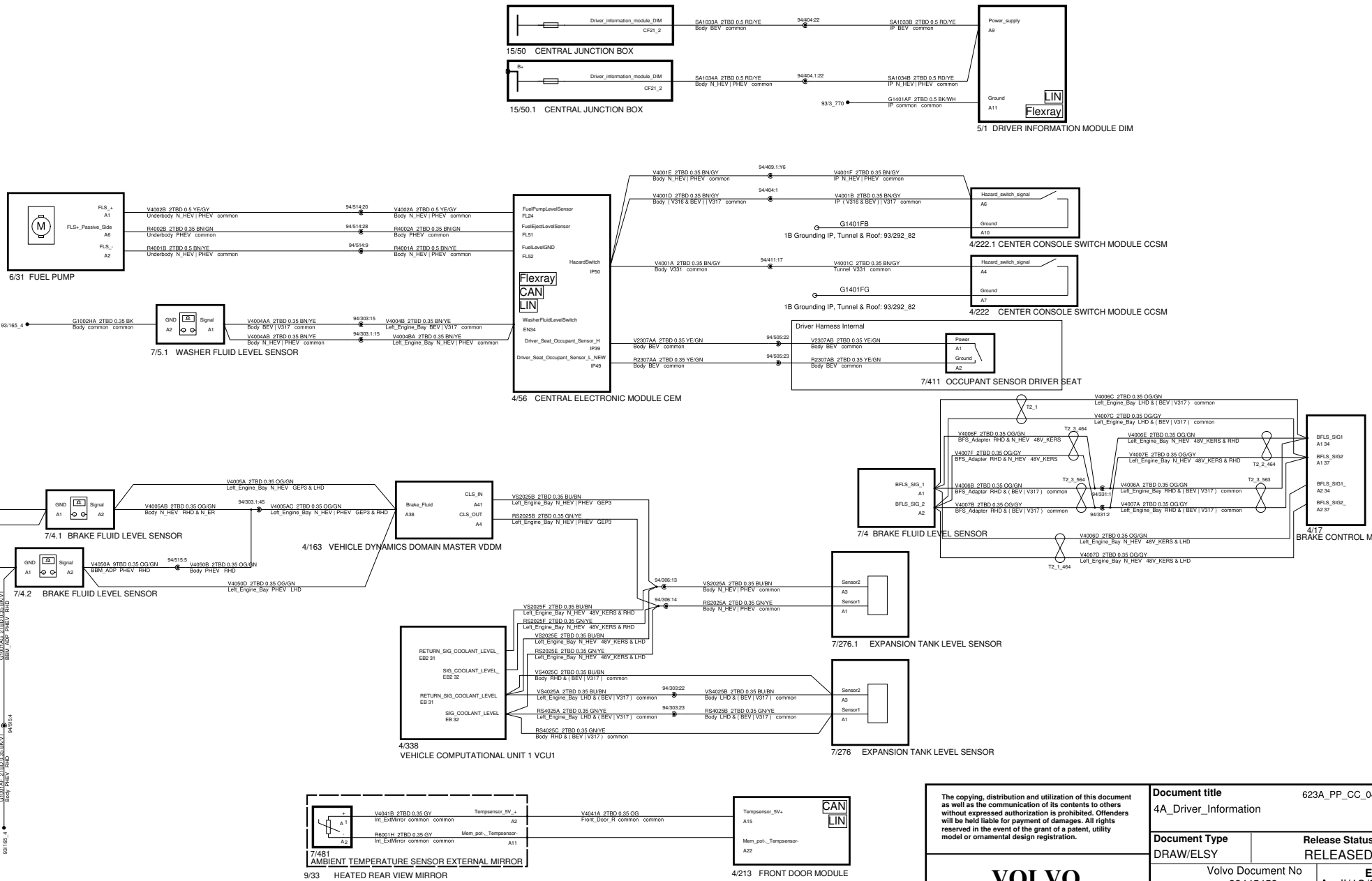

<p>The copying, distribution and utilization of this document as well as the communication of its contents to others without expressed authorization is prohibited. Offenders will be held liable for payment of damages. All rights reserved in the event of the grant of a patent, utility model or ornamental design registration.</p> <p>VOLVO VOLVO CAR CORPORATION</p>		<p>Document title 4A_Driver_Information</p>		<p>623A_PP_CC_04_06_2023</p>	
		<p>Document Type DRAW/ELSY</p>		<p>Release Status RELEASED</p>	
		<p>Volvo Document No 33445458</p>		<p>Edited April/13/2023</p>	
		<p>Issue 035</p>		<p>Page No 93/146</p>	

4J1 Parking Assistance FAP

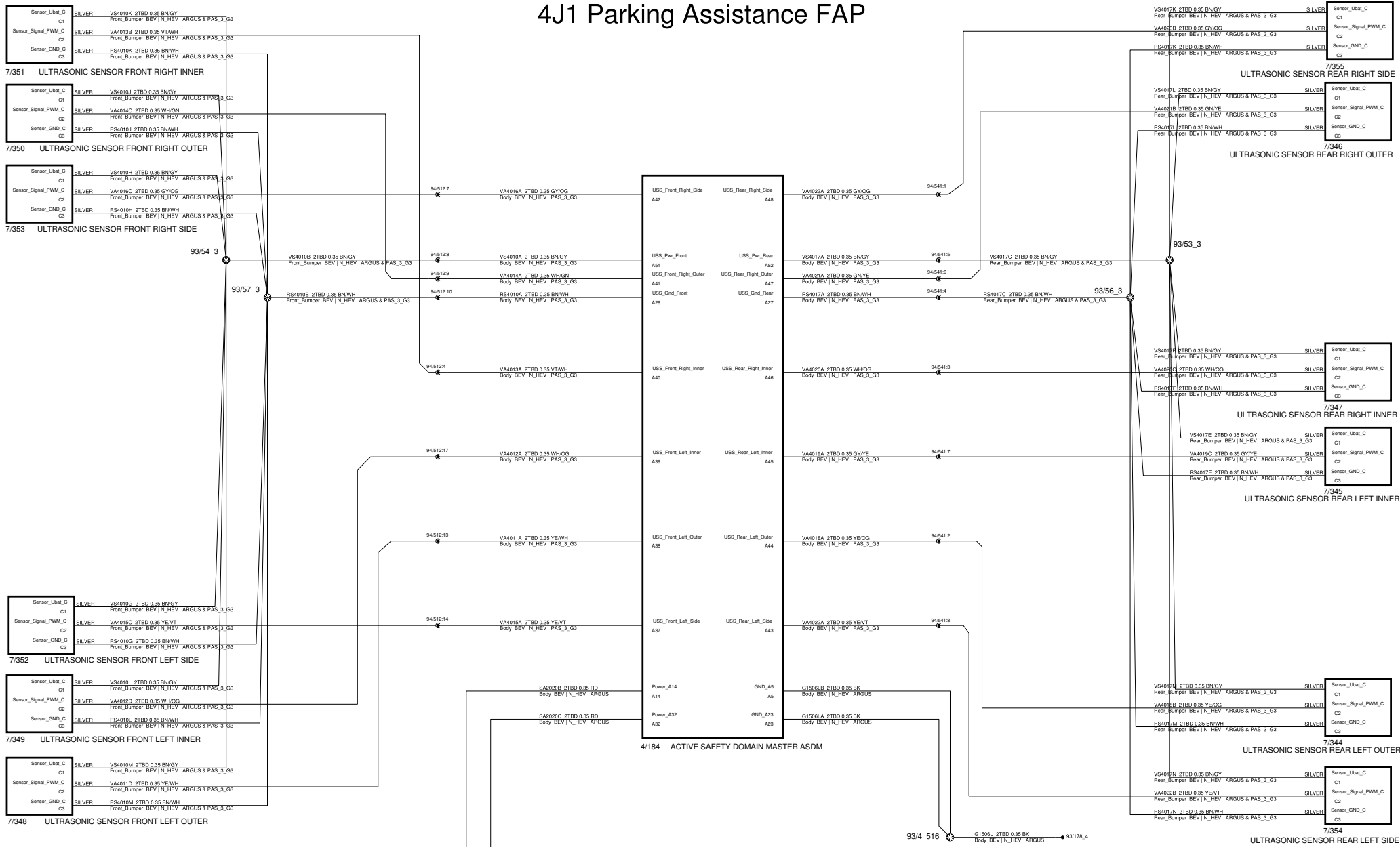

<p>The copying, distribution and utilization of this document as well as the communication of its contents to others without expressed authorization is prohibited. Offenders will be held liable for payment of damages. All rights reserved in the event of the grant of a patent, utility model or ornamental design registration.</p>		Document title		623A_PP_CC_04_06_2023
		4J1_Parking_Assistance_FAP		
Document Type		Release Status		
DRAW/ELSY		RELEASED		
Volvo Document No		Edited		
33445458		April/13/2023		
Issue		Page No		
035		94/146		

VOLVO
VOLVO CAR CORPORATION

4J1 Parking Assistance NBEV

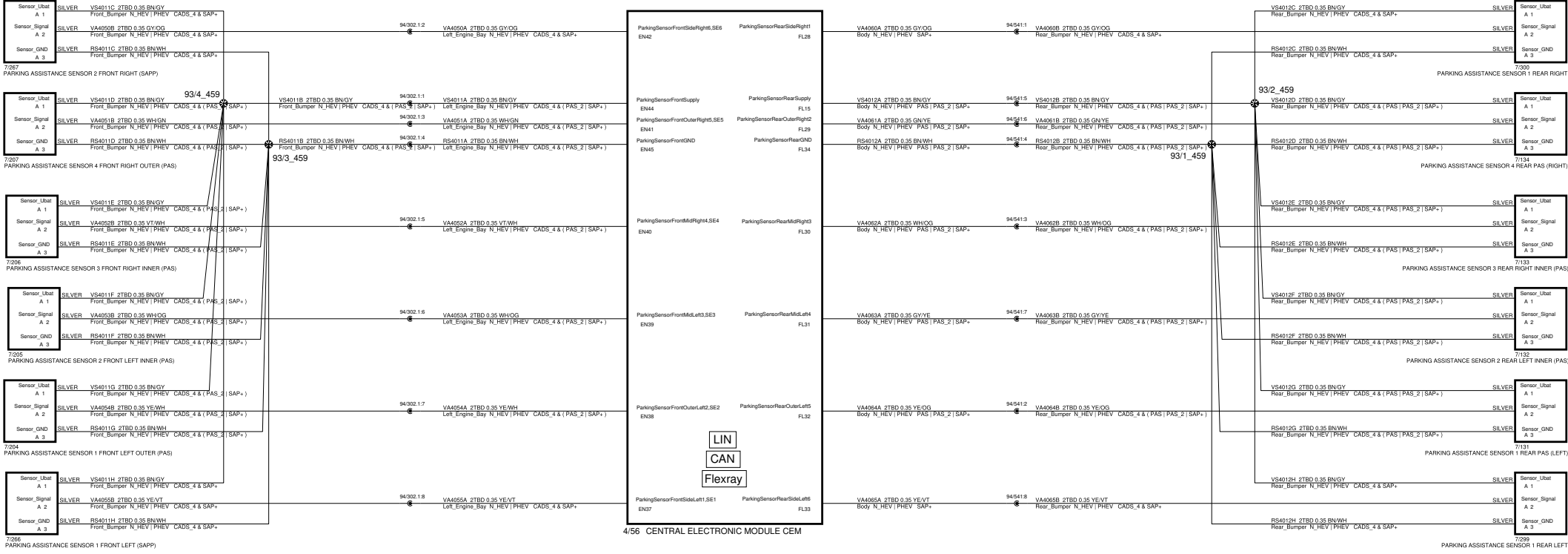

<p>The copying, distribution and utilization of this document as well as the communication of its contents to others without expressed authorization is prohibited. Offenders will be held liable for payment of damages. All rights reserved in the event of the grant of a patent, utility model or ornamental design registration.</p> <p>VOLVO VOLVO CAR CORPORATION</p>	<p>Document title 623A_PP_CC_04_06_2023</p> <p>4J1_Parking_Assistance_NBEV</p>	
	<p>Document Type DRAW/ELSY</p>	<p>Release Status RELEASED</p>
	<p>CEVT Document No 8888522365</p>	<p>Edited June/16/2021</p>
	<p>Issue 035</p>	<p>Page No 95/146</p>
	<p>7299 PARKING ASSISTANCE SENSOR 1 REAR LEFT</p>	

4J1 Parking Assistance PAS PAS_2

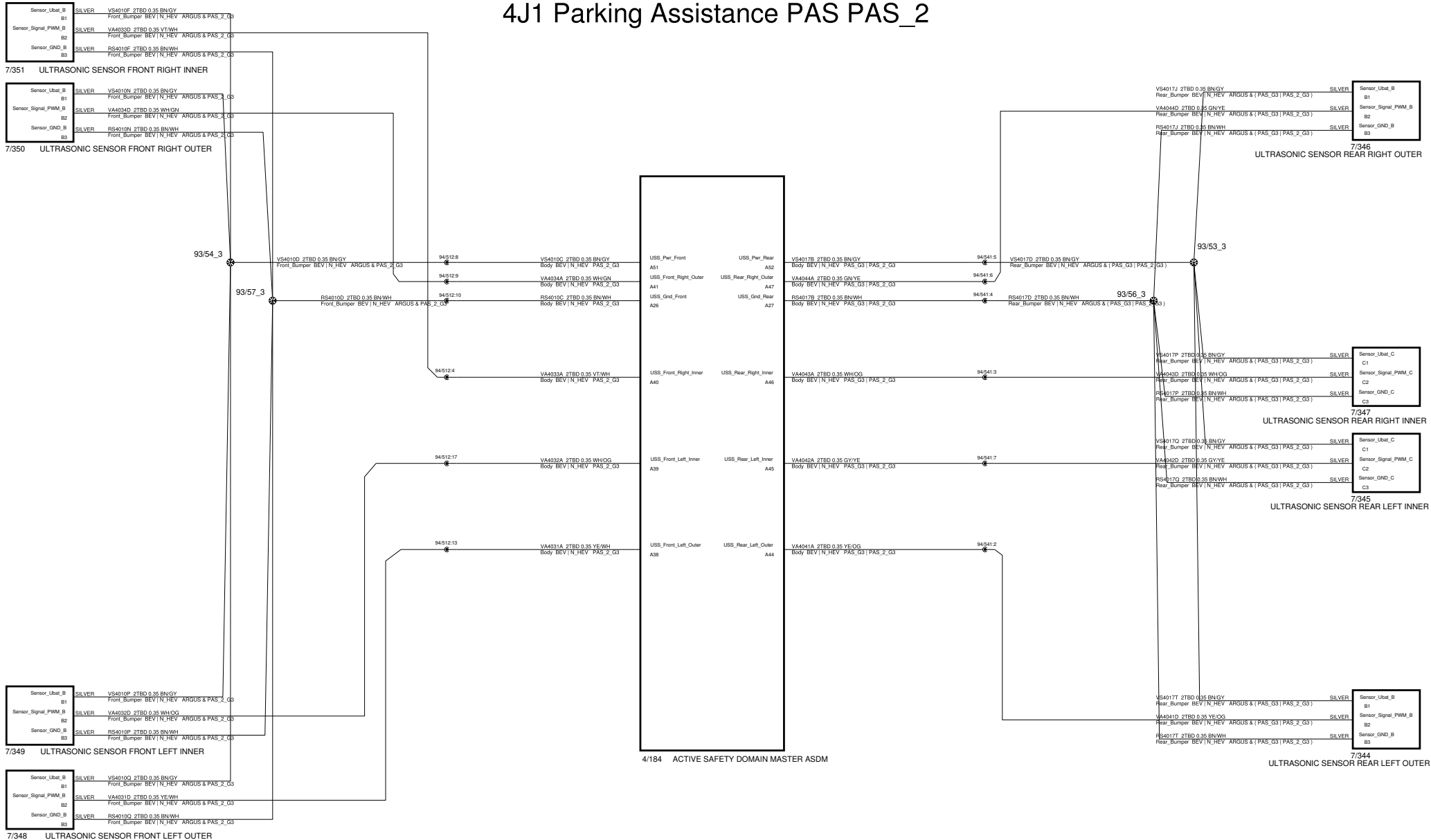

<p>The copying, distribution and utilization of this document as well as the communication of its contents to others without expressed authorization is prohibited. Offenders will be held liable for payment of damages. All rights reserved in the event of the grant of a patent, utility model or ornamental design registration.</p> <p>VOLVO VOLVO CAR CORPORATION</p>	<p>Document title 623A_PP_GC_04_06_2023 4J1_Parking_Assistance_PAS_PAS2</p>	
	<p>Document Type DRAW/ELSY</p>	<p>Release Status RELEASED</p>
	<p>CEVT Document No 8888522365</p>	<p>Edited June/16/2021</p>
	<p>Issue 035</p>	<p>Page No 96/146</p>

4J2B Lane Change Aid

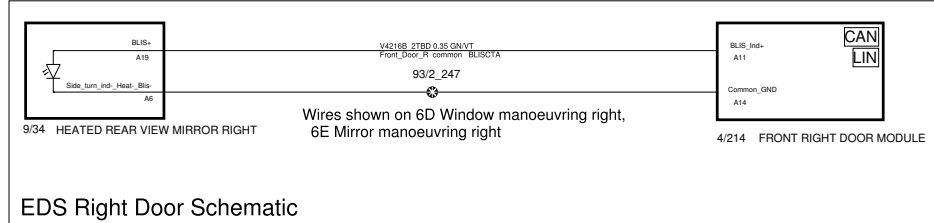
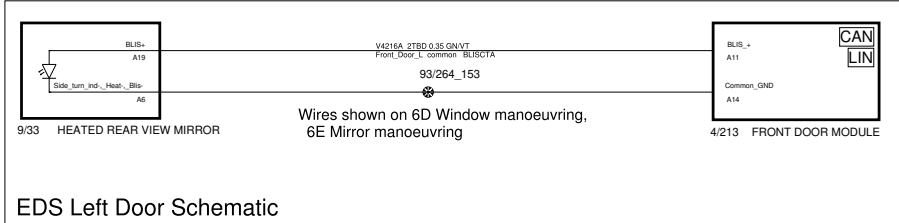
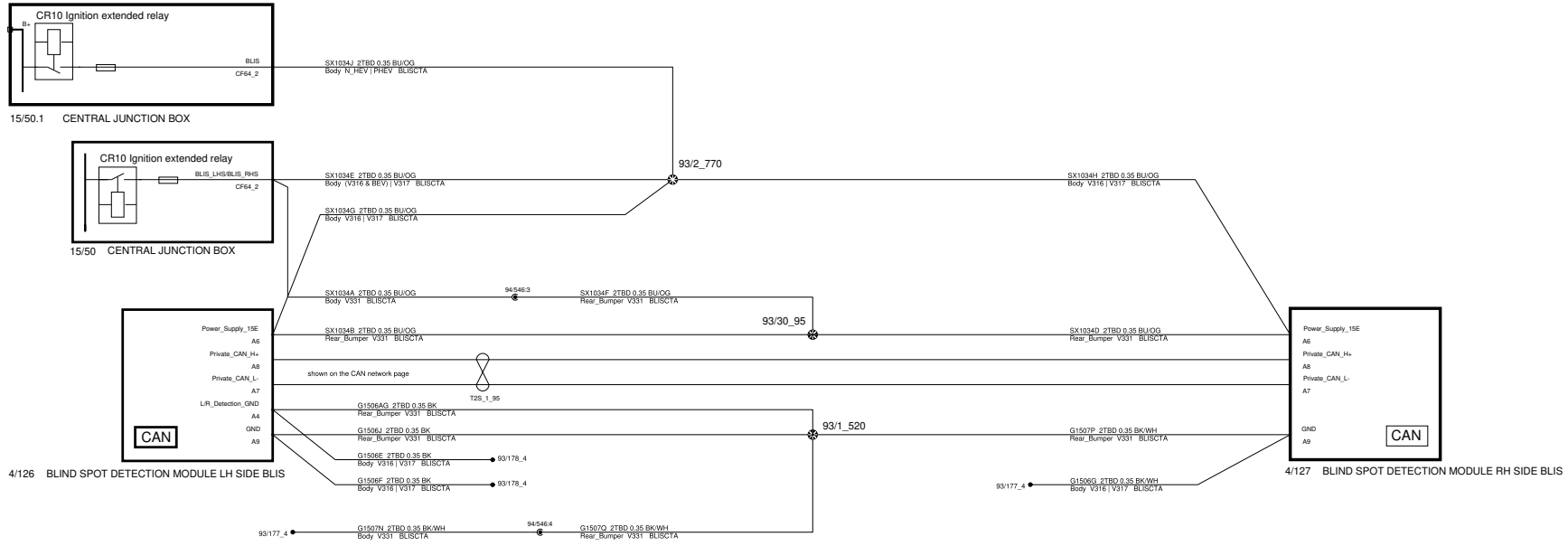

<p>The copying, distribution and utilization of this document as well as the communication of its contents to others without expressed authorization is prohibited. Offenders will be held liable for payment of damages. All rights reserved in the event of the grant of a patent, utility model or ornamental design registration.</p>		Document title 623A_PP_CC_04_06_2023 4J2B_Lane_Change_Aid	
		Document Type DRAW/ELSY	Release Status RELEASED
<p>VOLVO VOLVO CAR CORPORATION</p>		Volvo Document No 33445458	Edited April/13/2023
		Issue 035	Page No 97/146

4J4 PAC Visualisation/Driver Assistance COAX

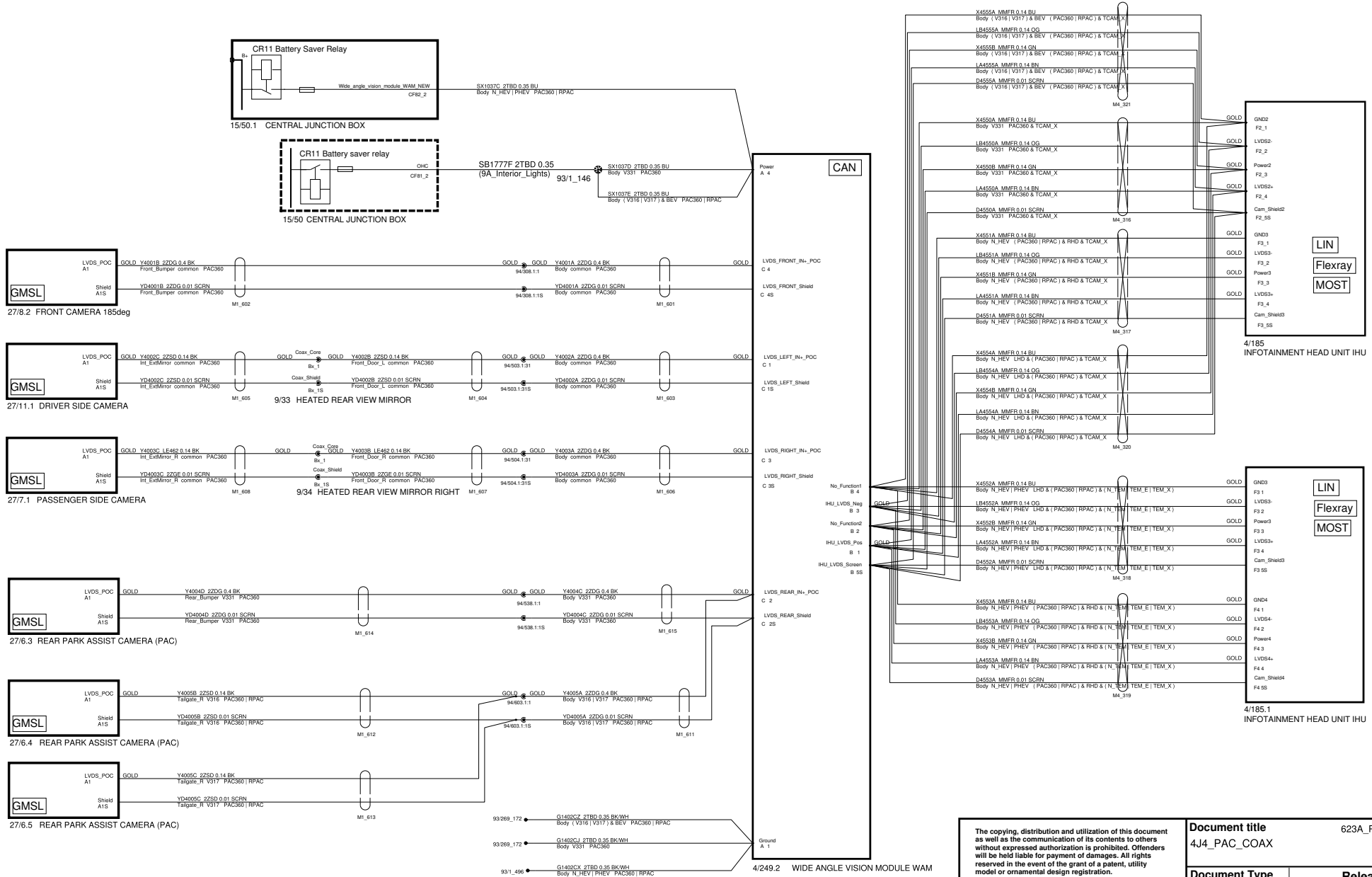

<p>The copying, distribution and utilization of this document as well as the communication of its contents to others without expressed authorization is prohibited. Offenders will be held liable for payment of damages. All rights reserved in the event of a patent, utility model or ornamental design registration.</p> <p style="text-align: center;">VOLVO VOLVO CAR CORPORATION</p>		<p>Document title 4J4_PAC_COAX</p>		<p>623A_PP_CC_04_06_2023</p>	
		<p>Document Type DRAW/ELSY</p>		<p>Release Status RELEASED</p>	
		<p>CEVT Document No 8888522365</p>		<p>Edited April/13/2023</p>	
		<p>Issue 035</p>		<p>Page No 98/146</p>	

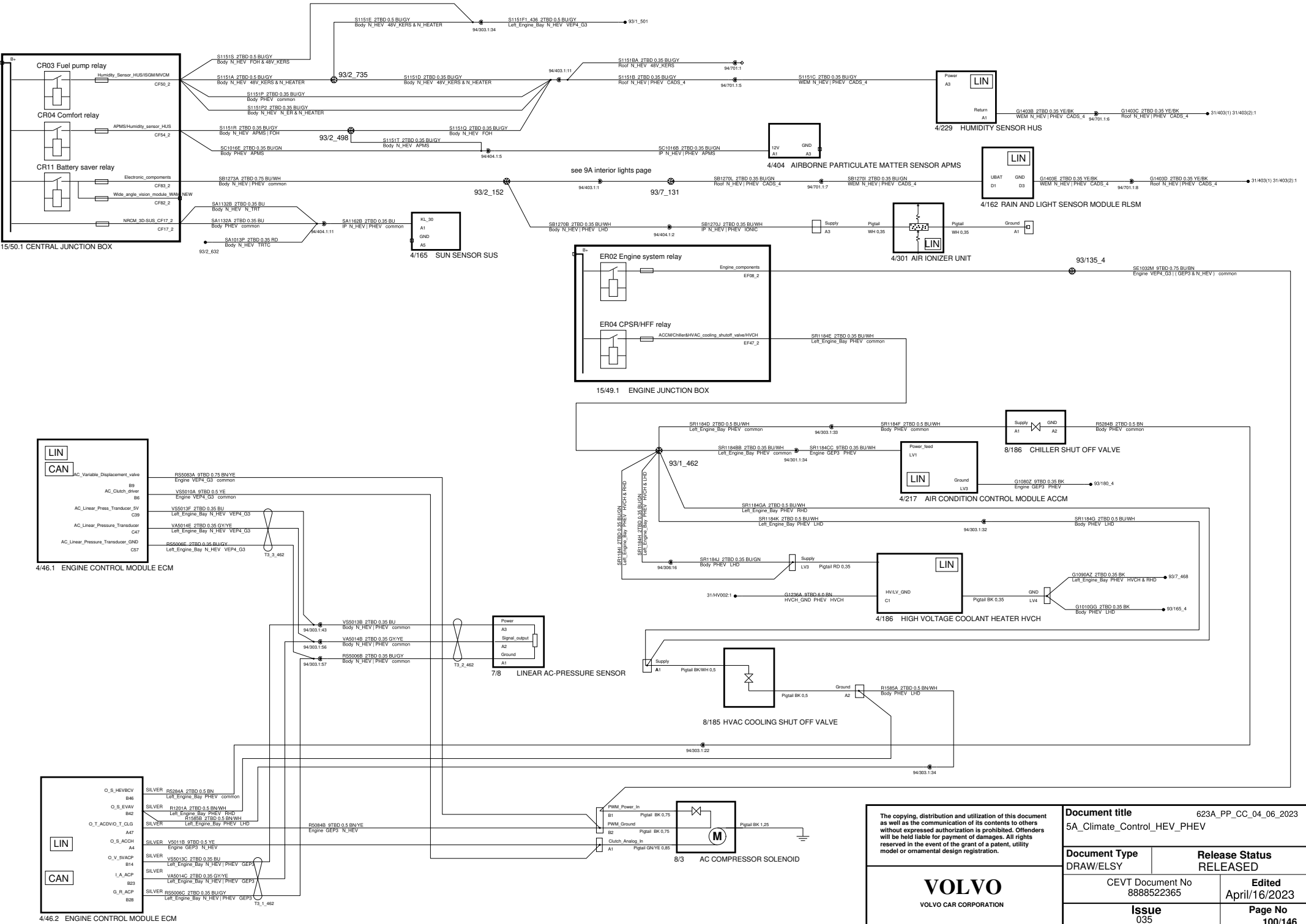

The copying, distribution and utilization of this document as well as the communication of its contents to others without expressed authorization is prohibited. Offenders will be held liable for payment of damages. All rights reserved in the event of the grant of a patent, utility model or ornamental design registration.

VOLVO
VOLVO CAR CORPORATION

Document title 623A_PP_CC_04_06_2023 5A_Climate_Control_HEV_PHEV	
Document Type DRAW/ELSY	Release Status RELEASED
CEVT Document No 8888522365	Edited April/16/2023
Issue 035	Page No 100/146

5A Climate Control HVAC ECC

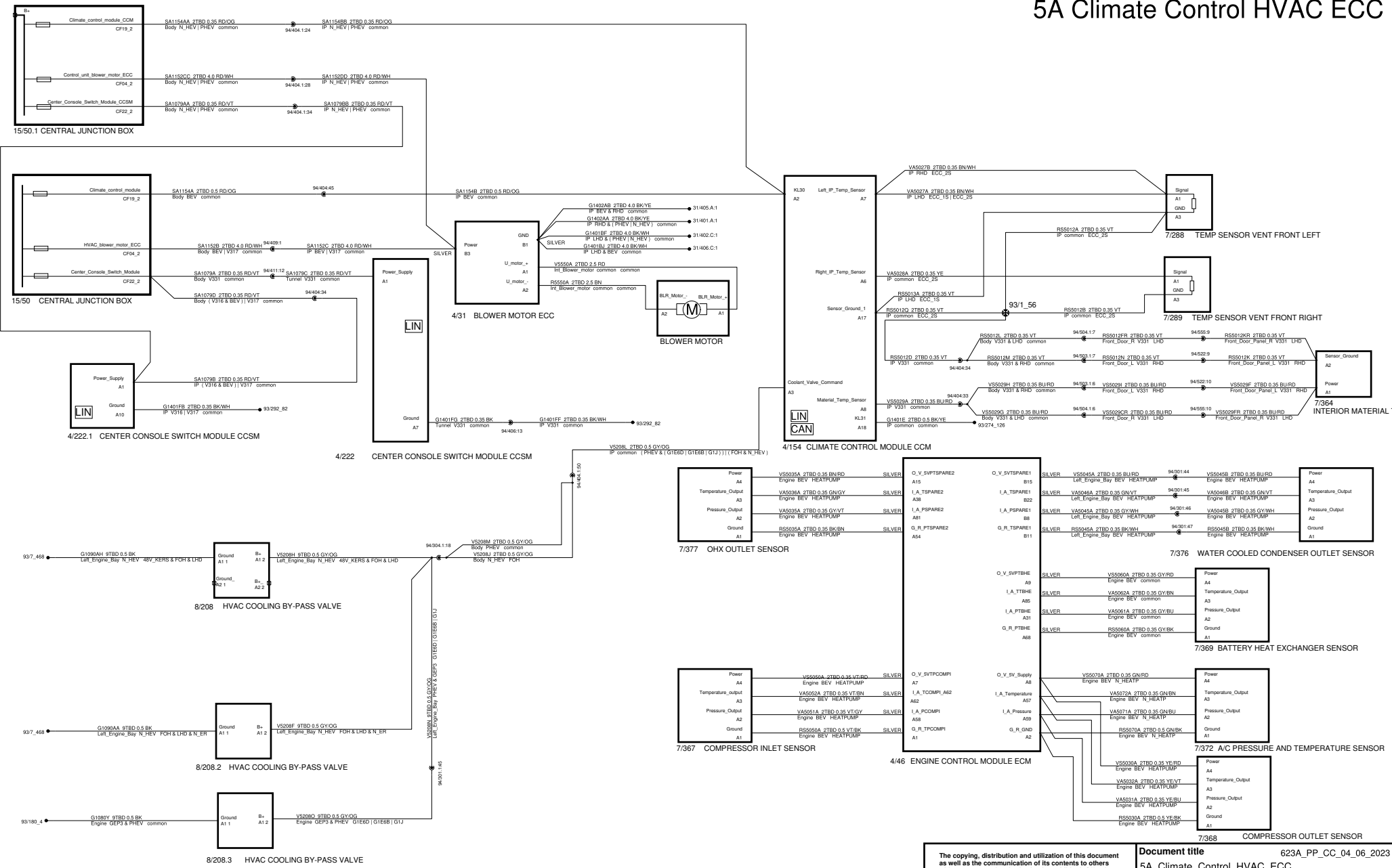

The copying, distribution and utilization of this document as well as the communication of its contents to others without expressed authorization is prohibited. Offenders will be held liable for payment of damages. All rights reserved in the event of the grant of a patent, utility model or ornamental design registration.

VOLVO
VOLVO CAR CORPORATION

Document title 623A_PP_CC_04_06_2023 5A_Climate_Control_HVAC_ECC	
Document Type DRAW/ELSY	Release Status RELEASED
Issue 035	Page No 101/146
Volvo Document No 33445458	Edited April/19/2023

5A Climate Control

A

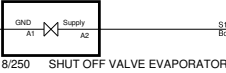
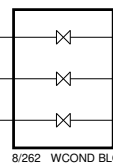
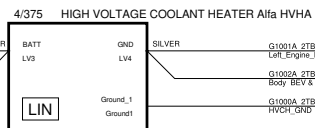
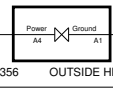
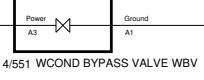
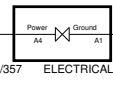
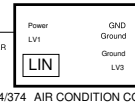
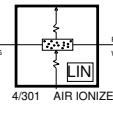
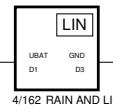
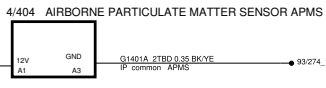
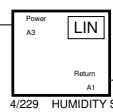
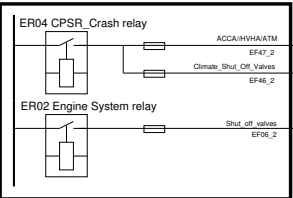
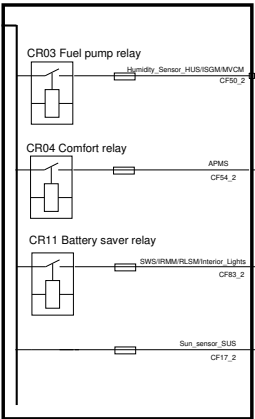
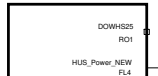

A

B

C

D

E

F

<p>The copying, distribution and utilization of this document as well as the communication of its contents to others without expressed authorization is prohibited. Offenders will be held liable for payment of damages. All rights reserved in the event of the grant of a patent, utility model or ornamental design registration.</p> <p>VOLVO VOLVO CAR CORPORATION</p>	<p>Document title 5A_Climate_Control</p>		<p>623A_PP_CC_04_06_2023</p>
	<p>Document Type DRAW/ELSY</p>	<p>Release Status RELEASED</p>	
	<p>Volvo Document No 33445458</p>		<p>Edited April/16/2023</p>
	<p>Issue 035</p>	<p>Page No 99/146</p>	

1

2

3

4

5

6

7

8

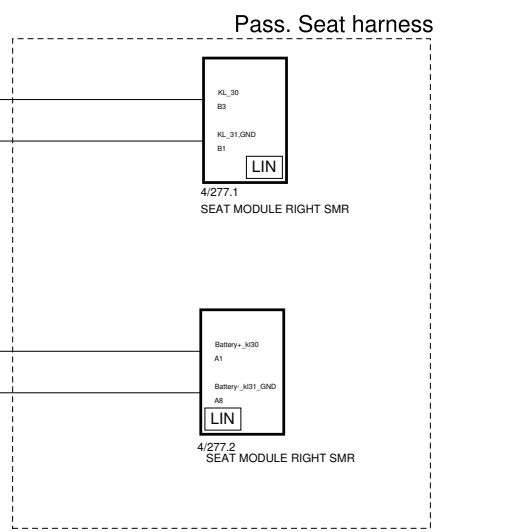
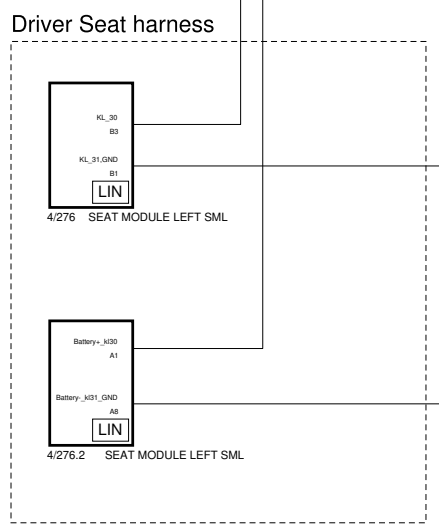
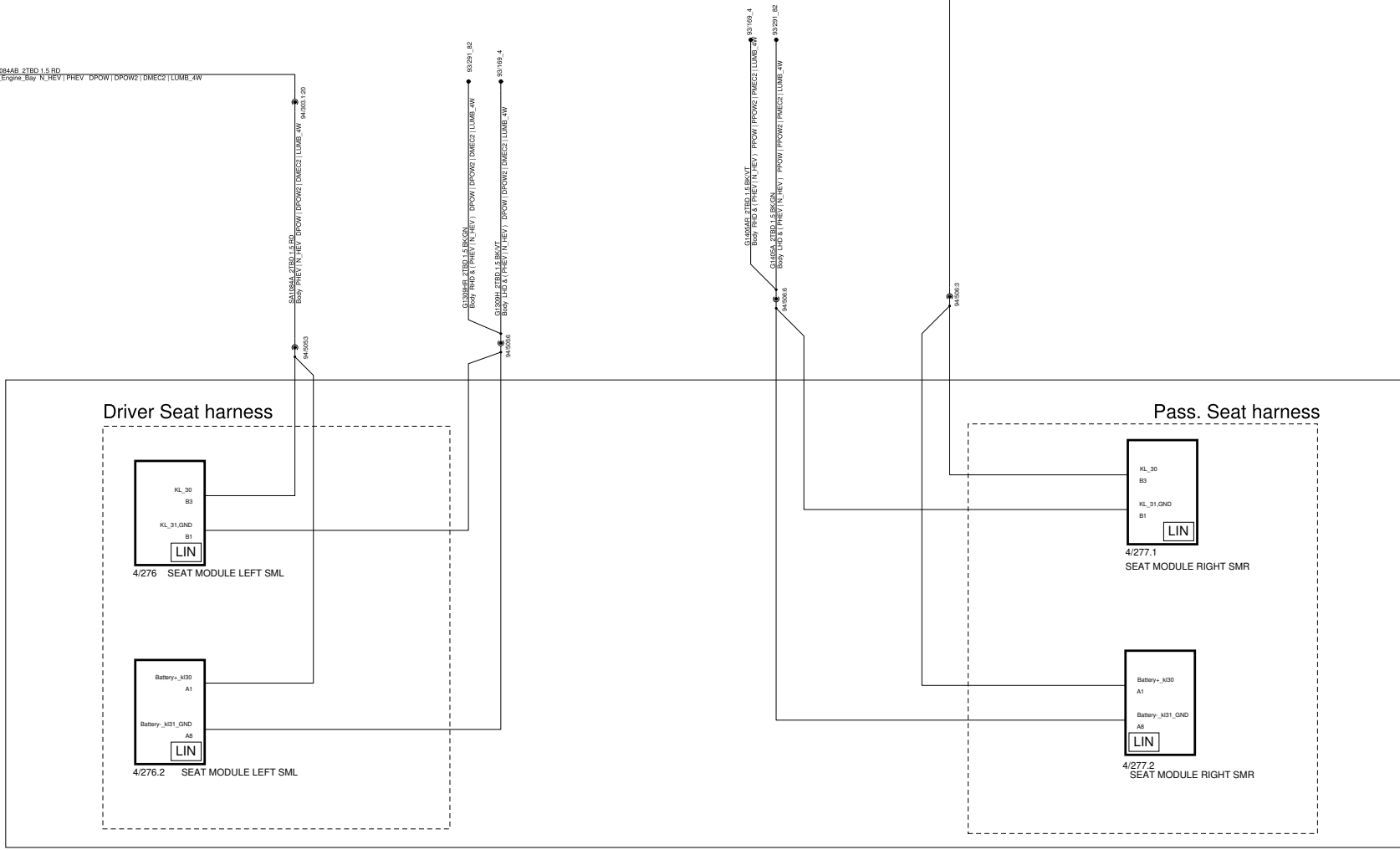
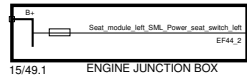
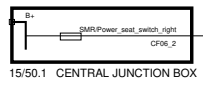

The copying, distribution and utilization of this document as well as the communication of its contents to others without expressed authorization is prohibited. Offenders will be held liable for payment of damages. All rights reserved in the event of the grant of a patent, utility model or ornamental design registration.

VOLVO
VOLVO CAR CORPORATION

Document title		623A_PP_CC_04_06_2023	
5B_Front_Seat_Comfort_PHEV			
Document Type	DRAW/ELSY	Release Status	RELEASED
CEVT Document No 8888522365		Edited April/16/2023	
Issue 035		Page No 103/146	

5B Front Seat Comfort

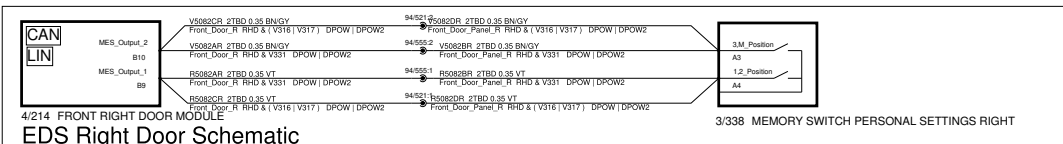
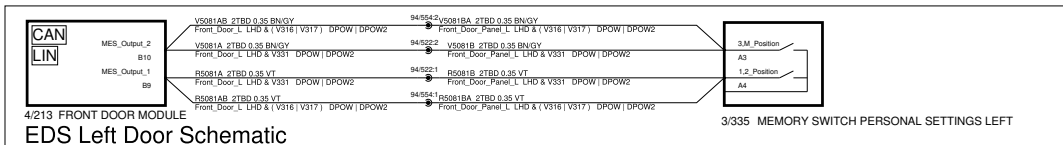
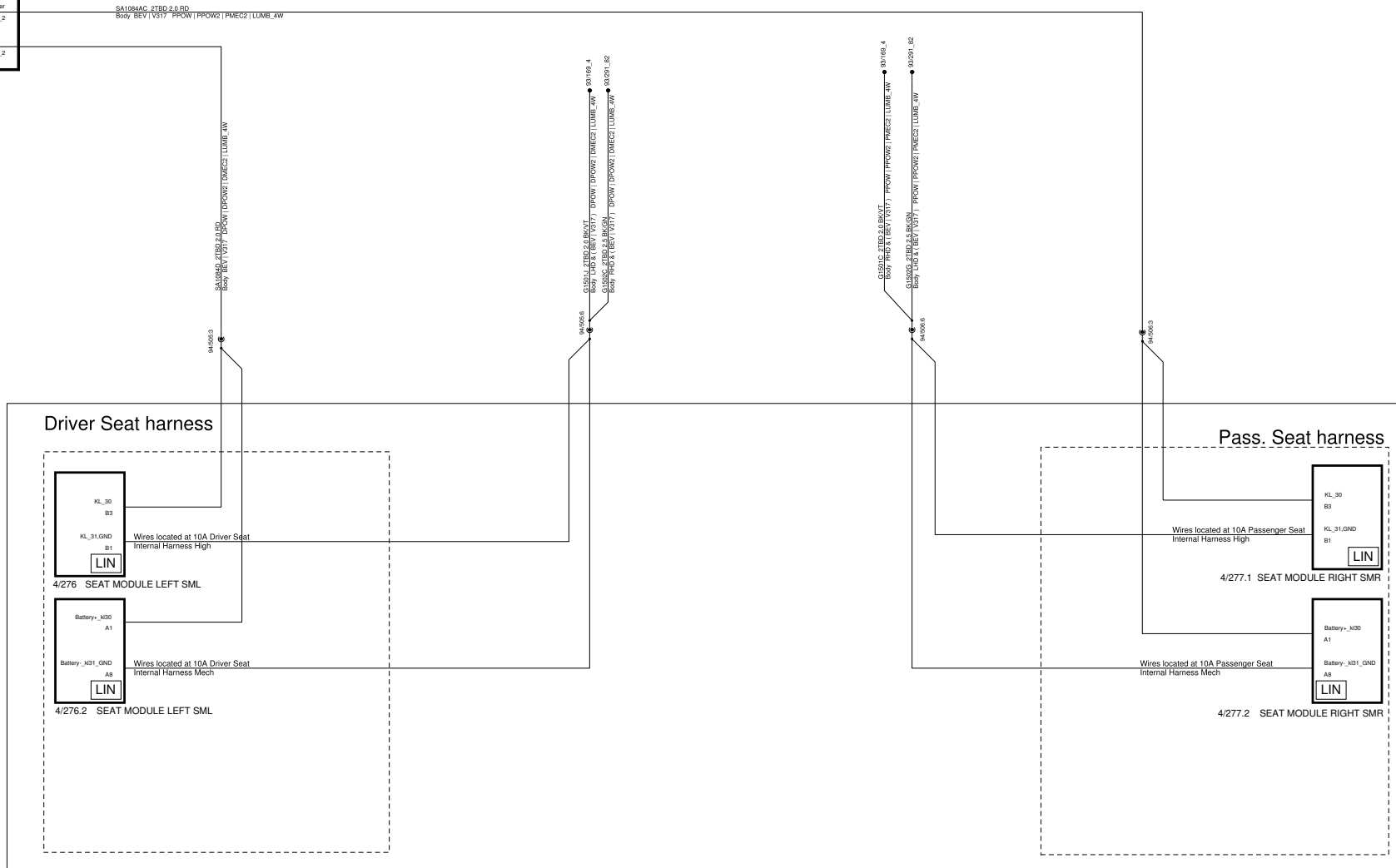
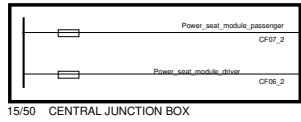

<p>The copying, distribution and utilization of this document as well as the communication of its contents to others without expressed authorization is prohibited. Offenders will be held liable for payment of damages. All rights reserved in the event of the grant of a patent, utility model or ornamental design registration.</p>		<p>Document title</p> <p>623A_PP_CC_04_06_2023</p>	
		<p>Document Type</p> <p>DRAW/ELSY</p>	<p>Release Status</p> <p>RELEASED</p>
<p>VOLVO</p> <p>VOLVO CAR CORPORATION</p>		<p>Volvo Document No</p> <p>33445458</p>	<p>Edited</p> <p>April/16/2023</p>
		<p>Issue</p> <p>035</p>	<p>Page No</p> <p>102/146</p>

5B Rear Seat Comfort

Rear Seat Harness

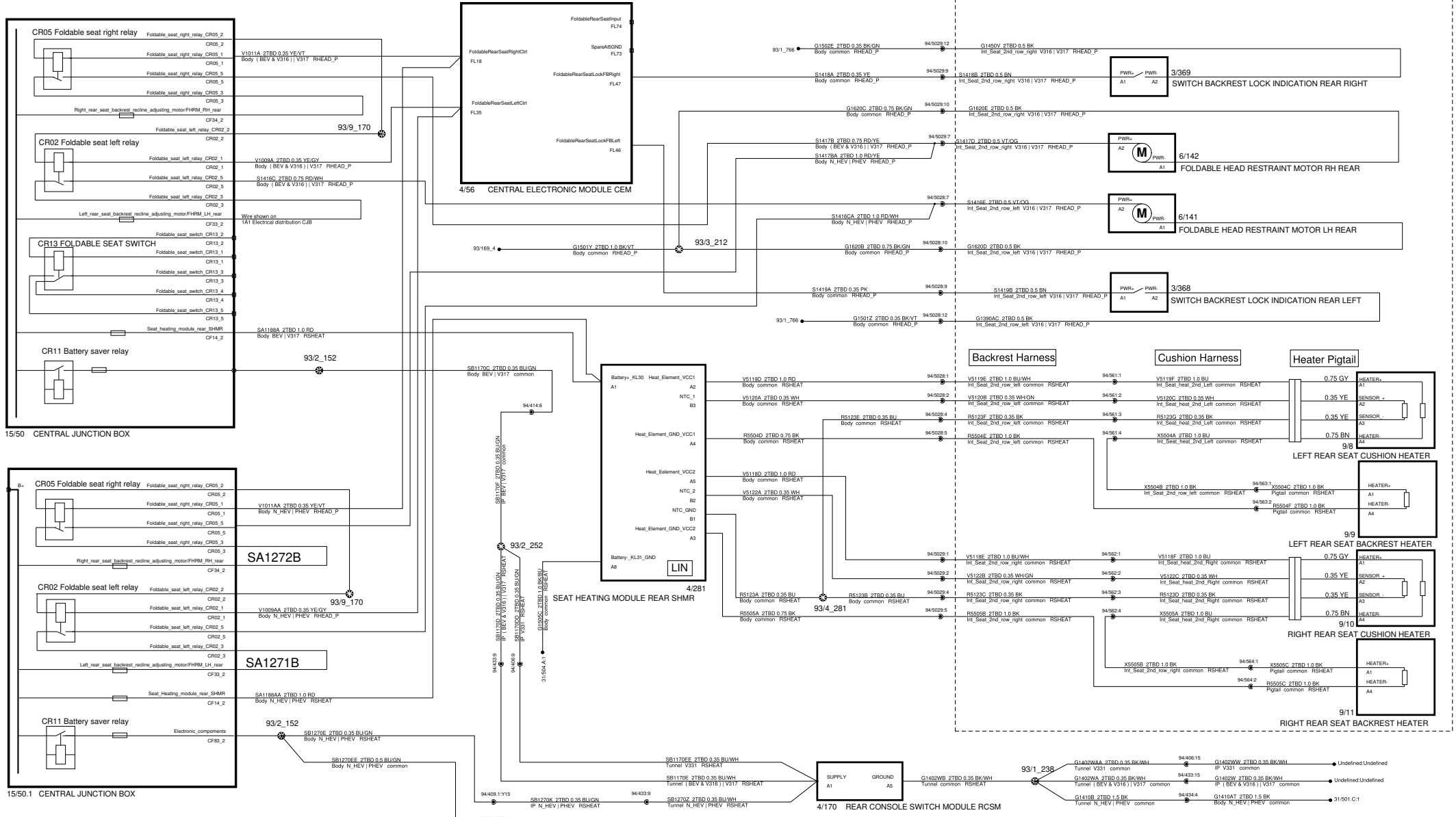

Continues through
 - 8A_Exterior_Light_Front
 - 9A_Interior_Lights

<p>The copying, distribution and utilization of this document as well as the communication of its contents to others without expressed authorization is prohibited. Offenders will be held liable for payment of damages. All rights reserved in the event of the grant of a patent, utility model or ornamental design registration.</p>		<p>Document title 5B_Rear_Seat_Comfort</p> <p>623A_PP_CC_04_06_2023</p>	
<p>Document Type DRAW/ELSY</p>		<p>Release Status RELEASED</p>	
<p>Volvo Document No 33445458</p>		<p>Edited April/16/2023</p>	
<p>Issue 035</p>		<p>Page No 104/146</p>	



VOLVO CAR CORPORATION

5F1 Passenger Compartment Pre-Conditioning

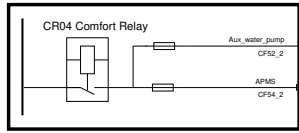

15/50 CENTRAL JUNCTION BOX

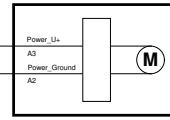

4/694 COMPARTMENT COOLANT PUMP MODULE CCPM

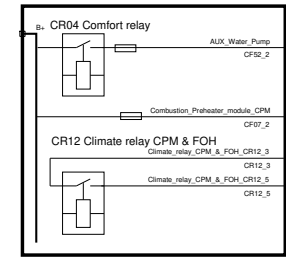

15/50.1 CENTRAL JUNCTION BOX

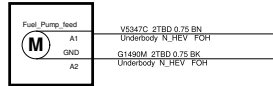

6/35 FUEL PUMP PARKING HEATER

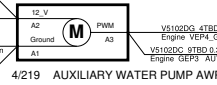

4/219 AUXILIARY WATER PUMP AWP

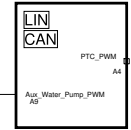

4/154 CLIMATE CONTROL MODULE CCM

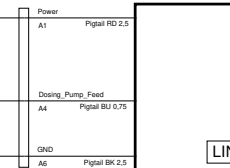

4/7 COMBUSTION PREHEATER MODULE CPM

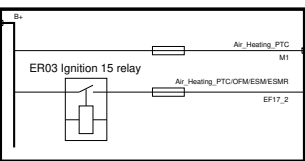

15/49.1 ENGINE JUNCTION BOX

<p>The copying, distribution and utilization of this document as well as the communication of its contents to others without expressed authorization is prohibited. Offenders will be held liable for payment of damages. All rights reserved in the event of the grant of a patent, utility model or ornamental design registration.</p> <p>VOLVO</p> <p>VOLVO CAR CORPORATION</p>	<p>Document title 623A_PP_CC_04_06_2023</p> <p>5F1_Passenger_Compartment_Pre-Conditioning</p>	
	<p>Document Type</p> <p>DRAW/ELSY</p>	<p>Release Status</p> <p>RELEASED</p>
	<p>Volvo Document No</p> <p>33445458</p>	<p>Edited</p> <p>April/16/2023</p>
	<p>Issue</p> <p>035</p>	<p>Page No</p> <p>105/146</p>

5G Steering Wheel Heating

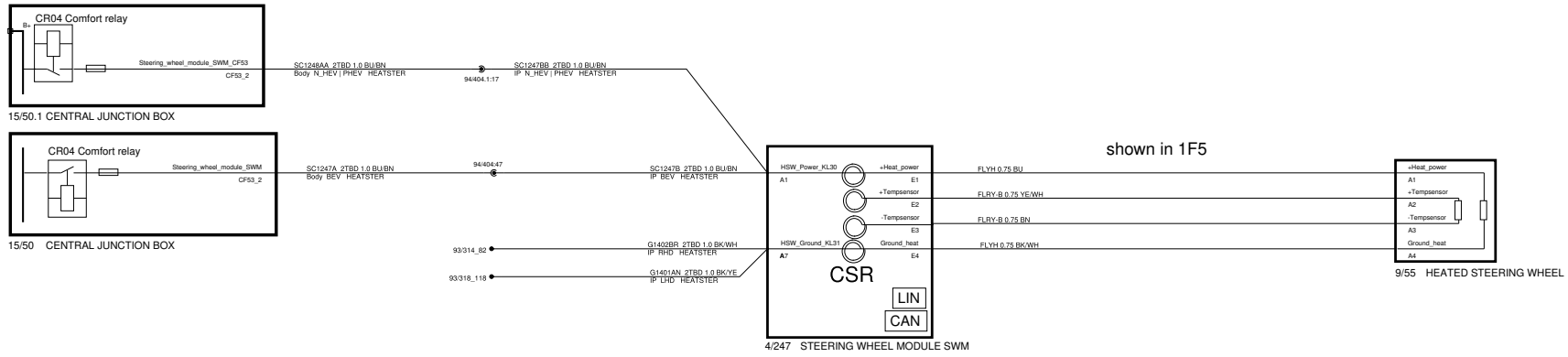

<p>The copying, distribution and utilization of this document as well as the communication of its contents to others without expressed authorization is prohibited. Offenders will be held liable for payment of damages. All rights reserved in the event of the grant of a patent, utility model or ornamental design registration.</p> <p>VOLVO VOLVO CAR CORPORATION</p>	Document title 623A_PP_CC_04_06_2023 5G_Steering_Wheel_Heating	
	Document Type DRAW/ELSY	Release Status RELEASED
	Volvo Document No 33445458	Edited April/16/2023
	Issue 035	Page No 106/146

6A Locking Front Right

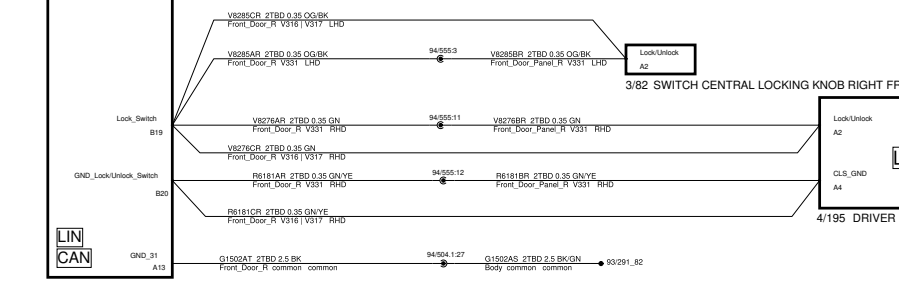
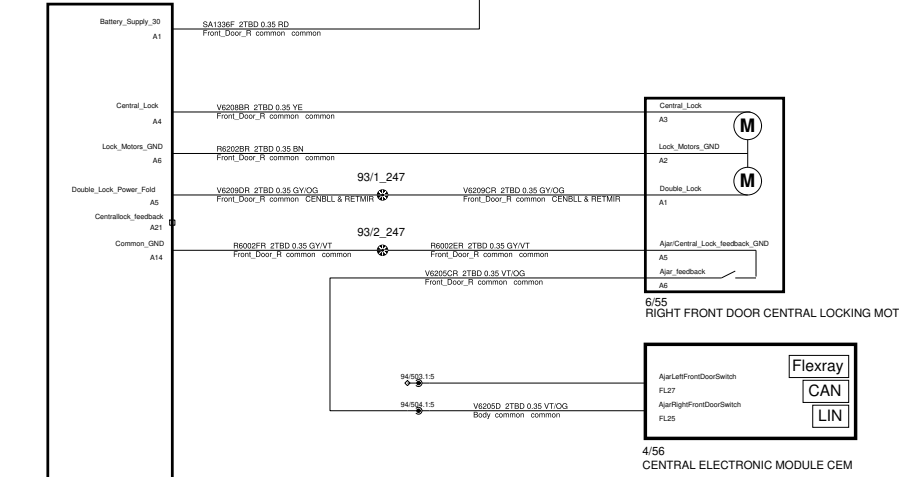
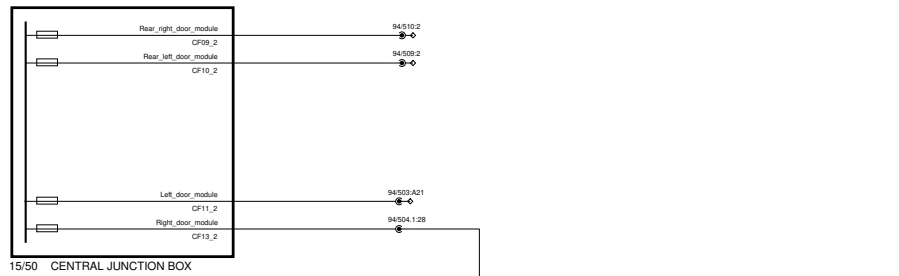

<p>The copying, distribution and utilization of this document as well as the communication of its contents to others without expressed authorization is prohibited. Offenders will be held liable for payment of damages. All rights reserved in the event of the grant of a patent, utility model or ornamental design registration.</p> <p>VOLVO VOLVO CAR CORPORATION</p>	Document title 623A_PP_CC_04_06_2023 6A_Locking_Front_Right	
	Document Type DRAW/ELSY	Release Status RELEASED
	CEVT Document No 8888522365	Edited April/16/2023
	Issue 035	Page No 108/146

6A Locking Rear Right

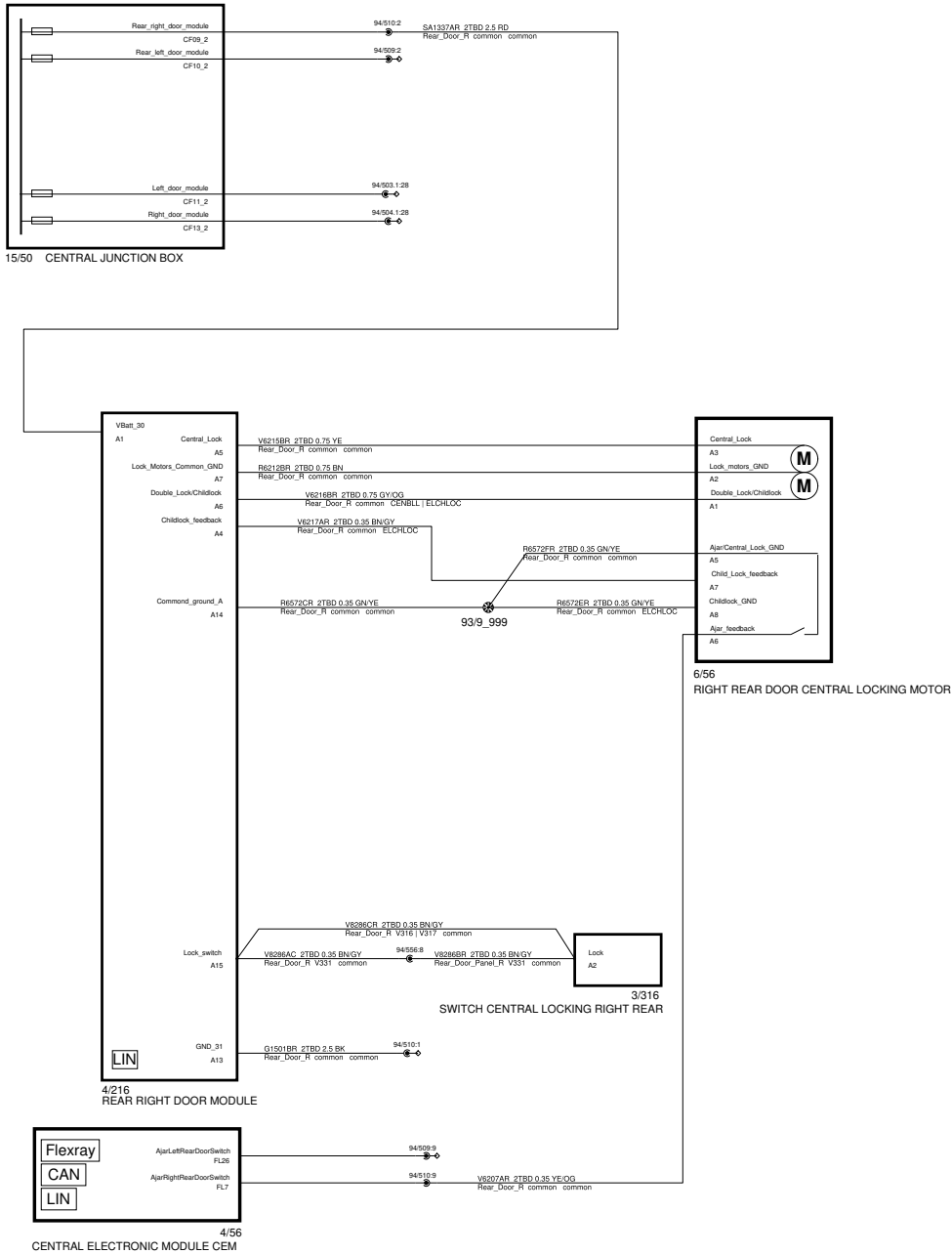

<p>The copying, distribution and utilization of this document as well as the communication of its contents to others without expressed authorization is prohibited. Offenders will be held liable for payment of damages. All rights reserved in the event of the grant of a patent, utility model or ornamental design registration.</p> <p>VOLVO VOLVO CAR CORPORATION</p>	<p>Document title 623A_PP_CC_04_06_2023 6A_Locking_Rear_Right</p>	
	<p>Document Type DRAW/ELSY</p>	<p>Release Status RELEASED</p>
	<p>CEVT Document No 8888522365</p>	<p>Edited April/16/2023</p>
	<p>Issue 035</p>	<p>Page No 109/146</p>

6A Locking

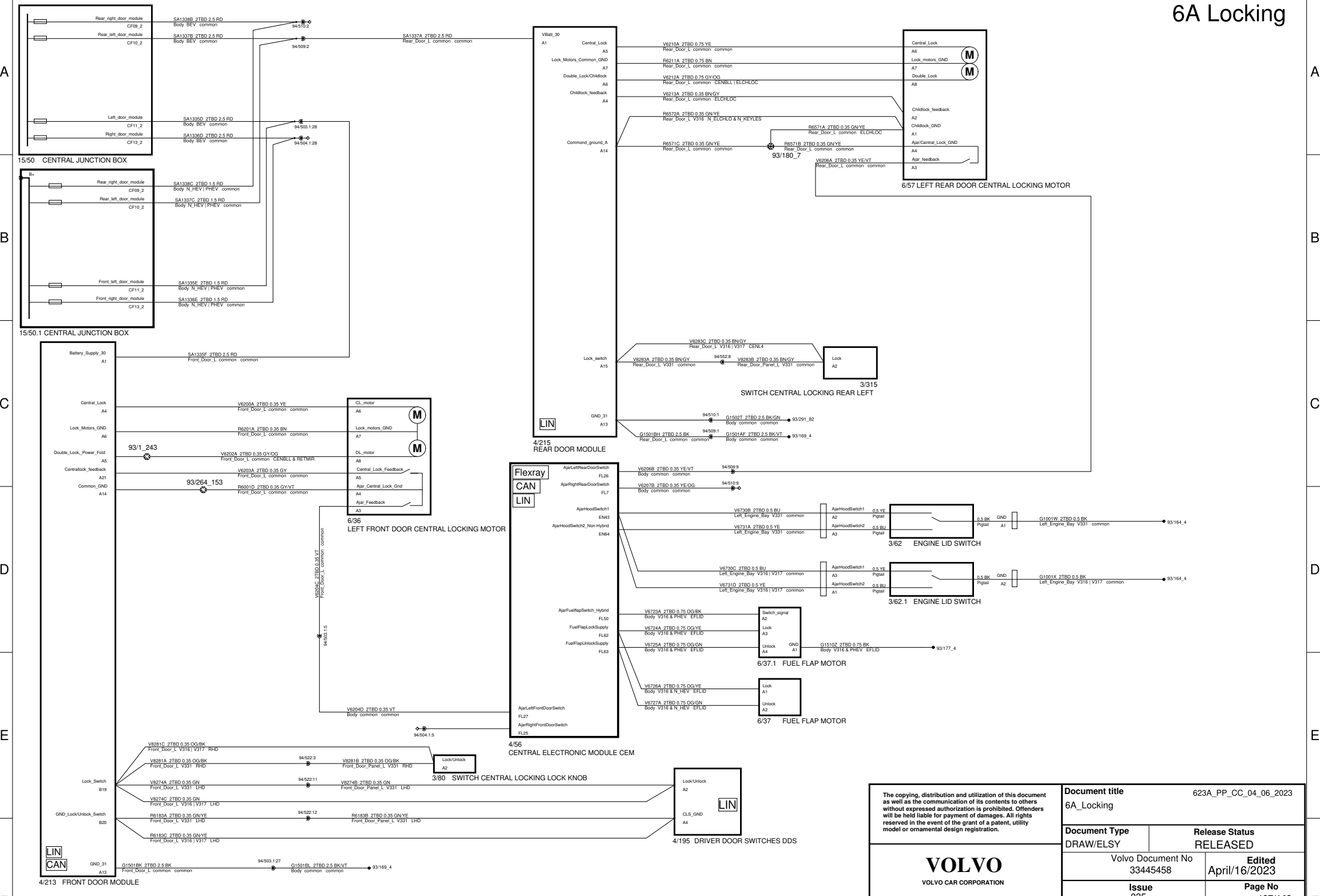

The copying, distribution and utilization of this document as well as the communication of its contents to others without expressed authorization is prohibited. Offenders will be held liable for payment of damages. All rights reserved in the event of the grant of a patent, utility model or ornamental design registration.		Document title 6A_Locking	623A_PP_CC_04_06_2023
Document Type DRAW/ELSY	Release Status RELEASED		
Volvo Document No 33445458	Edited April/16/2023		
Issue 035	Page No 107/146		

VOLVO
VOLVO CAR CORPORATION

6C Theft Protection

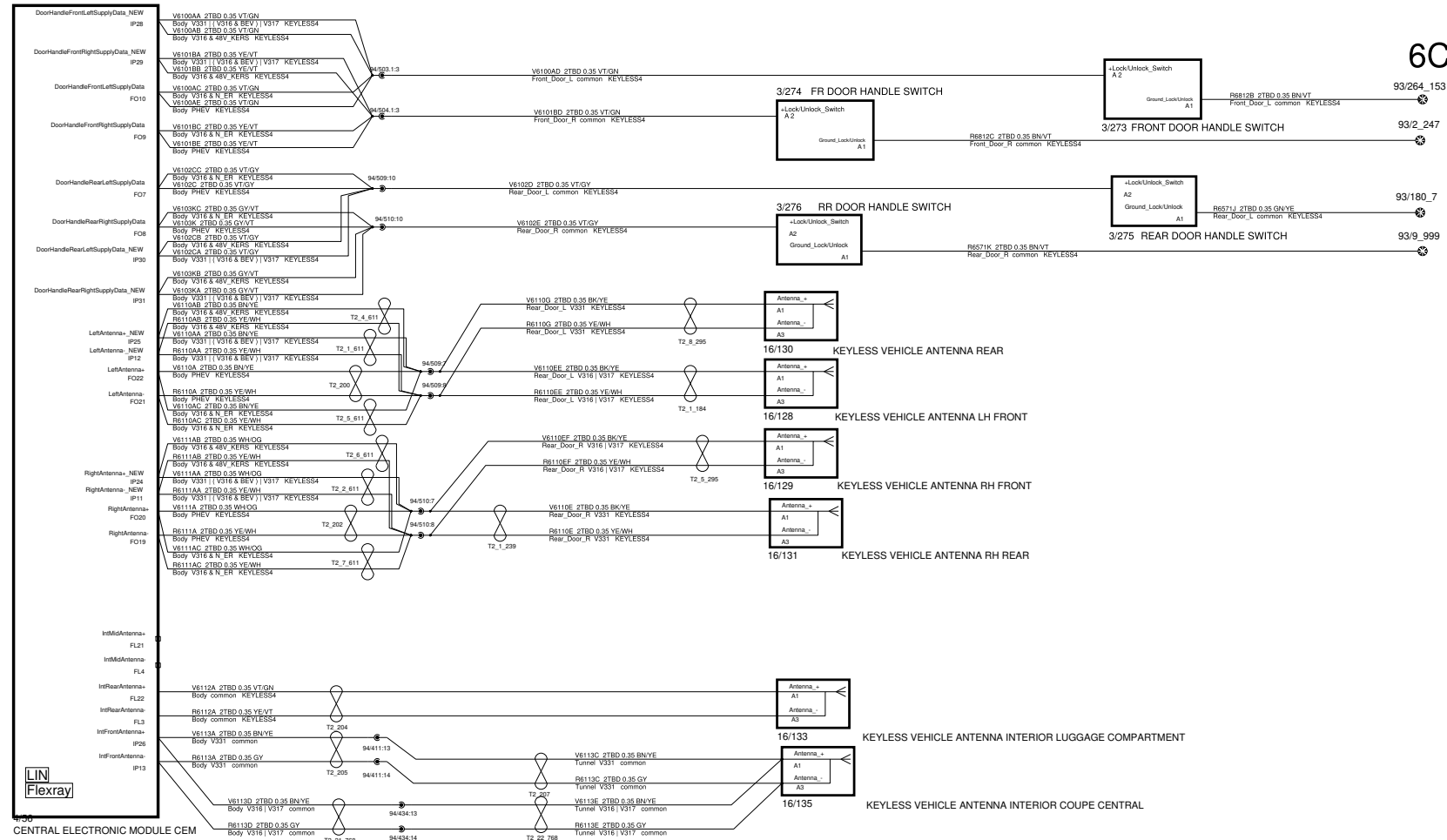

Passive unlocking

Immobilizing

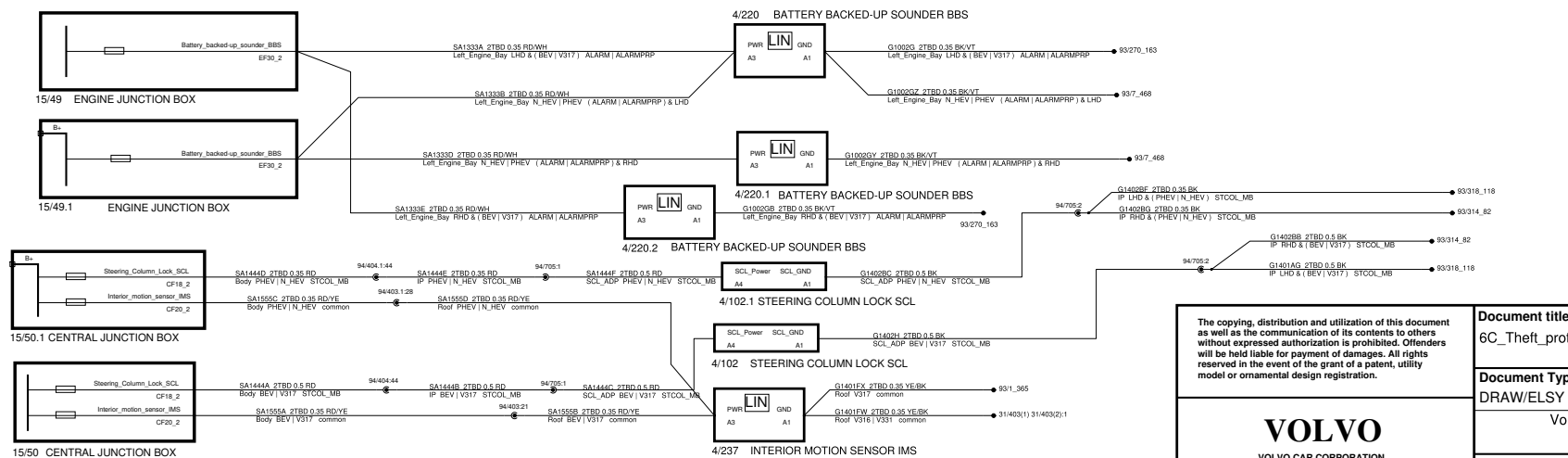

<p>The copying, distribution and utilization of this document as well as the communication of its contents to others without expressed authorization is prohibited. Offenders will be held liable for payment of damages. All rights reserved in the event of the grant of a patent, utility model or ornamental design registration.</p>		<p>Document title 6C_Theft_protection</p>	<p>623A_PP_CC_04_06_2023</p>
<p>Document Type DRAW/ELSY</p>	<p>Release Status RELEASED</p>		
<p>Volvo Document No 33445458</p>		<p>Edited April/16/2023</p>	
<p>Issue 035</p>		<p>Page No 111/146</p>	

VOLVO
VOLVO CAR CORPORATION

6C1 Phone As Key

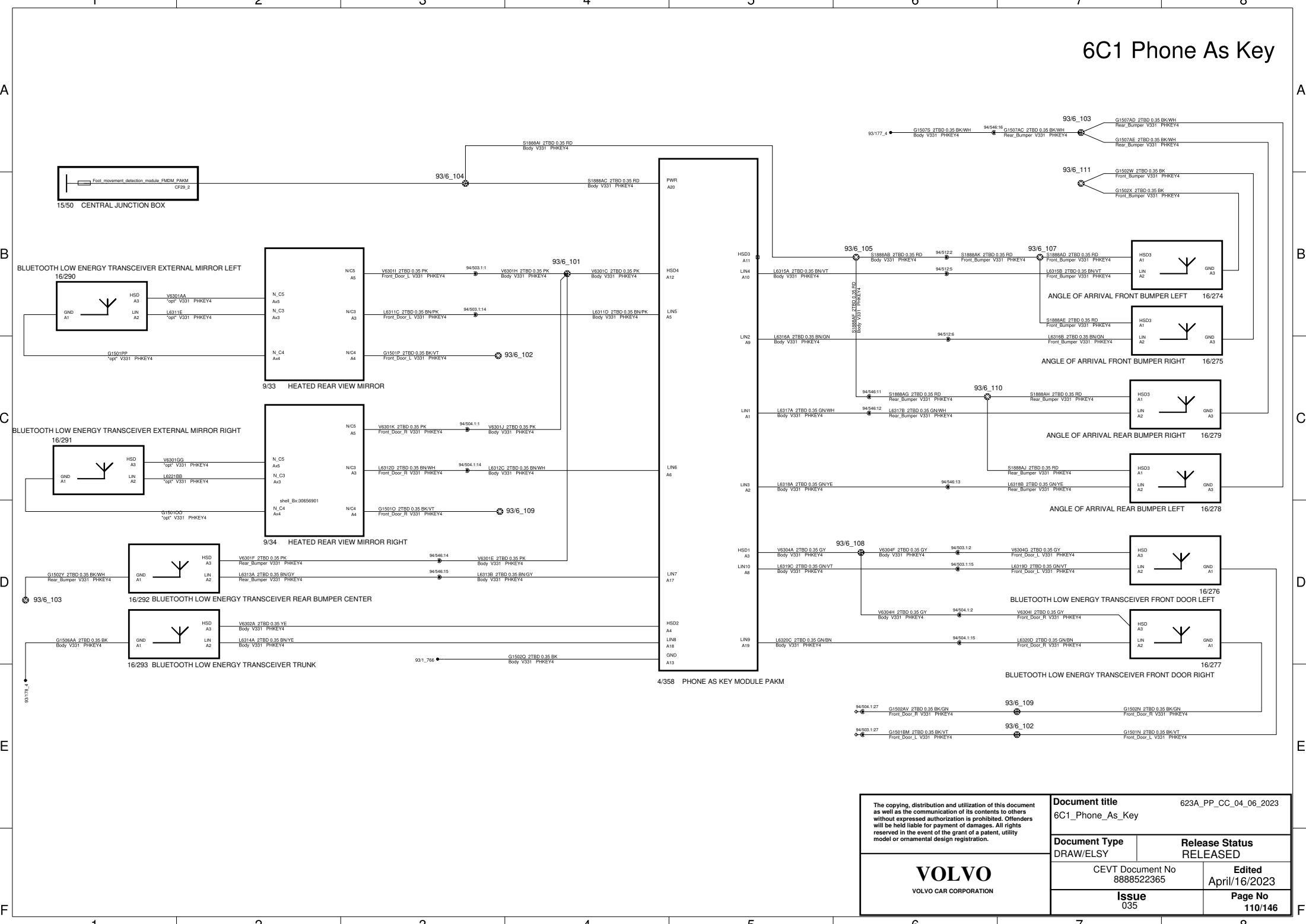

<p>The copying, distribution and utilization of this document as well as the communication of its contents to others without expressed authorization is prohibited. Offenders will be held liable for payment of damages. All rights reserved in the event of the grant of a patent, utility model or ornamental design registration.</p> <p style="text-align: center;">VOLVO VOLVO CAR CORPORATION</p>		<p>Document title 6C1_Phone_As_Key</p>		<p>623A_PP_CC_04_06_2023</p>	
		<p>Document Type DRAW/ELSY</p>	<p>Release Status RELEASED</p>		
		<p>CEVT Document No 8888522365</p>	<p>Edited April/16/2023</p>		
		<p>Issue 035</p>	<p>Page No 110/146</p>		

6D Window manoeuvring 6E Mirror manoeuvring

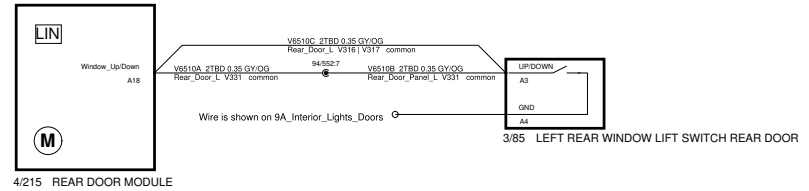
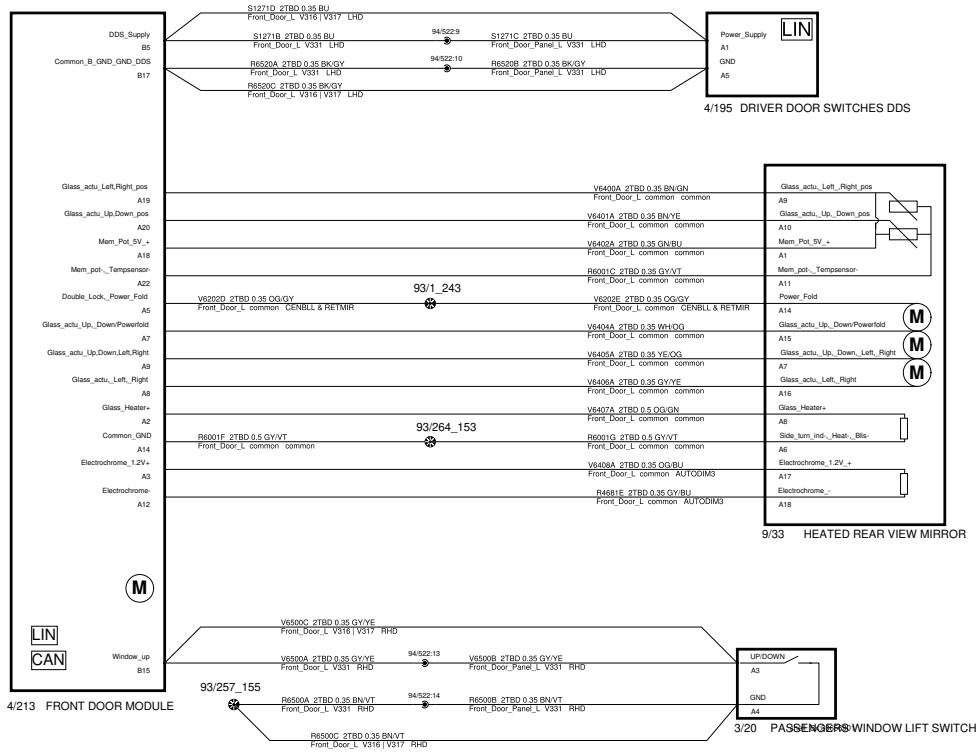

<p>The copying, distribution and utilization of this document as well as the communication of its contents to others without expressed authorization is prohibited. Offenders will be held liable for payment of damages. All rights reserved in the event of the grant of a patent, utility model or ornamental design registration.</p> <p>VOLVO VOLVO CAR CORPORATION</p>	Document title 623A_PP_CC_04_06_2023	
	6D_Window_Manoeuving	
	Document Type DRAW/ELSY	Release Status RELEASED
	Volvo Document No 33445458	Edited April/16/2023
	Issue 035	Page No 112/146

6D Window manoeuvring Right 6E Mirror manoeuvring Right

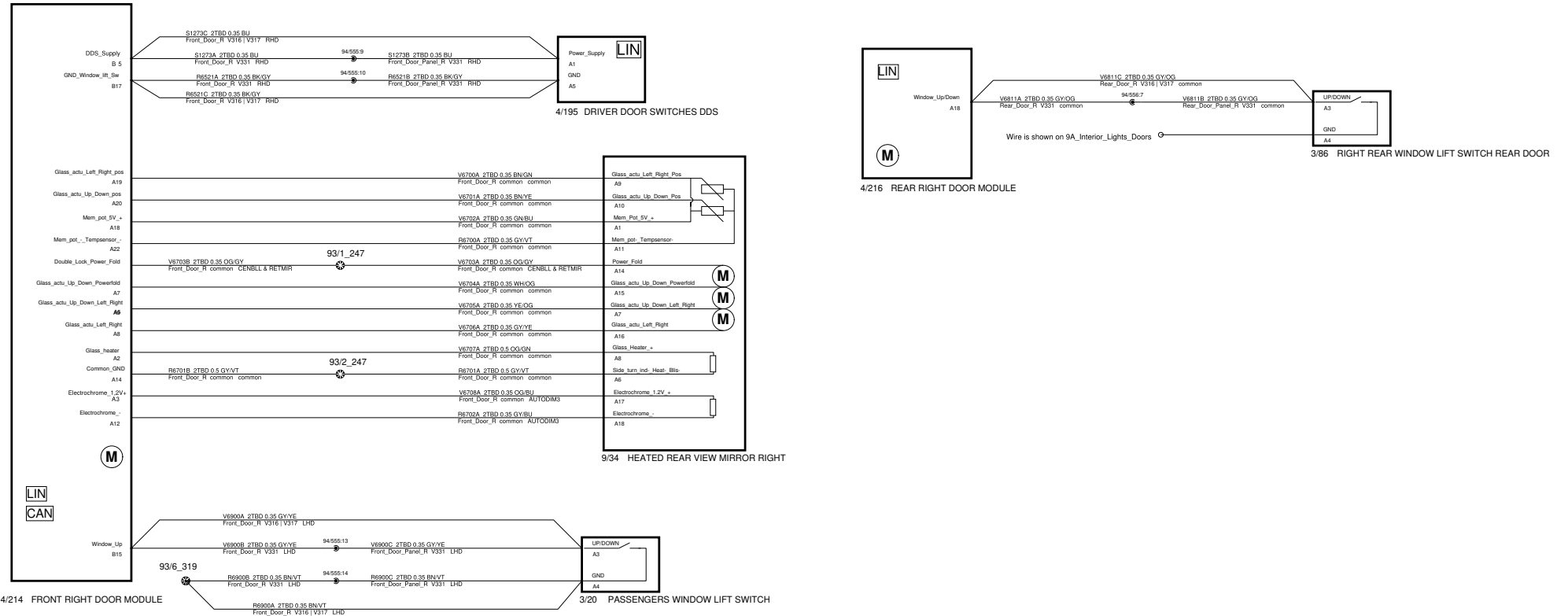

<p>The copying, distribution and utilization of this document as well as the communication of its contents to others without expressed authorization is prohibited. Offenders will be held liable for payment of damages. All rights reserved in the event of the grant of a patent, utility model or ornamental design registration.</p> <p>VOLVO VOLVO CAR CORPORATION</p>	<p>Document title 623A_PP_CC_04_06_2023 6D_Window_Manoeuvring_Right</p>	
	<p>Document Type DRAW/ELSY</p>	<p>Release Status RELEASED</p>
	<p>CEVT Document No 8888522365</p>	<p>Edited April/16/2023</p>
	<p>Issue 035</p>	<p>Page No 113/146</p>

6F Roof Manoeuvring

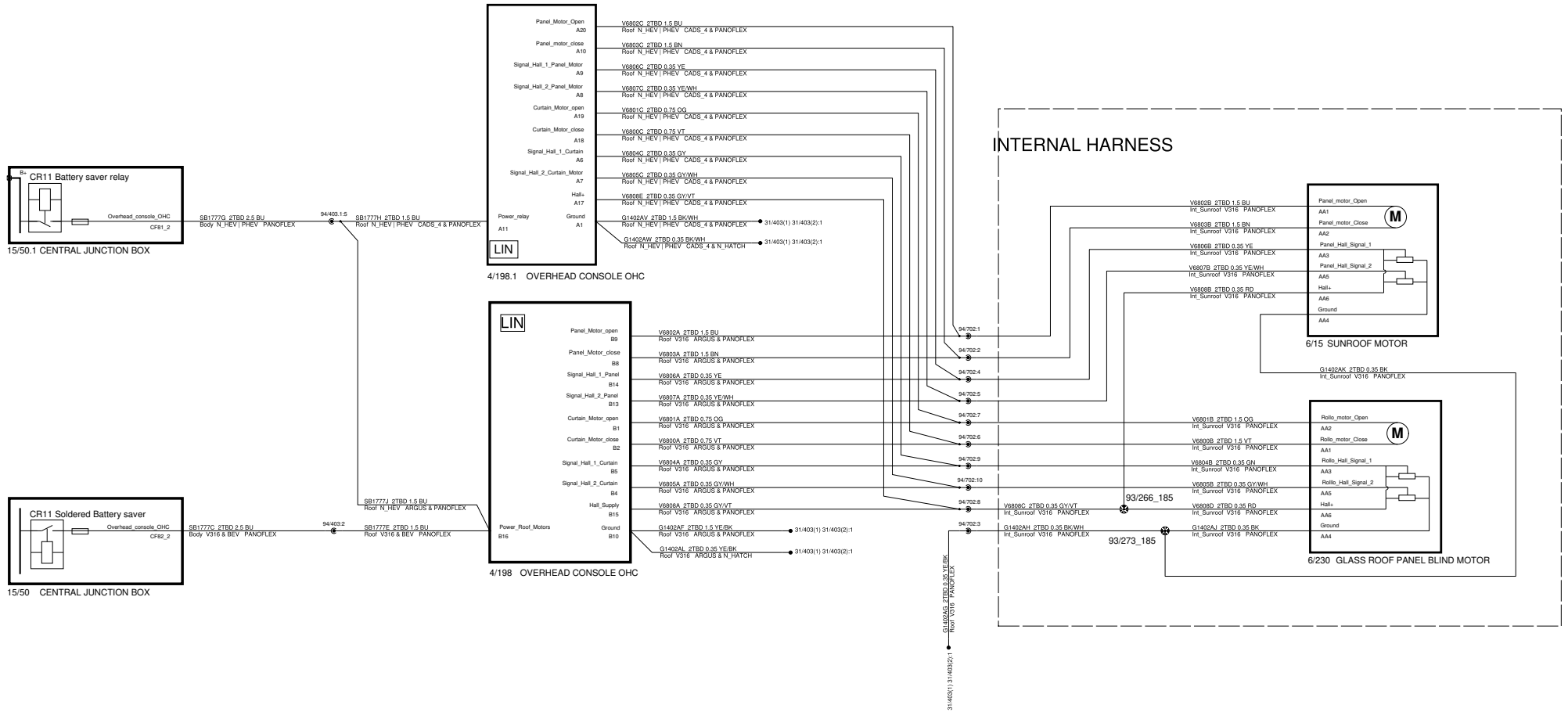

<p>The copying, distribution and utilization of this document as well as the communication of its contents to others without expressed authorization is prohibited. Offenders will be held liable for payment of damages. All rights reserved in the event of the grant of a patent, utility model or ornamental design registration.</p> <p>VOLVO VOLVO CAR CORPORATION</p>	Document title 623A_PP_CC_04_06_2023	
	6F_Roof_Manoeuvring	
	Document Type DRAW/ELSY	Release Status RELEASED
	CEVT Document No 8888522365	Edited June/16/2021
Issue 035	Page No 114/146	

6K Tailgate & Boot Lid Manoeuvring 6N Luggage Concealing

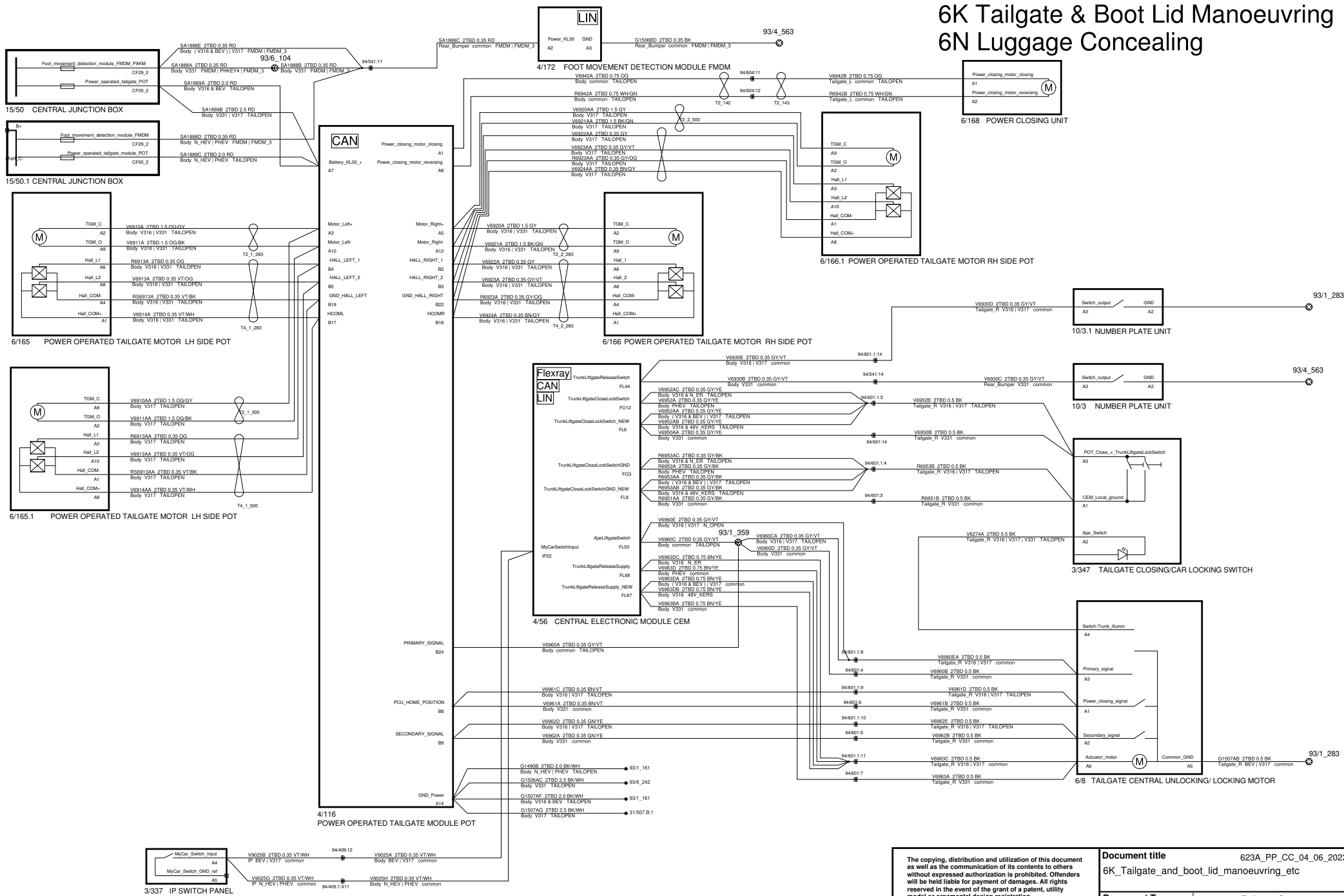

<p>The copying, distribution and utilization of this document as well as the communication of its contents to others without expressed authorization is prohibited. Offenders will be held liable for payment of damages. All rights reserved in the event of the grant of a patent, utility model or ornamental design registration.</p>		<p>Document title 623A_PP_OC_04_06_2023 6K_Tailgate_and_boot_lid_manoeuvring_etc</p>	
<p>Document Type DRAW/ELSY</p>		<p>Release Status RELEASED</p>	
<p>Volvo Document No 33445458</p>		<p>Edited April/16/2023</p>	
<p>Issue 035</p>		<p>Page No 115/146</p>	

VOLVO
VOLVO CAR CORPORATION

6P Voltage Outlet

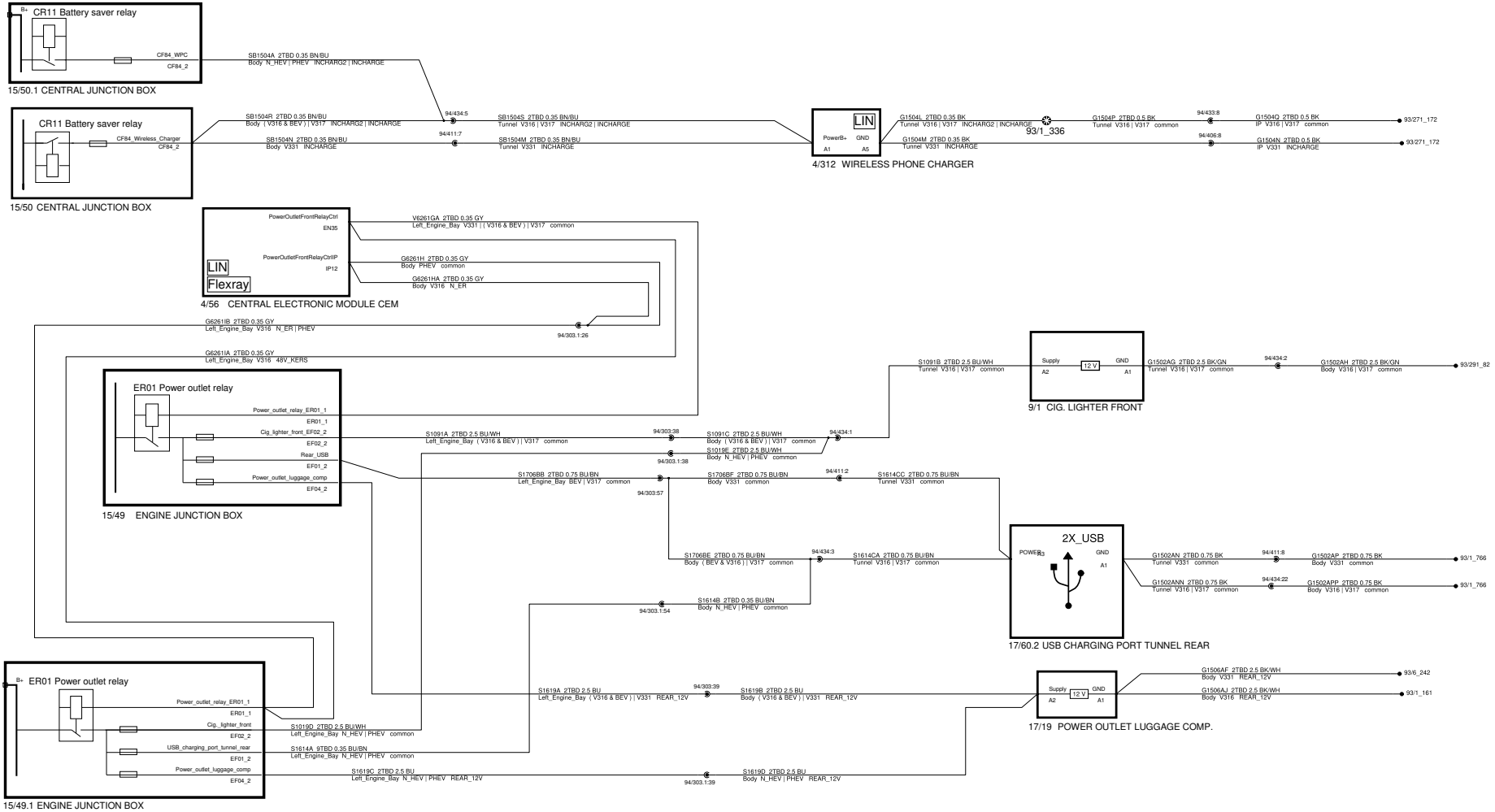

<p>The copying, distribution and utilization of this document as well as the communication of its contents to others without expressed authorization is prohibited. Offenders will be held liable for payment of damages. All rights reserved in the event of the grant of a patent, utility model or ornamental design registration.</p> <p>VOLVO VOLVO CAR CORPORATION</p>	Document title		623A_PP_CC_04_06_2023
	6P_Voltage_outlet		
	Document Type	Release Status	
	DRAW/ELSY	RELEASED	
Volvo Document No 33445458		Edited April/16/2023	
Issue 035		Page No 116/146	

7A External Amplifier

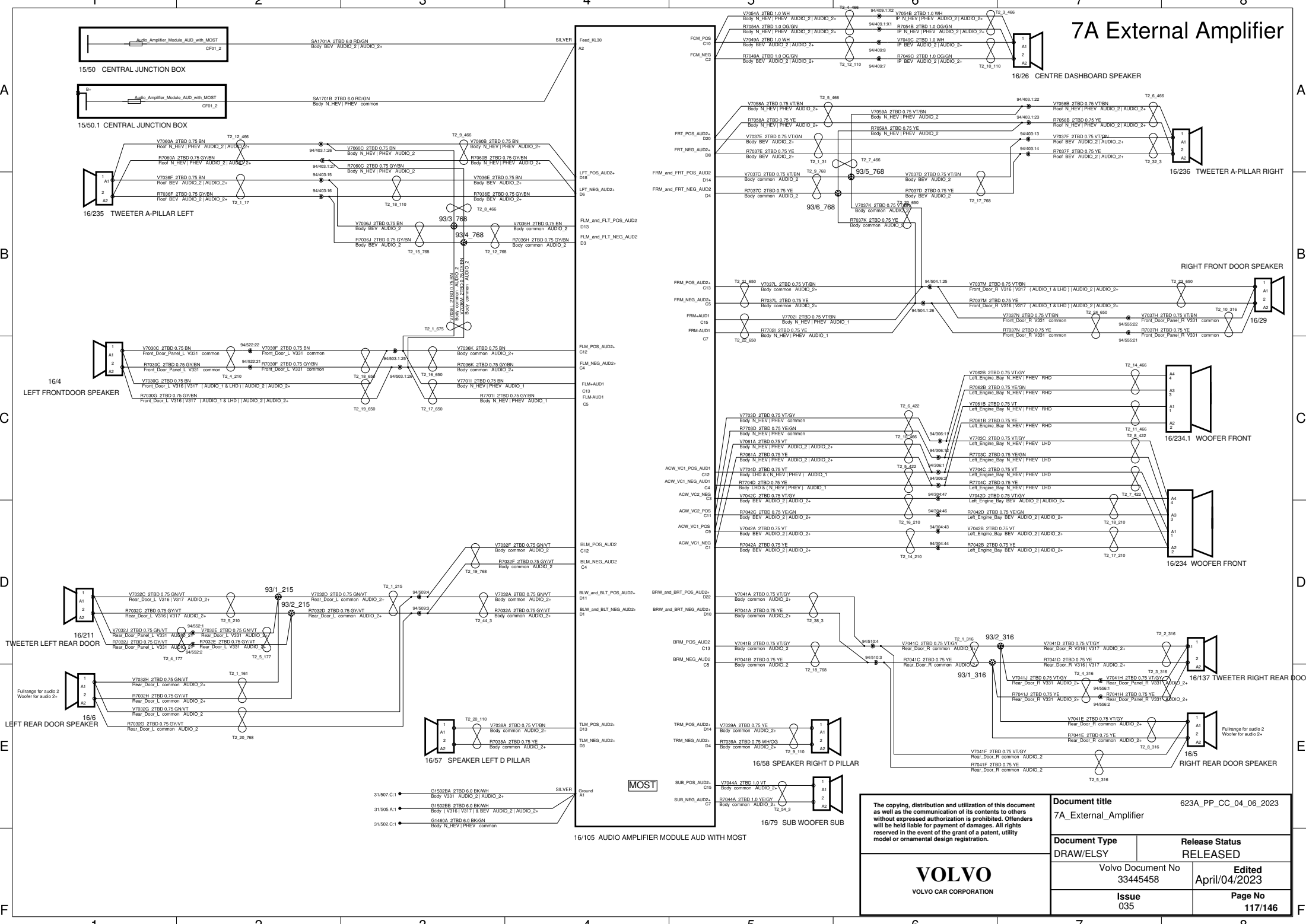

The copying, distribution and utilization of this document as well as the communication of its contents to others without expressed authorization is prohibited. Offenders will be held liable for payment of damages. All rights reserved in the event of the grant of a patent, utility model or ornamental design registration.		Document title 7A_External_Amplifier	623A_PP_CC_04_06_2023
Document Type DRAW/ELSY	Release Status RELEASED		
Volvo Document No 33445458	Edited April/04/2023		
Issue 035	Page No 117/146		



7A Infotainment IHU 4.0/iCUP

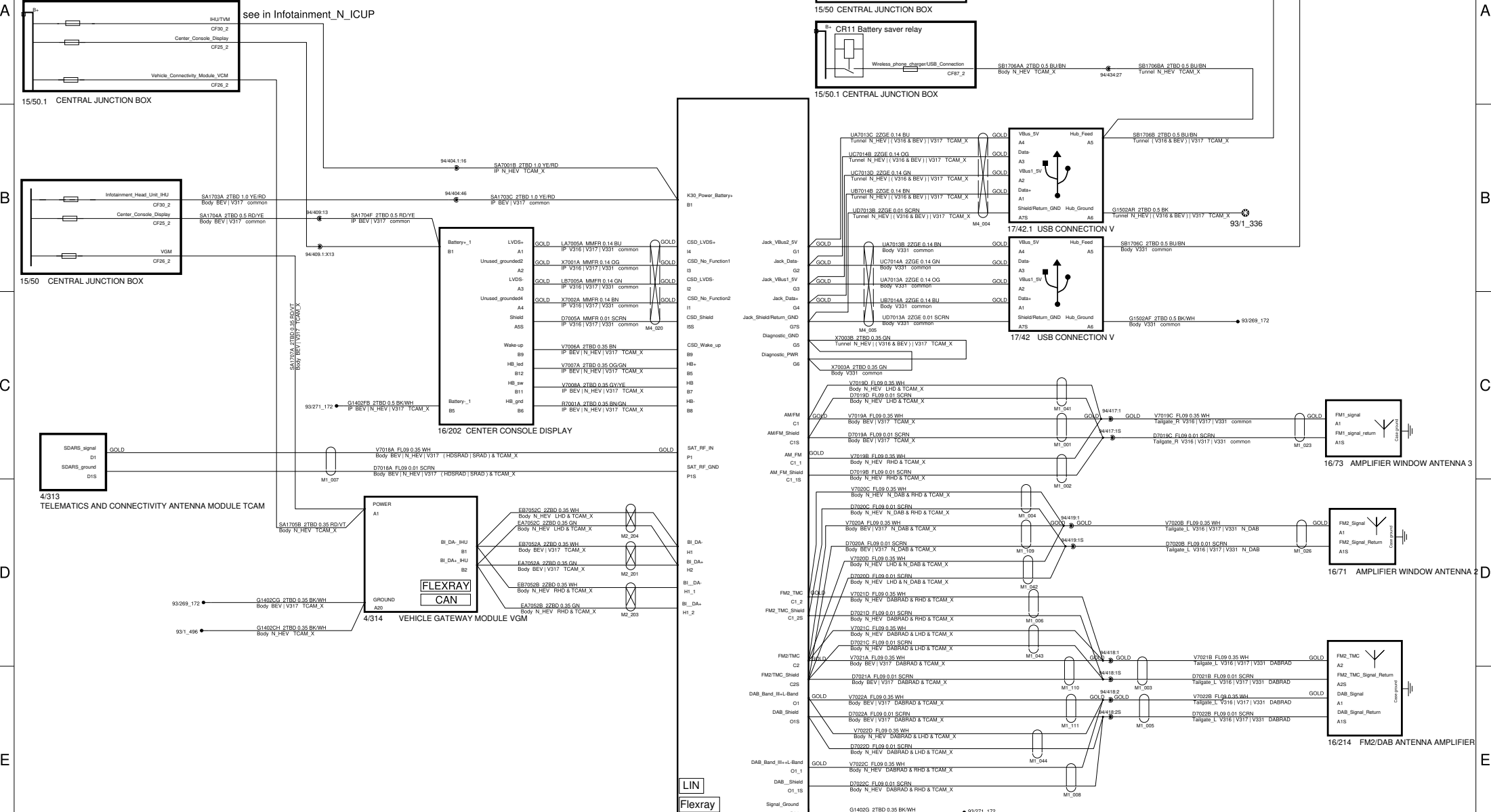

<p>The copying, distribution and utilization of this document as well as the communication of its contents to others without expressed authorization is prohibited. Offenders will be held liable for payment of damages. All rights reserved in the event of the grant of a patent, utility model or ornamental design registration.</p>		<p>Document title 7A_Infotainment</p>		<p>623A_PP_CC_04_06_2023</p>	
<p>Document Type DRAW/ELSY</p>		<p>Release Status RELEASED</p>		<p>Edited April/18/2023</p>	
<p>Issue 035</p>		<p>Volvo Document No 33445458</p>		<p>Page No 118/146</p>	



4/185 - INFOTAINMENT HEAD UNIT IHU

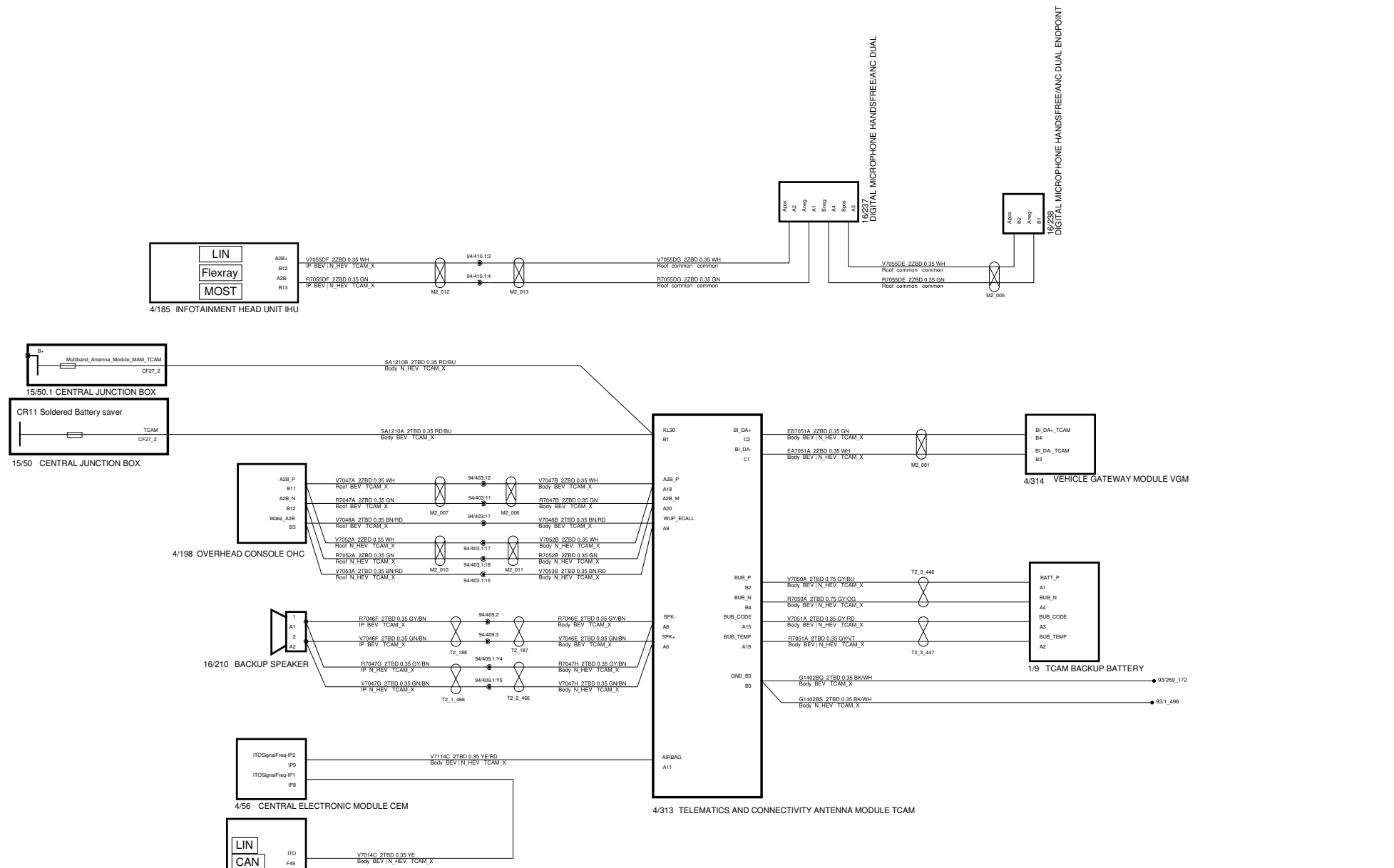

<p>The copying, distribution and utilization of this document as well as the communication of its contents to others without expressed authorization is prohibited. Offenders will be held liable for payment of damages. All rights reserved in the event of the grant of a patent, utility model or ornamental design registration.</p> <p>VOLVO VOLVO CAR CORPORATION</p>	Document title 623A_PP_CC_04_06_2023	
	7B_Telematics_ICUP	
	Document Type DRAW/ELSY	Release Status RELEASED
	Volvo Document No 33445458	Edited April/18/2023
Issue 035	Page No 120/146	

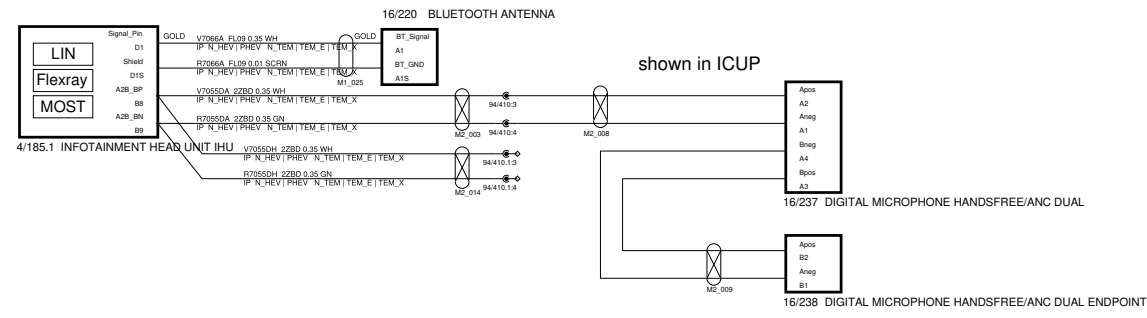
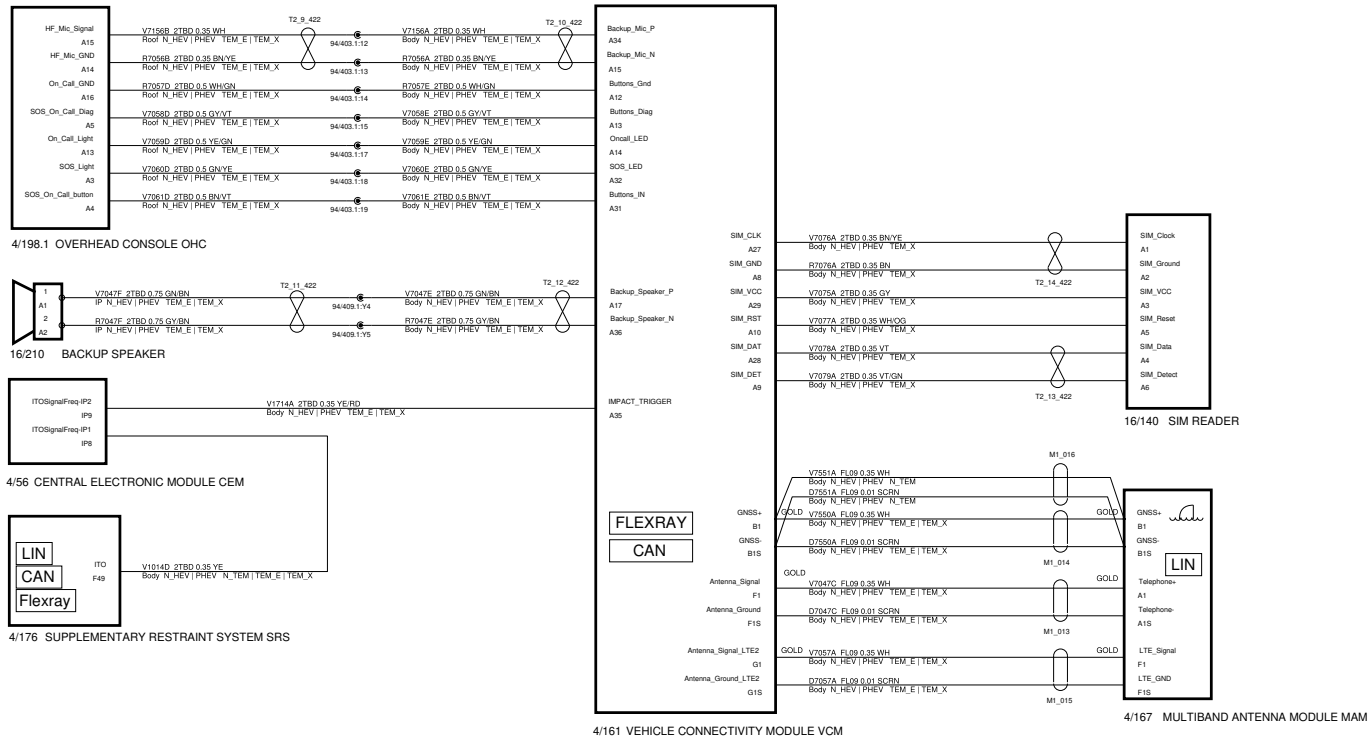

7C DSRC IHU 3.0/_NiCUP

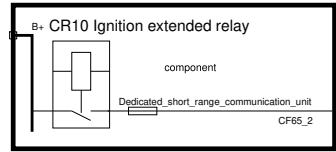

15/50.1 CENTRAL JUNCTION BOX

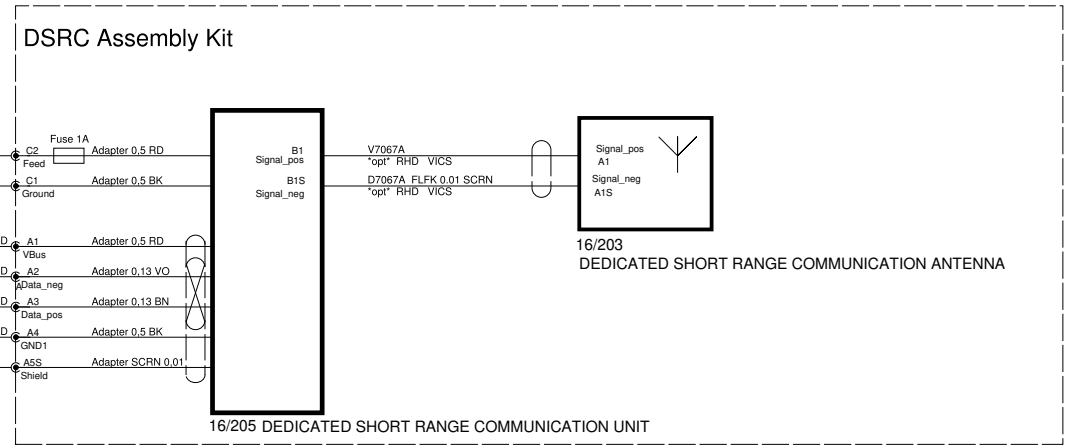

16/205 DEDICATED SHORT RANGE COMMUNICATION UNIT

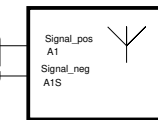

16/203 DEDICATED SHORT RANGE COMMUNICATION ANTENNA

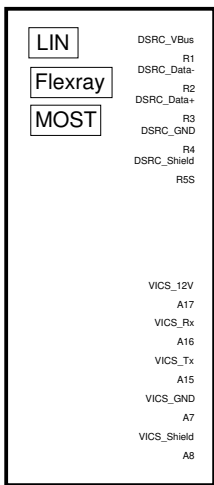

4/185.1 INFOTAINMENT HEAD UNIT IHU

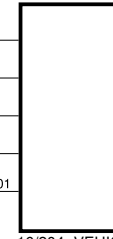

16/204 VEHICLE INFORMATION AND COMMUNICATION SYSTEM ANTENNA

<p>The copying, distribution and utilization of this document as well as the communication of its contents to others without expressed authorization is prohibited. Offenders will be held liable for payment of damages. All rights reserved in the event of the grant of a patent, utility model or ornamental design registration.</p> <p>VOLVO VOLVO CAR CORPORATION</p>	<p>Document title 623A_PP_CC_04_06_2023 7C_DSRC_N_iCUP</p>	
	<p>Document Type DRAW/ELSY</p>	<p>Release Status RELEASED</p>
	<p>CEVT Document No 8888522365</p>	<p>Edited April/18/2023</p>
	<p>Issue 035</p>	<p>Page No 123/146</p>

7C DSRC IHU 4.0/iCUP

A

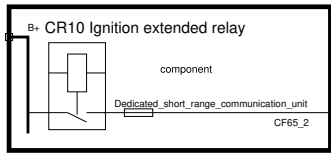

15/50.1 CENTRAL JUNCTION BOX

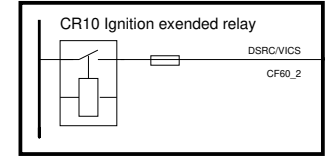

15/50 CENTRAL JUNCTION BOX

B

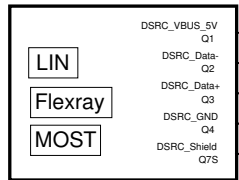

4/185
INFOTAINMENT HEAD UNIT IHU

C

DSRC Assembly Kit

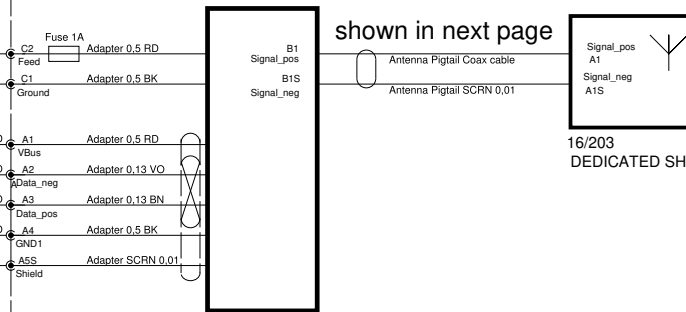

16/205
DEDICATED SHORT RANGE COMMUNICATION UNIT

D

DSRC Assembly Kit

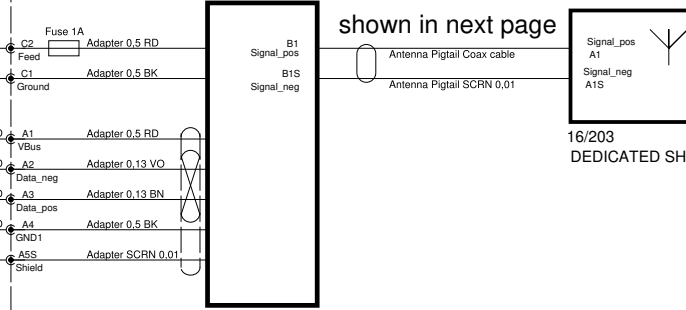

16/205.1
DEDICATED SHORT RANGE COMMUNICATION UNIT

E

<p>The copying, distribution and utilization of this document as well as the communication of its contents to others without expressed authorization is prohibited. Offenders will be held liable for payment of damages. All rights reserved in the event of the grant of a patent, utility model or ornamental design registration.</p> <p>VOLVO VOLVO CAR CORPORATION</p>	<p>Document title 623A_PP_CC_04_06_2023 7C_DSRC</p>	
	<p>Document Type DRAW/ELSY</p>	<p>Release Status RELEASED</p>
	<p>CEVT Document No 8888522365</p>	<p>Edited April/18/2023</p>
	<p>Issue 035</p>	<p>Page No 122/146</p>

1

2

3

4

5

7F Electronic Toll Collection

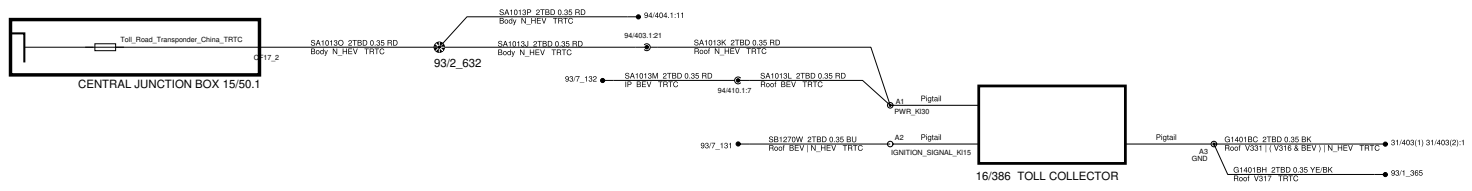

<p>The copying, distribution and utilization of this document as well as the communication of its contents to others without expressed authorization is prohibited. Offenders will be held liable for payment of damages. All rights reserved in the event of the grant of a patent, utility model or ornamental design registration.</p> <p>VOLVO VOLVO CAR CORPORATION</p>	Document title 623A_PP_CC_04_06_2023	
	7F_Electronic_Toll_Collection	
	Document Type DRAW/ELSY	Release Status RELEASED
	CEVT Document No 8888522365	Edited April/18/2023
Issue 035	Page No 124/146	

8A Exterior Light Front

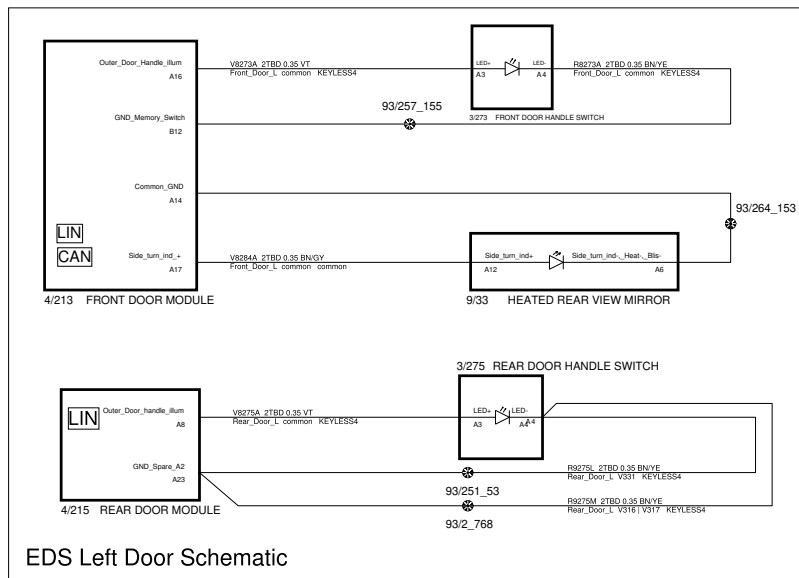
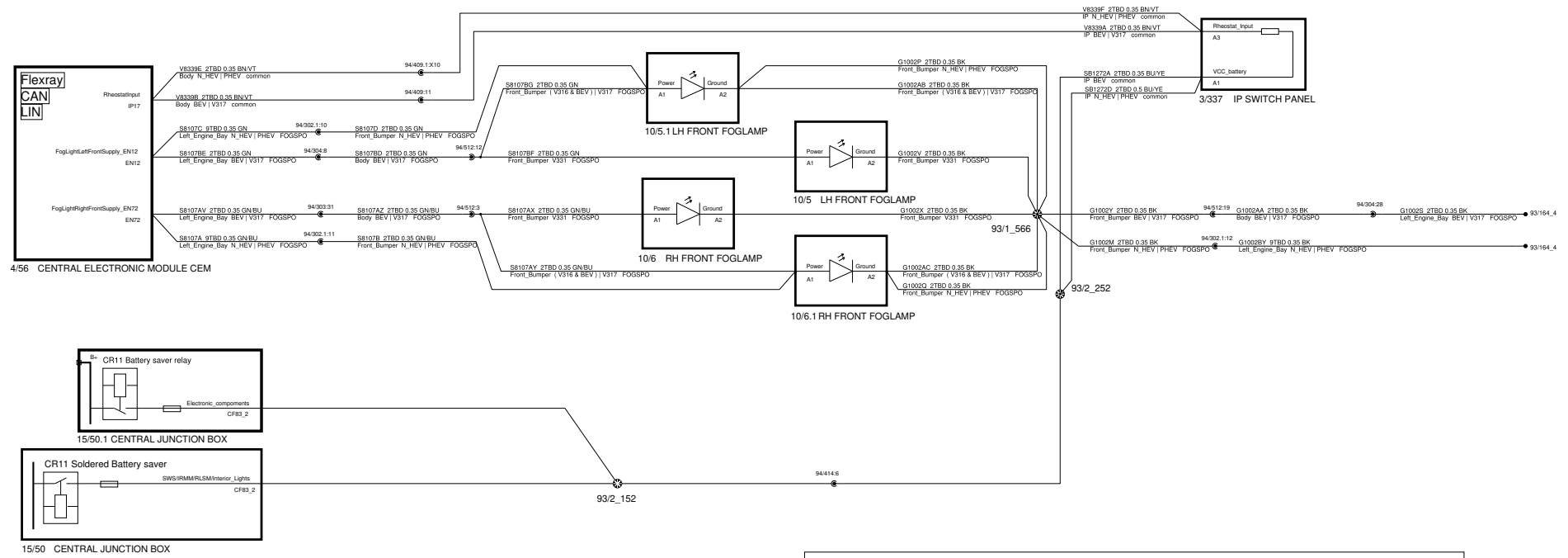

EDS Left Door Schematic

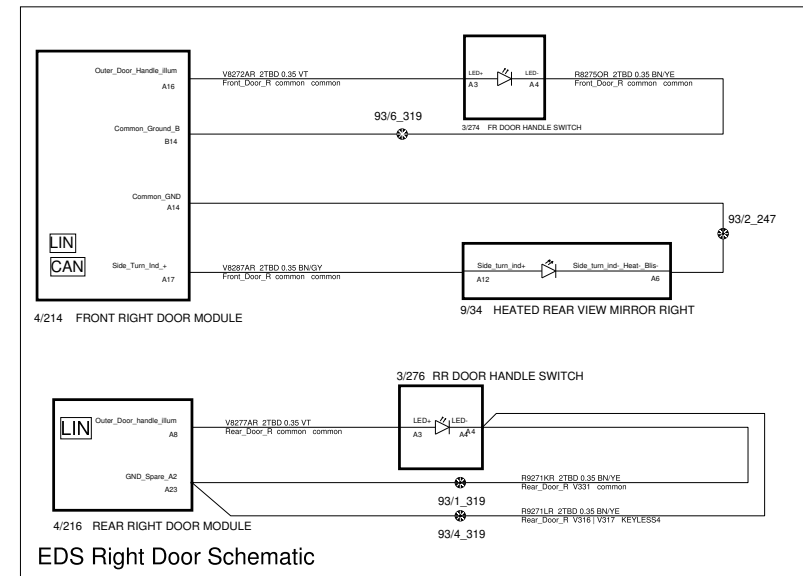

EDS Right Door Schematic

The copying, distribution and utilization of this document as well as the communication of its contents to others without expressed authorization is prohibited. Offenders will be held liable for payment of damages. All rights reserved in the event of the grant of a patent, utility model or ornamental design registration.

VOLVO

VOLVO CAR CORPORATION

Document title
8A_Exterior_Light_Front

623A_PP_CC_04_06_2023

Document Type

Release Status

DRAW/ELSY

RELEASED

Volvo Document No

33445458

Edited

April/18/2023

Issue

035

Page No

125/146

8A Exterior Light LED Front

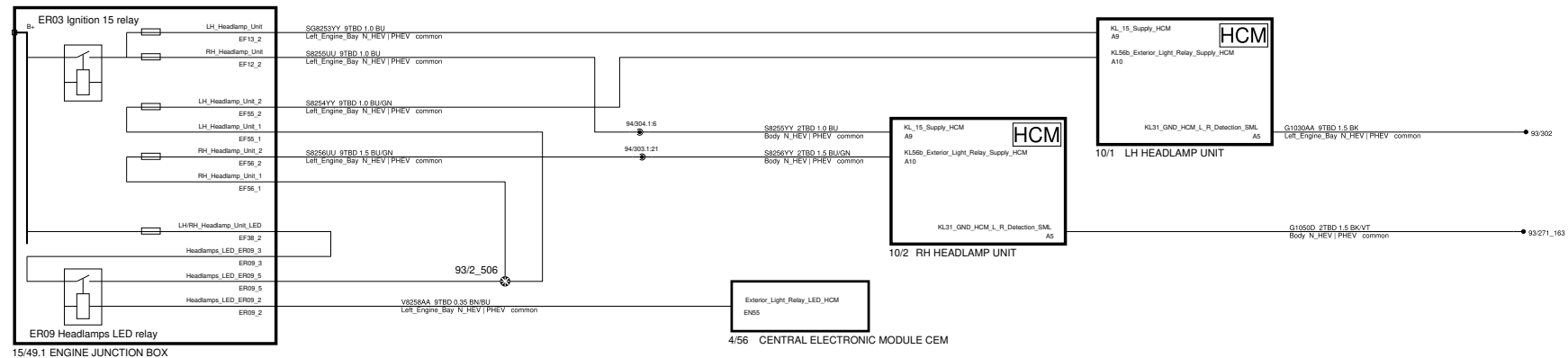
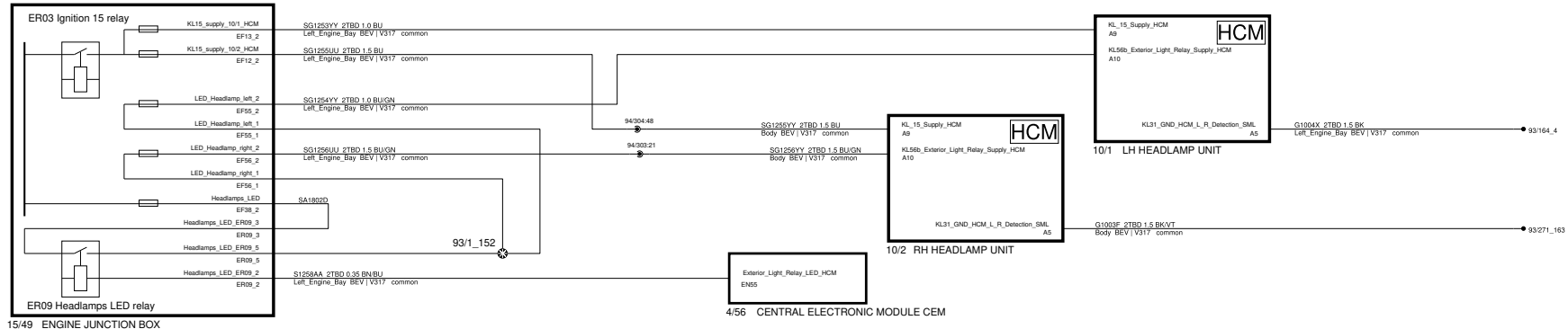

<p>The copying, distribution and utilization of this document as well as the communication of its contents to others without expressed authorization is prohibited. Offenders will be held liable for payment of damages. All rights reserved in the event of the grant of a patent, utility model or ornamental design registration.</p> <p>VOLVO</p> <p>VOLVO CAR CORPORATION</p>	Document title 623A_PP_CC_04_06_2023	
	8A_Exterior_Light_LED_Front	
	Document Type	Release Status
	Volvo Document No 33445458	RELEASED
Issue 035	Edited April/18/2023	
	Page No 126/146	

8A Exterior Light Rear V316

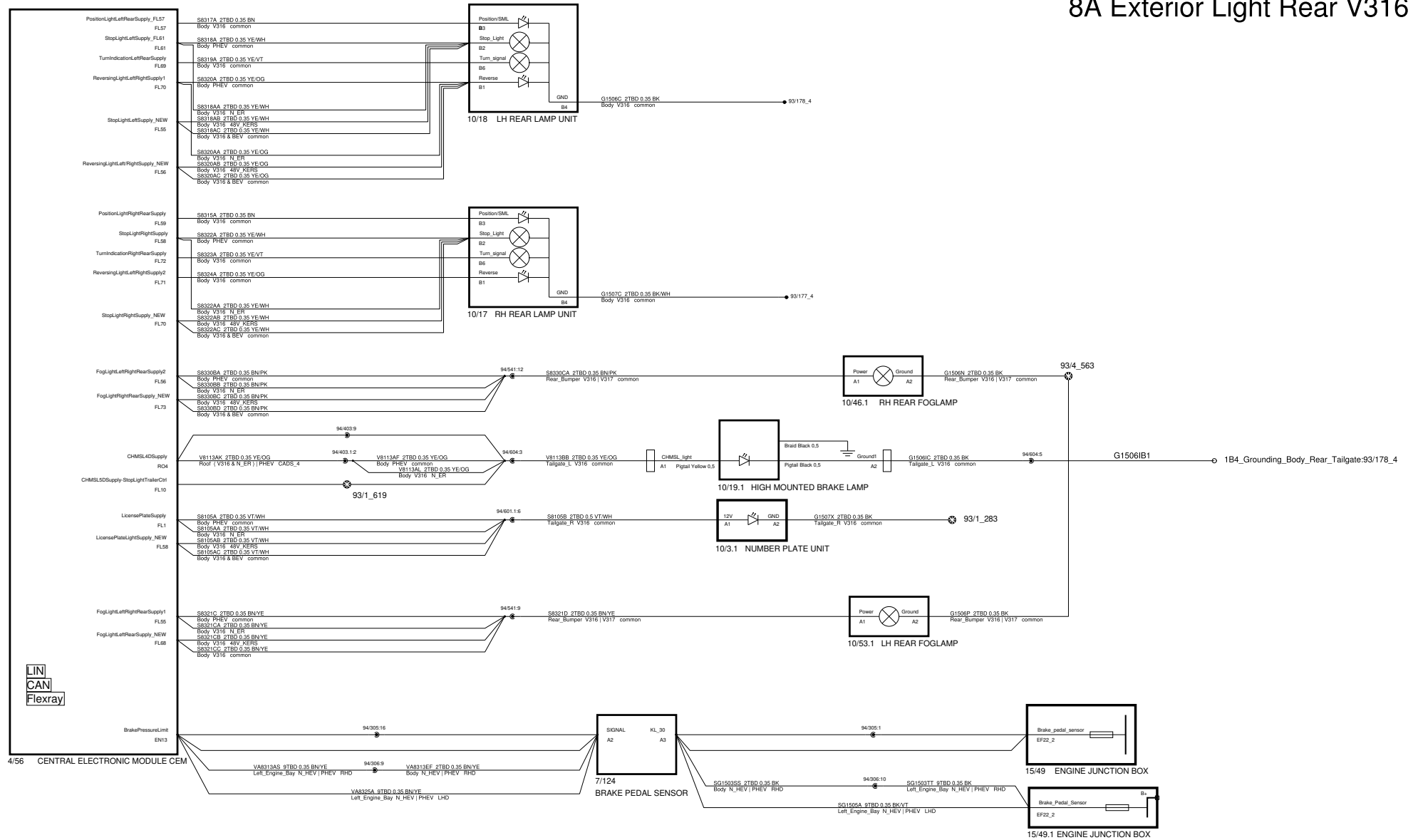

<p>The copying, distribution and utilization of this document as well as the communication of its contents to others without expressed authorization is prohibited. Offenders will be held liable for payment of damages. All rights reserved in the event of the grant of a patent, utility model or ornamental design registration.</p>		<p>Document title 623A_PP_CC_04_06_2023 8A_Exterior_Light_Rear_V316</p>	
		<p>Document Type DRAW/ELSY</p>	<p>Release Status RELEASED</p>
<p>VOLVO VOLVO CAR CORPORATION</p>		<p>CEVT Document No 8888522365</p>	<p>Edited April/18/2023</p>
		<p>Issue 035</p>	<p>Page No 127/146</p>

8A Exterior Light Rear V331

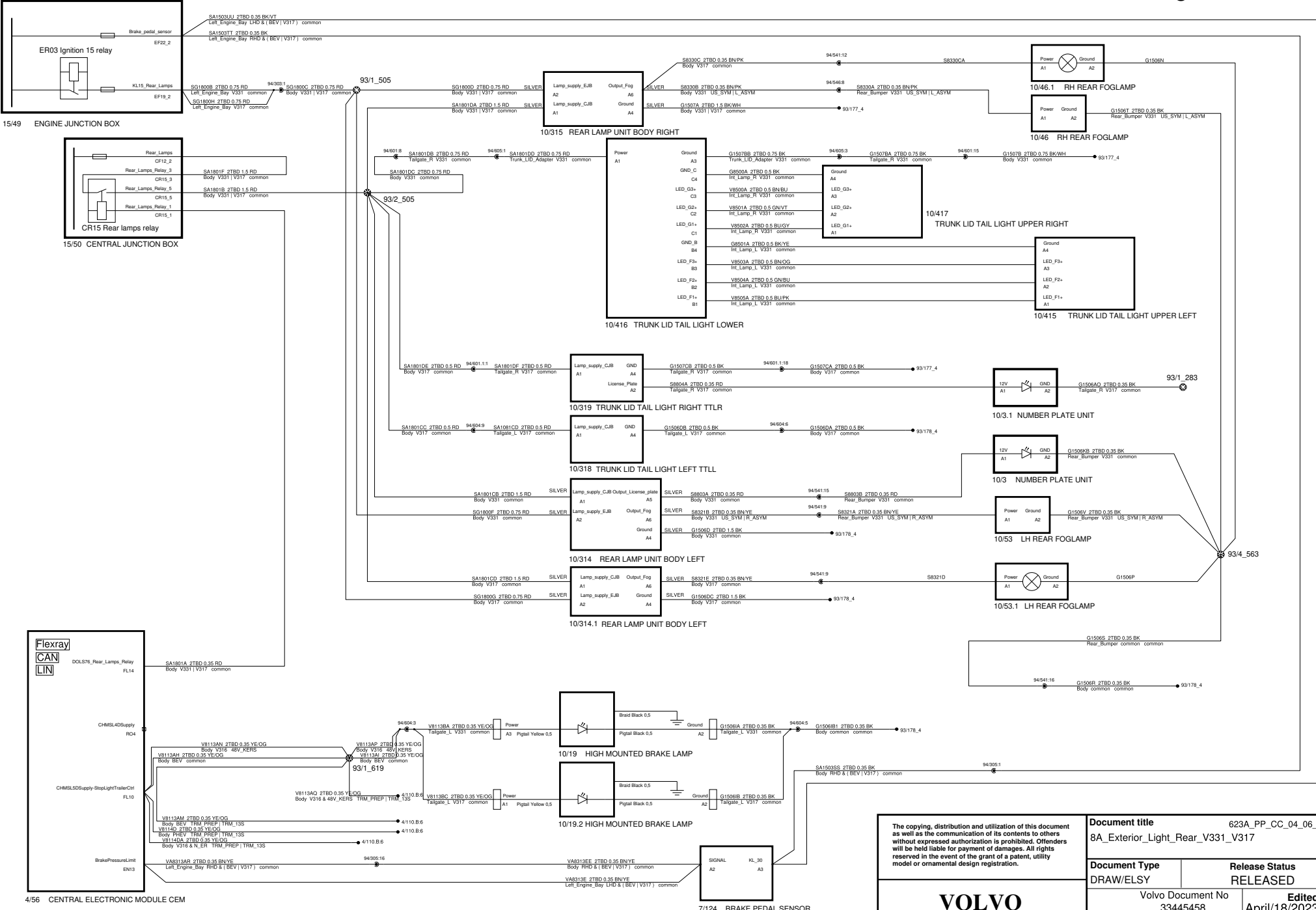

<p>The copying, distribution and utilization of this document as well as the communication of its contents to others without expressed authorization is prohibited. Offenders will be held liable for payment of damages. All rights reserved in the event of the grant of a patent, utility model or ornamental design registration.</p> <p>VOLVO VOLVO CAR CORPORATION</p>	<p>Document title: 623A_PP_CC_04_06_2023 8A_Exterior_Light_Rear_V331_V317</p>	
	<p>Document Type: DRAW/ELSY</p>	<p>Release Status: RELEASED</p>
	<p>Volvo Document No: 33445458</p>	<p>Edited: April/18/2023</p>
	<p>Issue: 035</p>	<p>Page No: 128/146</p>

A

B

C

D

E

F

A

B

C

D

E

F

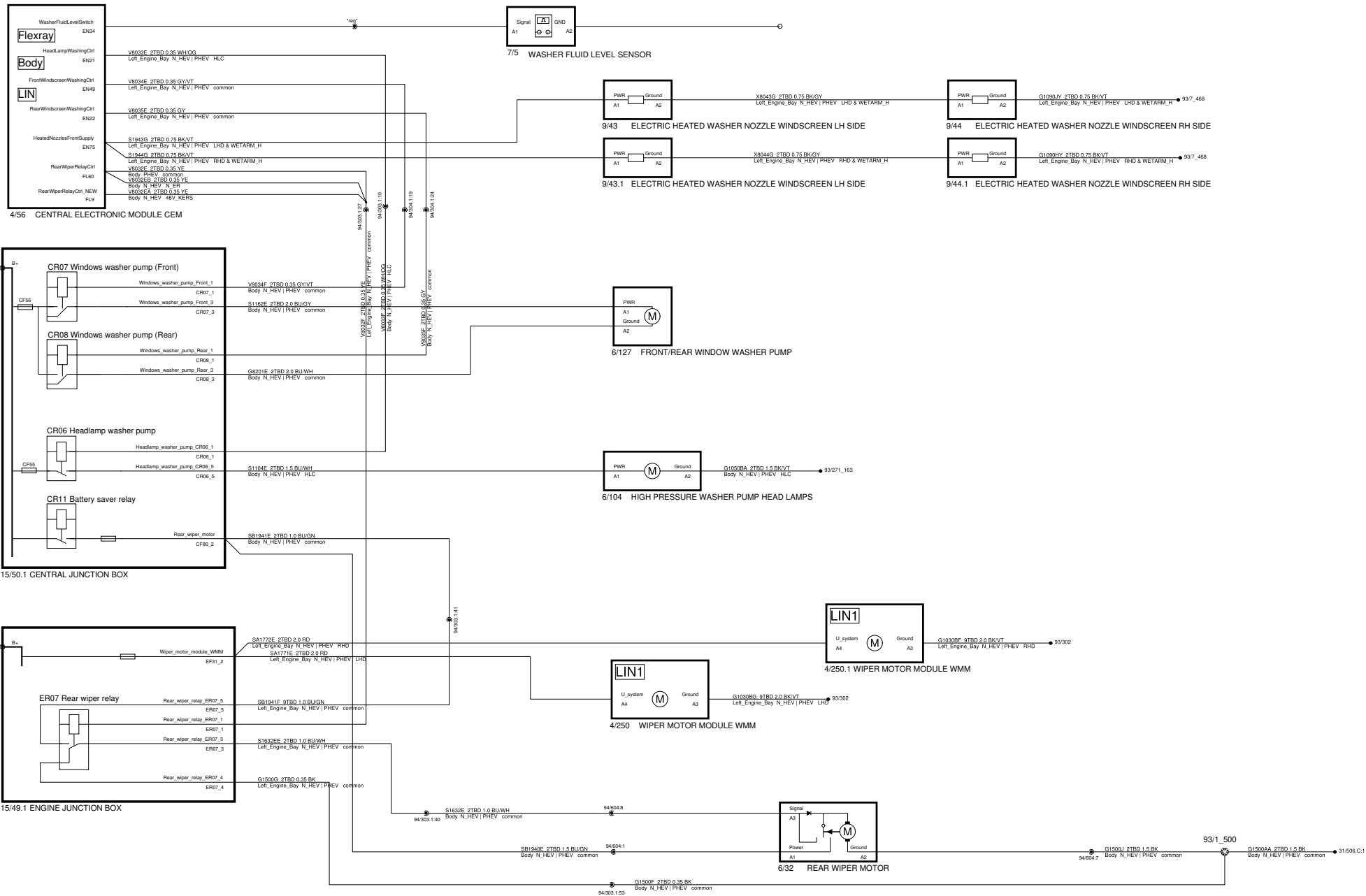

1

2

3

4

5

6

7

8

8K Lamp cleaning control 8H Windscreen cleaning control 8J Rear window cleaning

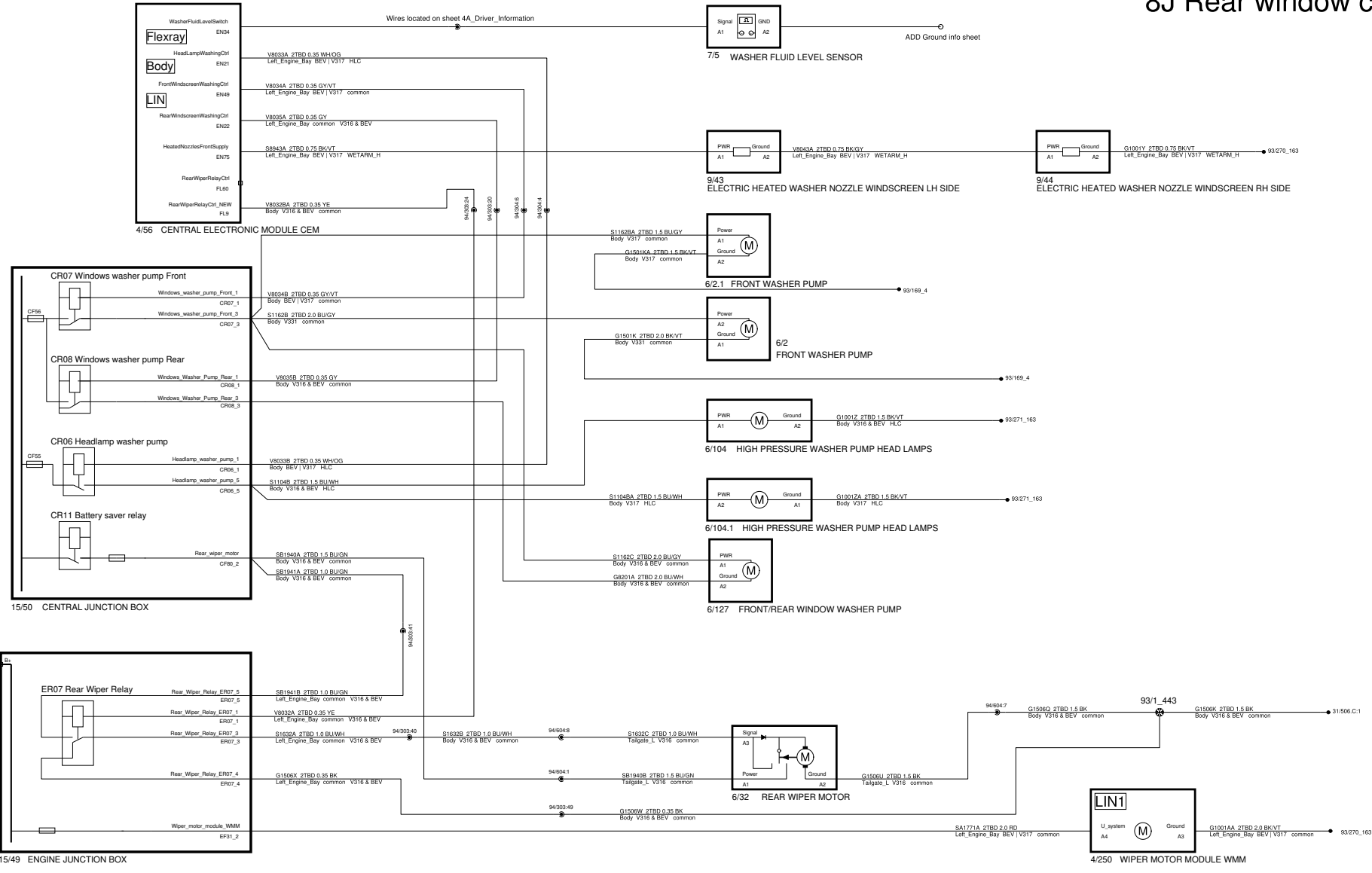

<p>The copying, distribution and utilization of this document as well as the communication of its contents to others without expressed authorization is prohibited. Offenders will be held liable for payment of damages. All rights reserved in the event of the grant of a patent, utility model or ornamental design registration.</p>		<p>Document title 623A_PP_CC_04_06_2023 8K_8H_8J_Lamp_windscreen_rear_window_cleaning</p>	
		<p>Document Type DRAW/ELSY</p>	<p>Release Status RELEASED</p>
<p>VOLVO VOLVO CAR CORPORATION</p>		<p>Volvo Document No 33445458</p>	<p>Edited April/18/2023</p>
		<p>Issue 035</p>	<p>Page No 129/146</p>

8N Windscreen defroster control 8L Rear window defroster control

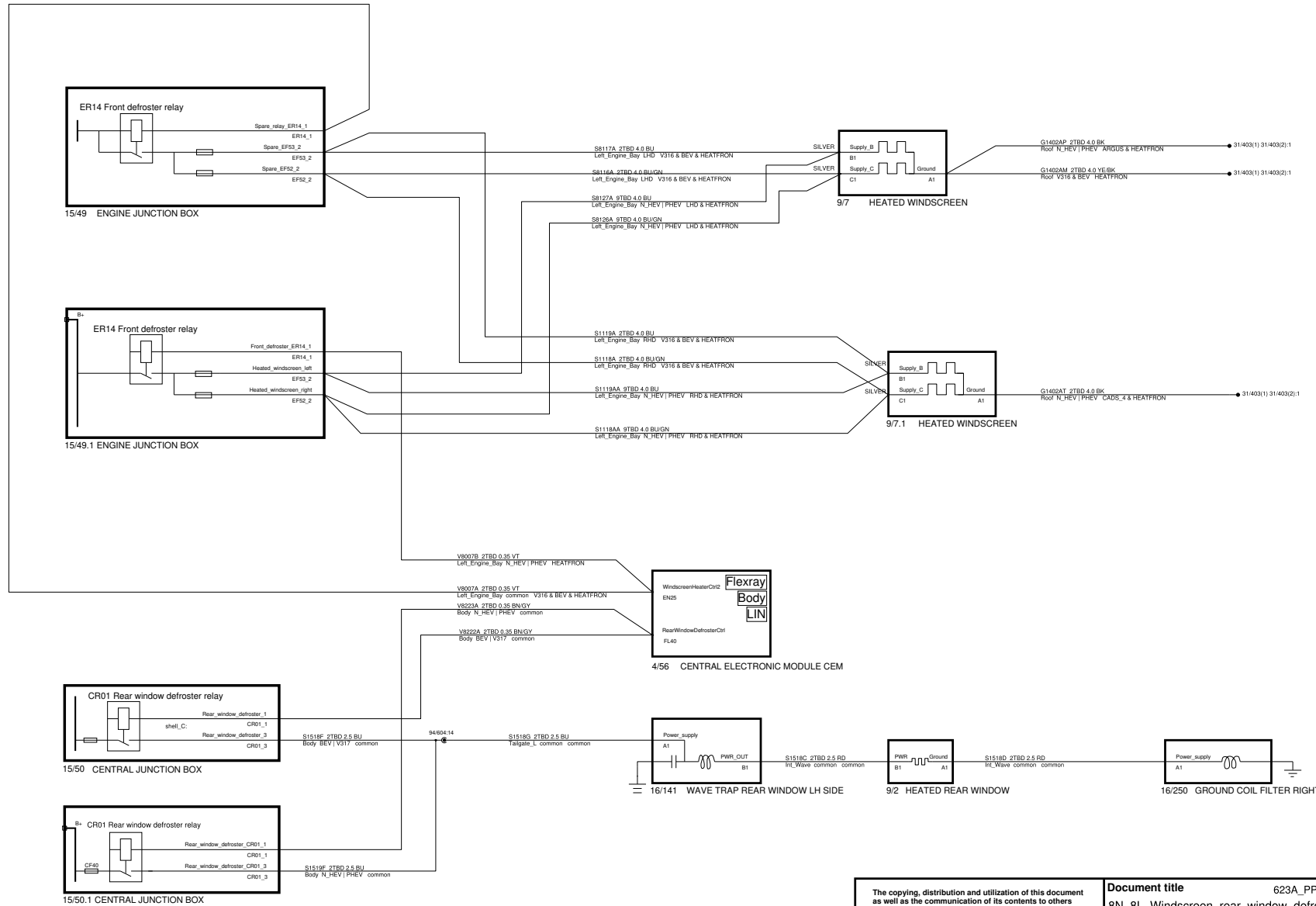

The copying, distribution and utilization of this document as well as the communication of its contents to others without expressed authorization is prohibited. Offenders will be held liable for payment of damages. All rights reserved in the event of the grant of a patent, utility model or ornamental design registration.

VOLVO
VOLVO CAR CORPORATION

Document title 8N_8L_Windscreen_rear_window_defroster		623A_PP_CC_04_06_2023	
Document Type DRAW/ELSY	Release Status RELEASED		
Volvo Document No 33445458	Edited April/18/2023		
Issue 035	Page No 131/146		

8P Sound Signaling

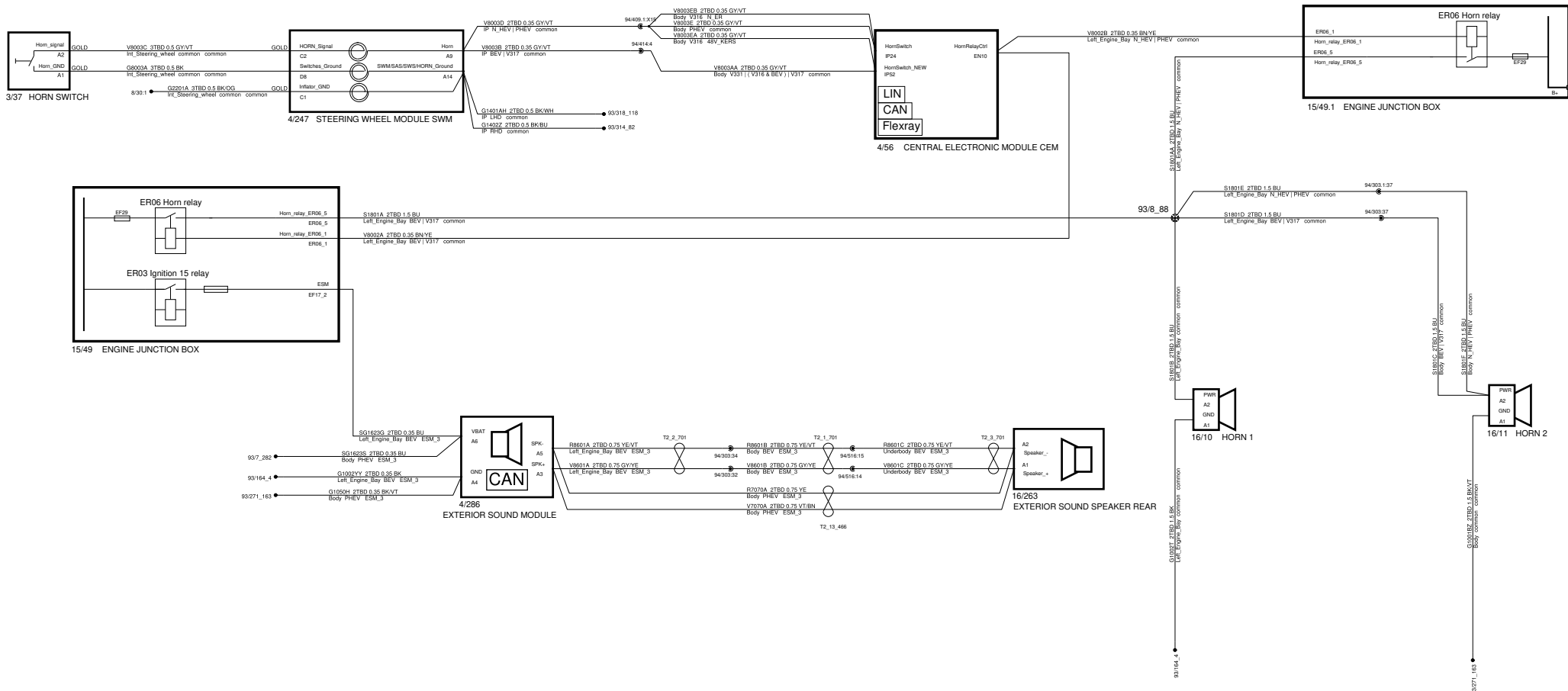

VOLVO VOLVO CAR CORPORATION	Document title 8P_Sound_signaling		623A_PP_CC_04_06_2023
	Document Type DRAW/ELSY		Release Status RELEASED
	Volvo Document No 33445458		Edited April/18/2023
	Issue 035		Page No 132/146

9A Interior Lights

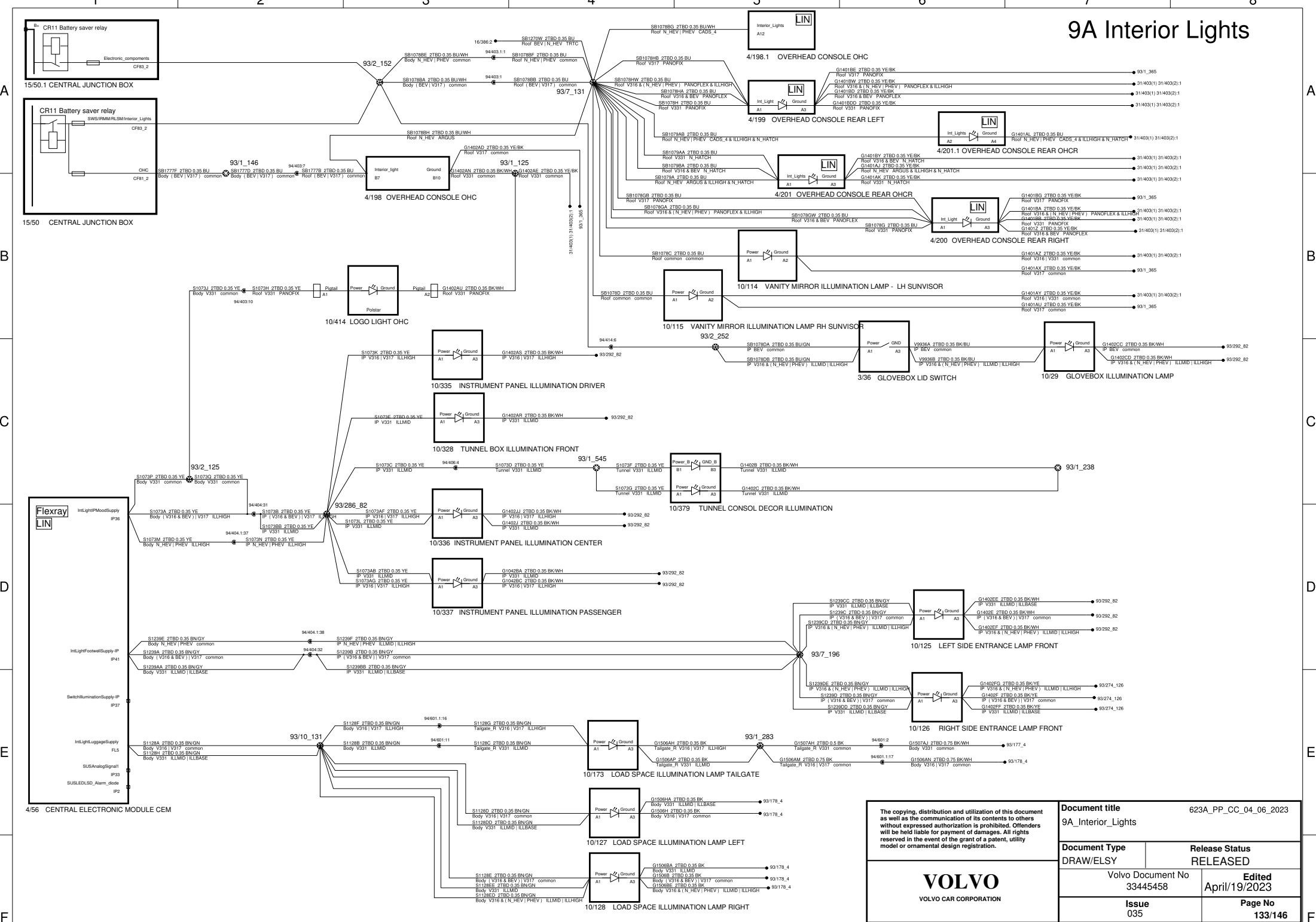

<p>The copying, distribution and utilization of this document as well as the communication of its contents to others without expressed authorization is prohibited. Offenders will be held liable for payment of damages. All rights reserved in the event of the grant of a patent, utility model or ornamental design registration.</p>		Document title	623A_PP_CC_04_06_2023
		9A_Interior_Lights	
Document Type	Release Status		
DRAW/ELSY	RELEASED		
Volvo Document No		Edited	
33445458		April/19/2023	
Issue		Page No	
035		133/146	



9A Interior Lights Doors

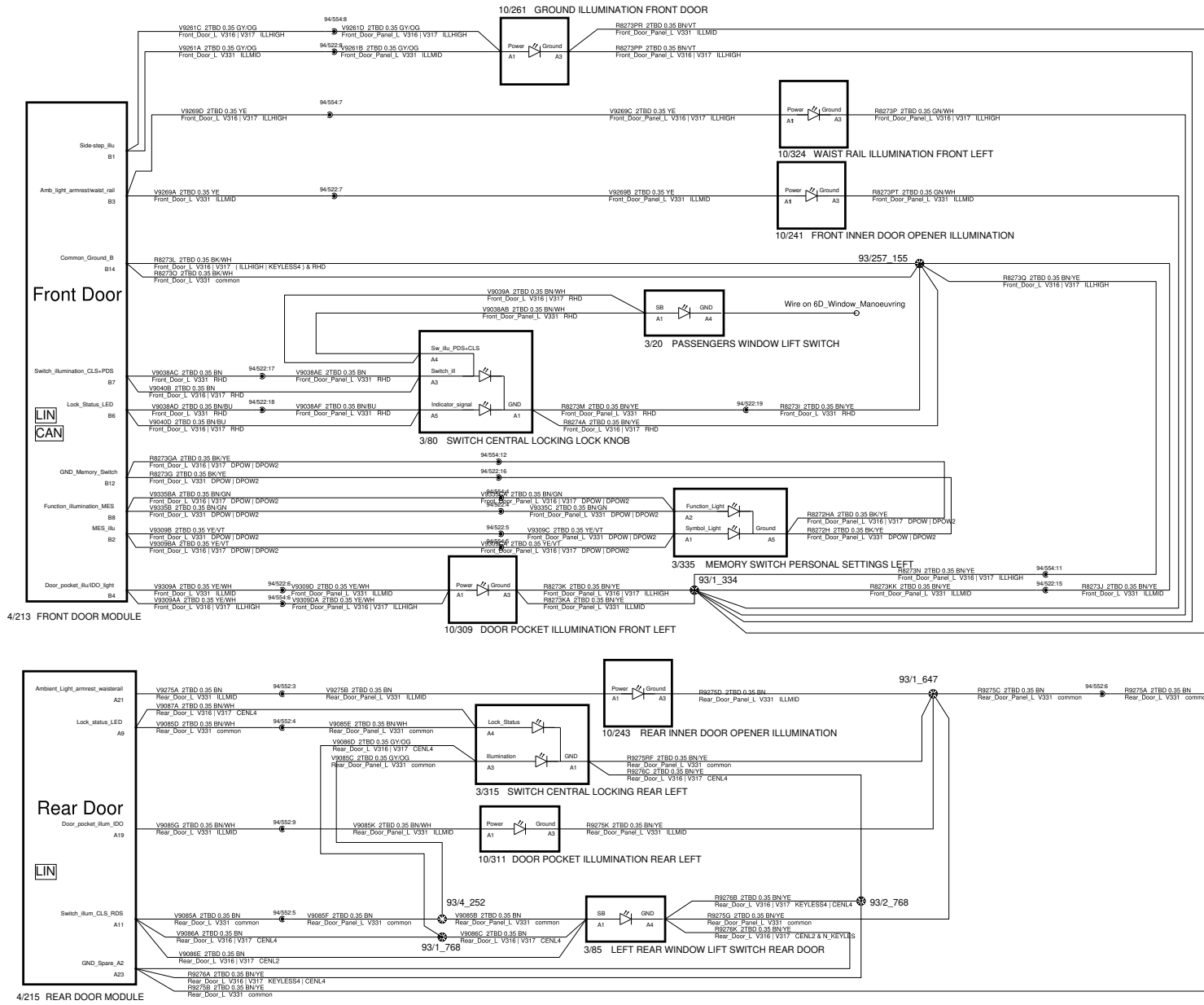

<p>The copying, distribution and utilization of this document as well as the communication of its contents to others without expressed authorization is prohibited. Offenders will be held liable for payment of damages. All rights reserved in the event of the grant of a patent, utility model or ornamental design registration.</p>		<p>Document title 9A_Interior_Lights_Doors</p>		<p>623A_PP_CC_04_06_2023</p>	
		<p>Document Type DRAW/ELSY</p>	<p>Release Status RELEASED</p>		
<p>VOLVO VOLVO CAR CORPORATION</p>		<p>Volvo Document No 33445458</p>	<p>Edited April/11/2023</p>		
		<p>Issue 035</p>	<p>Page No 134/146</p>		

9A Interior Lights Doors Right

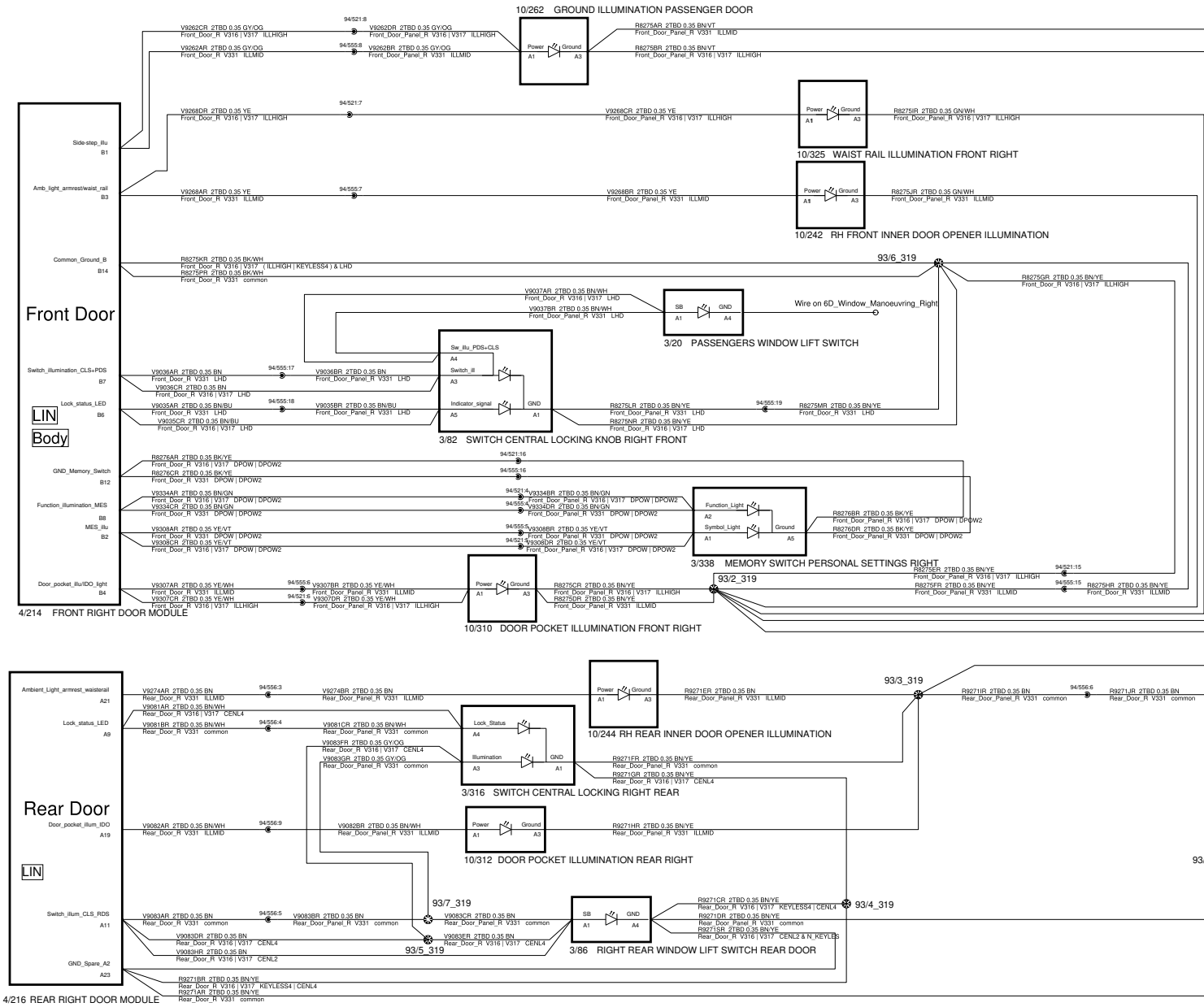

<p>The copying, distribution and utilization of this document as well as the communication of its contents to others without expressed authorization is prohibited. Offenders will be held liable for payment of damages. All rights reserved in the event of the grant of a patent, utility model or ornamental design registration.</p>		<p>Document title 623A_PP_CC_04_06_2023 9A_Interior_Lights_Doors_Right</p>	
		<p>Document Type DRAW/ELSY</p>	<p>Release Status RELEASED</p>
<p>VOLVO VOLVO CAR CORPORATION</p>		<p>CEVT Document No 8888522365</p>	<p>Edited April/11/2023</p>
		<p>Issue 035</p>	<p>Page No 135/146</p>

9H Instr/Control Switch Lighting

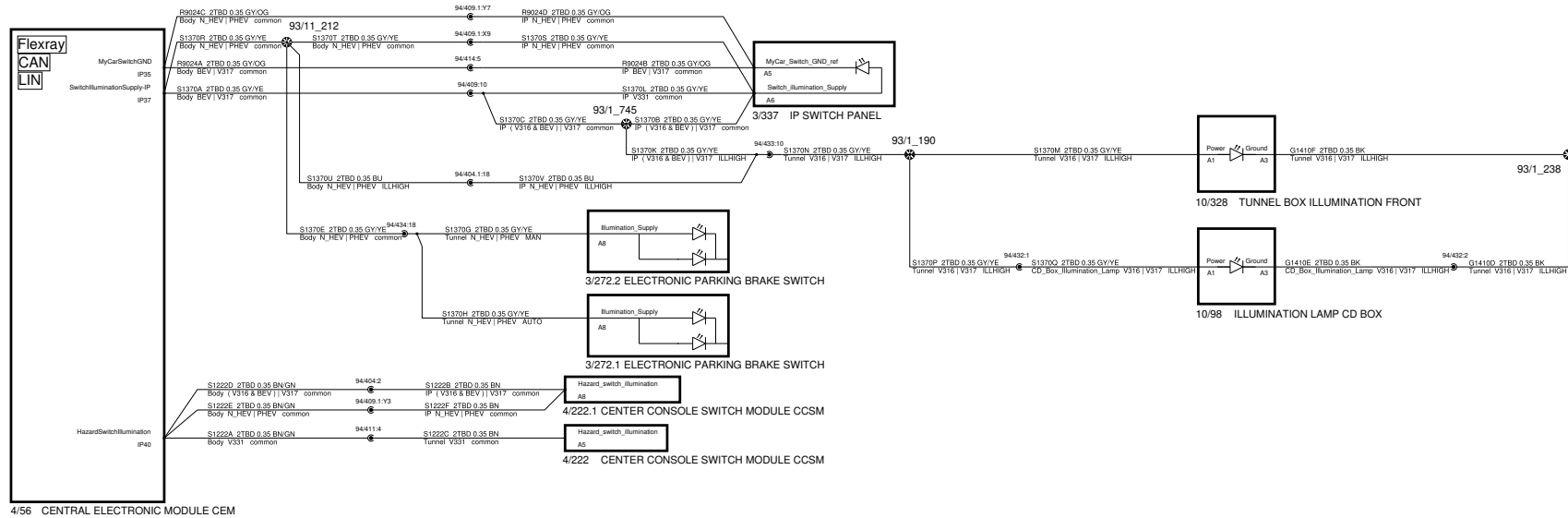
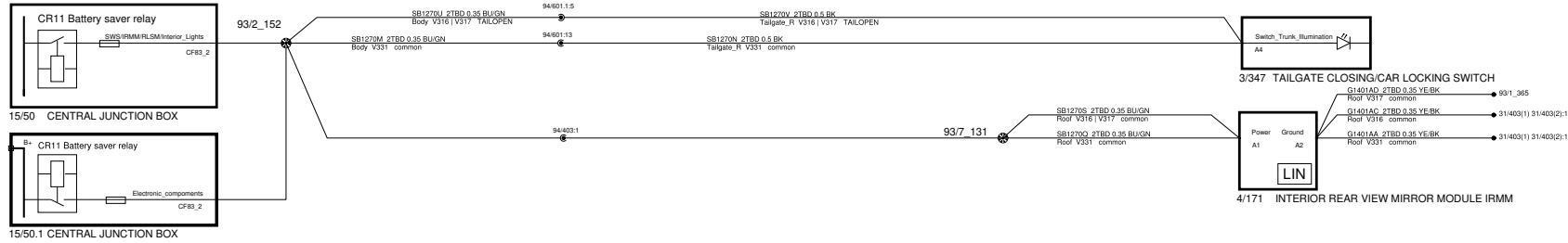

<p>The copying, distribution and utilization of this document as well as the communication of its contents to others without expressed authorization is prohibited. Offenders will be held liable for payment of damages. All rights reserved in the event of the grant of a patent, utility model or ornamental design registration.</p> <p>VOLVO VOLVO CAR CORPORATION</p>	<p>Document title 623A_PP_CC_04_06_2023 9H_Instr_Control_Switch_Lighting</p>	
	<p>Document Type DRAW/ELSY</p>	<p>Release Status RELEASED</p>
	<p>Volvo Document No 33445458</p>	<p>Edited April/19/2023</p>
	<p>Issue 035</p>	<p>Page No 136/146</p>

10A Internal 7DCT Harness

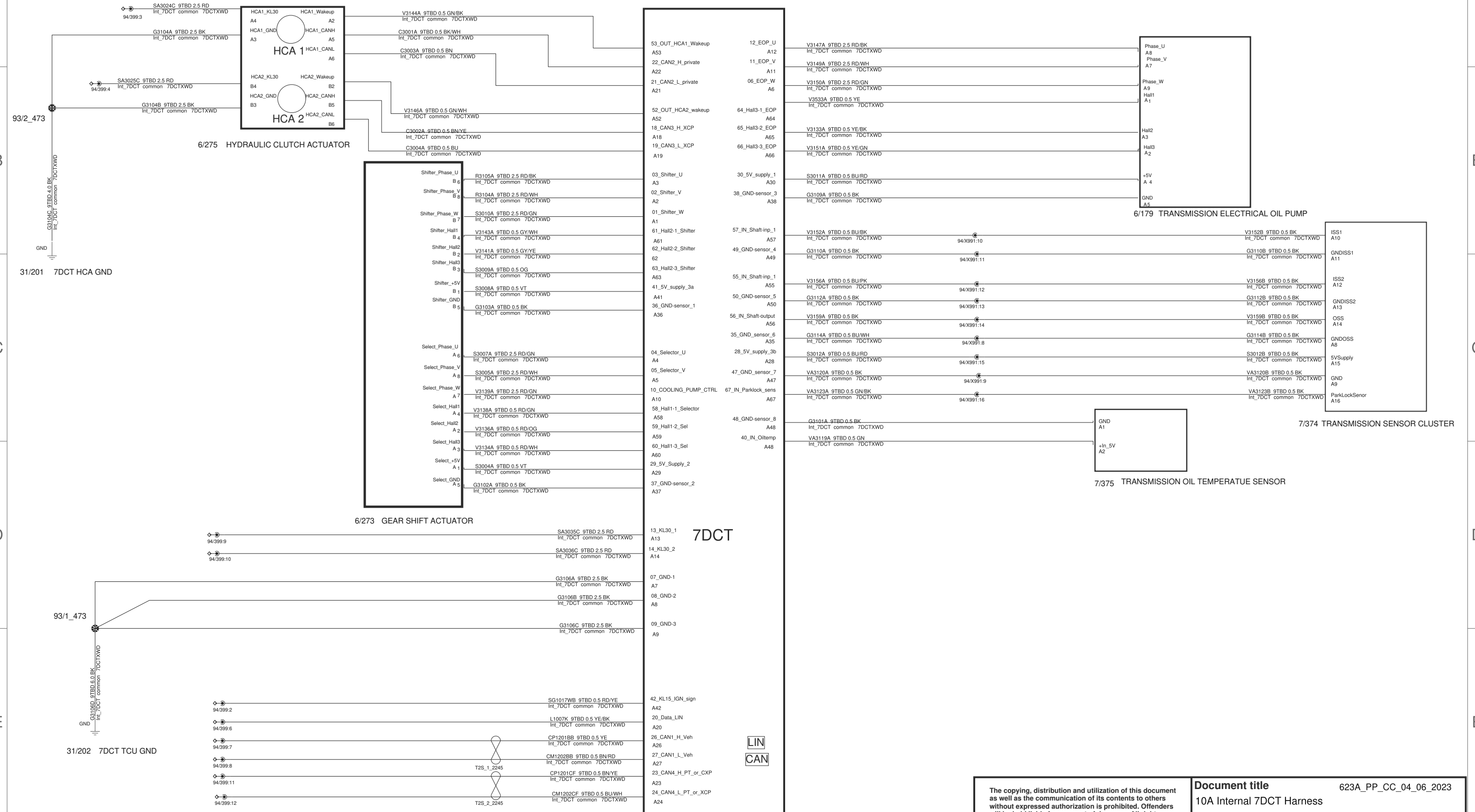

<p>The copying, distribution and utilization of this document as well as the communication of its contents to others without expressed authorization is prohibited. Offenders will be held liable for payment of damages. All rights reserved in the event of the grant of a patent, utility model or ornamental design registration.</p>		<p>Document title 623A_PP_CC_04_06_2023</p>	
		<p>Document Type DRAW/ELSY</p>	
<p>VOLVO VOLVO CAR CORPORATION</p>		<p>Release Status RELEASED</p>	
		<p>CEVT Document No 8888522365</p>	<p>Edited April/19/2023</p>
		<p>Issue 035</p>	<p>Page No 137/146</p>

10A Driver Seat Internal Harness High LHD

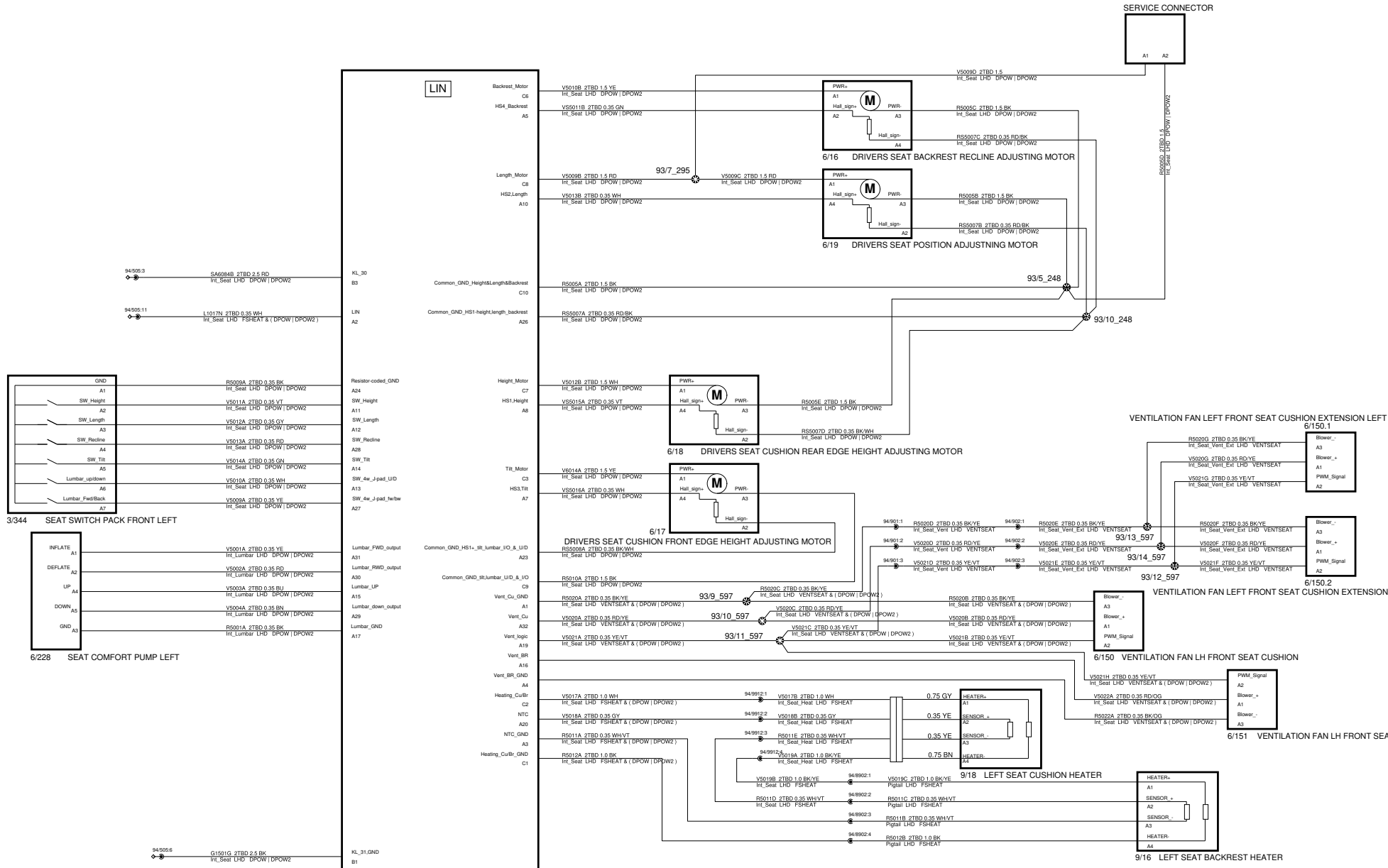

The copying, distribution and utilization of this document as well as the communication of its contents to others without expressed authorization is prohibited. Offenders will be held liable for payment of damages. All rights reserved in the event of the grant of a patent, utility model or ornamental design registration.

Document title 623A_PP_CC_04_06_2023
10A_Driver_Seat_Internal_Harness_High_LHD

Document Type	Release Status
DRAW/ELSY	RELEASED
Volvo Document No 33445458	Edited April/11/2023
Issue 035	Page No 138/146

VOLVO
VOLVO CAR CORPORATION

10A Driver Seat Internal Harness High RHD

SERVICE CONNECTOR

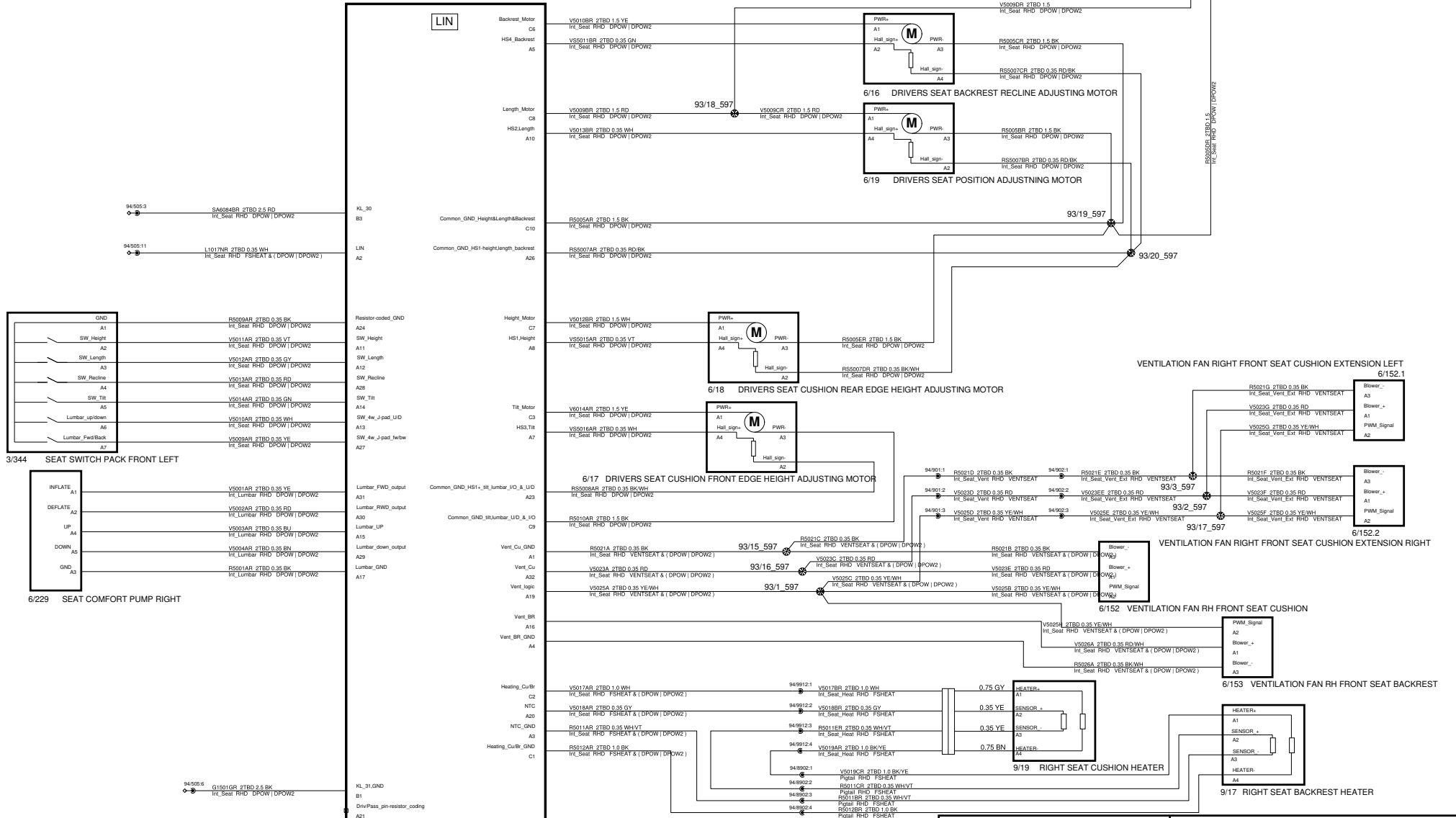

<p>The copying, distribution and utilization of this document as well as the communication of its contents to others without expressed authorization is prohibited. Offenders will be held liable for payment of damages. All rights reserved in the event of the grant of a patent, utility model or ornamental design registration.</p> <p>VOLVO VOLVO CAR CORPORATION</p>	<p>Document title 623A_PP_CC_04_06_2023 10A_Driver_Seat_Internal_Harness_High_RHD</p>	
	<p>Document Type DRAW/ELSY</p>	<p>Release Status RELEASED</p>
	<p>Volvo Document No 33445458</p>	<p>Edited April/11/2023</p>
	<p>Issue 035</p>	<p>Page No 139/146</p>

10A Driver Seat Internal Harness Mech LHD

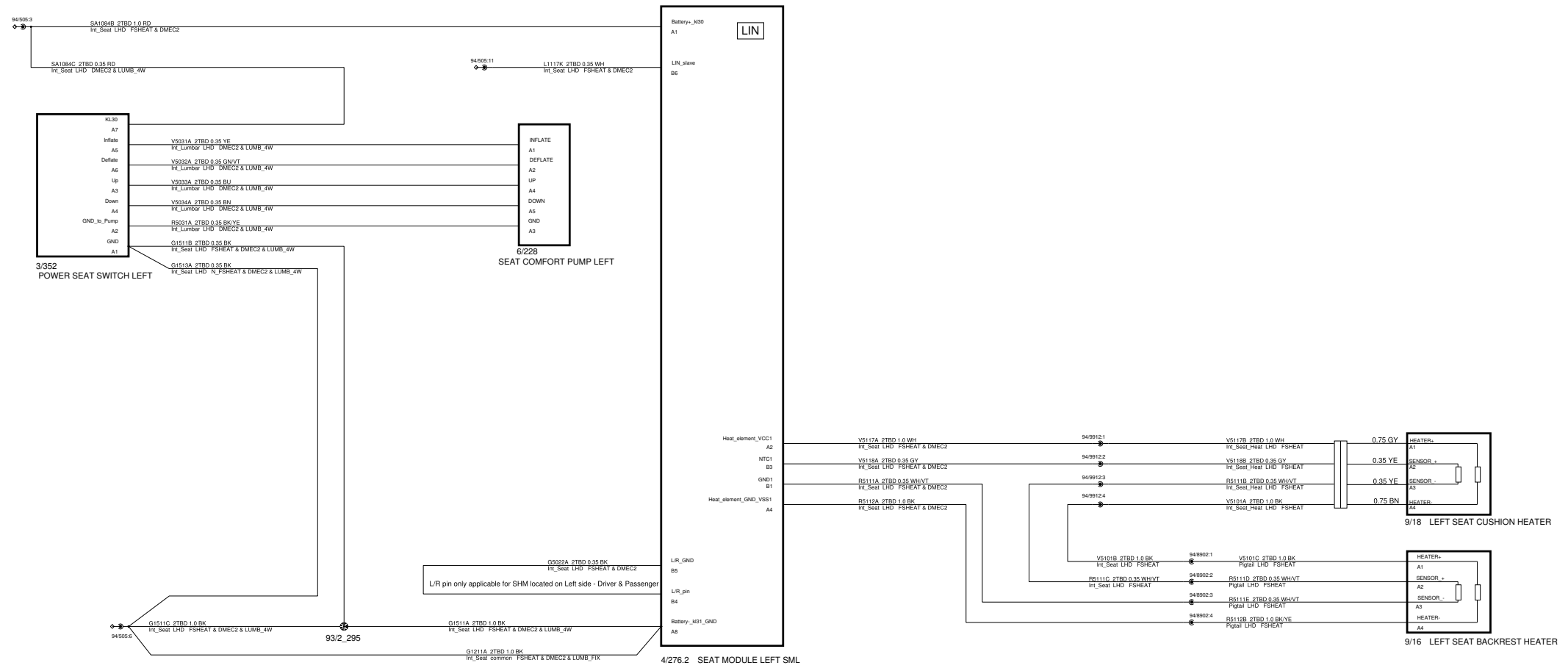

<p>The copying, distribution and utilization of this document as well as the communication of its contents to others without expressed authorization is prohibited. Offenders will be held liable for payment of damages. All rights reserved in the event of the grant of a patent, utility model or ornamental design registration.</p> <p>VOLVO VOLVO CAR CORPORATION</p>	Document title 623A_PP_CC_04_06_2023	
	10A_Driver_Seat_Internal_Harness_Mech_LHD	
	Document Type DRAW/ELSY	Release Status RELEASED
	Volvo Document No 33445458	Edited April/19/2023
	Issue 035	Page No 140/146

10A Driver Seat Internal Harness Mech RHD

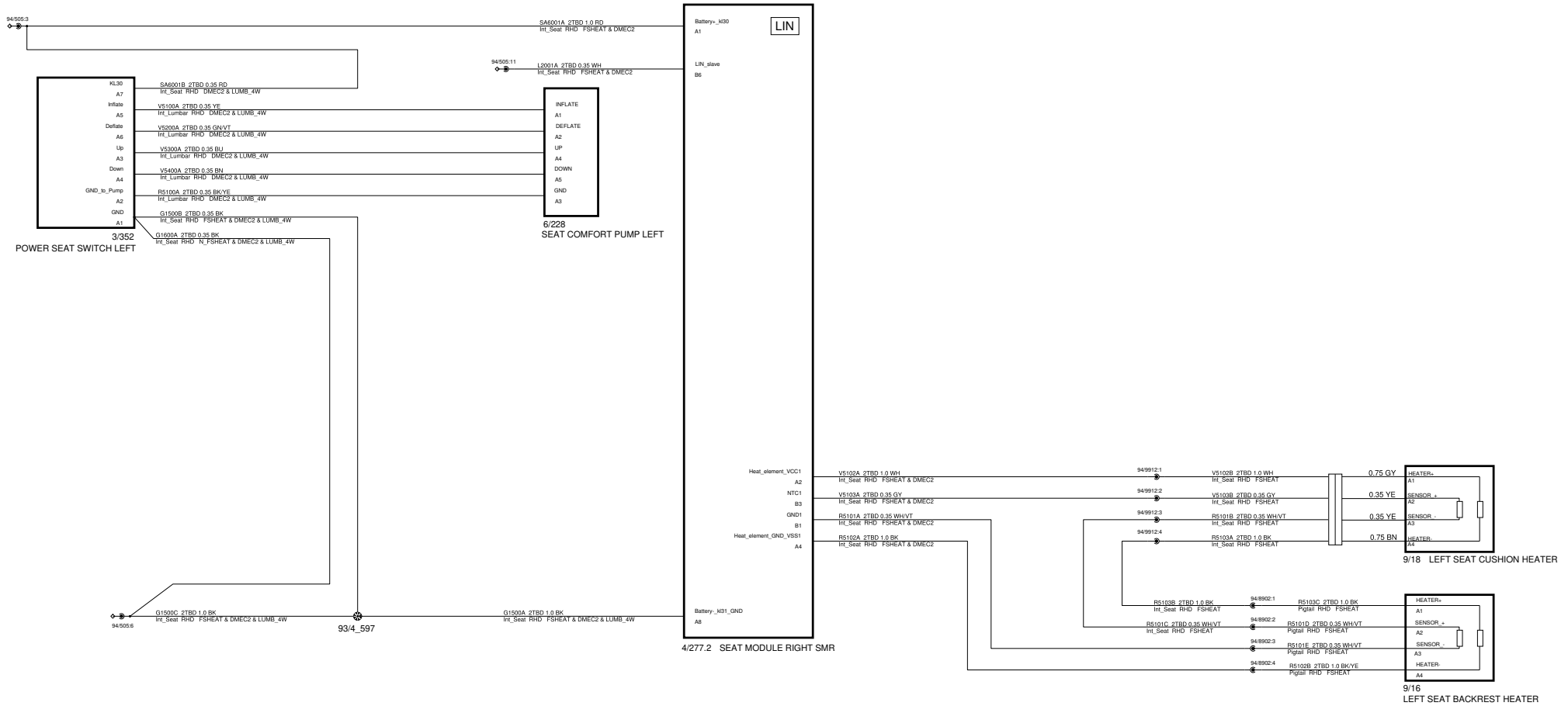

<p>The copying, distribution and utilization of this document as well as the communication of its contents to others without expressed authorization is prohibited. Offenders will be held liable for payment of damages. All rights reserved in the event of the grant of a patent, utility model or ornamental design registration.</p> <p>VOLVO VOLVO CAR CORPORATION</p>	<p>Document title 623A_PP_CC_04_06_2023 10A_Driver_Seat_Internal_Harness_Mech_RHD</p>	
	<p>Document Type DRAW/ELSY</p>	<p>Release Status RELEASED</p>
	<p>Volvo Document No 33445458</p>	<p>Edited April/10/2023</p>
	<p>Issue 035</p>	<p>Page No 141/146</p>

10A Interior HVAC harness 2 ZONES ECC

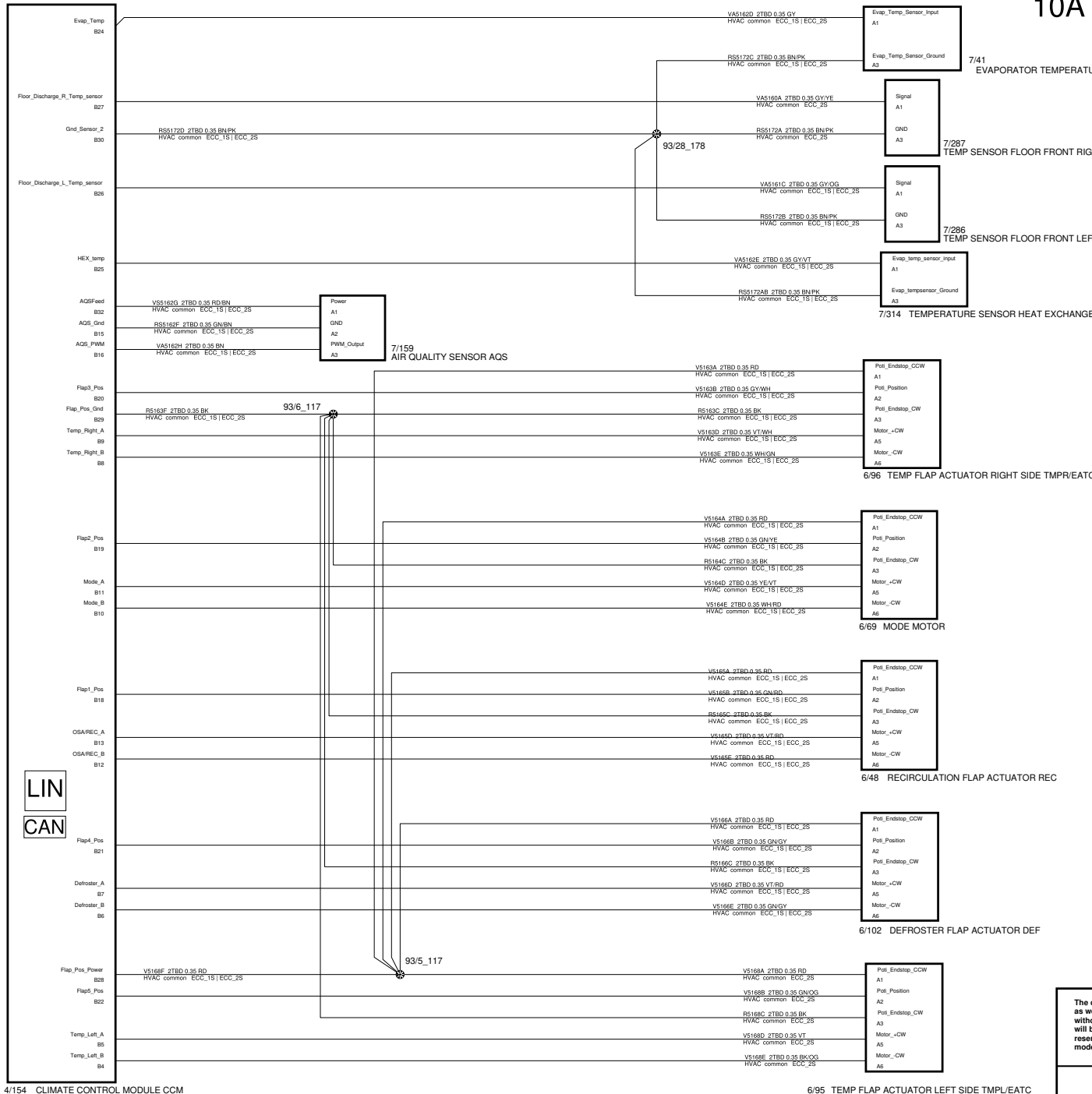

<p>The copying, distribution and utilization of this document as well as the communication of its contents to others without expressed authorization is prohibited. Offenders will be held liable for payment of damages. All rights reserved in the event of the grant of a patent, utility model or ornamental design registration.</p>		<p>Document title 623A_PP_CC_04_06_2023</p>	
		<p>10A_Interior_HVAC_Harness_VCC_2-ZONES_ECC</p>	
<p>Document Type DRAW/ELSY</p>	<p>Release Status RELEASED</p>		<p>Edited June/16/2021</p>
	<p>Volvo Document No 33445458</p>		
<p>Issue 035</p>		<p>Page No 142/146</p>	

VOLVO
VOLVO CAR CORPORATION

4/154 CLIMATE CONTROL MODULE CCM

6/95 TEMP FLAP ACTUATOR LEFT SIDE TMPL/EATC

10A Passenger Seat Internal Harness High LHD

SERVICE CONNECTOR

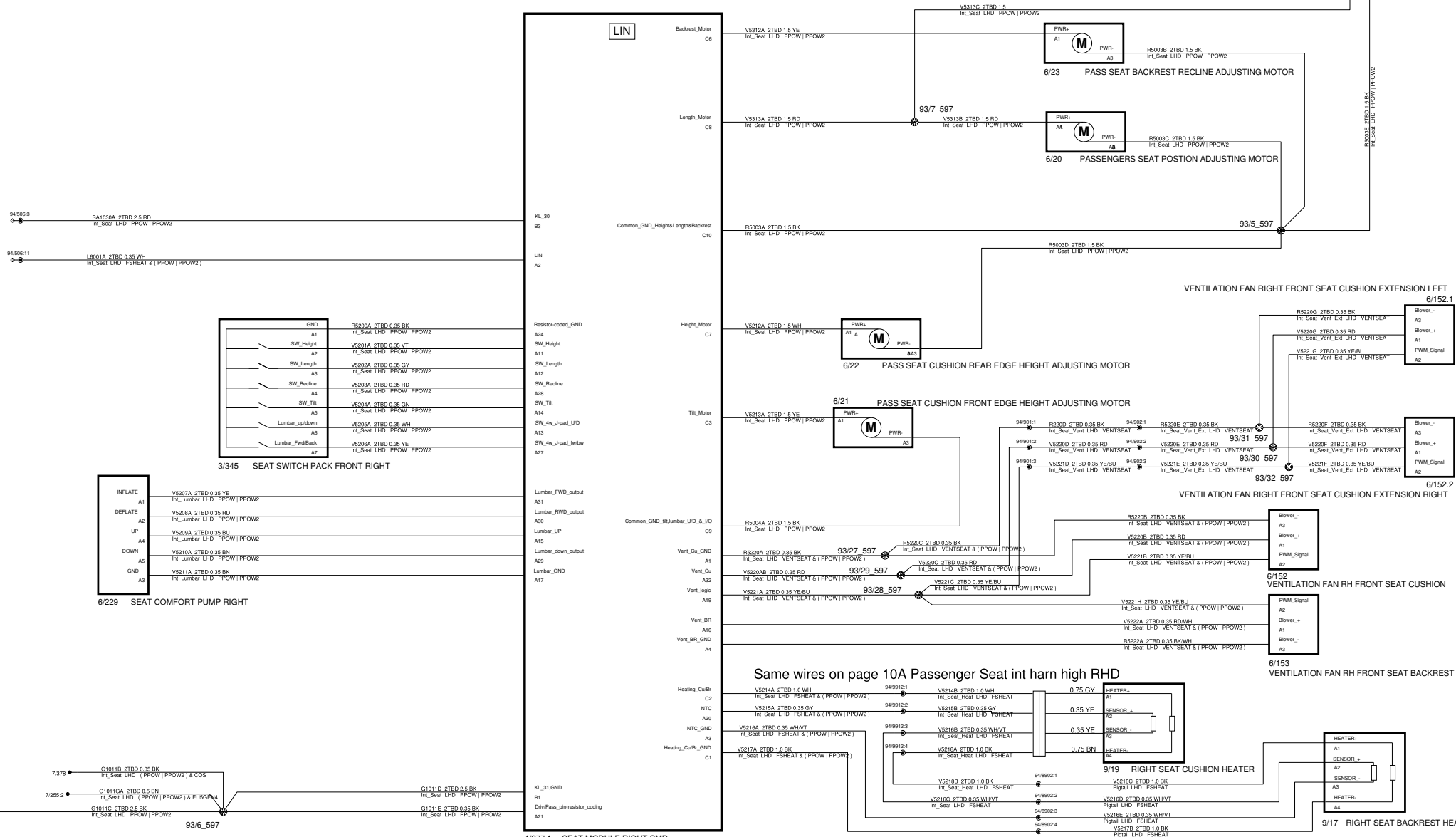

Same wires on page 10A Passenger Seat int harm high RHD

<p>The copying, distribution and utilization of this document as well as the communication of its contents to others without expressed authorization is prohibited. Offenders will be held liable for payment of damages. All rights reserved in the event of the grant of a patent, utility model or ornamental design registration.</p>		<p>Document title 10A_Passenger_Seat_Internal_Harness_High_LHD</p>	
<p>Document Type DRAW/ELSY</p>		<p>Release Status RELEASED</p>	
<p>Volvo Document No 33445458</p>		<p>Edited April/19/2023</p>	
<p>Issue No 035</p>		<p>Page No 143/146</p>	

VOLVO
VOLVO CAR CORPORATION

10A Passenger Seat Internal Harness High RHD

SERVICE CONNECTOR

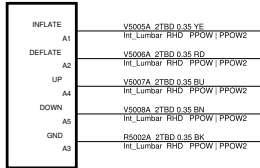
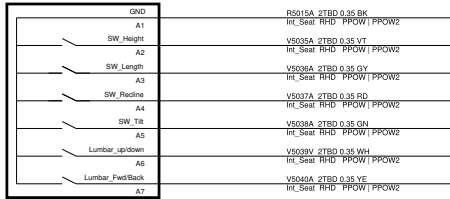
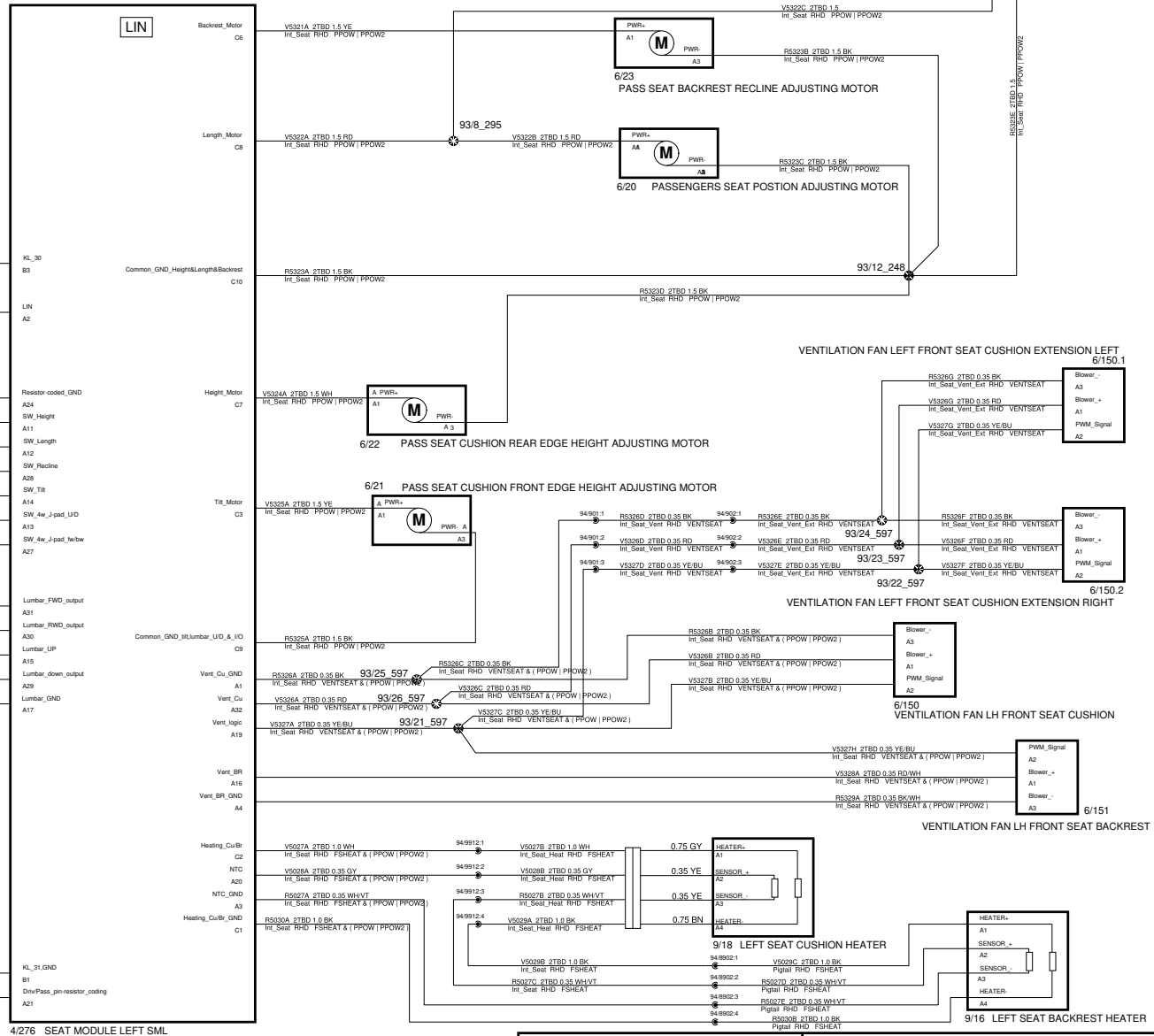
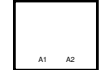

Resistor-coded_GND

INFLATE

DEFLATE

UP

DOWN

GND

6/228 SEAT COMFORT PUMP LEFT

4/276 SEAT MODULE LEFT SML

The copying, distribution and utilization of this document as well as the communication of its contents to others without expressed authorization is prohibited. Offenders will be held liable for payment of damages. All rights reserved in the event of the grant of a patent, utility model or ornamental design registration.

VOLVO
VOLVO CAR CORPORATION

Document title 623A_PP_CC_04_06_2023

10A_Passenger_Seat_Internal_Harness_High_RHD

Document Type Release Status

DRAW/ELSY RELEASED

Volvo Document No 33445458 Edited April/19/2023

Issue No 035 Page No 144/146

10A Passenger Seat Internal Harness Mech LHD

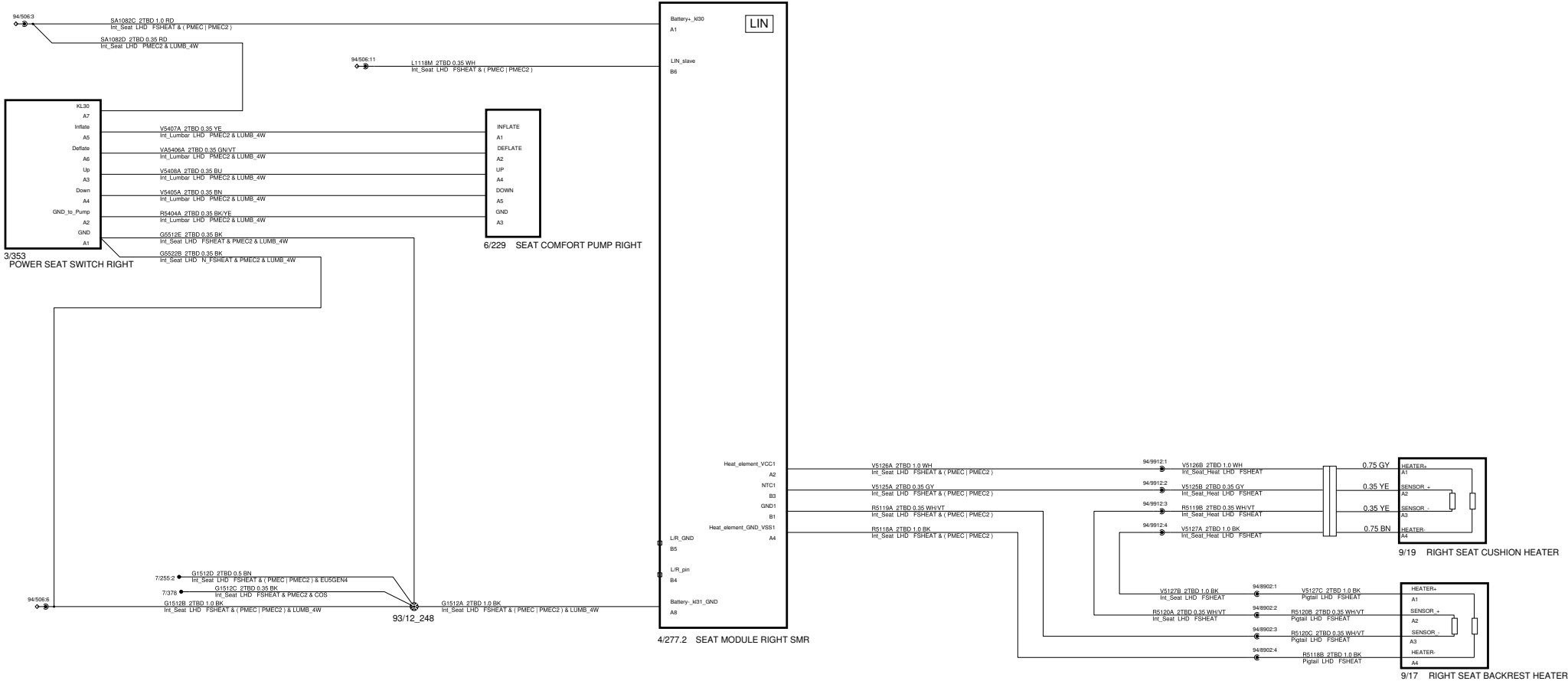

<p>The copying, distribution and utilization of this document as well as the communication of its contents to others without expressed authorization is prohibited. Offenders will be held liable for payment of damages. All rights reserved in the event of the grant of a patent, utility model or ornamental design registration.</p> <p>VOLVO VOLVO CAR CORPORATION</p>	<p>Document title: 623A_PP_CC_04_06_2023 10A_Passenger_Seat_Internal_Harness_Mech_LHD</p>	
	<p>Document Type: DRAW/ELSY</p>	<p>Release Status: RELEASED</p>
	<p>Volvo Document No: 33445458</p>	<p>Edited: April/19/2023</p>
	<p>Issue: 035</p>	<p>Page No: 145/146</p>

10A Passenger Seat Internal Harness Mech RHD

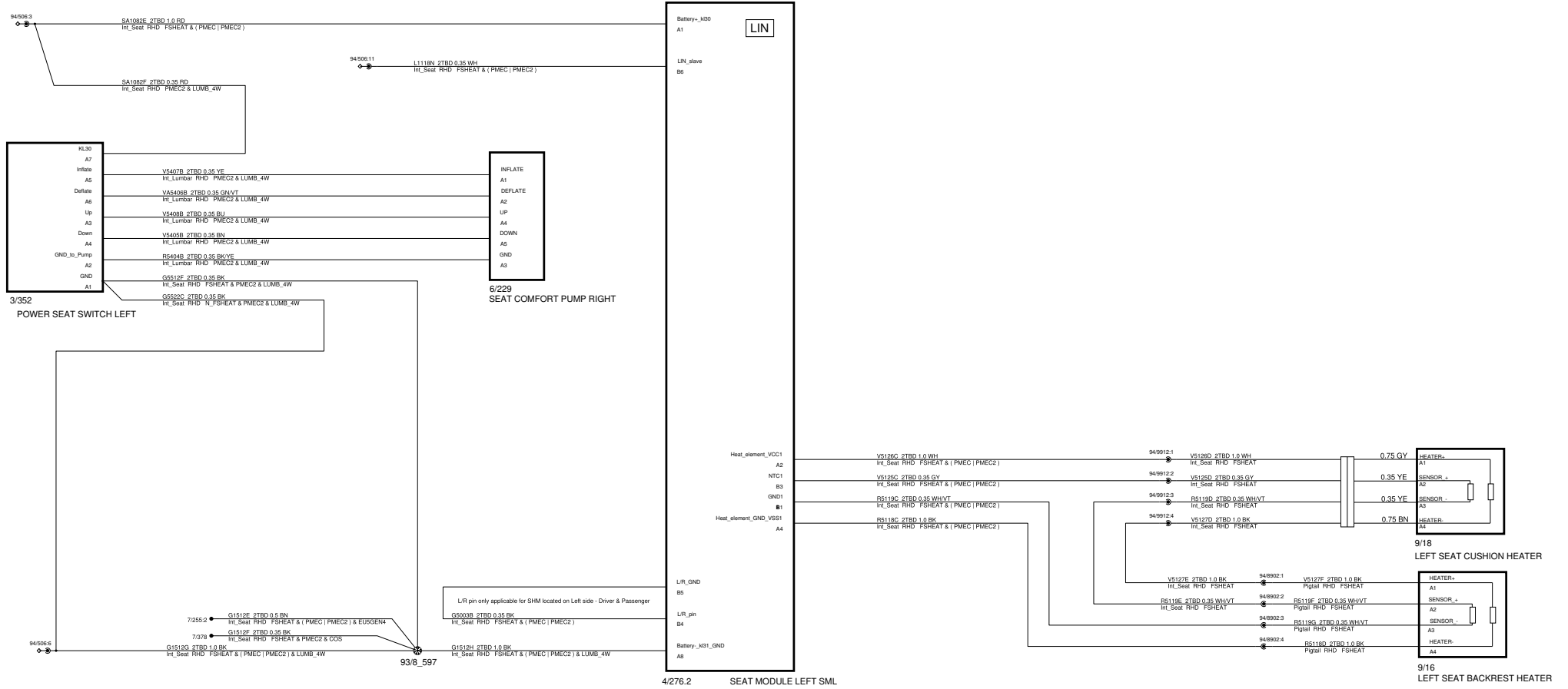

<p>The copying, distribution and utilization of this document as well as the communication of its contents to others without expressed authorization is prohibited. Offenders will be held liable for payment of damages. All rights reserved in the event of the grant of a patent, utility model or ornamental design registration.</p> <p>VOLVO</p> <p>VOLVO CAR CORPORATION</p>	<p>Document title 623A_PP_CC_04_06_2023</p> <p>10A_Passenger_Seat_Internal_Harness_Mech_RHD</p>	
	<p>Document Type</p> <p>DRAW/ELSY</p>	<p>Release Status</p> <p>RELEASED</p>
	<p>Volvo Document No</p> <p>33445458</p>	<p>Edited</p> <p>April/19/2023</p>
	<p>Issue</p> <p>035</p>	<p>Page No</p> <p>146/146</p>