



Bulletin Title		Ref NO	
Aftermarket Wiring Diagrams SPA MY24		SJ1001861	
Issuer (Dept.)	Car Market	Issue Date	Status Date
Service Operations	United States and Canada	4/25/23	4/25/23
Revisions		Page	
		Page 1 of 178	

**Background:**

As a result of delays in the production of aftermarket wiring diagrams, there is a risk of missing or incorrect wiring diagrams for certain customer functions for SPA MY24 vehicles (structure week 202317 - ).

Models included:

XC90, XC60, S90, S90L, V90, V90CC, S60, V60, V60CC

**Temporary Solution:**

In cases of missing or incorrect wiring diagrams in VIDA, refer to the cleaned-up system-based wiring diagrams from R&D attached as a PDF.

**Final Solution:**

Customer function-based wiring diagrams will continuously be updated and released to VIDA once they are finished.

# V526 / V54x / V426 / L541 / V43x 523A PP | 524A VP

Sheet Name	Sheet Number	Sheet Name	Sheet Number
0A_V526_V54X_V426_V43X_L541_P514	1	3A_Engine_Management_VEP4g3_sensor	90
0B1_Overview_LHD	2	3B_Management_Hybrid_Driveline	91
0B1_Overview_Temp	3	3C_Engine_Management_VED4g3	92
0B2_Overview_RHD	4	3D_Engine_thermal_management	93
0B3_Overview_Hybrid	5	3E_Automatic_Gear_Shifting	94
1A1_Electrical_distribution_CJB	6	3E_Automatic_Gear_Shifting_2	95
1A1_Electrical_distribution_EJB	7	3E_Automatic_Gear_Shifting_7DCT	96
1A1_Electrical_distribution_FJB	8	3E_Automatic_Gear_Shifting_Hybrid	97
1A3_System_relays_control	9	3G_4WD_Transmission	98
1B1_Grounding_Engine_Engine_Bay	10	3M_Engine_cranking_control	99
1B3_Grounding_Floor_Front	11	3P_Driveline_Sound_Absorbing	100
1B3_Grounding_Floor_Front_L541	12	3S1_Fuel_Leakage_Detection	101
1B4_Grounding_Floor_Rear_Tailgate	13	3S_Fuel_Supply_Control	102
1C1_EI_power_generating	14	3U1_NOx_Reduction_Pump	103
1D_003_Diagnostics_VCU1	15	3U2_NOx_Reduction_Sensors	104
1E_001B_Flexray_Backbone_CL90	16	3U_NOx_Reduction	105
1E_001B_Flexray_Backbone_V43X_iCUP_LHD	17	4A_001_Driver_Information	106
1E_001B_Flexray_Backbone_V43X_iCUP_RHD	18	4A_002_Tyre_Pressure_Monitoring_System	107
1E_001B_Flexray_Backbone_V426	19	4J1_USS_FAP_ARGUS	108
1E_001B_Flexray_Front2_Mid2	20	4J1_USS_Front_ARGUS	109
1E_002_Body_CAN_LHD	21	4J1_USS_Rear_ARGUS	110
1E_002_Body_CAN_LHD_CL60	22	4J2B_Lane_Change_Aid	111
1E_002_Body_CAN_LHD_L541	23	4J4_PAC_Visualisation_COAX	112
1E_002_Body_CAN_RHD	24	5A_Climate_Control	113
1E_002_Body_CAN_RHD_CL60	25	5A_Climate_Control_2	114
1E_003C_Front_CAN_1	26	5A_Climate_Control_HVAC	115
1E_004_Exposed_Safety_CAN_V54X_L541_V426_V43X_ARGUS	27	5B_Front_Seat_Comfort	116
1E_004_Exposed_Safety_CAN_V526_ARGUS	28	5B_Rear_Seat_Comfort	117
1E_004B_Front_CAN_4_Exposed	29	5B_Rear_Seat_Comfort_L541	118
1E_006A_Protected_Safety_CAN_CL90	30	5B_Rear_Seat_Comfort_V54X_V43X_V426	119
1E_006B_Protected_Safety_CAN_CL60	31	5F1_Passenger_Compartment_Pre-Conditioning	120
1E_007A_LIN_Powertrain	32	5G_Steering_Wheel_Heating	121
1E_007B_LIN_Comfort	33	6A_Locking	122
1E_007C_LIN_Comfort_L541	34	6A_Locking_Rear	123
1E_007D_LIN_Infotainment	35	6C_Theft_protection	124
1E_007E_LIN_Body	36	6D_Window_Manoeuvring	125
1E_007E_LIN_Body_2	37	6D_Window_Manoeuvring_Right	126
1E_007F_LIN_Doors	38	6F1_001_Roof_Manoeuvring	127
1E_008_MOST	39	6K_Tailgate_boot_lid_manoeuvring_V526_etc	128
1E_009_Engine_CAN	40	6K_Tailgate_boot_lid_manoeuvring_V541_L541_V431	129
1E_010_Body_CAN_Exposed	41	6K_Tailgate_boot_lid_manoeuvring_V542_V543_V426_V432_V433	130
1E_013A_Rear_CAN_PHEV_519A	42	6P_001_Voltage_outlet	131
1E_013B_Rear_CAN_48V_519A	43	7A_001C_Infotainment_40_iCUP	132
1E_014_MID_CAN	44	7A_001H_Infotainment_Ethernet_Internet_iCUP	133
1E_015_ABS_BRAKING_CAN	45	7A_002B_External_Amplifier_Audio2_CL90	134
1F2_001_Access_Towing_System_13S_13pol	46	7A_002C_External_Amplifier_Audio2+_CL90	135
1F2_002_Access_Towing_System_4_7pol	47	7A_002D_External_Amplifier_Audio3_CL90	136
1F2_003_Accessory_Distribution_Box_AJB	48	7A_002E_External_Amplifier_Audio_CL60	137
1F3_004_Accessories_USB_Char_IPAD_V54X_V426_V526_519A	49	7B_001C_Telematics_TGAM	138
1F3_005_Accessories_USB_Char_IPAD_L541_5SEAT_519A	50	7B_002B_Telematics_Microphones_Digital	139
1F4_001A_Accessories_LED_Illumination	51	7C_003_DSRC_IHU40	140
1F4_001B_Accessories_LED_Illumination	52	7D_001_Remote_Monitoring_System	141
1F4_001C_Accessories_LED_Running_Board	53	7E_001_Wireless_Phone_Charger	142
1F5_001_Accessories_Alcolock_prep	54	7F_Electronic_Toll_Collector	143
1F5_002_Accessories_Alcolock	55	8A_Exterior_Light_Front_Fog	144
1F10_Accessories_Repair_Harness_USB_2.0	56	8A_Exterior_Light_Front_HCM	145
1F12_001_Accessories_Park_Assist_Pilot_Front_V43X	57	8A_Exterior_Light_Rear	146
1F12_002_Accessories_Park_Assist_Pilot_Rear_V43X	58	8A_Exterior_Light_Rear_CL60	147
1H_EI_Distribution_High_Voltage_521H	59	8A_Exterior_Light_Rear_RCM	148
1K_EI_Energy_Management_High_Voltage_521H	60	8A_Exterior_Light_Rear_Sensors	149
1L_EI_generating_public_network_523A_EVI_1	61	8K_9H_8J_Lamp_windscreen_rear_window_cleaning	150
1L_EI_generating_public_network_523A_EVI_2_EVI_3	62	8N_8L_Windscreen_rear_window_defroster	151
1M_001_MVBM_Adaptor	63	8P_Sound_signaling	152
1M_EI_Distribution_Mid_Voltage	64	9A_Interior_Lights_CEM	153
2A_Braking_519A_519B	65	9A_Interior_Lights_CJB	154
2E_Power_Steering	66	9A_Interior_Lights_Doors_Front	155
2F_2G_Damping_Control_Levelving_Control	67	9A_Interior_Lights_Doors_Front_Right	156
2G1_Rear_Levelving	68	9A_Interior_Lights_Doors_Rear	157
2G_Levelving_Control	69	9H_Instr_Control_Switch_Lighting	158
2M_Pedestrian_Protection_CL90_V426_N_HEV	70	10A_Internal_7DCT_Harness	159
2M_Pedestrian_Protection_CL90_V426_PHEV	71	10A_Driver_Seat_LHD	160
2M_Pedestrian_Protection_V43X_N_HEV	72	10A_Driver_Seat_Massage_LHD	161
2N_Safety_Belt_Reminder_CL90_V426_N_HEV	73	10A_HVAC_ECC2	162
2N_Safety_Belt_Reminder_CL90_V426_PHEV	74	10A_HVAC_ECC4	163
2N_Safety_Belt_Reminder_V43X_N_HEV	75	10A_Passenger_Seat_LHD	164
2O_Collision_Avoidance	76	10A_Passenger_Seat_Lumbar_Massage_LHD	165
2O_Collision_Avoidance_ARGUS	77	10A_Rear_Seat_L541	166
2P_Supplementary_Restraint_System_Igniters_CL90_V426_NHEV	78	10A_Rear_Seat_V526	167
2P_Supplementary_Restraint_System_Igniters_CL90_V426_PHEV	79	10A_Rear_Seat_V541_V431	168
2P_Supplementary_Restraint_System_Igniters_V43X_NHEV	80	10A_Rear_Seat_V542_V543_V432_V433	169
2P_Supplementary_Restraint_System_Igniters_V43X_PHEV	81	11B_001_SP_Police_Accessories_Base	170
2R_Safety_Belt_CL90_V426_NHEV	82	11B_001_SP_Police_Accessories_Base_2	171
2R_Safety_Belt_CL90_V426_PHEV	83	11B_001_SP_Police_Accessories_Engine_Bay	172
2R_Safety_Belt_V43X_NHEV	84	11B_001_SP_Police_Accessories_Power_Supply	173
3A_3C_Engine_management	85	11B_001_SP_Police_Accessories_Rear_Door	174
3A_3C_Engine_Management_VED4g3	86	11B_001_SP_Police_Accessories_Roof_Tailgate	175
3A_3C_Engine_Management_VEP4g3	87	11B_001_SP_Police_Grounding	176
3A_Engine_management_VEP4g2	88	IHU_WAM_Service_Adapter_Harness	177
3A_Engine_Management_VEP4g3	89		

<p>The copying, distribution and utilization of this document as well as the communication of its contents to others without expressed authorization is prohibited. Offenders will be held liable for payment of damages. All rights reserved in the event of the grant of a patent, utility model or ornamental design registration.</p>	<b>Document title</b> SPA_issue25_Release1	
	0A_V526_V54X_V426_V43X_L541_P514	
 VOLVO CAR CORPORATION	<b>Document Type</b> DRAW/ELSY	<b>Edited</b> April/20/2023
	<b>Release Status</b> RELEASED	
<b>Document No</b> 33409142	<b>Issue</b> 035	<b>Page No</b> 1/177

# 0B Overview LHD

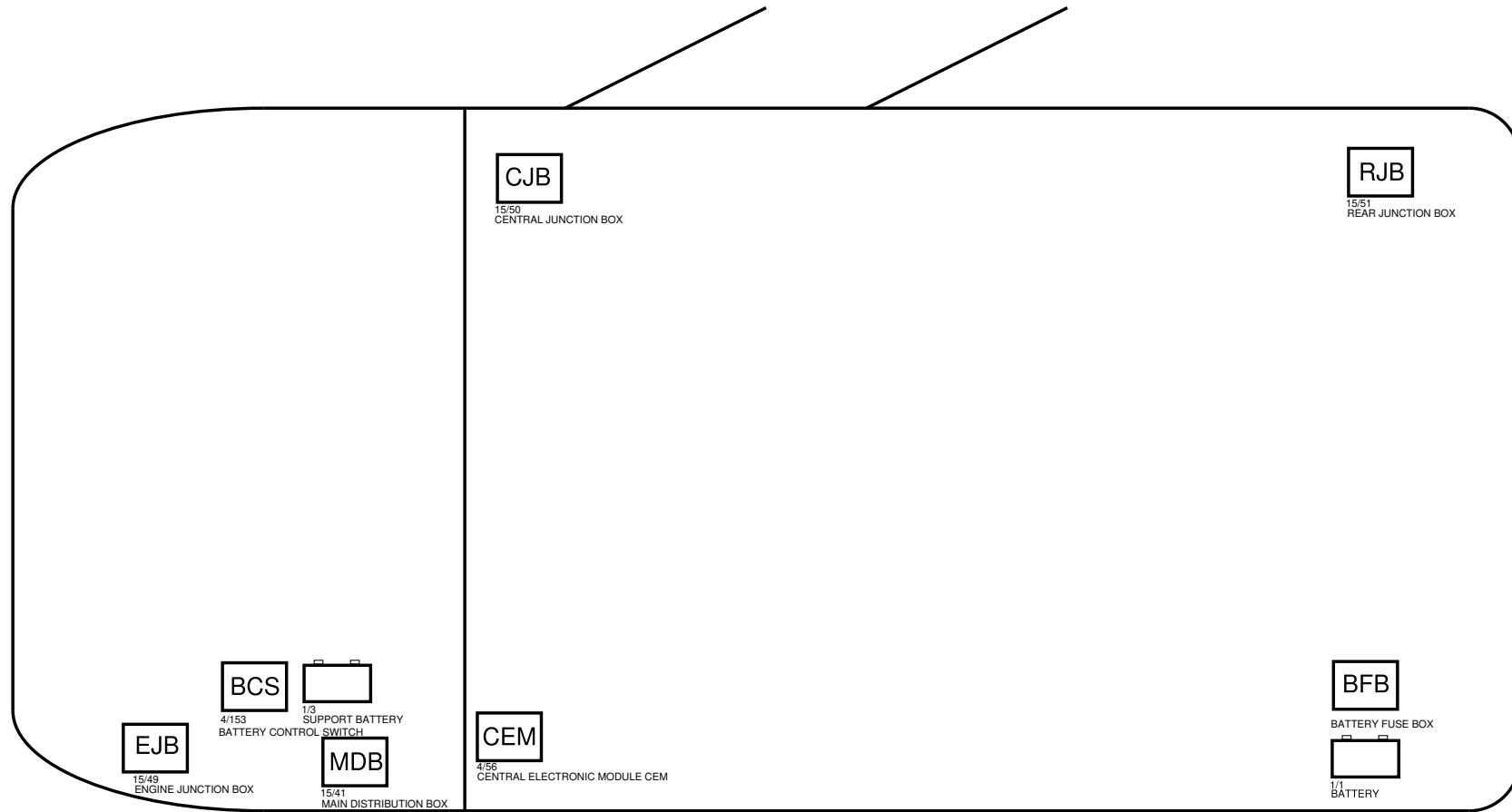

<p>The copying, distribution and utilization of this document as well as the communication of its contents to others without expressed authorization is prohibited. Offenders will be held liable for payment of damages. All rights reserved in the event of the grant of a patent, utility model or ornamental design registration.</p>	<b>Document title</b> SPA_Issue25_Release1 0B1_Overview_LHD	
	<b>Document Type</b> DRAW/ELSY	<b>Edited</b> January/19/2022
<p><b>VOLVO</b> VOLVO CAR CORPORATION</p>	<b>Release Status</b> RELEASED	
	<b>Document No</b> 33409142	<b>Issue</b> 035
	<b>Page No</b> 2/177	

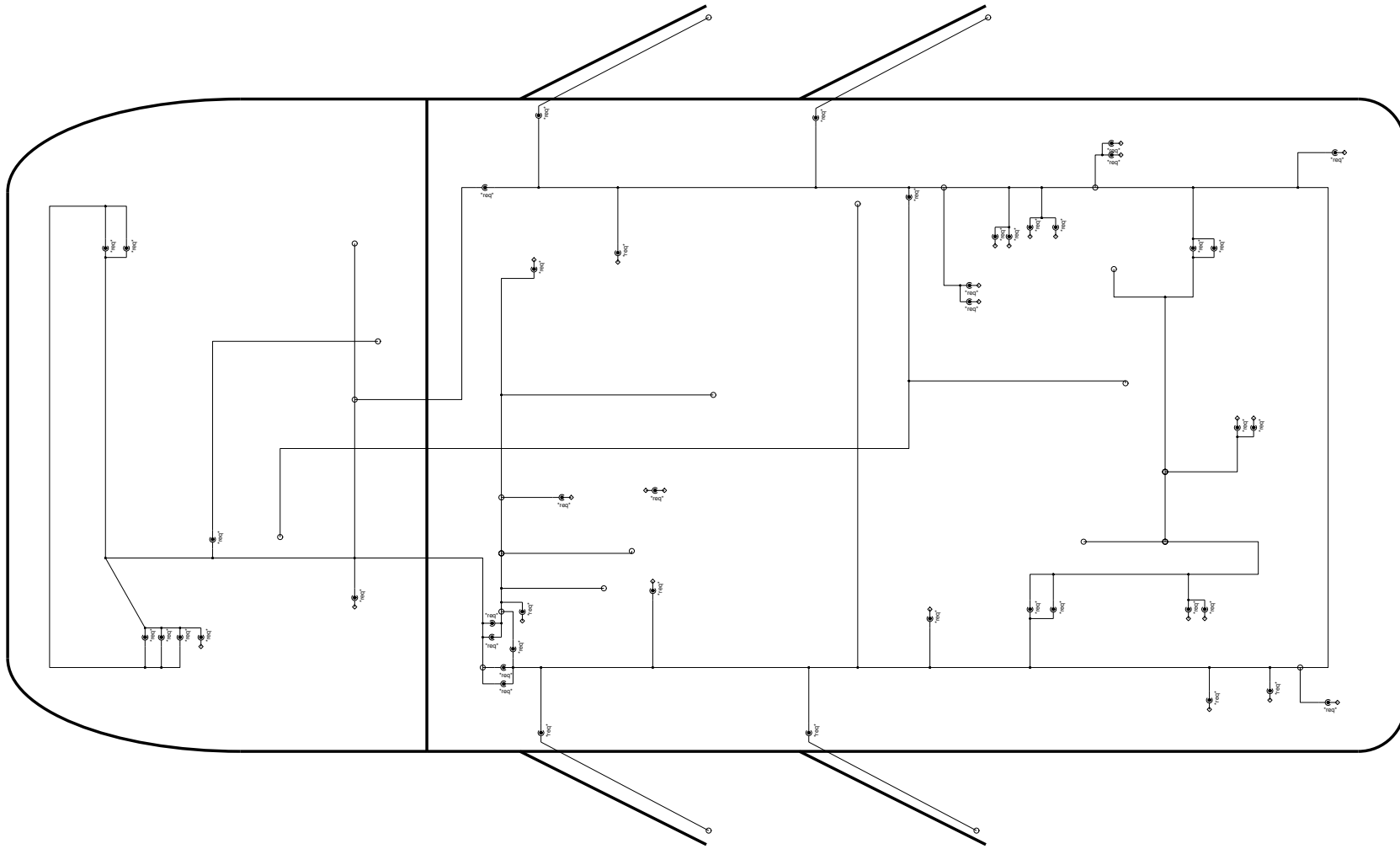

<p>The copying, distribution and utilization of this document as well as the communication of its contents to others without expressed authorization is prohibited. Offenders will be held liable for payment of damages. All rights reserved in the event of the grant of a patent, utility model or ornamental design registration.</p> <p><b>VOLVO</b> VOLVO CAR CORPORATION</p>	<b>Document title</b> SPA_Issue25_Release1 0B1_Overview_Temp	
	<b>Document Type</b> DRAW/ELSY	<b>Edited</b> April/19/2021
	<b>Release Status</b> RELEASED	
	<b>Document No</b> 33409142	<b>Issue</b> 035

# 0B Overview RHD

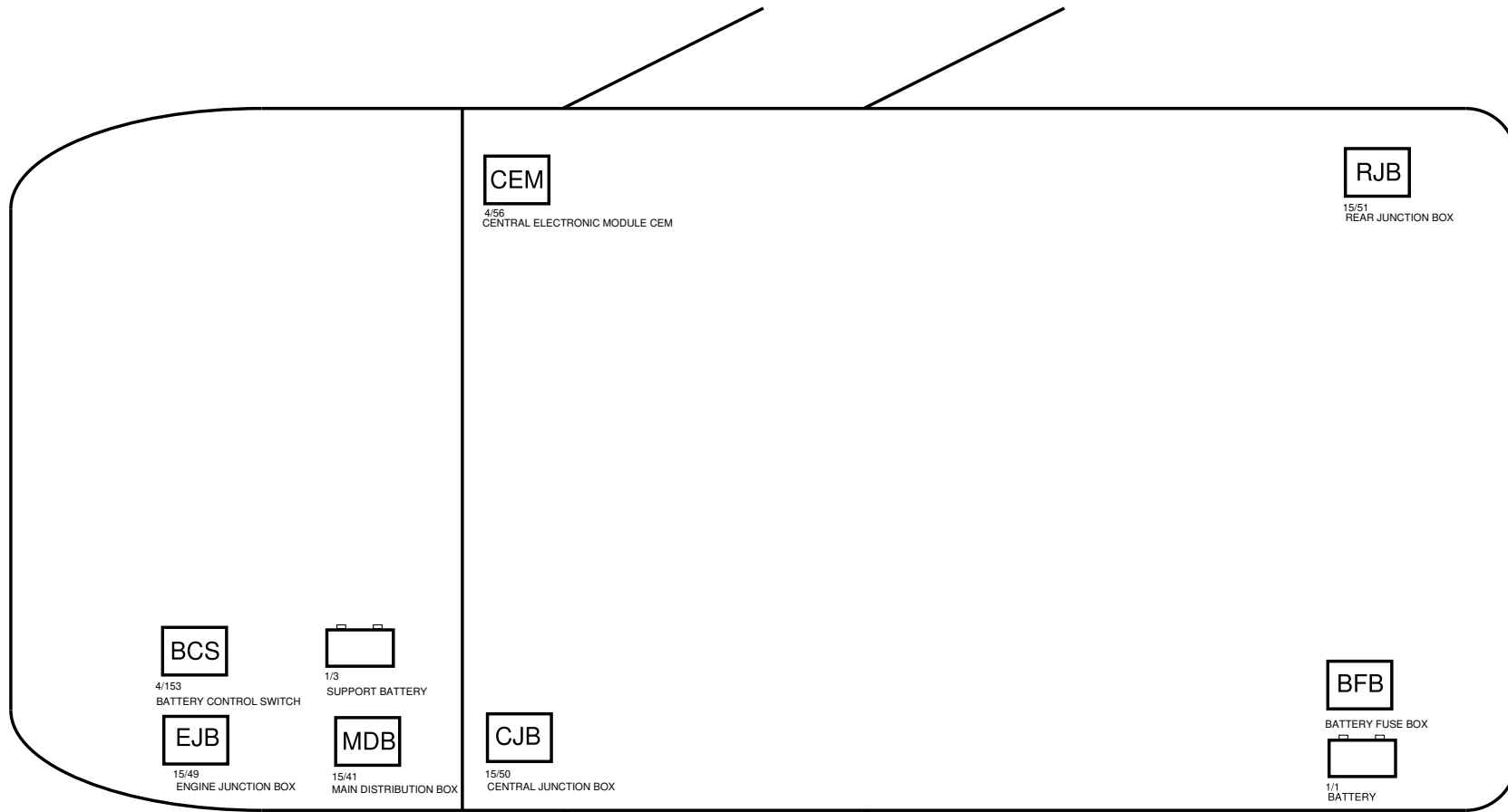

**BCS**

4/153  
BATTERY CONTROL SWITCH



1/3  
SUPPORT BATTERY

**EJB**

15/49  
ENGINE JUNCTION BOX

**MDB**

15/41  
MAIN DISTRIBUTION BOX

**CJB**

15/50  
CENTRAL JUNCTION BOX

**CEM**

4/56  
CENTRAL ELECTRONIC MODULE CEM

**RJB**

15/51  
REAR JUNCTION BOX

**BFB**

BATTERY FUSE BOX



1/1  
BATTERY

<p>The copying, distribution and utilization of this document as well as the communication of its contents to others without expressed authorization is prohibited. Offenders will be held liable for payment of damages. All rights reserved in the event of the grant of a patent, utility model or ornamental design registration.</p>	<p><b>Document title</b> SPA_Issue25_Release1 0B2_Overview_RHD</p>	
	<p><b>Document Type</b> DRAW/ELSY</p>	<p><b>Edited</b> April/05/2023</p>
<p><b>VOLVO</b> VOLVO CAR CORPORATION</p>	<p><b>Release Status</b> RELEASED</p>	
	<p><b>Document No</b> 33409142</p>	<p><b>Issue</b> 035 <b>Page No</b> 4/177</p>

# 0B Overview Hybrid

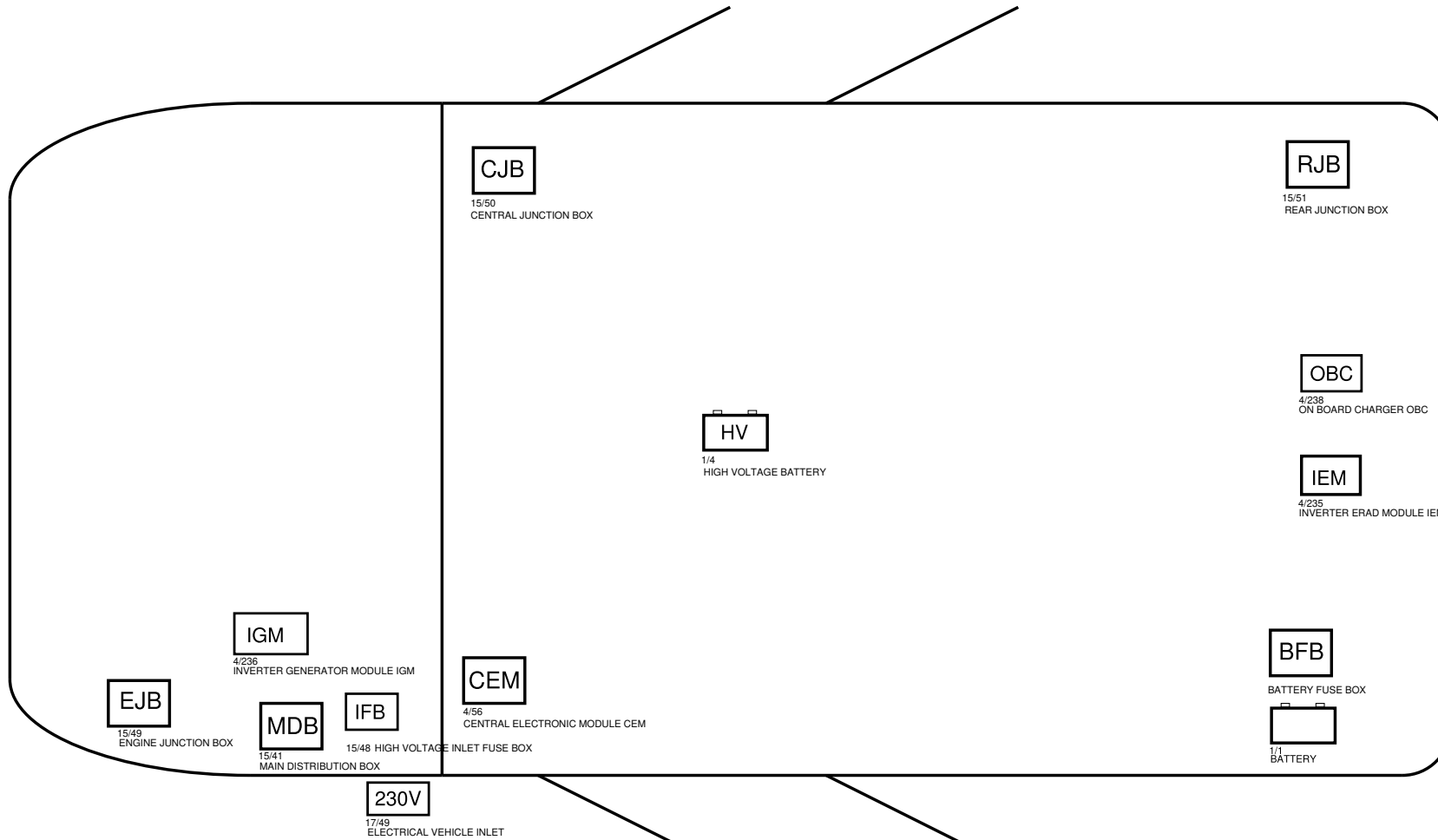

<p>The copying, distribution and utilization of this document as well as the communication of its contents to others without expressed authorization is prohibited. Offenders will be held liable for payment of damages. All rights reserved in the event of the grant of a patent, utility model or ornamental design registration.</p> <p><b>VOLVO</b> VOLVO CAR CORPORATION</p>	<b>Document title</b> SPA_Issue25_Release1 0B3_Overview_Hybrid	
	<b>Document Type</b> DRAW/ELSY	<b>Edited</b> April/05/2023
	<b>Release Status</b> RELEASED	
	<b>Document No</b> 33409142	<b>Issue</b> 035

# 1A1 Electrical distribution CJB

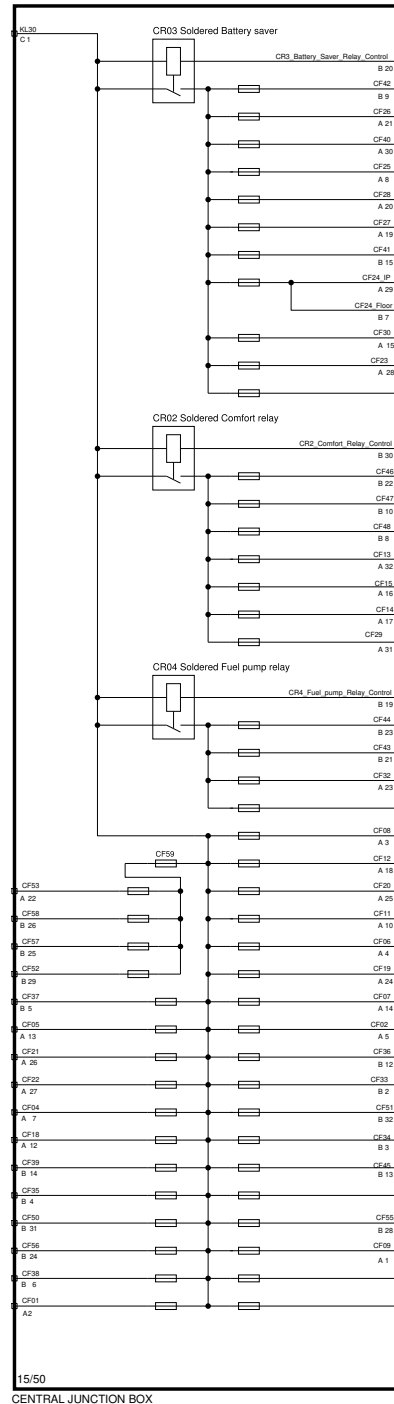

<p>The copying, distribution and utilization of this document as well as the communication of its contents to others without expressed authorization is prohibited. Offenders will be held liable for payment of damages. All rights reserved in the event of the grant of a patent, utility model or ornamental design registration.</p>	<p><b>Document title</b> SPA_Issue25_Release1 1A1_Electrical_distribution_CJB</p>		
	<p><b>Document Type</b> DRAW/ELSY</p>	<p><b>Edited</b> April/05/2023</p>	
<p><b>VOLVO</b> VOLVO CAR CORPORATION</p>	<p><b>Release Status</b> RELEASED</p>		
	<p><b>Document No</b> 33409142</p>	<p><b>Issue</b> 035</p>	<p><b>Page No</b> 6/177</p>

# 1A1 Electrical distribution EJB

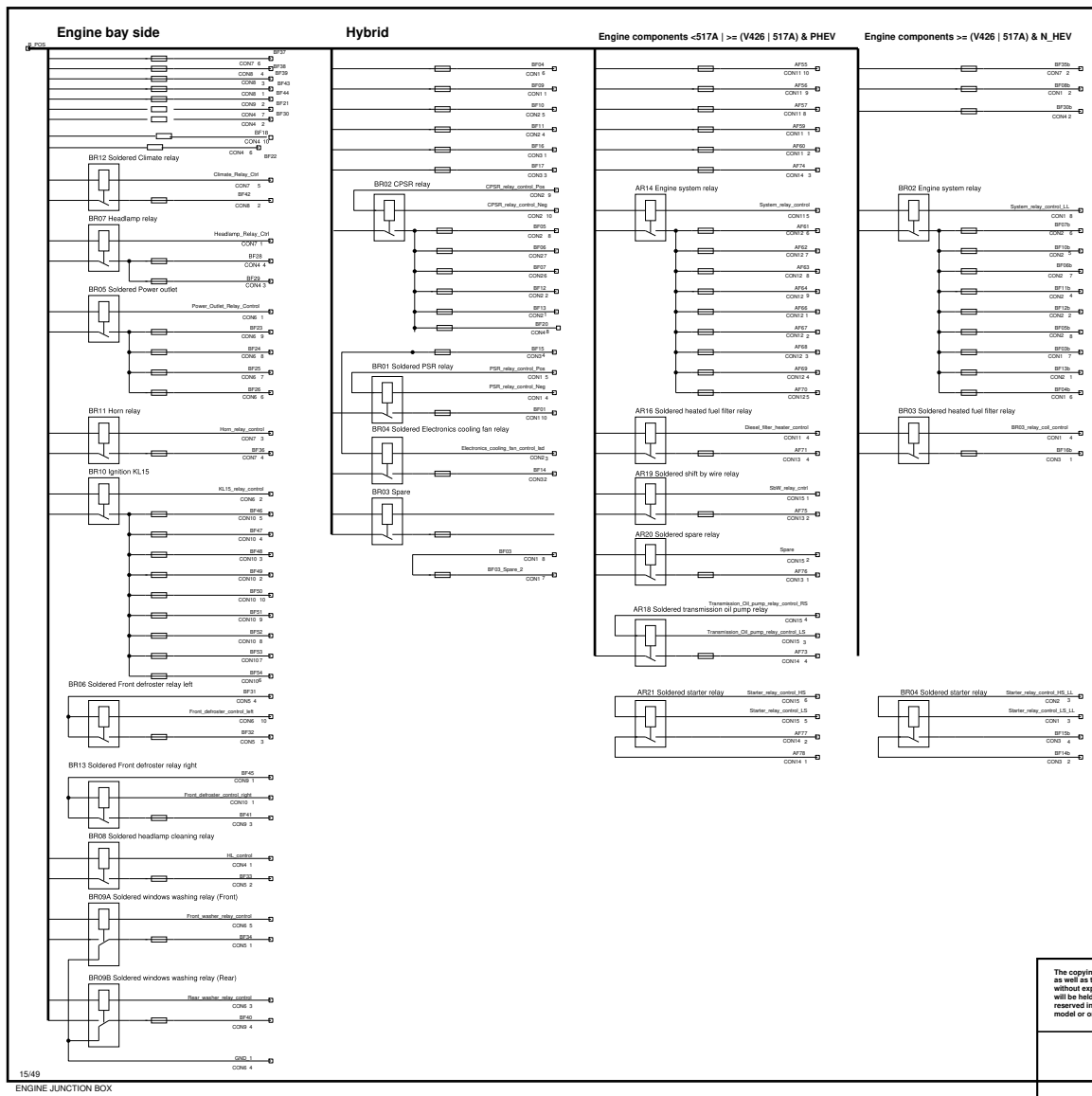

<p>The copying, distribution and utilization of this document as well as the communication of its contents to others without expressed authorization is prohibited. Offenders will be held liable for payment of damages. All rights reserved in the event of the grant of a patent, utility model or ornamental design registration.</p>		<p><b>Document title</b> SPA_Issue25_Release1 1A1_Electrical_distribution_EJB</p>	
		<p><b>Document Type</b> DRAW/ELSY</p>	<p><b>Edited</b> March/20/2023</p>
<p><b>VOLVO</b> VOLVO CAR CORPORATION</p>		<p><b>Release Status</b> RELEASED</p>	
		<p><b>Document No</b> 33409142</p>	<p><b>Issue</b> 035</p> <p><b>Page No</b> 7/177</p>

15/49  
ENGINE JUNCTION BOX



# 1A1 Electrical distribution RJB

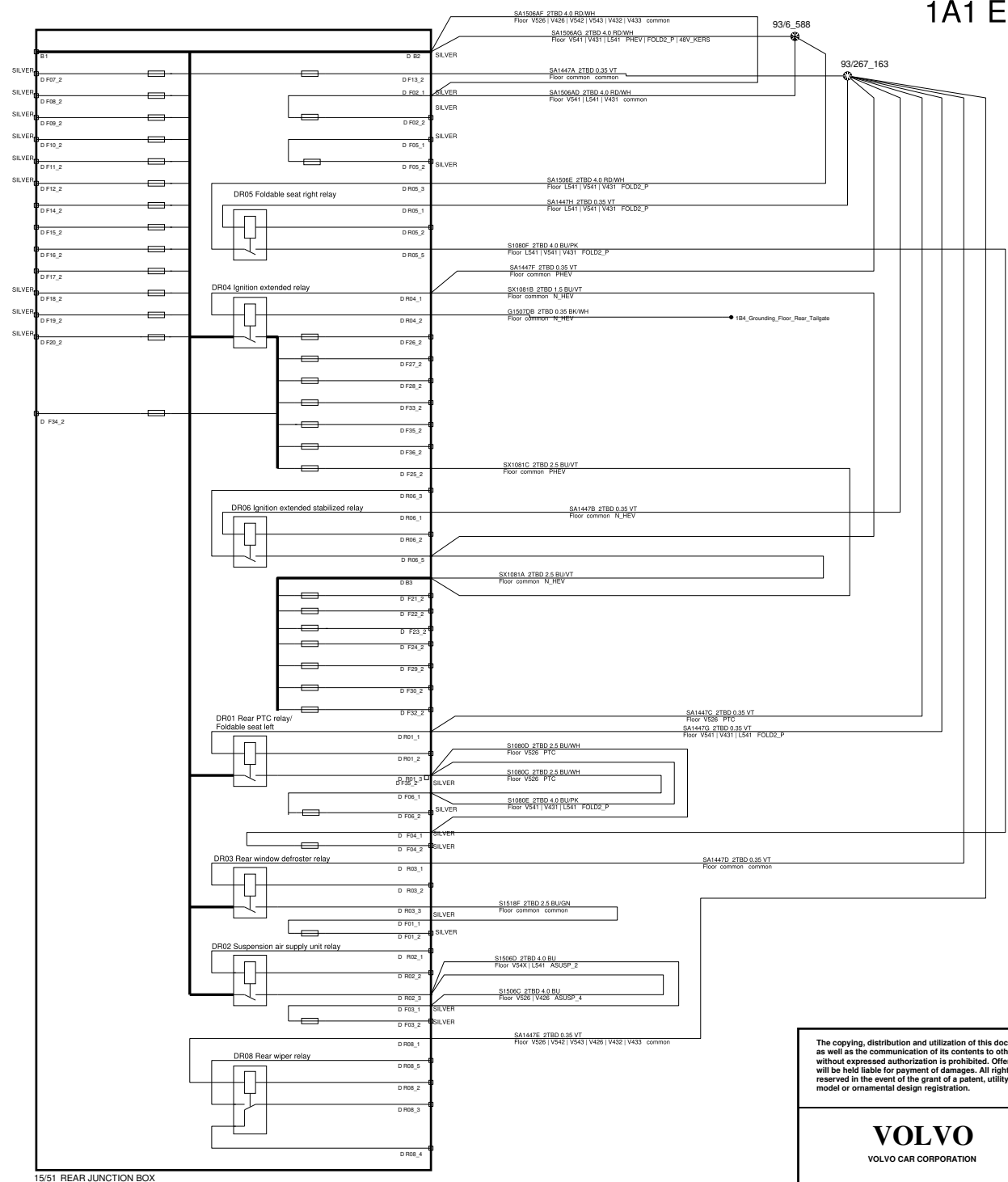

<p>The copying, distribution and utilization of this document as well as the communication of its contents to others without expressed authorization is prohibited. Offenders will be held liable for payment of damages. All rights reserved in the event of the grant of a patent, utility model or ornamental design registration.</p> <p><b>VOLVO</b> VOLVO CAR CORPORATION</p>	<p><b>Document title</b> SPA_Issue25_Release1 1A1_Electrical_distribution_RJB</p>		
	<p><b>Document Type</b> DRAW/ELSY</p>	<p><b>Edited</b> March/20/2023</p>	
	<p><b>Release Status</b> RELEASED</p>		
	<p><b>Document No</b> 33409142</p>	<p><b>Issue</b> 035</p>	<p><b>Page No</b> 8/177</p>



# 1A3 System relays control

A

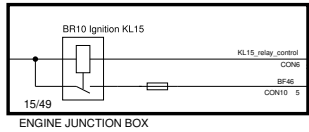

B

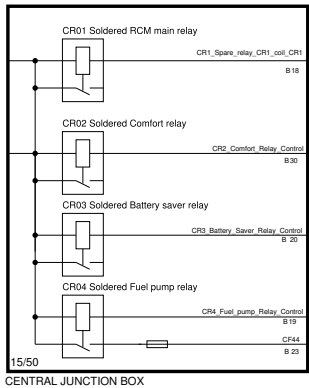

C

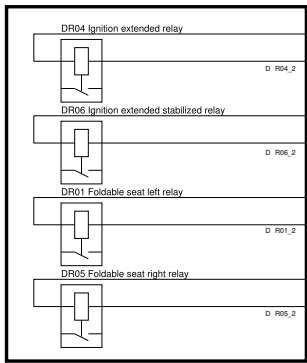

D

E

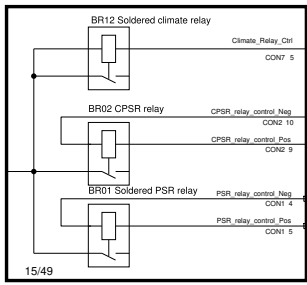

F

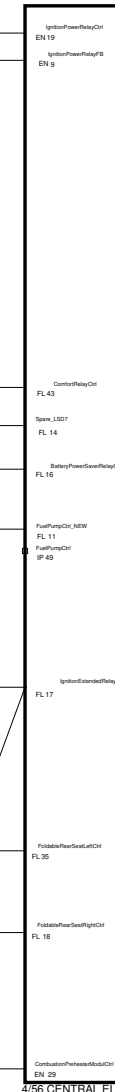
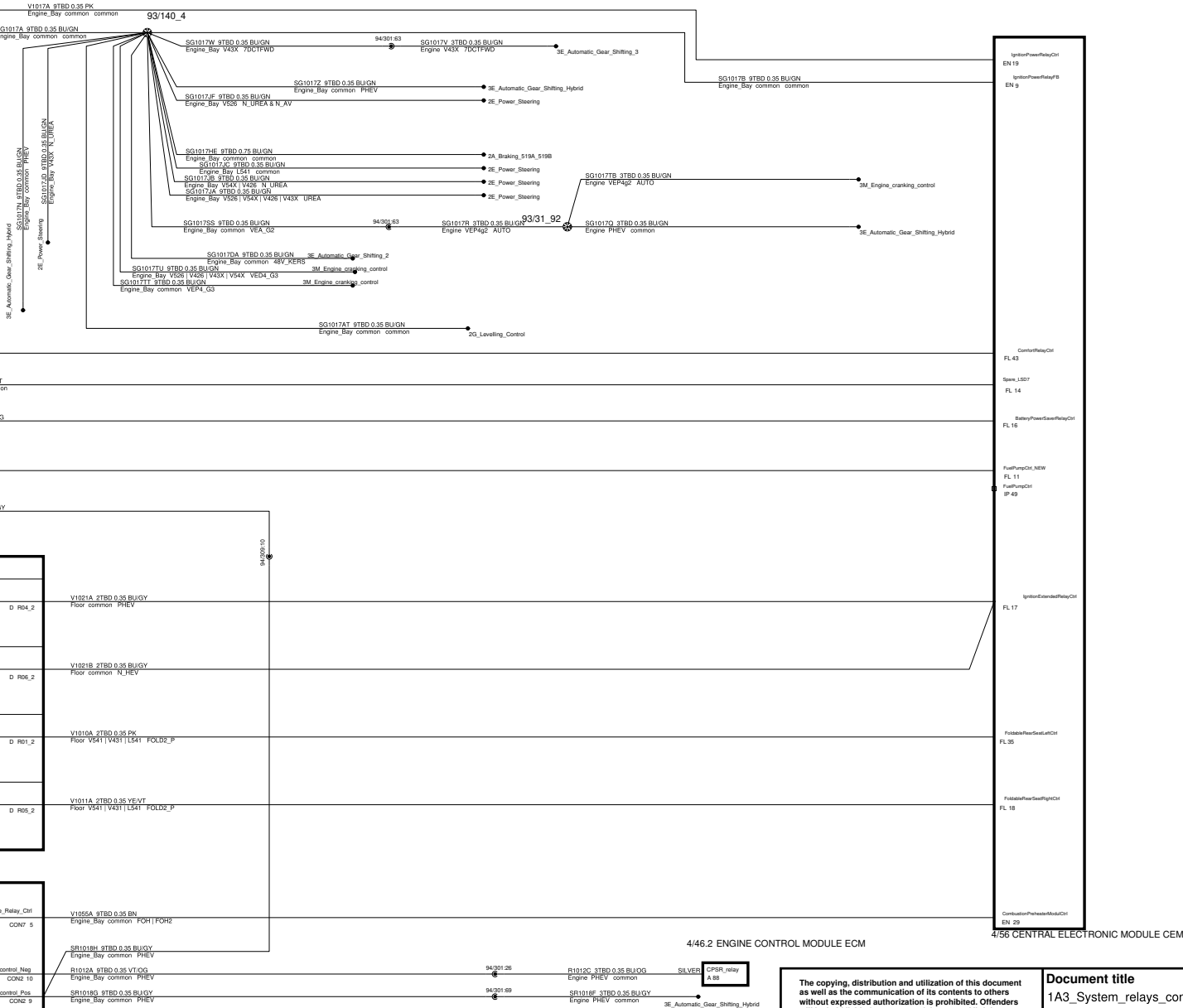

 VOLVO CAR CORPORATION	<b>Document title</b> SPA_Issue25_Release1 1A3_System_relays_control	
	<b>Document Type</b> DRAW/ELSY	<b>Edited</b> April/05/2023
<b>Release Status</b> RELEASED		
<b>Document No</b> 33409142	<b>Issue</b> 035	<b>Page No</b> 9/177

The copying, distribution and utilization of this document as well as the communication of its contents to others without expressed authorization is prohibited. Offenders will be held liable for payment of damages. All rights reserved in the event of the grant of a patent, utility model or ornamental design registration.



# 1B Grounding Engine, Engine Bay

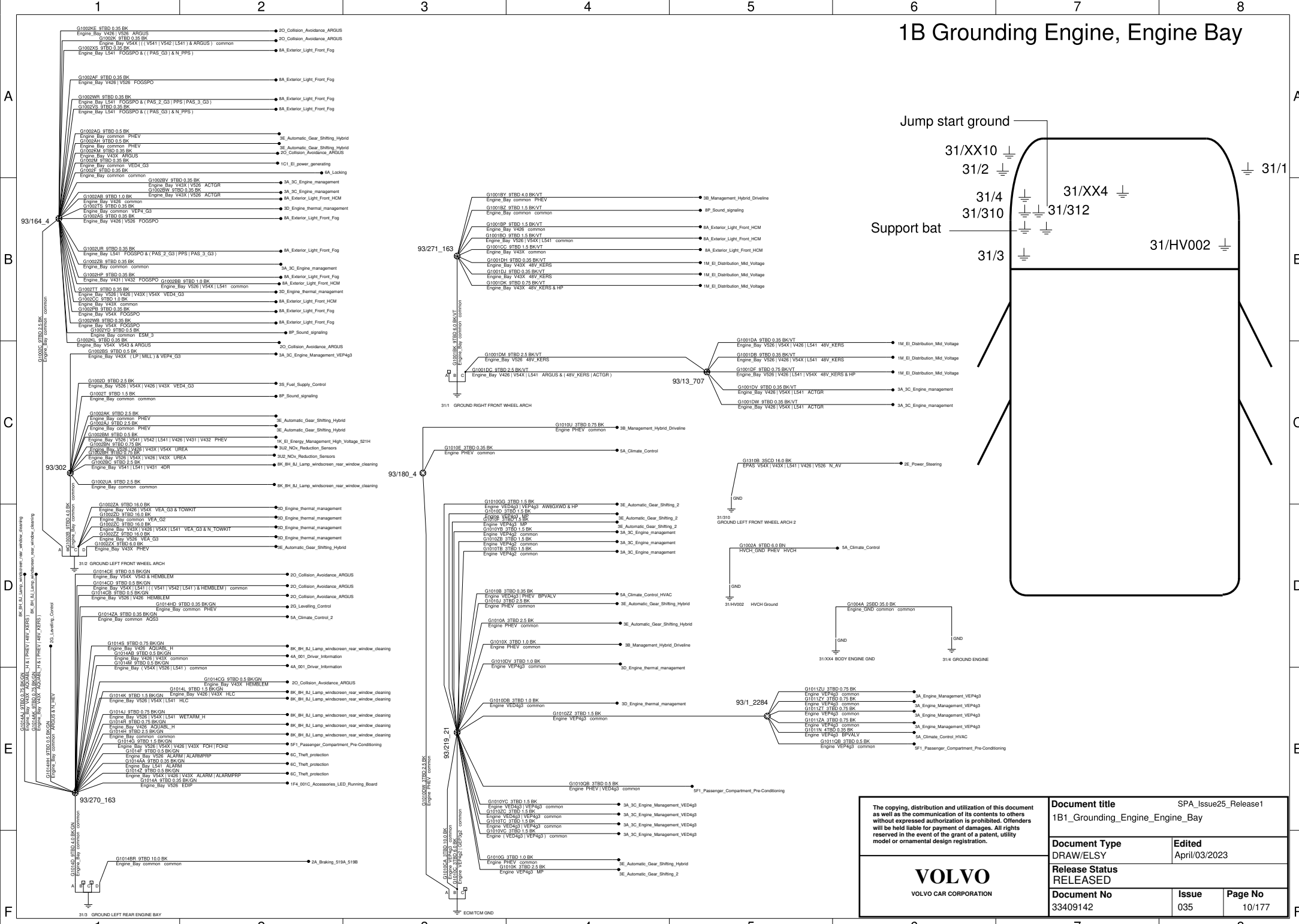

<p>The copying, distribution and utilization of this document as well as the communication of its contents to others without expressed authorization is prohibited. Offenders will be held liable for payment of damages. All rights reserved in the event of the grant of a patent, utility model or ornamental design registration.</p>		<p>Document title SPA_Issue25_Release1 1B1_Grounding_Engine_Engine_Bay</p>	
<p>Document Type DRAW/ELSY</p>	<p>Edited April/03/2023</p>		
<p>Release Status RELEASED</p>			
<p>Document No 33409142</p>	<p>Issue 035</p>	<p>Page No 10/177</p>	



VOLVO CAR CORPORATION



# 1B Grounding Floor Front

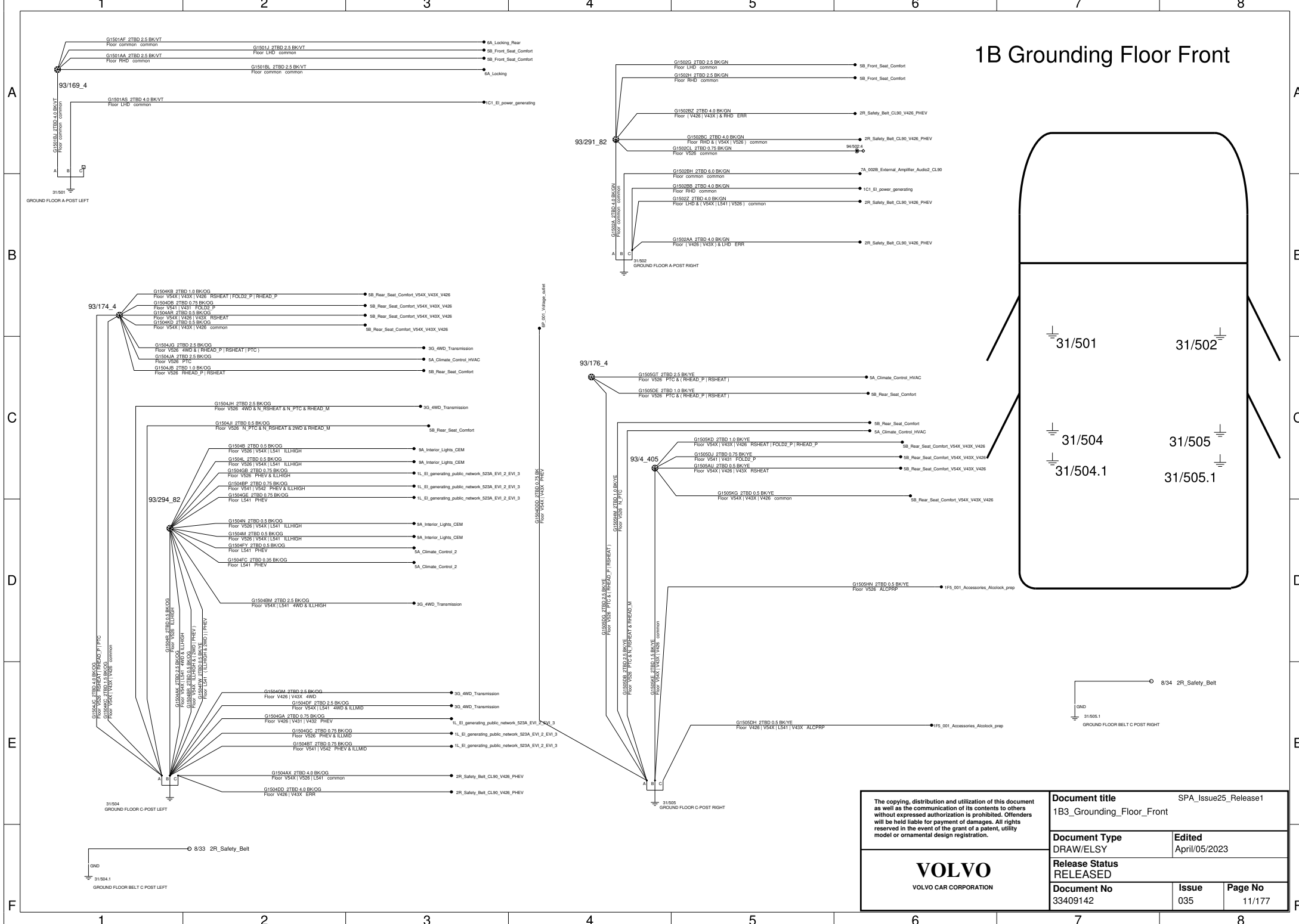

The copying, distribution and utilization of this document as well as the communication of its contents to others without expressed authorization is prohibited. Offenders will be held liable for payment of damages. All rights reserved in the event of the grant of a patent, utility model or ornamental design registration.		<b>Document title</b> SPA_Issue25_Release1	
		<b>Document Type</b> DRAW/ELSY	
<b>VOLVO</b> VOLVO CAR CORPORATION		<b>Released Status</b> RELEASED	
		<b>Document No</b> 33409142	
		<b>Issue</b> 035	<b>Page No</b> 11/177

# 1B Grounding Floor Front L541

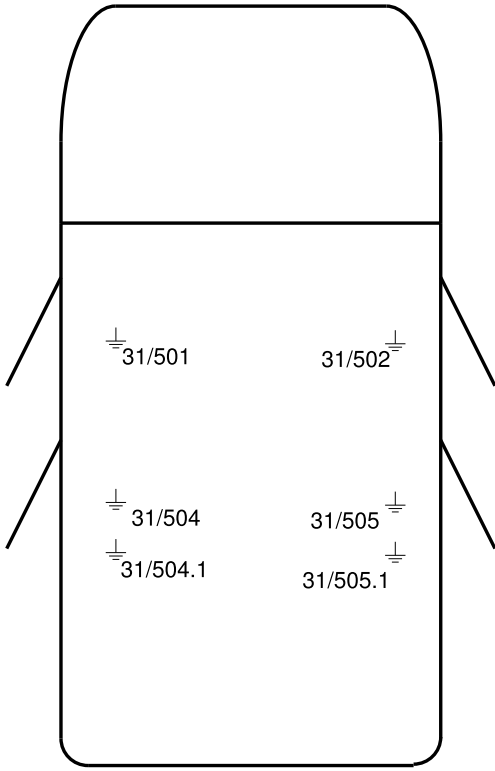
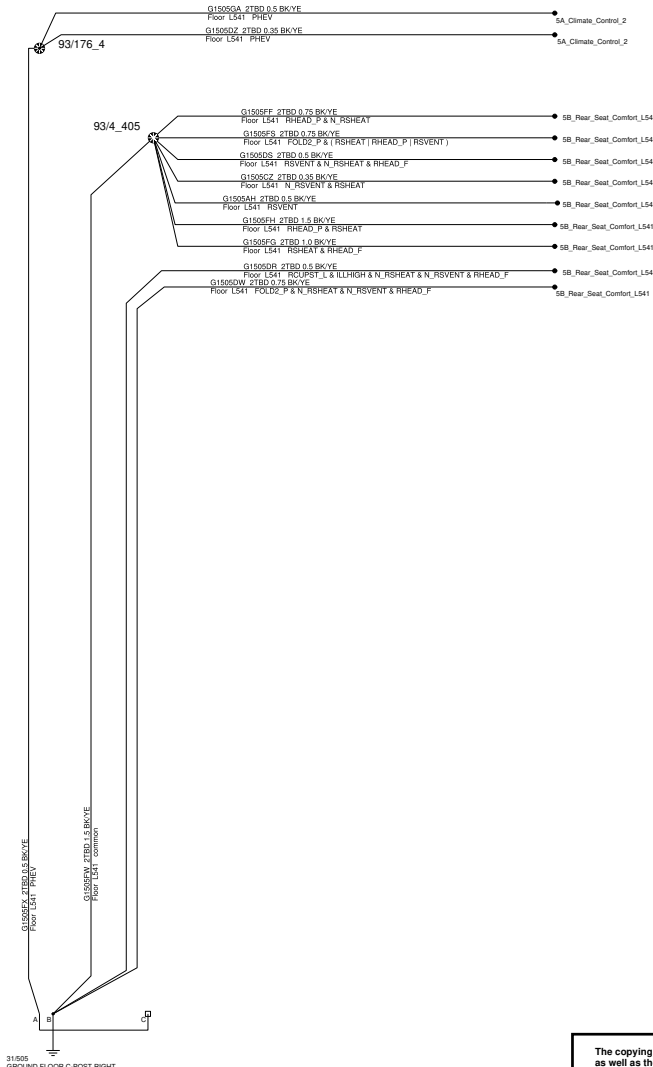
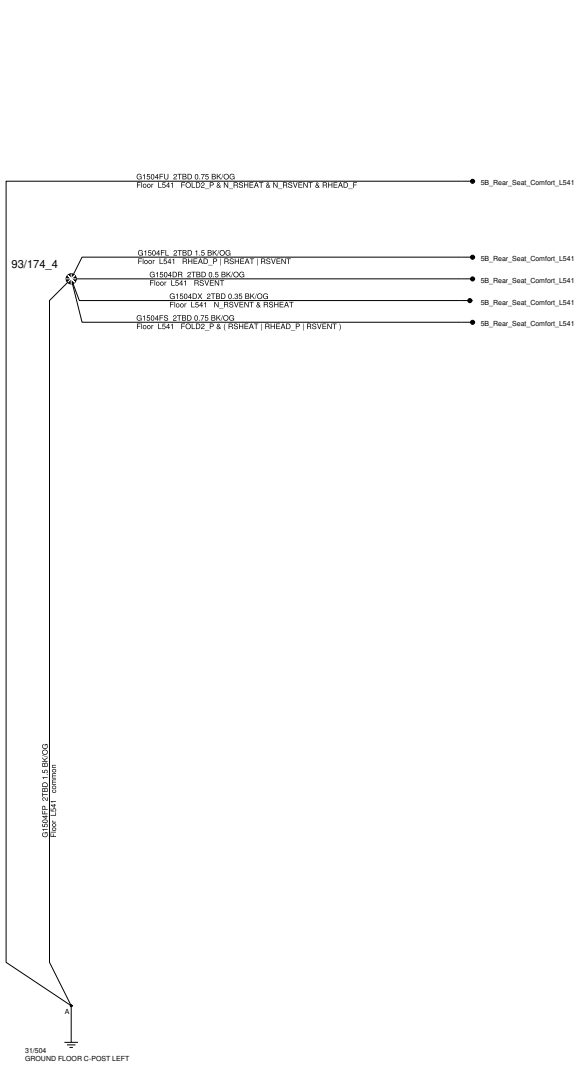

<p>The copying, distribution and utilization of this document as well as the communication of its contents to others without expressed authorization is prohibited. Offenders will be held liable for payment of damages. All rights reserved in the event of the grant of a patent, utility model or ornamental design registration.</p>		<p><b>Document title</b> SPA_Issue25_Release1</p>	
		<p>1B3_Grounding_Floor_Front_L541</p>	
<p><b>Document Type</b> DRAW/ELSY</p>		<p><b>Edited</b> March/14/2023</p>	
<p><b>Release Status</b> RELEASED</p>			
<p><b>Document No</b> 33409142</p>		<p><b>Issue</b> 035</p>	<p><b>Page No</b> 12/177</p>



# 1B Grounding Floor Rear, Tailgate

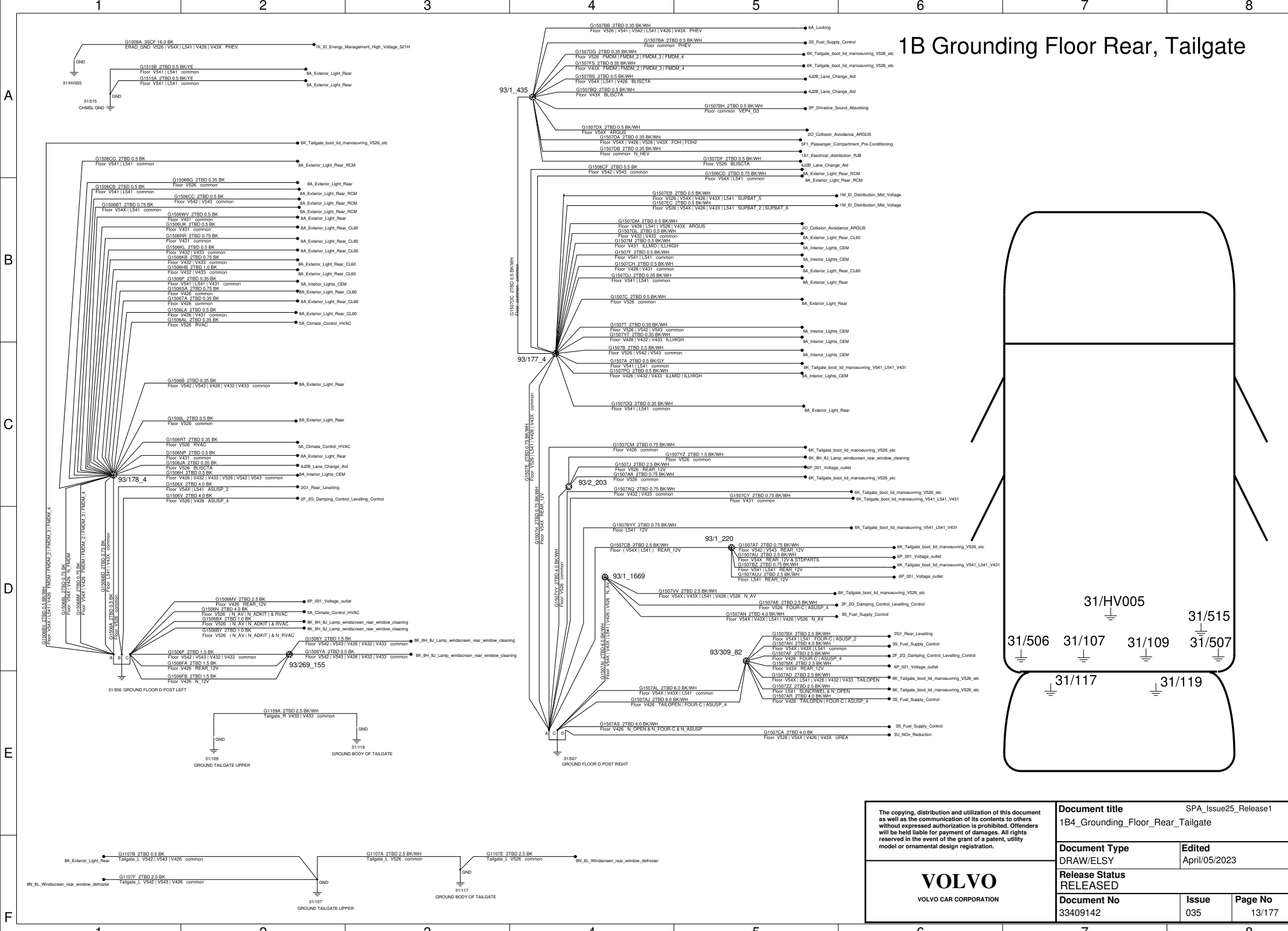

# 1C1 El. Power generating

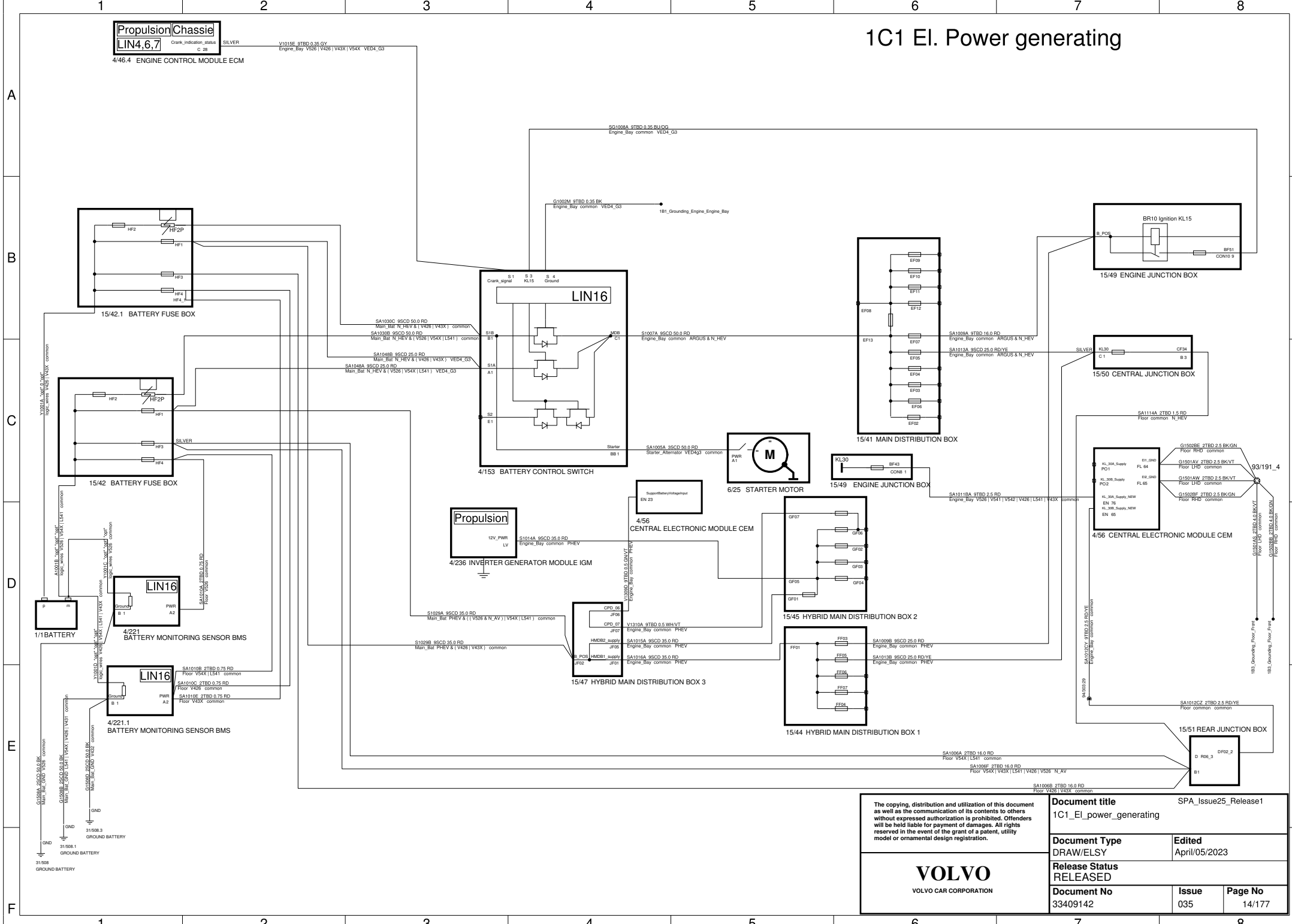

<p>The copying, distribution and utilization of this document as well as the communication of its contents to others without expressed authorization is prohibited. Offenders will be held liable for payment of damages. All rights reserved in the event of the grant of a patent, utility model or ornamental design registration.</p>		<p>Document title 1C1_El_power_generating</p>		<p>SPA_Issue25_Release1</p>	
<p>Document Type DRAW/ELSY</p>		<p>Edited April/05/2023</p>			
<p>Release Status RELEASED</p>					
<p>Document No 33409142</p>		<p>Issue 035</p>		<p>Page No 14/177</p>	



VOLVO CAR CORPORATION

# 1D Diagnostics with Diagnostics CAN 519G, and iCUP CL90 w VCU1

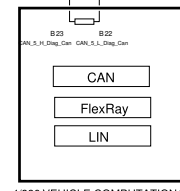
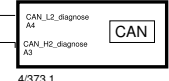
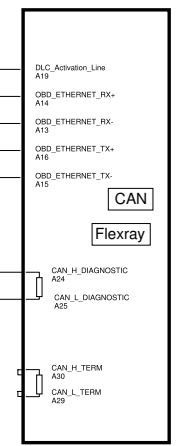
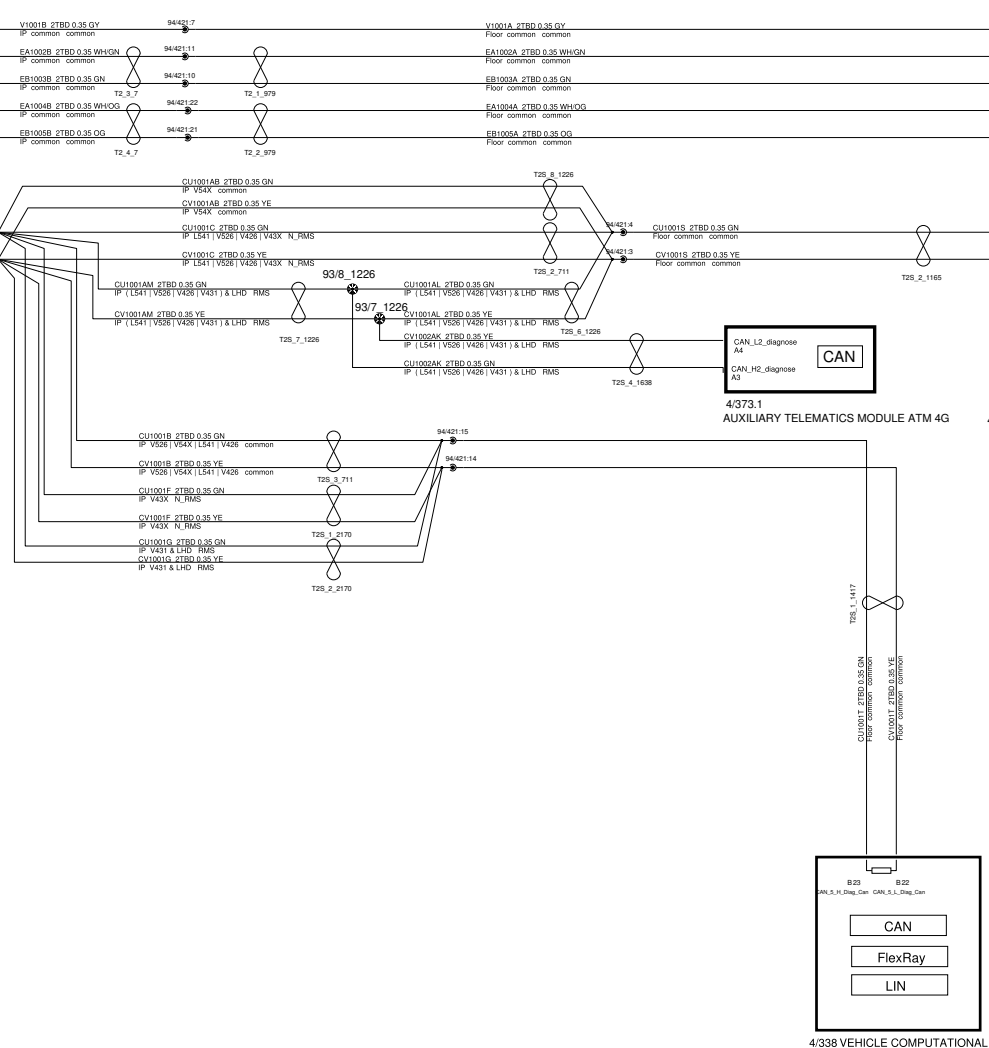
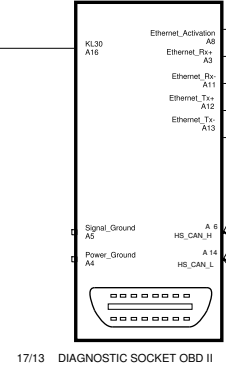
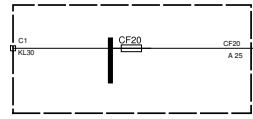

The copying, distribution and utilization of this document as well as the communication of its contents to others without expressed authorization is prohibited. Offenders will be held liable for payment of damages. All rights reserved in the event of the grant of a patent, utility model or ornamental design registration.	<b>Document title</b> SPA_Issue25_Release1	
	1D_003_Diagnostics_VCU1	
<b>Document Type</b> DRAW/ELSY	<b>Edited</b> April/05/2023	
<b>Release Status</b> RELEASED		
<b>Document No</b> 33409142	<b>Issue</b> 035	<b>Page No</b> 15/177





# 1E Flexray Backbone CL90 LHD

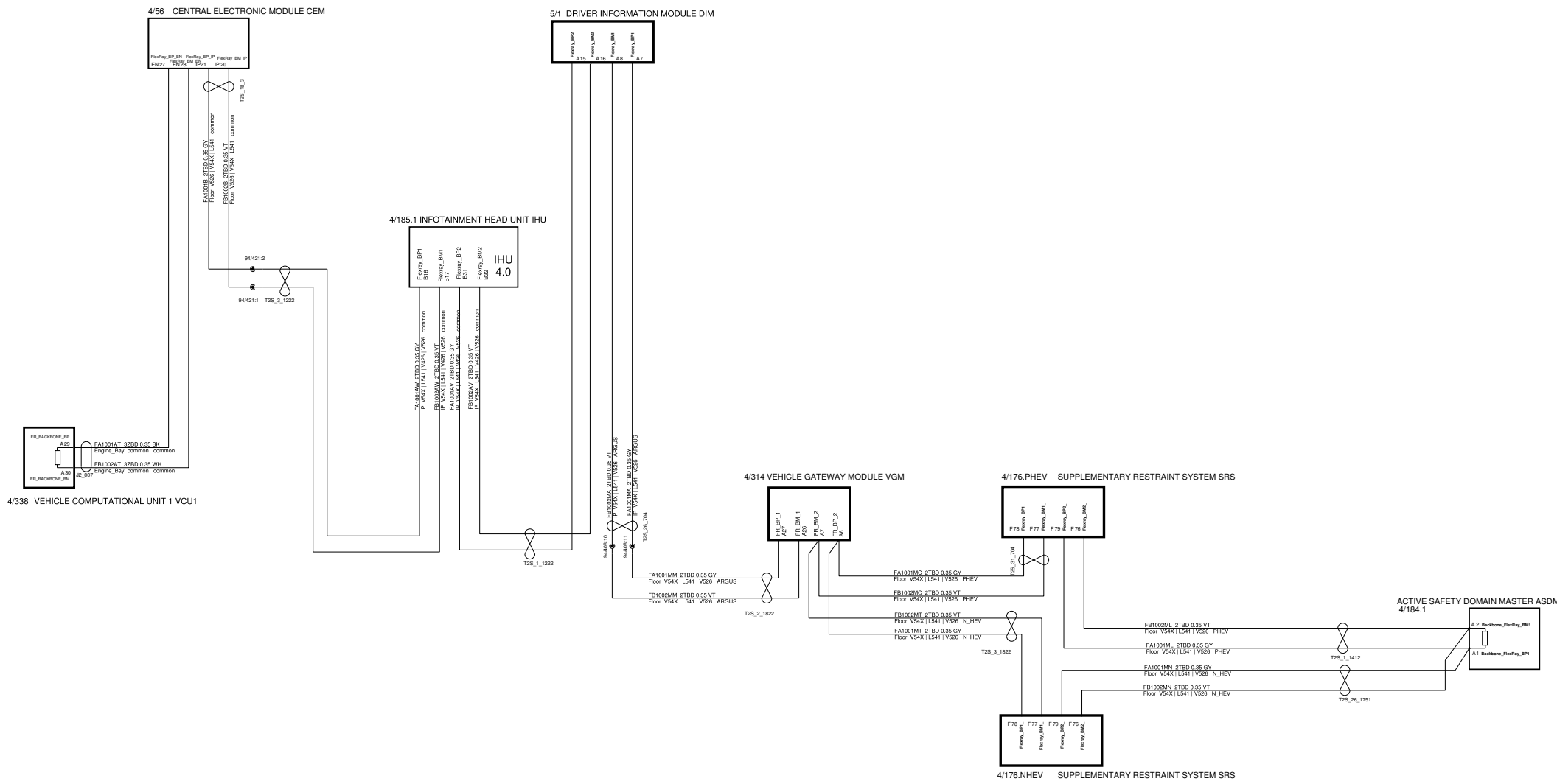

The copying, distribution and utilization of this document as well as the communication of its contents to others without expressed authorization is prohibited. Offenders will be held liable for payment of damages. All rights reserved in the event of the grant of a patent, utility model or ornamental design registration.

**VOLVO**  
VOLVO CAR CORPORATION

<b>Document title</b> 1E_001B_Flexray_Backbone_CL90		SPA_Issue25_Release1	
<b>Document Type</b> DRAW/ELSY	<b>Edited</b> April/05/2023		
<b>Release Status</b> RELEASED			
<b>Document No</b> 33409142	<b>Issue</b> 035	<b>Page No</b> 16/177	



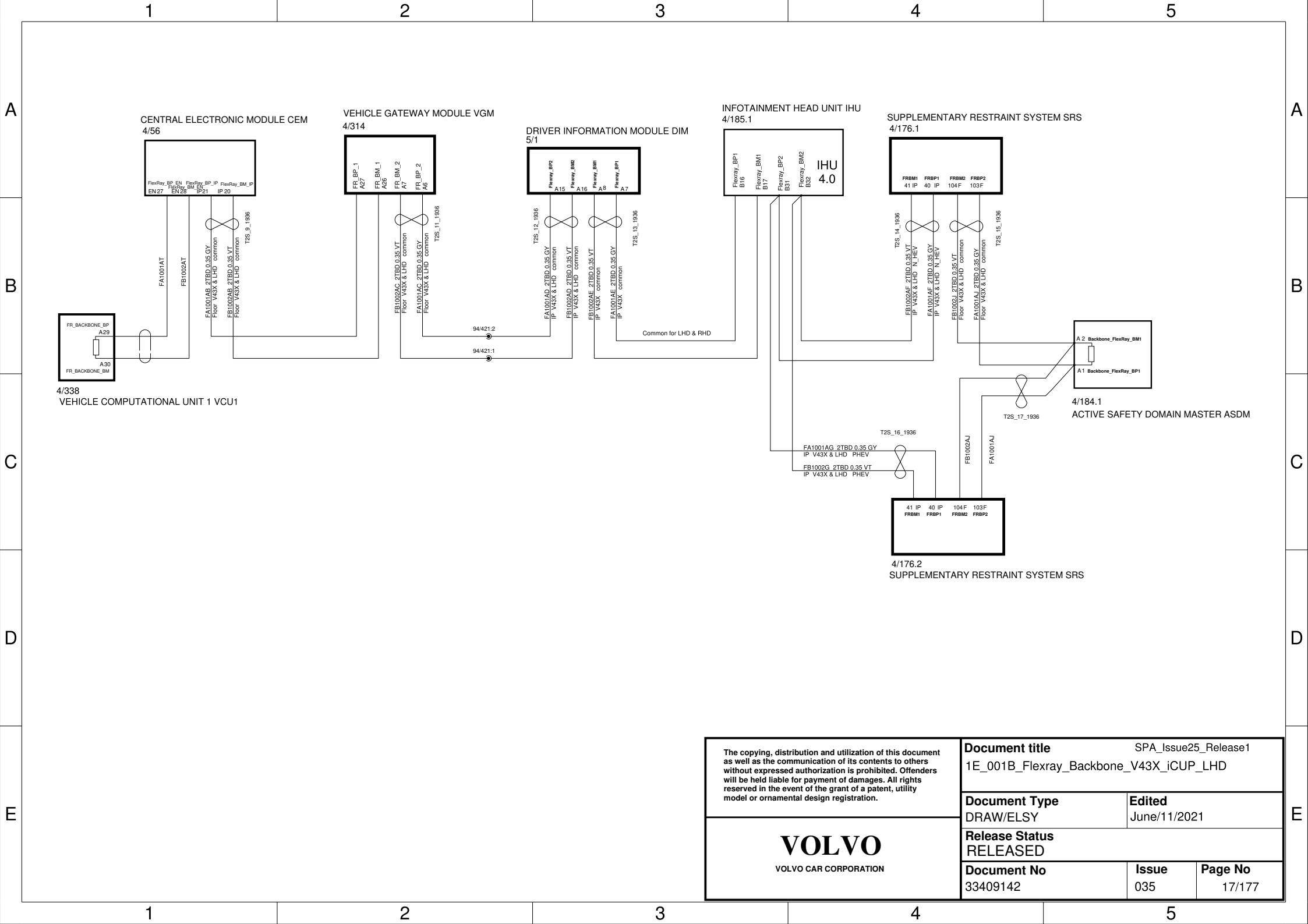

<p>The copying, distribution and utilization of this document as well as the communication of its contents to others without expressed authorization is prohibited. Offenders will be held liable for payment of damages. All rights reserved in the event of the grant of a patent, utility model or ornamental design registration.</p> <p><b>VOLVO</b> VOLVO CAR CORPORATION</p>	<p><b>Document title</b> SPA_Issue25_Release1 1E_001B_Flexray_Backbone_V43X_iCUP_LHD</p>		
	<p><b>Document Type</b> DRAW/ELSY</p>	<p><b>Edited</b> June/11/2021</p>	
	<p><b>Release Status</b> RELEASED</p>		
	<p><b>Document No</b> 33409142</p>	<p><b>Issue</b> 035</p>	<p><b>Page No</b> 17/177</p>

**CENTRAL ELECTRONIC MODULE CEM**  
4/56

**SUPPLEMENTARY RESTRAINT SYSTEM SRS**  
4/176.1

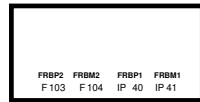
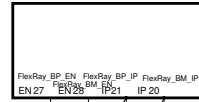

**DRIVER INFORMATION MODULE DIM**  
5/1

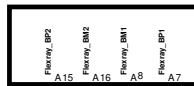

**INFOTAINMENT HEAD UNIT IHU**  
4/185.1

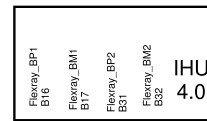

**VEHICLE GATEWAY MODULE VGM**  
4/314

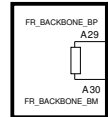
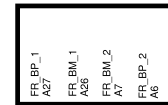

4/338  
**VEHICLE COMPUTATIONAL UNIT 1 VCU1**

**SUPPLEMENTARY RESTRAINT SYSTEM SRS**  
4/176.2

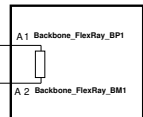
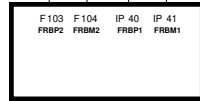

4/184.1  
**ACTIVE SAFETY DOMAIN MASTER ASDM**

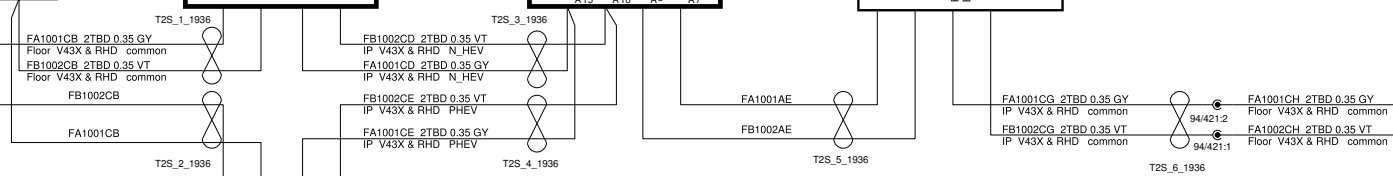

# 1E Flexray Backbone V426 LHD

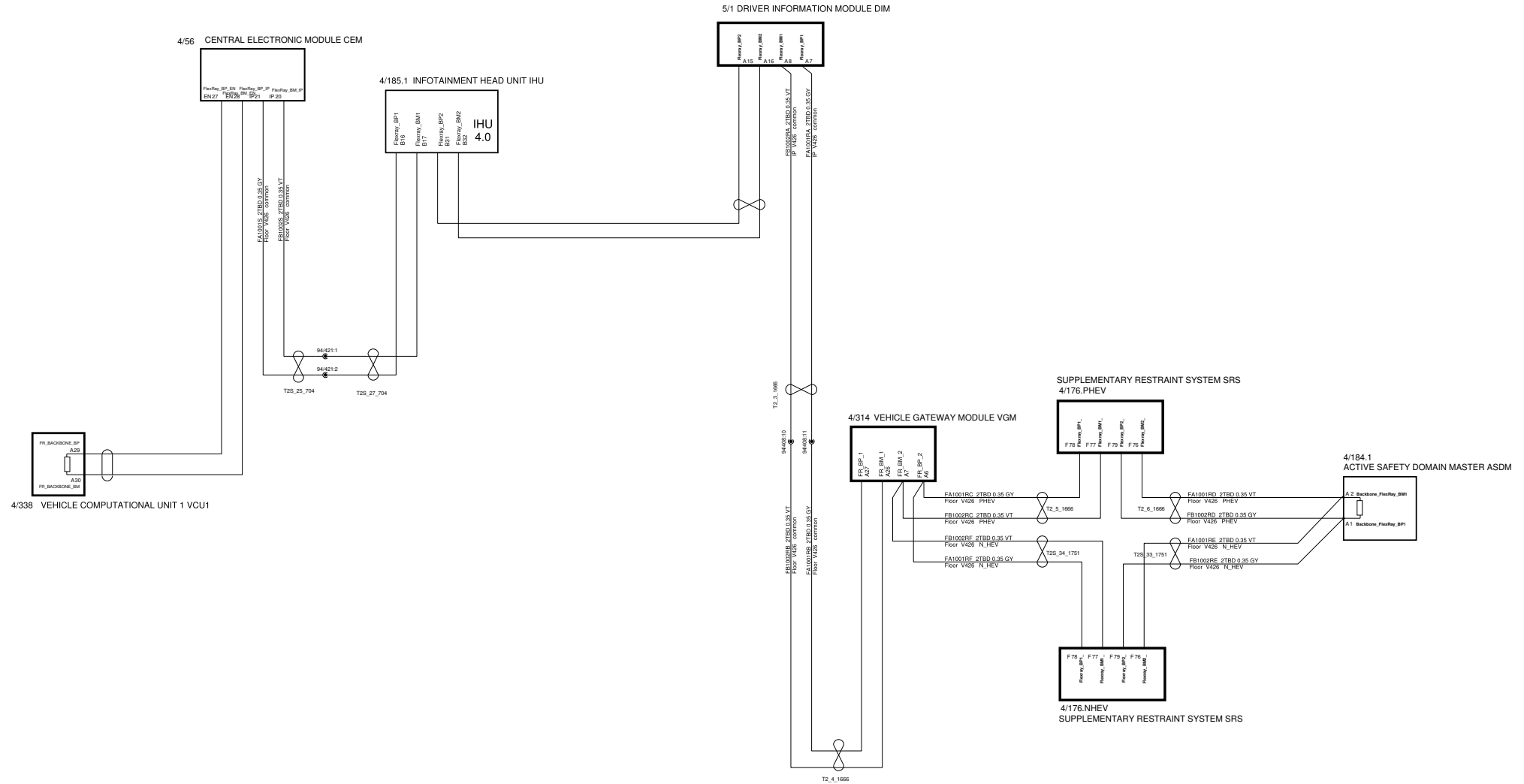

<p>The copying, distribution and utilization of this document as well as the communication of its contents to others without expressed authorization is prohibited. Offenders will be held liable for payment of damages. All rights reserved in the event of the grant of a patent, utility model or ornamental design registration.</p> <p><b>VOLVO</b> VOLVO CAR CORPORATION</p>	<p><b>Document title</b> SPA_Issue25_Release1 1E_001B_Flexray_Backbone_V426</p>		
	<p><b>Document Type</b> DRAW/ELSY</p>	<p><b>Edited</b> April/05/2023</p>	
<p><b>Release Status</b> RELEASED</p>			
<p><b>Document No</b> 33409142</p>	<p><b>Issue</b> 035</p>	<p><b>Page No</b> 19/177</p>	

1E Flexray Mid 2  
1E Flexray Front 2

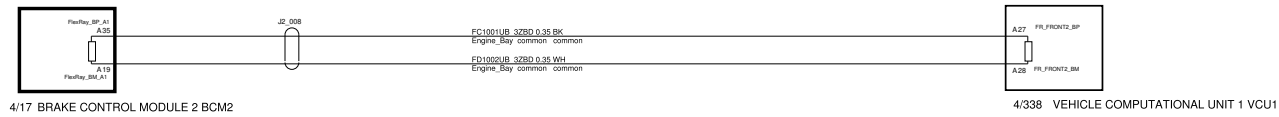
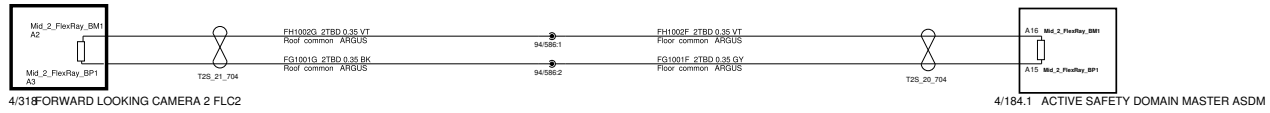

<p>The copying, distribution and utilization of this document as well as the communication of its contents to others without expressed authorization is prohibited. Offenders will be held liable for payment of damages. All rights reserved in the event of the grant of a patent, utility model or ornamental design registration.</p> <p><b>VOLVO</b> VOLVO CAR CORPORATION</p>	<p><b>Document title</b> SPA_Issue25_Release1 1E_001B_Flexray_Front2_Mid2</p>		
	<p><b>Document Type</b> DRAW/ELSY</p>	<p><b>Edited</b> April/05/2023</p>	
	<p><b>Release Status</b> RELEASED</p>		
	<p><b>Document No</b> 33409142</p>	<p><b>Issue</b> 035</p>	<p><b>Page No</b> 20/177</p>

# 1E Body-CAN LHD

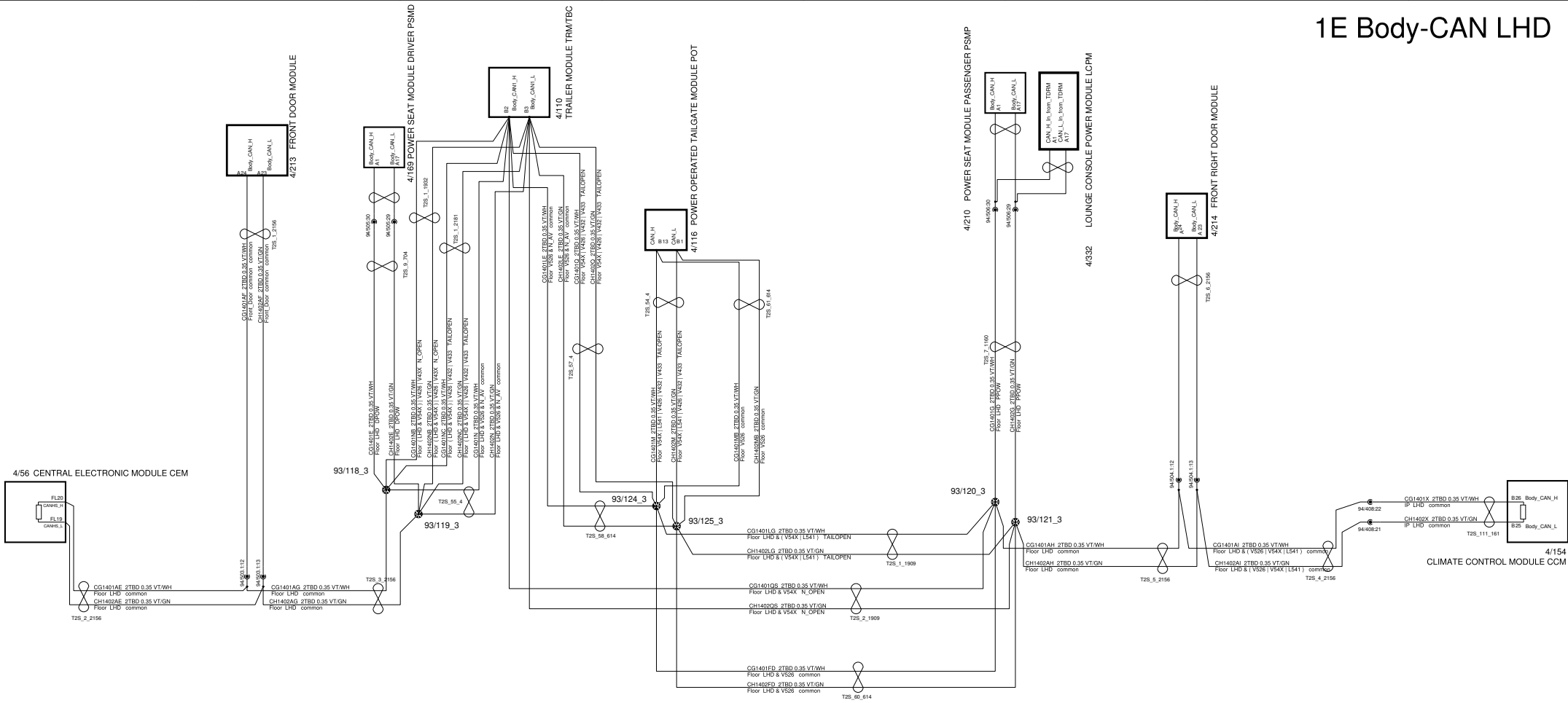

<p>The copying, distribution and utilization of this document as well as the communication of its contents to others without expressed authorization is prohibited. Offenders will be held liable for payment of damages. All rights reserved in the event of the grant of a patent, utility model or ornamental design registration.</p>		<p>Document title SPA_Issue25_Release1</p>	
		<p>1E_002_Body_CAN_LHD</p>	
<p>Document Type DRAW/ELSY</p>		<p>Edited April/05/2023</p>	
<p>Release Status RELEASED</p>			
<p>Document No 33409142</p>		<p>Issue 035</p>	<p>Page No 21/177</p>



A  
B  
C  
D  
E  
F

A  
B  
C  
D  
E  
F

1 2 3 4 5 6 7 8

# 1E Body-CAN LHD CL60 unique

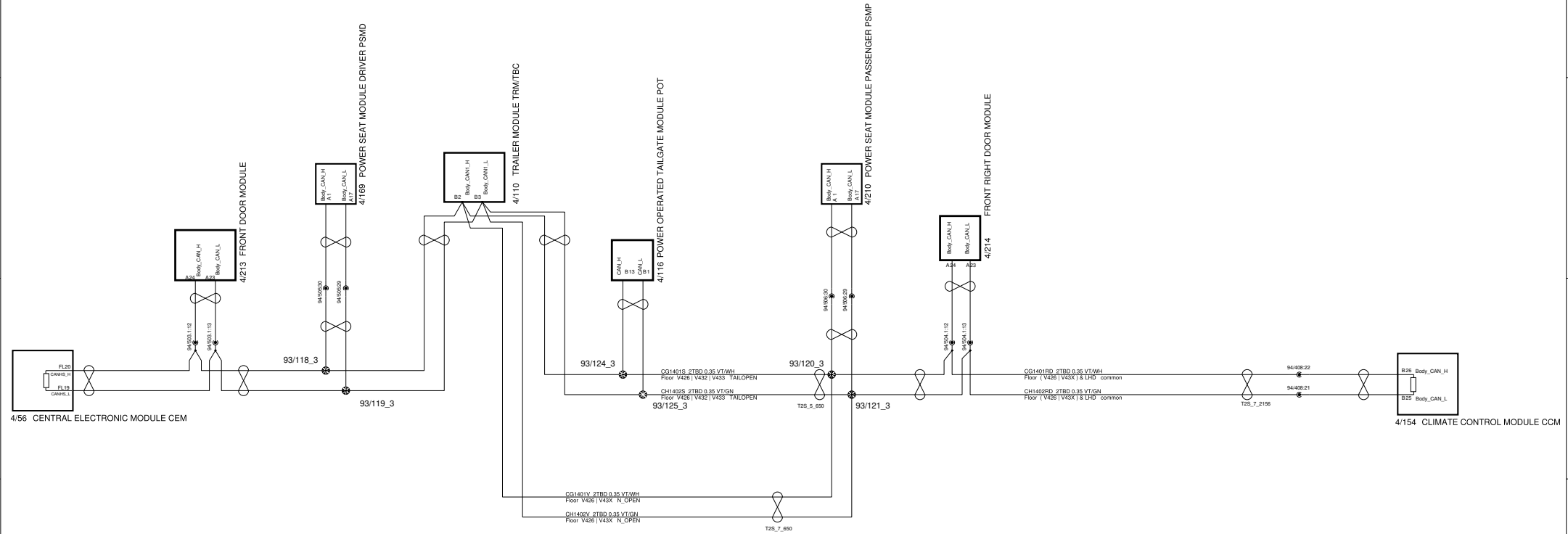

<p>The copying, distribution and utilization of this document as well as the communication of its contents to others without expressed authorization is prohibited. Offenders will be held liable for payment of damages. All rights reserved in the event of the grant of a patent, utility model or ornamental design registration.</p>	<p><b>Document title</b> SPA_Issue25_Release1 1E_002_Body_CAN_LHD_CL60</p>		
	<p><b>Document Type</b> DRAW/ELSY</p>	<p><b>Edited</b> April/05/2023</p>	
<p><b>VOLVO</b> VOLVO CAR CORPORATION</p>	<p><b>Release Status</b> RELEASED</p>		
	<p><b>Document No</b> 33409142</p>	<p><b>Issue</b> 035</p>	<p><b>Page No</b> 22/177</p>

# 1E Body-CAN LHD L541 unique

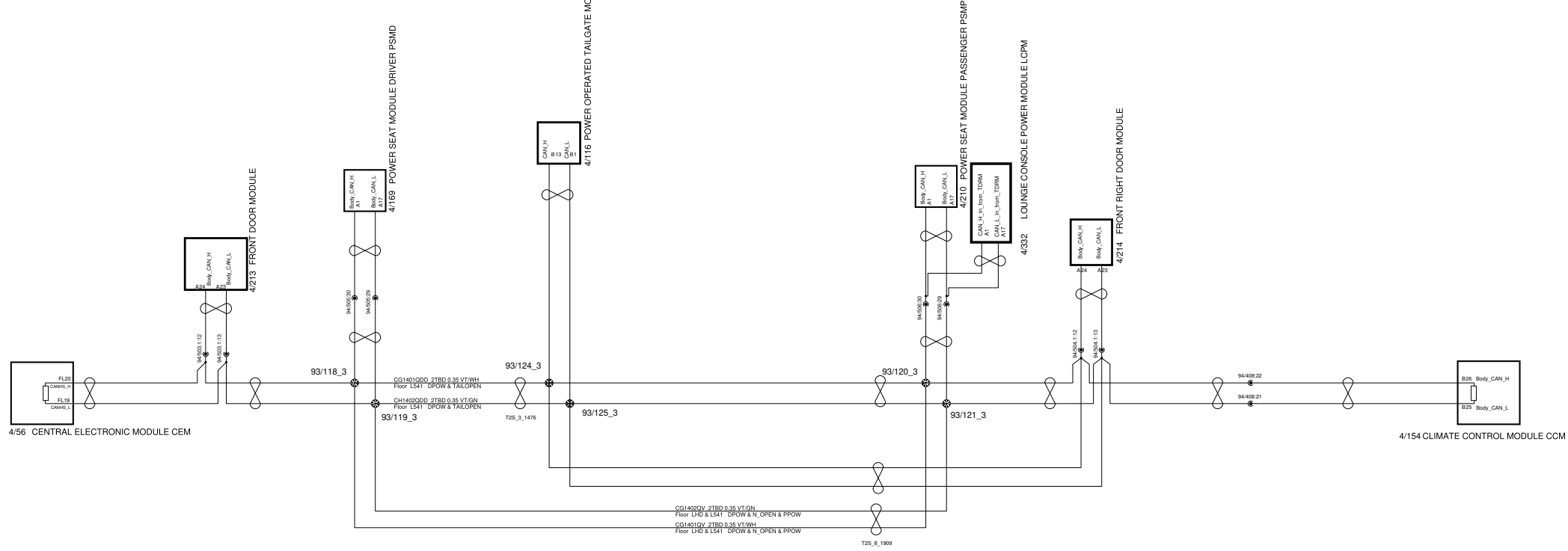

<p>The copying, distribution and utilization of this document as well as the communication of its contents to others without expressed authorization is prohibited. Offenders will be held liable for payment of damages. All rights reserved in the event of the grant of a patent, utility model or ornamental design registration.</p> <p><b>VOLVO</b> VOLVO CAR CORPORATION</p>	<b>Document title</b> SPA_Issue25_Release1 1E_002_Body_CAN_LHD_L541		
	<b>Document Type</b> DRAW/ELSY	<b>Edited</b> April/05/2023	
	<b>Release Status</b> RELEASED		
	<b>Document No</b> 33409142	<b>Issue</b> 035	<b>Page No</b> 23/177



# 1E Body-CAN RHD

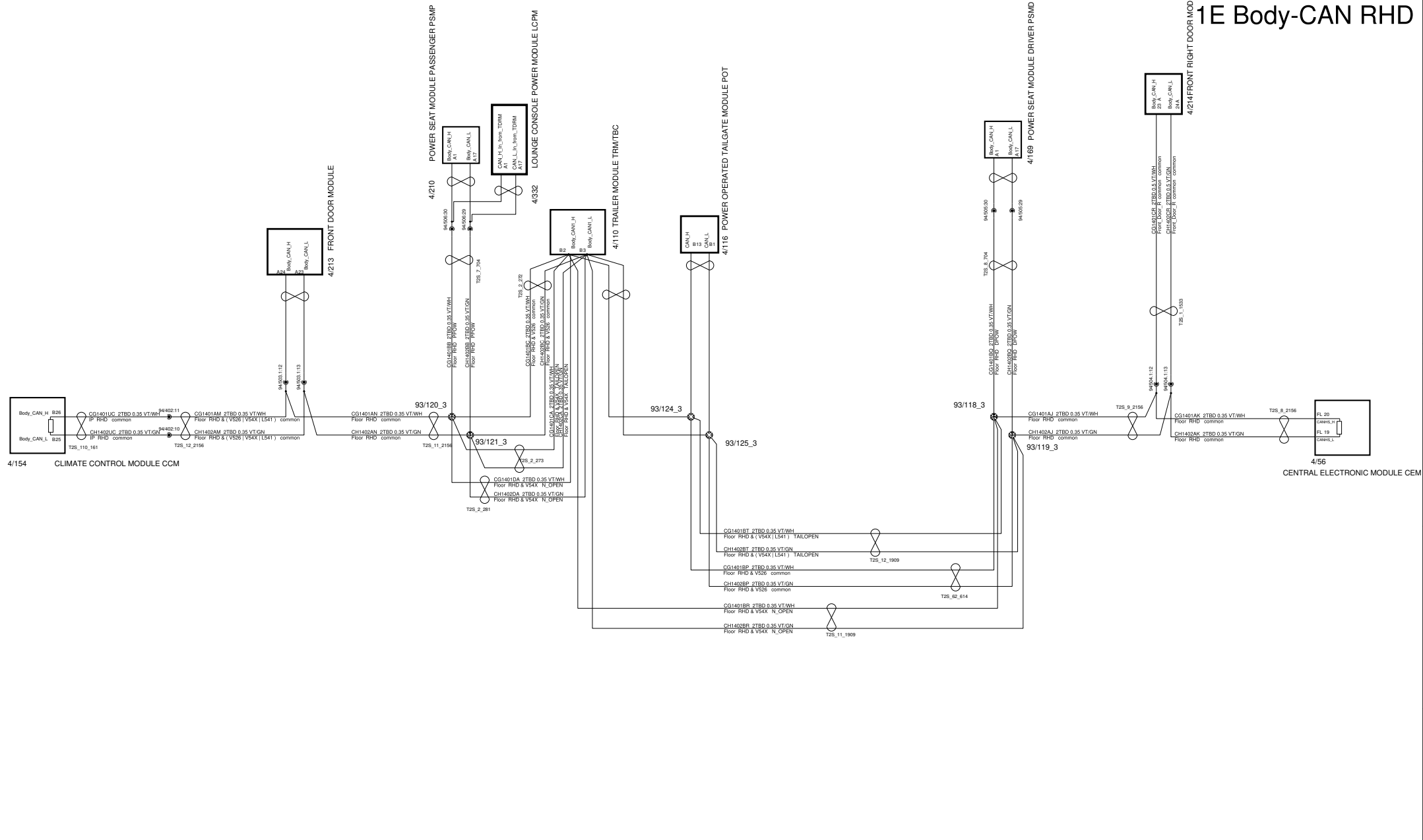

<p>The copying, distribution and utilization of this document as well as the communication of its contents to others without expressed authorization is prohibited. Offenders will be held liable for payment of damages. All rights reserved in the event of the grant of a patent, utility model or ornamental design registration.</p> <p><b>VOLVO</b> VOLVO CAR CORPORATION</p>	<p><b>Document title</b> SPA_Issue25_Release1 1E_002_Body_CAN_RHD</p>	
	<p><b>Document Type</b> DRAW/ELSY</p>	<p><b>Edited</b> April/05/2023</p>
<p><b>Release Status</b> RELEASED</p>		
<p><b>Document No</b> 33409142</p>	<p><b>Issue</b> 035</p>	<p><b>Page No</b> 24/177</p>

# 1E Body-CAN RHD CL60 unique

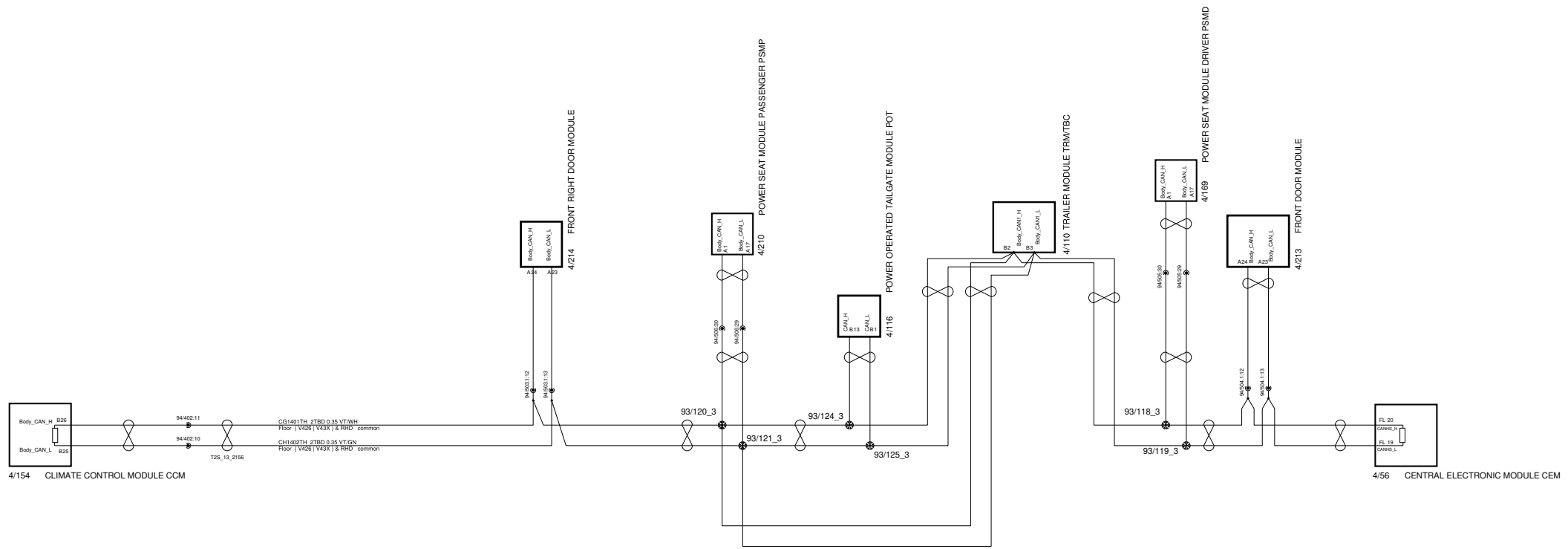

<p>The copying, distribution and utilization of this document as well as the communication of its contents to others without expressed authorization is prohibited. Offenders will be held liable for payment of damages. All rights reserved in the event of the grant of a patent, utility model or ornamental design registration.</p> <p><b>VOLVO</b> VOLVO CAR CORPORATION</p>	<b>Document title</b> SPA_Issue25_Release1 1E_002_Body_CAN_RHD_CL60	
	<b>Document Type</b> DRAW/ELSY	<b>Edited</b> April/05/2023
	<b>Release Status</b> RELEASED	
	<b>Document No</b> 33409142	<b>Issue</b> 035

# 1E Front CAN 1

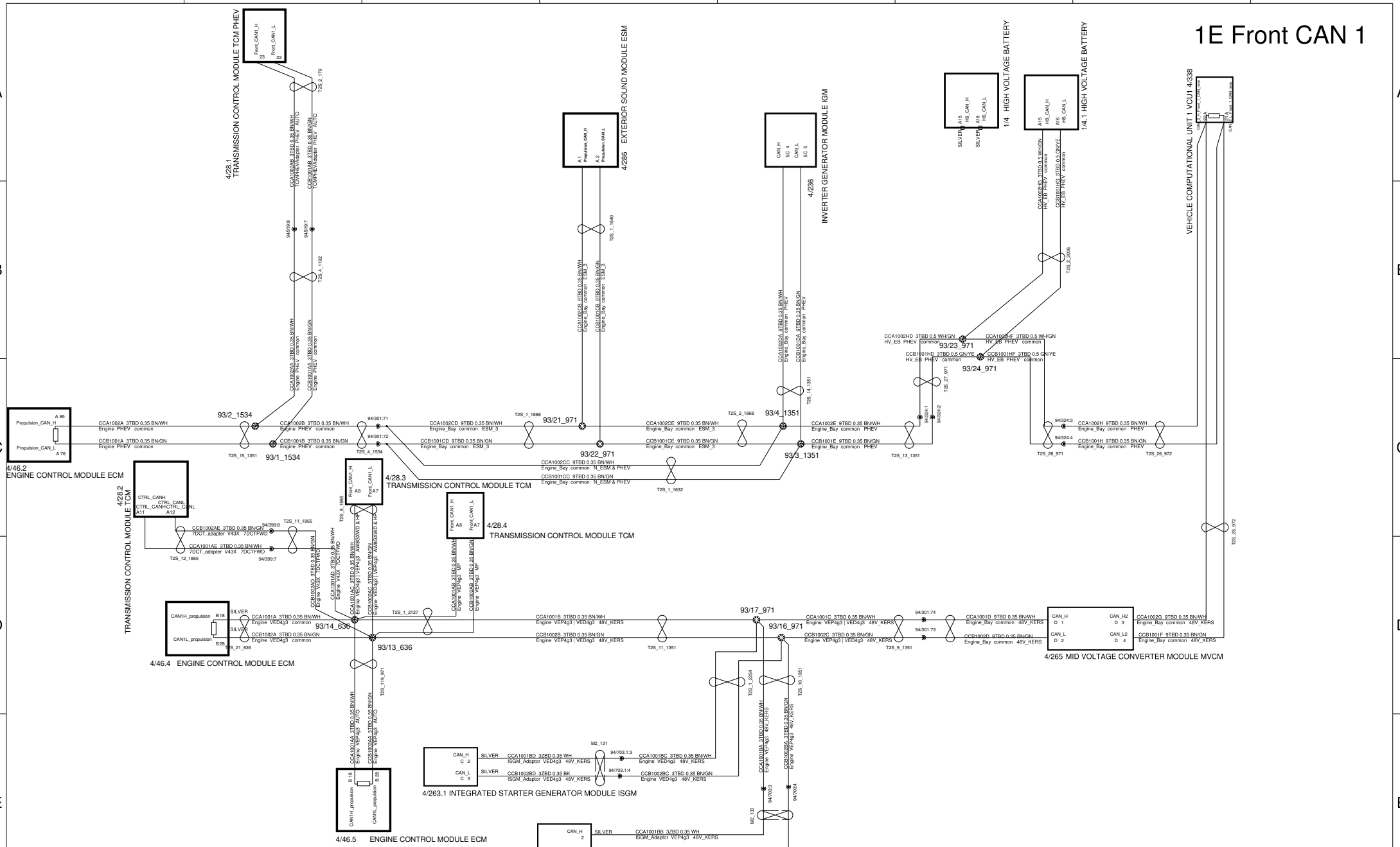

<p>The copying, distribution and utilization of this document as well as the communication of its contents to others without expressed authorization is prohibited. Offenders will be held liable for payment of damages. All rights reserved in the event of the grant of a patent, utility model or ornamental design registration.</p> <p style="text-align: center;"><b>VOLVO</b> VOLVO CAR CORPORATION</p>		<p><b>Document title</b> SPA_Issue25_Release1 1E_003C_Front_CAN_1</p>	
		<p><b>Document Type</b> DRAW/ELSY</p>	<p><b>Edited</b> April/05/2023</p>
<p><b>Release Status</b> RELEASED</p>		<p><b>Document No</b> 33409142</p>	<p><b>Issue</b> 035</p>
		<p><b>Page No</b> 26/177</p>	

# 1E Exposed Safety CAN V54X L541 V426 V43X ARGUS

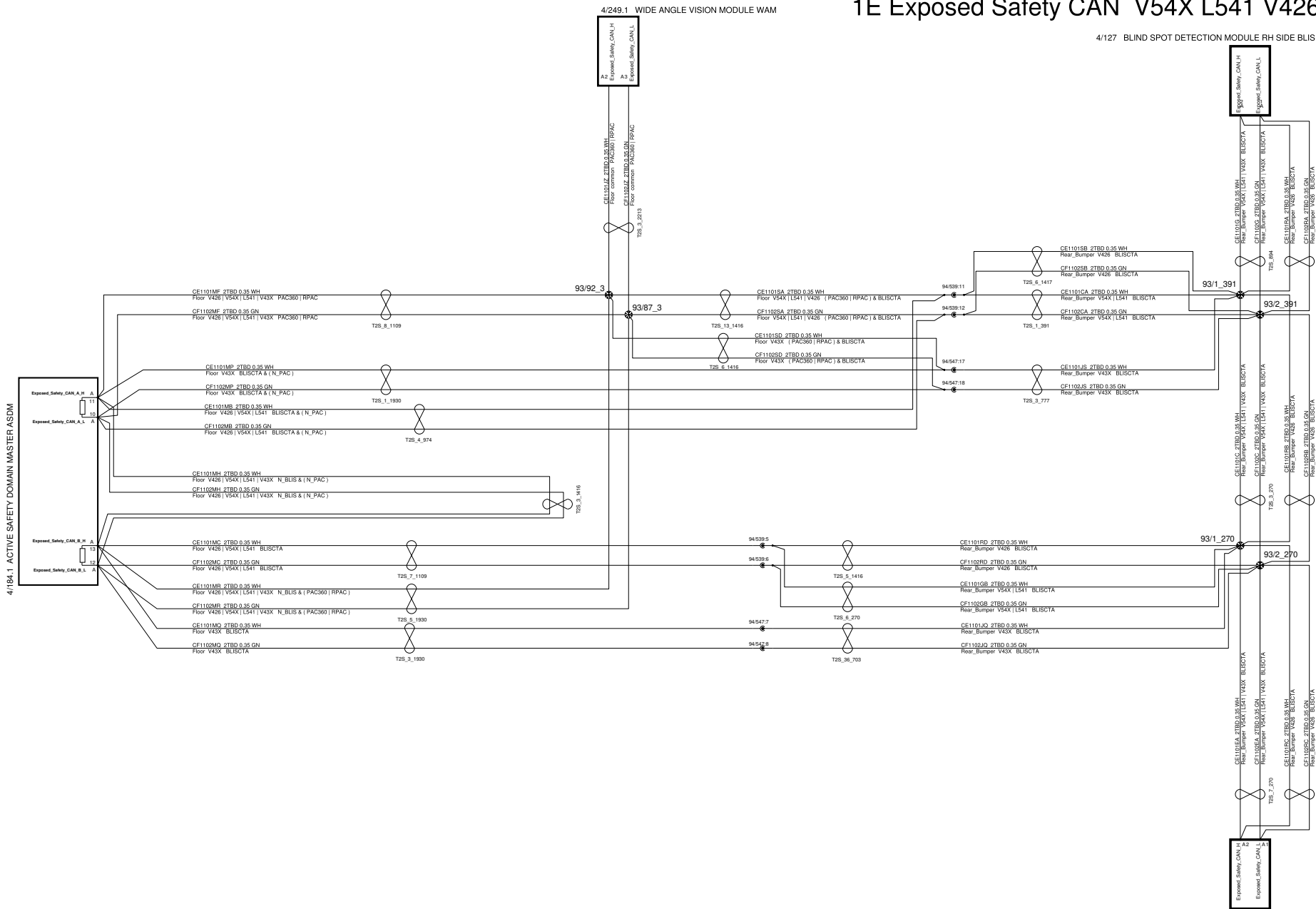

4/249.1 WIDE ANGLE VISION MODULE WAM

4/127 BLIND SPOT DETECTION MODULE RH SIDE BLIS

4/126 BLIND SPOT DETECTION MODULE LH SIDE BLIS

<p>The copying, distribution and utilization of this document as well as the communication of its contents to others without expressed authorization is prohibited. Offenders will be held liable for payment of damages. All rights reserved in the event of the grant of a patent, utility model or ornamental design registration.</p> <p><b>VOLVO</b> VOLVO CAR CORPORATION</p>	<p><b>Document title</b> SPA_Issue25_Release1 1E_004_Exposed_Safety_CAN_V54X_L541_V426_V43X_ARGUS</p>	
	<p><b>Document Type</b> DRAW/ELSY</p>	<p><b>Edited</b> April/05/2023</p>
	<p><b>Release Status</b> RELEASED</p>	
	<p><b>Document No</b> 33409142</p>	<p><b>Issue</b> 035</p>

# 1E Exposed Safety-CAN V526 ARGUS

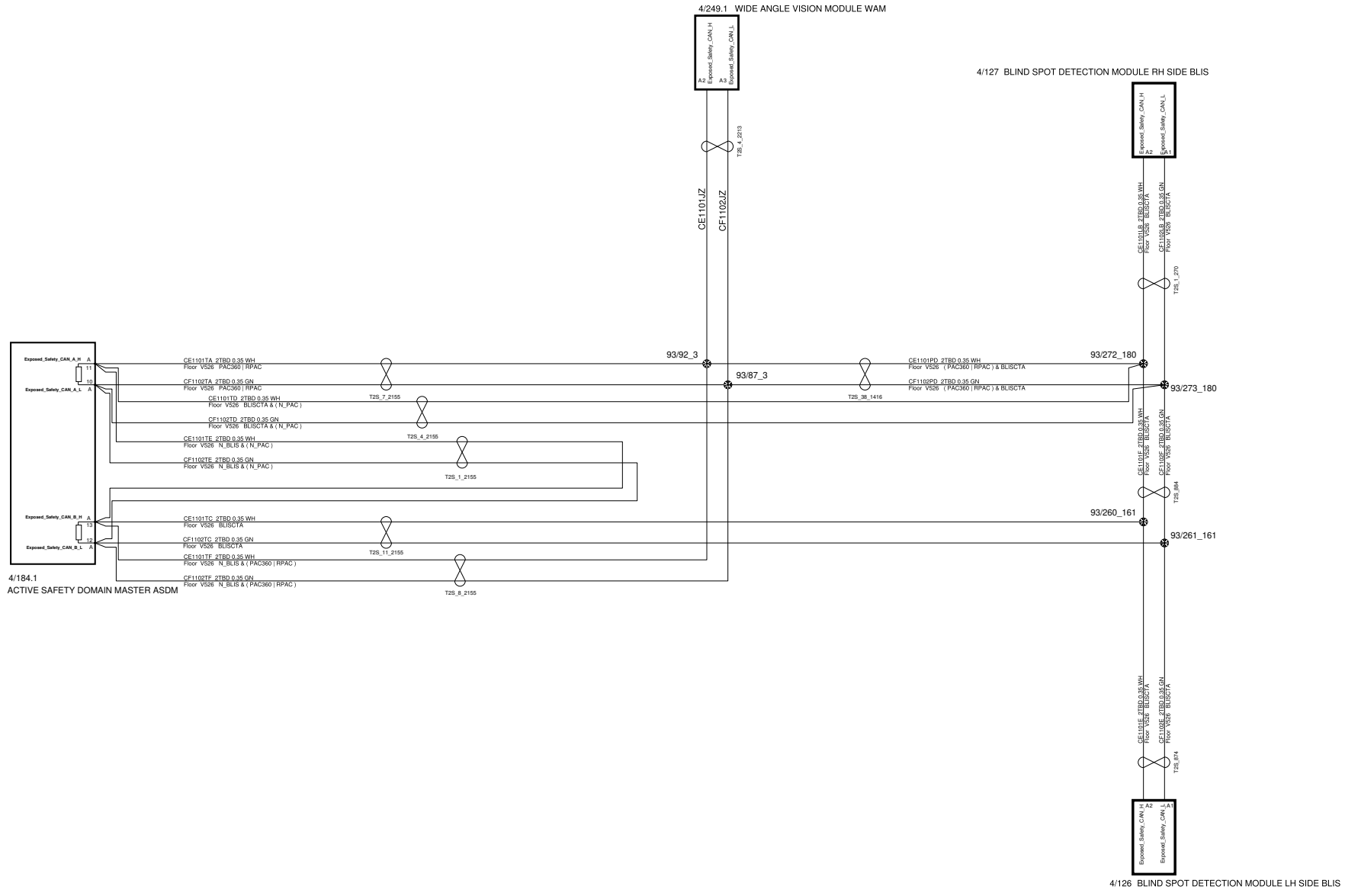

<p>The copying, distribution and utilization of this document as well as the communication of its contents to others without expressed authorization is prohibited. Offenders will be held liable for payment of damages. All rights reserved in the event of the grant of a patent, utility model or ornamental design registration.</p> <p style="text-align: center;"><b>VOLVO</b> VOLVO CAR CORPORATION</p>	<p><b>Document title</b> SPA_Issue25_Release1 1E_004_Exposed_Safety_CAN_V526_ARGUS</p>	
	<p><b>Document Type</b> DRAW/ELSY</p>	<p><b>Edited</b> March/17/2023</p>
<p><b>Release Status</b> RELEASED</p>		
<p><b>Document No</b> 33409142</p>	<p><b>Issue</b> 035</p>	<p><b>Page No</b> 28/177</p>

# Front 4 CAN Exposed

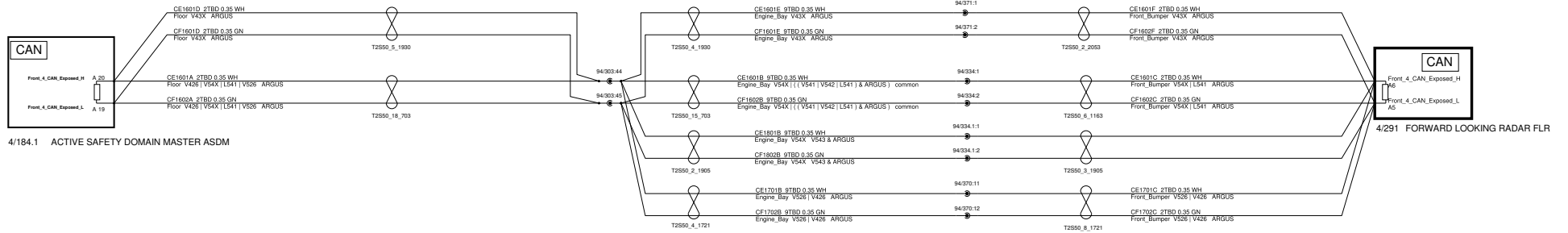

<p>The copying, distribution and utilization of this document as well as the communication of its contents to others without expressed authorization is prohibited. Offenders will be held liable for payment of damages. All rights reserved in the event of the grant of a patent, utility model or ornamental design registration.</p>		<p><b>Document title</b> SPA_Issue25_Release1 1E_004B_Front_CAN_4_Exposed</p>		
		<p><b>Document Type</b> DRAW/ELSY</p>	<p><b>Edited</b> April/03/2023</p>	
<p><b>VOLVO</b> VOLVO CAR CORPORATION</p>				
<p><b>Release Status</b> RELEASED</p>		<p><b>Document No</b> 33409142</p>	<p><b>Issue</b> 035</p>	<p><b>Page No</b> 29/177</p>



# 1E Protected Safety-CAN CL90

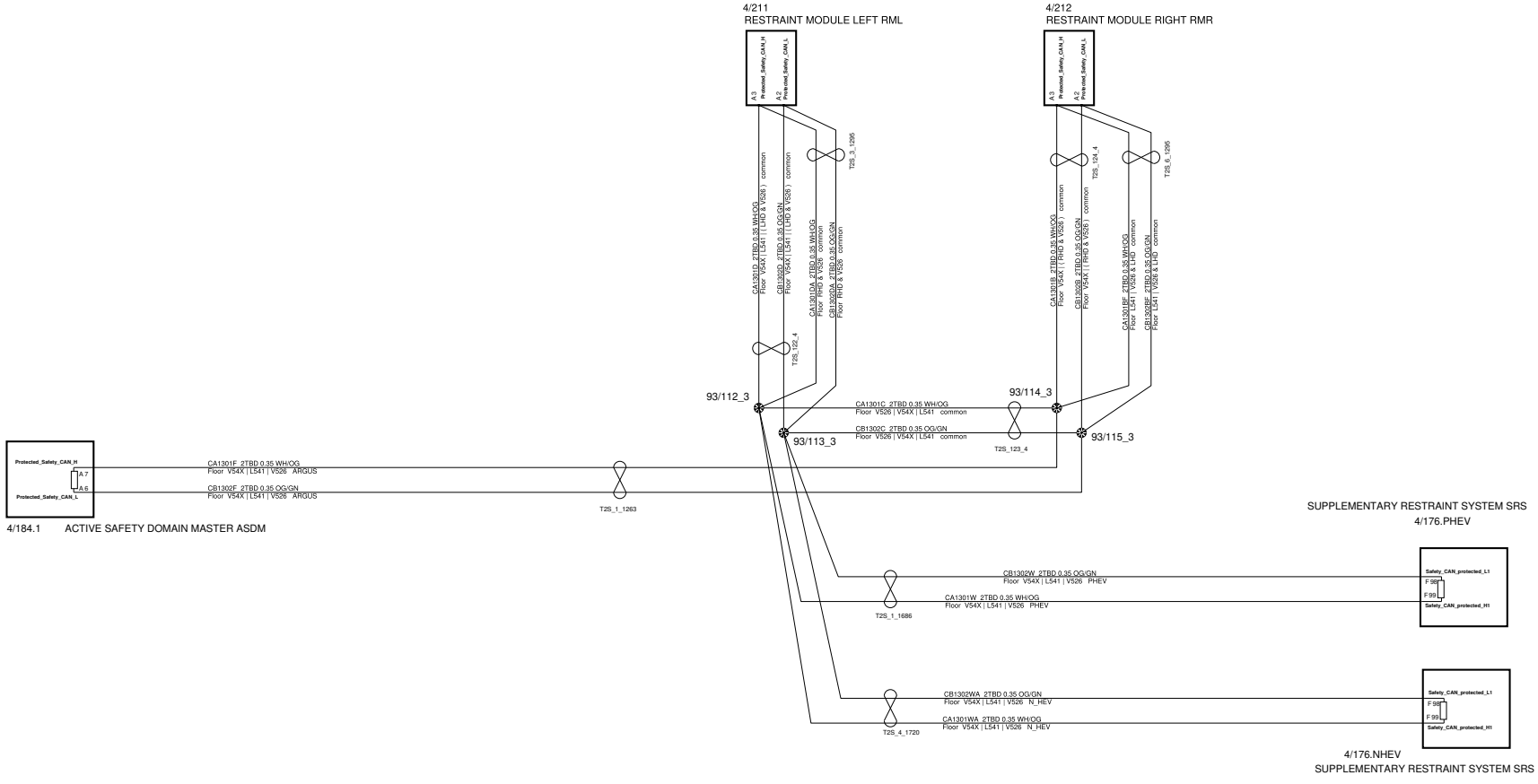

<p>The copying, distribution and utilization of this document as well as the communication of its contents to others without expressed authorization is prohibited. Offenders will be held liable for payment of damages. All rights reserved in the event of the grant of a patent, utility model or ornamental design registration.</p> <p><b>VOLVO</b> VOLVO CAR CORPORATION</p>	<p><b>Document title</b> SPA_Issue25_Release1 1E_006A_Protected_Safety_CAN_CL90</p>		
	<p><b>Document Type</b> DRAW/ELSY</p>	<p><b>Edited</b> April/05/2023</p>	
	<p><b>Release Status</b> RELEASED</p>		
	<p><b>Document No</b> 33409142</p>	<p><b>Issue</b> 035</p>	<p><b>Page No</b> 30/177</p>

# 1E Protected Safety-CAN CL60

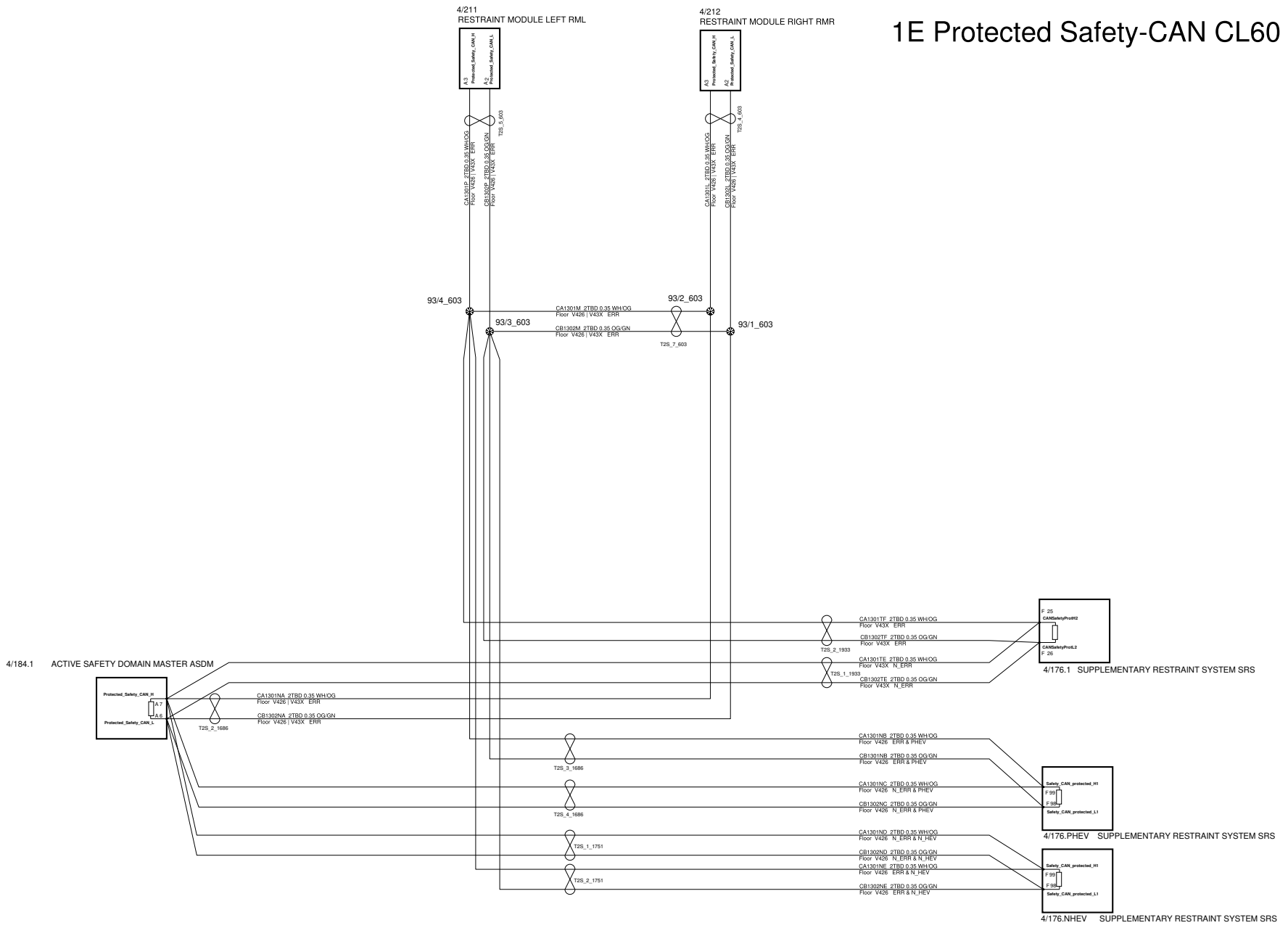

<p>The copying, distribution and utilization of this document as well as the communication of its contents to others without expressed authorization is prohibited. Offenders will be held liable for payment of damages. All rights reserved in the event of the grant of a patent, utility model or ornamental design registration.</p>		<p>Document title SPA_Issue25_Release1 1E_006B_Protected_Safety_CAN_CL60</p>	
		<p>Document Type DRAW/ELSY</p>	<p>Edited April/05/2023</p>
<p><b>VOLVO</b> VOLVO CAR CORPORATION</p>		<p>Release Status RELEASED</p>	
		<p>Document No 33409142</p>	<p>Issue 035</p>
		<p>Page No 31/177</p>	



# 1E LIN Powertrain

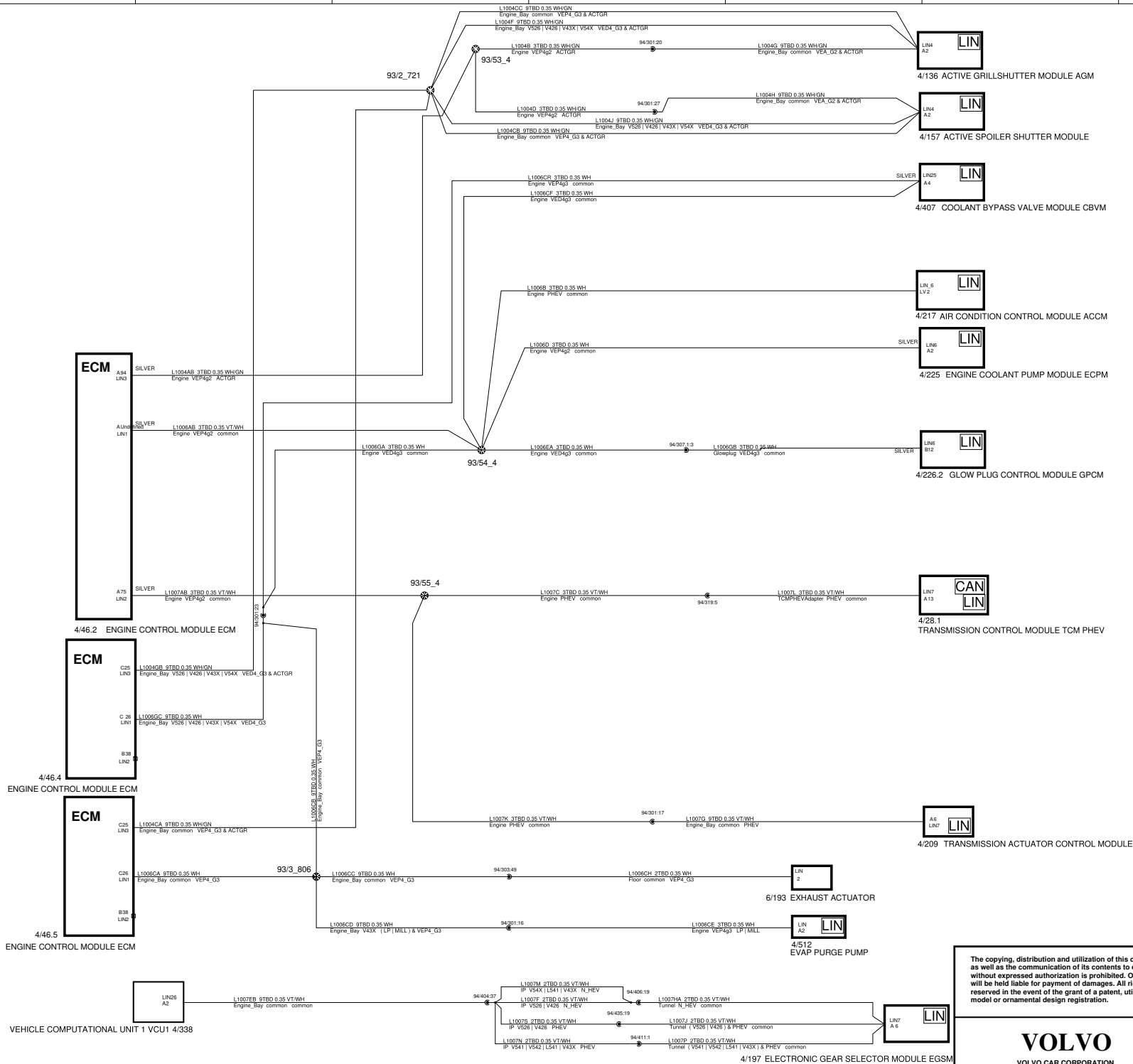

The copying, distribution and utilization of this document as well as the communication of its contents to others without expressed authorization is prohibited. Offenders will be held liable for payment of damages. All rights reserved in the event of the grant of a patent, utility model or ornamental design registration.

**VOLVO**  
VOLVO CAR CORPORATION

<b>Document title</b> 1E_007A_LIN_Powertrain		SPA_Issue25_Release1	
<b>Document Type</b> DRAW/ELSY	<b>Edited</b> April/05/2023		
<b>Release Status</b> RELEASED			
<b>Document No</b> 33409142	<b>Issue</b> 035	<b>Page No</b> 32/177	

# 1E LIN Comfort

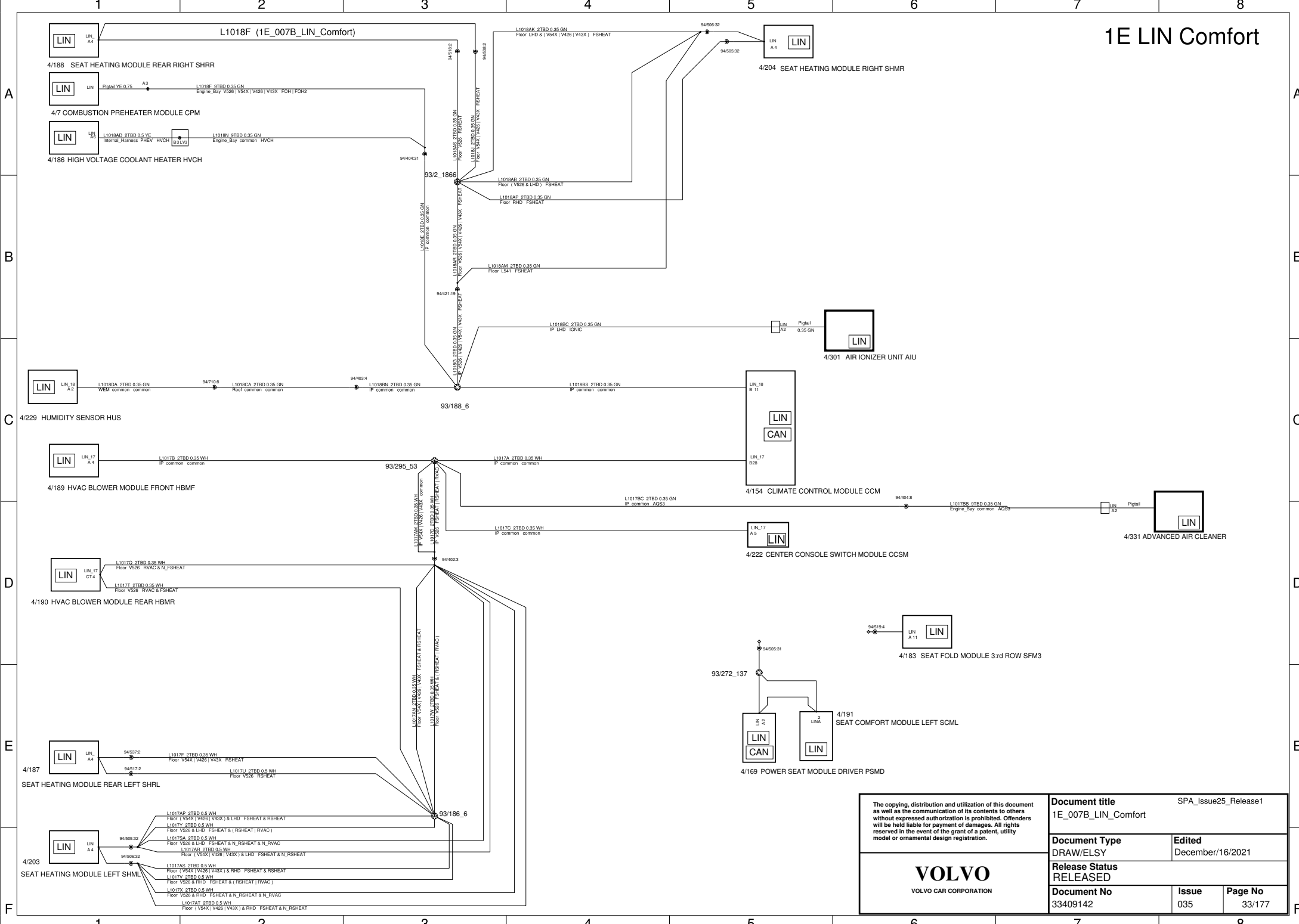

The copying, distribution and utilization of this document as well as the communication of its contents to others without expressed authorization is prohibited. Offenders will be held liable for payment of damages. All rights reserved in the event of the grant of a patent, utility model or ornamental design registration.		<b>Document title</b> SPA_Issue25_Release1	
<b>Document title</b> 1E_007B_LIN_Comfort		<b>Edited</b> December/16/2021	
<b>Document Type</b> DRAW/ELSY		<b>Release Status</b> RELEASED	
<b>Document No</b> 33409142	<b>Issue</b> 035	<b>Page No</b> 33/177	



# 1E LIN Comfort L541 unique content

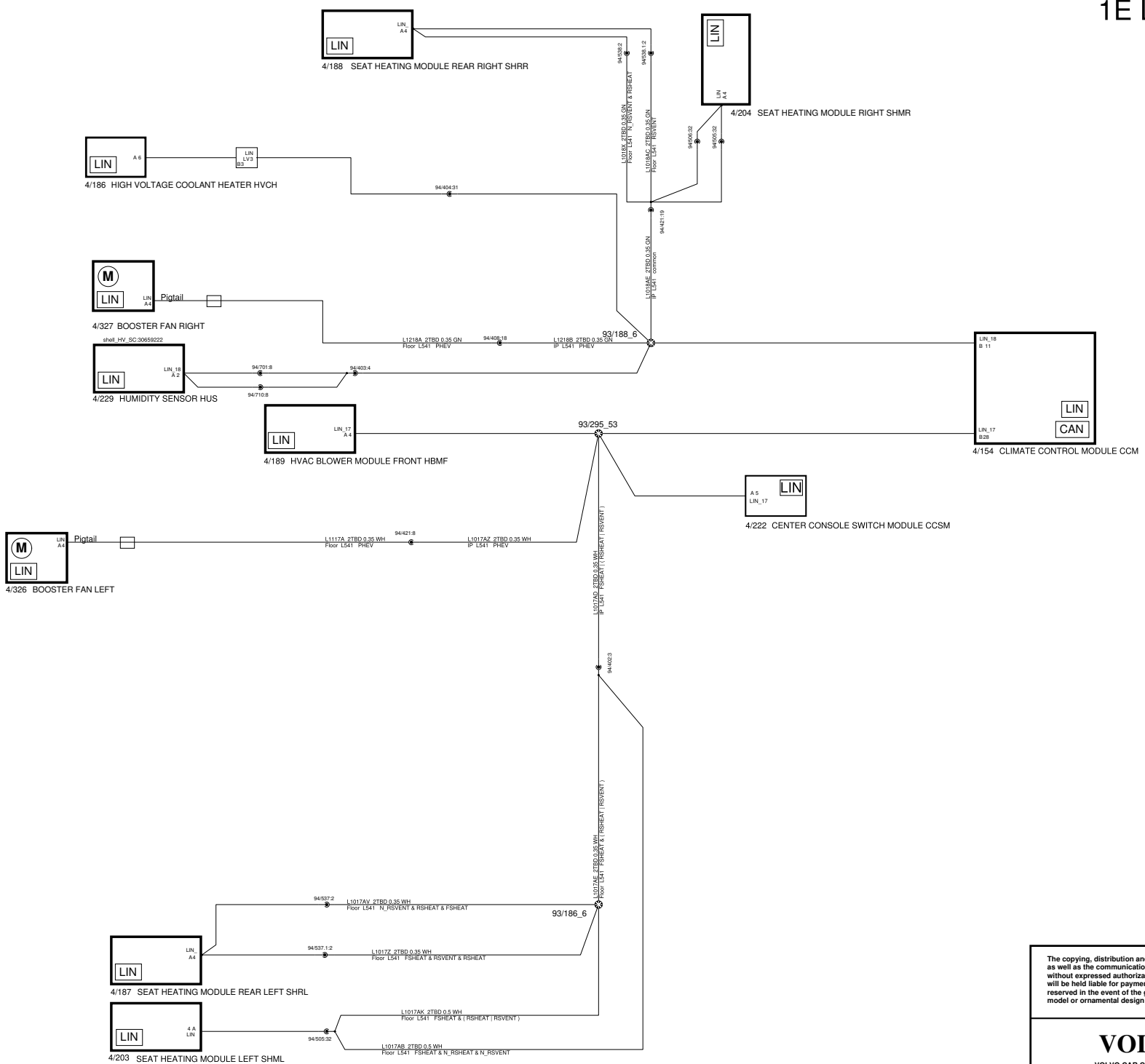

<p>The copying, distribution and utilization of this document as well as the communication of its contents to others without expressed authorization is prohibited. Offenders will be held liable for payment of damages. All rights reserved in the event of the grant of a patent, utility model or ornamental design registration.</p> <p><b>VOLVO</b> VOLVO CAR CORPORATION</p>	<b>Document title</b> SPA_Issue25_Release1 1E_007C_LIN_Comfort_L541		
	<b>Document Type</b> DRAW/ELSY	<b>Edited</b> June/16/2021	
	<b>Release Status</b> RELEASED		
	<b>Document No</b> 33409142	<b>Issue</b> 035	<b>Page No</b> 34/177

# 1E LIN Infotainment

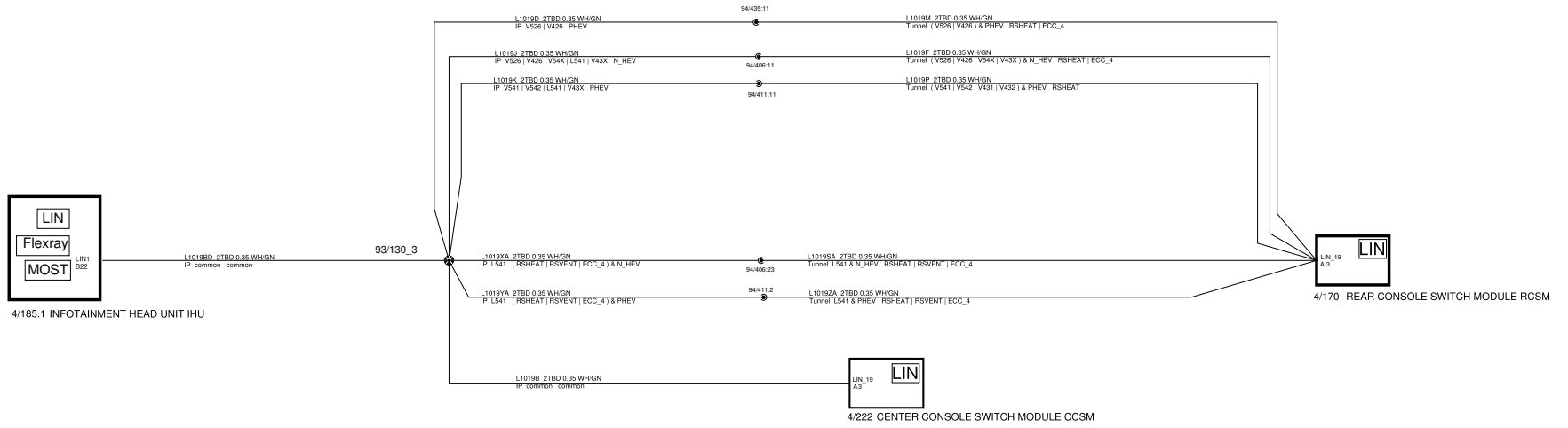

<p>The copying, distribution and utilization of this document as well as the communication of its contents to others without expressed authorization is prohibited. Offenders will be held liable for payment of damages. All rights reserved in the event of the grant of a patent, utility model or ornamental design registration.</p> <p><b>VOLVO</b> VOLVO CAR CORPORATION</p>	<b>Document title</b> SPA_Issue25_Release1 1E_007D_LIN_Infotainment	
	<b>Document Type</b> DRAW/ELSY	<b>Edited</b> March/14/2023
	<b>Release Status</b> RELEASED	
	<b>Document No</b> 33409142	<b>Issue</b> 035

# 1E LIN Body

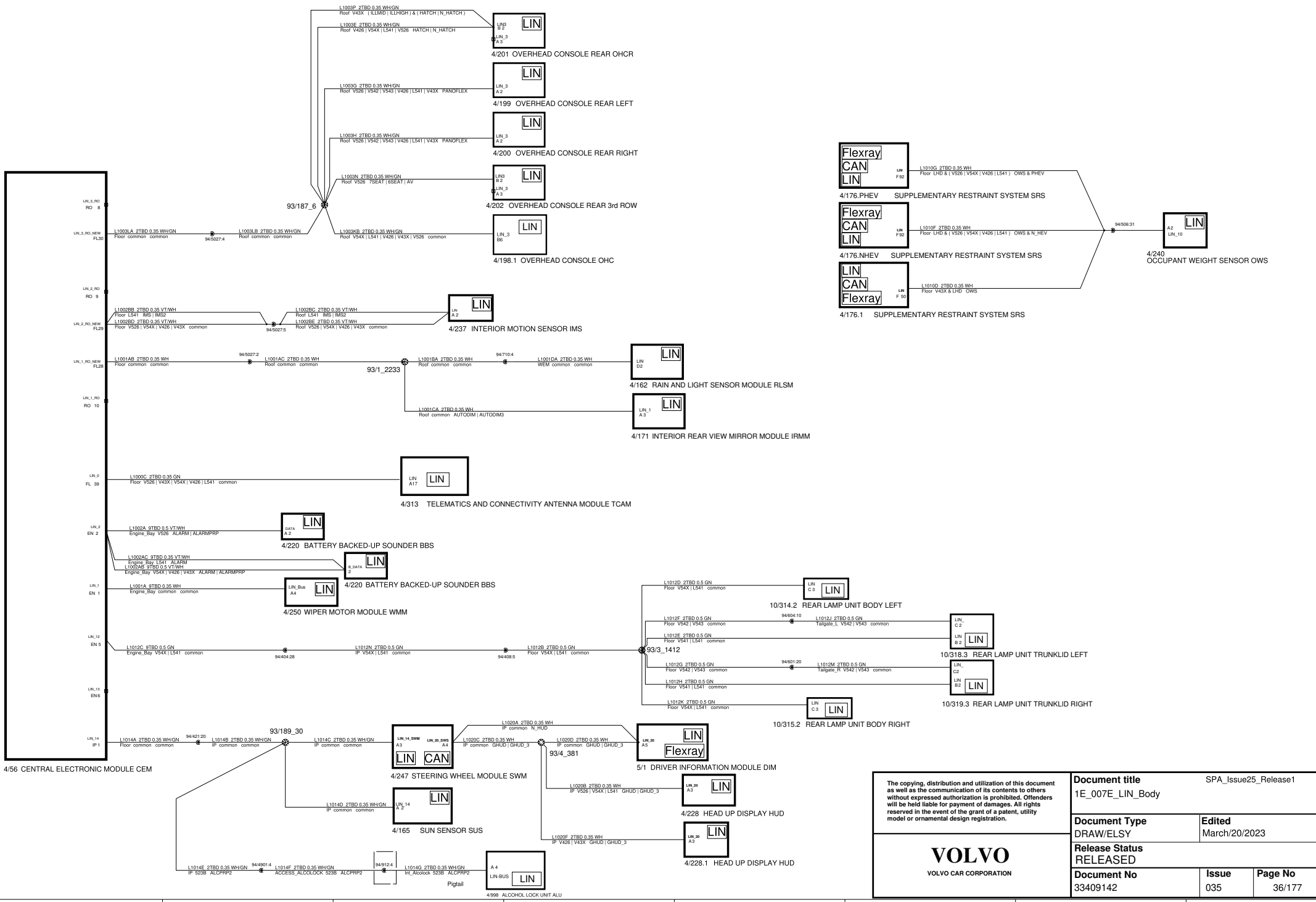

The copying, distribution and utilization of this document as well as the communication of its contents to others without expressed authorization is prohibited. Offenders will be held liable for payment of damages. All rights reserved in the event of the grant of a patent, utility model or ornamental design registration.



Document title		SPA_Issue25_Release1	
1E_007E_LIN_Body			
Document Type	DRAW/ELSY	Edited	14Feb/2023
Release Status		RELEASED	
Document No	33409142	Issue	035
		Page No	36/177

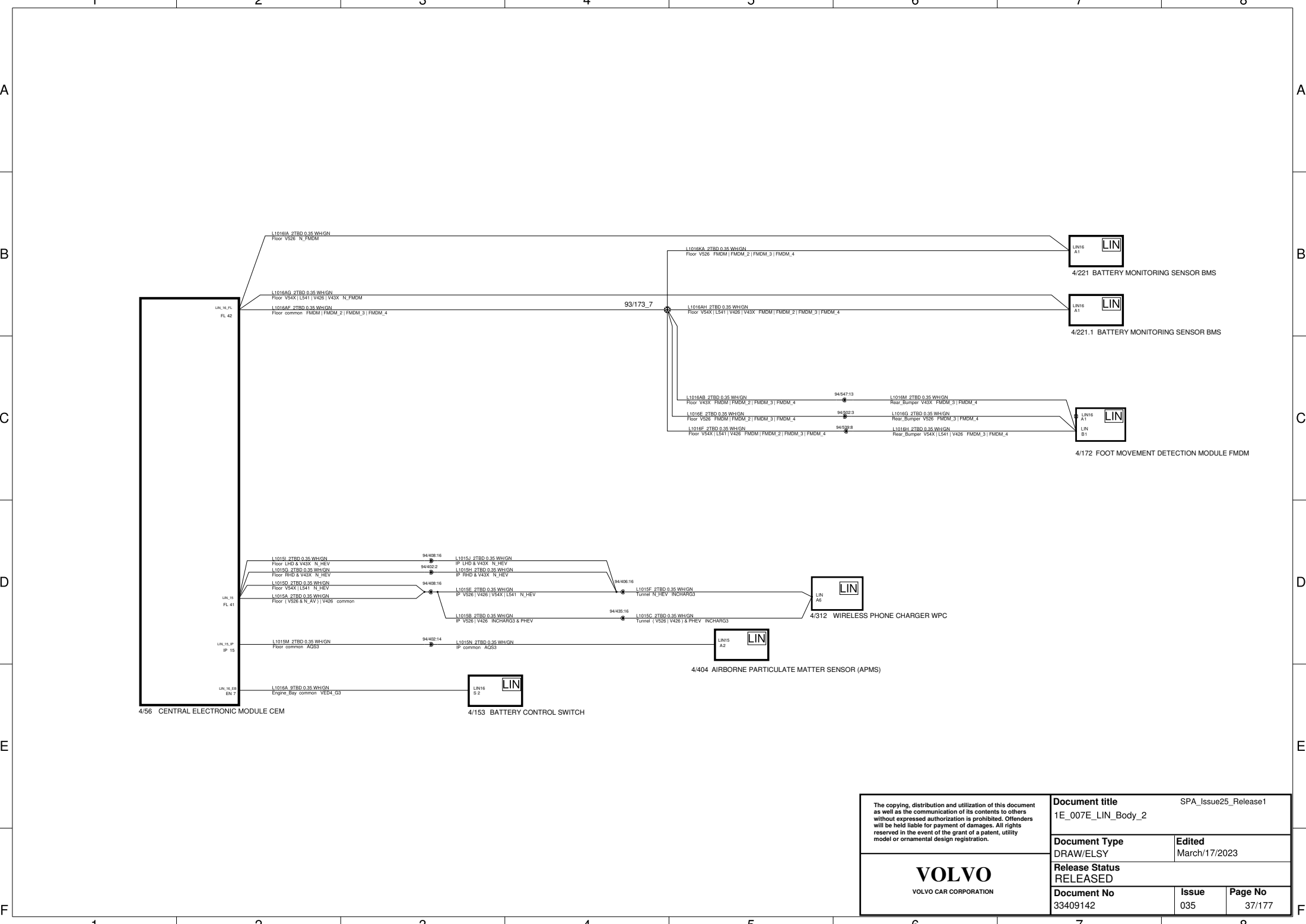

The copying, distribution and utilization of this document as well as the communication of its contents to others without expressed authorization is prohibited. Offenders will be held liable for payment of damages. All rights reserved in the event of the grant of a patent, utility model or ornamental design registration.	<b>Document title</b> SPA_Issue25_Release1	
	1E_007E_LIN_Body_2	
<b>VOLVO</b> VOLVO CAR CORPORATION	<b>Document Type</b> DRAW/ELSY	<b>Edited</b> March/17/2023
	<b>Release Status</b> RELEASED	
<b>Document No</b> 33409142	<b>Issue</b> 035	<b>Page No</b> 37/177

# 1E LIN Doors

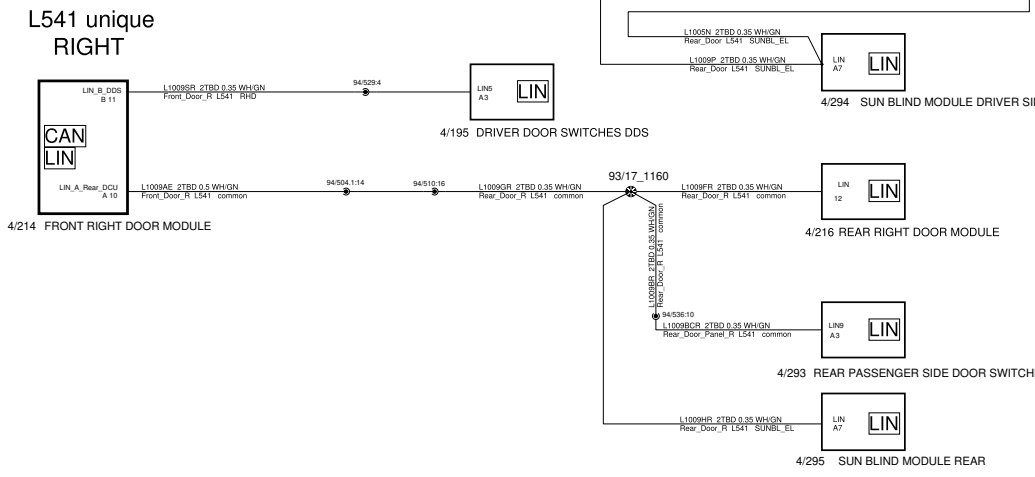
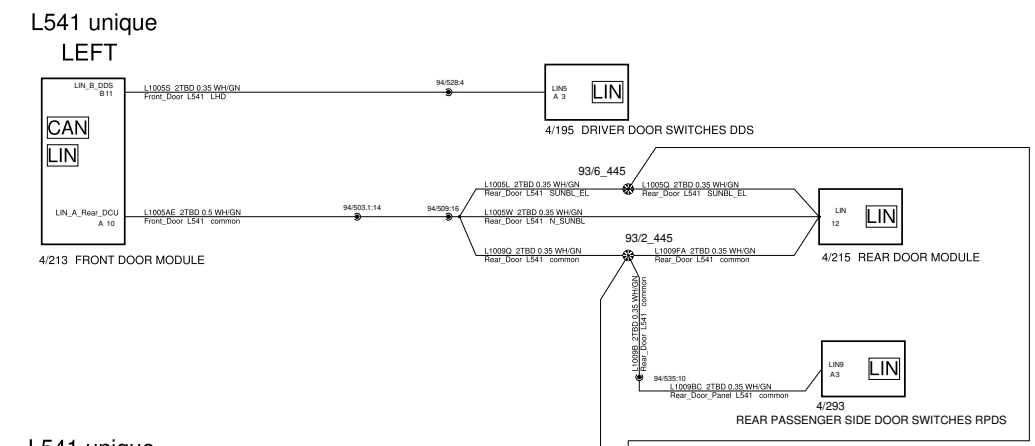
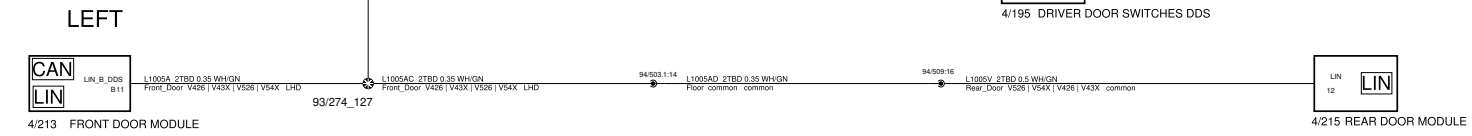

<p>The copying, distribution and utilization of this document as well as the communication of its contents to others without expressed authorization is prohibited. Offenders will be held liable for payment of damages. All rights reserved in the event of the grant of a patent, utility model or ornamental design registration.</p> <p><b>VOLVO</b> VOLVO CAR CORPORATION</p>	<b>Document title</b> SPA_Issue25_Release1	
	1E_007F_LIN_Doors	
	<b>Document Type</b> DRAW/ELSY	<b>Edited</b> March/15/2023
	<b>Release Status</b> RELEASED	
<b>Document No</b> 33409142	<b>Issue</b> 035	<b>Page No</b> 38/177

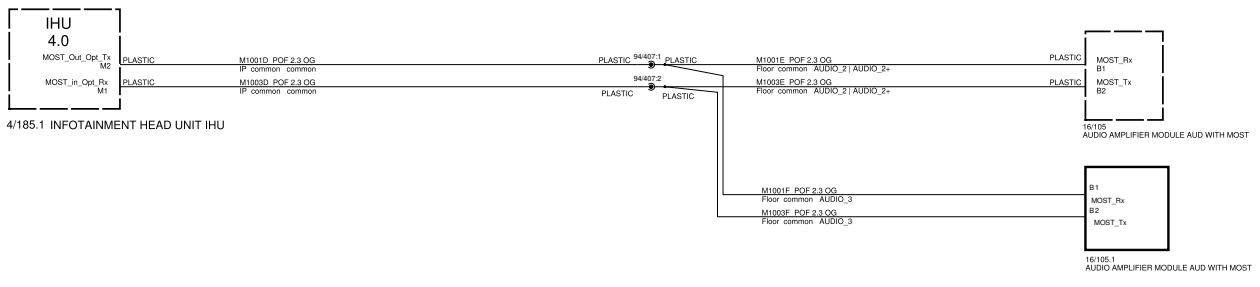

<p>The copying, distribution and utilization of this document as well as the communication of its contents to others without expressed authorization is prohibited. Offenders will be held liable for payment of damages. All rights reserved in the event of the grant of a patent, utility model or ornamental design registration.</p> <p><b>VOLVO</b> VOLVO CAR CORPORATION</p>	<p><b>Document title</b> SPA_Issue25_Release1 1E_008_MOST</p>	
	<p><b>Document Type</b> DRAW/ELSY</p>	<p><b>Edited</b> April/08/2022</p>
	<p><b>Release Status</b> RELEASED</p>	
	<p><b>Document No</b> 33409142</p>	<p><b>Issue</b> 035</p>



# 1E Engine-CAN

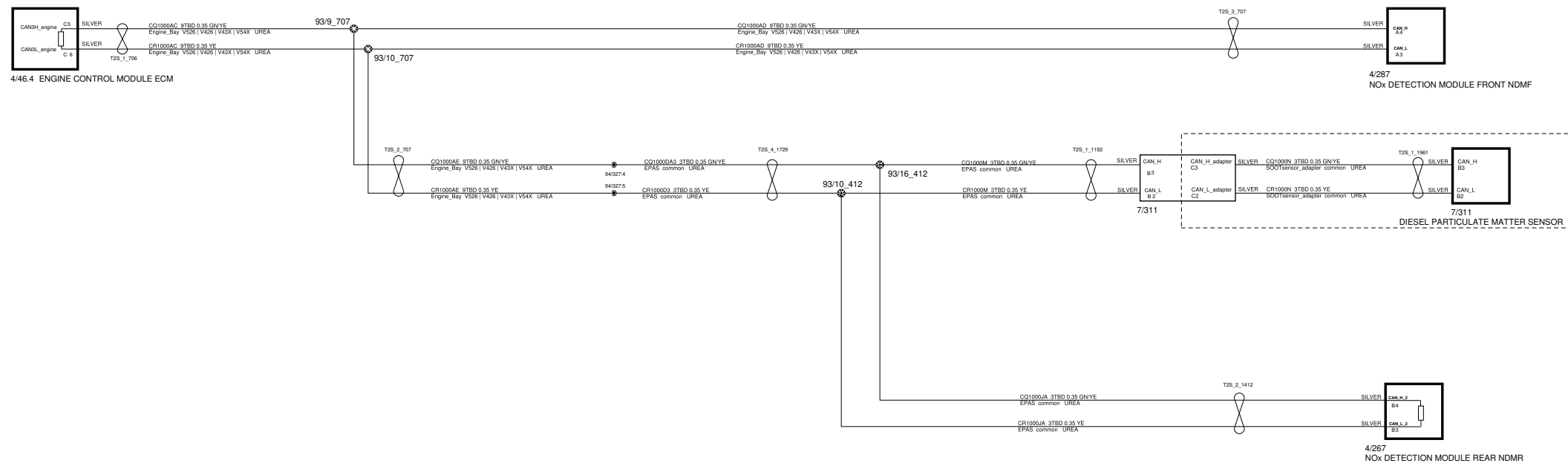

<p>The copying, distribution and utilization of this document as well as the communication of its contents to others without expressed authorization is prohibited. Offenders will be held liable for payment of damages. All rights reserved in the event of the grant of a patent, utility model or ornamental design registration.</p> <p><b>VOLVO</b> VOLVO CAR CORPORATION</p>	<b>Document title</b> SPA_Issue25_Release1 1E_009_Engine_CAN	
	<b>Document Type</b> DRAW/ELSY	<b>Edited</b> March/17/2023
	<b>Release Status</b> RELEASED	
	<b>Document No</b> 33409142	<b>Issue</b> 035



# 1E Body-CAN Exposed

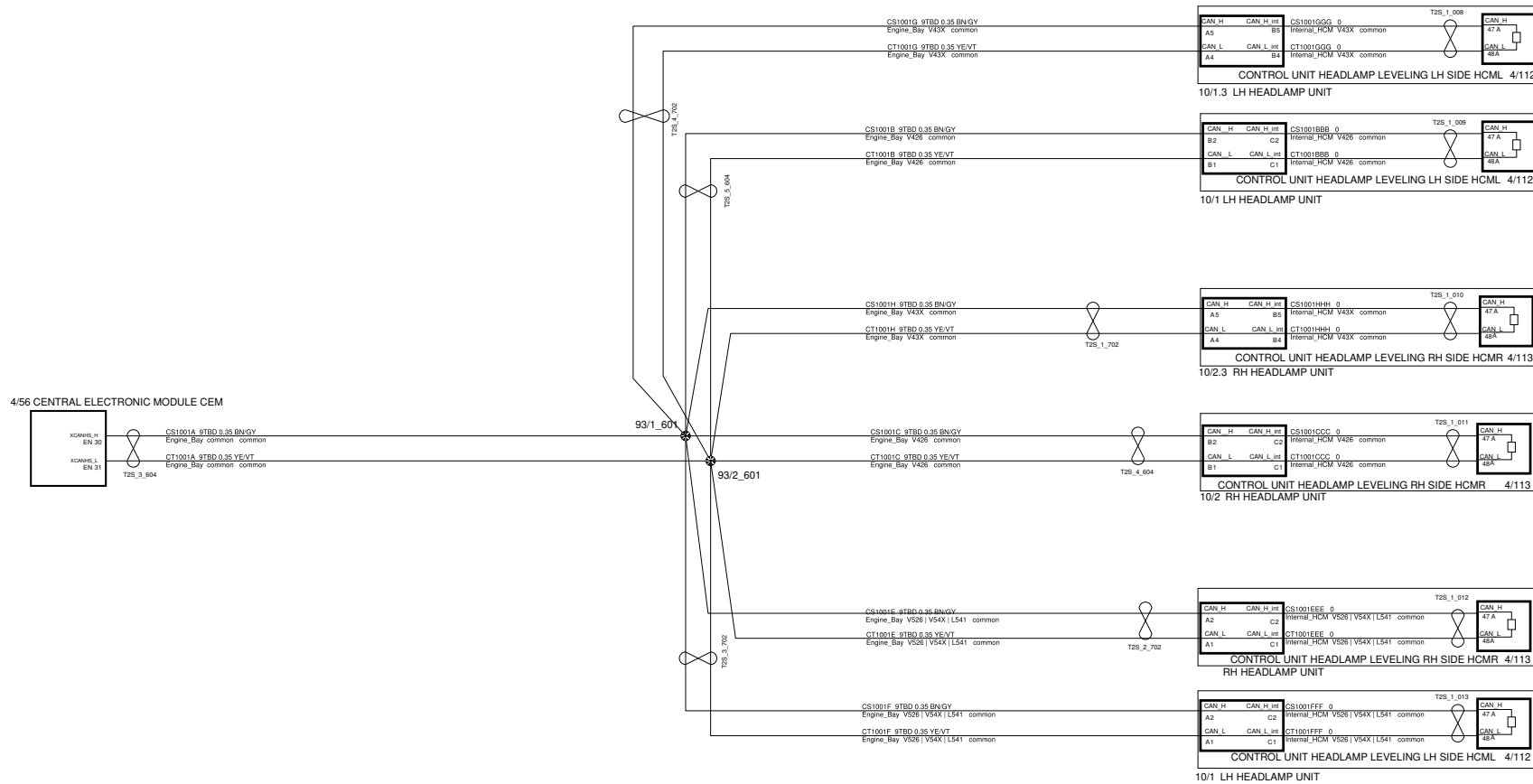

<p>The copying, distribution and utilization of this document as well as the communication of its contents to others without expressed authorization is prohibited. Offenders will be held liable for payment of damages. All rights reserved in the event of the grant of a patent, utility model or ornamental design registration.</p> <p><b>VOLVO</b> VOLVO CAR CORPORATION</p>	<b>Document title</b> SPA_Issue25_Release1 1E_010_Body_CAN_Exposed	
	<b>Document Type</b> DRAW/ELSY	<b>Edited</b> April/05/2023
	<b>Release Status</b> RELEASED	
	<b>Document No</b> 33409142	<b>Issue</b> 035

# 1E Rear CAN PHEV

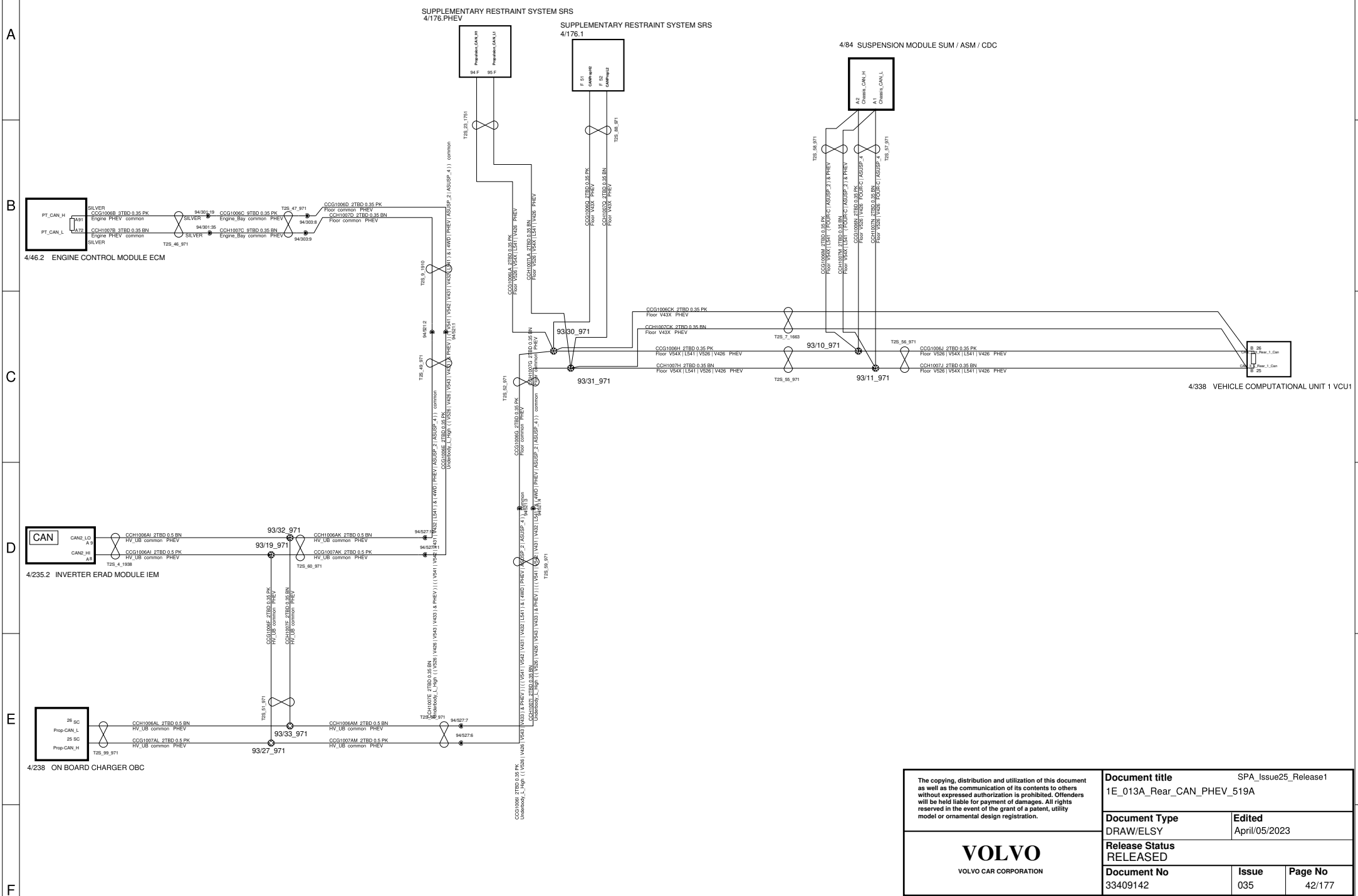

The copying, distribution and utilization of this document as well as the communication of its contents to others without expressed authorization is prohibited. Offenders will be held liable for payment of damages. All rights reserved in the event of the grant of a patent, utility model or ornamental design registration.	<b>Document title</b> SPA_Issue25_Release1 1E_013A_Rear_CAN_PHEV_519A	
	<b>Document Type</b> DRAW/ELSY	<b>Edited</b> April/05/2023
<b>VOLVO</b> VOLVO CAR CORPORATION		
<b>Document No</b> 33409142	<b>Issue</b> 035	<b>Page No</b> 42/177



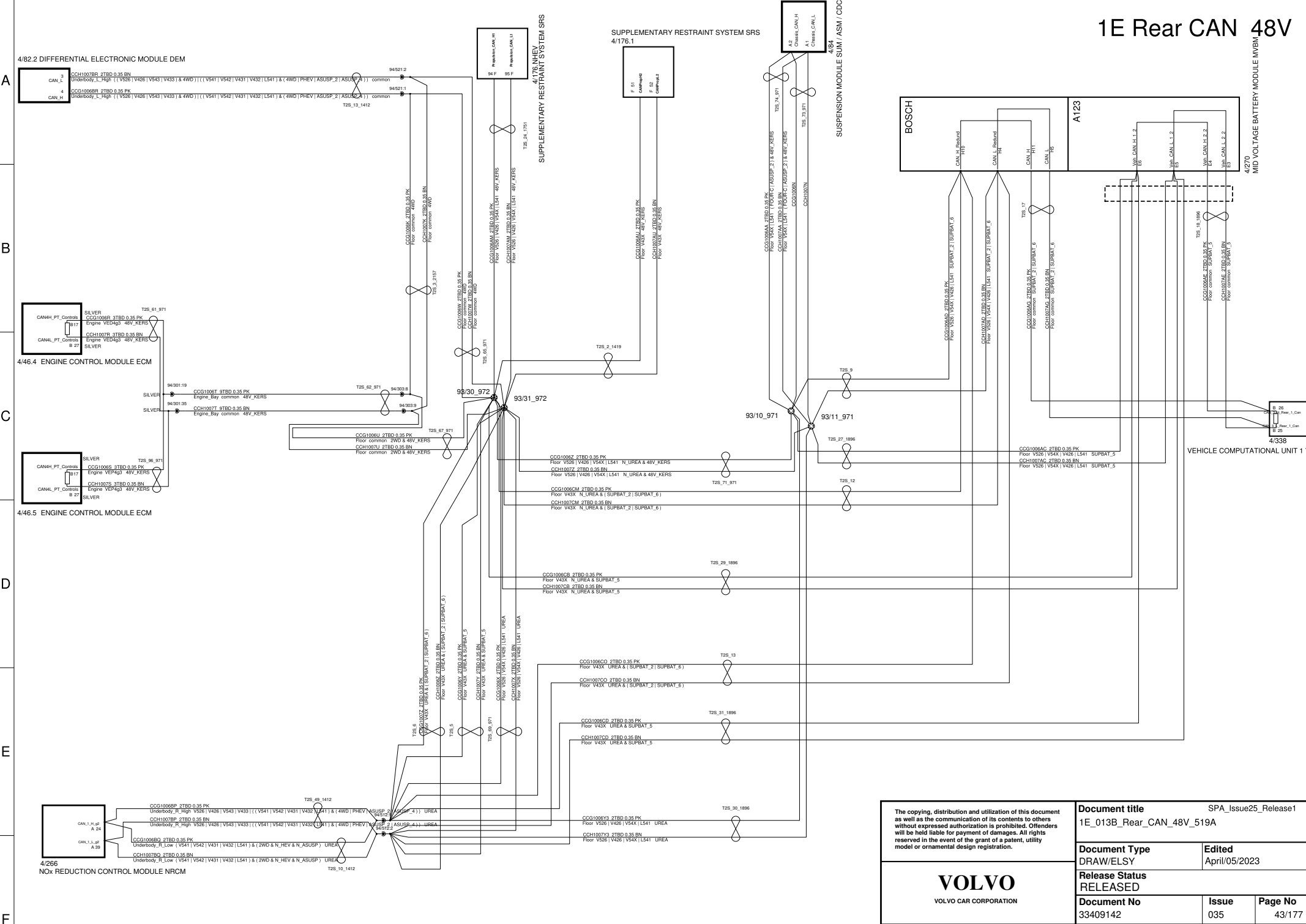

# 1E Rear CAN 48V

<p>The copying, distribution and utilization of this document as well as the communication of its contents to others without expressed authorization is prohibited. Offenders will be held liable for payment of damages. All rights reserved in the event of the grant of a patent, utility model or ornamental design registration.</p>		<p>Document title SPA_Issue25_Release1 1E_013B_Rear_CAN_48V_519A</p>	
<p>Document Type DRAW/ELSY</p>		<p>Edited April/05/2023</p>	
<p>Release Status RELEASED</p>			
<p>Document No 33409142</p>	<p>Issue 035</p>	<p>Page No 43/177</p>	



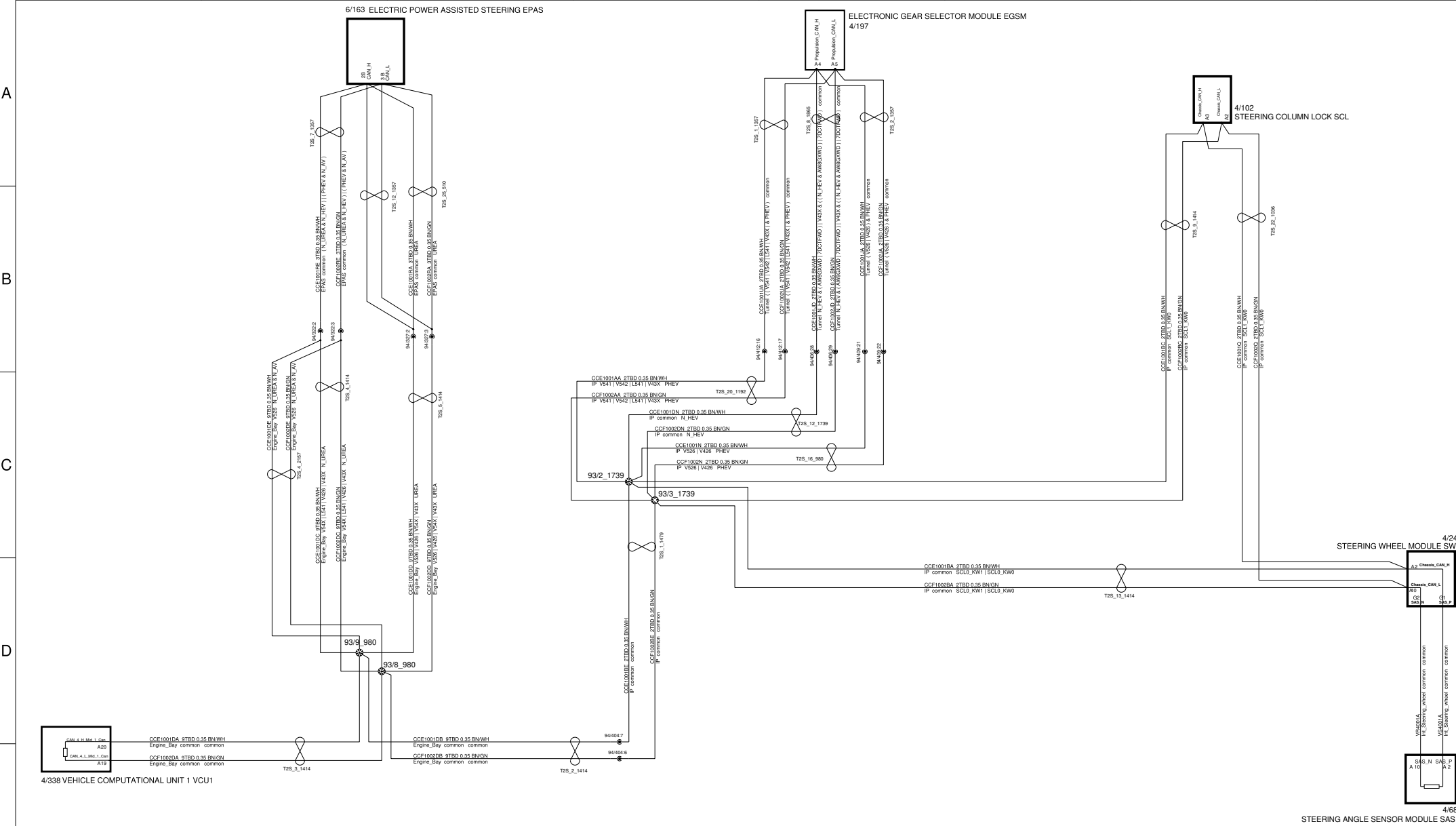

The copying, distribution and utilization of this document as well as the communication of its contents to others without expressed authorization is prohibited. Offenders will be held liable for payment of damages. All rights reserved in the event of the grant of a patent, utility model or ornamental design registration.		SPA_Issue25_Release1	
<b>Document title</b> 1E_014_MID_CAN		<b>Edited</b> April/05/2023	
<b>Document Type</b> DRAW/ELSY		<b>Release Status</b> RELEASED	
<b>Document No</b> 33409142	<b>Issue</b> 035	<b>Page No</b> 44/177	



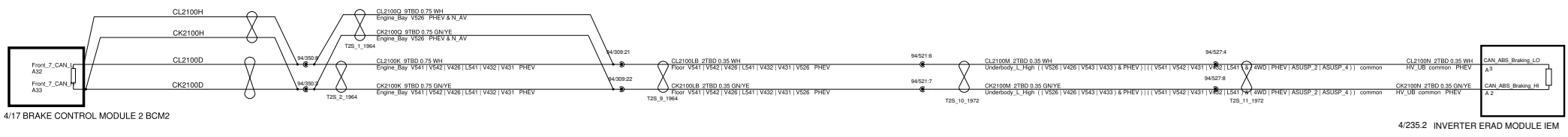

4/17 BRAKE CONTROL MODULE 2 BCM2

4/235.2 INVERTER ERAD MODULE IEM

<p>The copying, distribution and utilization of this document as well as the communication of its contents to others without expressed authorization is prohibited. Offenders will be held liable for payment of damages. All rights reserved in the event of the grant of a patent, utility model or ornamental design registration.</p> <p><b>VOLVO</b> VOLVO CAR CORPORATION</p>	<p><b>Document title</b> SPA_Issue25_Release1 1E_015_ABS_BRAKING_CAN</p>		
	<p><b>Document Type</b> DRAW/ELSY</p>	<p><b>Edited</b> April/20/2023</p>	
	<p><b>Release Status</b> RELEASED</p>		
	<p><b>Document No</b> 33409142</p>	<p><b>Issue</b> 035</p>	<p><b>Page No</b> 45/177</p>

# 1F2 Accessories Towing System 13S/13-pole Trailer Connector

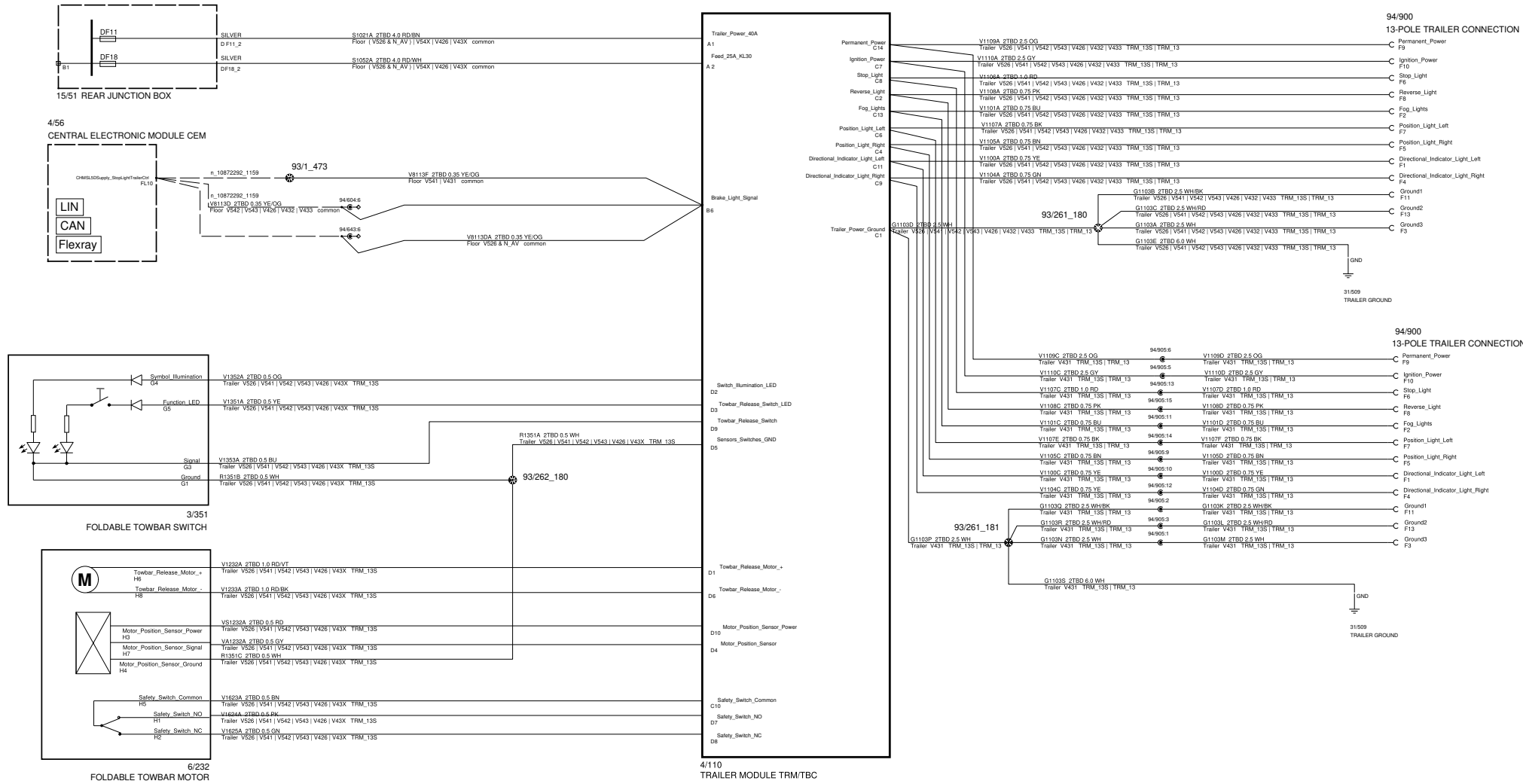

<p>The copying, distribution and utilization of this document as well as the communication of its contents to others without expressed authorization is prohibited. Offenders will be held liable for payment of damages. All rights reserved in the event of the grant of a patent, utility model or ornamental design registration.</p> <p style="text-align: center;"><b>VOLVO</b> VOLVO CAR CORPORATION</p>		<p><b>Document title</b> SPA_Issue25_Release1 1F2_001_Access_Towing_System_13S_13pol</p>	
		<p><b>Document Type</b> DRAW/ELSY</p>	<p><b>Issued</b> April/05/2023</p>
<p><b>Release Status</b> RELEASED</p>		<p><b>Document No</b> 33409142</p>	<p><b>Issue</b> 035</p>
		<p><b>Page No</b> 46/177</p>	

# 1F2 Accessories Towing System 4/7-Pol Trailer Connector

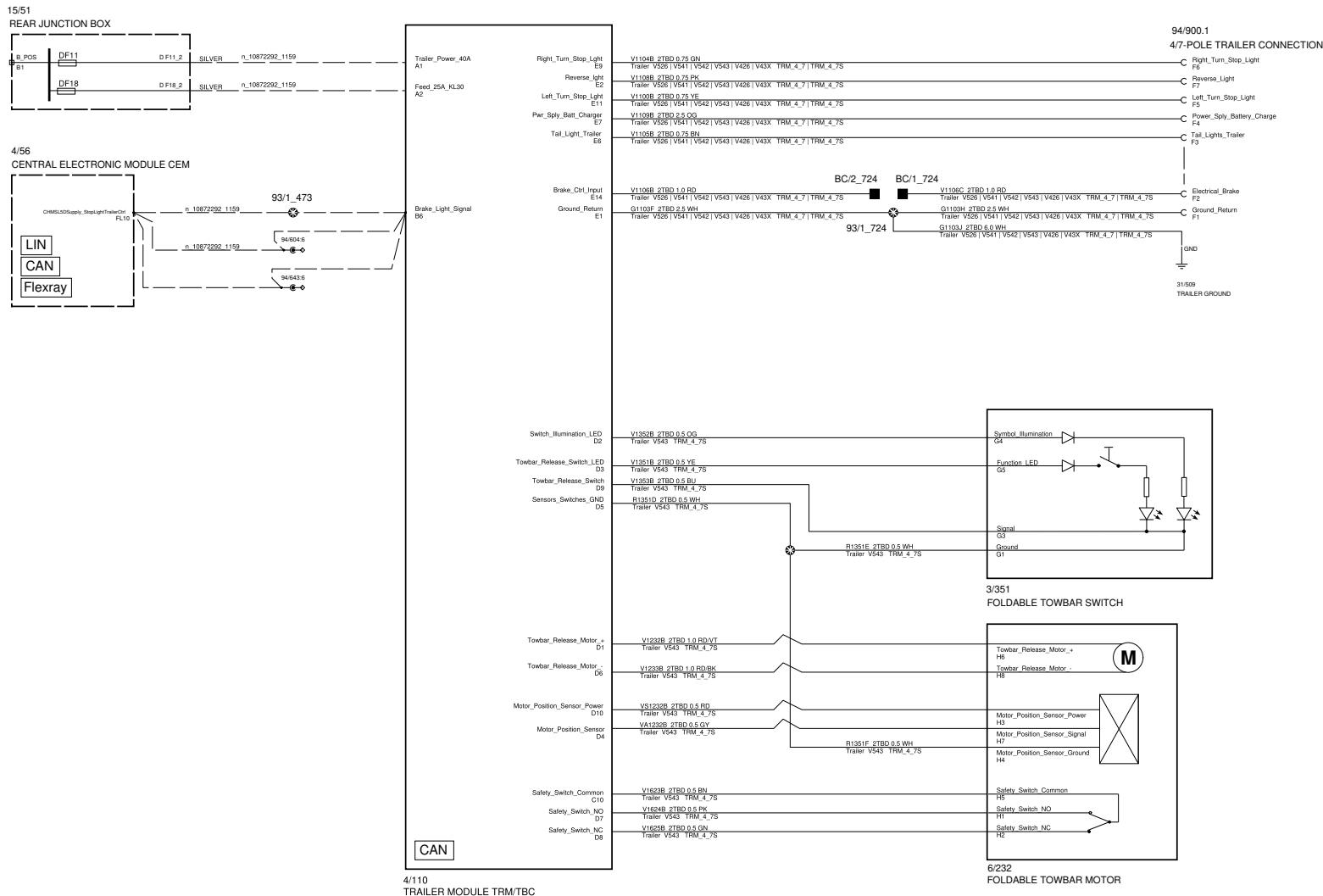

<p>The copying, distribution and utilization of this document as well as the communication of its contents to others without expressed authorization is prohibited. Offenders will be held liable for payment of damages. All rights reserved in the event of the grant of a patent, utility model or ornamental design registration.</p> <p><b>VOLVO</b> VOLVO CAR CORPORATION</p>	<p><b>Document title</b> SPA_Issue25_Release1 1F2_002_Access_Towing_System_4_7pol</p>		
	<p><b>Document Type</b> DRAW/ELSY</p>	<p><b>Edited</b> March/20/2023</p>	
	<p><b>Release Status</b> RELEASED</p>		
	<p><b>Document No</b> 33409142</p>	<p><b>Issue</b> 035</p>	<p><b>Page No</b> 47/177</p>



# 1F3 Accessories Junction Box AJB V526/V426/V54X 518A--->

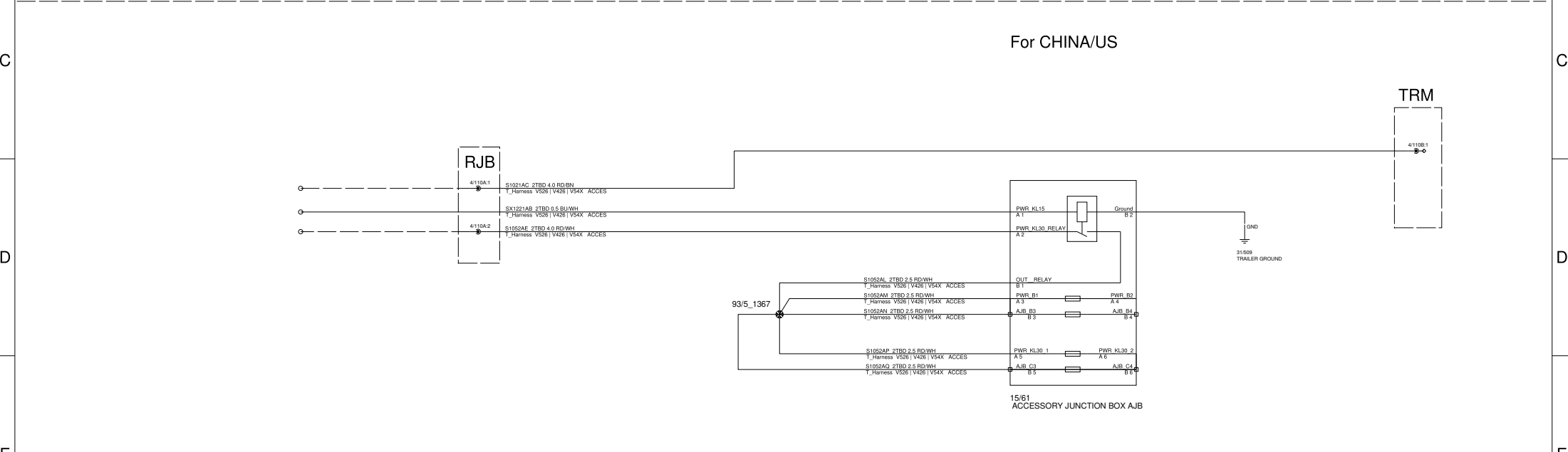

<p>The copying, distribution and utilization of this document as well as the communication of its contents to others without expressed authorization is prohibited. Offenders will be held liable for payment of damages. All rights reserved in the event of the grant of a patent, utility model or ornamental design registration.</p> <p><b>VOLVO</b> VOLVO CAR CORPORATION</p>	<p><b>Document title</b> SPA_Issue25_Release1 1F2_003_Accessory_Distribution_Box_AJB</p>	
	<p><b>Document Type</b> DRAW/ELSY</p>	<p><b>Edited</b> April/05/2023</p>
	<p><b>Release Status</b> RELEASED</p>	
	<p><b>Document No</b> 33409142</p>	<p><b>Issue</b> 035</p> <p><b>Page No</b> 48/177</p>

# 1F3 Accessories USB Charger/IPAD Holder V426 / V54X / V526 & 5SEAT & 7SEAT 519

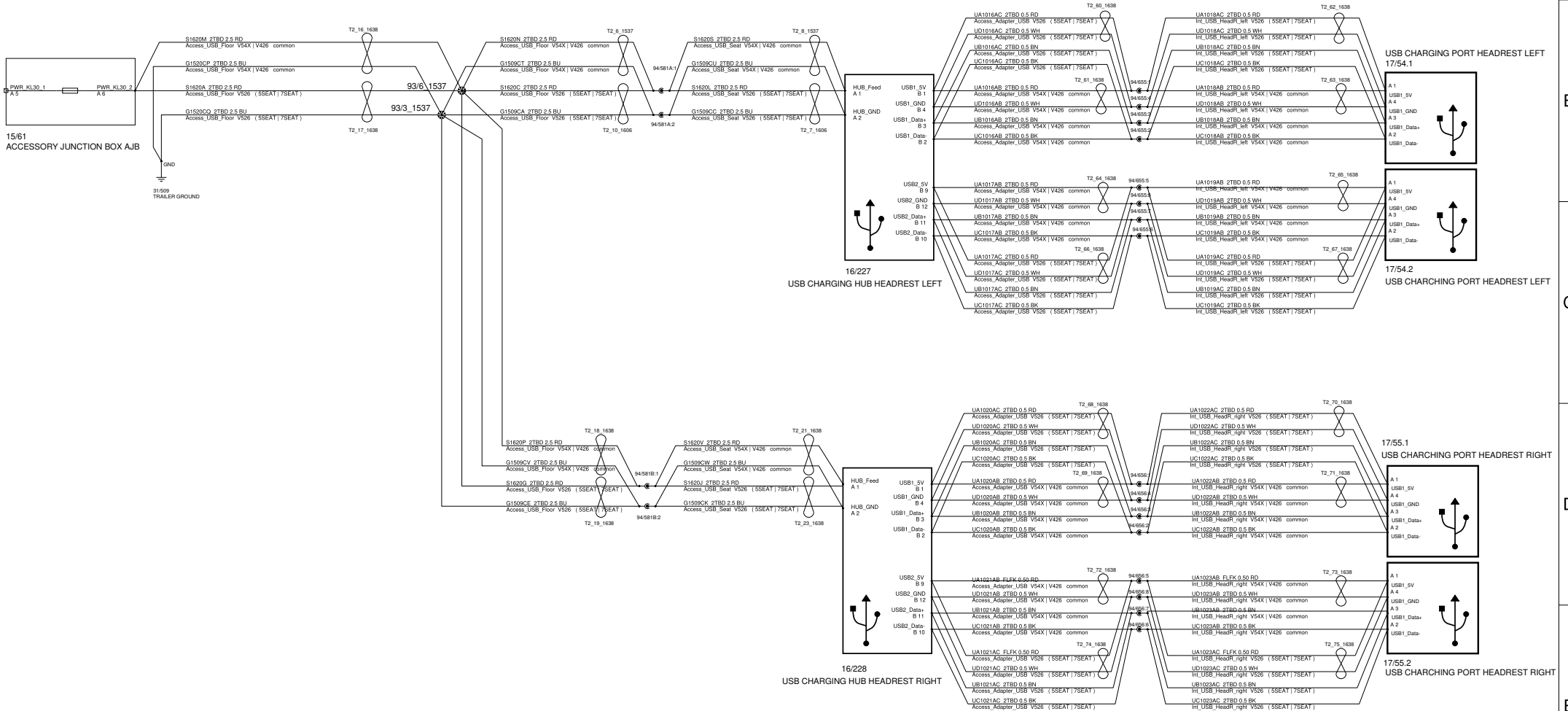

The copying, distribution and utilization of this document as well as the communication of its contents to others without expressed authorization is prohibited. Offenders will be held liable for payment of damages. All rights reserved in the event of the grant of a patent, utility model or ornamental design registration.		Document title SPA_Issue25_Release1	
1F3_004_Accessories_USB_Char_IPAD_V54X_V426_V526_5SEAT_7SEAT		Document Type DRAW/ELS	
VOLVO VOLVO CAR CORPORATION		Release Status RELEASED	
Document No 33409142	Issue 035	Page No 49/177	

# 1F3 Accessories USB Charger/IPAD Holder L541 5SEAT 519A-->

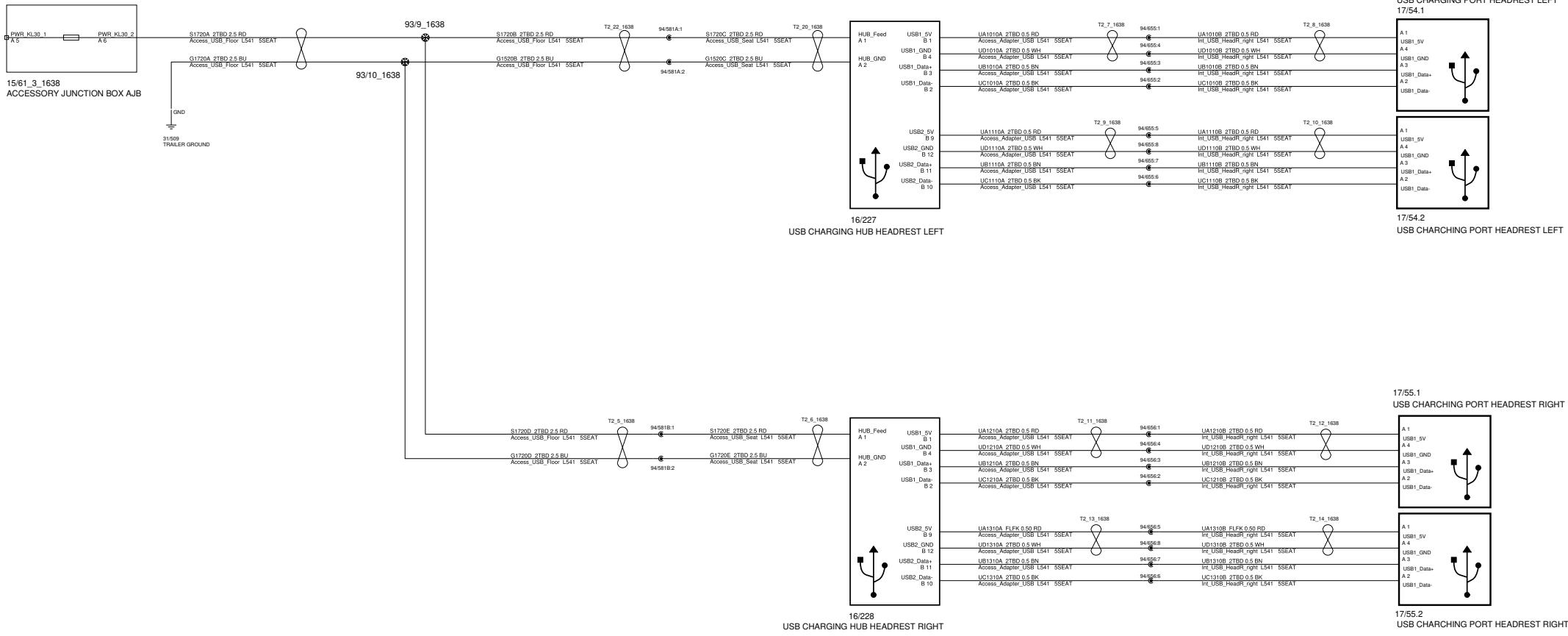

<p>The copying, distribution and utilization of this document as well as the communication of its contents to others without expressed authorization is prohibited. Offenders will be held liable for payment of damages. All rights reserved in the event of the grant of a patent, utility model or ornamental design registration.</p> <p style="font-size: 24pt; font-weight: bold; margin: 10px 0;">VOLVO</p> <p style="font-size: 10pt; margin: 0;">VOLVO CAR CORPORATION</p>	<p><b>Document title</b> SPA_Issue25_Release1 1F3_005_Accessories_USB_Char_IPAD_L541_5SEAT_519A</p>	
	<p><b>Document Type</b> DRAW/ELSY</p>	<p><b>Edited</b> June/16/2021</p>
	<p><b>Release Status</b> RELEASED</p>	
	<p><b>Document No</b> 33409142</p>	<p><b>Issue</b> 035</p>

# 1F4 Accessories LED Illumination

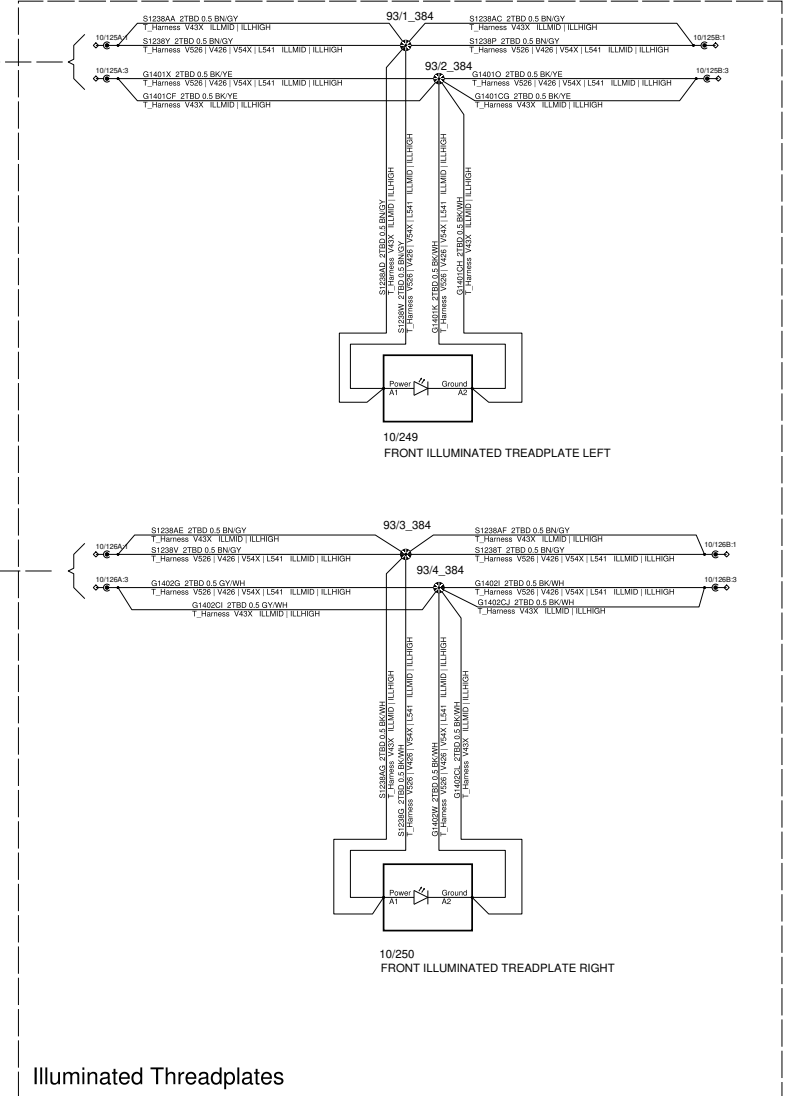
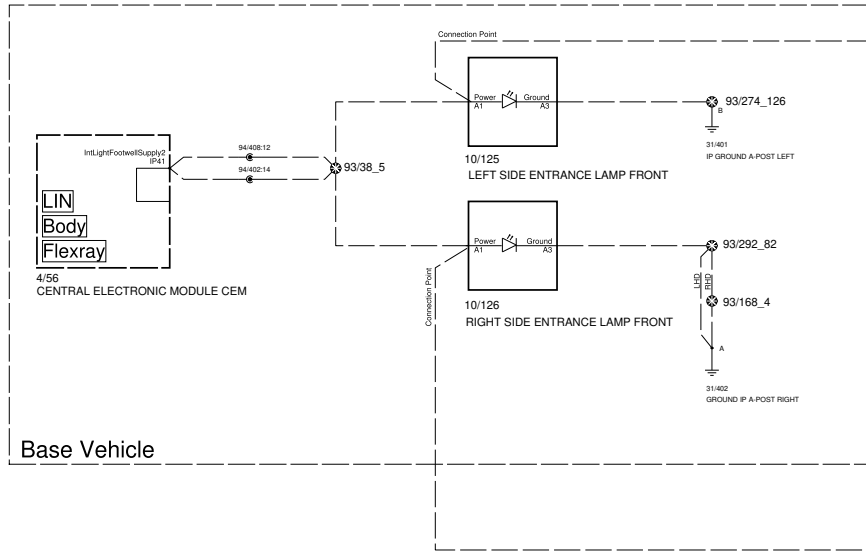

<p>The copying, distribution and utilization of this document as well as the communication of its contents to others without expressed authorization is prohibited. Offenders will be held liable for payment of damages. All rights reserved in the event of the grant of a patent, utility model or ornamental design registration.</p> <p><b>VOLVO</b> VOLVO CAR CORPORATION</p>	<b>Document title</b> SPA_Issue25_Release1	
	1F4_001A_Accessories_LED_Illumination	
	<b>Document Type</b> DRAW/ELSY	<b>Edited</b> August/25/2022
	<b>Release Status</b> RELEASED	
<b>Document No</b> 33409142	<b>Issue</b> 035	<b>Page No</b> 51/177

# 1F4 Accessories LED Illumination

## Passthrough 94/604 - (14pol)

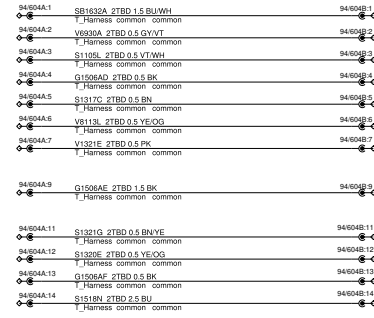

## Base Vehicle

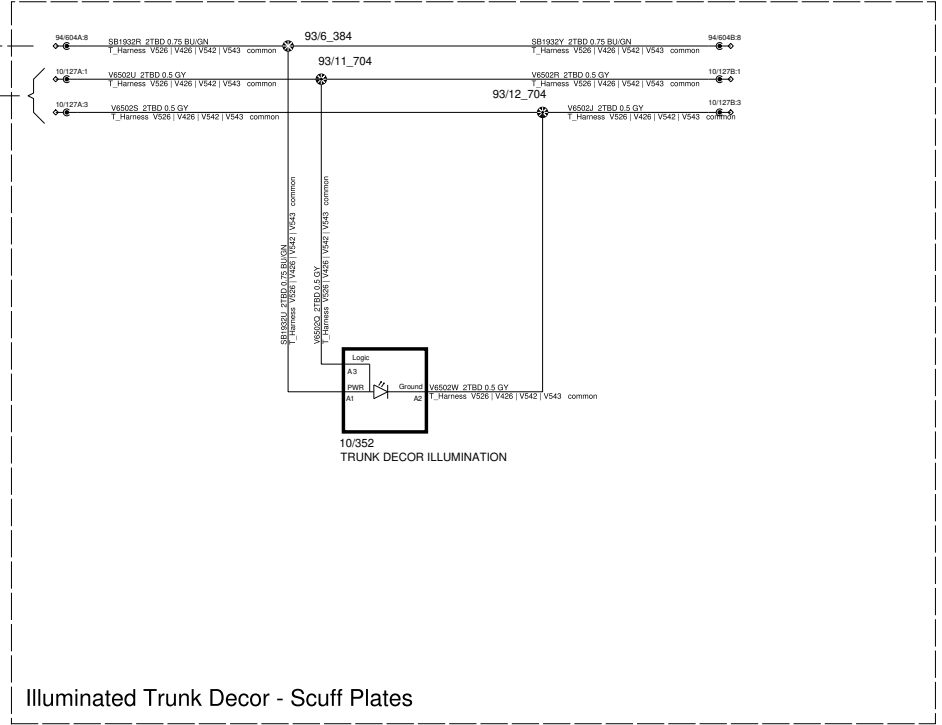
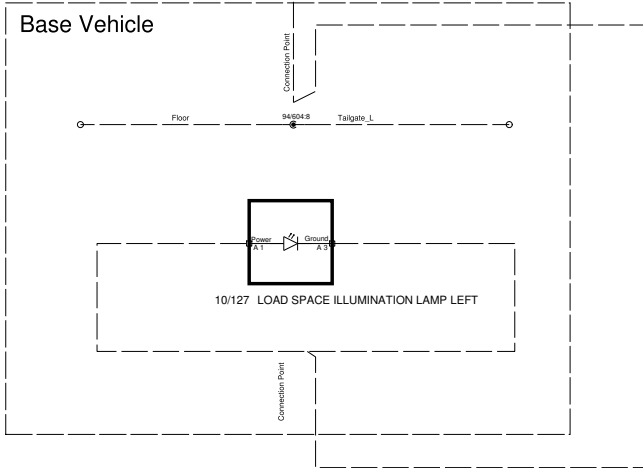

<p>The copying, distribution and utilization of this document as well as the communication of its contents to others without expressed authorization is prohibited. Offenders will be held liable for payment of damages. All rights reserved in the event of the grant of a patent, utility model or ornamental design registration.</p> <p><b>VOLVO</b> VOLVO CAR CORPORATION</p>	<p><b>Document title</b> SPA_Issue25_Release1 1F4_001B_Accessories_LED_Illumination</p>	
	<p><b>Document Type</b> DRAW/ELSY</p>	<p><b>Edited</b> January/13/2022</p>
	<p><b>Release Status</b> RELEASED</p>	
	<p><b>Document No</b> 33409142</p>	<p><b>Issue</b> 035</p> <p><b>Page No</b> 52/177</p>

# 1F4 Accessories LED Running Board and Emblem

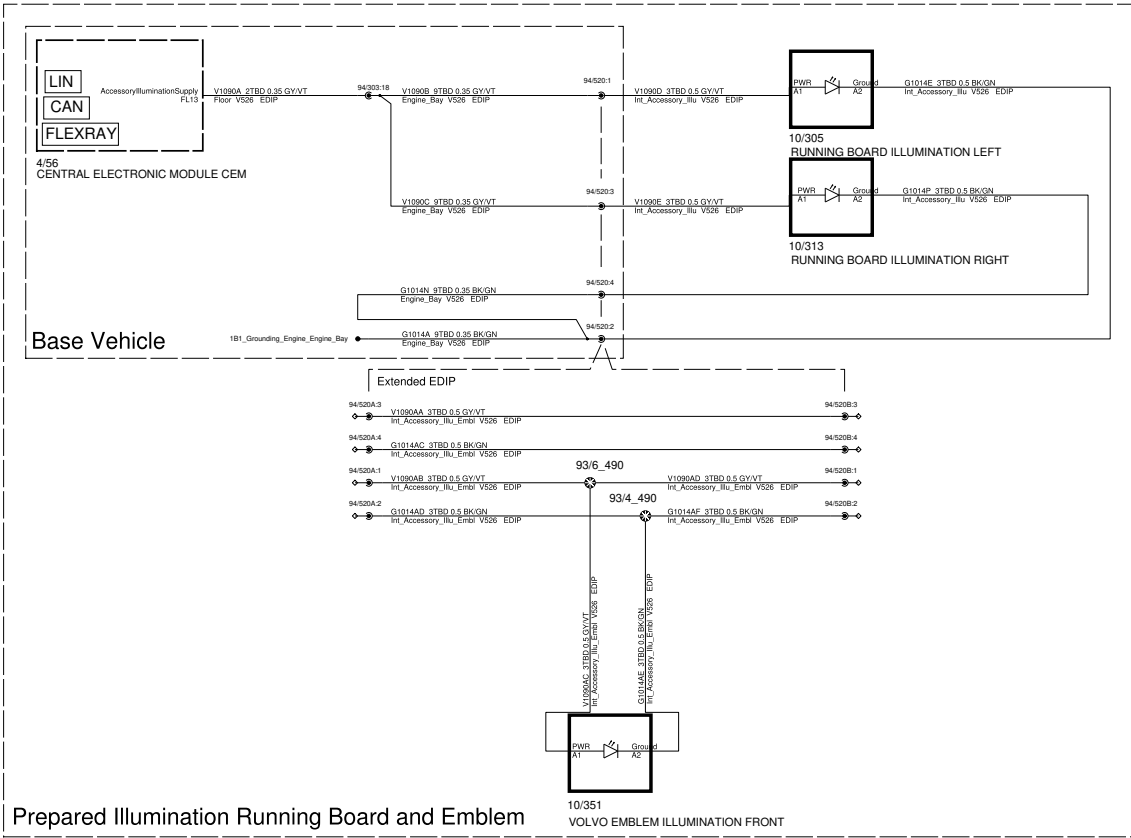
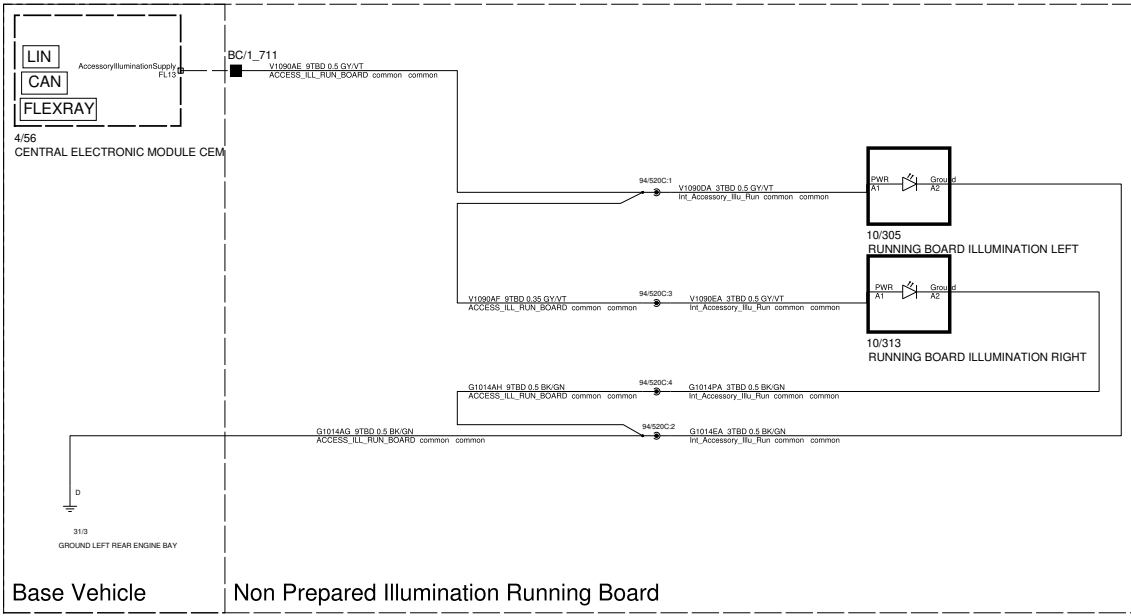

<p>The copying, distribution and utilization of this document as well as the communication of its contents to others without expressed authorization is prohibited. Offenders will be held liable for payment of damages. All rights reserved in the event of the grant of a patent, utility model or ornamental design registration.</p> <p><b>VOLVO</b> VOLVO CAR CORPORATION</p>	<b>Document title</b> SPA_Issue25_Release1 1F4_001C_Accessories_LED_Running_Board		
	<b>Document Type</b> DRAW/ELSY	<b>Edited</b> June/16/2021	
	<b>Release Status</b> RELEASED		
	<b>Document No</b> 33409142	<b>Issue</b> 035	<b>Page No</b> 53/177

# 1F5 Accessories Alcolock Preparation

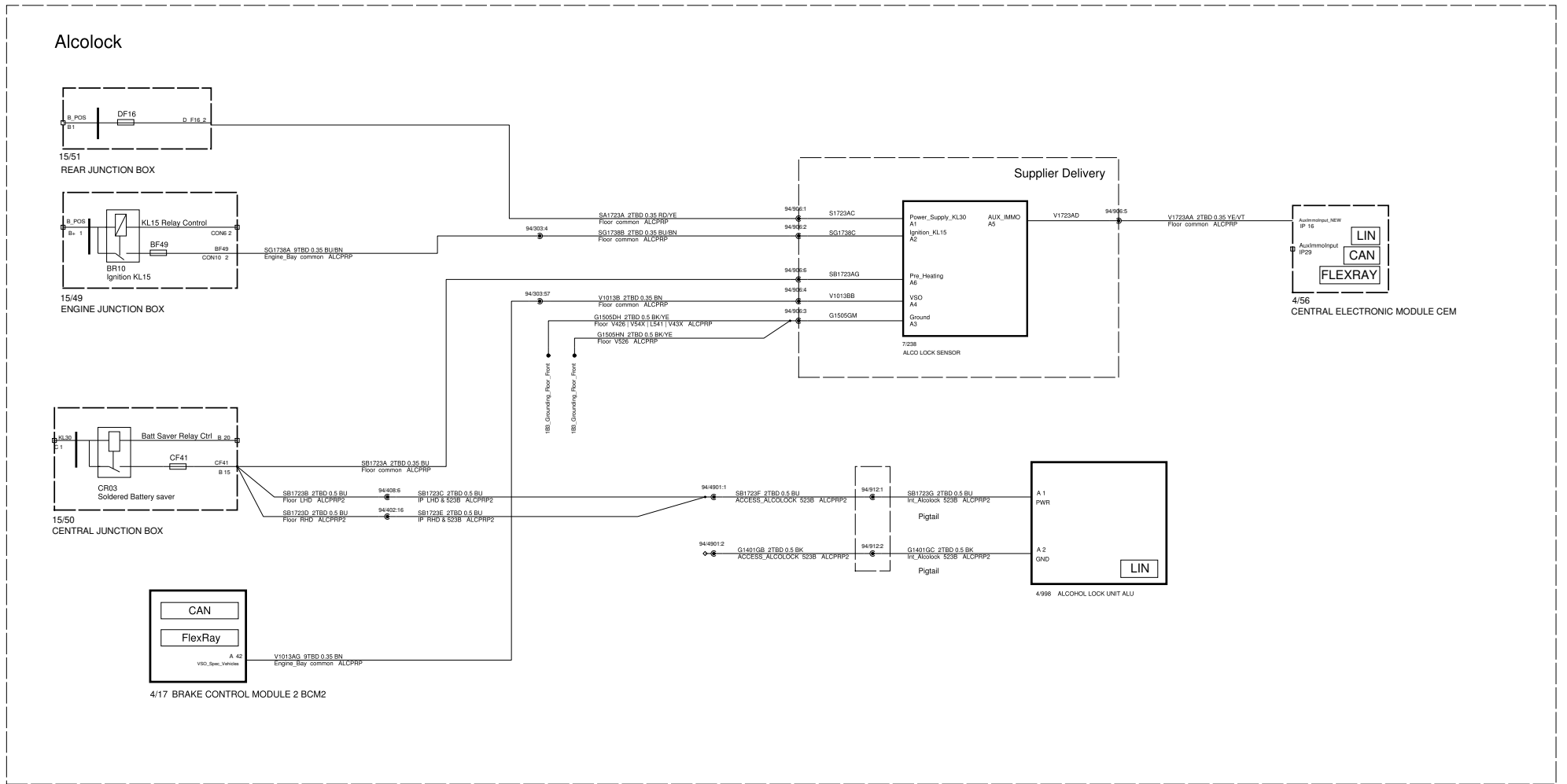

<p>The copying, distribution and utilization of this document as well as the communication of its contents to others without expressed authorization is prohibited. Offenders will be held liable for payment of damages. All rights reserved in the event of the grant of a patent, utility model or ornamental design registration.</p> <p><b>VOLVO</b> VOLVO CAR CORPORATION</p>	<p><b>Document title</b> SPA_Issue25_Release1 1F5_001_Accessories_Alcolock_prep</p>	
	<p><b>Document Type</b> DRAW/ELSY</p>	<p><b>Edited</b> March/17/2023</p>
	<p><b>Release Status</b> RELEASED</p>	
	<p><b>Document No</b> 33409142</p>	<p><b>Issue</b> 035</p>

# 1F5 Accessories Alcolock Aftermarket

## Alcolock

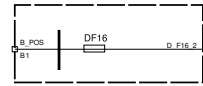

15/51  
REAR JUNCTION BOX

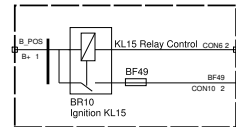

15/49  
ENGINE JUNCTION BOX

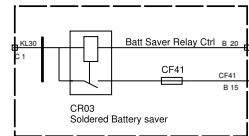

15/50  
CENTRAL JUNCTION BOX

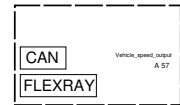

4/163  
VEHICLE DYNAMICS DOMAIN MASTER

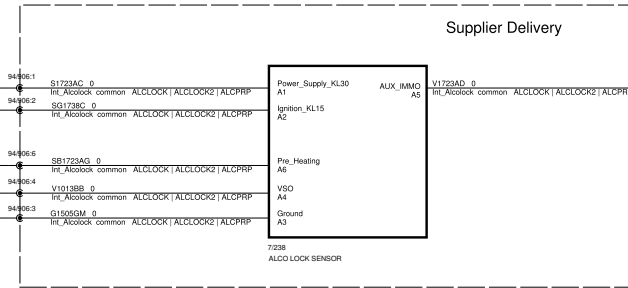

Supplier Delivery

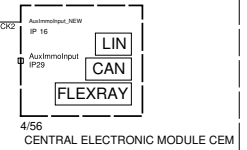

4/56  
CENTRAL ELECTRONIC MODULE CEM



<p>The copying, distribution and utilization of this document as well as the communication of its contents to others without expressed authorization is prohibited. Offenders will be held liable for payment of damages. All rights reserved in the event of the grant of a patent, utility model or ornamental design registration.</p>	<p><b>Document title</b> SPA_Issue25_Release1 1F5_002_Accessories_Alcolock</p>	
	<p><b>Document Type</b> DRAW/ELSY</p>	<p><b>Edited</b> April/04/2023</p>
<p><b>VOLVO</b> VOLVO CAR CORPORATION</p>	<p><b>Release Status</b> RELEASED</p>	
	<p><b>Document No</b> 33409142</p>	<p><b>Issue</b> 035</p>
	<p><b>Page No</b> 55/177</p>	



# Accessories USB 2.0 HUB Repair Harness 518A-->

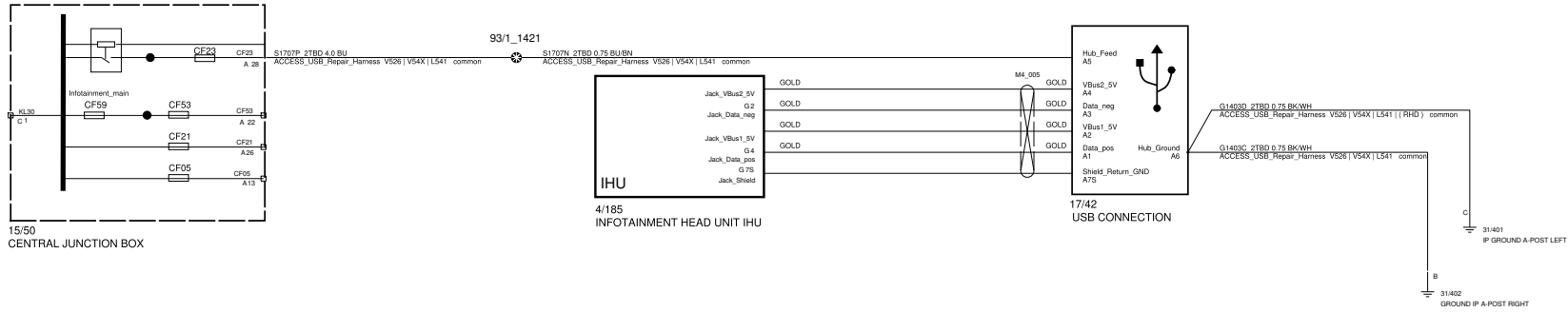

<p>The copying, distribution and utilization of this document as well as the communication of its contents to others without expressed authorization is prohibited. Offenders will be held liable for payment of damages. All rights reserved in the event of the grant of a patent, utility model or ornamental design registration.</p> <p><b>VOLVO</b> VOLVO CAR CORPORATION</p>	<p><b>Document title</b> SPA_Issue25_Release1 1F10_Accessories_Repair_USB_2.0</p>		
	<p><b>Document Type</b> DRAW/ELSY</p>	<p><b>Edited</b> March/20/2023</p>	
	<p><b>Release Status</b> RELEASED</p>		
	<p><b>Document No</b> 33409142</p>	<p><b>Issue</b> 035</p>	<p><b>Page No</b> 56/177</p>

# 1F12\_001 ACCESSORIES PARK ASSIST PILOT FRONT V43X

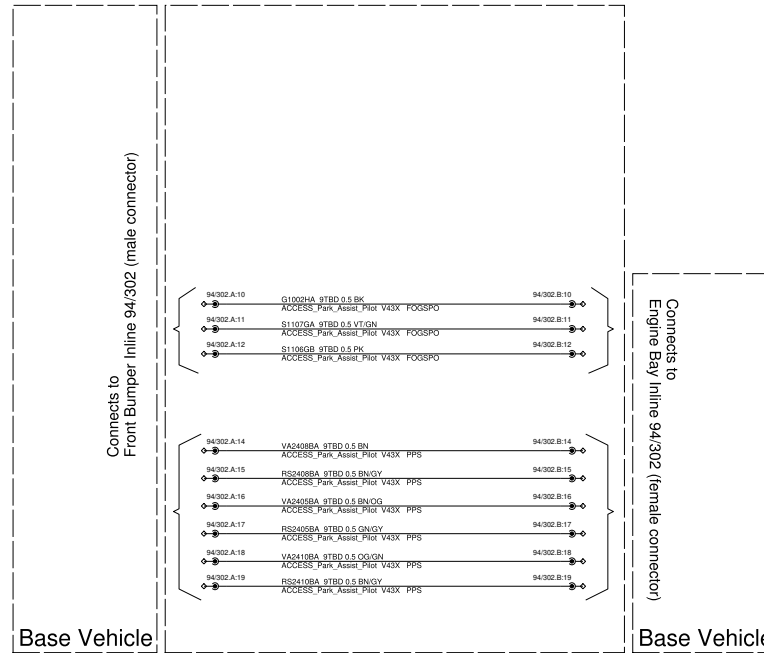

<p>The copying, distribution and utilization of this document as well as the communication of its contents to others without expressed authorization is prohibited. Offenders will be held liable for payment of damages. All rights reserved in the event of the grant of a patent, utility model or ornamental design registration.</p> <p><b>VOLVO</b> VOLVO CAR CORPORATION</p>	<b>Document title</b> SPA_Issue25_Release1 1F12_001_Accessories_Park_Assist_Pilot_Front_V43X	
	<b>Document Type</b> DRAW/ELSY	<b>Edited</b> March/15/2023
	<b>Release Status</b> RELEASED	
	<b>Document No</b> 33409142	<b>Issue</b> 035

# 1F12\_001 ACCESSORIES PARK ASSIST PILOT REAR V43X

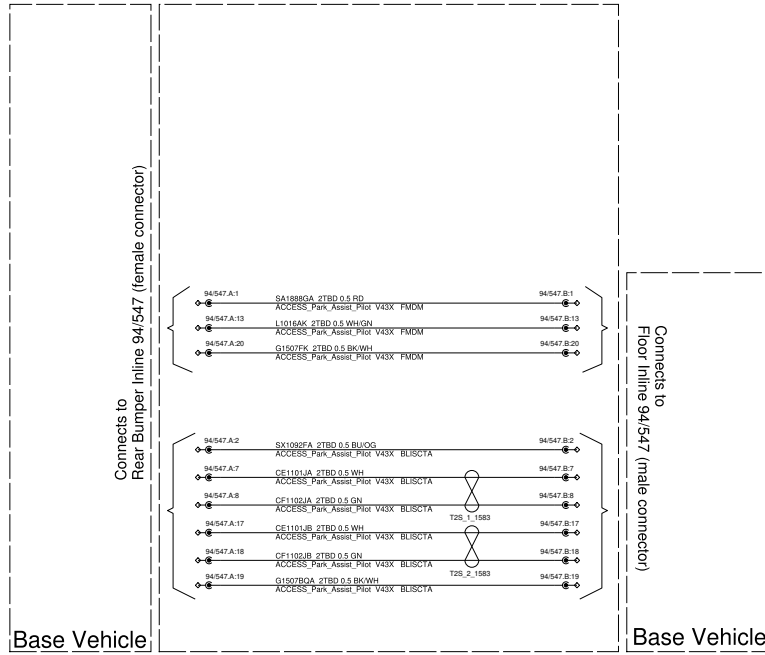

<p>The copying, distribution and utilization of this document as well as the communication of its contents to others without expressed authorization is prohibited. Offenders will be held liable for payment of damages. All rights reserved in the event of the grant of a patent, utility model or ornamental design registration.</p> <p><b>VOLVO</b> VOLVO CAR CORPORATION</p>	<b>Document title</b> SPA_Issue25_Release1 1F12_002_Accessories_Park_Assist_Pilot_Rear_V43X	
	<b>Document Type</b> DRAW/ELSY	<b>Edited</b> March/15/2023
	<b>Release Status</b> RELEASED	
	<b>Document No</b> 33409142	<b>Issue</b> 035

# 1H EI Distribution High Voltage 521H

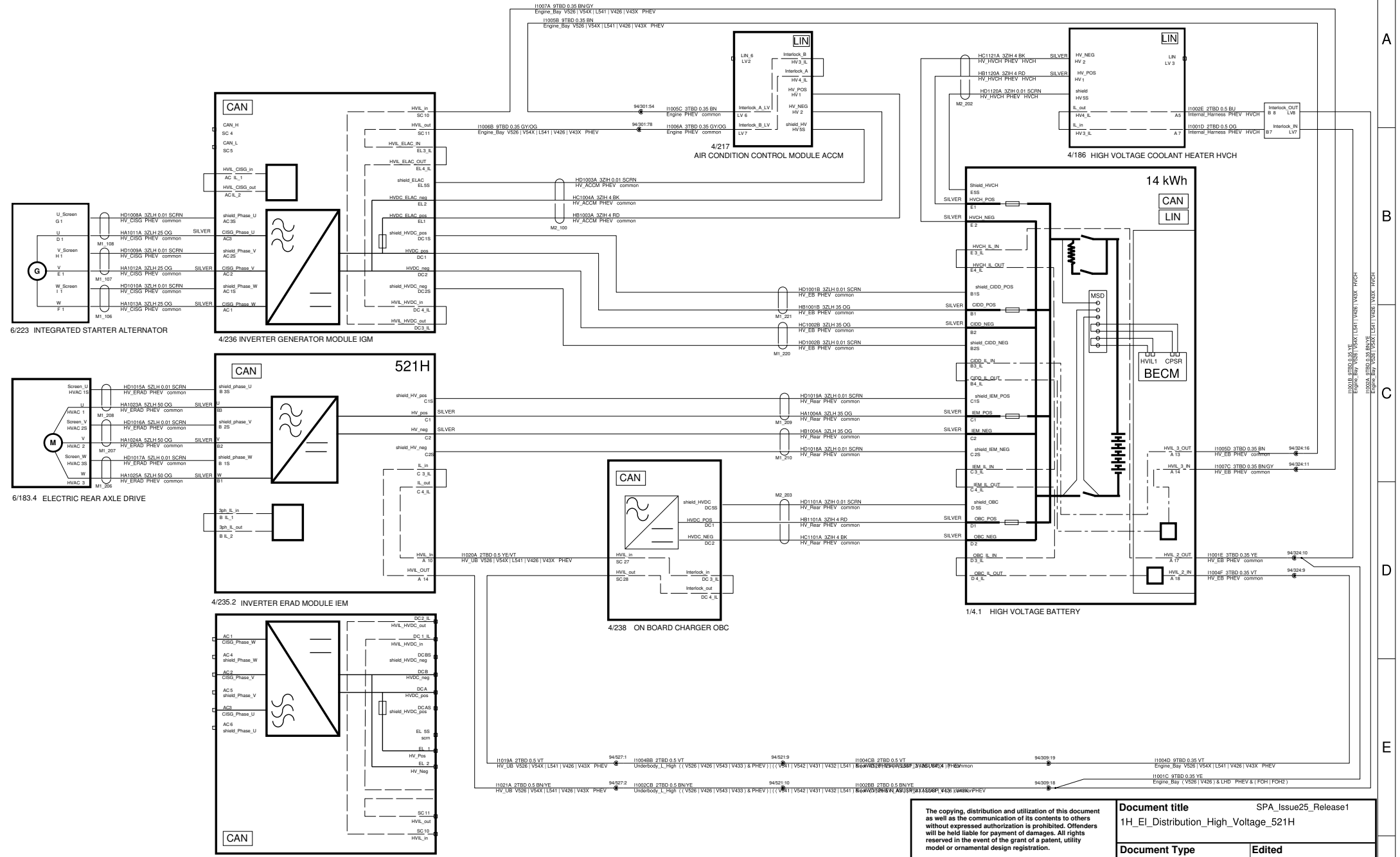

<p>The copying, distribution and utilization of this document as well as the communication of its contents to others without expressed authorization is prohibited. Offenders will be held liable for payment of damages. All rights reserved in the event of the grant of a patent, utility model or ornamental design registration.</p>		<p><b>Document title</b> SPA_Issue25_Release1 1H_EI_Distribution_High_Voltage_521H</p>	
<p><b>Document Type</b> DRAW/ELSY</p>		<p><b>Edited</b> April/05/2023</p>	
<p><b>Release Status</b> RELEASED</p>			
<p><b>Document No</b> 33409142</p>		<p><b>Issue</b> 035</p>	<p><b>Page No</b> 59/177</p>



VOLVO CAR CORPORATION

# 1K EI Energy Management High Voltage\_521H

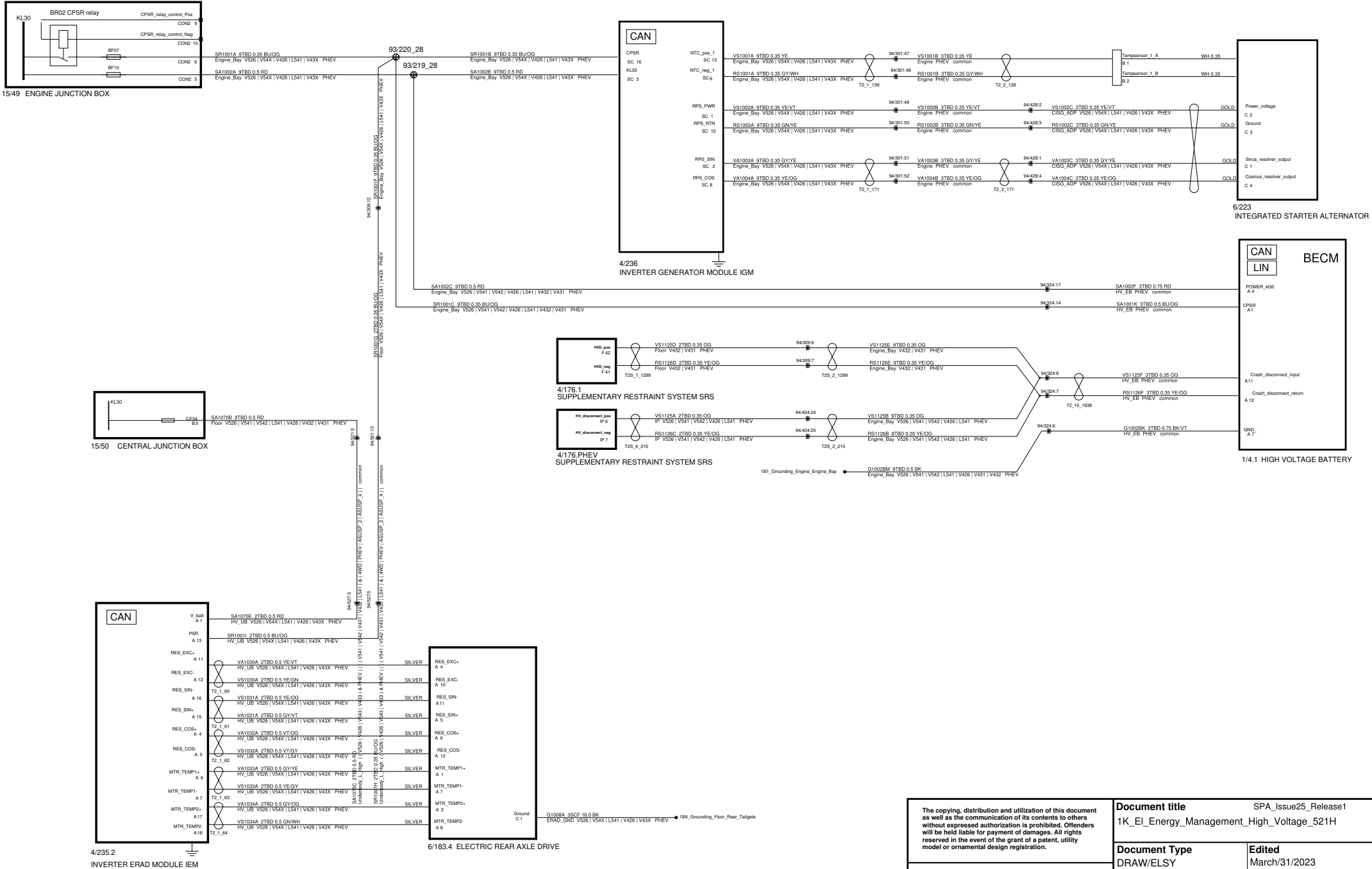

<p>The copying, distribution and utilization of this document as well as the communication of its contents to others without expressed authorization is prohibited. Offenders will be held liable for payment of damages. All rights reserved in the event of the grant of a patent, utility model or ornamental design registration.</p>		<p><b>Document title</b> SPA_Issue25_Release1 1K_EI_Energy_Management_High_Voltage_521H</p>	
		<p><b>Document Type</b> DRAW/ELSY</p>	<p><b>Issued</b> March/31/2023</p>
<p><b>VOLVO</b> VOLVO CAR CORPORATION</p>		<p><b>Release Status</b> RELEASED</p>	
		<p><b>Document No</b> 33409142</p>	<p><b>Issue</b> 035 <b>Page No</b> 60/177</p>

# 1L2 EI generating public network

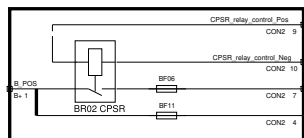

15/49 ENGINE JUNCTION BOX

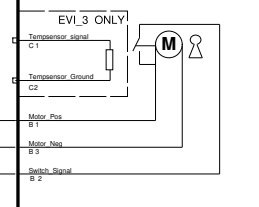
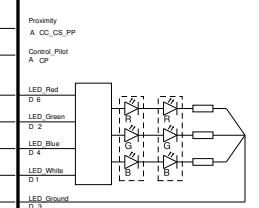
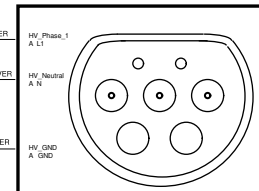
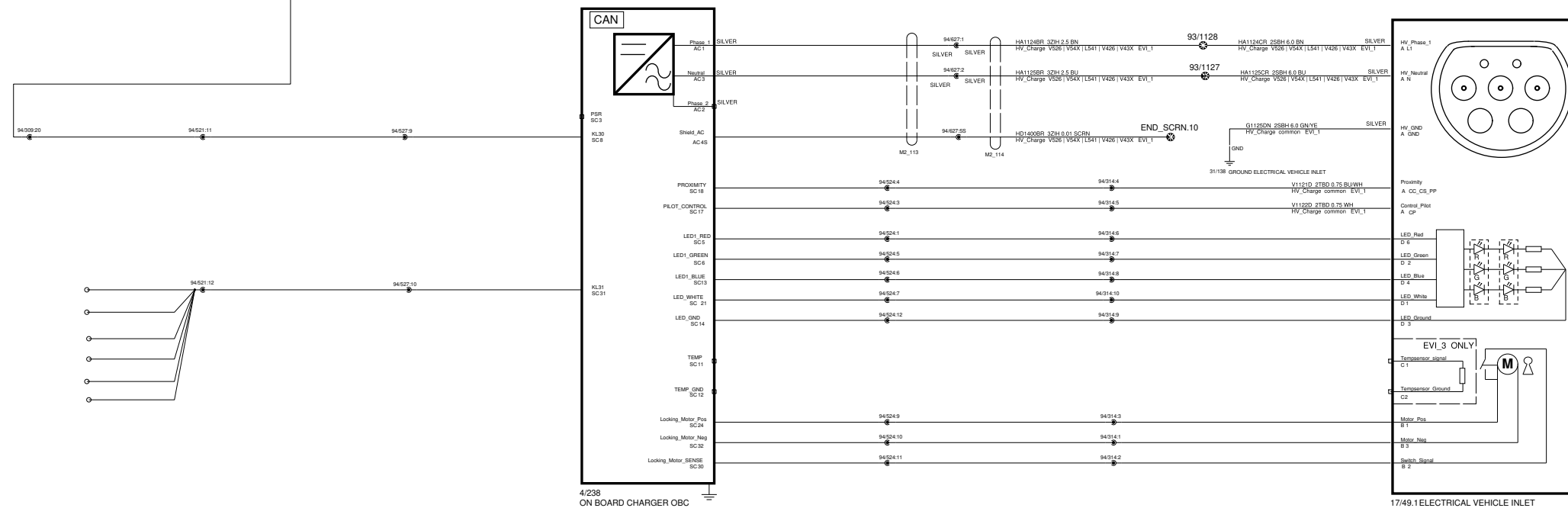

17/49,1 ELECTRICAL VEHICLE INLET

 VOLVO CAR CORPORATION	<b>Document title</b> SPA_Issue25_Release1 1L_EI_generating_public_network_523A_EVI_1	
	<b>Document Type</b> DRAW/ELSY	<b>Edited</b> March/22/2023
	<b>Release Status</b> RELEASED	
	<b>Document No</b> 33409142	<b>Issue</b> 035

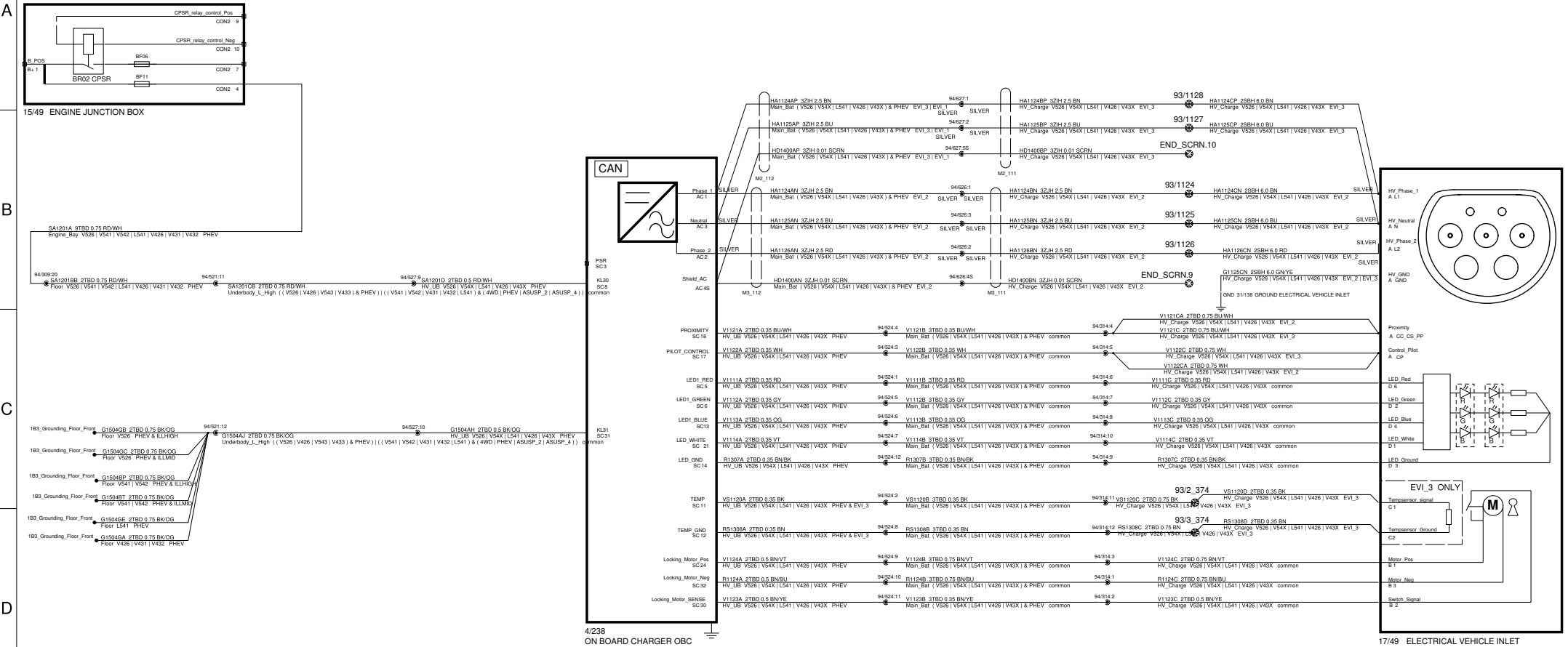

<p>The copying, distribution and utilization of this document as well as the communication of its contents to others without expressed authorization is prohibited. Offenders will be held liable for payment of damages. All rights reserved in the event of the grant of a patent, utility model or ornamental design registration.</p> <p><b>VOLVO</b> VOLVO CAR CORPORATION</p>	<b>Document title</b> SPA_Issue25_Release1 1L_EI_generating_public_network_523A_EVI_2_EVI_3	
	<b>Document Type</b> DRAW/ELSY	<b>Edited</b> April/05/2023
	<b>Release Status</b> RELEASED	
<b>Document No</b> 33409142	<b>Issue</b> 035	<b>Page No</b> 62/177



ACCESS\_MVBM\_Adaptor harness to be used when replacing the MVBM introduced in 519A with the MVBM introduced in 520B.

Adapter Harness Floor Harness

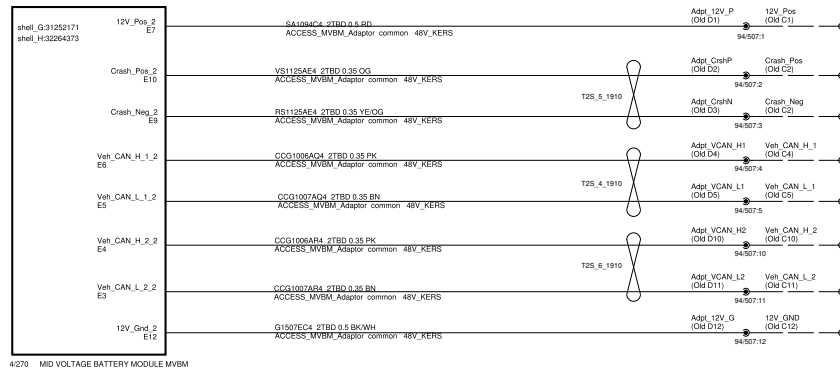

4/270 MID VOLTAGE BATTERY MODULE MVBM

<p>The copying, distribution and utilization of this document as well as the communication of its contents to others without expressed authorization is prohibited. Offenders will be held liable for payment of damages. All rights reserved in the event of the grant of a patent, utility model or ornamental design registration.</p> <p><b>VOLVO</b> VOLVO CAR CORPORATION</p>	<p><b>Document title</b> SPA_Issue25_Release1 1M_001_MVBM_Adaptor</p>	
	<p><b>Document Type</b> DRAW/ELSY</p>	<p><b>Edited</b> April/05/2023</p>
	<p><b>Release Status</b> RELEASED</p>	
	<p><b>Document No</b> 33409142</p>	<p><b>Issue</b> 035</p>



# 48V Power Distribution

# 1 M EI Distribution Mid Voltage

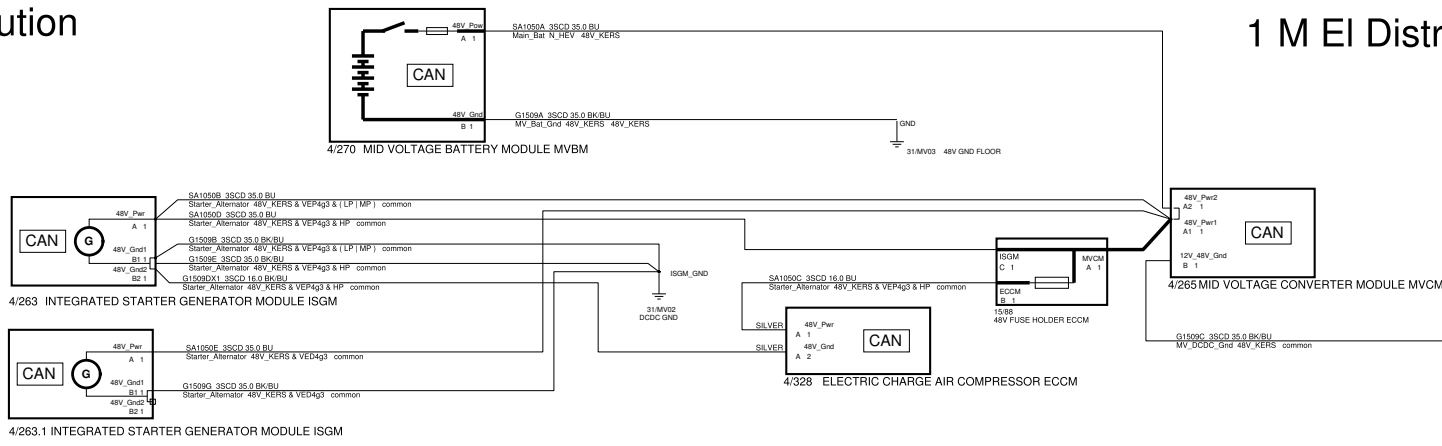

# 12V Signals / Power Supplies

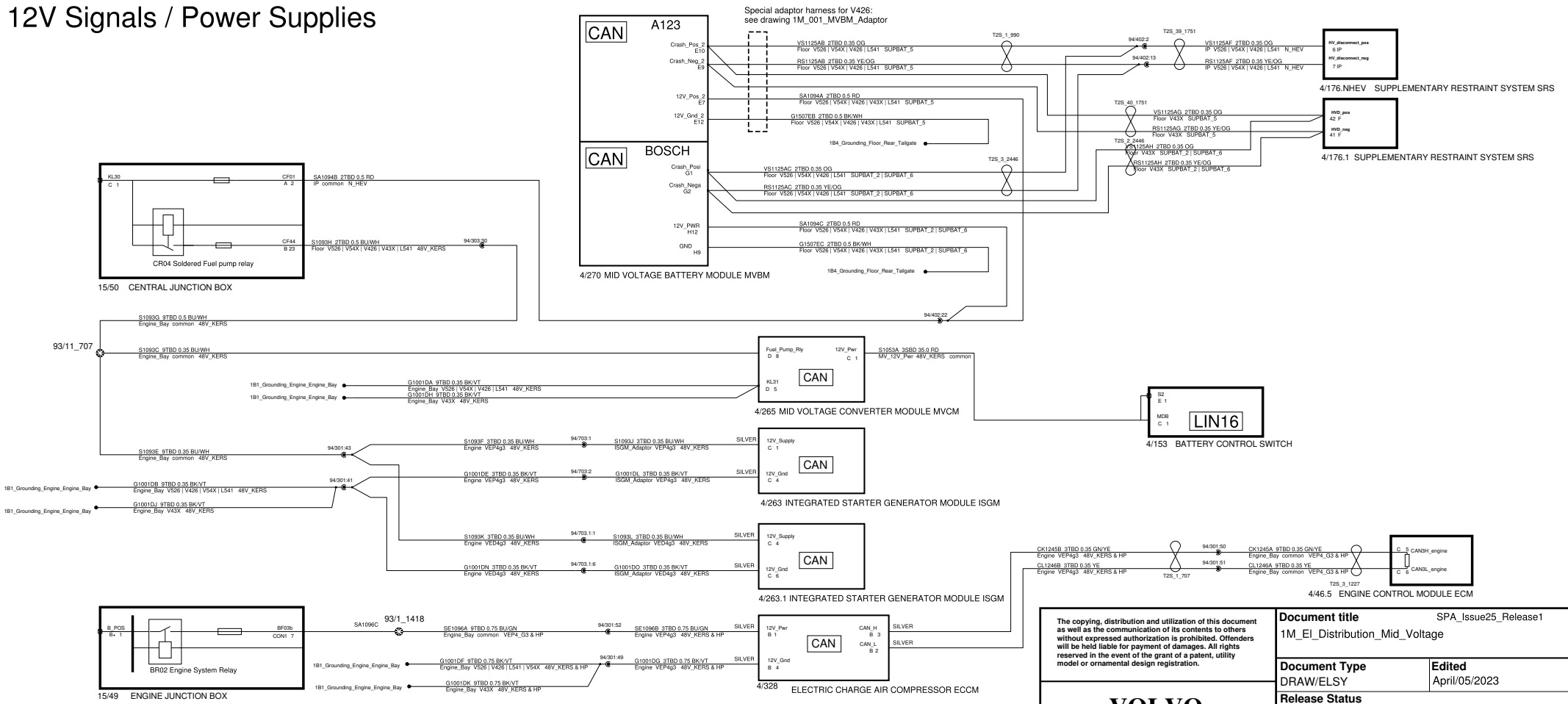

<p>The copying, distribution and utilization of this document as well as the communication of its contents to others without expressed authorization is prohibited. Offenders will be held liable for payment of damages. All rights reserved in the event of the grant of a patent, utility model or ornamental design registration.</p> <p><b>VOLVO</b> VOLVO CAR CORPORATION</p>		<p>Document title SPA_issue25_Release1 1M_EI_Distribution_Mid_Voltage</p>	
		<p>Document Type DRAW/ELSY</p>	<p>Edited April/05/2023</p>
<p>RELEASED</p>		<p>Release Status</p>	<p>Issue</p>
		<p>Document No 33409142</p>	<p>Page No 64/177</p>

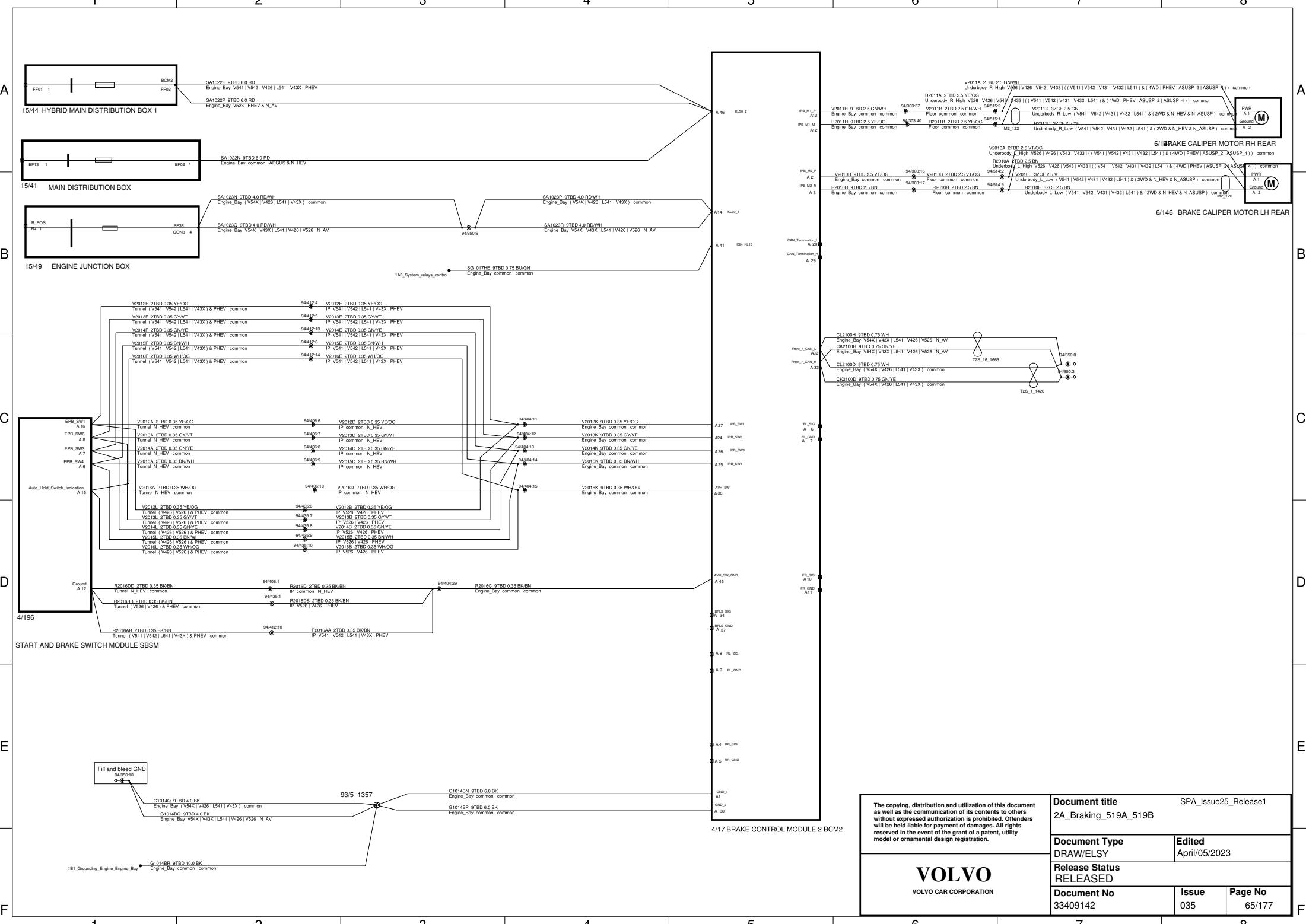

<p>The copying, distribution and utilization of this document as well as the communication of its contents to others without expressed authorization is prohibited. Offenders will be held liable for payment of damages. All rights reserved in the event of the grant of a patent, utility model or ornamental design registration.</p> <p style="text-align: center;"><b>VOLVO</b> VOLVO CAR CORPORATION</p>		<p><b>Document title</b> SPA_Issue25_Release1 2A_Braking_519A_519B</p>	
		<p><b>Document Type</b> DRAW/ELSY</p>	<p><b>Edited</b> April/05/2023</p>
<p><b>Release Status</b> RELEASED</p>		<p><b>Document No</b> 33409142</p>	<p><b>Issue</b> 035</p>
		<p><b>Page No</b> 65/177</p>	

# 2E Power Steering

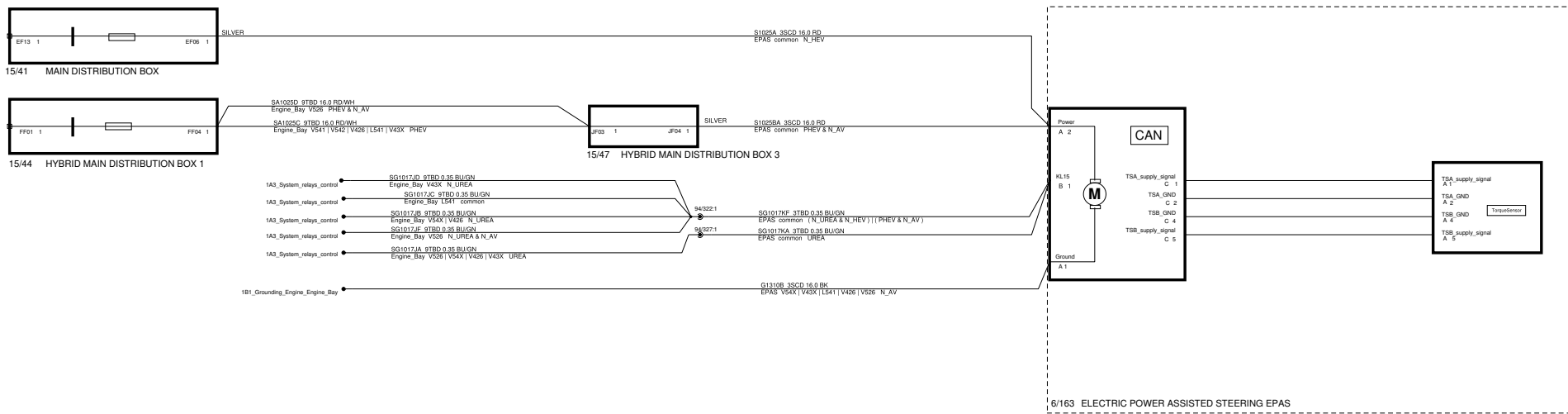

The copying, distribution and utilization of this document as well as the communication of its contents to others without expressed authorization is prohibited. Offenders will be held liable for payment of damages. All rights reserved in the event of the grant of a patent, utility model or ornamental design registration.		Document title SPA_Issue25_Release1 2E_Power_Steering	
Document Type DRAW/ELSY		Edited March/31/2023	
Release Status RELEASED			
Document No 33409142	Issue 035	Page No 66/177	



# 2F Damping Control 2G Levelling Control

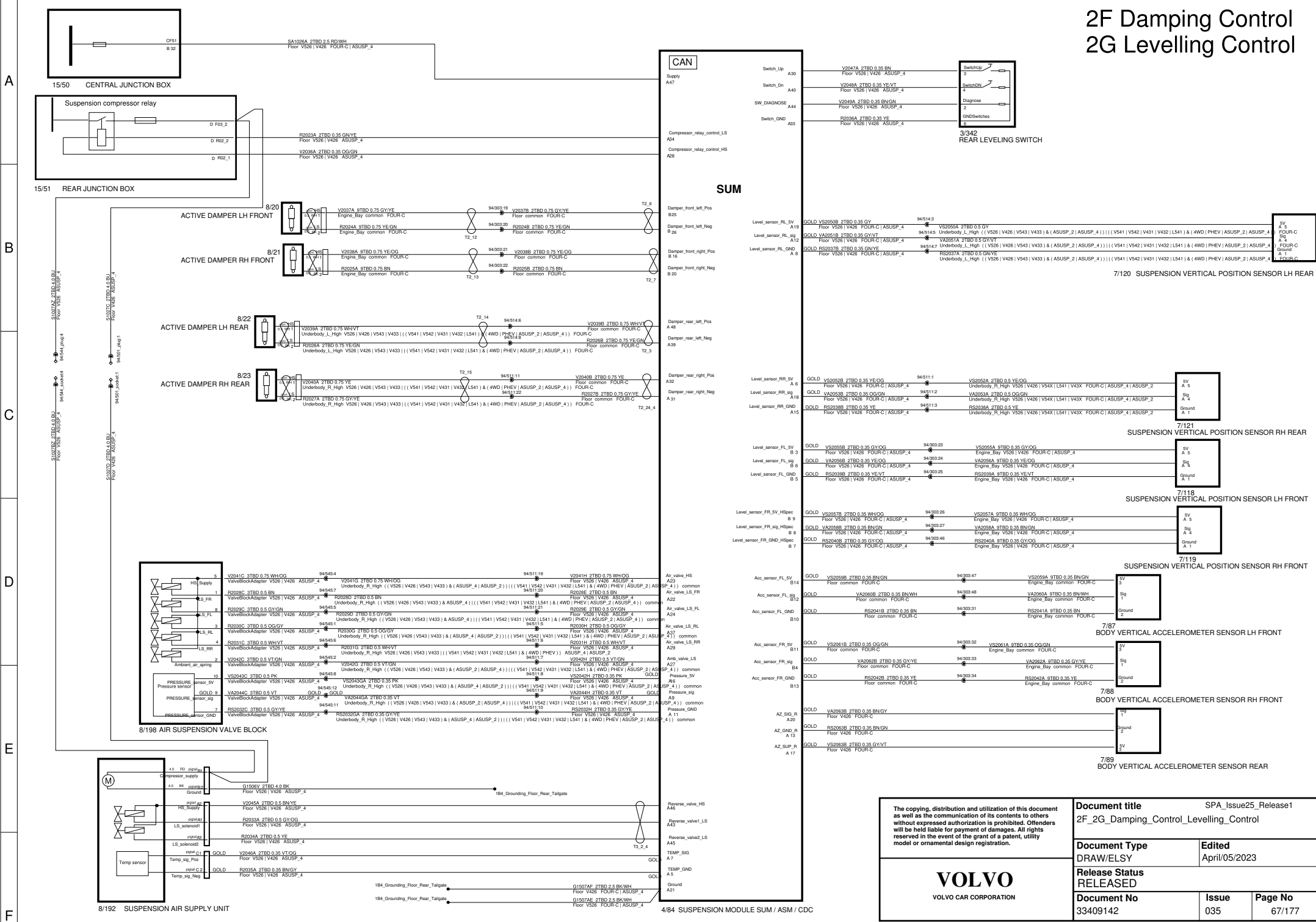

The copying, distribution and utilization of this document as well as the communication of its contents to others without expressed authorization is prohibited. Offenders will be held liable for payment of damages. All rights reserved in the event of the grant of a patent, utility model or ornamental design registration.		<b>Document title</b> SPA_Issue25_Release1 2F_2G_Damping_Control_Levelling_Control	
<b>Document Type</b> DRAW/ELSY		<b>Edited</b> April/05/2023	
<b>Release Status</b> RELEASED			
<b>Document No</b> 33409142	<b>Issue</b> 035	<b>Page No</b> 67/177	



4/84 SUSPENSION MODULE SUM / ASM / CDC

# 2G1\_Rear\_Levelling

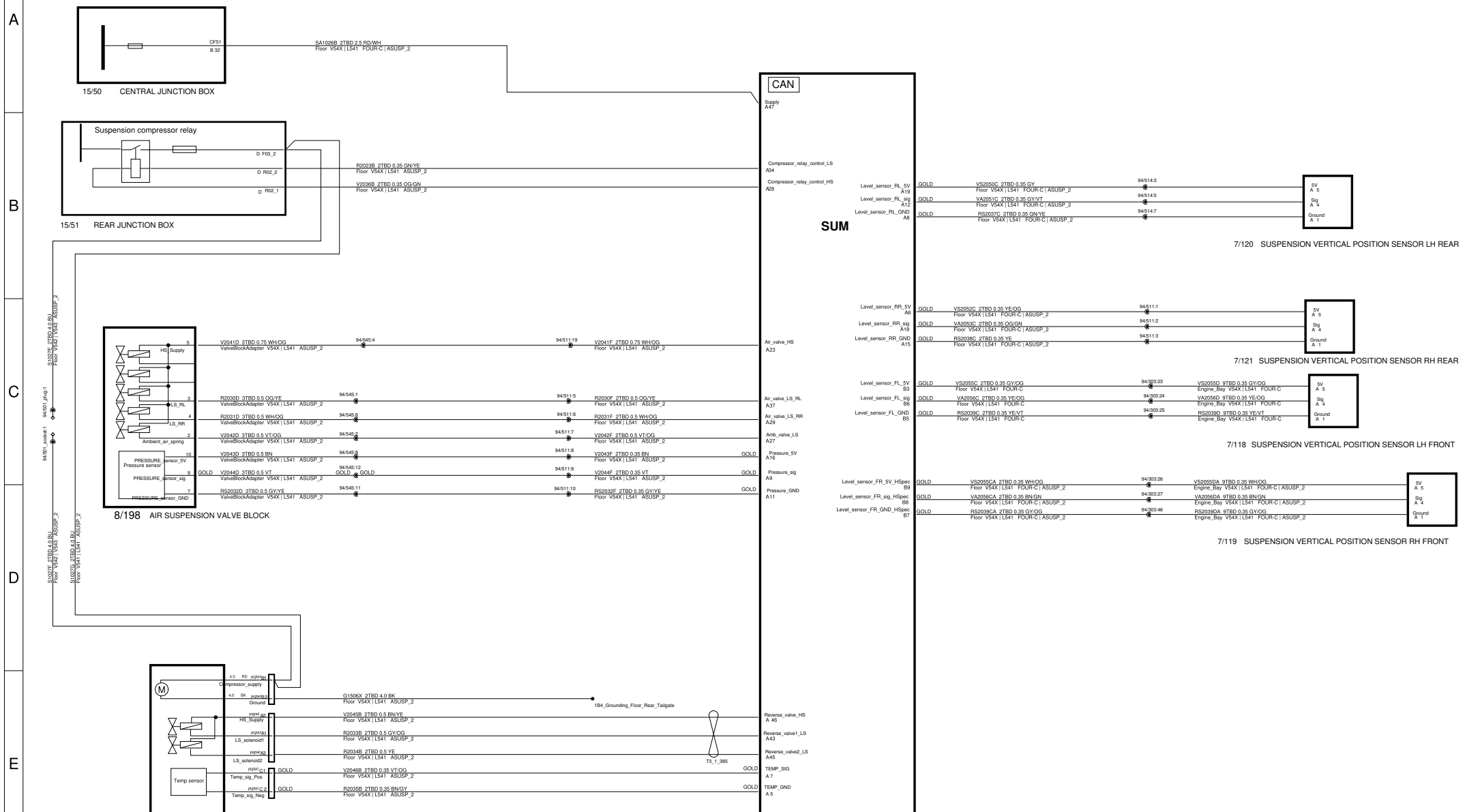

The copying, distribution and utilization of this document as well as the communication of its contents to others without expressed authorization is prohibited. Offenders will be held liable for payment of damages. All rights reserved in the event of the grant of a patent, utility model or ornamental design registration.		<b>Document title</b> SPA_Issue25_Release1	
		<b>Document Type</b> DRAW/ELSY	
<b>VOLVO</b> VOLVO CAR CORPORATION		<b>Edited</b> April/05/2023	
		<b>Release Status</b> RELEASED	
<b>Document No</b> 33409142	<b>Issue</b> 035	<b>Page No</b> 68/177	



# 2G Levelling Control

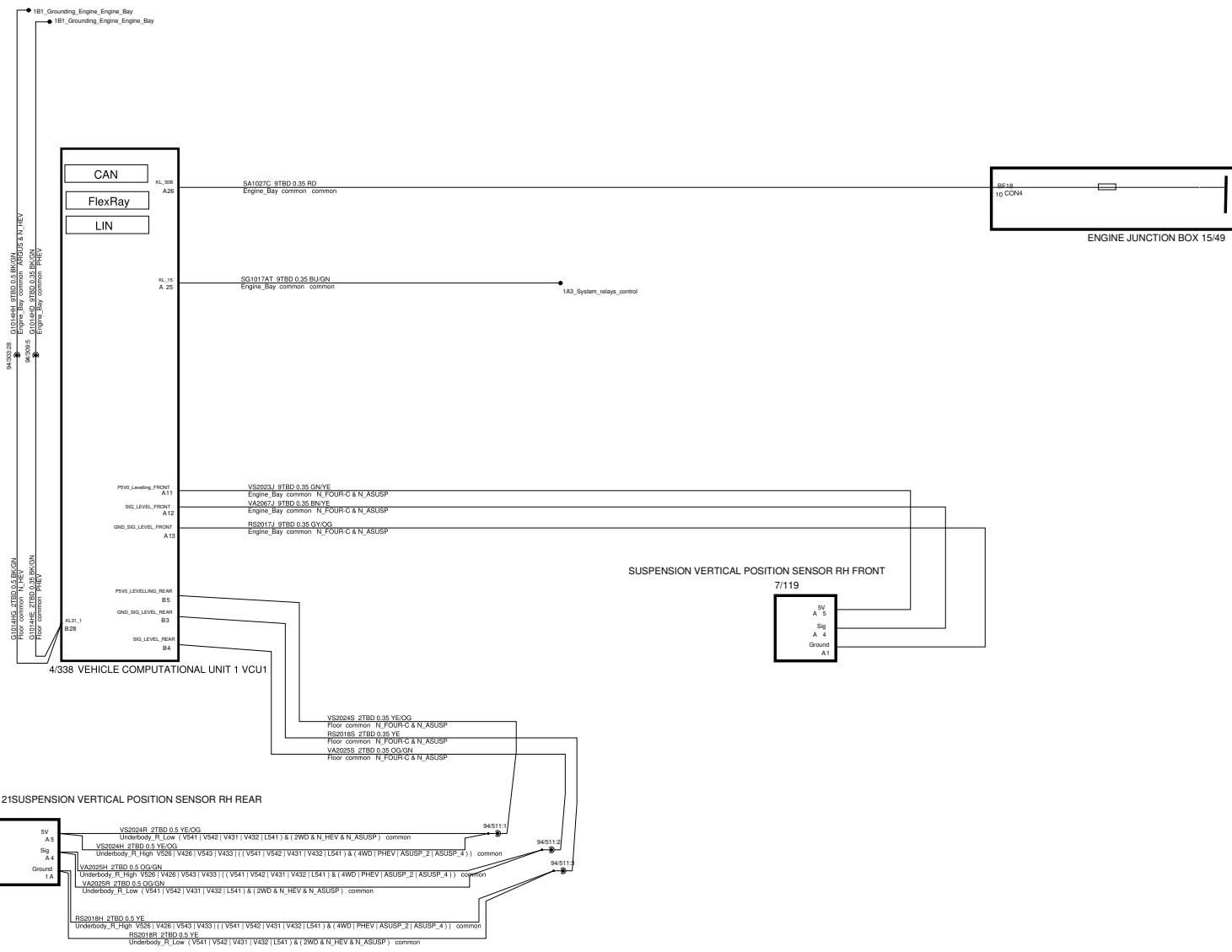

<p>The copying, distribution and utilization of this document as well as the communication of its contents to others without expressed authorization is prohibited. Offenders will be held liable for payment of damages. All rights reserved in the event of the grant of a patent, utility model or ornamental design registration.</p> <p><b>VOLVO</b> VOLVO CAR CORPORATION</p>	<b>Document title</b> SPA_Issue25_Release1 2G_Levelling_Control	
	<b>Document Type</b> DRAW/ELSY	<b>Edited</b> April/05/2023
	<b>Release Status</b> RELEASED	
	<b>Document No</b> 33409142	<b>Issue</b> 035

# 2M Pedestrian Protection V54x/L541/V526/V426 N\_HEV

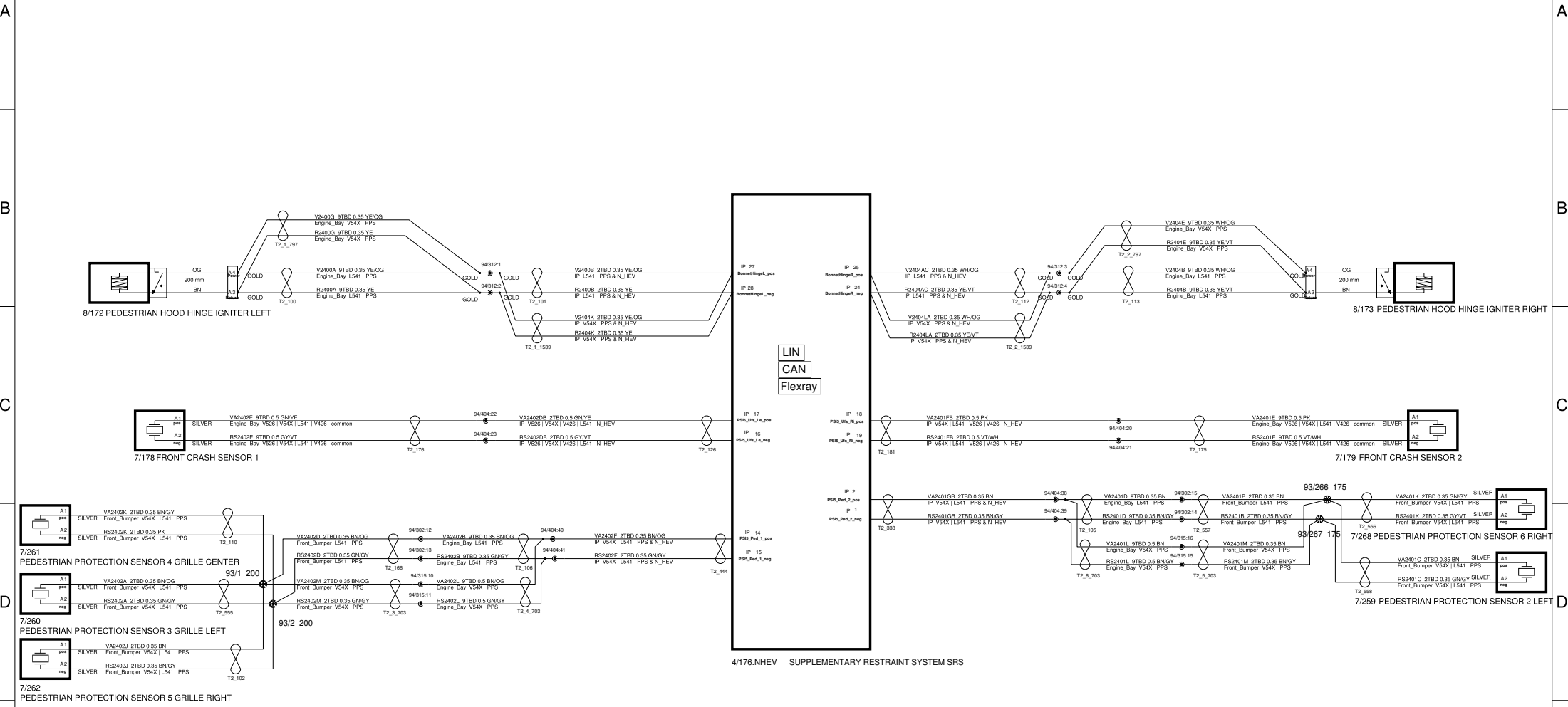

<p>The copying, distribution and utilization of this document as well as the communication of its contents to others without expressed authorization is prohibited. Offenders will be held liable for payment of damages. All rights reserved in the event of the grant of a patent, utility model or ornamental design registration.</p>		<p>Document title SPA_Issue25_Release1 2M_Pedestrian_Protection_CL90_V426_N_HEV</p>	
		<p>Document Type DRAW/ELSY</p>	<p>Issued January/13/2022</p>
<p><b>VOLVO</b> VOLVO CAR CORPORATION</p>		<p>Release Status RELEASED</p>	
		<p>Document No 33409142</p>	<p>Issue 035 Page No 70/177</p>

# 2M Pedestrian Protection V54x/L541/V526/519G/P514/V426 PHEV

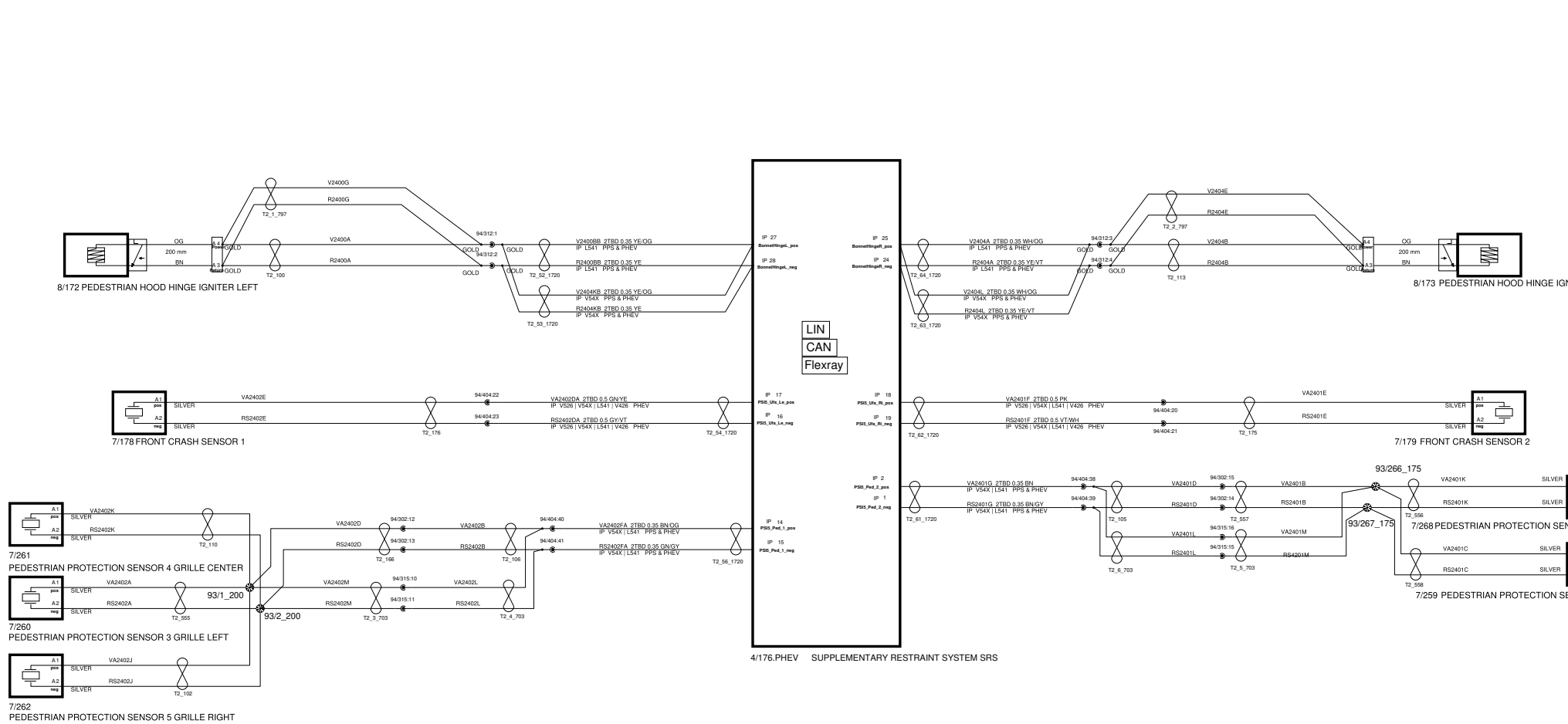

<p>The copying, distribution and utilization of this document as well as the communication of its contents to others without expressed authorization is prohibited. Offenders will be held liable for payment of damages. All rights reserved in the event of the grant of a patent, utility model or ornamental design registration.</p> <p><b>VOLVO</b> VOLVO CAR CORPORATION</p>	<b>Document title</b> SPA_Issue25_Release1 2M_Pedestrian_Protection_CL90_V426_PHEV	
	<b>Document Type</b> DRAW/ELSY	<b>Edited</b> March/21/2023
	<b>Release Status</b> RELEASED	
	<b>Document No</b> 33409142	<b>Issue</b> 035





# 2M Pedestrian Protection V43X N\_HEV

A  
B  
C  
D  
E  
F

A  
B  
C  
D  
E  
F

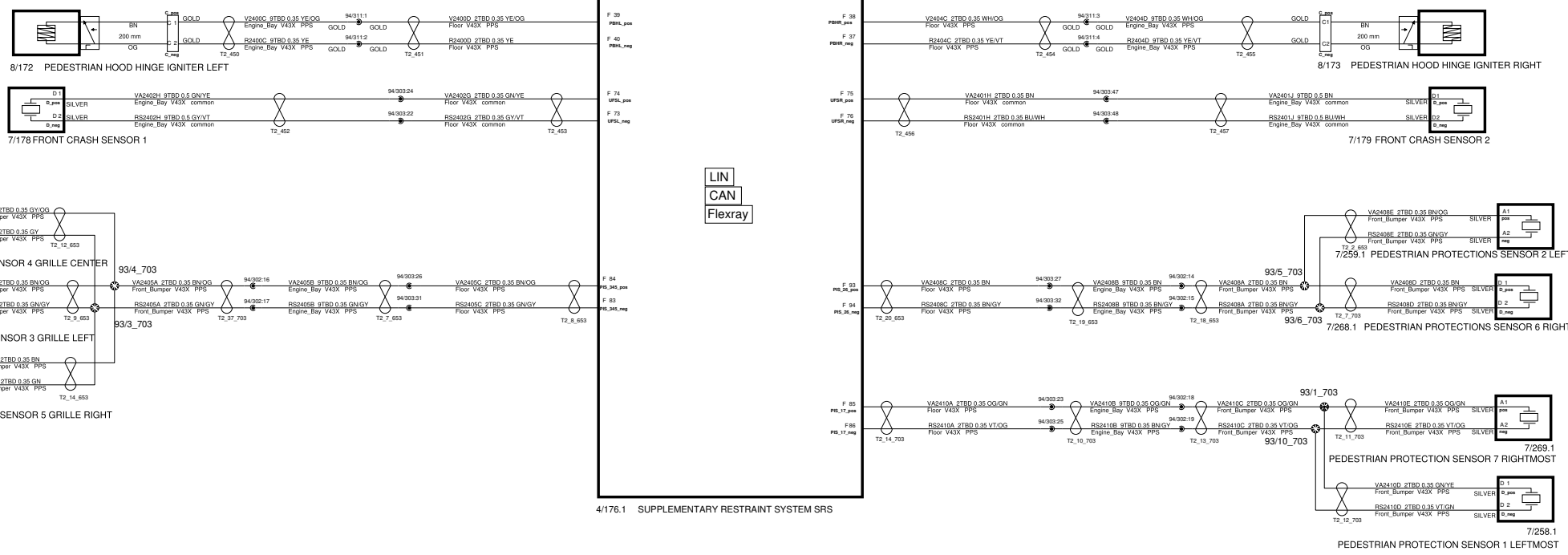

The copying, distribution and utilization of this document as well as the communication of its contents to others without expressed authorization is prohibited. Offenders will be held liable for payment of damages. All rights reserved in the event of the grant of a patent, utility model or ornamental design registration.			
<b>Document title</b>		SPA_Issue25_Release1 2M_Pedestrian_Protection_V43X_N_HEV	
<b>Document Type</b>		<b>Edited</b>	
DRAW/ELSY		February/06/2022	
<b>Release Status</b>			
RELEASED			
<b>Document No</b>		<b>Issue</b>	<b>Page No</b>
33409142		035	72/177



# 2N Safety Belt Reminder V526/V54X/L541/V426 N\_HEV

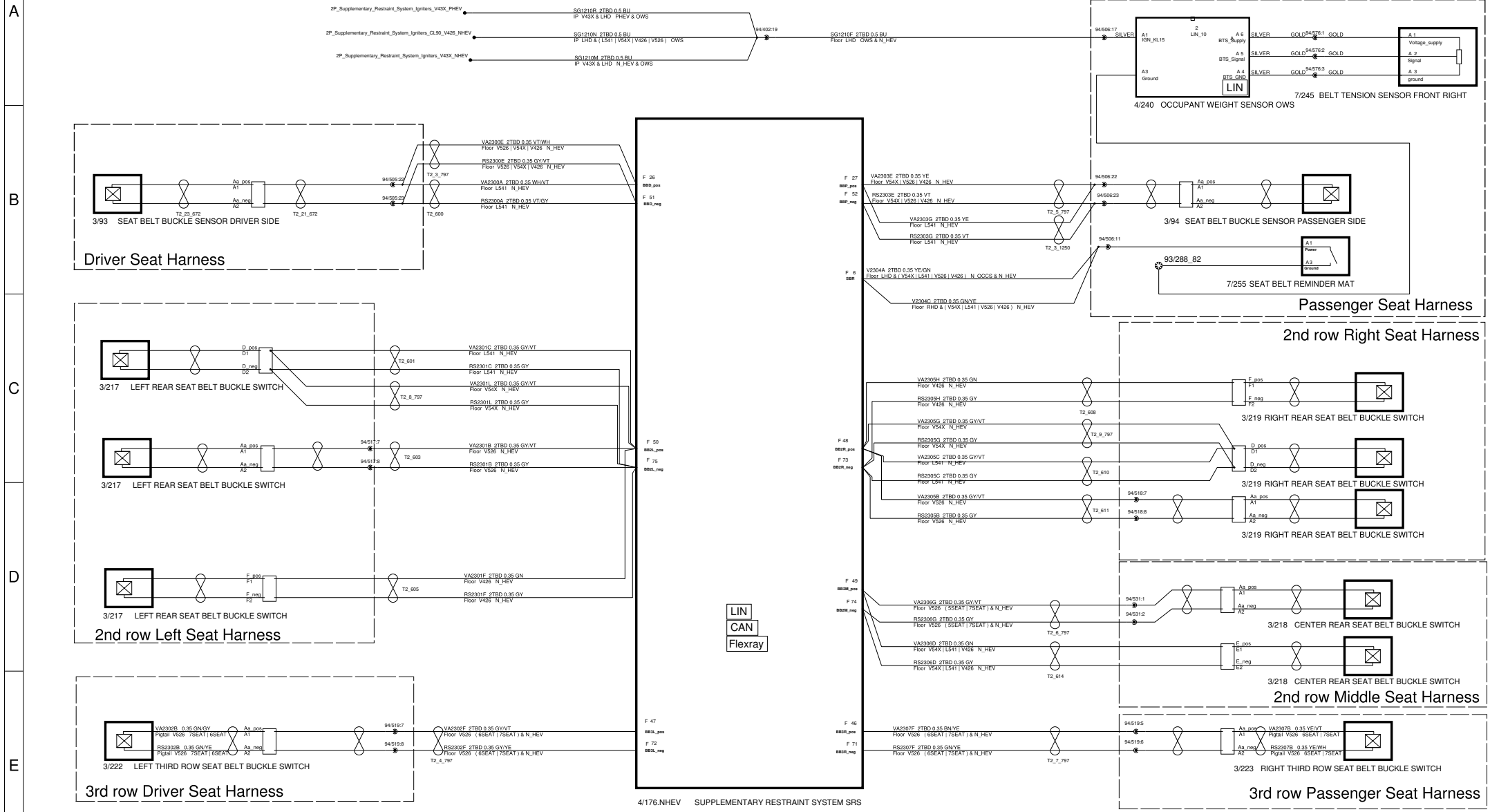

<p>The copying, distribution and utilization of this document as well as the communication of its contents to others without expressed authorization is prohibited. Offenders will be held liable for payment of damages. All rights reserved in the event of the grant of a patent, utility model or ornamental design registration.</p>		<p>Document title 2N_Safety_Belt_Reminder_CL90_V426_N_HEV</p>		<p>SPA_Issue25_Release1</p>	
<p>Document Type DRAW/ELSY</p>		<p>Released Status RELEASED</p>		<p>Edited January/13/2022</p>	
<p>Document No 33409142</p>		<p>Issue 035</p>	<p>Page No 73/177</p>		



# 2N Safety Belt Reminder V526/519G/V54X/L541/P514/V426 PHEV

2P\_Supplementary\_Restraint\_System\_Igniters\_CL90\_NHEV

SG1210N

SG1210FF  
 94462:19  
 94462:19  
 SG1210P\_2TRD 0.5 BU  
 Floor LHD\_OWS & PHEV

4/240 OCCUPANT WEIGHT SENSOR OWS

7/245 BELT TENSION SENSOR FRONT RIGHT

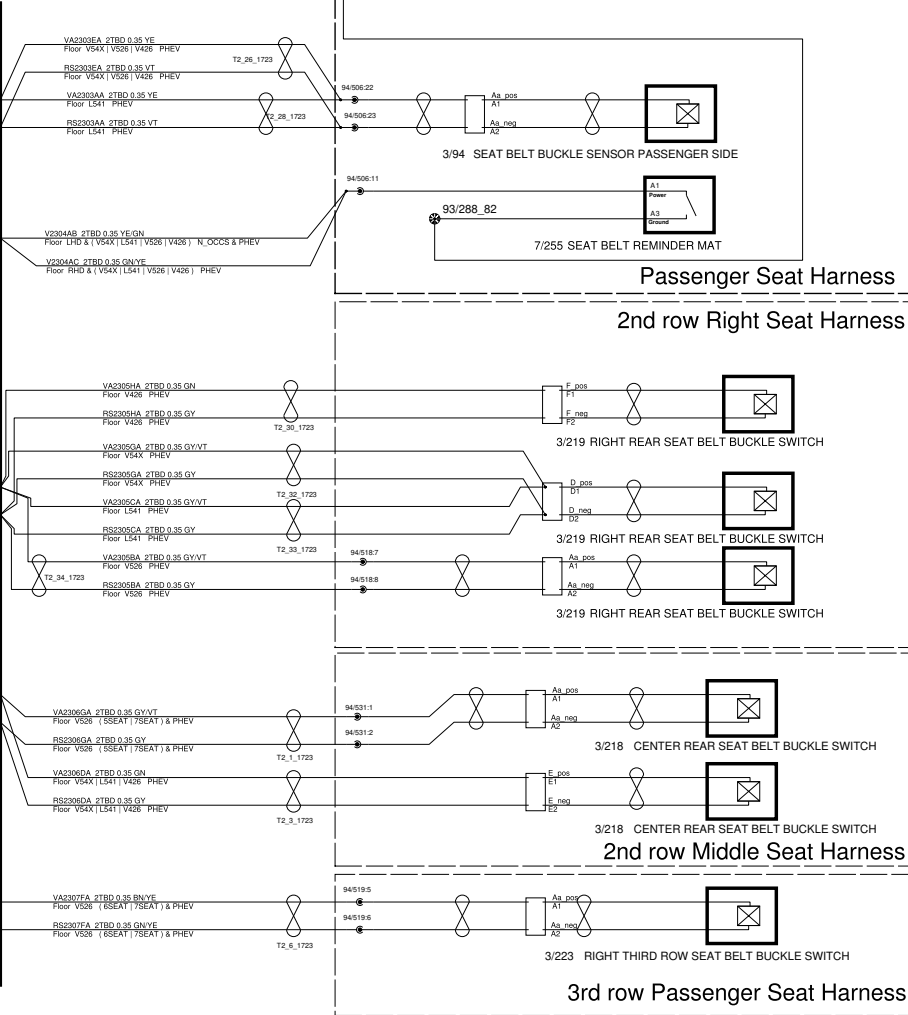
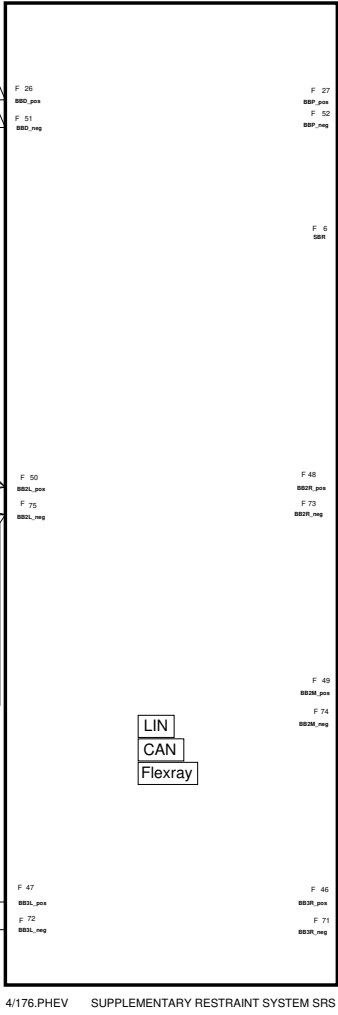
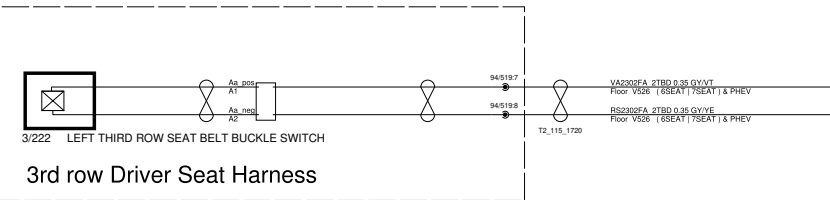
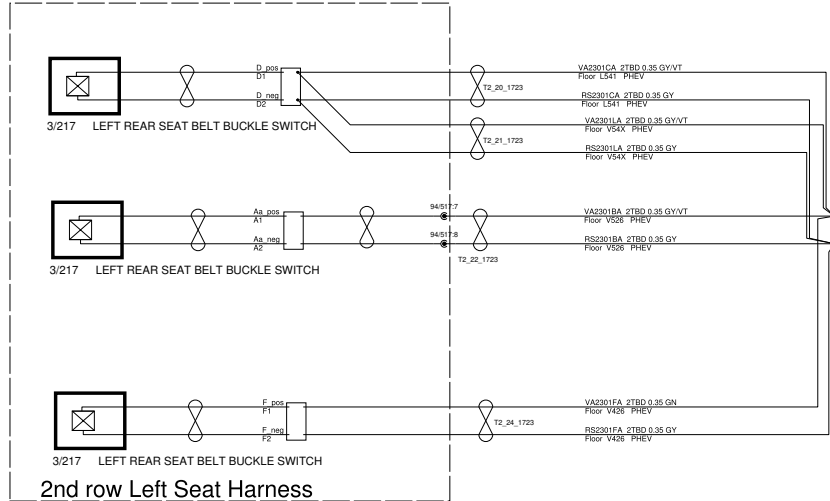
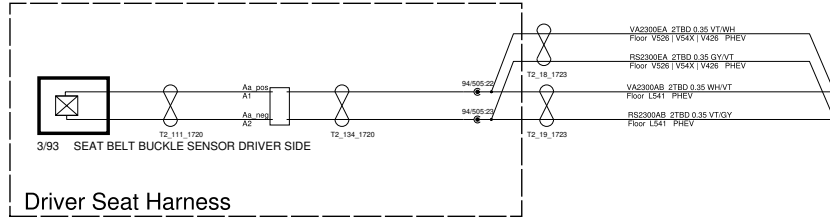

The copying, distribution and utilization of this document as well as the communication of its contents to others without expressed authorization is prohibited. Offenders will be held liable for payment of damages. All rights reserved in the event of the grant of a patent, utility model or ornamental design registration.

**VOLVO**  
 VOLVO CAR CORPORATION

**Document title** SPA\_issue25\_Release1  
 2N\_Safety\_Belt\_Reminder\_CL90\_V426\_PHEV

**Document Type** DRAW/ELSY  
**Release Status** RELEASED

**Document No** 33409142  
**Issue** 035  
**Page No** 74/177

**Edited** January/13/2022

# 2N Safety Belt Reminder V43X N\_HEV

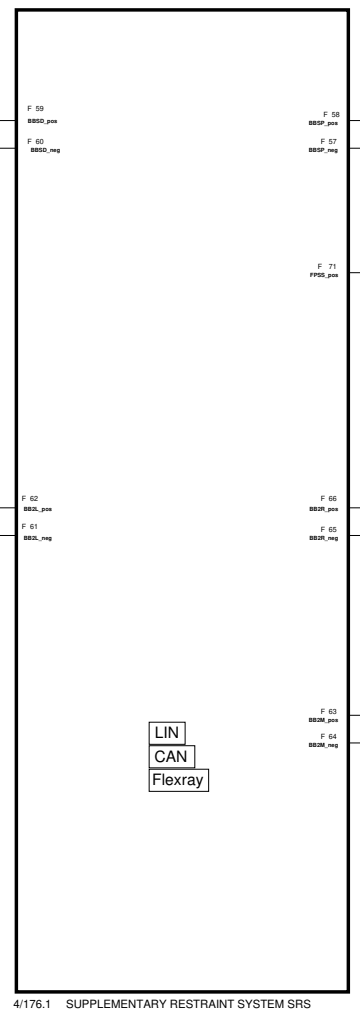
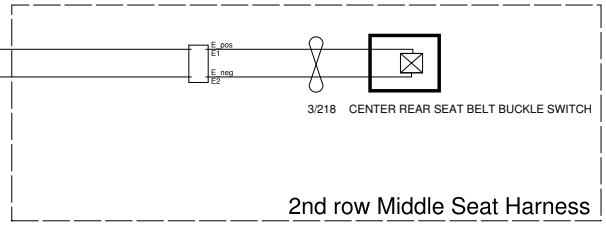
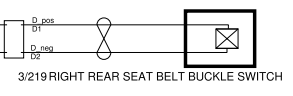
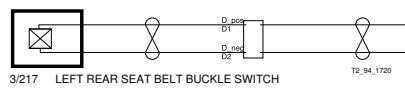
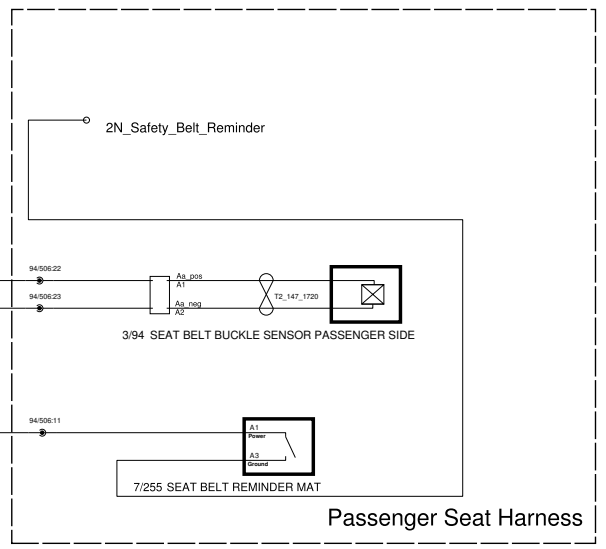
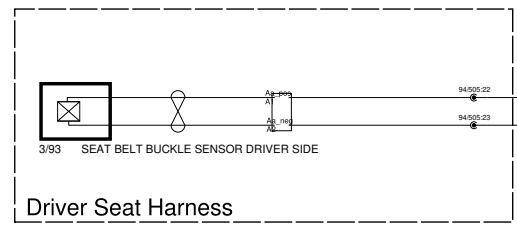

LIN  
CAN  
Flexray

<p>The copying, distribution and utilization of this document as well as the communication of its contents to others without expressed authorization is prohibited. Offenders will be held liable for payment of damages. All rights reserved in the event of the grant of a patent, utility model or ornamental design registration.</p> <p><b>VOLVO</b> VOLVO CAR CORPORATION</p>	<p><b>Document title</b> SPA_Issue25_Release1 2N_Safety_Belt_Reminder_V43X_N_HEV</p>	
	<p><b>Document Type</b> DRAW/ELSY</p>	<p><b>Edited</b> June/16/2021</p>
	<p><b>Release Status</b> RELEASED</p>	
	<p><b>Document No</b> 33409142</p>	<p><b>Issue</b> 035</p>

# 20 Collision Avoidance

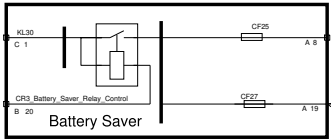

15/50 CENTRAL JUNCTION BOX

S1102C 2TBD 0.35 BN/BN  
IP V528 | V54X | L541 | GHUD | GHUD\_3  
S1102A 2TBD 0.5 HO/BN  
IP L541 | GHUD | GHUD\_3  
S1420B 2TBD 0.5 HO/BN  
IP V428 | V43X | GHUD | GHUD\_3

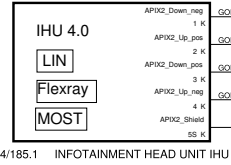

4/185.1 INFOTAINMENT HEAD UNIT IHU

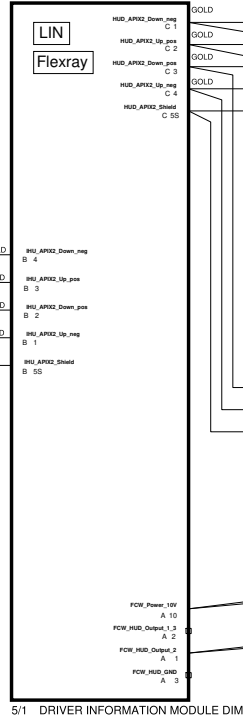

5/1 DRIVER INFORMATION MODULE DIM

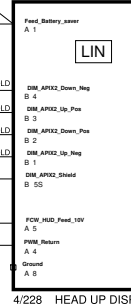

4/228 HEAD UP DISPLAY HUD

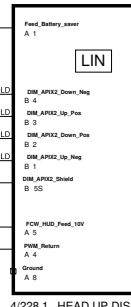

4/228.1 HEAD UP DISPLAY HUD

<p>The copying, distribution and utilization of this document as well as the communication of its contents to others without expressed authorization is prohibited. Offenders will be held liable for payment of damages. All rights reserved in the event of the grant of a patent, utility model or ornamental design registration.</p> <p><b>VOLVO</b> VOLVO CAR CORPORATION</p>	<p><b>Document title</b> SPA_Issue25_Release1 20_Collision_Avoidance</p>	
	<p><b>Document Type</b> DRAW/ELSY</p>	<p><b>Edited</b> December/15/2021</p>
<p><b>Release Status</b> RELEASED</p>		
<p><b>Document No</b> 33409142</p>	<p><b>Issue</b> 035</p>	<p><b>Page No</b> 76/177</p>

# 20 Collision Avoidance 521

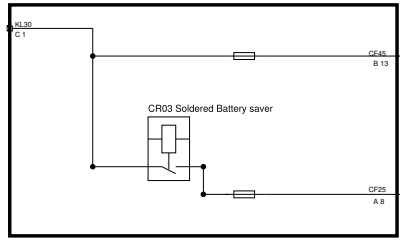

15/50 CENTRAL JUNCTION BOX

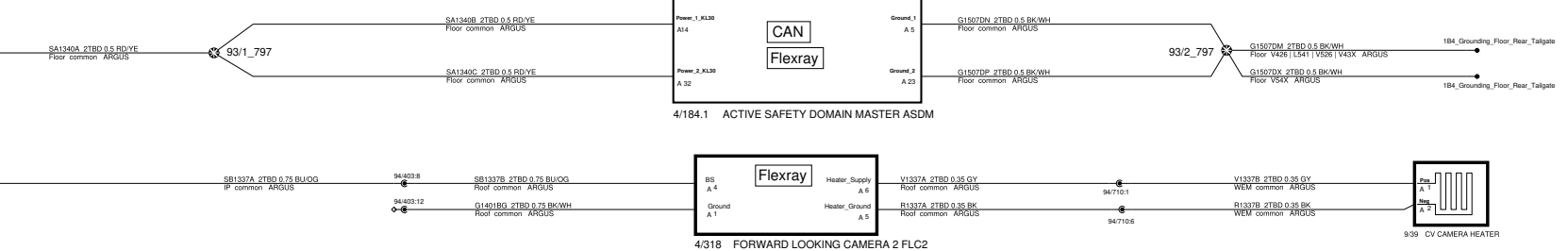

4/184.1 ACTIVE SAFETY DOMAIN MASTER ASDM

4/318 FORWARD LOOKING CAMERA 2 FLC2

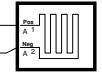

9/39 CV CAMERA HEATER

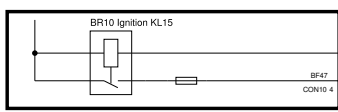

15/49 ENGINE JUNCTION BOX

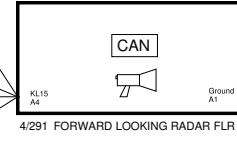
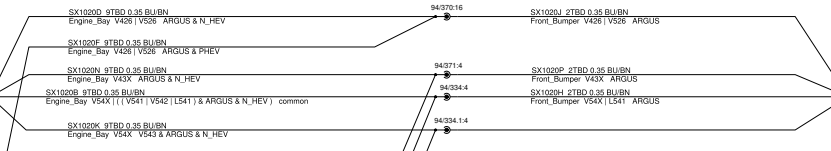

4/291 FORWARD LOOKING RADAR FLR

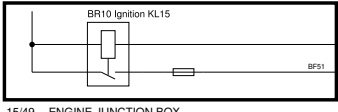

15/49 ENGINE JUNCTION BOX

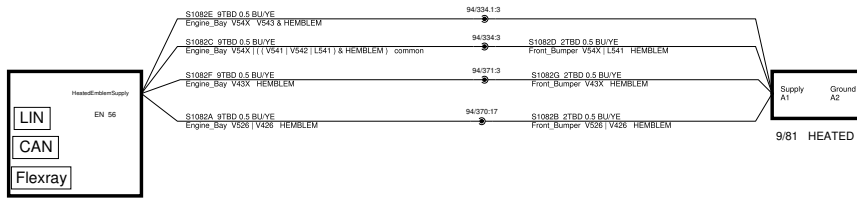
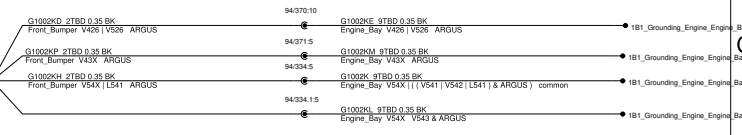

4/56 CENTRAL ELECTRONIC MODULE CEM



9/81 HEATED RADAR COVER



<p>The copying, distribution and utilization of this document as well as the communication of its contents to others without expressed authorization is prohibited. Offenders will be held liable for payment of damages. All rights reserved in the event of the grant of a patent, utility model or ornamental design registration.</p> <p><b>VOLVO</b> VOLVO CAR CORPORATION</p>	<p><b>Document title</b> SPA_Issue25_Release1 20_Collision_Avoidance_ARGUS</p>	
	<p><b>Document Type</b> DRAW/ELSY</p>	<p><b>Edited</b> April/06/2023</p>
	<p><b>Release Status</b> RELEASED</p>	
	<p><b>Document No</b> 33409142</p>	<p><b>Issue</b> 035</p>



# 2P Supplementary Restraint System Igniters V526/V54x/V426/L541 PHEV

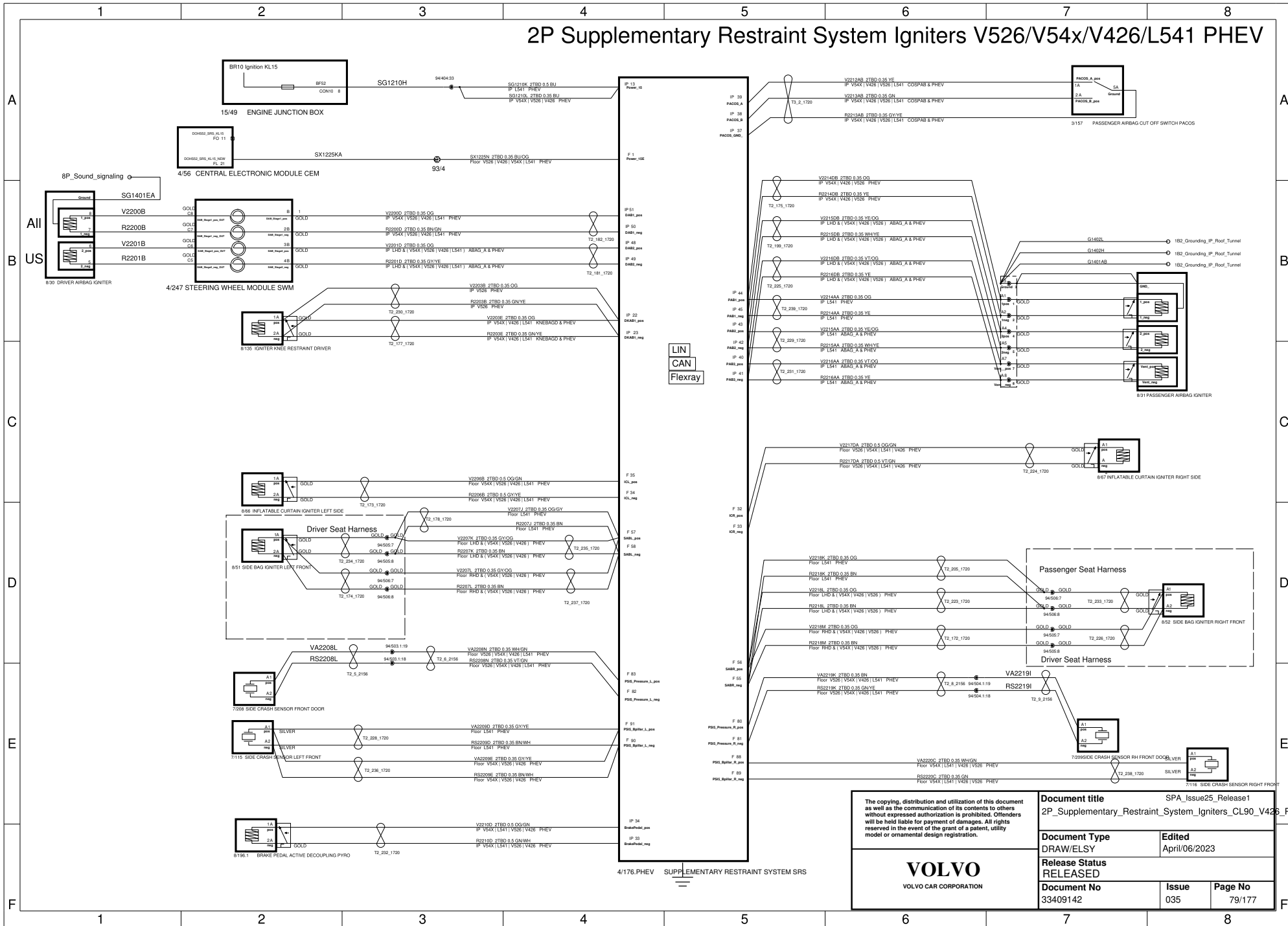

The copying, distribution and utilization of this document as well as the communication of its contents to others without expressed authorization is prohibited. Offenders will be held liable for payment of damages. All rights reserved in the event of the grant of a patent, utility model or ornamental design registration.

Document title		SPA_Issue25_Release1	
2P_Supplementary_Restraint_System_Igniters_CL90_V426_PHEV		Document Type	Edited
DRAW/ELSY		April/06/2023	
Release Status			
RELEASED			
Document No	Issue	Page No	
33409142	035	79/177	

**VOLVO**  
VOLVO CAR CORPORATION







# 2P Supplementary Restraint System Igniters V43x PHEV

A  
B  
C  
D  
E  
F

A  
B  
C  
D  
E  
F

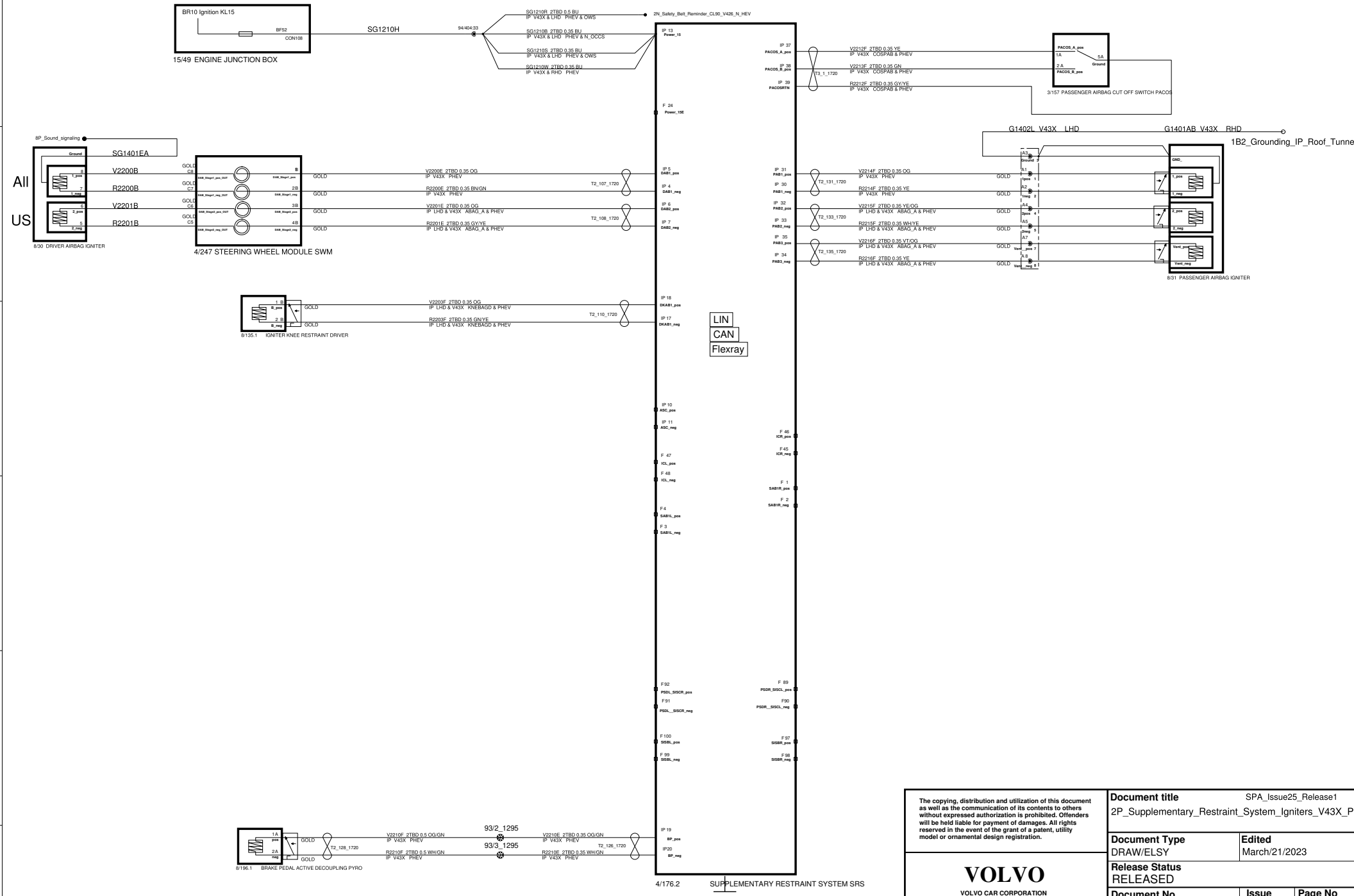

 VOLVO CAR CORPORATION	The copying, distribution and utilization of this document as well as the communication of its contents to others without expressed authorization is prohibited. Offenders will be held liable for payment of damages. All rights reserved in the event of the grant of a patent, utility model or ornamental design registration.		<b>Document title</b> SPA_Issue25_Release1 2P_Supplementary_Restraint_System_Igniters_V43x_PHEV	
	<b>Document Type</b> DRAW/ELSY	<b>Edited</b> March/21/2023		
	<b>Release Status</b> RELEASED		<b>Document No</b> 33409142	
	<b>Issue</b> 035	<b>Page No</b> 81/177		

# 2R Safety Belt CL90 V426 NHEV

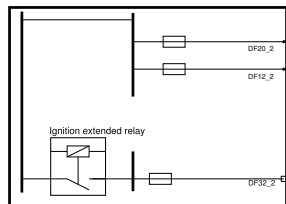

15/51 REAR JUNCTION BOX

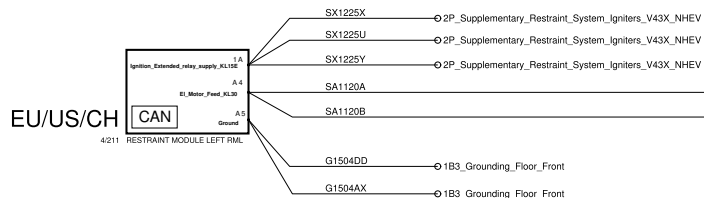

EU/US/CH CAN  
4211 RESTRAINT MODULE LEFT RML

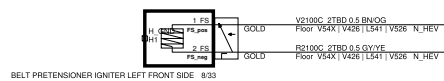

BELT PRETENSIONER IGNITER LEFT FRONT SIDE 8/33

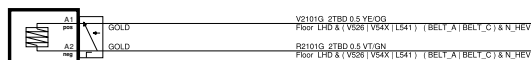

8/128 BELT FORCE REDUCER LH FRONT SIDE

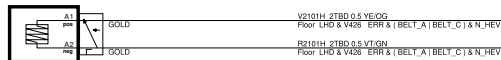

8/128 BELT FORCE REDUCER LH FRONT SIDE

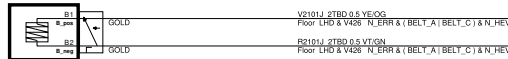

8/128 BELT FORCE REDUCER LH FRONT SIDE

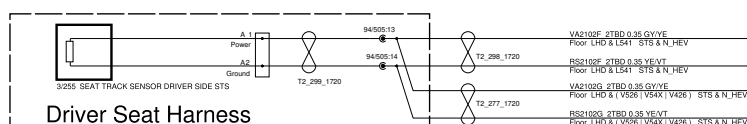

3/255 SEAT TRACK SENSOR DRIVER SIDE STS

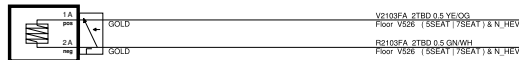

8/55.57SEAT BELT PRETENSIONER IGNITER LEFT REAR SIDE

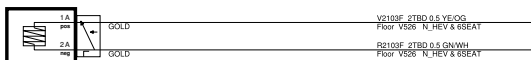

8/55.346SEAT BELT PRETENSIONER IGNITER LEFT REAR SIDE



8/55 BELT PRETENSIONER IGNITER LEFT REAR SIDE

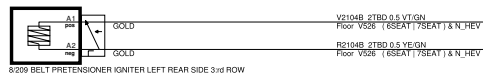

8/209 BELT PRETENSIONER IGNITER LEFT REAR SIDE 3rd ROW

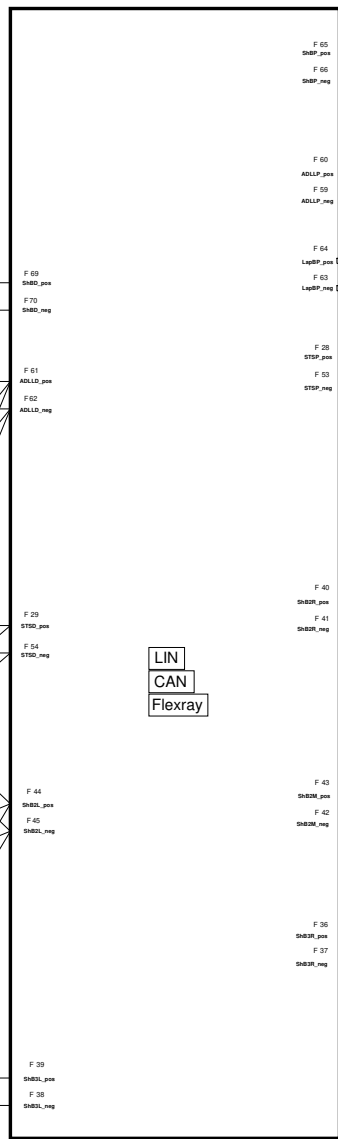

4/176.NHEV SUPPLEMENTARY RESTRAINT SYSTEM SRS

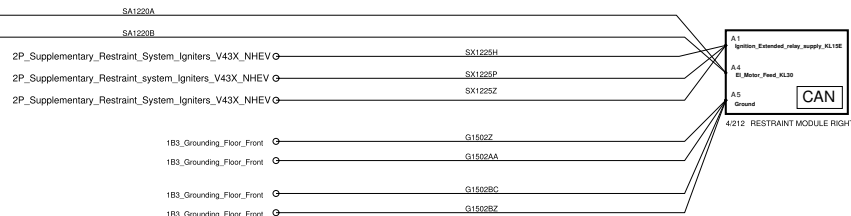

2P\_Supplementary\_Restraint\_System\_Igniters\_V43X\_NHEV  
2P\_Supplementary\_Restraint\_System\_Igniters\_V43X\_NHEV  
2P\_Supplementary\_Restraint\_System\_Igniters\_V43X\_NHEV

1B3\_Grounding\_Floor\_Front  
1B3\_Grounding\_Floor\_Front  
1B3\_Grounding\_Floor\_Front  
1B3\_Grounding\_Floor\_Front

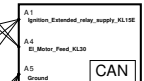

4212 RESTRAINT MODULE RIGHT RMR

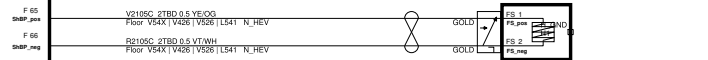

8/34 BELT TENSIONER IGNITER RIGHT FRONT SIDE

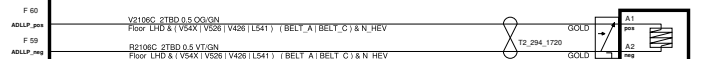

8/129 BELT FORCE REDUCER RH FRONT SIDE

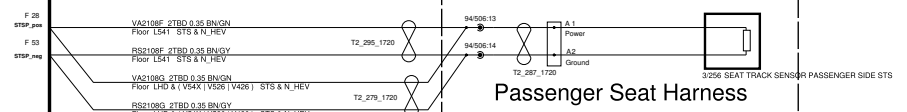

3/256 SEAT TRACK SENSOR PASSENGER SIDE STS

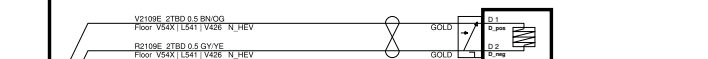

8/50 BELT PRETENSIONER IGNITER RIGHT REAR SIDE

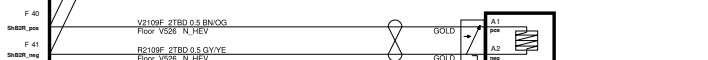

8/56 BELT PRETENSIONER IGNITER RIGHT REAR SIDE

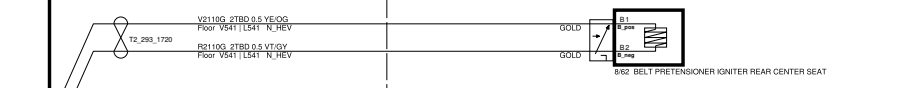

8/62 BELT PRETENSIONER IGNITER REAR CENTER SEAT

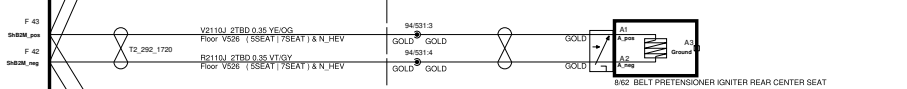

8/62 BELT PRETENSIONER IGNITER REAR CENTER SEAT

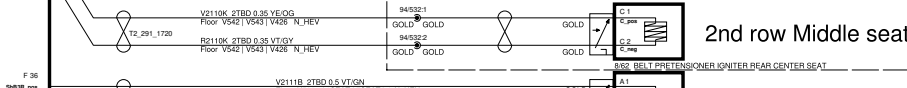

8/62 BELT PRETENSIONER IGNITER REAR CENTER SEAT



8/210 BELT PRETENSIONER IGNITER RIGHT REAR SIDE 3rd ROW

The copying, distribution and utilization of this document as well as the communication of its contents to others without expressed authorization is prohibited. Offenders will be held liable for payment of damages. All rights reserved in the event of the grant of a patent, utility model or ornamental design registration.		Document title 2R_Safety_Belt_CL90_V426_NHEV		SPA_Issue25_Release1	
Document Type DRAW/ELSY		Released Status RELEASED		Edited March/22/2023	
Document No 33409142		Issue 035		Page No 82/177	



# 2R Safety Belt CL90 V426 PHEV

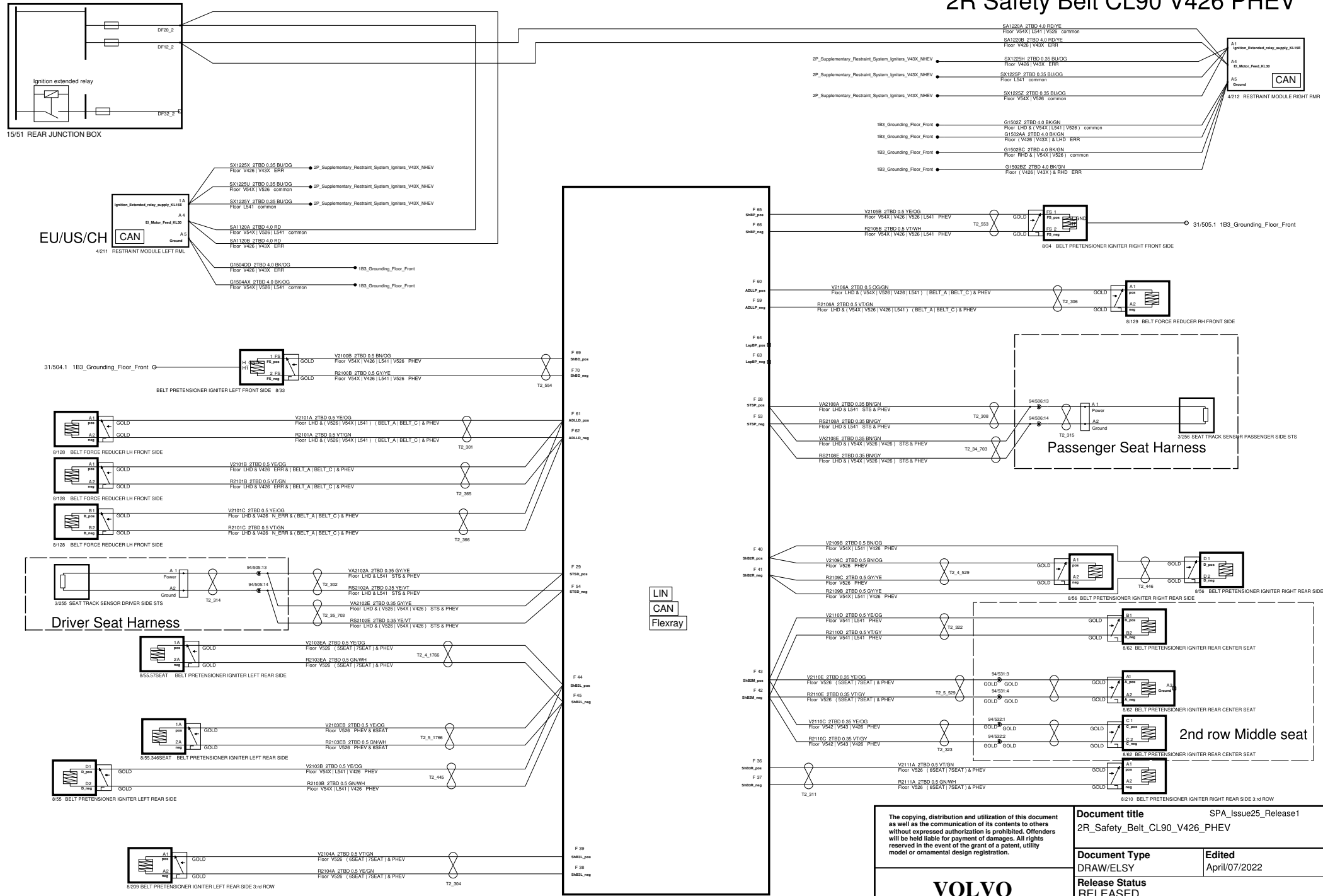

The copying, distribution and utilization of this document as well as the communication of its contents to others without expressed authorization is prohibited. Offenders will be held liable for payment of damages. All rights reserved in the event of the grant of a patent, utility model or ornamental design registration.		<b>Document title</b> SPA_Issue25_Release1	
2R_Safety_Belt_CL90_V426_PHEV		<b>Document Type</b> DRAW/ELSY	
<b>Release Status</b> RELEASED		<b>Edited</b> April/07/2022	
<b>Document No</b> 33409142	<b>Issue</b> 035	<b>Page No</b> 83/177	



4/176.PHEV SUPPLEMENTARY RESTRAINT SYSTEM SRS



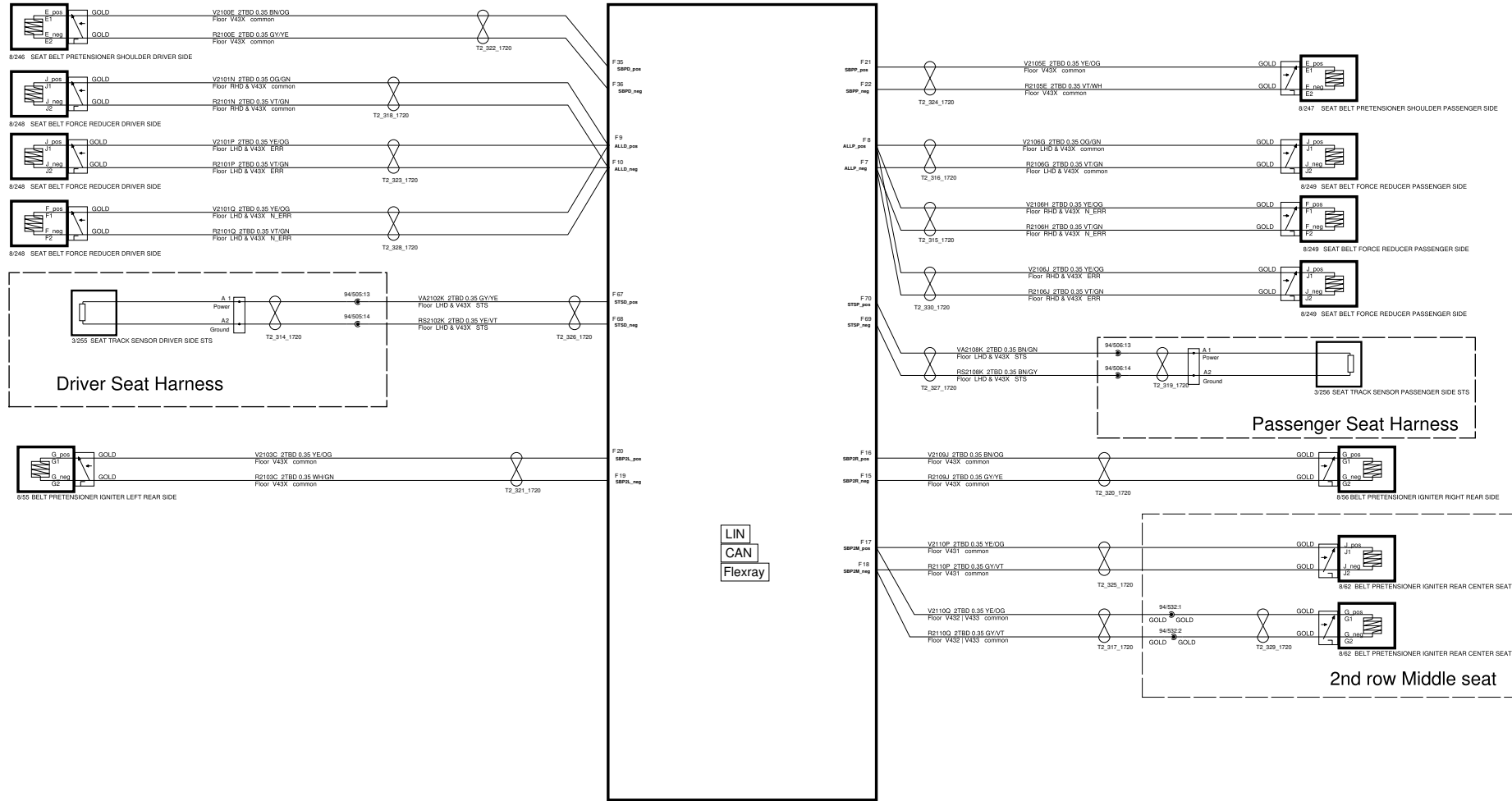

The copying, distribution and utilization of this document as well as the communication of its contents to others without expressed authorization is prohibited. Offenders will be held liable for payment of damages. All rights reserved in the event of the grant of a patent, utility model or ornamental design registration.		Document title 2R_Safety_Belt_V43x_NHEV		SPA_Issue25_Release1	
Document Type DRAW/ELSY		Edited September/24/2019			
Release Status RELEASED					
Document No 33409142		Issue 035		Page No 84/177	





# 3A, 3C Engine Management

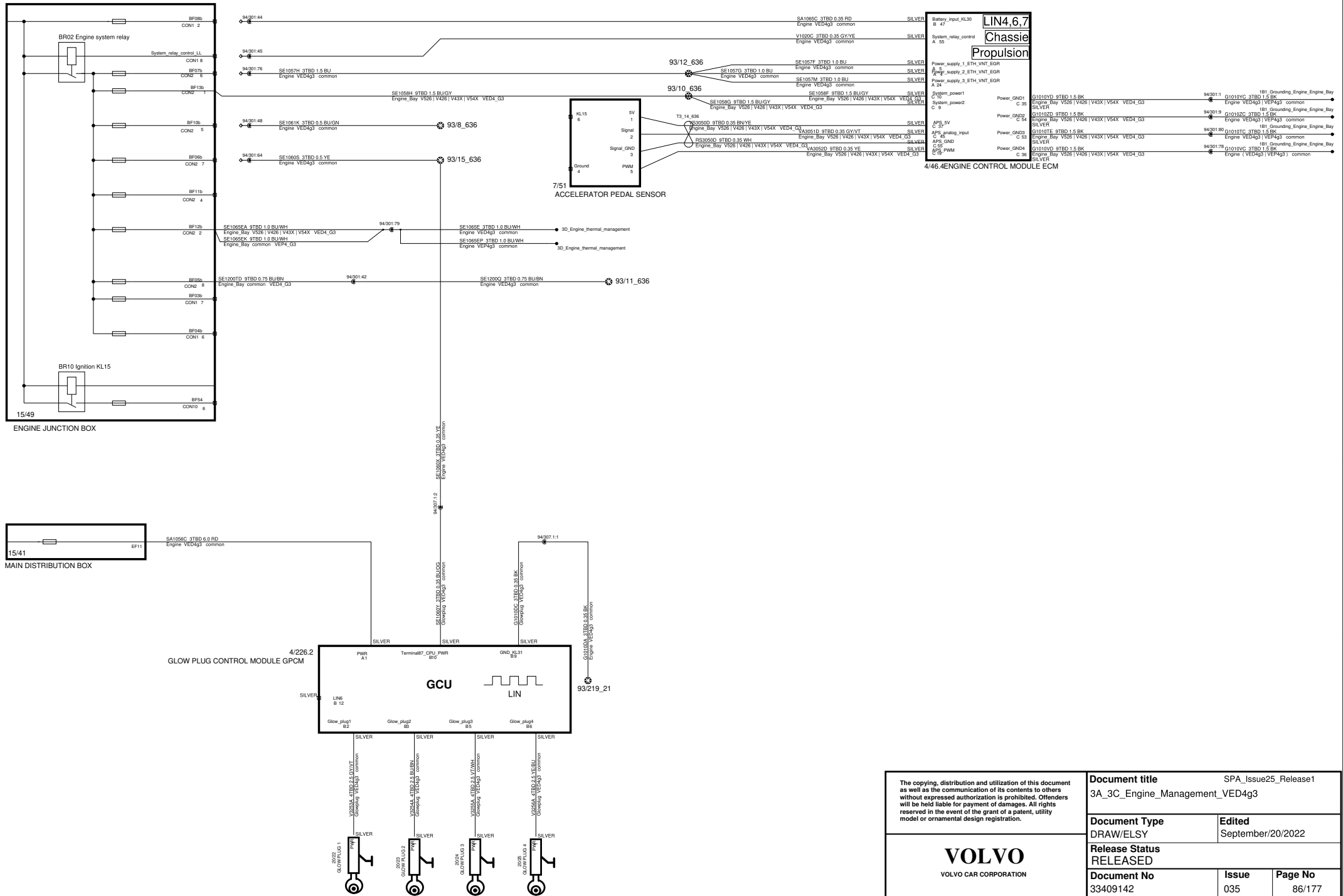

<p>The copying, distribution and utilization of this document as well as the communication of its contents to others without expressed authorization is prohibited. Offenders will be held liable for payment of damages. All rights reserved in the event of the grant of a patent, utility model or ornamental design registration.</p>		<p>Document title SPA_Issue25_Release1 3A_3C_Engine_Management_VED4g3</p>	
		<p>Document Type DRAW/ELSY</p>	<p>Edited September/20/2022</p>
<p><b>VOLVO</b> VOLVO CAR CORPORATION</p>		<p>Release Status RELEASED</p>	
		<p>Document No 33409142</p>	<p>Issue 035</p>
		<p>Page No 86/177</p>	

# 3A, 3C Engine Management

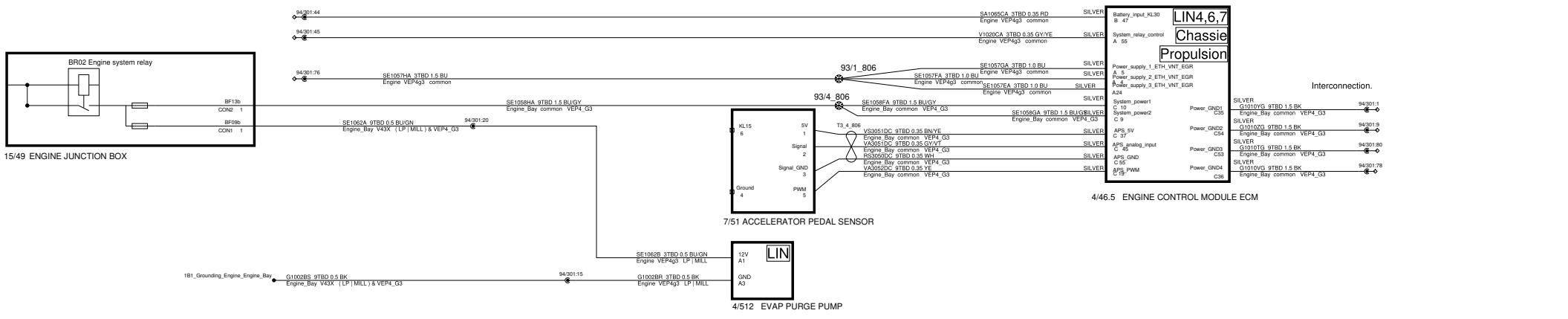

<p>The copying, distribution and utilization of this document as well as the communication of its contents to others without expressed authorization is prohibited. Offenders will be held liable for payment of damages. All rights reserved in the event of the grant of a patent, utility model or ornamental design registration.</p>		<p><b>Document title</b> SPA_Issue25_Release1 3A_3C_Engine_Management_VEP4g3</p>	
		<p><b>Document Type</b> DRAW/ELSY</p>	<p><b>Edited</b> April/06/2023</p>
<p><b>VOLVO</b> VOLVO CAR CORPORATION</p>		<p><b>Release Status</b> RELEASED</p>	
		<p><b>Document No</b> 33409142</p>	<p><b>Issue</b> 035</p>
		<p><b>Page No</b> 87/177</p>	



# 3A Engine Management VEP4g2

4/46.2 ENGINE CONTROL MODULE ECM

Propulsion  
Chassie  
LIN4,6,7

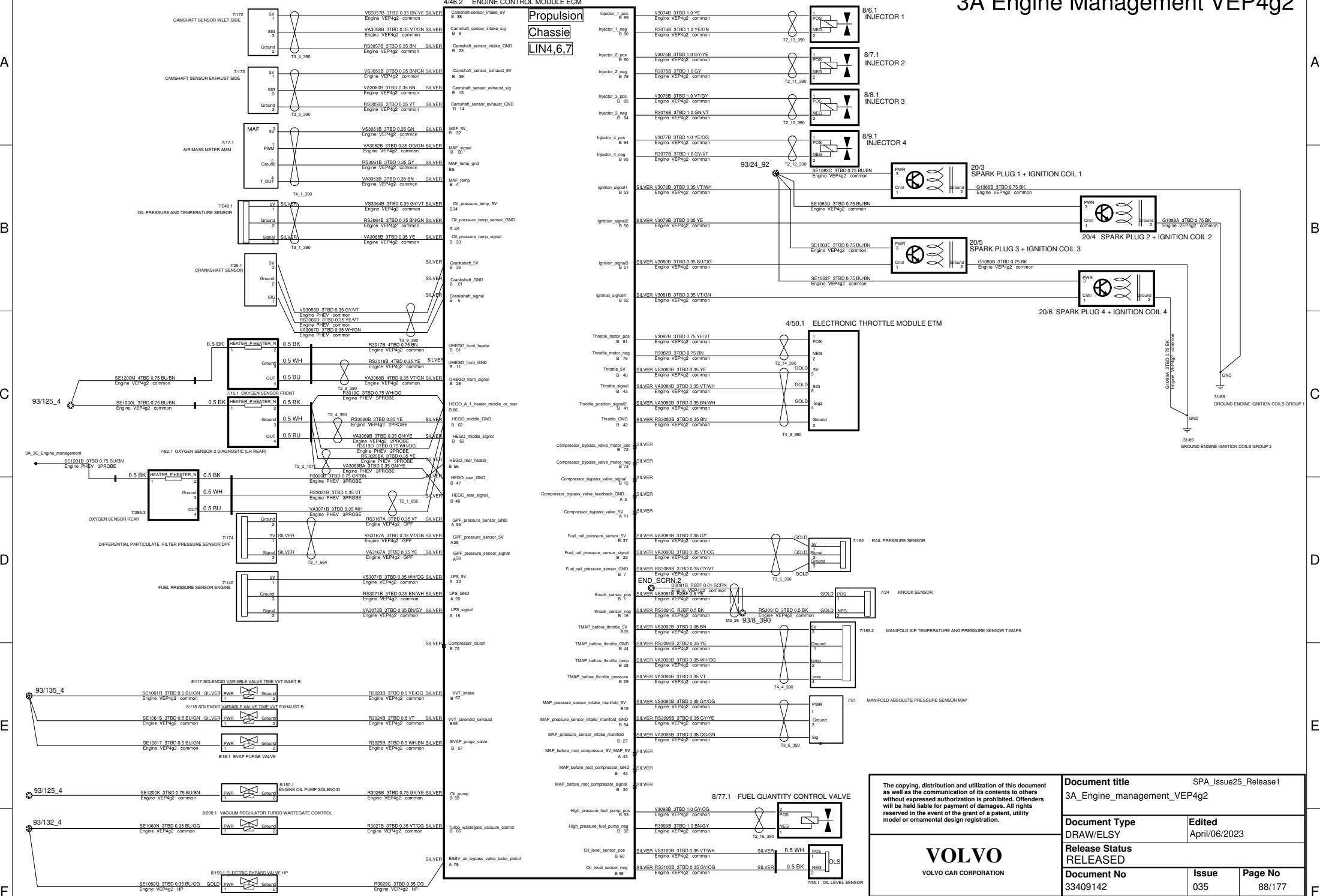

The copying, distribution and utilization of this document as well as the communication of its contents to others without expressed authorization is prohibited. Offenders will be held liable for payment of damages. All rights reserved in the event of the grant of a patent, utility model or ornamental design registration.

**VOLVO**  
VOLVO CAR CORPORATION

Document title		SPA_Issue25_Release1	
3A_Engine_management_VEP4g2			
Document Type	Draw/ELSY	Edited	April/06/2023
Release Status		RELEASED	
Document No	33409142	Issue	035
		Page No	88/177

# 3A Engine Management VEP4g3

## 4/46.5 ENGINE CONTROL MODULE ECM

Propulsion  
Chassie  
LIN4,6,7

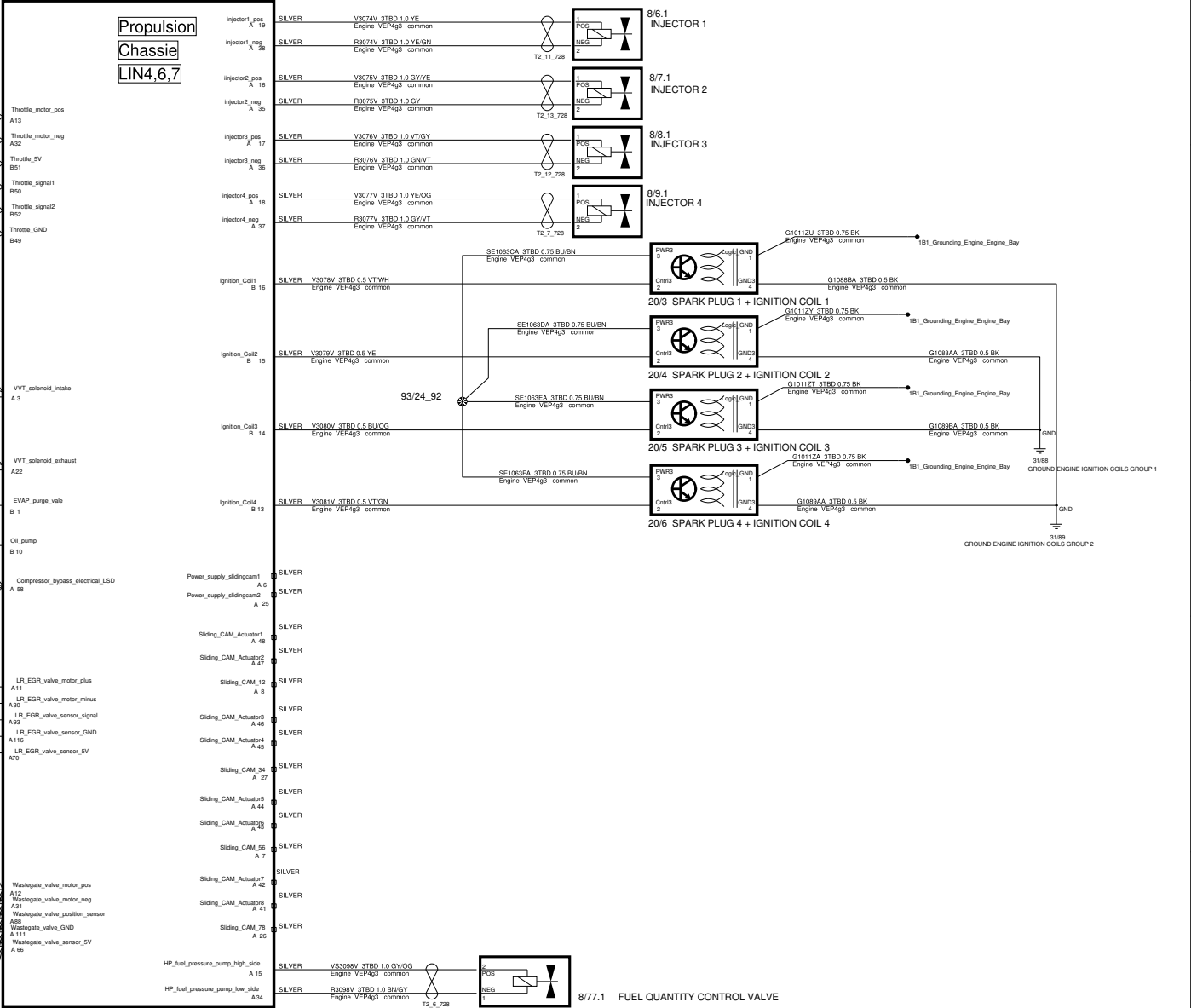
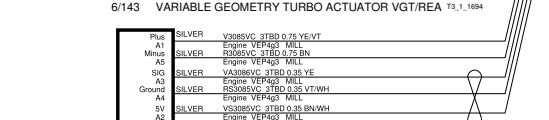
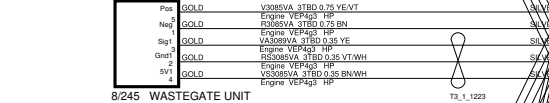
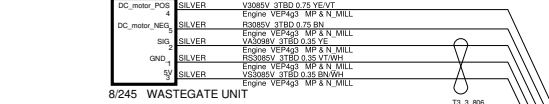
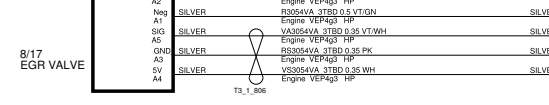
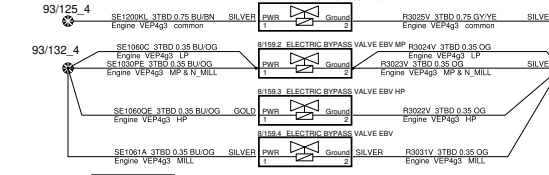
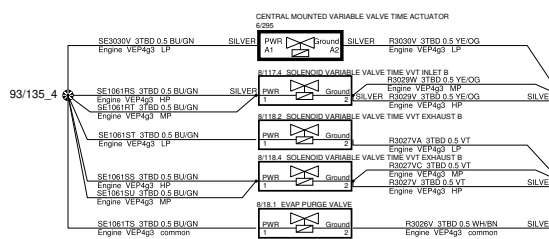
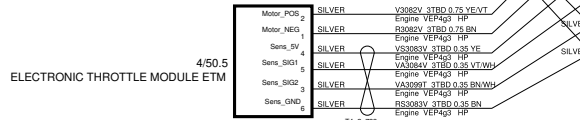
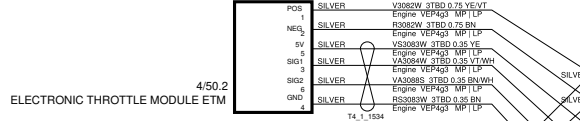

The copying, distribution and utilization of this document as well as the communication of its contents to others without expressed authorization is prohibited. Offenders will be held liable for payment of damages. All rights reserved in the event of the grant of a patent, utility model or ornamental design registration.		SPA_Issue25_Release1	
Document title		3A_Engine_Management_VEP4g3	
Document Type	DRAW/ELSY	Edited	April/06/2023
Release Status	RELEASED		
Document No	33409142	Issue	035
		Page No	89/177



# 3A\_Engine\_Management\_VEP4g3\_sensor

## 4/46.5 ENGINE CONTROL MODULE ECM

Propulsion  
Chassis  
LIN4.6.7

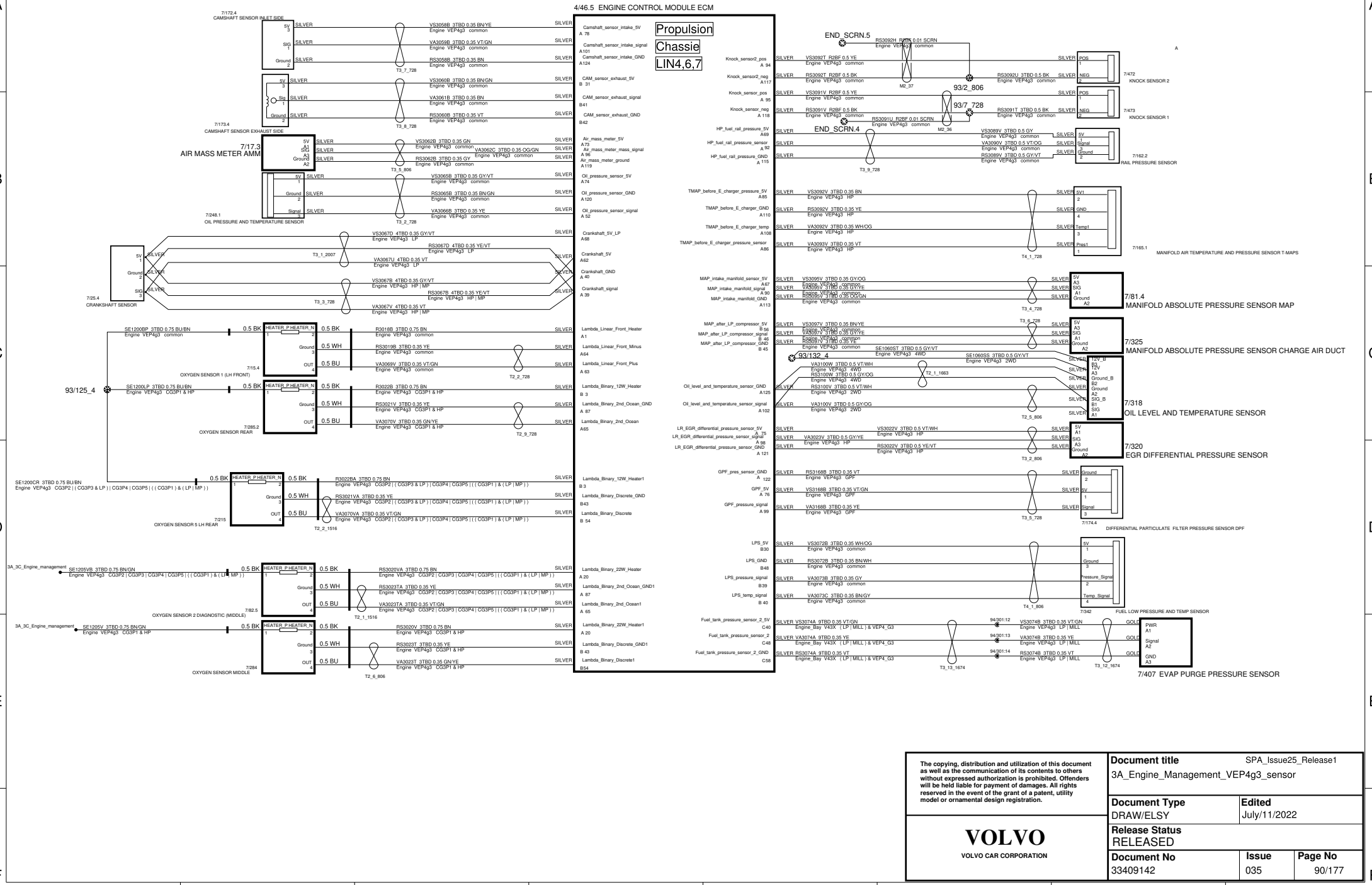

The copying, distribution and utilization of this document as well as the communication of its contents to others without expressed authorization is prohibited. Offenders will be held liable for payment of damages. All rights reserved in the event of the grant of a patent, utility model or ornamental design registration.		Document title SPA_Issue25_Release1	
Document Type DRAW/ELSY		Edited July/11/2022	
Release Status RELEASED			
Document No 33409142	Issue 035	Page No 90/177	



# 3B Management Hybrid Driveline

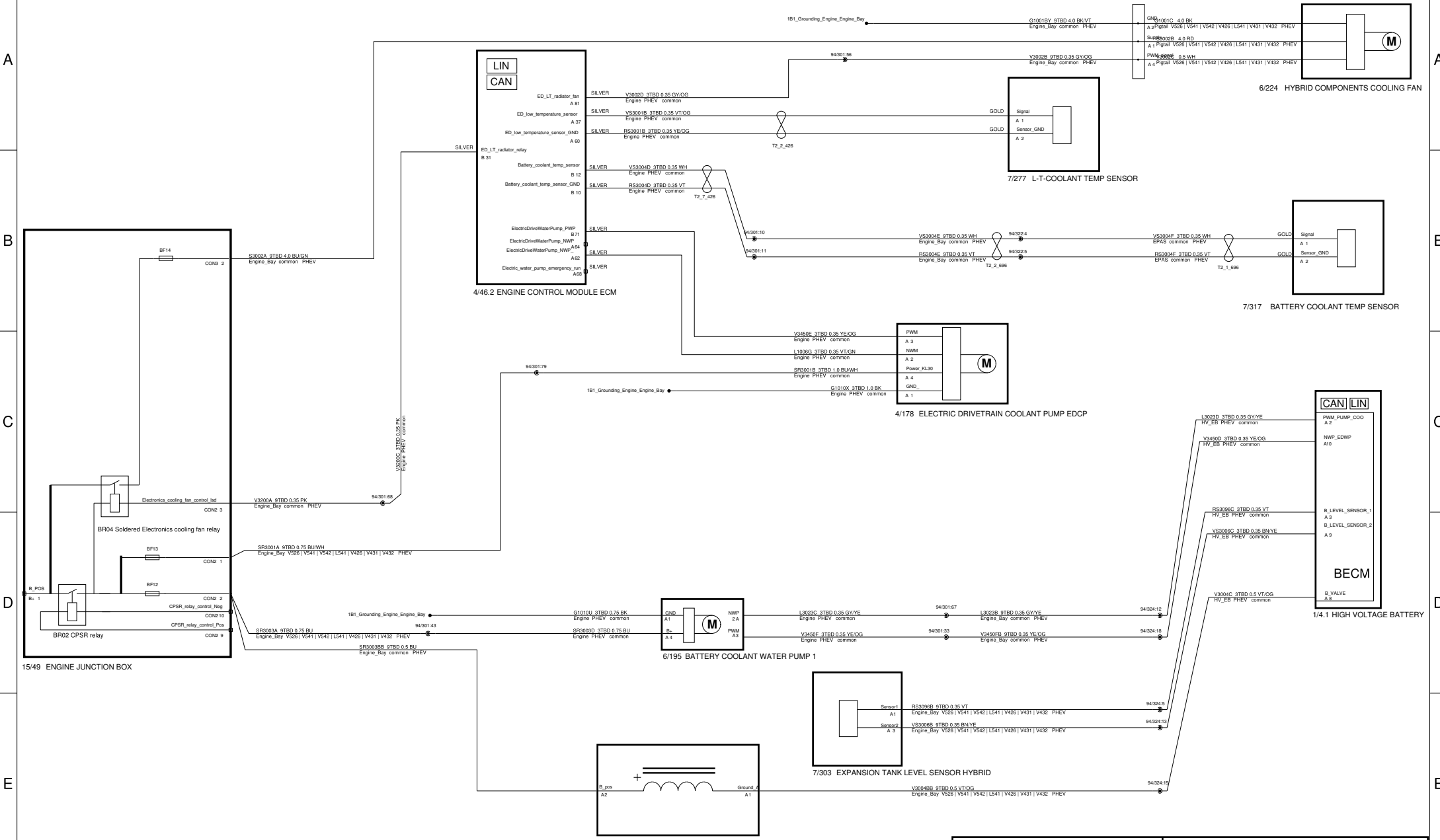

The copying, distribution and utilization of this document as well as the communication of its contents to others without expressed authorization is prohibited. Offenders will be held liable for payment of damages. All rights reserved in the event of the grant of a patent, utility model or ornamental design registration.		<b>Document title</b> SPA_Issue25_Release1 3B_Management_Hybrid_Driveline	
<b>Document Type</b> DRAW/ELSY		<b>Edited</b> July/13/2022	
<b>Release Status</b> RELEASED			
<b>Document No</b> 33409142	<b>Issue</b> 035	<b>Page No</b> 91/177	



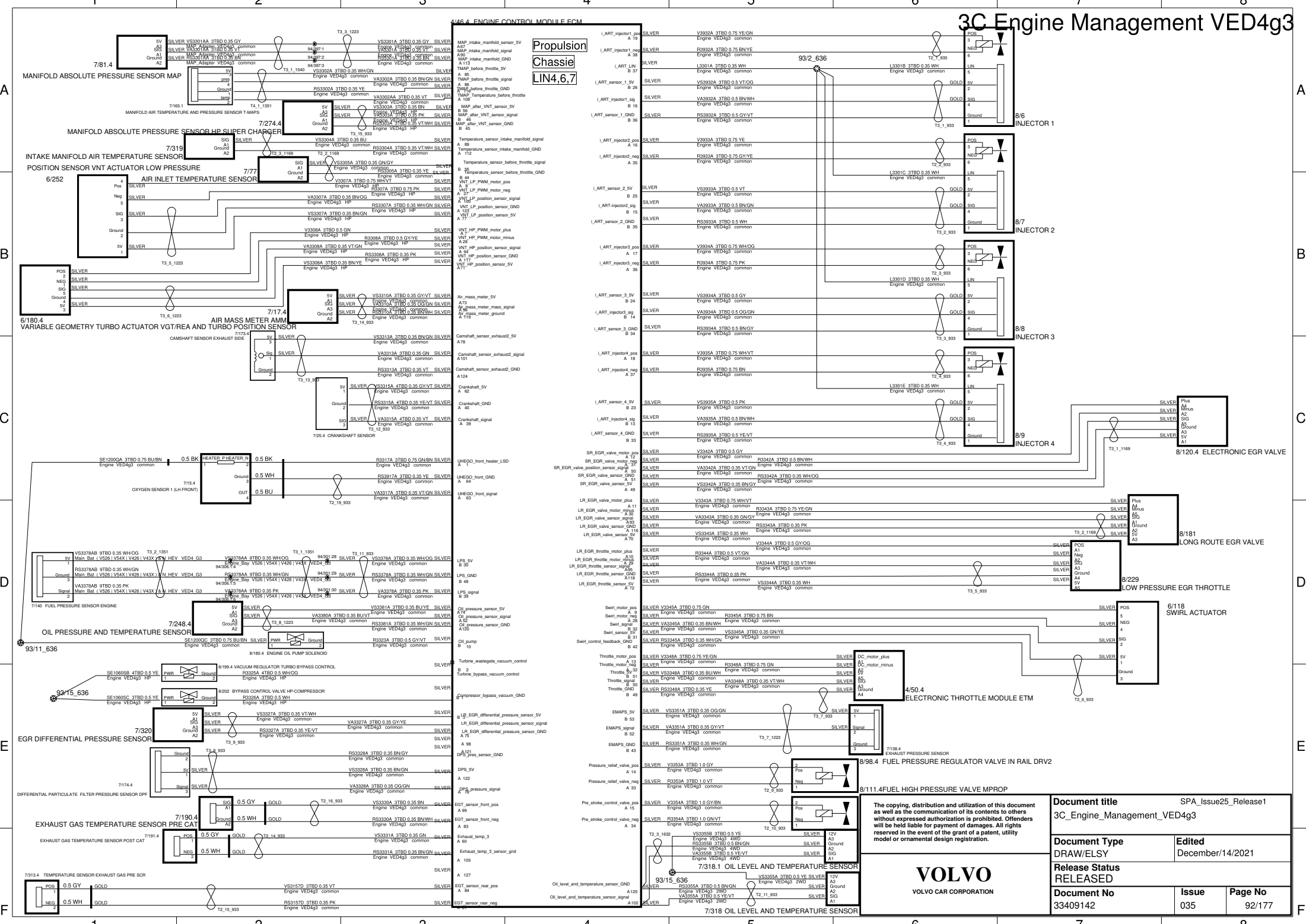

Propulsion  
Chassis  
LIN4.67

The copying, distribution and utilization of this document as well as the communication of its contents to others without expressed authorization is prohibited. Offenders will be held liable for payment of damages. All rights reserved in the event of the grant of a patent, utility model or ornamental design registration.

Document title		SPA_Issue25_Release1	
3C_Engine_Management_VED4g3			
Document Type	Draw/ELSY	Edited	December/14/2021
Release Status	RELEASED		
Document No	33409142	Issue	035
		Page No	92/177



VOLVO CAR CORPORATION

# 3D Engine Thermal Management

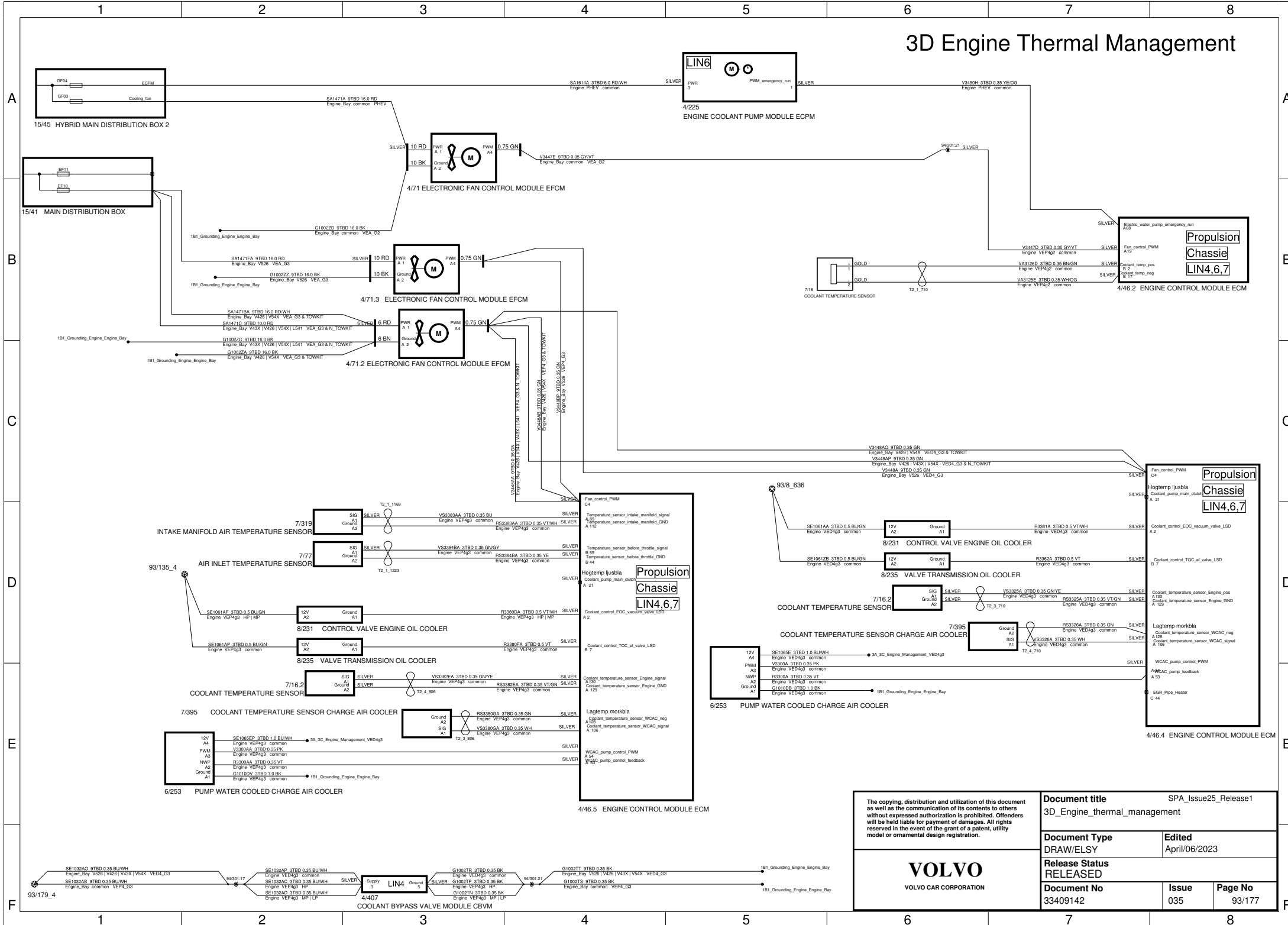

<p>The copying, distribution and utilization of this document as well as the communication of its contents to others without expressed authorization is prohibited. Offenders will be held liable for payment of damages. All rights reserved in the event of the grant of a patent, utility model or ornamental design registration.</p>		<p><b>Document title</b> SPA_Issue25_Release1 3D_Engine_thermal_management</p>	
<p><b>Document Type</b> DRAW/ELSY</p>		<p><b>Edited</b> April/06/2023</p>	
<p><b>Release Status</b> RELEASED</p>			
<p><b>Document No</b> 33409142</p>	<p><b>Issue</b> 035</p>	<p><b>Page No</b> 93/177</p>	



# 3E Automatic Gear Shifting

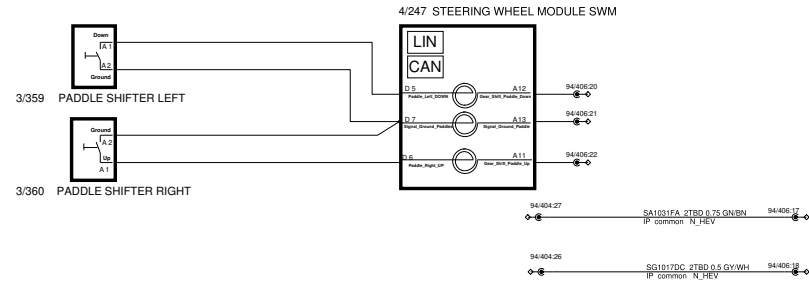

<p>The copying, distribution and utilization of this document as well as the communication of its contents to others without expressed authorization is prohibited. Offenders will be held liable for payment of damages. All rights reserved in the event of the grant of a patent, utility model or ornamental design registration.</p> <p><b>VOLVO</b> VOLVO CAR CORPORATION</p>	<p><b>Document title</b> SPA_Issue25_Release1 3E_Automatic_Gear_Shifting</p>		
	<p><b>Document Type</b> DRAW/ELSY</p>	<p><b>Edited</b> December/21/2021</p>	
	<p><b>Release Status</b> RELEASED</p>		
	<p><b>Document No</b> 33409142</p>	<p><b>Issue</b> 035</p>	<p><b>Page No</b> 94/177</p>



# 3E Automatic Gear Shifting 2

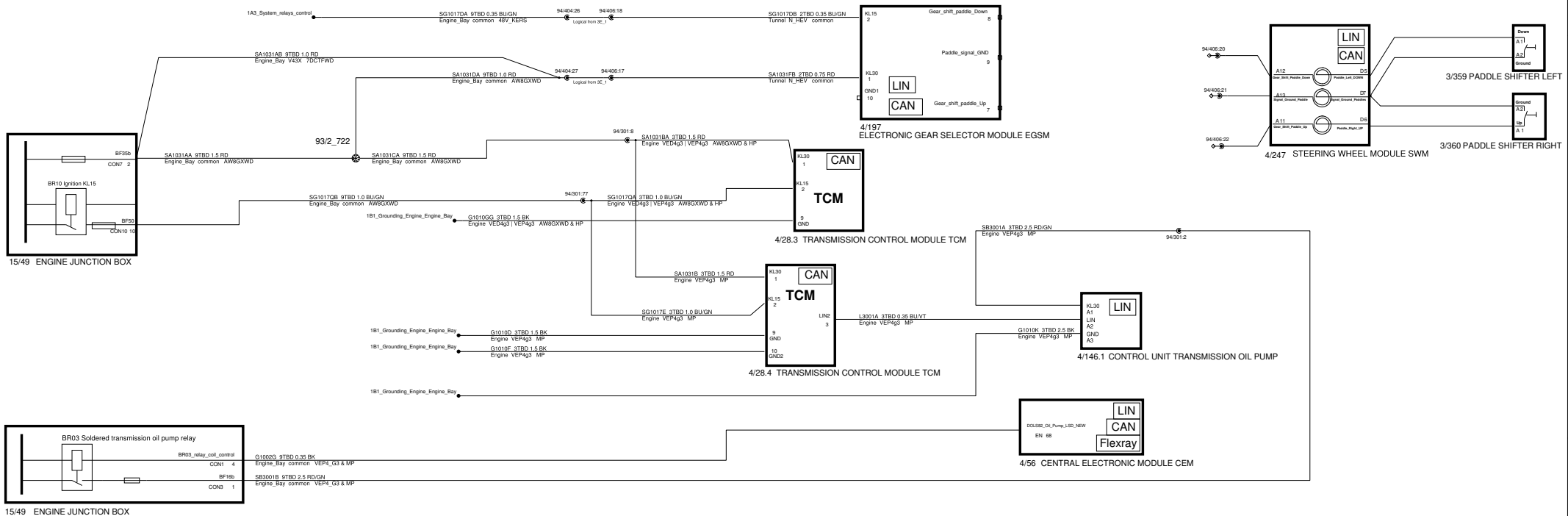

<p>The copying, distribution and utilization of this document as well as the communication of its contents to others without expressed authorization is prohibited. Offenders will be held liable for payment of damages. All rights reserved in the event of the grant of a patent, utility model or ornamental design registration.</p> <p><b>VOLVO</b> VOLVO CAR CORPORATION</p>	<p><b>Document title</b> SPA_Issue25_Release1 3E_Automatic_Gear_Shifting_2</p>		
	<p><b>Document Type</b> DRAW/ELSY</p>	<p><b>Edited</b> April/06/2023</p>	
	<p><b>Release Status</b> RELEASED</p>		
	<p><b>Document No</b> 33409142</p>	<p><b>Issue</b> 035</p>	<p><b>Page No</b> 95/177</p>



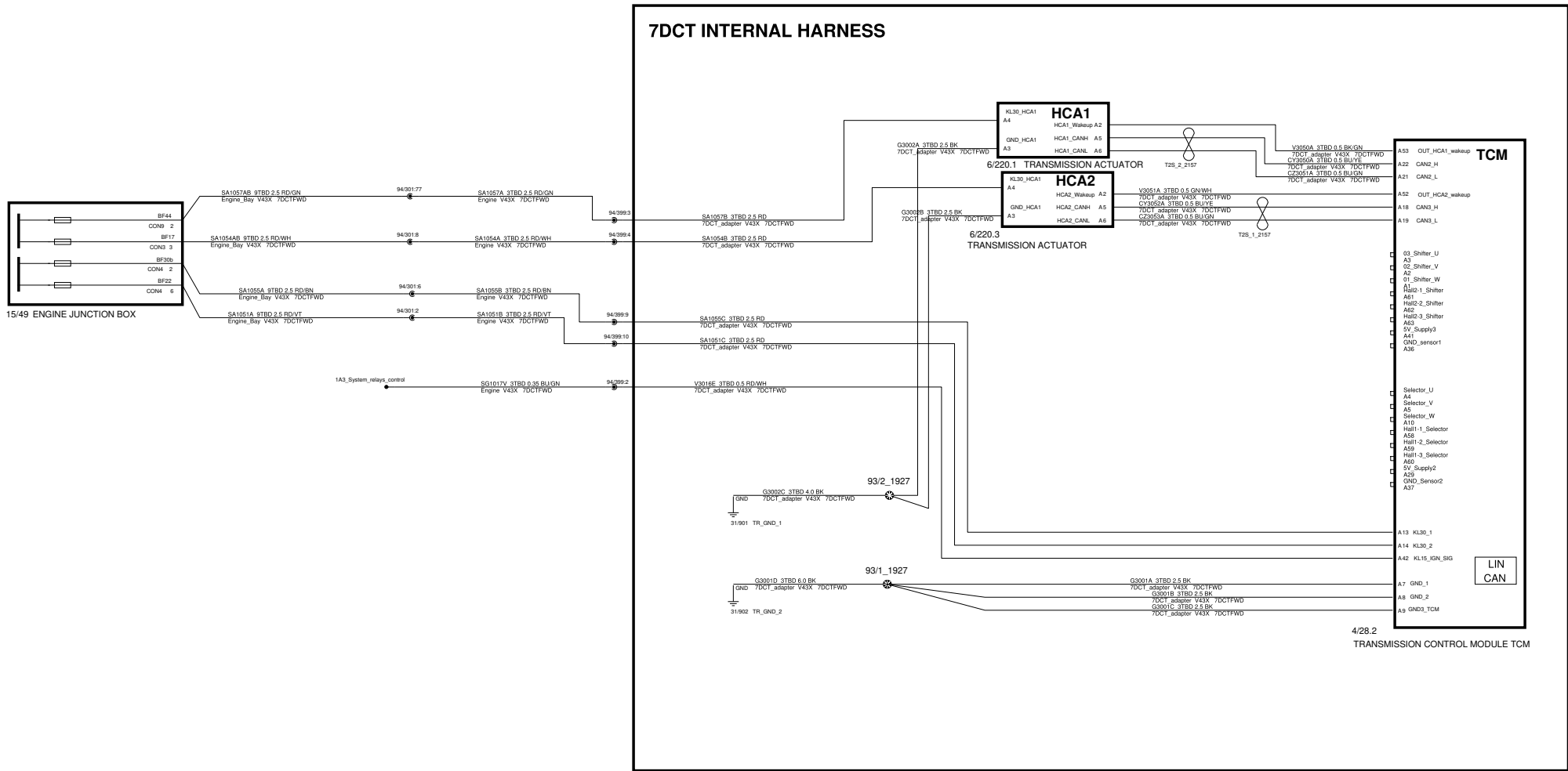

<p>The copying, distribution and utilization of this document as well as the communication of its contents to others without expressed authorization is prohibited. Offenders will be held liable for payment of damages. All rights reserved in the event of the grant of a patent, utility model or ornamental design registration.</p> <p><b>VOLVO</b></p> <p>VOLVO CAR CORPORATION</p>	<p><b>Document title</b> SPA_Issue25_Release1 3E_Automatic_Gear_Shifting_3</p>		
	<p><b>Document Type</b> DRAW/ELSY</p>	<p><b>Edited</b> April/23/2023</p>	
	<p><b>Release Status</b> RELEASED</p>		
	<p><b>Document No</b> 33409142</p>	<p><b>Issue</b> 035</p>	<p><b>Page No</b> 96/177</p>

# 3E Automatic Gear Shifting Hybrid

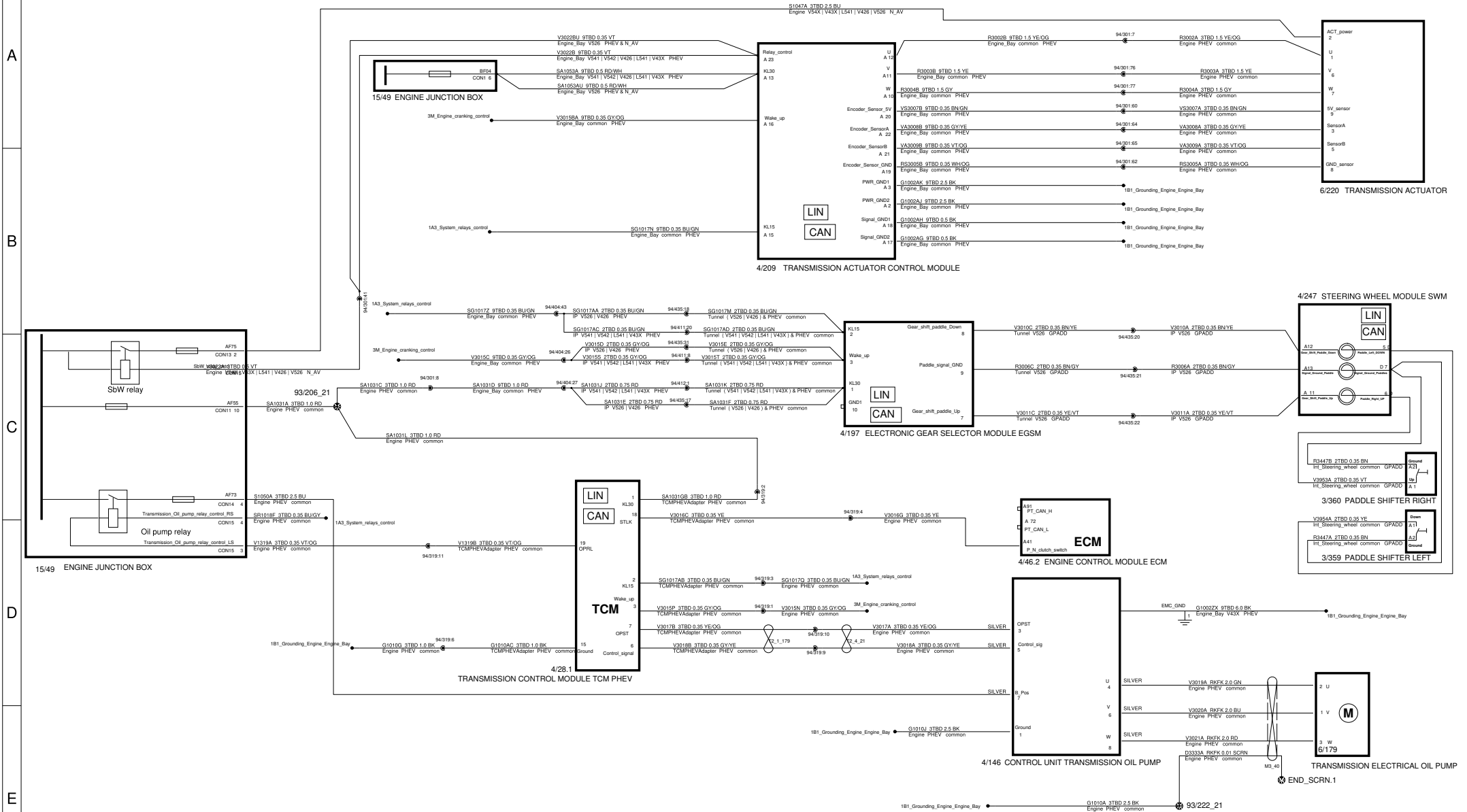

<p>The copying, distribution and utilization of this document as well as the communication of its contents to others without expressed authorization is prohibited. Offenders will be held liable for payment of damages. All rights reserved in the event of the grant of a patent, utility model or ornamental design registration.</p>		<p><b>Document title</b> SPA_Issue25_Release1 3E_Automatic_Gear_Shifting_Hybrid</p>	
<p><b>Document Type</b> DRAW/ELSY</p>		<p><b>Edited</b> March/31/2023</p>	
<p><b>Release Status</b> RELEASED</p>			
<p><b>Document No</b> 33409142</p>		<p><b>Issue</b> 035</p>	<p><b>Page No</b> 97/177</p>



# 3G 4WD Transmission

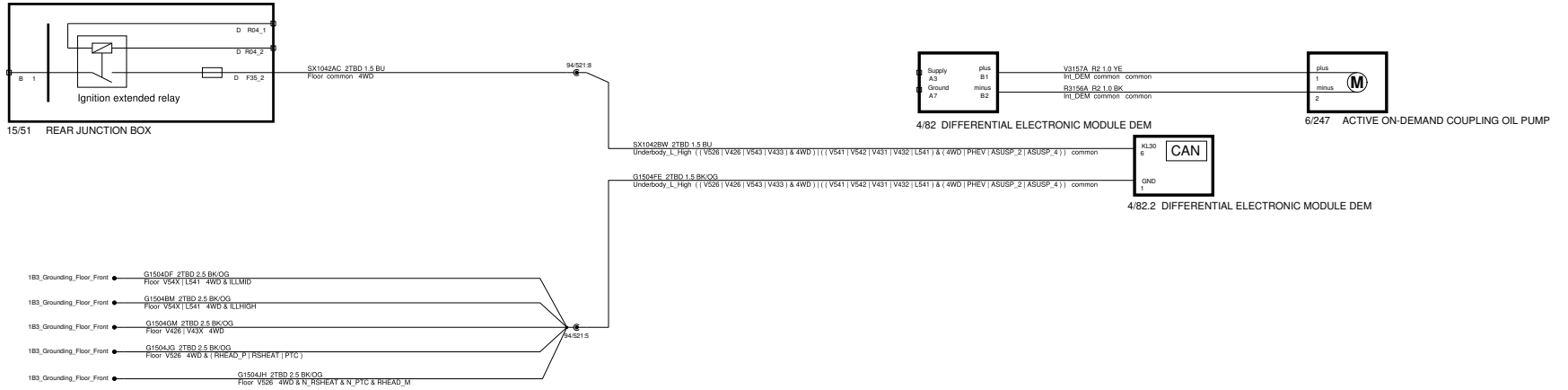

<p>The copying, distribution and utilization of this document as well as the communication of its contents to others without expressed authorization is prohibited. Offenders will be held liable for payment of damages. All rights reserved in the event of the grant of a patent, utility model or ornamental design registration.</p> <p><b>VOLVO</b> VOLVO CAR CORPORATION</p>	<b>Document title</b> SPA_Issue25_Release1 3G_4WD_Transmission	
	<b>Document Type</b> DRAW/ELSY	<b>Edited</b> April/06/2023
	<b>Release Status</b> RELEASED	
	<b>Document No</b> 33409142	<b>Issue</b> 035



# 3M Engine Cranking Control

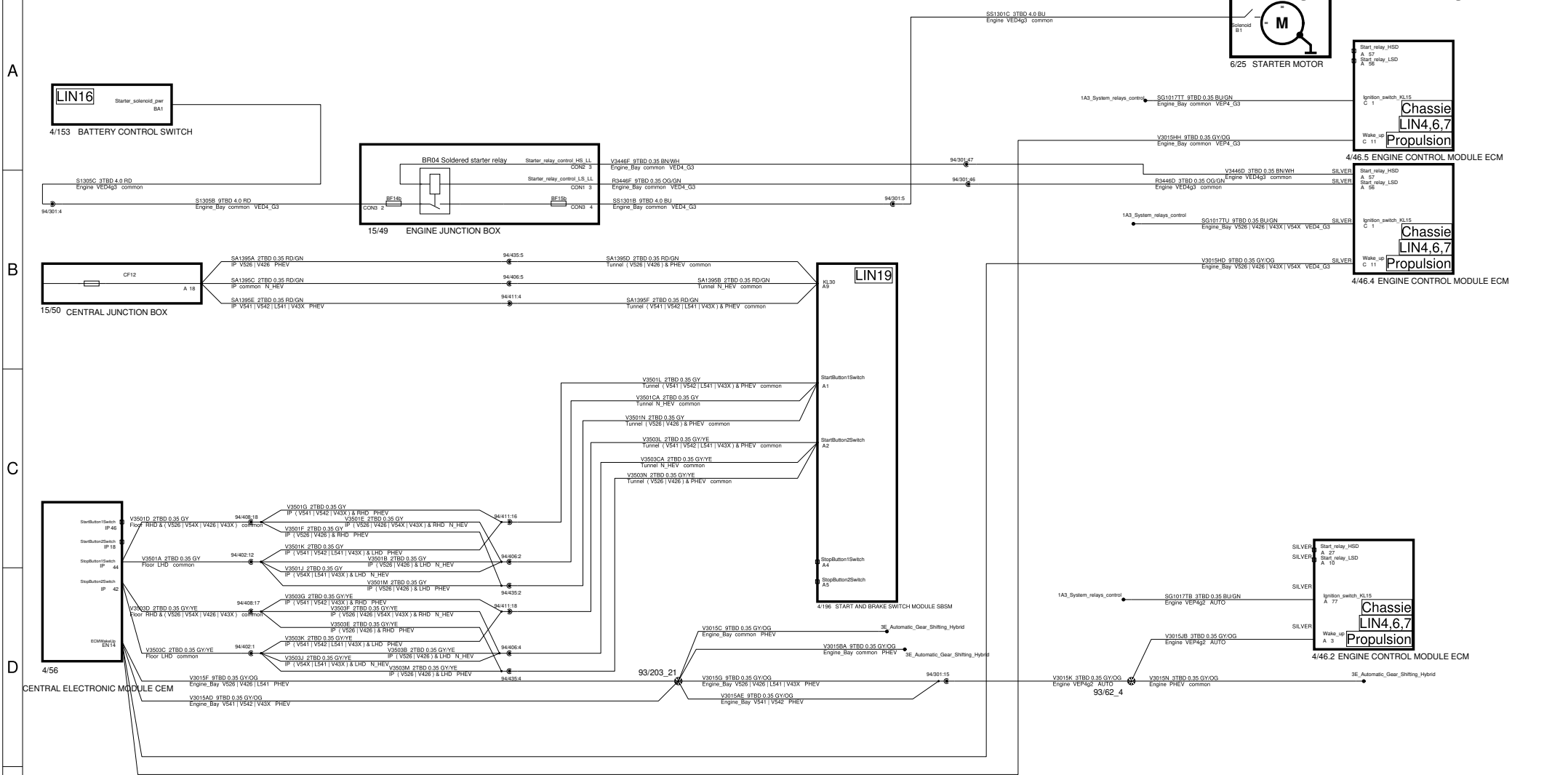

<p>The copying, distribution and utilization of this document as well as the communication of its contents to others without expressed authorization is prohibited. Offenders will be held liable for payment of damages. All rights reserved in the event of the grant of a patent, utility model or ornamental design registration.</p>		<p><b>Document title</b> SPA_Issue25_Release1</p>	
		<p><b>3M_Engine_cranking_control</b></p>	
<p><b>Document Type</b> DRAW/ELSY</p>		<p><b>Edited</b> April/06/2023</p>	
<p><b>Release Status</b> RELEASED</p>			
<p><b>Document No</b> 33409142</p>		<p><b>Issue</b> 035</p>	<p><b>Page No</b> 99/177</p>



# 3P Driveline Sound Absorbing

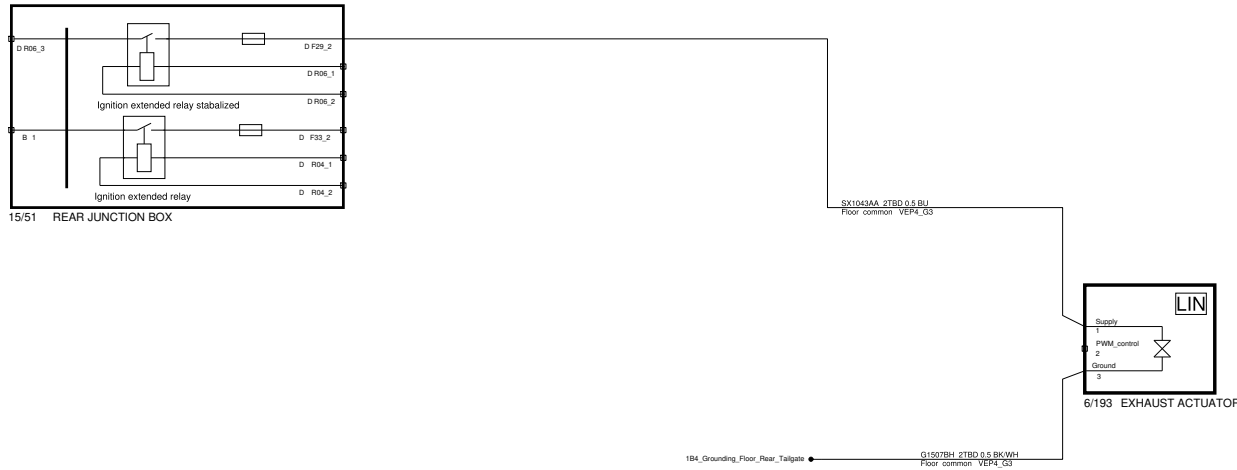

<p>The copying, distribution and utilization of this document as well as the communication of its contents to others without expressed authorization is prohibited. Offenders will be held liable for payment of damages. All rights reserved in the event of the grant of a patent, utility model or ornamental design registration.</p> <p><b>VOLVO</b> VOLVO CAR CORPORATION</p>	<b>Document title</b> SPA_Issue25_Release1 3P_Driveline_Sound_Absorbing		
	<b>Document Type</b> DRAW/ELSY	<b>Edited</b> March/03/2022	
	<b>Release Status</b> RELEASED		
	<b>Document No</b> 33409142	<b>Issue</b> 035	<b>Page No</b> 100/177

# 3S1 Fuel Leakage Detection

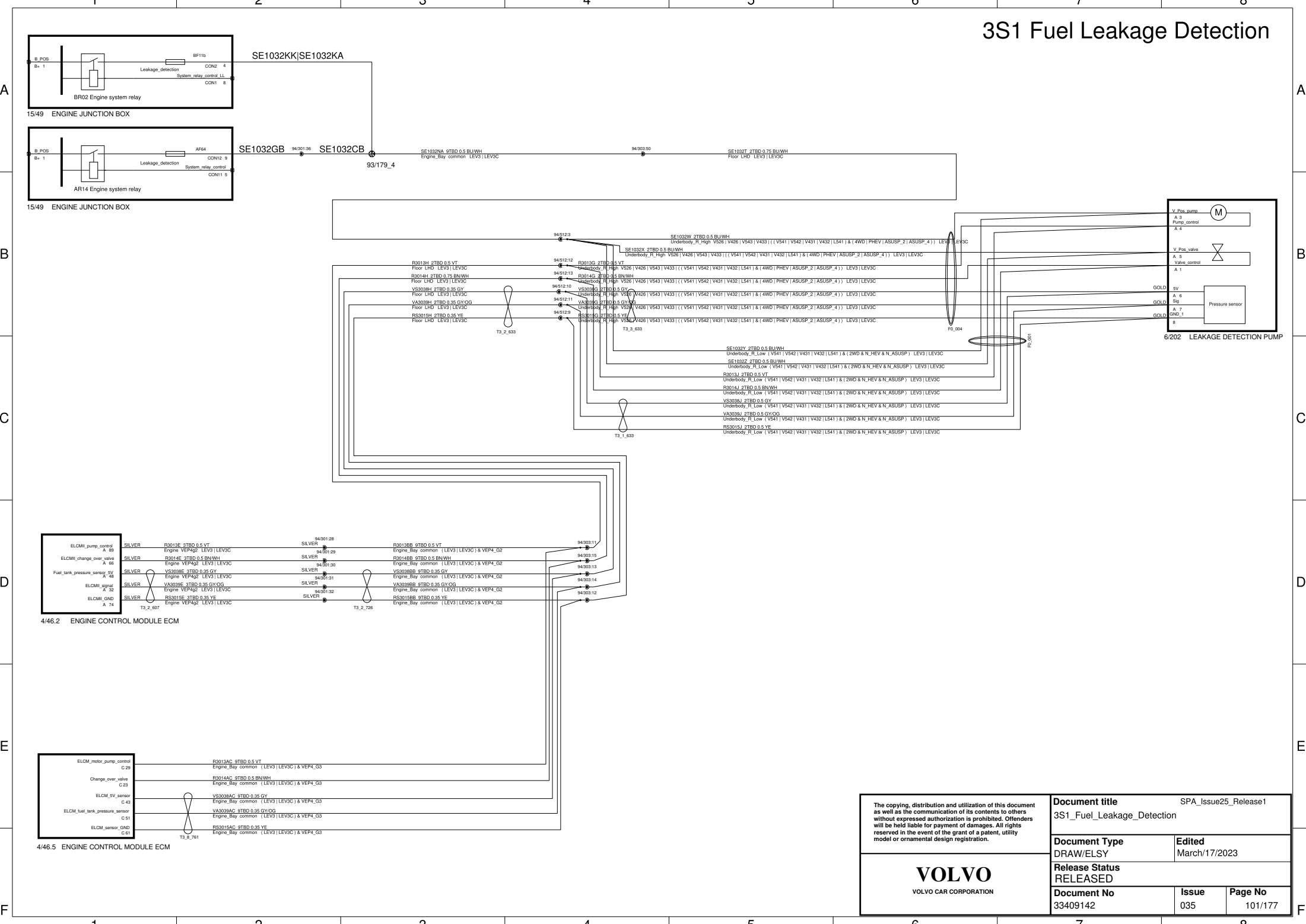

The copying, distribution and utilization of this document as well as the communication of its contents to others without expressed authorization is prohibited. Offenders will be held liable for payment of damages. All rights reserved in the event of the grant of a patent, utility model or ornamental design registration.

**VOLVO**  
VOLVO CAR CORPORATION

<b>Document title</b> SPA_Issue25_Release1 3S1_Fuel_Leakage_Detection	
<b>Document Type</b> DRAW/ELSY	<b>Edited</b> March/17/2023
<b>Release Status</b> RELEASED	
<b>Document No</b> 33409142	<b>Issue</b> 035
	<b>Page No</b> 101/177

# 3S Fuel Supply Control

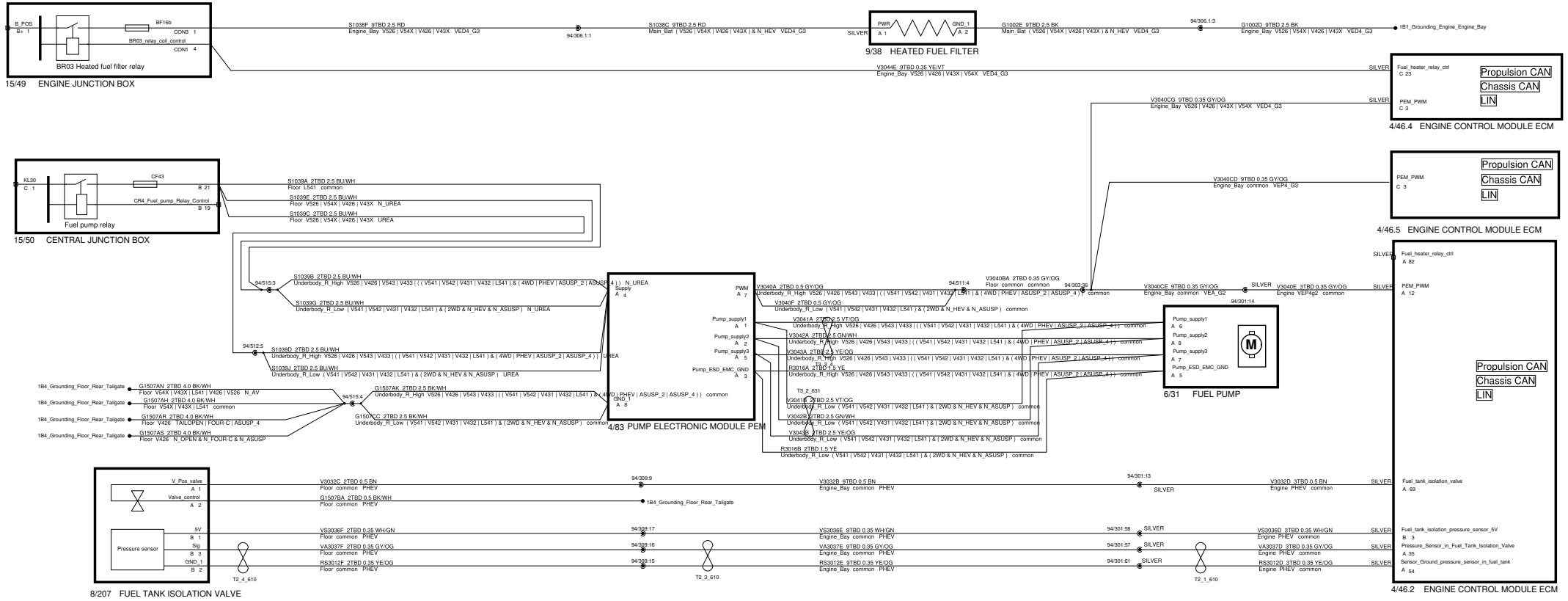

<p>The copying, distribution and utilization of this document as well as the communication of its contents to others without expressed authorization is prohibited. Offenders will be held liable for payment of damages. All rights reserved in the event of the grant of a patent, utility model or ornamental design registration.</p> <p><b>VOLVO</b> VOLVO CAR CORPORATION</p>	<p>Document title SPA_Issue25_Release1 3S_Fuel_Supply_Control</p>	
	<p>Document Type DRAW/ELSY</p>	<p>Edited April/06/2023</p>
	<p>Release Status RELEASED</p>	
	<p>Document No 33409142</p>	<p>Issue 035</p>

# 3U NOx Reduction Pump

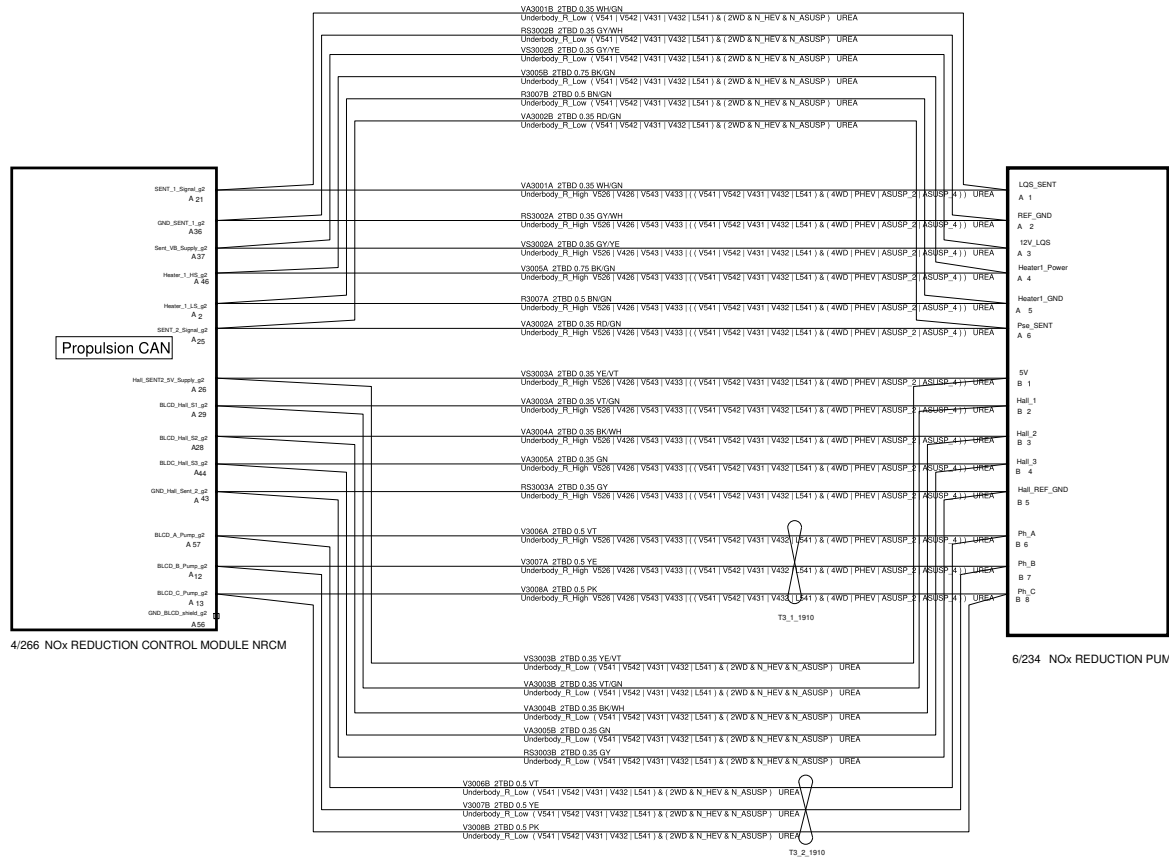

<p>The copying, distribution and utilization of this document as well as the communication of its contents to others without expressed authorization is prohibited. Offenders will be held liable for payment of damages. All rights reserved in the event of the grant of a patent, utility model or ornamental design registration.</p> <p><b>VOLVO</b> VOLVO CAR CORPORATION</p>	<p><b>Document title</b> SPA_Issue25_Release1 3U1_NOx_Reduction_Pump</p>	
	<p><b>Document Type</b> DRAW/ELSY</p>	<p><b>Edited</b> March/17/2023</p>
	<p><b>Release Status</b> RELEASED</p>	
	<p><b>Document No</b> 33409142</p>	<p><b>Issue</b> 035</p> <p><b>Page No</b> 103/177</p>



# 3U NOx Reduction Sensors

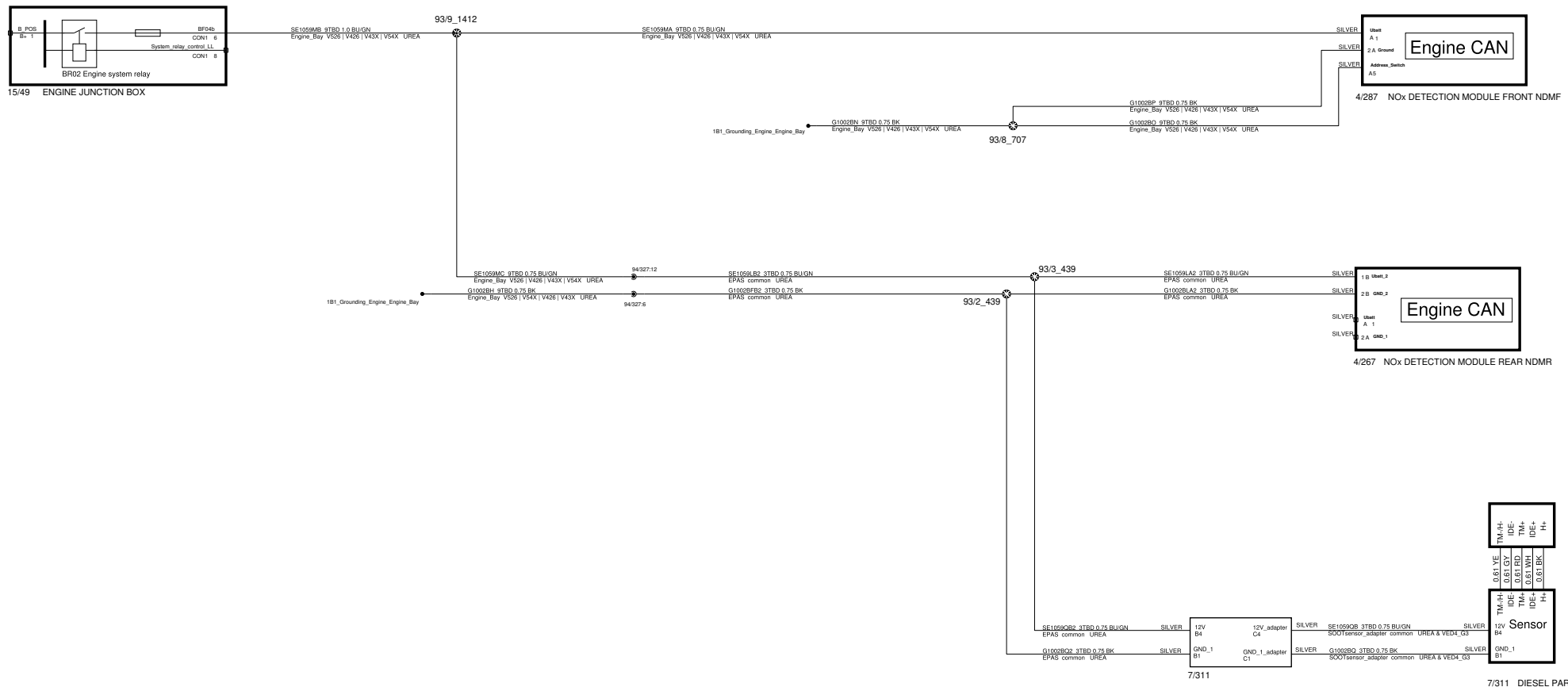

<p>The copying, distribution and utilization of this document as well as the communication of its contents to others without expressed authorization is prohibited. Offenders will be held liable for payment of damages. All rights reserved in the event of the grant of a patent, utility model or ornamental design registration.</p>		<p><b>Document title</b> SPA_Issue25_Release1 3U2_NOx_Reduction_Sensors</p>	
		<p><b>Document Type</b> DRAW/ELSY</p>	<p><b>Edited</b> March/21/2023</p>
<p><b>VOLVO</b> VOLVO CAR CORPORATION</p>			
<p><b>Release Status</b> RELEASED</p>		<p><b>Document No</b> 33409142</p>	<p><b>Issue</b> 035</p>
		<p><b>Page No</b> 104/177</p>	

# 3U NOx Reduction

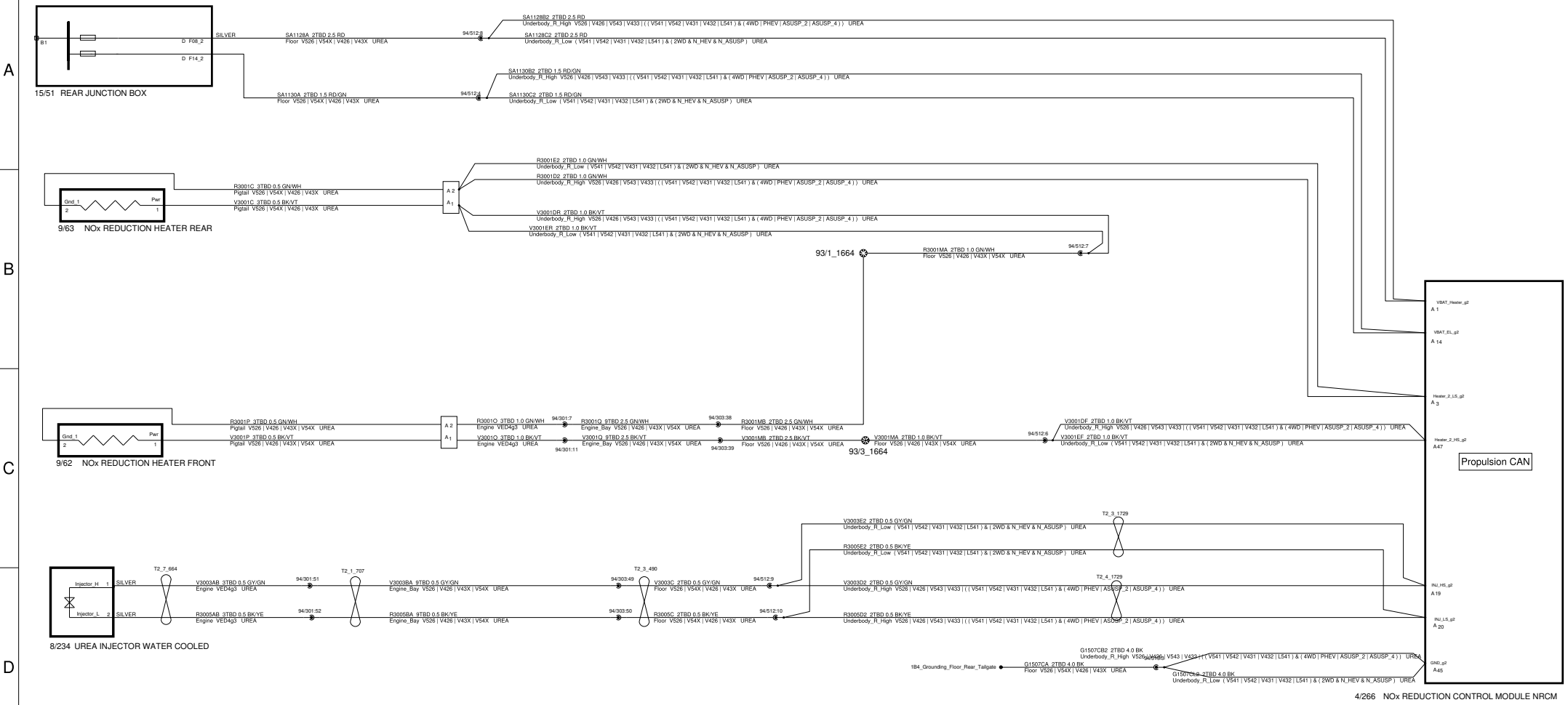

 VOLVO CAR CORPORATION	The copying, distribution and utilization of this document as well as the communication of its contents to others without expressed authorization is prohibited. Offenders will be held liable for payment of damages. All rights reserved in the event of the grant of a patent, utility model or ornamental design registration.		<b>Document title</b> SPA_Issue25_Release1 3U_NOx_Reduction	
	<b>Document Type</b> DRAW/ELSY		<b>Edited</b> April/06/2023	
	<b>Release Status</b> RELEASED			
	<b>Document No</b> 33409142	<b>Issue</b> 035	<b>Page No</b> 105/177	



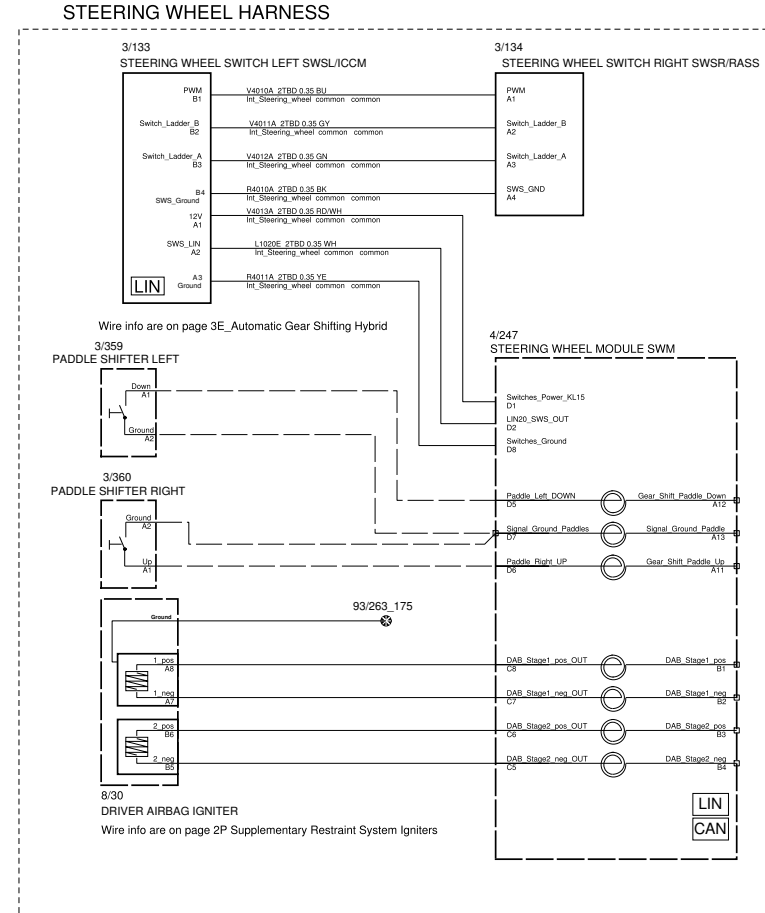
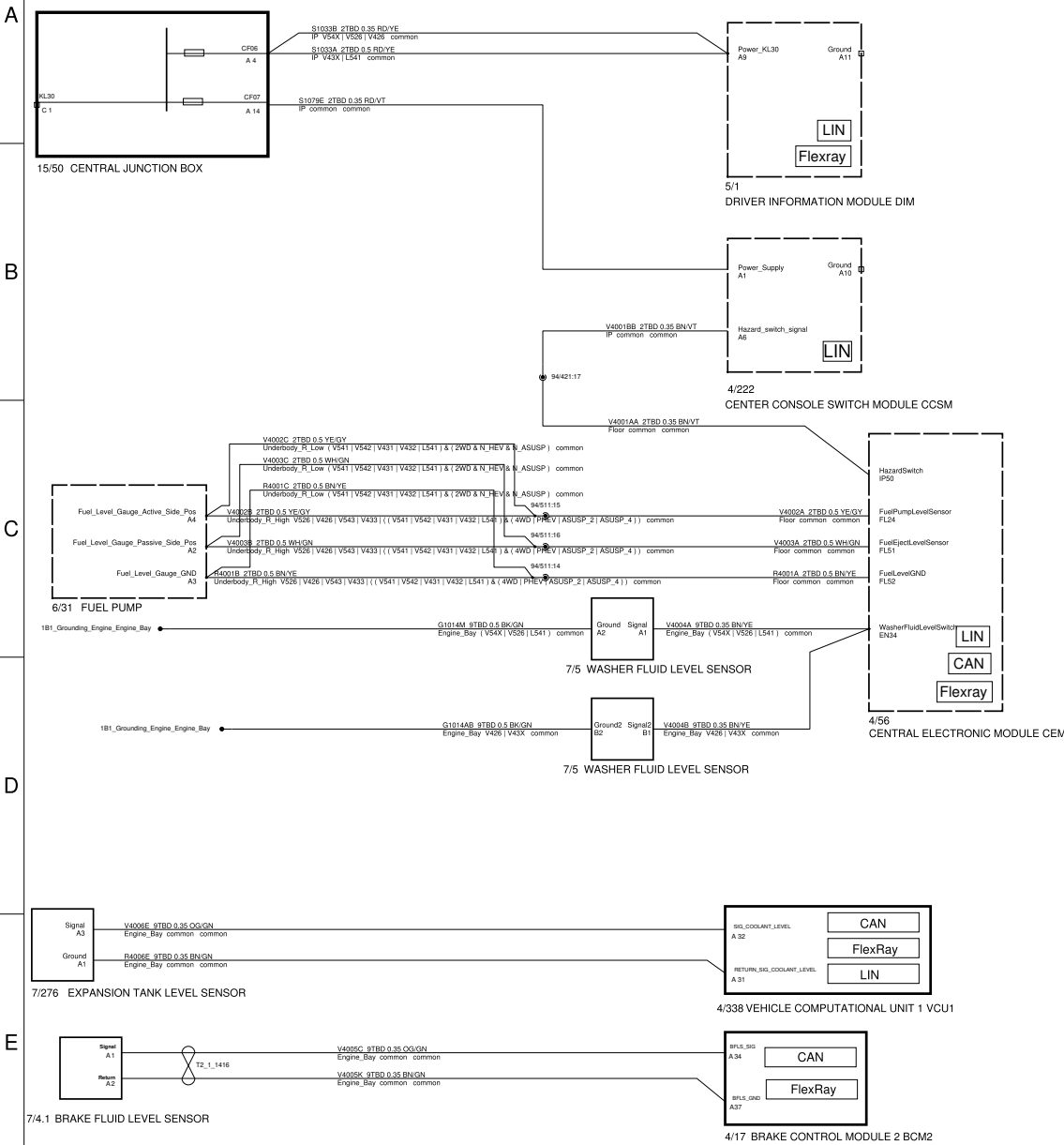

The copying, distribution and utilization of this document as well as the communication of its contents to others without expressed authorization is prohibited. Offenders will be held liable for payment of damages. All rights reserved in the event of the grant of a patent, utility model or ornamental design registration.		<b>Document title</b> SPA_Issue25_Release1	
<b>Document title</b> 4A_001_Driver_Information		<b>Document Type</b> DRAW/ELSY	
		<b>Edited</b> April/06/2023	
<b>VOLVO</b> VOLVO CAR CORPORATION			
<b>Release Status</b> RELEASED		<b>Document No</b> 33409142	
		<b>Issue</b> 035	<b>Page No</b> 106/177



# 4A Tyre Pressure Monitoring System



7/210 TYRE PRESSURE SENSOR LH FRONT



7/211 TYRE PRESSURE SENSOR RH FRONT



7/212 TYRE PRESSURE SENSOR LH REAR



7/213 TYRE PRESSURE SENSOR RH REAR



4/167 MULTIBAND ANTENNA MODULE MAM

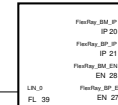

4/56 CENTRAL ELECTRONIC MODULE CEM

<p>The copying, distribution and utilization of this document as well as the communication of its contents to others without expressed authorization is prohibited. Offenders will be held liable for payment of damages. All rights reserved in the event of the grant of a patent, utility model or ornamental design registration.</p> <p><b>VOLVO</b> VOLVO CAR CORPORATION</p>	<p><b>Document title</b> SPA_Issue25_Release1 4A_002_Tyre_Pressure_Monitoring_System</p>		
	<p><b>Document Type</b> DRAW/ELSY</p>	<p><b>Edited</b> March/21/2023</p>	
	<p><b>Release Status</b> RELEASED</p>		
	<p><b>Document No</b> 33409142</p>	<p><b>Issue</b> 035</p>	<p><b>Page No</b> 107/177</p>

Silver plating added on connectors.  
Not shown in schematic.

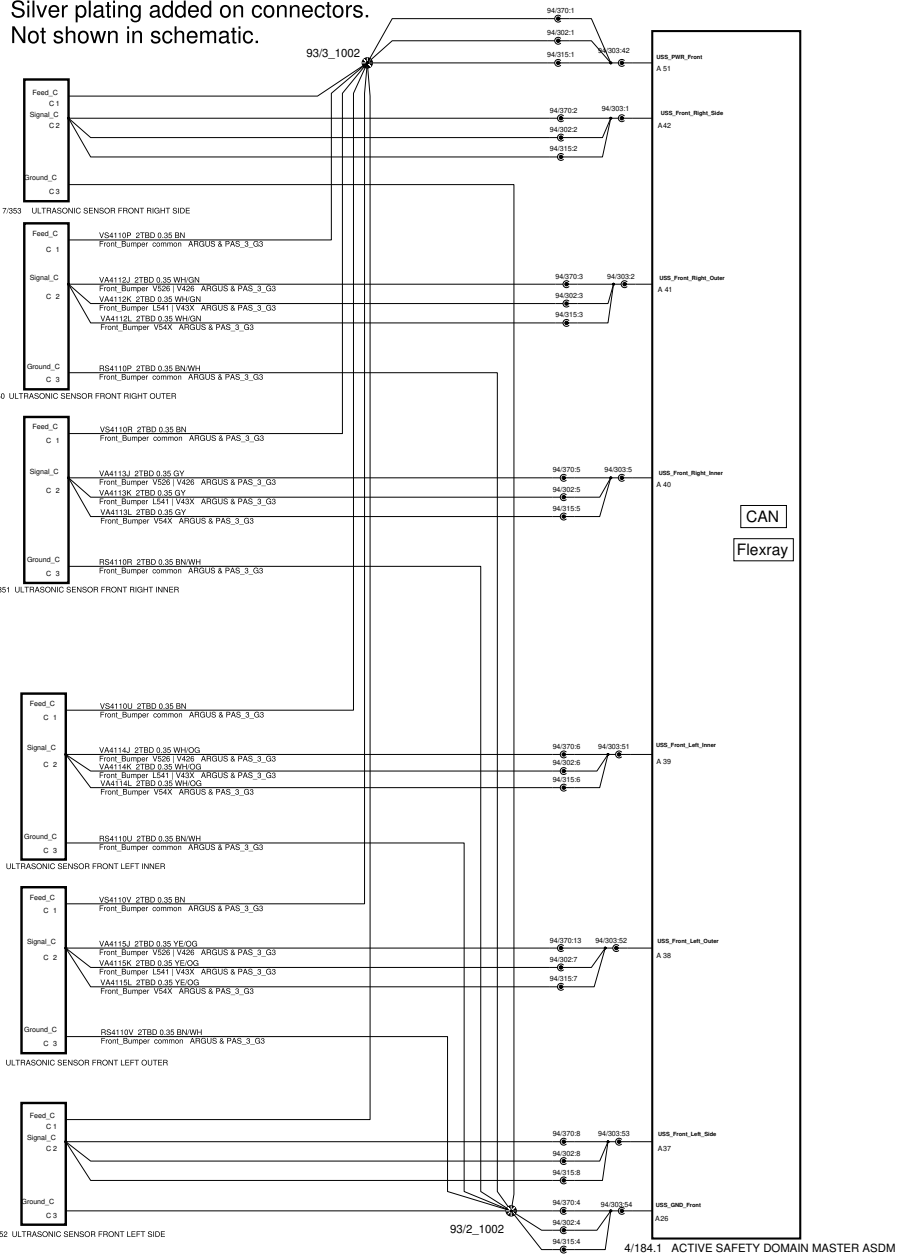

# 4J1 USS FAP ARGUS

Silver plating added on connectors.  
Not shown in schematic.

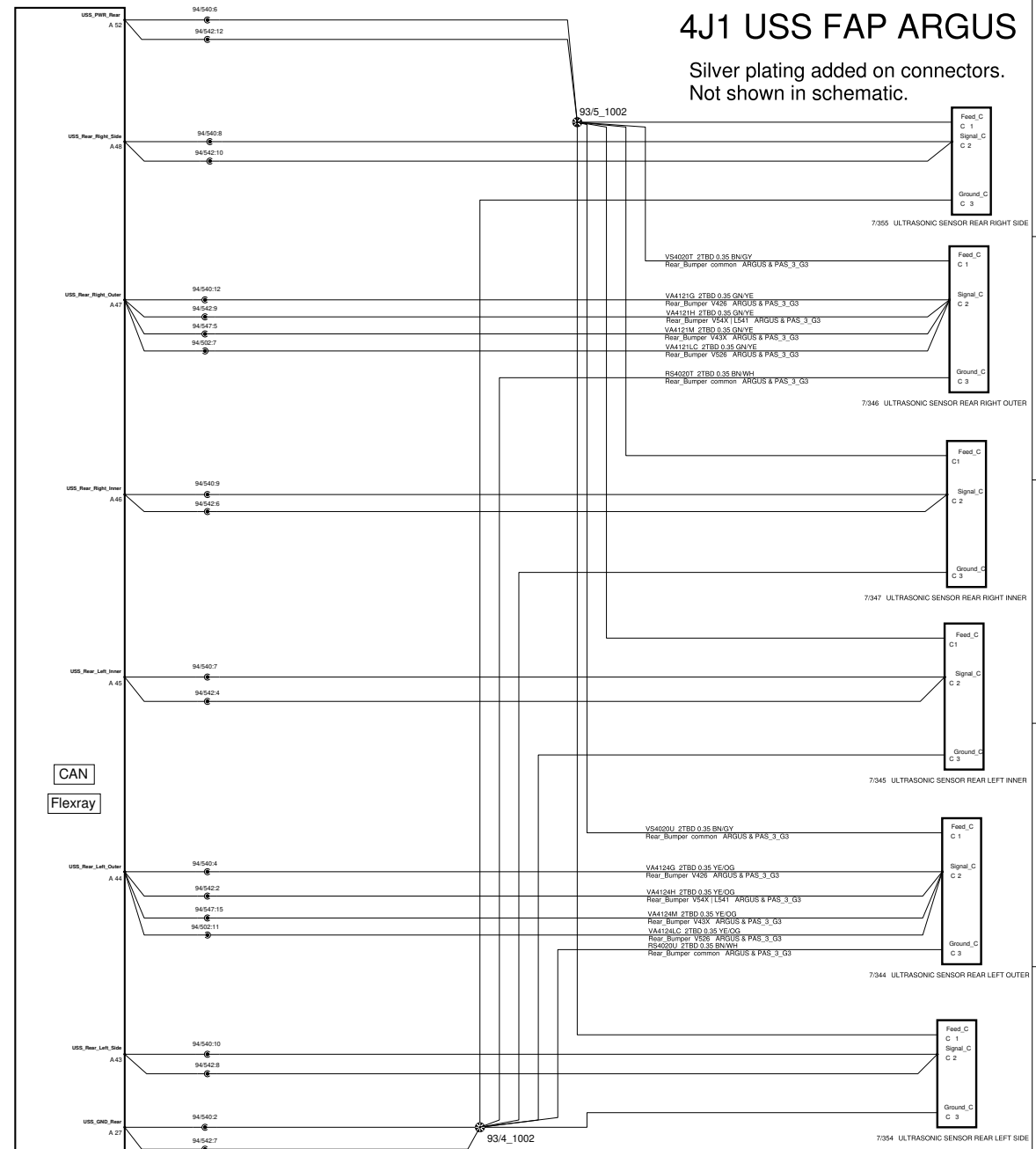

<p>The copying, distribution and utilization of this document as well as the communication of its contents to others without expressed authorization is prohibited. Offenders will be held liable for payment of damages. All rights reserved in the event of the grant of a patent, utility model or ornamental design registration.</p>		Document title		SPA_Issue25_Release1	
		4J1_USS_FAP_ARGUS			
Document Type		DRAW/ELSY		Edited	
Release Status		RELEASED		March/21/2023	
Document No		33409142		Issue	
		035		Page No	
				108/177	

**VOLVO**  
VOLVO CAR CORPORATION

4/184.1 ACTIVE SAFETY DOMAIN MASTER ASDM

# 4J1 USS Front ARGUS

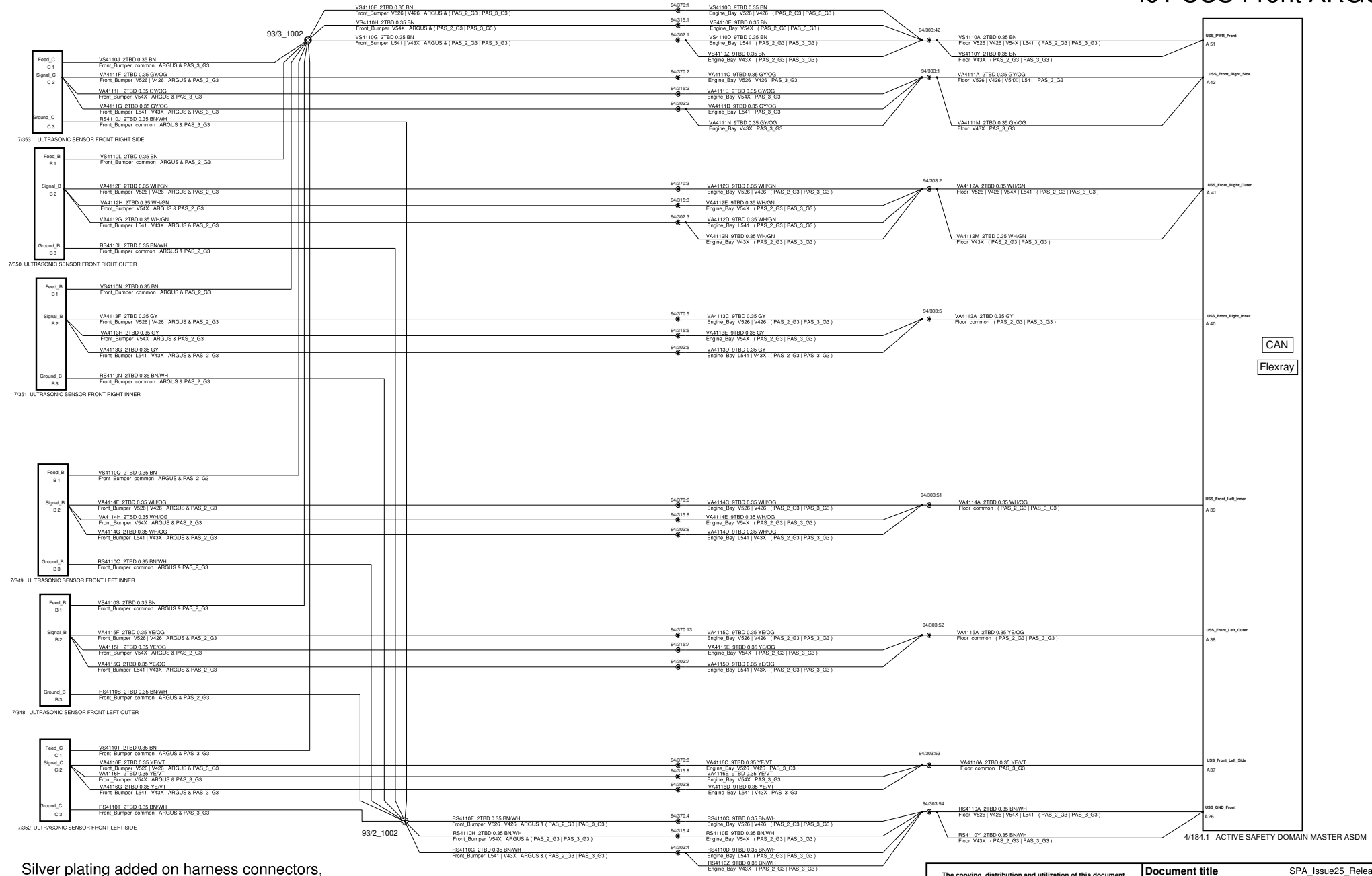

Silver plating added on harness connectors, but not visible in the schematic

<p>The copying, distribution and utilization of this document as well as the communication of its contents to others without expressed authorization is prohibited. Offenders will be held liable for payment of damages. All rights reserved in the event of the grant of a patent, utility model or ornamental design registration.</p> <p style="text-align: center;"><b>VOLVO</b> VOLVO CAR CORPORATION</p>		<p><b>Document title</b> SPA_Issue25_Release1 4J1_USS_Front_ARGUS</p>	
		<p><b>Document Type</b> DRAW/ELSY</p>	<p><b>Edited</b> February/06/2022</p>
<p><b>Release Status</b> RELEASED</p>		<p><b>Document No</b> 33409142</p>	<p><b>Issue</b> 035</p>
		<p><b>Page No</b> 109/177</p>	

# 4J1 USS Rear ARGUS

Silver plating added on connectors.  
Not shown in schematic.

A

B

C

D

E

F

A

B

C

D

E

F

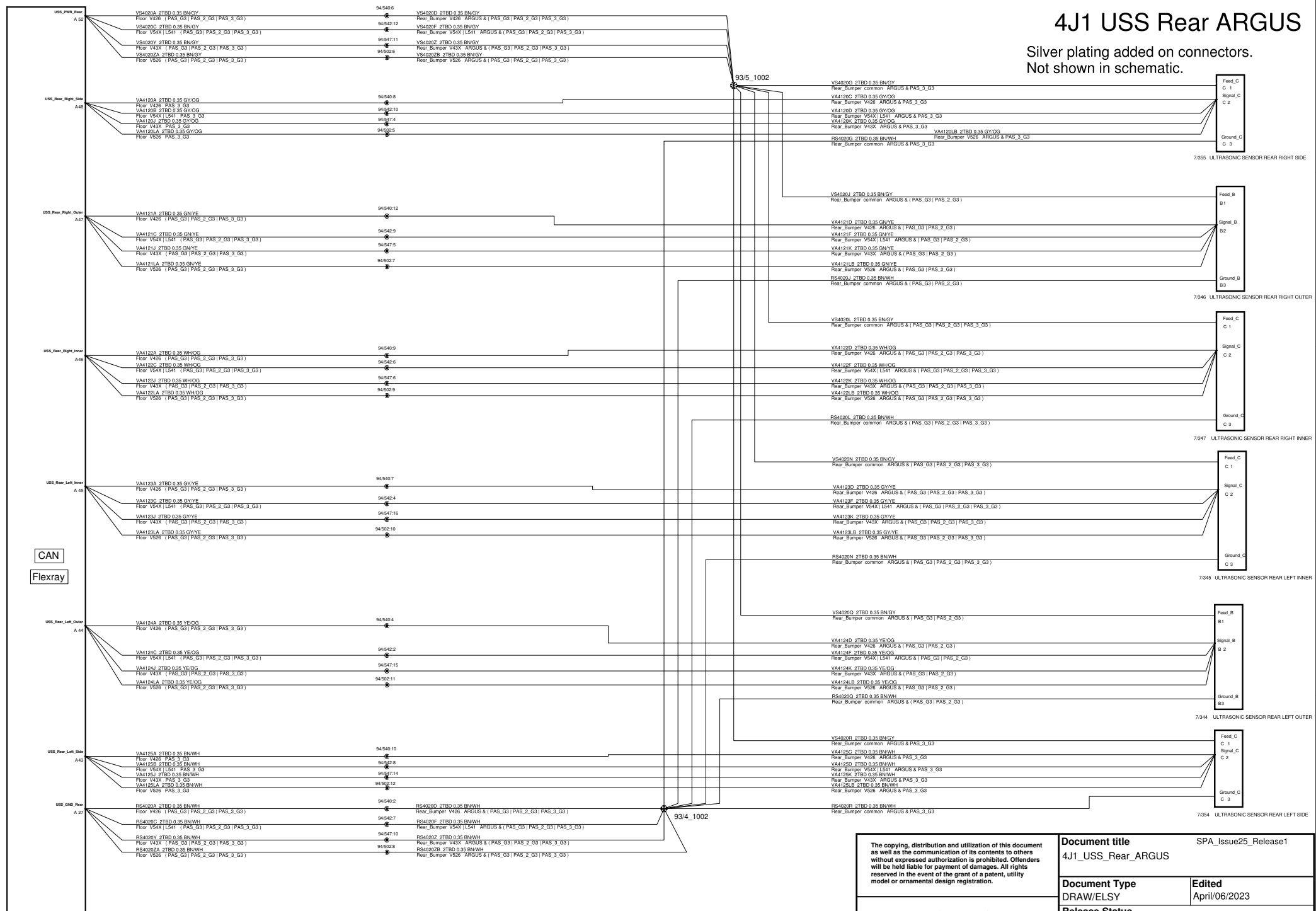

CAN

Flexray

4/184.1 ACTIVE SAFETY DOMAIN MASTER ASDM

<p>The copying, distribution and utilization of this document as well as the communication of its contents to others without expressed authorization is prohibited. Offenders will be held liable for payment of damages. All rights reserved in the event of the grant of a patent, utility model or ornamental design registration.</p>		Document title		SPA_Issue25_Release1	
		4J1_USS_Rear_ARGUS			
Document Type		DRAW/ELSY		Edited	
				April/06/2023	
Release Status		RELEASED			
Document No		33409142		Issue	
				035	
				Page No	
				110/177	

**VOLVO**  
VOLVO CAR CORPORATION

# 4J2B Lane Change Aid

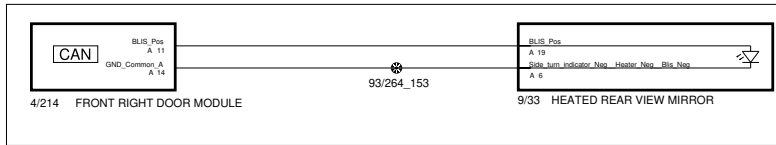
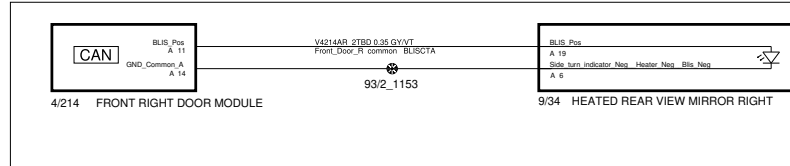
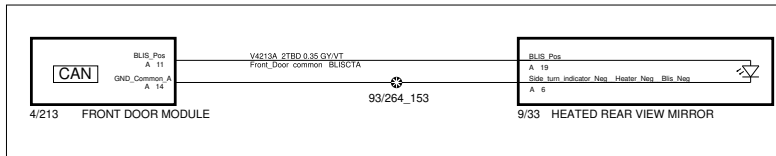
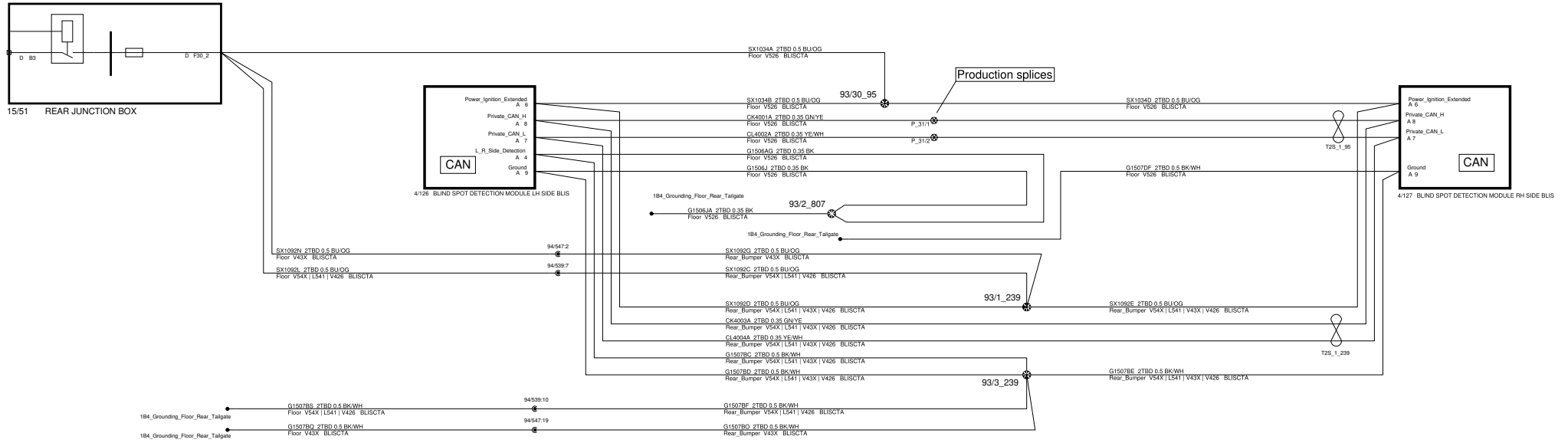

<b>VOLVO</b> VOLVO CAR CORPORATION	<b>Document title</b> SPA_Issue25_Release1 4J2B_Lane_Change_Aid	
	<b>Document Type</b> DRAW/ELSY	<b>Edited</b> March/21/2023
	<b>Release Status</b> RELEASED	
	<b>Document No</b> 33409142	<b>Issue</b> 035 <b>Page No</b> 111/177



# 4J4 PAC Visualisation/Driver Assistance COAX

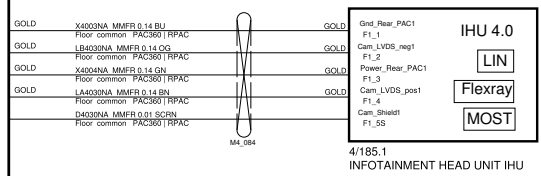
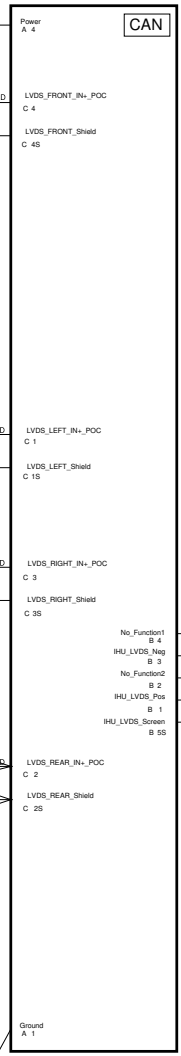
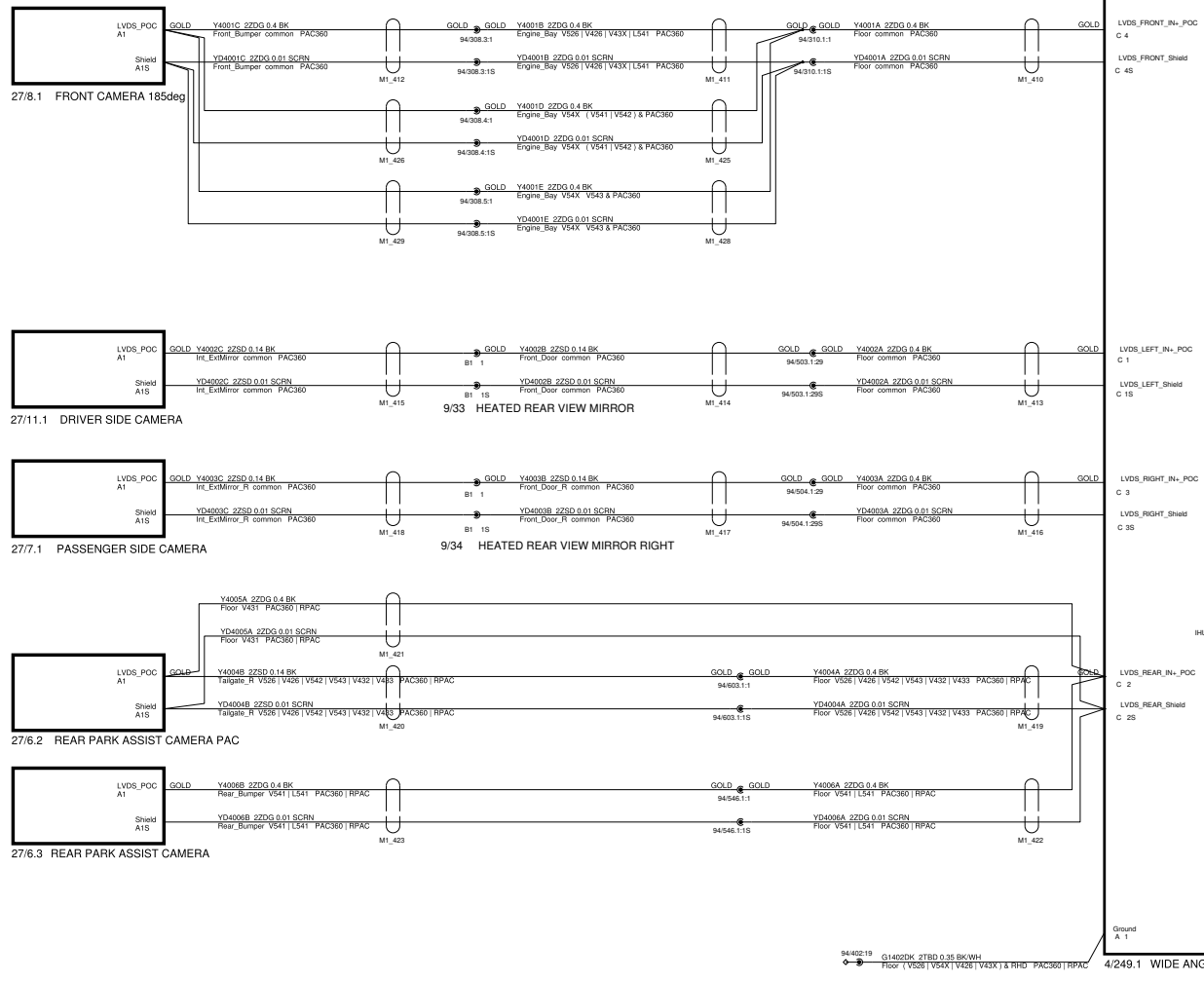
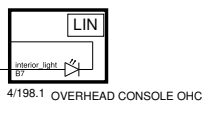
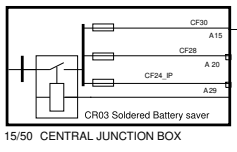

The copying, distribution and utilization of this document as well as the communication of its contents to others without expressed authorization is prohibited. Offenders will be held liable for payment of damages. All rights reserved in the event of the grant of a patent, utility model or ornamental design registration.		Document title SPA_Issue25_Release1	
DRAW/ELSY		Issued March/21/2023	
VOLVO VOLVO CAR CORPORATION		Release Status RELEASED	
Document No 33409142	Issue 035	Page No 112/177	

# 5A Climate Control

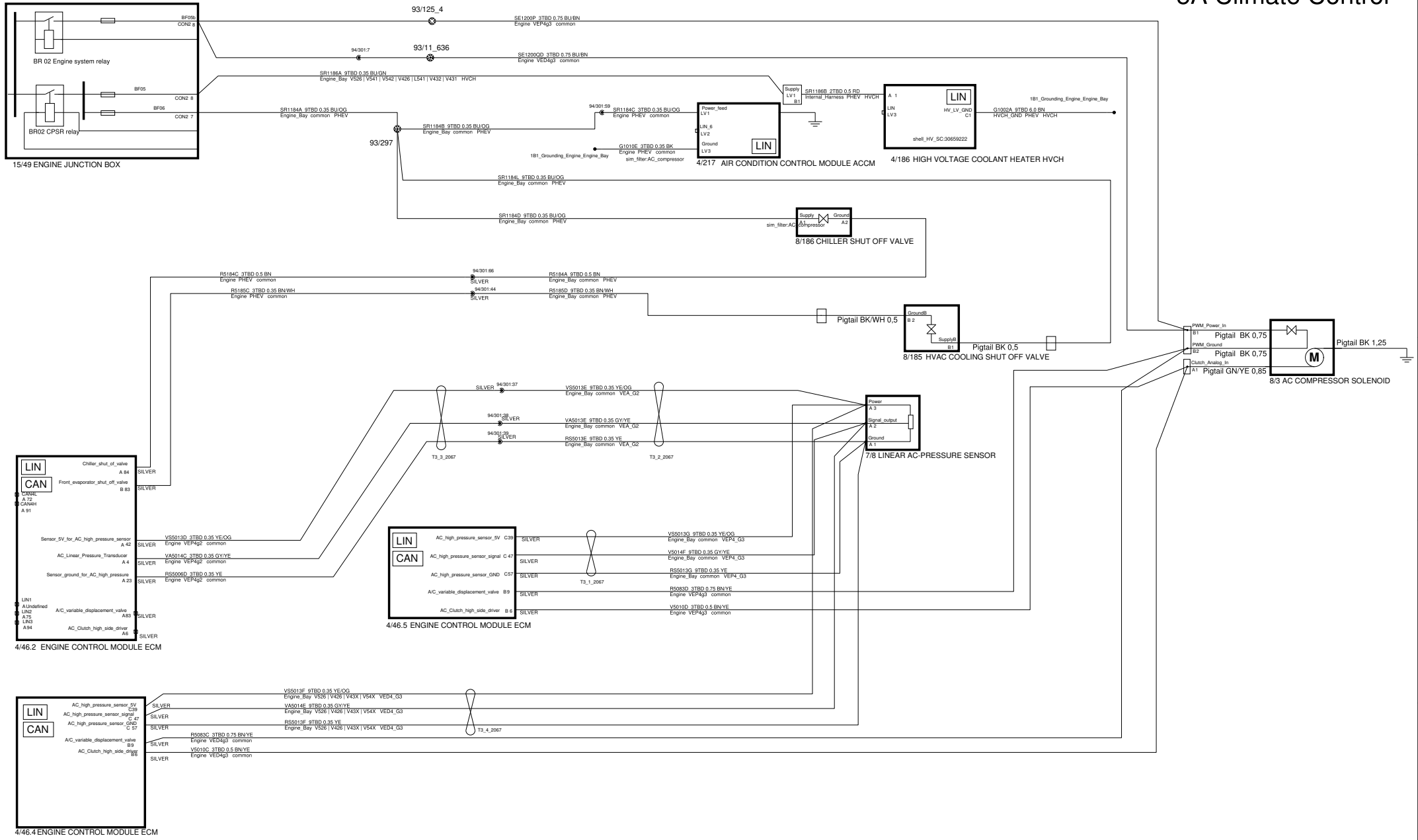

<p>The copying, distribution and utilization of this document as well as the communication of its contents to others without expressed authorization is prohibited. Offenders will be held liable for payment of damages. All rights reserved in the event of the grant of a patent, utility model or ornamental design registration.</p> <p><b>VOLVO</b> VOLVO CAR CORPORATION</p>	<p><b>Document title</b> SPA_Issue25_Release1 5A_Climate_Control</p>	
	<p><b>Document Type</b> DRAW/ELSY</p>	<p><b>Edited</b> April/06/2023</p>
	<p><b>Release Status</b> RELEASED</p>	
	<p><b>Document No</b> 33409142</p>	<p><b>Issue</b> 035</p> <p><b>Page No</b> 113/177</p>

# 5A Climate Control 2

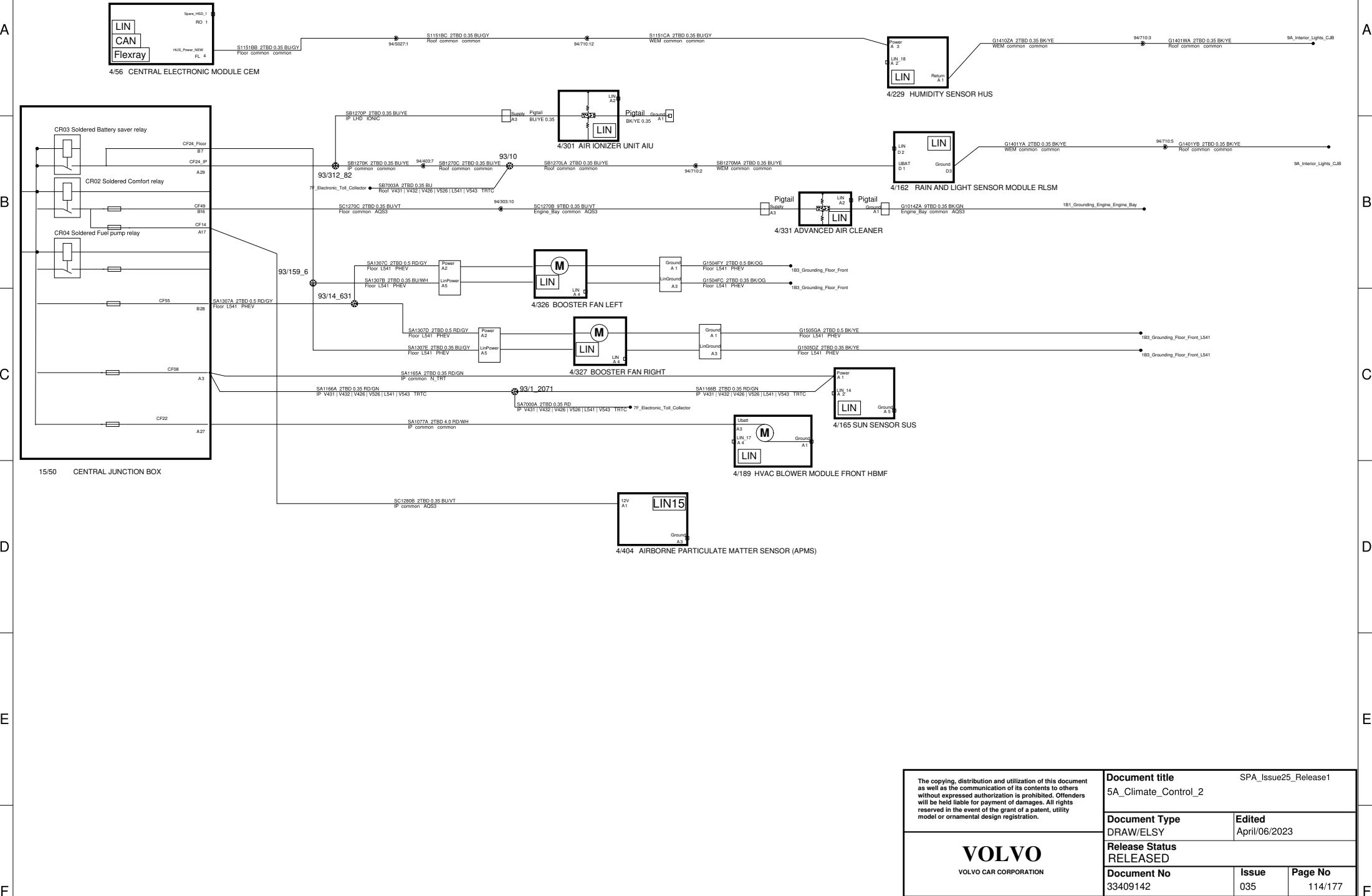

<b>VOLVO</b> VOLVO CAR CORPORATION	<b>Document title</b> SPA_Issue25_Release1 5A_Climate_Control_2	
	<b>Document Type</b> DRAW/ELSY	<b>Edited</b> April/06/2023
	<b>Release Status</b> RELEASED	
	<b>Document No</b> 33409142	<b>Issue</b> 035
		<b>Page No</b> 114/177

# 5A Climate Control HVAC

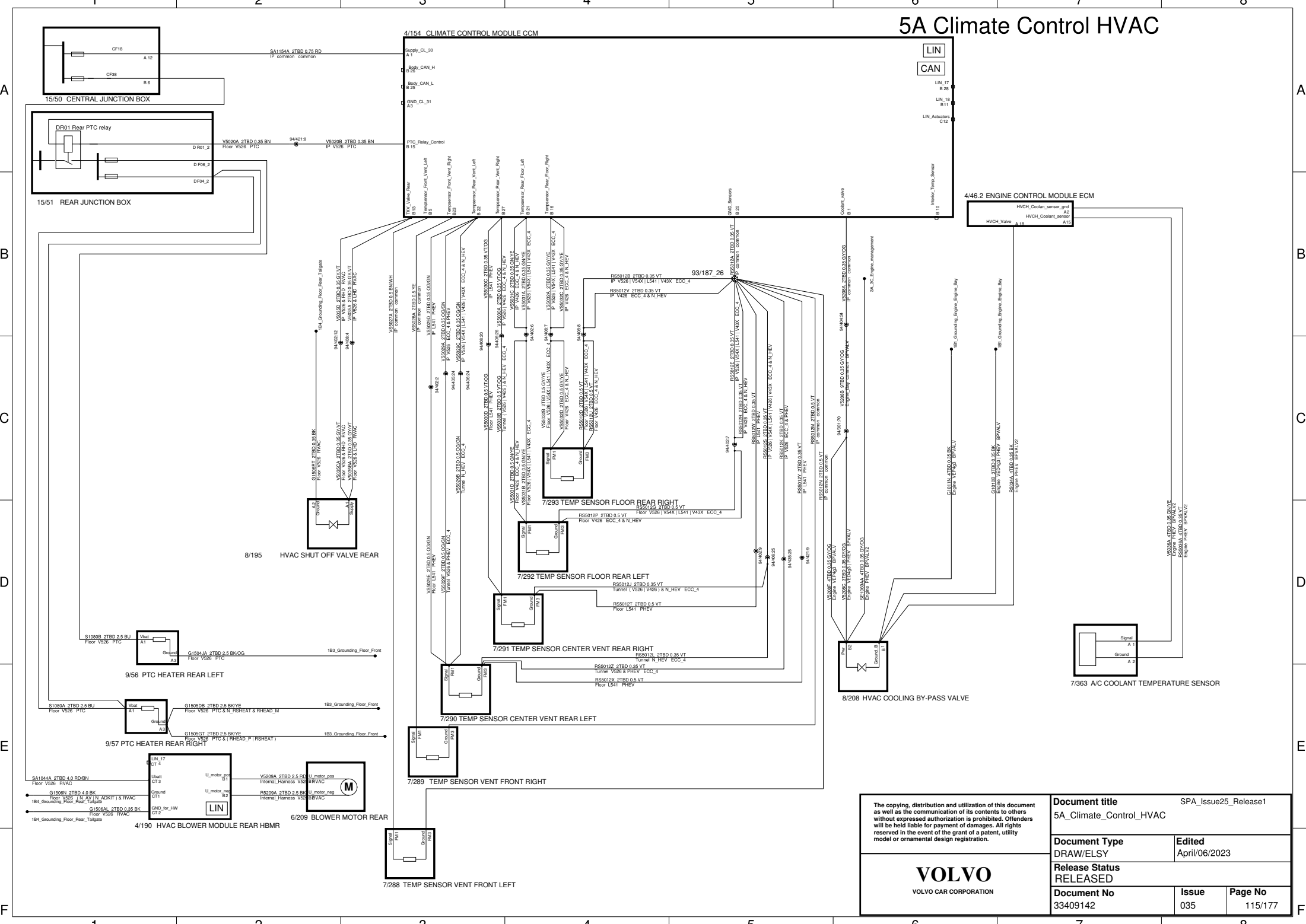

The copying, distribution and utilization of this document as well as the communication of its contents to others without expressed authorization is prohibited. Offenders will be held liable for payment of damages. All rights reserved in the event of the grant of a patent, utility model or ornamental design registration.

**VOLVO**  
VOLVO CAR CORPORATION

Document title		SPA_Issue25_Release1	
5A_Climate_Control_HVAC			
Document Type	DRAW/ELSY	Edited	April/06/2023
Release Status	RELEASED		
Document No	33409142	Issue	035
		Page No	115/177

# 5B Front Seat Comfort

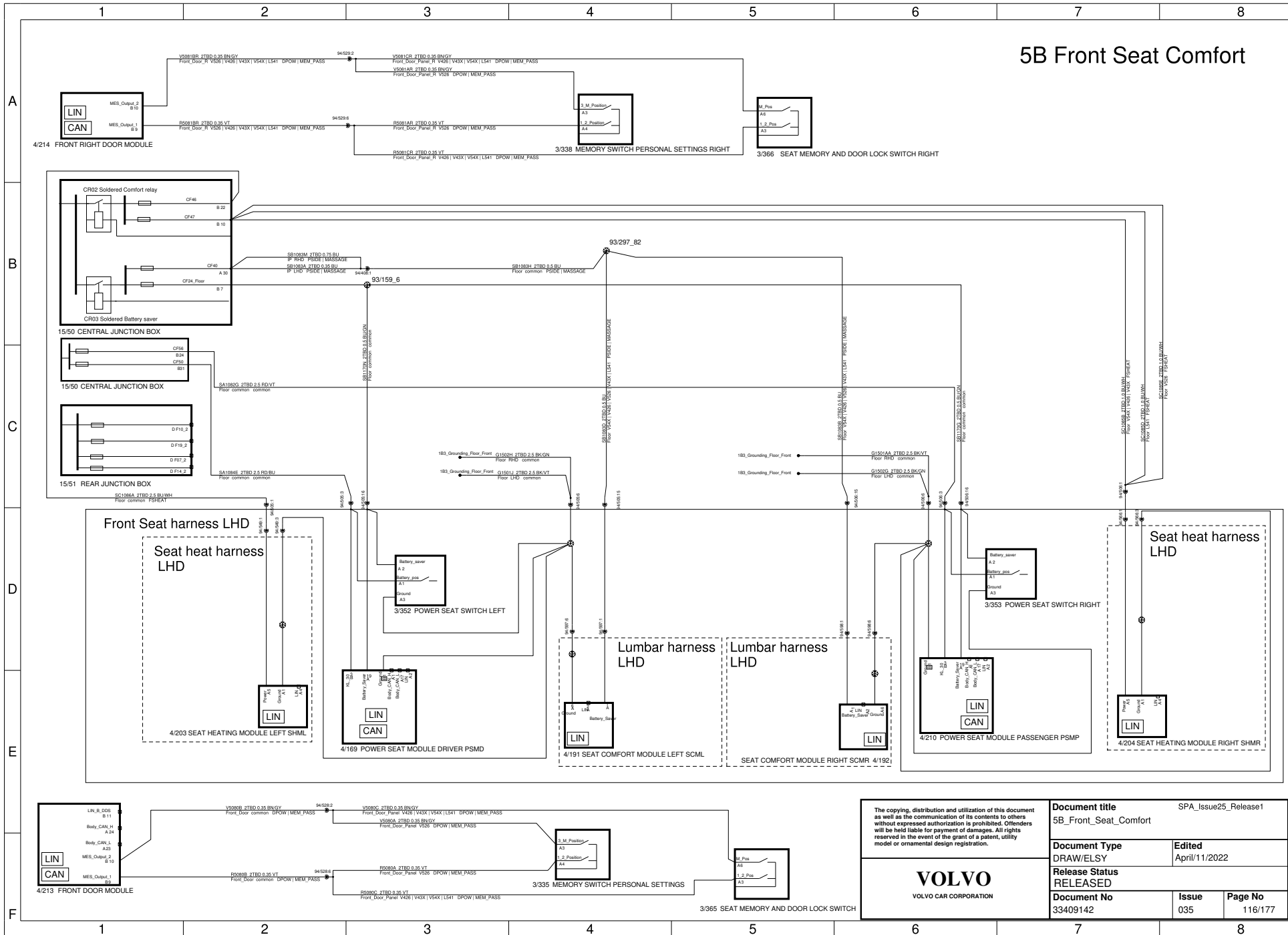

<p>The copying, distribution and utilization of this document as well as the communication of its contents to others without expressed authorization is prohibited. Offenders will be held liable for payment of damages. All rights reserved in the event of the grant of a patent, utility model or ornamental design registration.</p> <p><b>VOLVO</b> VOLVO CAR CORPORATION</p>	<p><b>Document title</b> SPA_Issue25_Release1 5B_Front_Seat_Comfort</p>
	<p><b>Document Type</b> Edited DRAW/ELSY April/11/2022</p>
	<p><b>Release Status</b> RELEASED</p>
<p><b>Document No</b> 33409142</p>	<p><b>Issue</b> 035</p>
	<p><b>Page No</b> 116/177</p>



# 5B Rear Seat Comfort V526

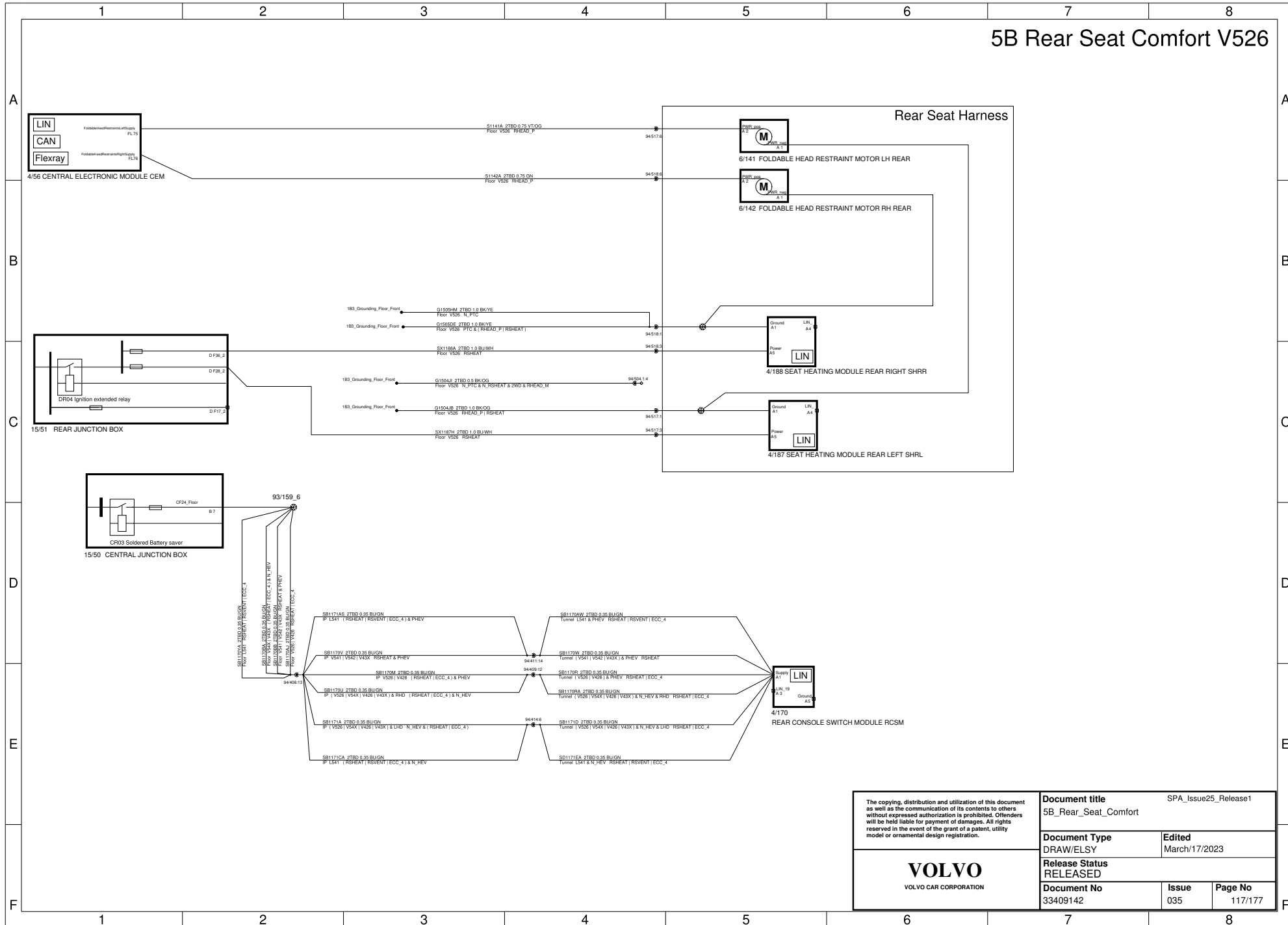

<p>The copying, distribution and utilization of this document as well as the communication of its contents to others without expressed authorization is prohibited. Offenders will be held liable for payment of damages. All rights reserved in the event of the grant of a patent, utility model or ornamental design registration.</p> <p><b>VOLVO</b> VOLVO CAR CORPORATION</p>		<p><b>Document title</b> SPA_Issue25_Release1 5B_Rear_Seat_Comfort</p>	
		<p><b>Document Type</b> DRAW/ELSY</p>	<p><b>Edited</b> March/17/2023</p>
<p><b>Release Status</b> RELEASED</p>			
<p><b>Document No</b> 33409142</p>	<p><b>Issue</b> 035</p>	<p><b>Page No</b> 117/177</p>	



# 5B Rear Seat Comfort L541

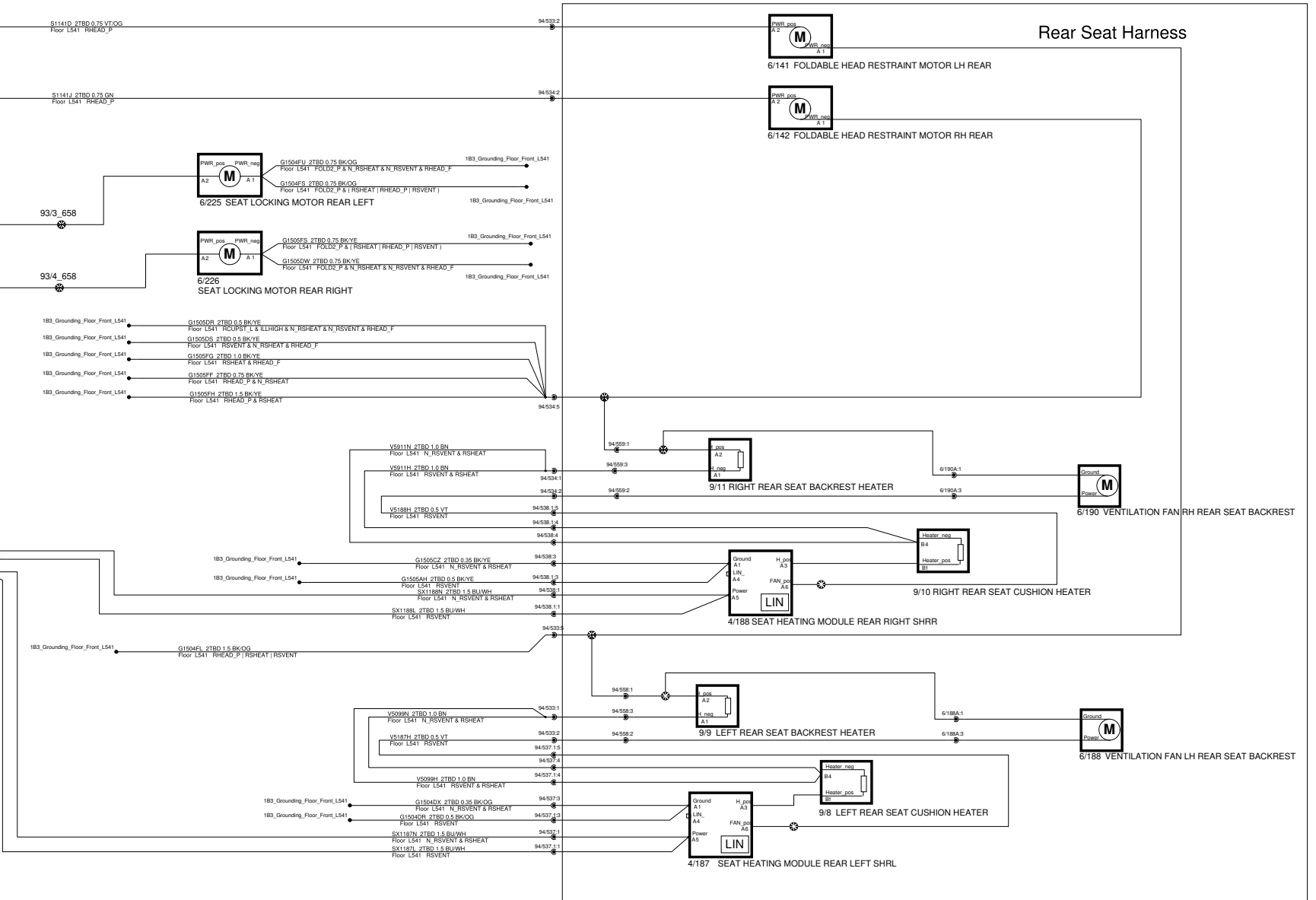
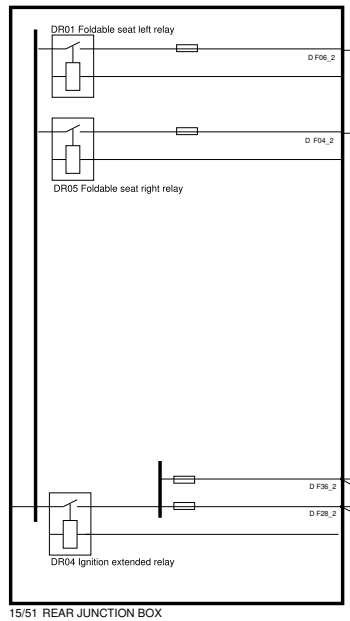
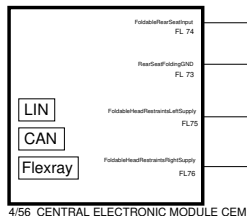

The copying, distribution and utilization of this document as well as the communication of its contents to others without expressed authorization is prohibited. Offenders will be held liable for payment of damages. All rights reserved in the event of the grant of a patent, utility model or ornamental design registration.



Document title		SPA_Issue25_Release1	
5B_Rear_Seat_Comfort_L541			
Document Type	DRAW/ELSY	Edited	April/06/2023
Release Status	RELEASED		
Document No	33409142	Issue	035
		Page No	118/177

# 5B Rear Seat Comfort V54X V43X V426

A  
B  
C  
D  
E  
F

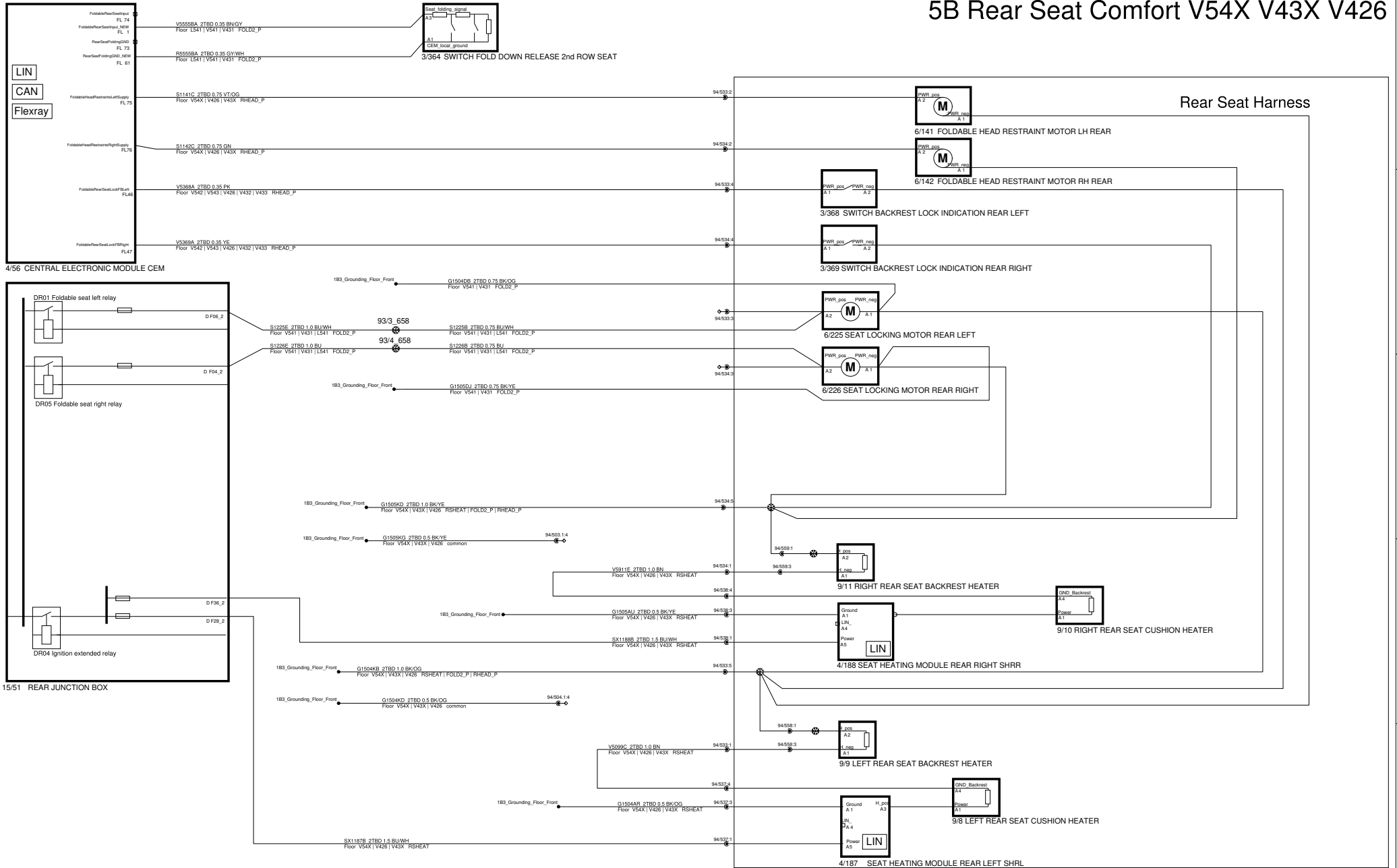

<p>The copying, distribution and utilization of this document as well as the communication of its contents to others without expressed authorization is prohibited. Offenders will be held liable for payment of damages. All rights reserved in the event of the grant of a patent, utility model or ornamental design registration.</p>		<p>Document title SPA_Issue25_Release1</p>	
		<p>5B_Rear_Seat_Comfort_V54X_V43X_V426</p>	
<p>Document Type DRAW/ELSY</p>		<p>Edited April/06/2023</p>	
<p>Release Status RELEASED</p>			
<p>Document No 33409142</p>		<p>Issue 035</p>	<p>Page No 119/177</p>



VOLVO CAR CORPORATION





# 5F1 Passenger Compartment Pre-Conditioning

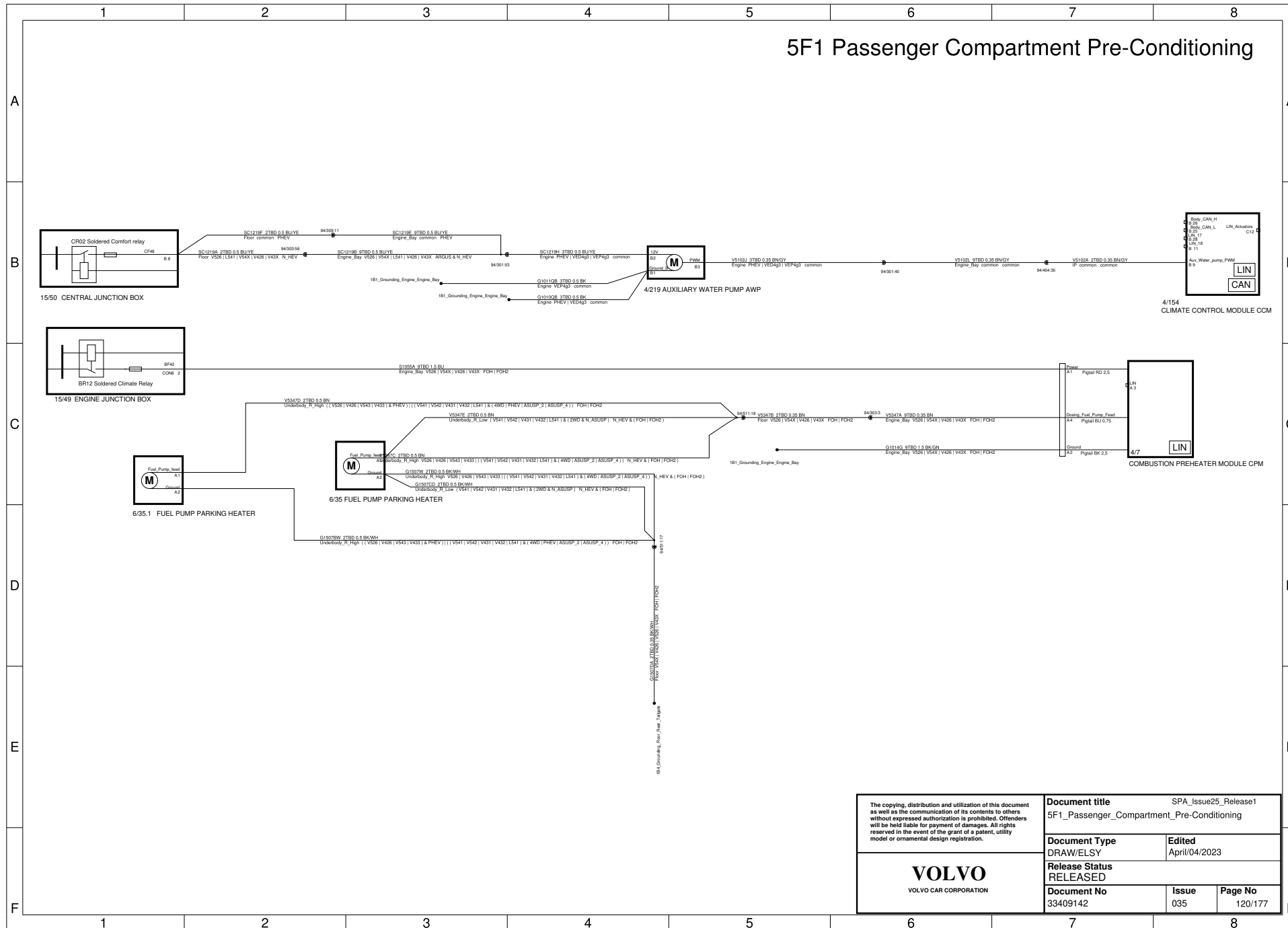

<p>The copying, distribution and utilization of this document as well as the communication of its contents to others without expressed authorization is prohibited. Offenders will be held liable for payment of damages. All rights reserved in the event of the grant of a patent, utility model or ornamental design registration.</p> <p><b>VOLVO</b> VOLVO CAR CORPORATION</p>	<b>Document title</b> SPA_Issue25_Release1 5F1_Passenger_Compartment_Pre-Conditioning	
	<b>Document Type</b> DRAW/ELSY	<b>Edited</b> April/04/2023
	<b>Release Status</b> RELEASED	
	<b>Document No</b> 33409142	<b>Issue</b> 035

# 5G Steering Wheel Heating

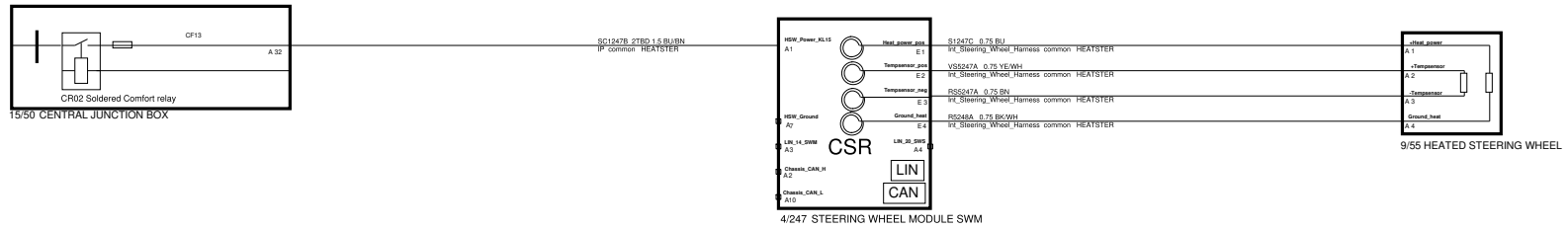

<p>The copying, distribution and utilization of this document as well as the communication of its contents to others without expressed authorization is prohibited. Offenders will be held liable for payment of damages. All rights reserved in the event of the grant of a patent, utility model or ornamental design registration.</p> <p><b>VOLVO</b> VOLVO CAR CORPORATION</p>	<b>Document title</b> SPA_Issue25_Release1 5G_Steering_Wheel_Heating	
	<b>Document Type</b> DRAW/ELSY	<b>Edited</b> June/16/2021
	<b>Release Status</b> RELEASED	
	<b>Document No</b> 33409142	<b>Issue</b> 035



# 6A Locking

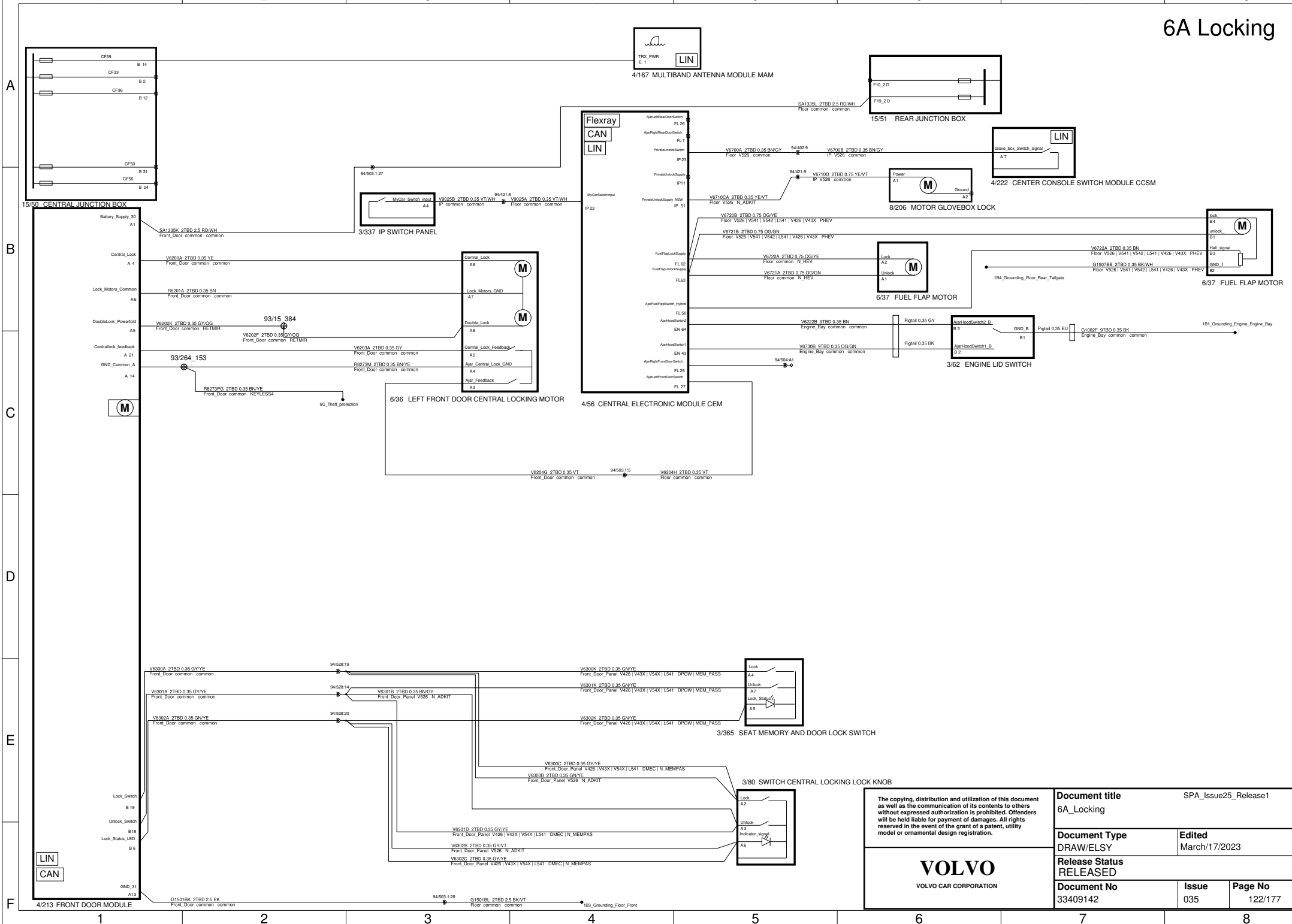

<p>The copying, distribution and utilization of this document as well as the communication of its contents to others without expressed authorization is prohibited. Offenders will be held liable for payment of damages. All rights reserved in the event of the grant of a patent, utility model or ornamental design registration.</p>		<b>Document title</b> SPA_Issue25_Release1	
		<b>Document Type</b> DRAW/ELSY	
<p><b>VOLVO</b> VOLVO CAR CORPORATION</p>		<b>Edited</b> March/17/2023	
		<b>Release Status</b> RELEASED	
<b>Document No</b> 33409142	<b>Issue</b> 035	<b>Page No</b> 122/177	

# 6A Locking Rear

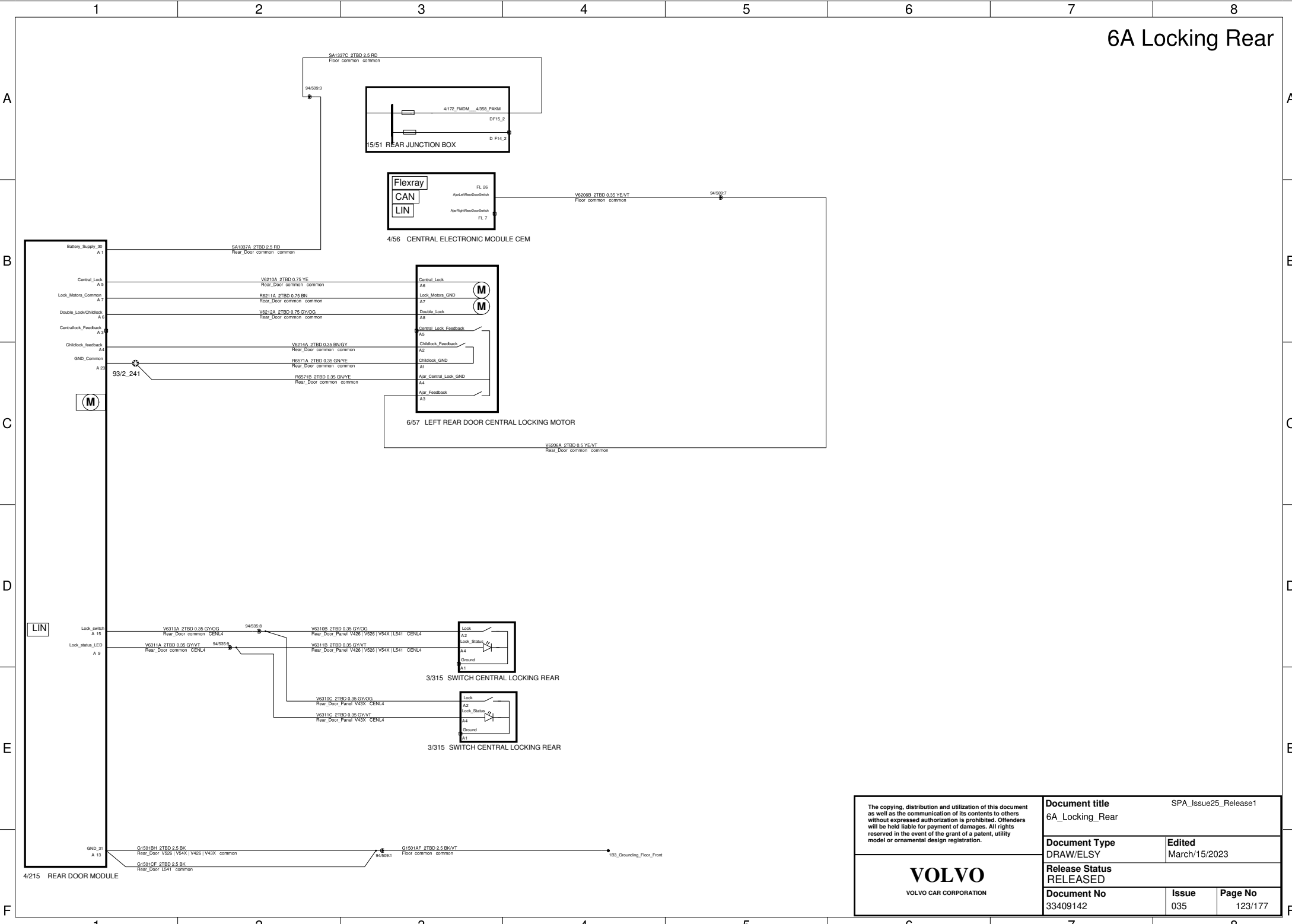

The copying, distribution and utilization of this document as well as the communication of its contents to others without expressed authorization is prohibited. Offenders will be held liable for payment of damages. All rights reserved in the event of the grant of a patent, utility model or ornamental design registration.		<b>Document title</b> 6A_Locking_Rear		SPA_Issue25_Release1	
		<b>Document Type</b> DRAW/ELSY	<b>Edited</b> March/15/2023		
<b>VOLVO</b> VOLVO CAR CORPORATION		<b>Release Status</b> RELEASED			
		<b>Document No</b> 33409142	<b>Issue</b> 035	<b>Page No</b> 123/177	



# 6C Theft Protection

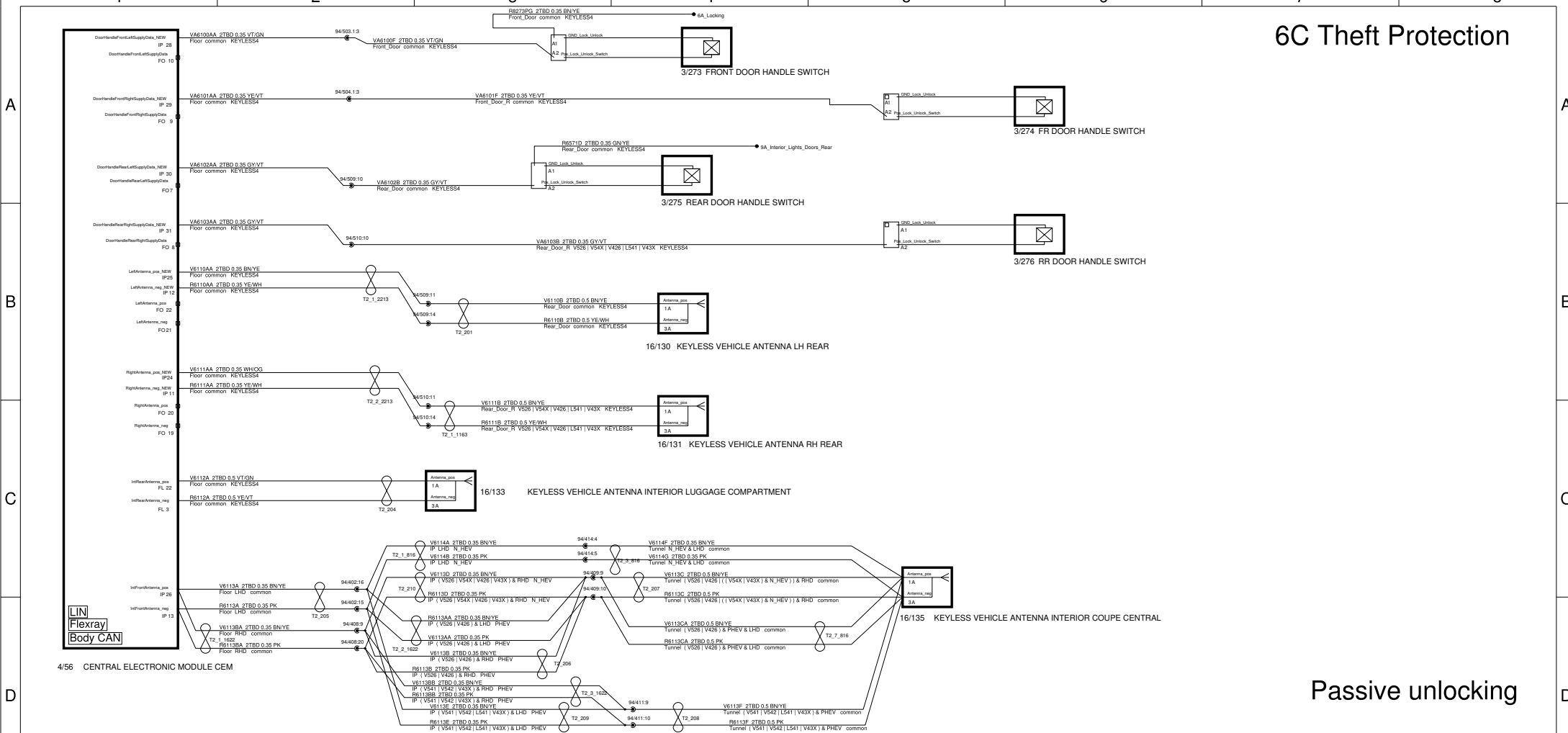

## Passive unlocking

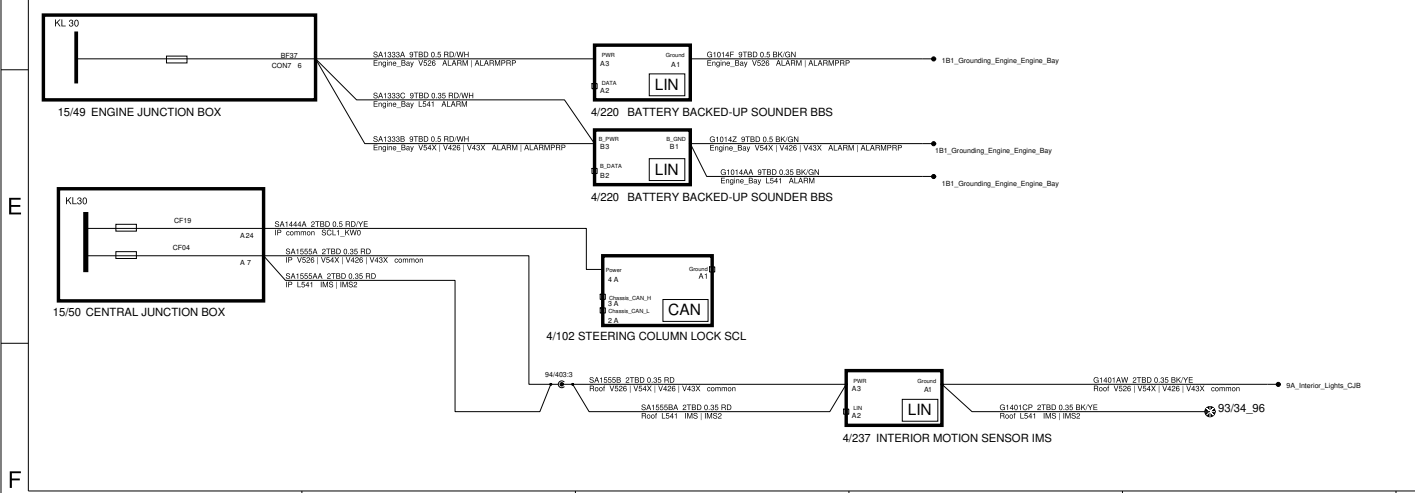

The copying, distribution and utilization of this document as well as the communication of its contents to others without expressed authorization is prohibited. Offenders will be held liable for payment of damages. All rights reserved in the event of the grant of a patent, utility model or ornamental design registration.		<b>Document title</b> SPA_Issue25_Release1	
<b>Document Type</b> DRAW/ELSY		<b>Edited</b> March/20/2023	
<b>Release Status</b> RELEASED		<b>Document No</b> 33409142	
<b>Issue</b> 035		<b>Page No</b> 124/177	



# 6D Window manoeuvring Left 6E Mirror manoeuvring Left

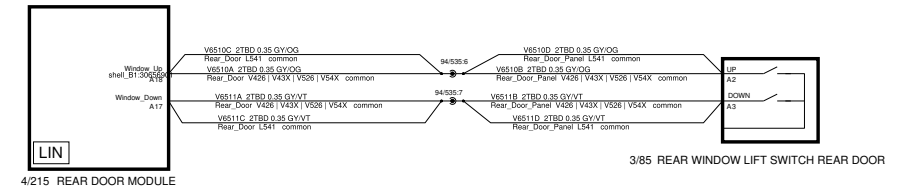
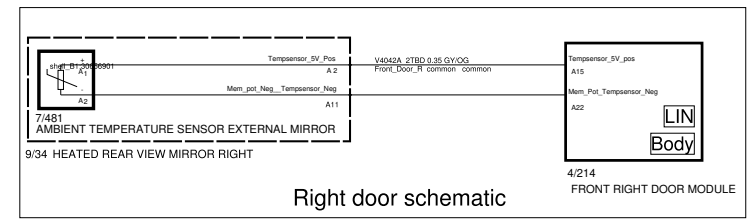
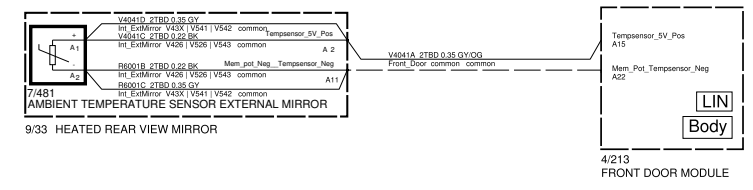
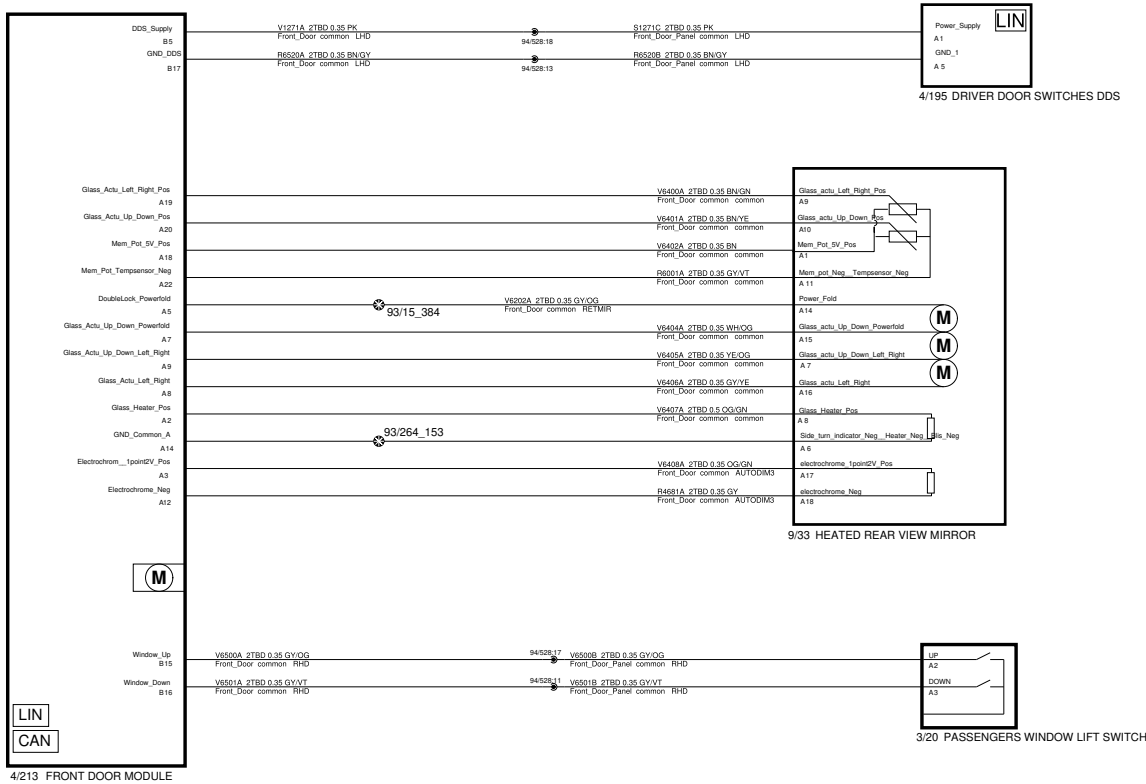

<p>The copying, distribution and utilization of this document as well as the communication of its contents to others without expressed authorization is prohibited. Offenders will be held liable for payment of damages. All rights reserved in the event of the grant of a patent, utility model or ornamental design registration.</p> <p><b>VOLVO</b> VOLVO CAR CORPORATION</p>	<p><b>Document title</b> SPA_Issue25_Release1</p> <p><b>6D_Window_Manoeuvring</b></p>	
	<p><b>Document Type</b> DRAW/ELSY</p>	<p><b>Edited</b> March/15/2023</p>
	<p><b>Release Status</b> RELEASED</p>	
	<p><b>Document No</b> 33409142</p>	<p><b>Issue</b> 035</p>

# 6D Window manoeuvring Right 6E Mirror manoeuvring Right

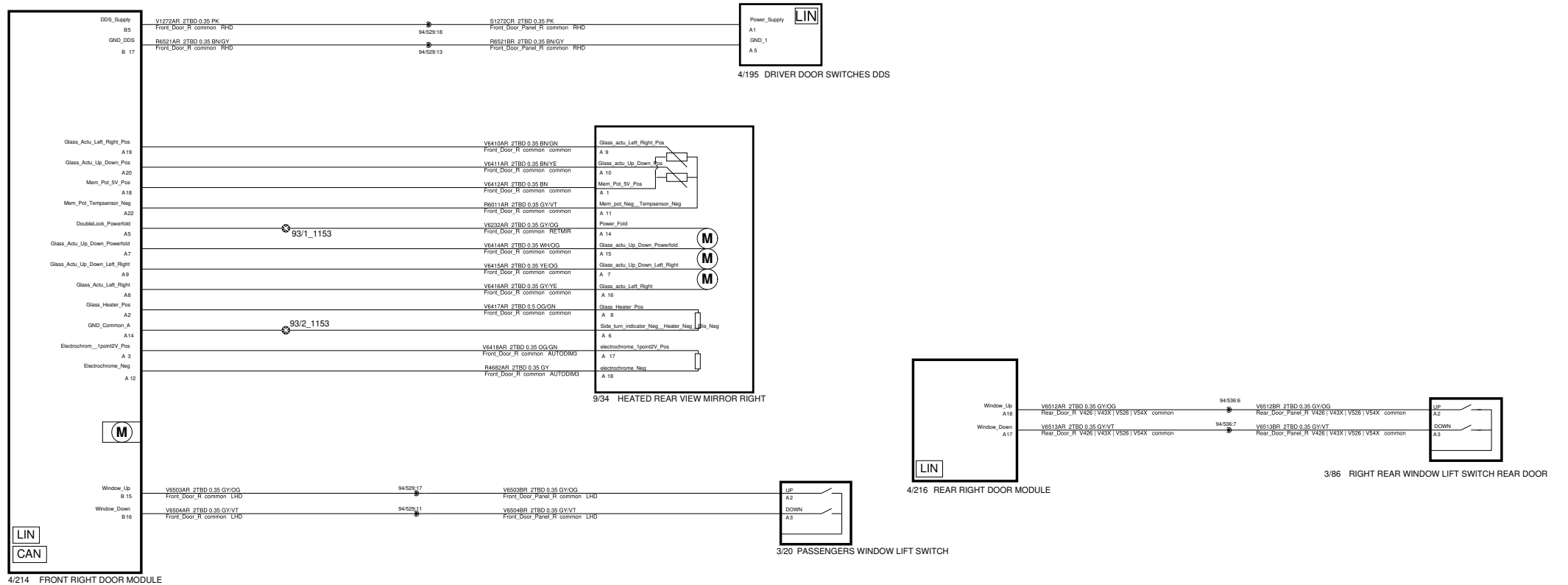

<p>The copying, distribution and utilization of this document as well as the communication of its contents to others without expressed authorization is prohibited. Offenders will be held liable for payment of damages. All rights reserved in the event of the grant of a patent, utility model or ornamental design registration.</p>		<p><b>Document title</b> SPA_Issue25_Release1 6D_Window_Manoevring_Right</p>	
		<p><b>Document Type</b> DRAW/ELSY</p>	<p><b>Edited</b> March/15/2023</p>
<p><b>VOLVO</b> VOLVO CAR CORPORATION</p>		<p><b>Release Status</b> RELEASED</p>	
		<p><b>Document No</b> 33409142</p>	<p><b>Issue</b> 035</p>
		<p><b>Page No</b> 126/177</p>	

# 6F Roof Manoeuvring

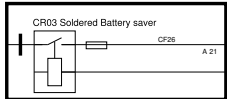

15/50 CENTRAL JUNCTION BOX

A

B

C

D

E

F

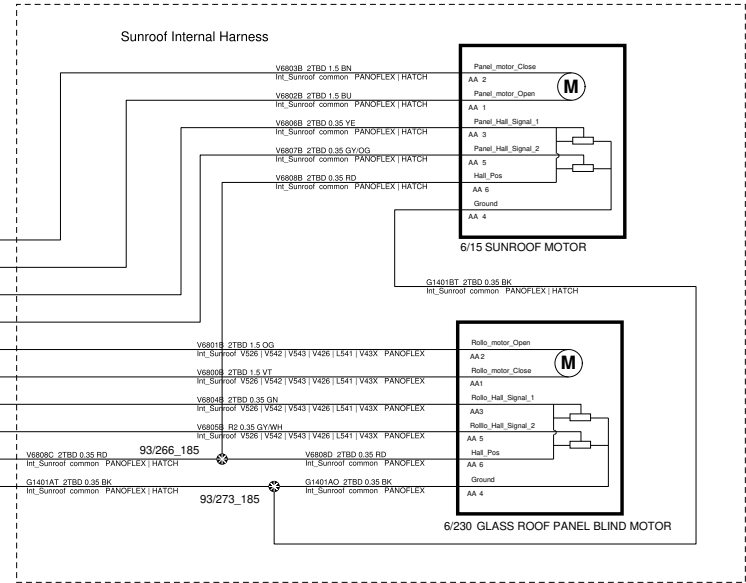
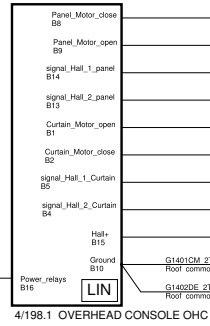

The copying, distribution and utilization of this document as well as the communication of its contents to others without expressed authorization is prohibited. Offenders will be held liable for payment of damages. All rights reserved in the event of the grant of a patent, utility model or ornamental design registration.	<b>Document title</b> SPA_Issue25_Release1 6F1_001_Roof_Manoeuvring	
	<b>Document Type</b> DRAW/ELSY	<b>Edited</b> January/20/2022
	<b>Release Status</b> RELEASED	
	<b>Document No</b> 33409142	<b>Issue</b> 035





# 6K Tailgate & boot lid manoeuvring 6N Luggage concealing

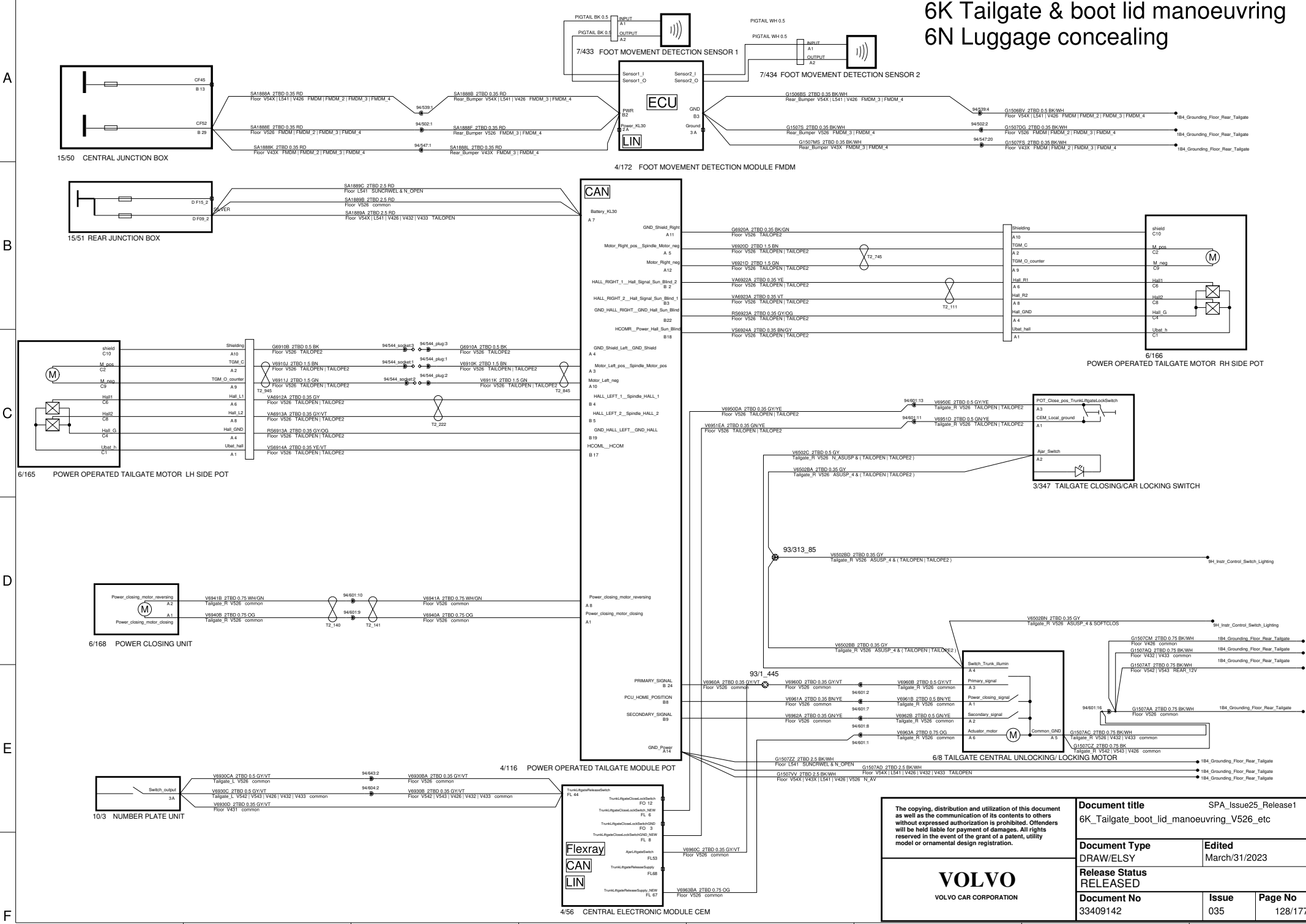

The copying, distribution and utilization of this document as well as the communication of its contents to others without expressed authorization is prohibited. Offenders will be held liable for payment of damages. All rights reserved in the event of the grant of a patent, utility model or ornamental design registration.		Document title SPA_Issue25_Release1 6K_Tailgate_boot_lid_manoeuvring_V526_etc	
Document Type DRAW/ELSY		Edited March/31/2023	
Release Status RELEASED			
Document No 33409142	Issue 035	Page No 128/177	



# 6K Tailgate & boot lid manoeuvring V541, V431 and L541

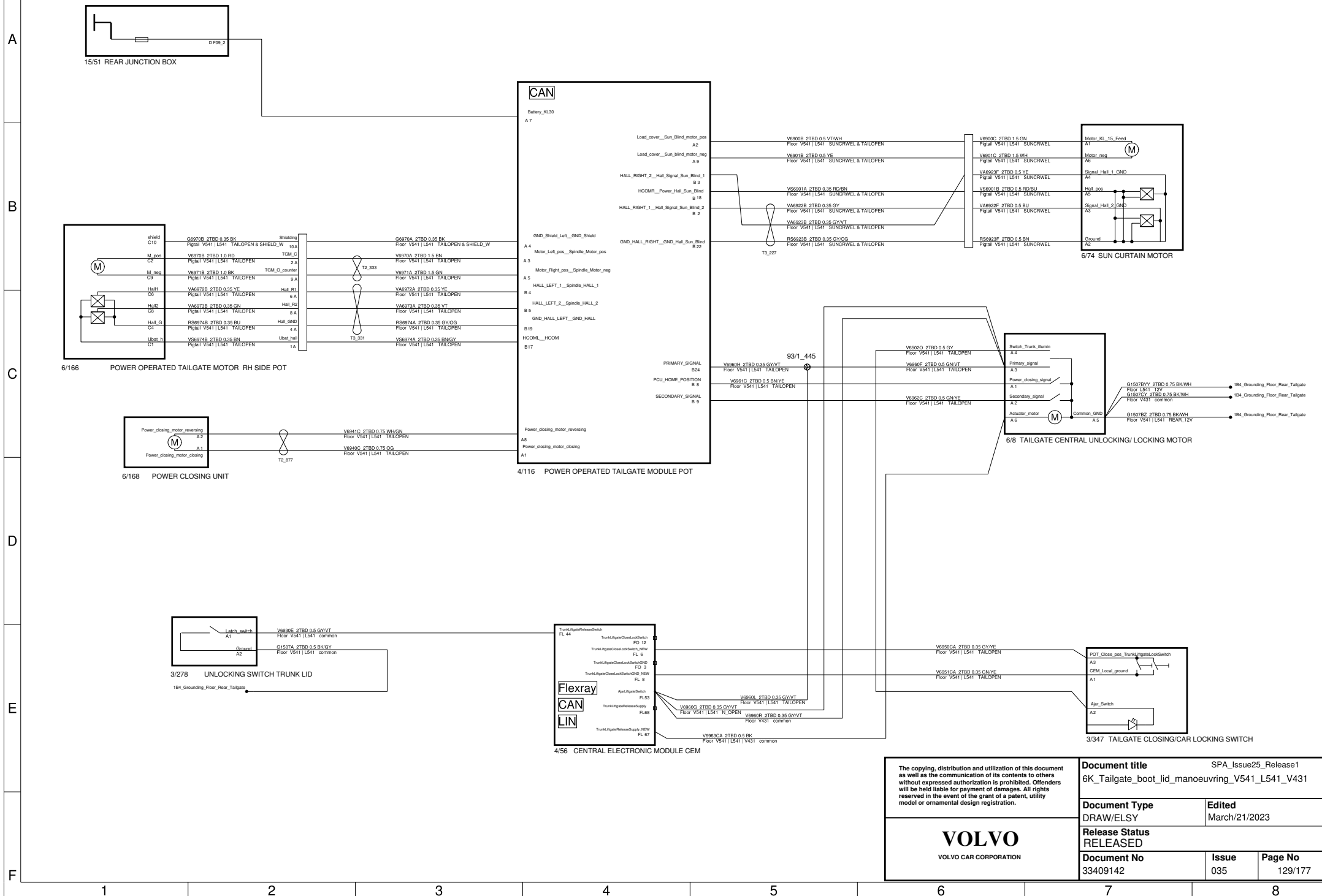

The copying, distribution and utilization of this document as well as the communication of its contents to others without expressed authorization is prohibited. Offenders will be held liable for payment of damages. All rights reserved in the event of the grant of a patent, utility model or ornamental design registration.

**VOLVO**  
VOLVO CAR CORPORATION

<b>Document title</b> 6K_Tailgate_boot_lid_manoeuvring_V541_L541_V431		SPA_Issue25_Release1	
<b>Document Type</b> DRAW/ELSY	<b>Edited</b> March/21/2023		
<b>Release Status</b> RELEASED			
<b>Document No</b> 33409142	<b>Issue</b> 035	<b>Page No</b> 129/177	

# 6K Tailgate & boot lid manoeuvring V542/V543, V432/433 and V426

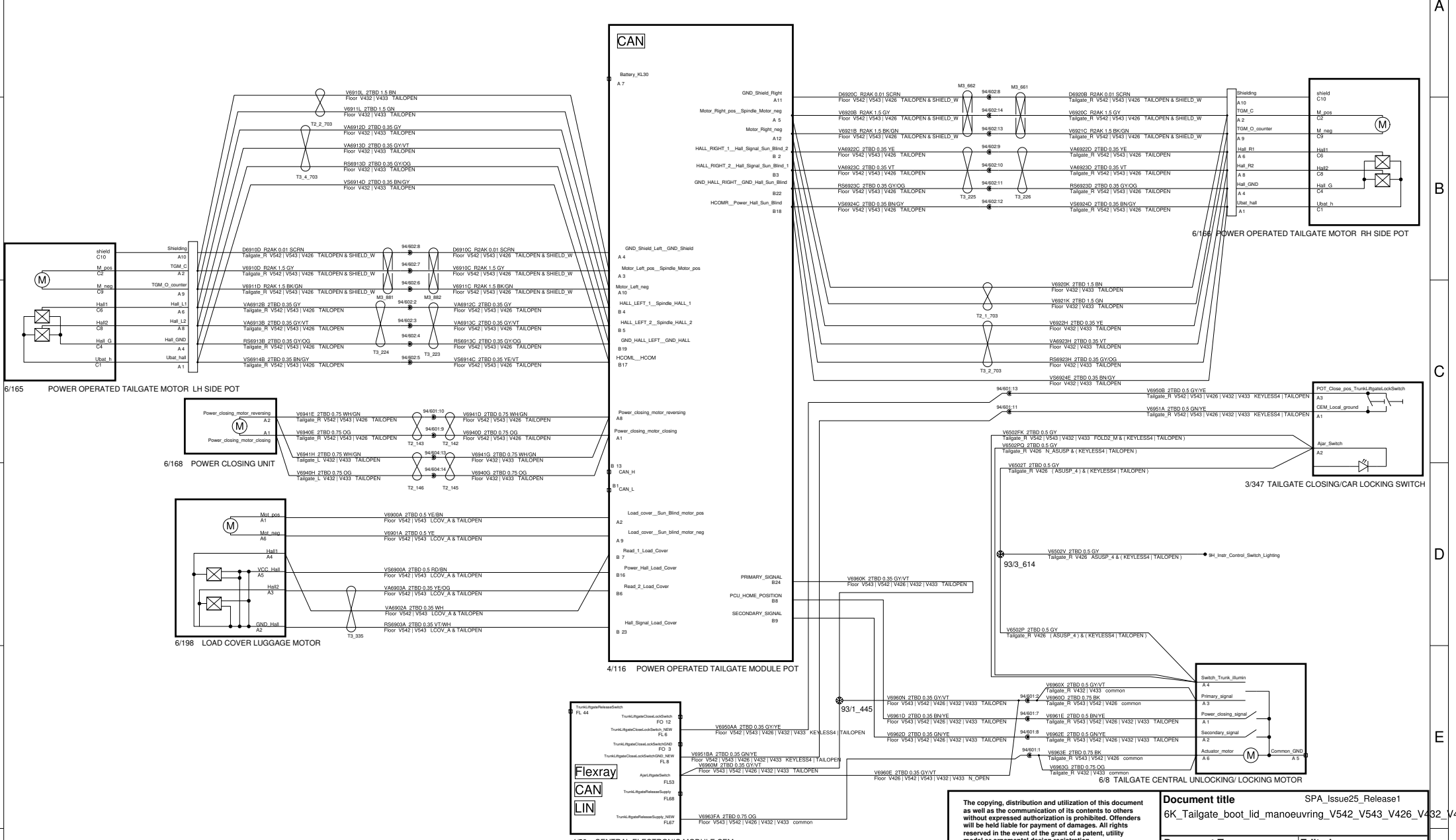

The copying, distribution and utilization of this document as well as the communication of its contents to others without expressed authorization is prohibited. Offenders will be held liable for payment of damages. All rights reserved in the event of the grant of a patent, utility model or ornamental design registration.

Document title SPA\_Issue25\_Release1  
6K\_Tailgate\_boot\_lid\_manoeuvring\_V542\_V543\_V426\_V432\_V433

Document Type Edited  
DRAW/ELSY March/17/2023

Release Status  
RELEASED

Document No Issue Page No  
33409142 035 130/177



# 6P Voltage Outlet

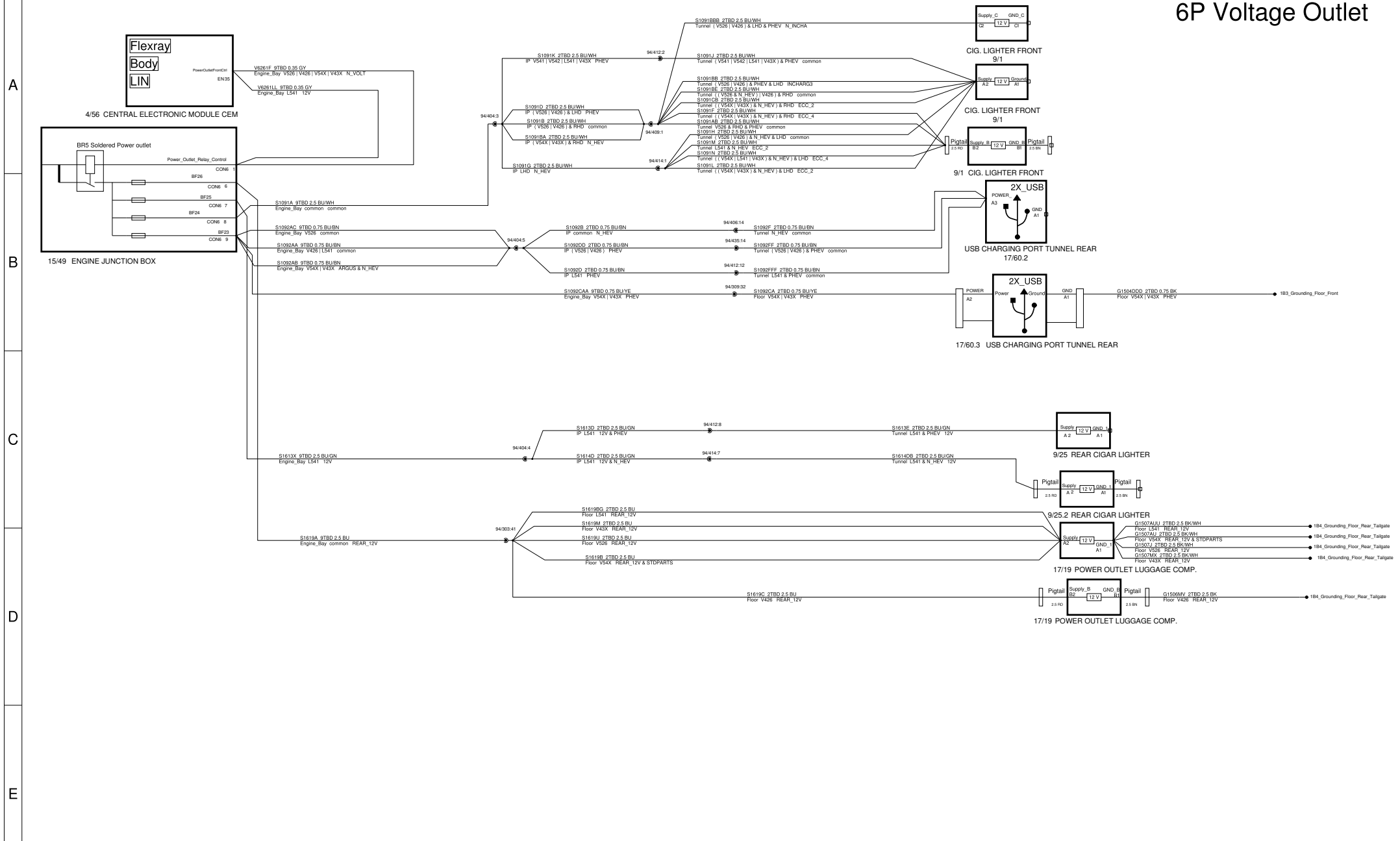

 VOLVO CAR CORPORATION	<b>Document title</b> SPA_Issue25_Release1 6P_001_Voltage_outlet	
	<b>Document Type</b> DRAW/ELSY	<b>Edited</b> October/05/2022
	<b>Release Status</b> RELEASED	
	<b>Document No</b> 33409142	<b>Issue</b> 035 <b>Page No</b> 131/177



# 7A Infotainment IHU 4.0, iCUP

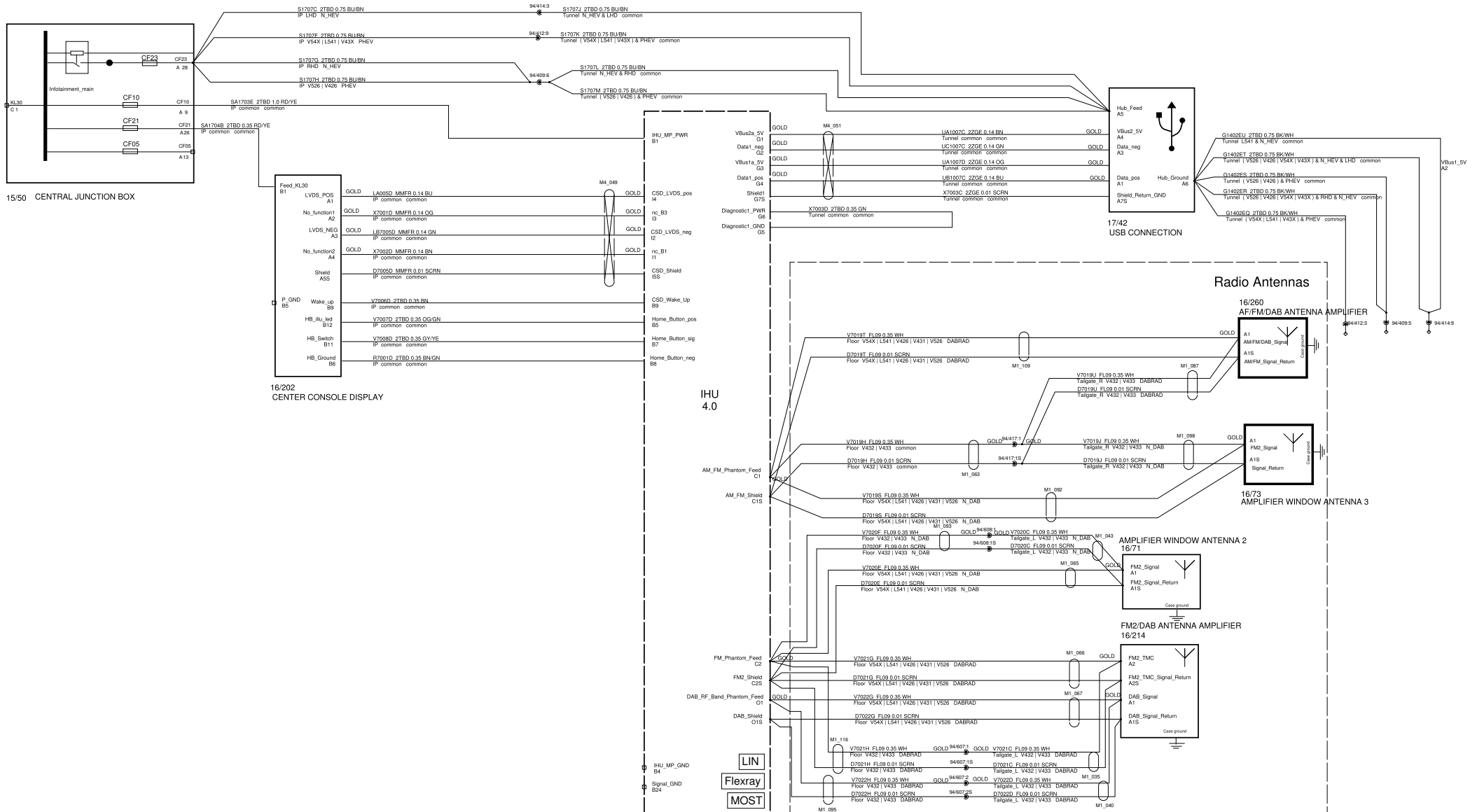

4/185.1  
INFOTAINMENT HEAD UNIT IHU

<p>The copying, distribution and utilization of this document as well as the communication of its contents to others without expressed authorization is prohibited. Offenders will be held liable for payment of damages. All rights reserved in the event of the grant of a patent, utility model or ornamental design registration.</p>		<p>Document title SPA_Issue25_Release1 7A_001C_Infotainment_40_iCUP</p>	
		<p>Document Type DRAW/ELSY</p>	<p>Edited January/12/2022</p>
<p><b>VOLVO</b> VOLVO CAR CORPORATION</p>		<p>Release Status RELEASED</p>	
		<p>Document No 33409142</p>	<p>Issue 035 Page No 132/177</p>

# 7A Infotainment Ethernet & Internet

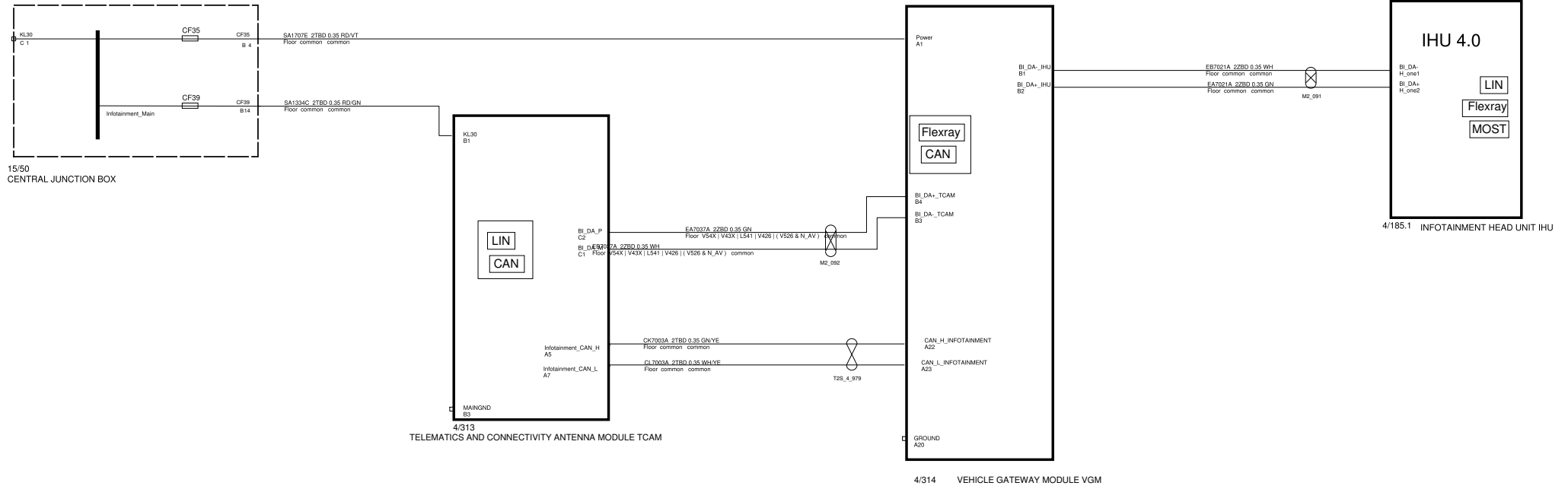

<p>The copying, distribution and utilization of this document as well as the communication of its contents to others without expressed authorization is prohibited. Offenders will be held liable for payment of damages. All rights reserved in the event of the grant of a patent, utility model or ornamental design registration.</p> <p><b>VOLVO</b> VOLVO CAR CORPORATION</p>	<p><b>Document title</b> SPA_Issue25_Release1 7A_001H_Infotainment_Ethernet_Internet_iCUP</p>		
	<p><b>Document Type</b> DRAW/ELSY</p>	<p><b>Edited</b> April/20/2023</p>	
	<p><b>Release Status</b> RELEASED</p>		
	<p><b>Document No</b> 33409142</p>	<p><b>Issue</b> 035</p>	<p><b>Page No</b> 133/177</p>

# 7A External Amplifier Audio 2

## CI 90 High Performance

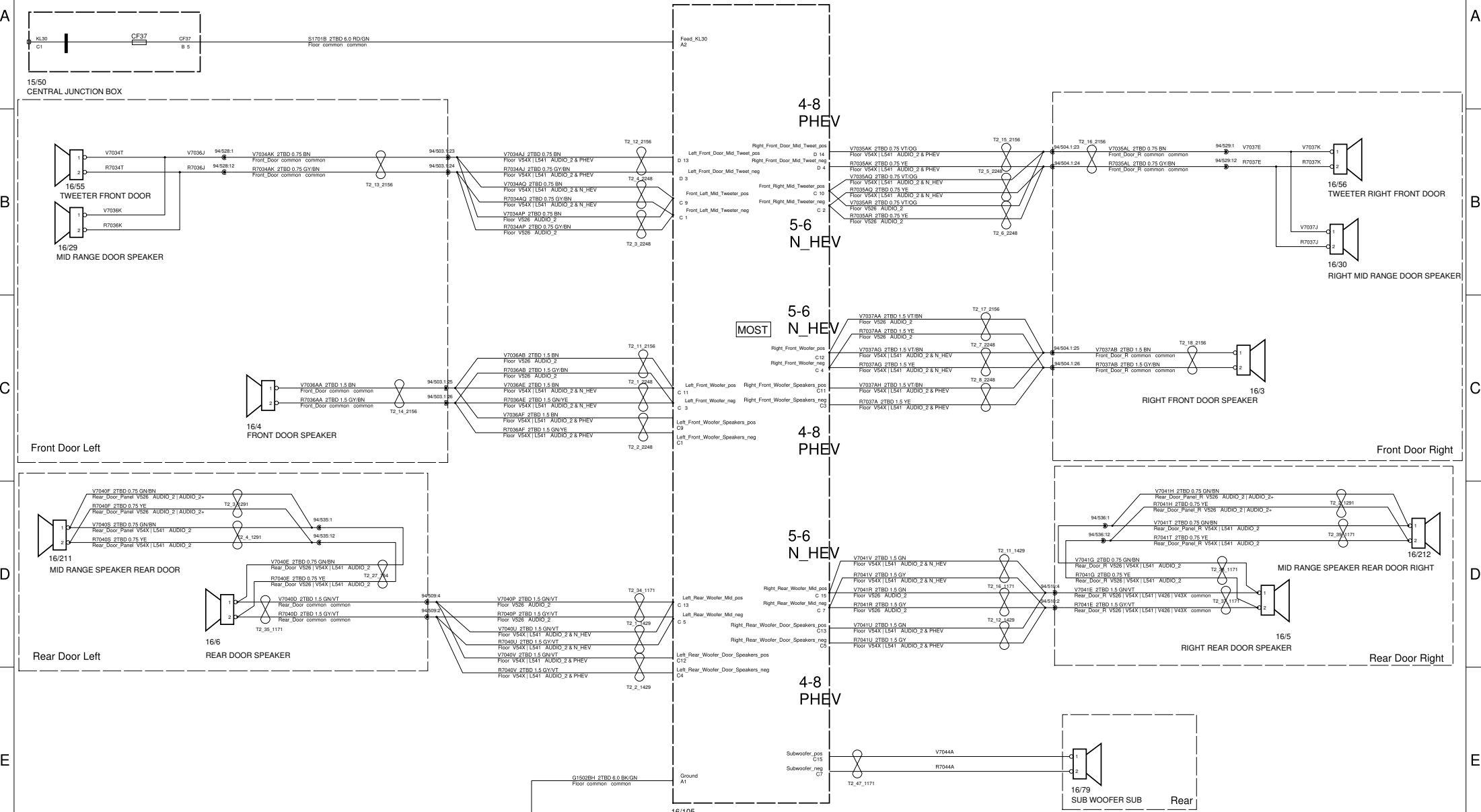

<p>The copying, distribution and utilization of this document as well as the communication of its contents to others without expressed authorization is prohibited. Offenders will be held liable for payment of damages. All rights reserved in the event of the grant of a patent, utility model or ornamental design registration.</p>		<p>Document title SPA_Issue25_Release1</p>	
		<p>7A_002B_External_Amplifier_Audio2_CL90</p>	
<p>Document Type DRAW/ELSY</p>		<p>Edited May/24/2022</p>	
<p>Release Status RELEASED</p>			
<p>Document No 33409142</p>	<p>Issue 035</p>	<p>Page No 134/177</p>	



VOLVO CAR CORPORATION

# 7A External Amplifier Audio 2+ CL90 High Performance pro

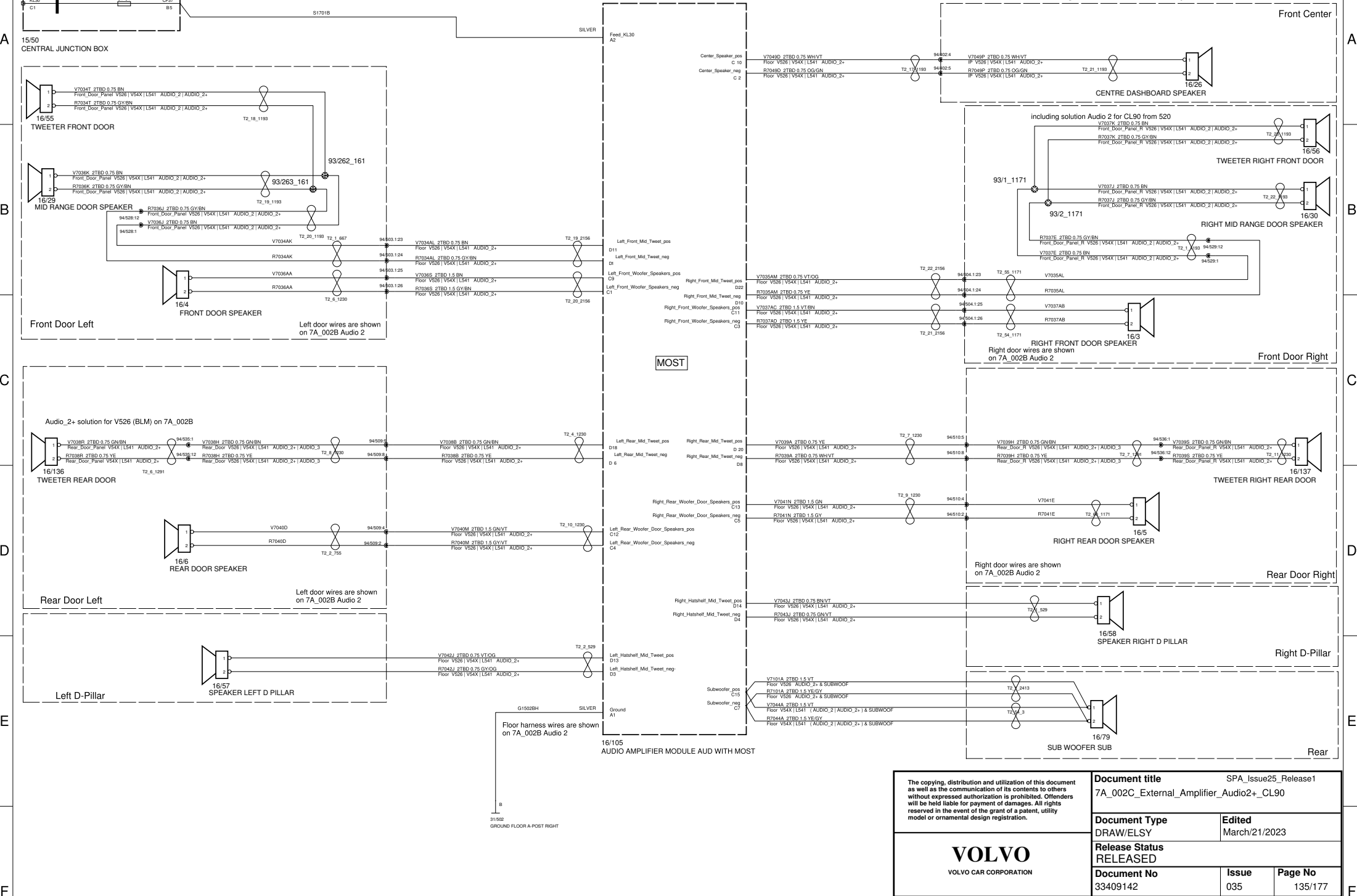

<p>The copying, distribution and utilization of this document as well as the communication of its contents to others without expressed authorization is prohibited. Offenders will be held liable for payment of damages. All rights reserved in the event of the grant of a patent, utility model or ornamental design registration.</p>		<p>Document title SPA_Issue25_Release1</p>	
		<p>7A_002C_External_Amplifier_Audio2+_CL90</p>	
<p>Document Type DRAW/ELSY</p>		<p>Issued March/21/2023</p>	
<p>Release Status RELEASED</p>			
<p>Document No 33409142</p>		<p>Issue 035</p>	<p>Page No 135/177</p>





# 7A External Amplifier Audio 3 Premium Audio

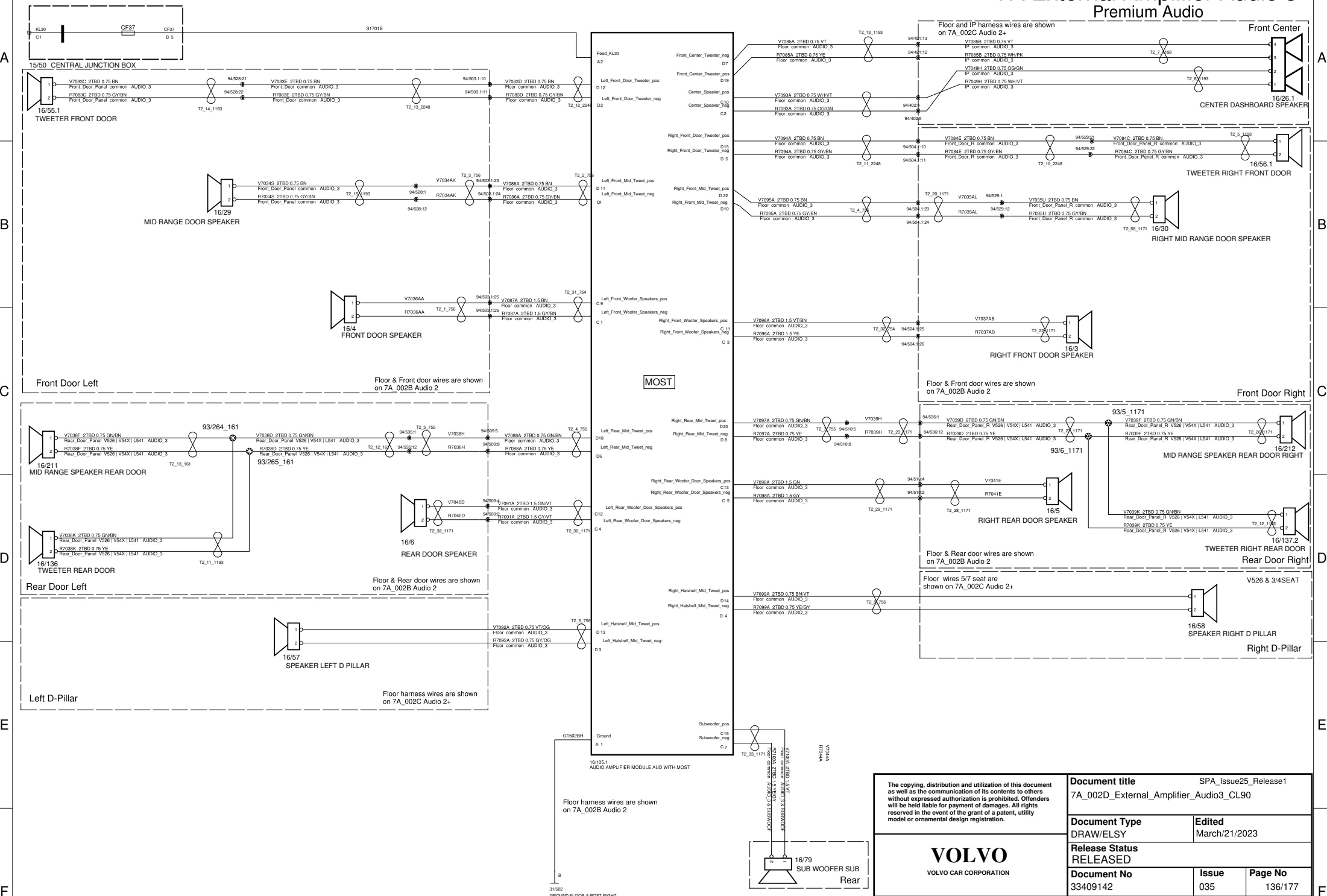

<p>The copying, distribution and utilization of this document as well as the communication of its contents to others without expressed authorization is prohibited. Offenders will be held liable for payment of damages. All rights reserved in the event of the grant of a patent, utility model or ornamental design registration.</p>		<p>Document title SPA_Issue25_Release1 7A_002D_External_Amplifier_Audio3_CL90</p>	
		<p>Document Type DRAW/ELSY</p>	<p>Issued March/21/2023</p>
<p>Release Status RELEASED</p>		<p>Document No 33409142</p>	
<p>Issue 035</p>		<p>Page No 136/177</p>	

**VOLVO**  
VOLVO CAR CORPORATION

# 7A External Amplifier CL60

## Audio2 | Audio2+

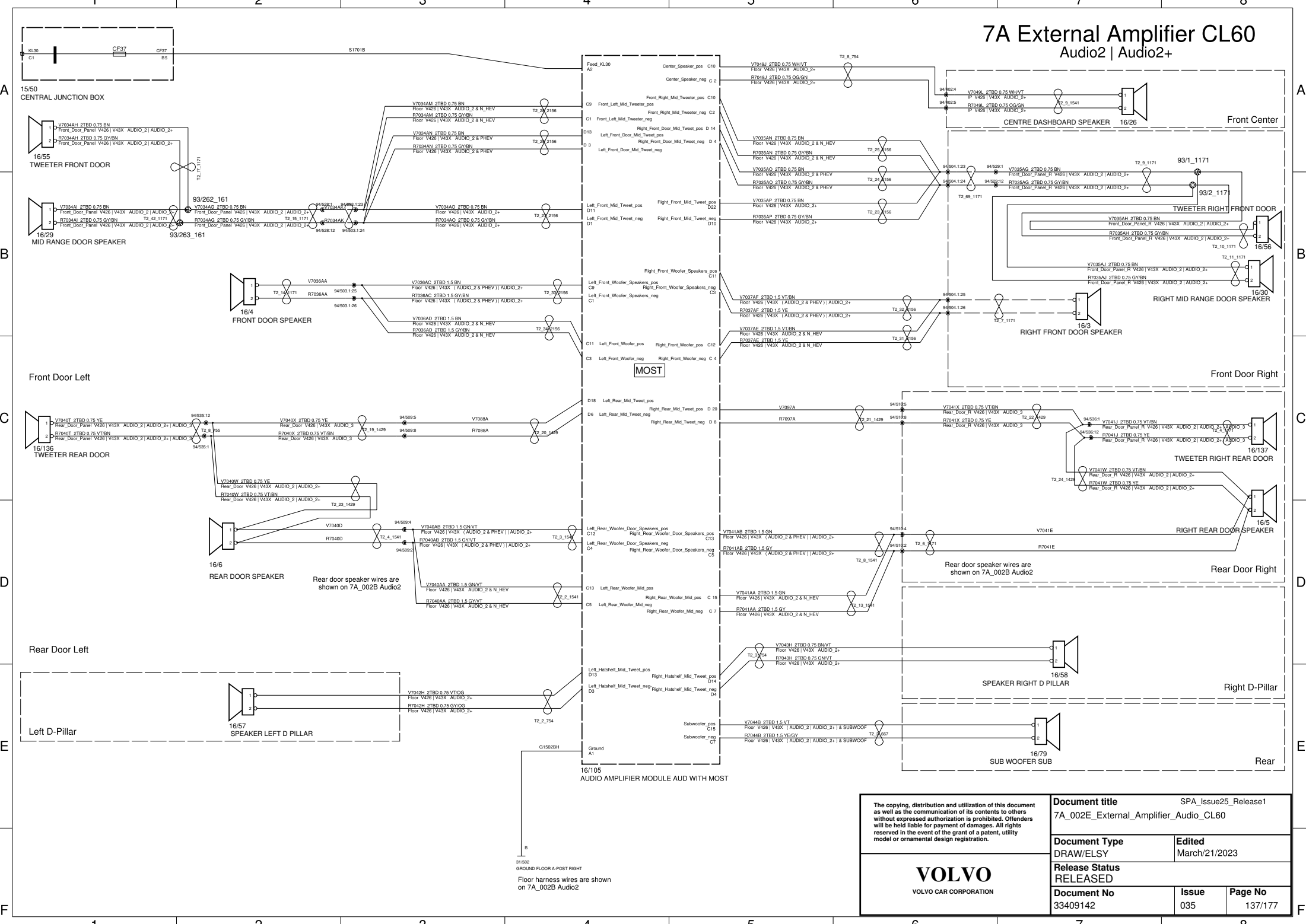

<p>The copying, distribution and utilization of this document as well as the communication of its contents to others without expressed authorization is prohibited. Offenders will be held liable for payment of damages. All rights reserved in the event of the grant of a patent, utility model or ornamental design registration.</p>		<p>Document title SPA_Issue25_Release1</p>	
		<p>7A_002E_External_Amplifier_Audio_CL60</p>	
<p>Document Type</p>	<p>Draw/ELSY</p>		<p>Edited</p>
<p>Release Status</p>	<p>RELEASED</p>		
<p>Document No</p>	<p>33409142</p>	<p>Issue</p>	<p>Page No</p>
		<p>035</p>	<p>137/177</p>



VOLVO CAR CORPORATION

31/502  
GROUND FLOOR A-POST RIGHT  
Floor harness wires are shown on 7A\_002B Audio2

# 7B Telematics CL90 From 519A ROW

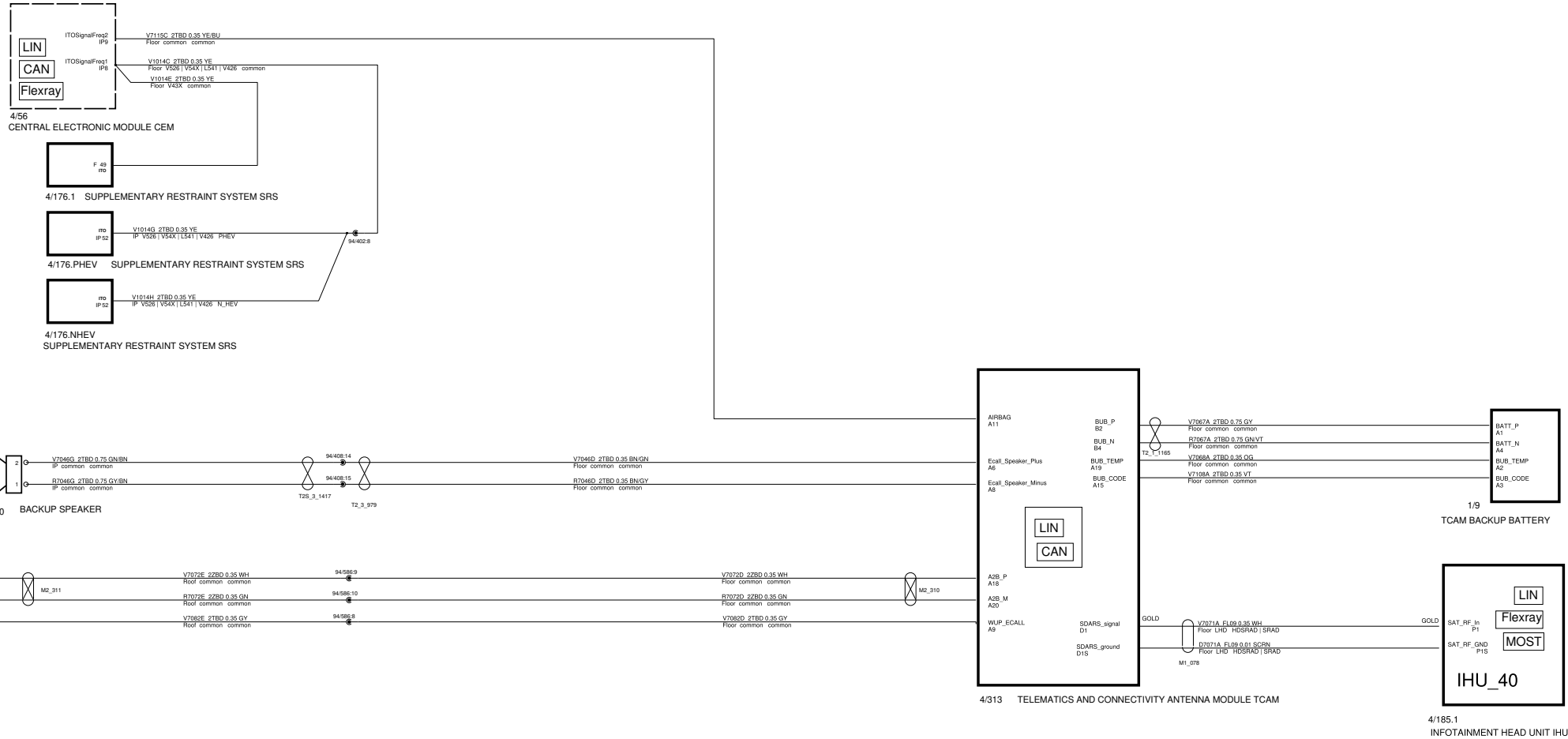

<p>The copying, distribution and utilization of this document as well as the communication of its contents to others without expressed authorization is prohibited. Offenders will be held liable for payment of damages. All rights reserved in the event of the grant of a patent, utility model or ornamental design registration.</p> <p><b>VOLVO</b> VOLVO CAR CORPORATION</p>	<p><b>Document title</b> SPA_Issue25_Release1 7B_001C_Telematics_TCAM</p>	
	<p><b>Document Type</b> DRAW/ELSY</p>	<p><b>Edited</b> December/22/2021</p>
	<p><b>Release Status</b> RELEASED</p>	
	<p><b>Document No</b> 33409142</p>	<p><b>Issue</b> 035</p>

# 7B Telematics Digital Microphones

IHU 3.2 from V526/V54x/V426/V43x 18w17 L2  
 IHU 4.0 from 519G | 21w17

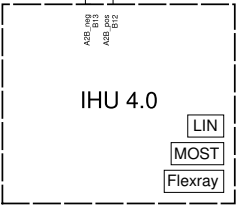
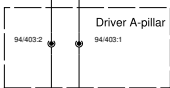
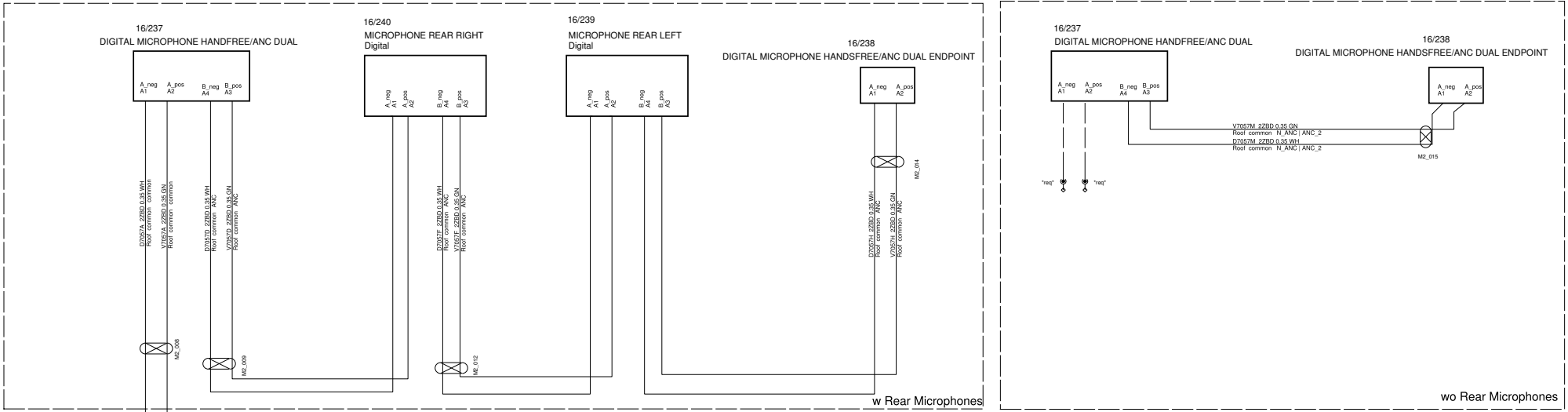

4/185.1  
 INFOTAINMENT HEAD UNIT IHU

<p>The copying, distribution and utilization of this document as well as the communication of its contents to others without expressed authorization is prohibited. Offenders will be held liable for payment of damages. All rights reserved in the event of the grant of a patent, utility model or ornamental design registration.</p> <p><b>VOLVO</b>                  VOLVO CAR CORPORATION</p>	<p><b>Document title</b> SPA_Issue25_Release1                  7B_002B_Telematics_Microphones_Digital</p>	
	<p><b>Document Type</b>                  DRAW/ELSY</p>	<p><b>Edited</b>                  December/22/2021</p>
	<p><b>Release Status</b>                  RELEASED</p>	
	<p><b>Document No</b>                  33409142</p>	<p><b>Issue</b>                  035</p>

# 7C DSRC IHU 4.0/iCUP

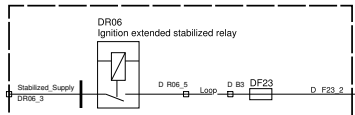

15/51  
REAR JUNCTION BOX

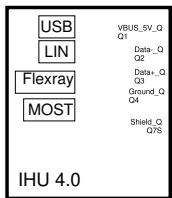

4/185.1 INFOTAINMENT HEAD UNIT IHU

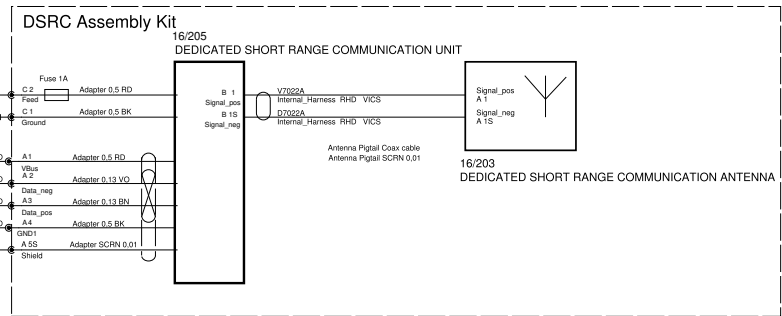

<p>The copying, distribution and utilization of this document as well as the communication of its contents to others without expressed authorization is prohibited. Offenders will be held liable for payment of damages. All rights reserved in the event of the grant of a patent, utility model or ornamental design registration.</p> <p><b>VOLVO</b> VOLVO CAR CORPORATION</p>	<p><b>Document title</b> SPA_Issue25_Release1 7C_003_DSRC_IHU40</p>	
	<p><b>Document Type</b> DRAW/ELSY</p>	<p><b>Edited</b> November/12/2021</p>
	<p><b>Release Status</b> RELEASED</p>	
	<p><b>Document No</b> 33409142</p>	<p><b>Issue</b> 035</p>

# 7D Remote Monitoring System

China market only. Pummel RMS.

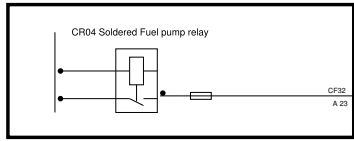

15/50  
CENTRAL JUNCTION BOX

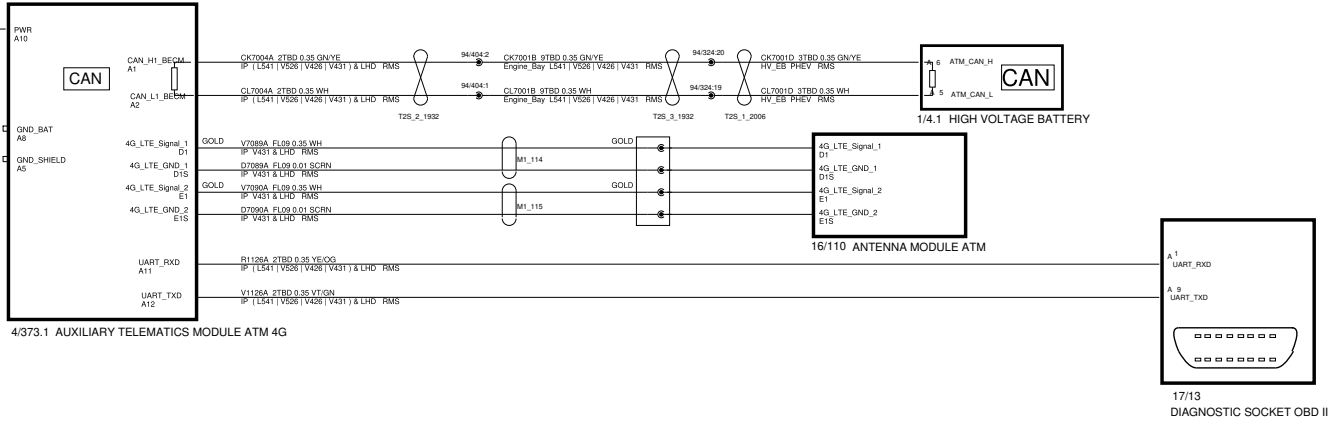

<p>The copying, distribution and utilization of this document as well as the communication of its contents to others without expressed authorization is prohibited. Offenders will be held liable for payment of damages. All rights reserved in the event of the grant of a patent, utility model or ornamental design registration.</p> <p><b>VOLVO</b> VOLVO CAR CORPORATION</p>	<b>Document title</b> SPA_Issue25_Release1 7D_001_Remote_Monitoring_System		
	<b>Document Type</b> DRAW/ELSY	<b>Edited</b> March/21/2023	
	<b>Release Status</b> RELEASED		
	<b>Document No</b> 33409142	<b>Issue</b> 035	<b>Page No</b> 141/177

# 7E Wireless Phone Charger

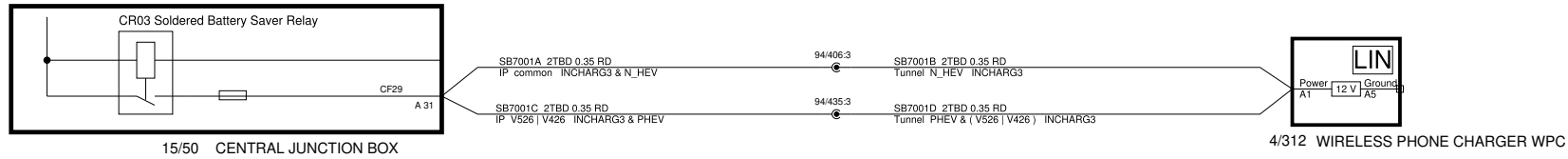

<p>The copying, distribution and utilization of this document as well as the communication of its contents to others without expressed authorization is prohibited. Offenders will be held liable for payment of damages. All rights reserved in the event of the grant of a patent, utility model or ornamental design registration.</p>	<b>Document title</b> SPA_Issue25_Release1 7E_001_Wireless_Phone_Charger	
	<b>Document Type</b> DRAW/ELSY	<b>Edited</b> December/22/2021
<p><b>VOLVO</b> VOLVO CAR CORPORATION</p>	<b>Release Status</b> RELEASED	
	<b>Document No</b> 33409142	<b>Issue</b> 035
	<b>Page No</b> 142/177	

# 7F Electronic Toll Collector

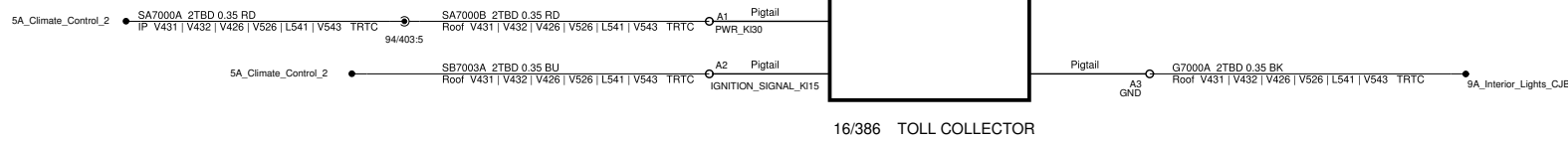

<p>The copying, distribution and utilization of this document as well as the communication of its contents to others without expressed authorization is prohibited. Offenders will be held liable for payment of damages. All rights reserved in the event of the grant of a patent, utility model or ornamental design registration.</p> <p><b>VOLVO</b> VOLVO CAR CORPORATION</p>	<p><b>Document title</b> SPA_Issue25_Release1 7F_Electronic_Toll_Collector</p>		
	<p><b>Document Type</b> DRAW/ELSY</p>	<p><b>Edited</b> June/16/2021</p>	
	<p><b>Release Status</b> RELEASED</p>		
	<p><b>Document No</b> 33409142</p>	<p><b>Issue</b> 035</p>	<p><b>Page No</b> 143/177</p>



# 8A Exterior Light Front Fog

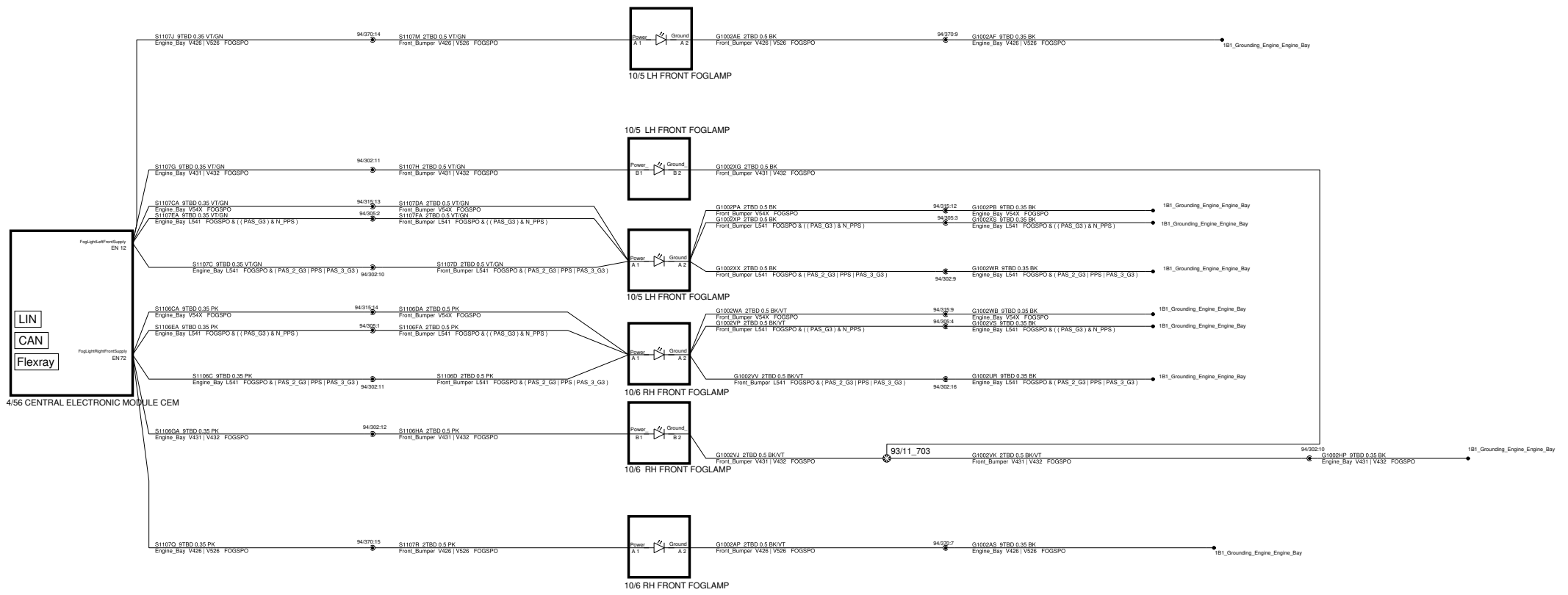

<p>The copying, distribution and utilization of this document as well as the communication of its contents to others without expressed authorization is prohibited. Offenders will be held liable for payment of damages. All rights reserved in the event of the grant of a patent, utility model or ornamental design registration.</p>	<b>Document title</b> SPA_Issue25_Release1 8A_Exterior_Light_Front_Fog	
	<b>Document Type</b> DRAW/ELSY	<b>Edited</b> March/15/2023
<p><b>VOLVO</b> VOLVO CAR CORPORATION</p>	<b>Release Status</b> RELEASED	
	<b>Document No</b> 33409142	<b>Issue</b> 035
	<b>Page No</b> 144/177	

# 8A Exterior Light Front HCM

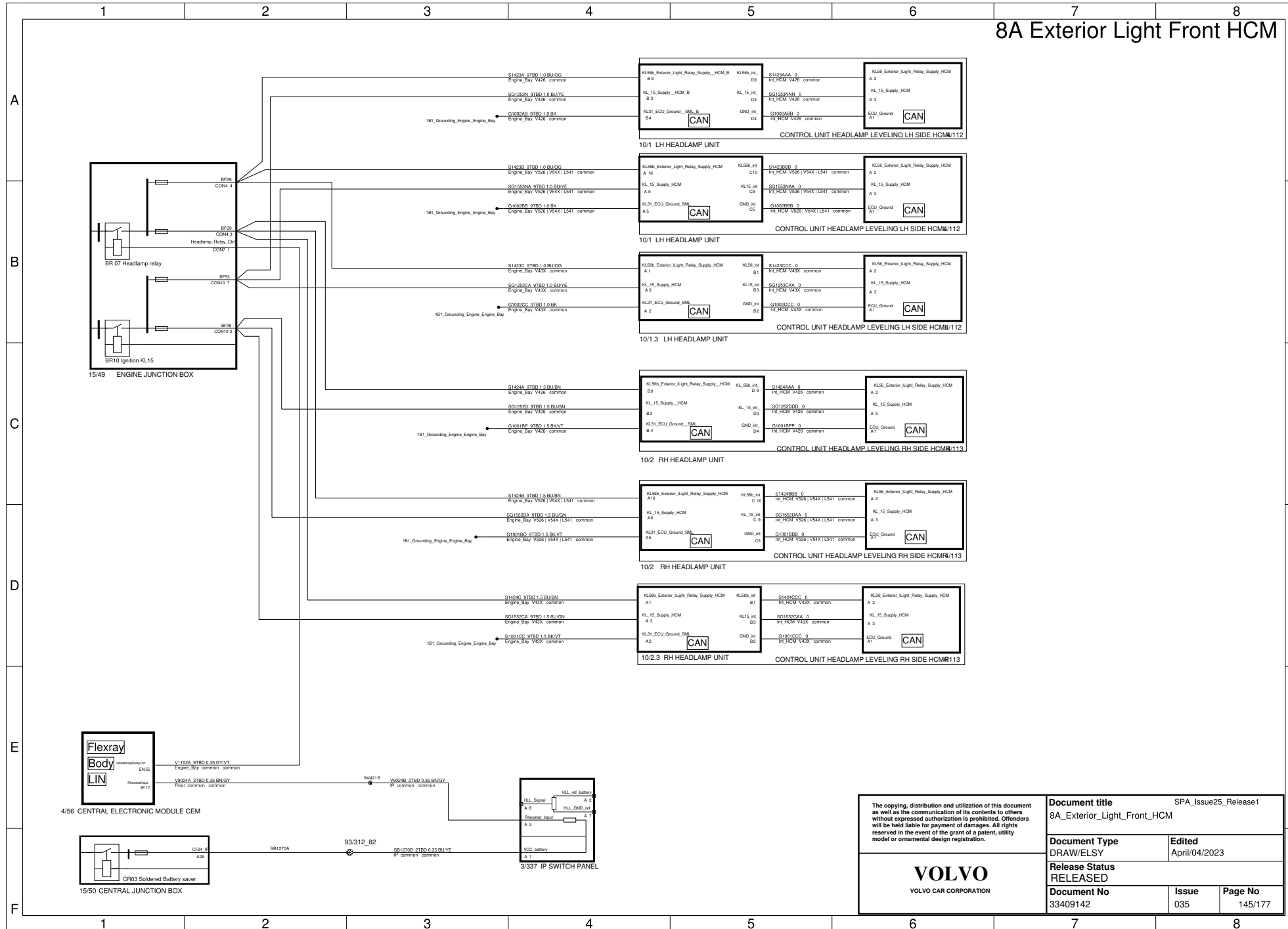

<p>The copying, distribution and utilization of this document as well as the communication of its contents to others without expressed authorization is prohibited. Offenders will be held liable for payment of damages. All rights reserved in the event of the grant of a patent, utility model or ornamental design registration.</p> <p><b>VOLVO</b> VOLVO CAR CORPORATION</p>	<b>Document title</b> SPA_Issue25_Release1 8A_Exterior_Light_Front_HCM	
	<b>Document Type</b> DRAW/ELSY	<b>Edited</b> April/04/2023
<b>Release Status</b> RELEASED		
<b>Document No</b> 33409142	<b>Issue</b> 035	<b>Page No</b> 145/177

# 8A Exterior Light Rear

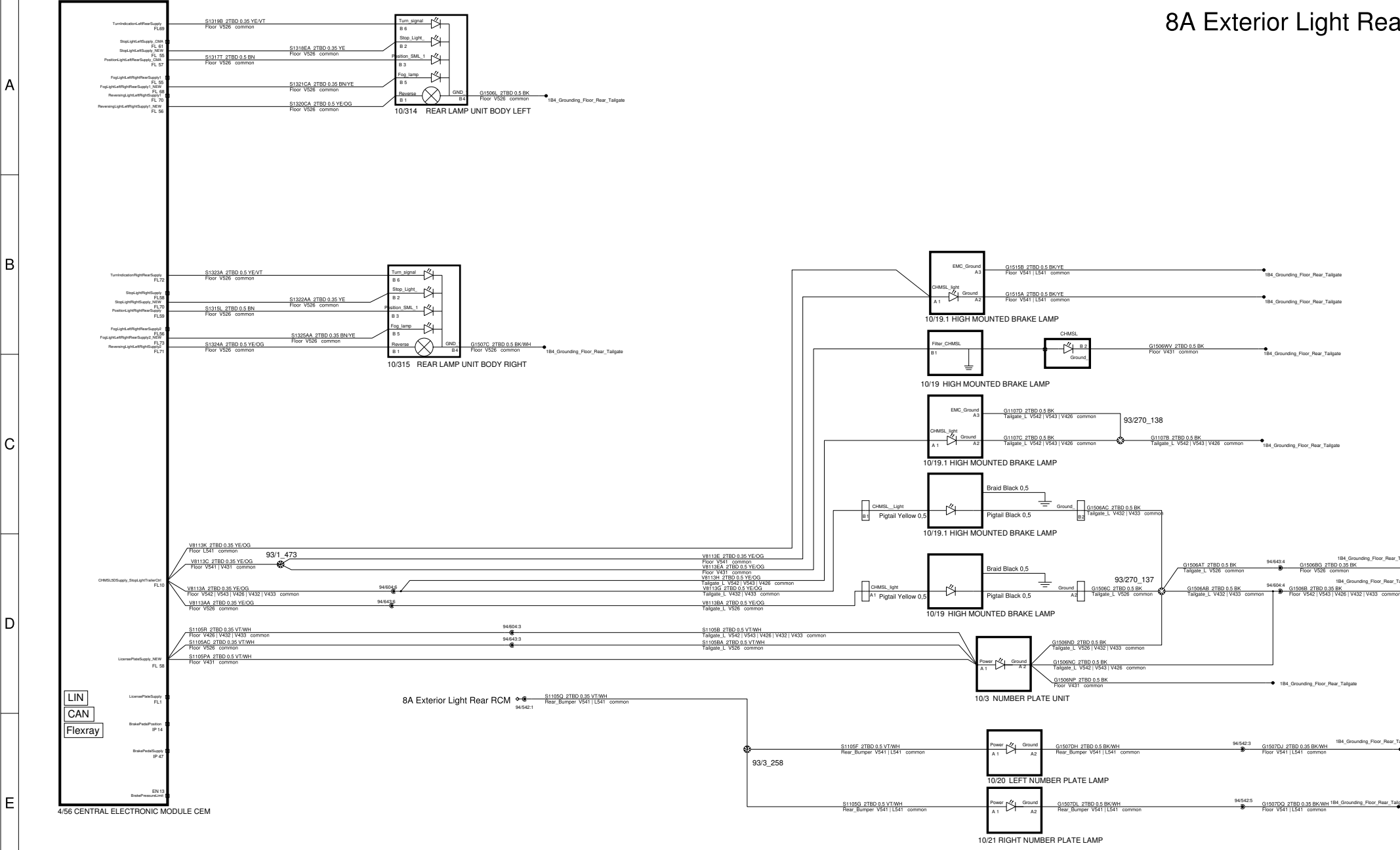

<p>The copying, distribution and utilization of this document as well as the communication of its contents to others without expressed authorization is prohibited. Offenders will be held liable for payment of damages. All rights reserved in the event of the grant of a patent, utility model or ornamental design registration.</p> <p><b>VOLVO</b> VOLVO CAR CORPORATION</p>	<p><b>Document title</b> 8A_Exterior_Light_Rear</p>		<p>SPA_Issue25_Release1</p>	
	<p><b>Document Type</b> DRAW/ELSY</p>		<p><b>Edited</b> January/13/2022</p>	
	<p><b>Release Status</b> RELEASED</p>			
	<p><b>Document No</b> 33409142</p>	<p><b>Issue</b> 035</p>	<p><b>Page No</b> 146/177</p>	



# 8A Exterior Light Rear CL60

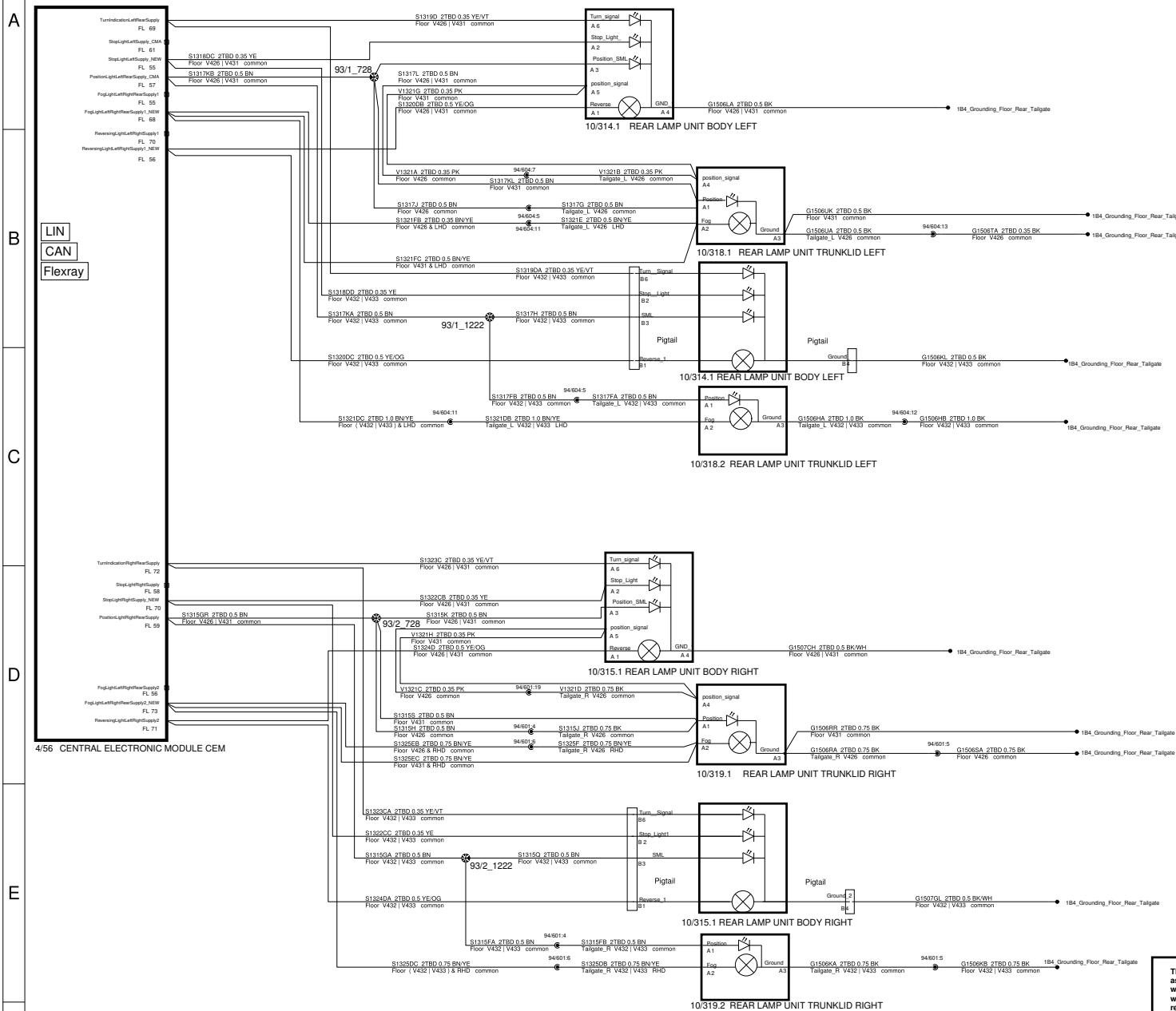

<p>The copying, distribution and utilization of this document as well as the communication of its contents to others without expressed authorization is prohibited. Offenders will be held liable for payment of damages. All rights reserved in the event of the grant of a patent, utility model or ornamental design registration.</p>		<p><b>Document title</b> SPA_Issue25_Release1</p>	
<p><b>Document Type</b> DRAW/ELSY</p>		<p><b>Edited</b> March/21/2023</p>	
<p><b>Release Status</b> RELEASED</p>			
<p><b>Document No</b> 33409142</p>	<p><b>Issue</b> 035</p>	<p><b>Page No</b> 147/177</p>	



# 8A Exterior Light Rear RCM

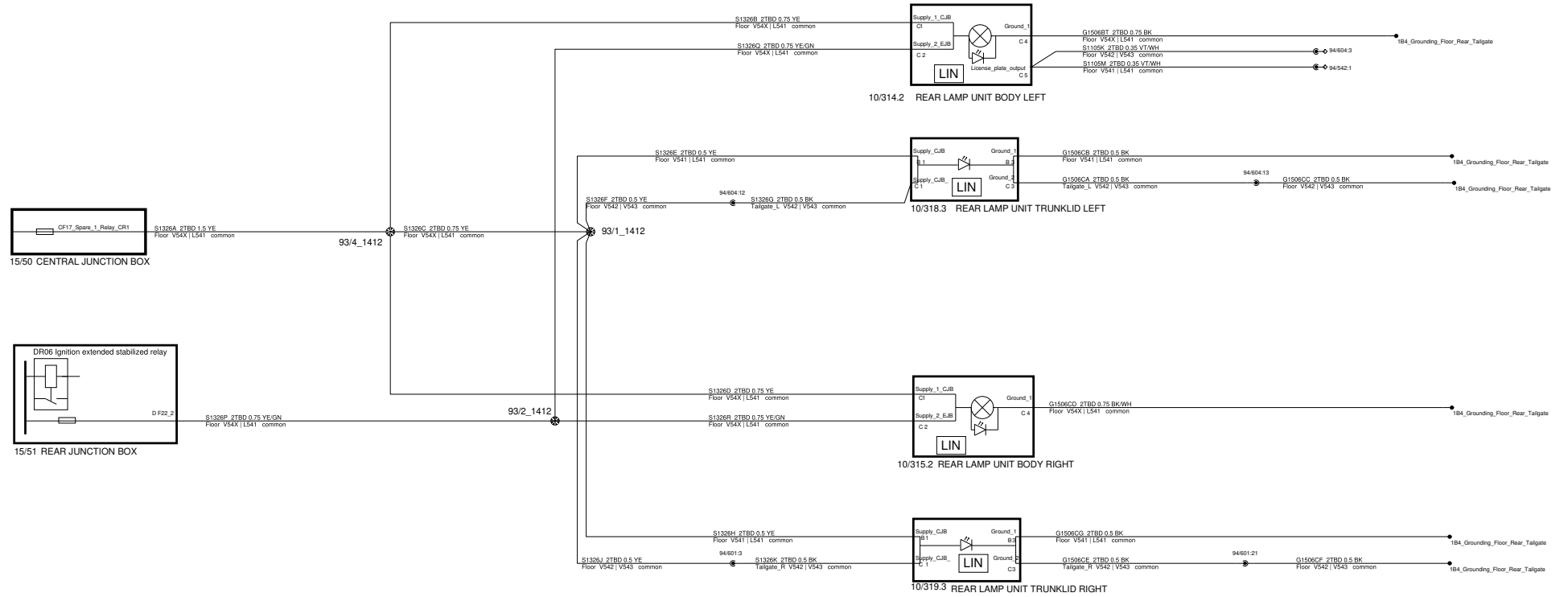

<p>The copying, distribution and utilization of this document as well as the communication of its contents to others without expressed authorization is prohibited. Offenders will be held liable for payment of damages. All rights reserved in the event of the grant of a patent, utility model or ornamental design registration.</p> <p><b>VOLVO</b> VOLVO CAR CORPORATION</p>	<p><b>Document title</b> SPA_Issue25_Release1 8A_Exterior_Light_Rear_RCM</p>	
	<p><b>Document Type</b> DRAW/ELSY</p>	<p><b>Edited</b> March/20/2023</p>
	<p><b>Release Status</b> RELEASED</p>	
	<p><b>Document No</b> 33409142</p>	<p><b>Issue</b> 035</p> <p><b>Page No</b> 148/177</p>

# 8A Exterior Light Rear Sensors

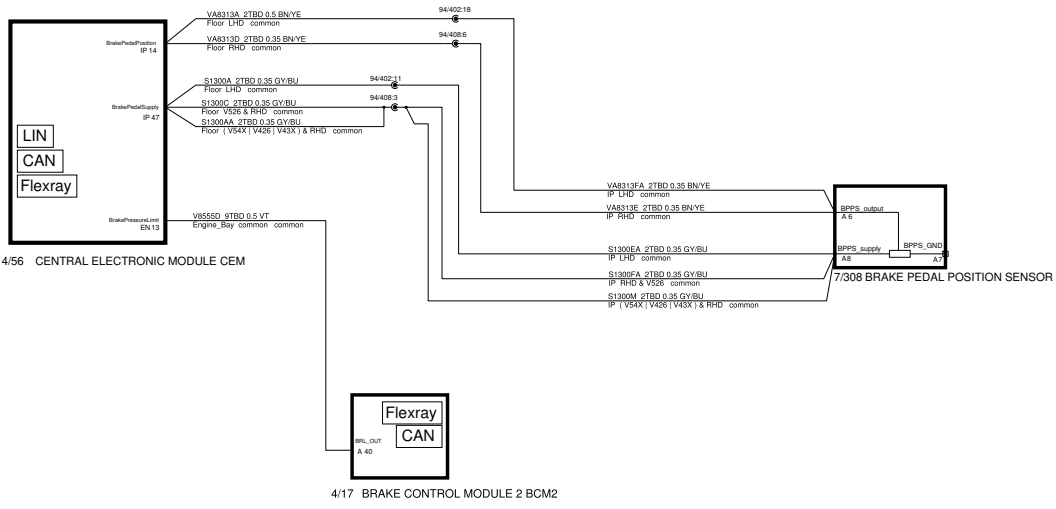

<p>The copying, distribution and utilization of this document as well as the communication of its contents to others without expressed authorization is prohibited. Offenders will be held liable for payment of damages. All rights reserved in the event of the grant of a patent, utility model or ornamental design registration.</p> <p><b>VOLVO</b> VOLVO CAR CORPORATION</p>	<b>Document title</b> SPA_Issue25_Release1 8A_Exterior_Light_Rear_Sensors		
	<b>Document Type</b> DRAW/ELSY	<b>Edited</b> April/08/2022	
	<b>Release Status</b> RELEASED		
	<b>Document No</b> 33409142	<b>Issue</b> 035	<b>Page No</b> 149/177

# 8K Lamp cleaning control 8H Windscreen cleaning control 8J Rear window cleaning

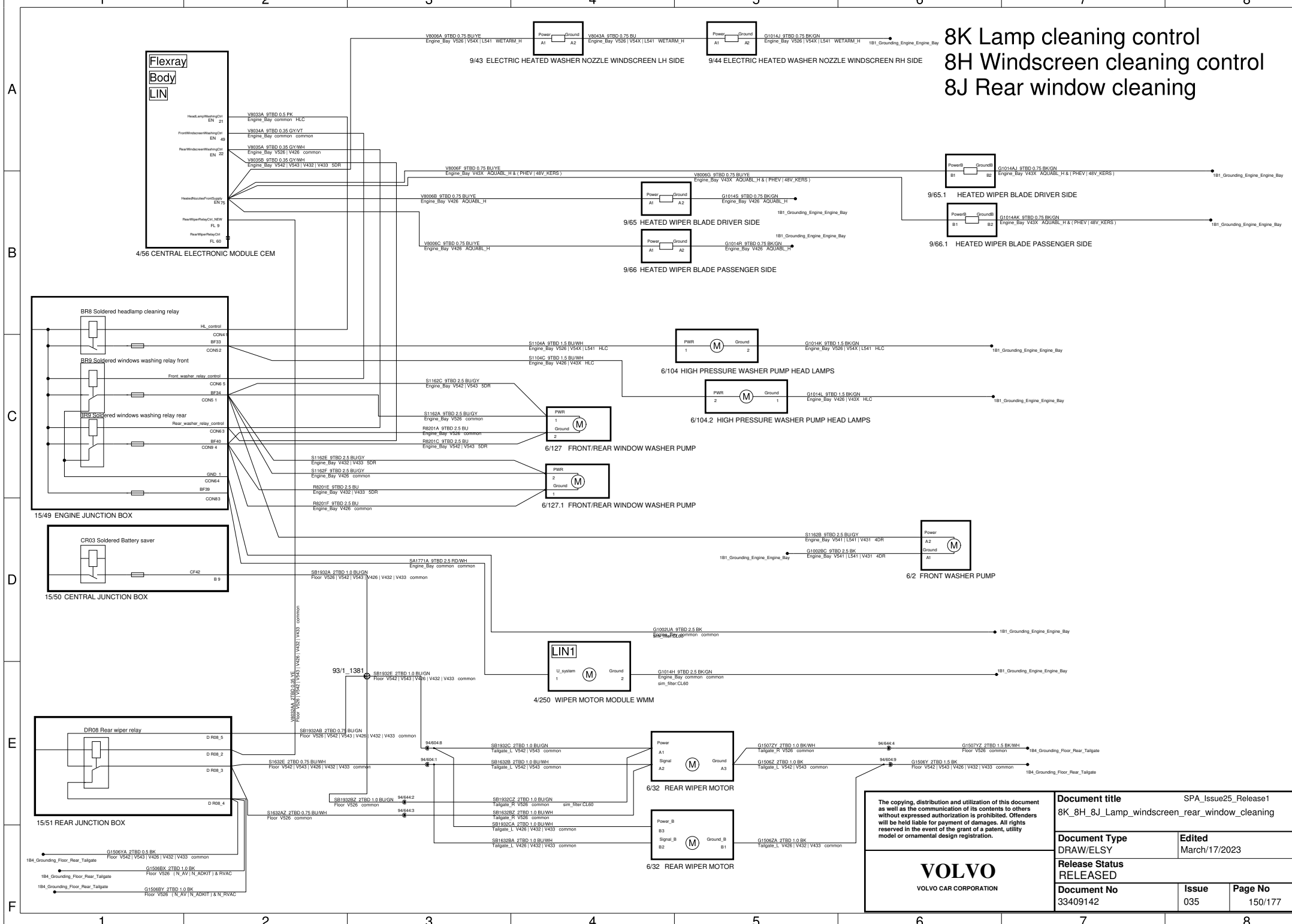

The copying, distribution and utilization of this document as well as the communication of its contents to others without expressed authorization is prohibited. Offenders will be held liable for payment of damages. All rights reserved in the event of the grant of a patent, utility model or ornamental design registration.		<b>Document title</b> SPA_Issue25_Release1 8K_8H_8J_Lamp_windscreen_rear_window_cleaning	
<b>Document Type</b> DRAW/ELSY		<b>Edited</b> March/17/2023	
<b>Release Status</b> RELEASED			
<b>Document No</b> 33409142	<b>Issue</b> 035	<b>Page No</b> 150/177	



# 8N Windscreen defroster control 8L Rear window defroster control

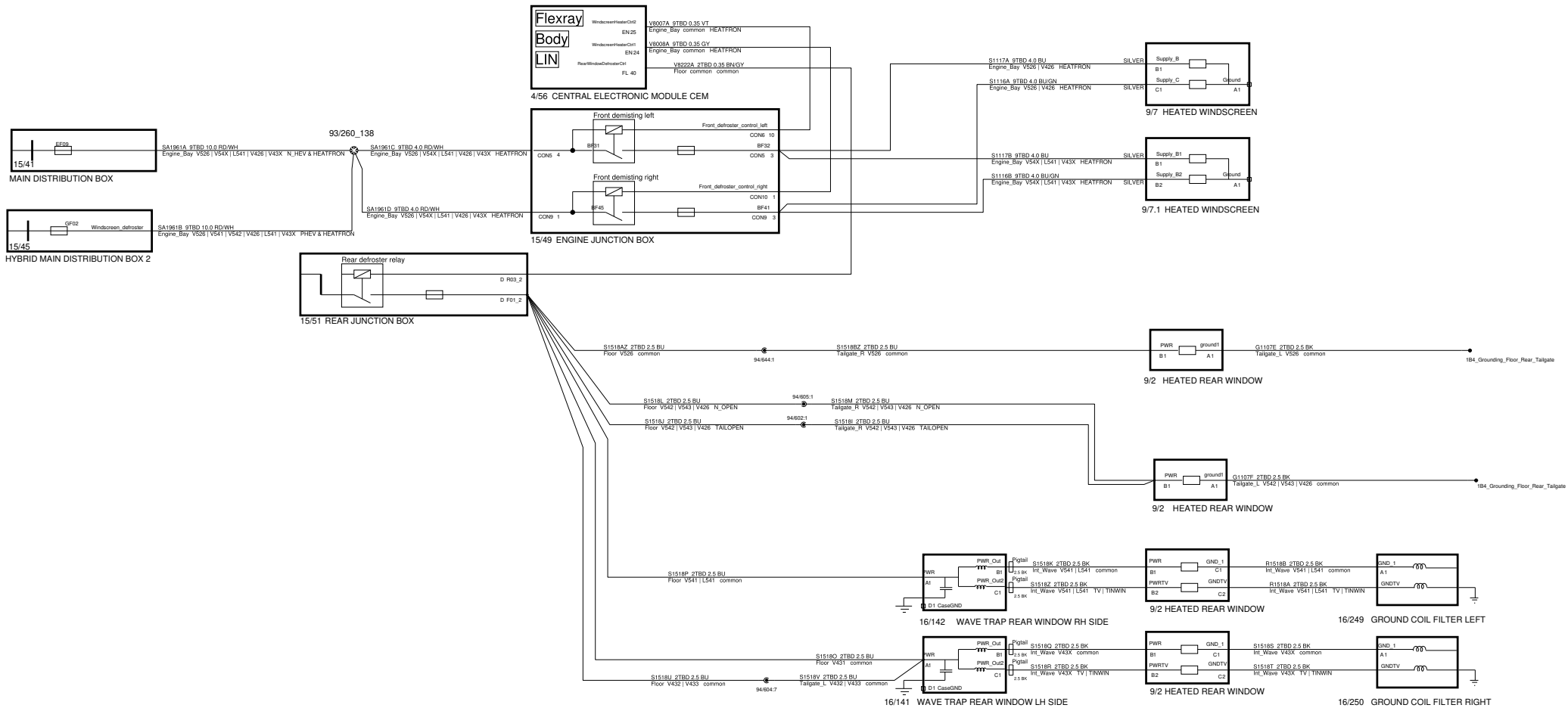

<p>The copying, distribution and utilization of this document as well as the communication of its contents to others without expressed authorization is prohibited. Offenders will be held liable for payment of damages. All rights reserved in the event of the grant of a patent, utility model or ornamental design registration.</p>		Document title		SPA_Issue25_Release1	
		8N_8L_Windscreen_rear_window_defroster			
<p><b>VOLVO</b> VOLVO CAR CORPORATION</p>		Document Type		Released	
		DRAW/ELSY		December/16/2021	
		Release Status		RELEASED	
Document No		Issue		Page No	
33409142		035		151/177	





# 8P Sound Signaling

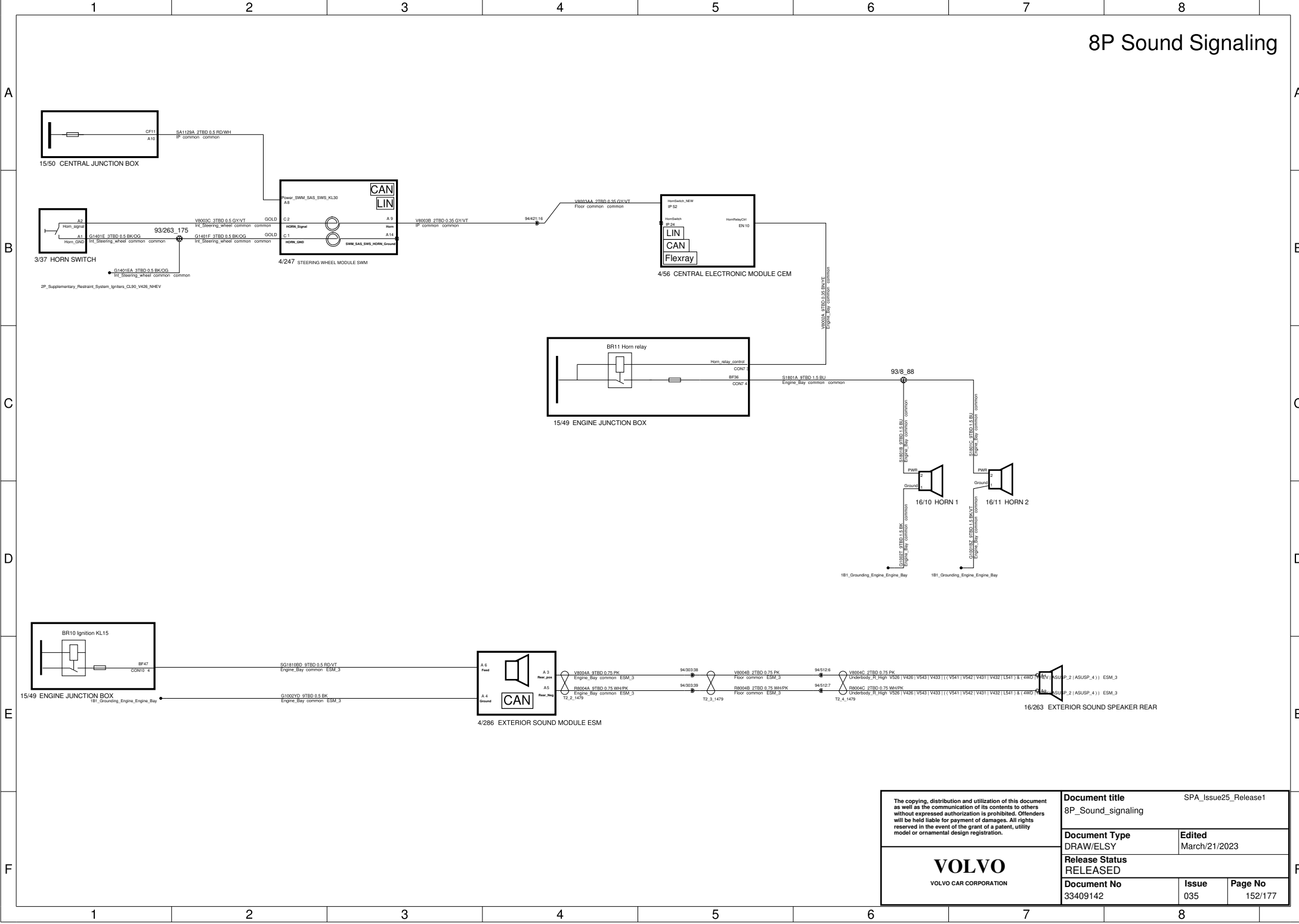

<p>The copying, distribution and utilization of this document as well as the communication of its contents to others without expressed authorization is prohibited. Offenders will be held liable for payment of damages. All rights reserved in the event of the grant of a patent, utility model or ornamental design registration.</p> <p><b>VOLVO</b> VOLVO CAR CORPORATION</p>	<b>Document title</b> SPA_Issue25_Release1 8P_Sound_signaling	
	<b>Document Type</b> DRAW/ELSY	<b>Edited</b> March/21/2023
	<b>Release Status</b> RELEASED	
	<b>Document No</b> 33409142	<b>Issue</b> 035



# 9A Interior Lights CEM

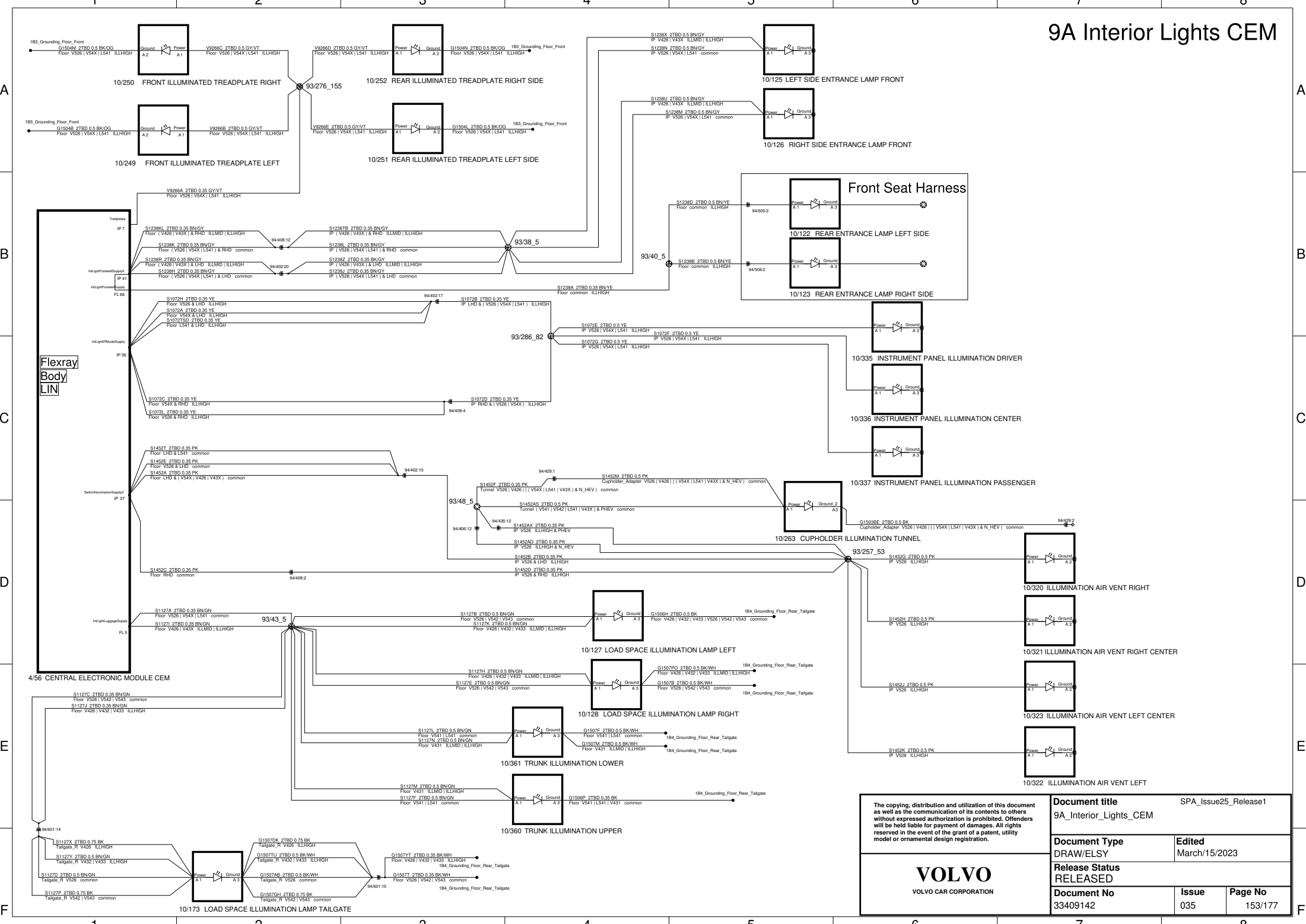

The copying, distribution and utilization of this document as well as the communication of its contents to others without expressed authorization is prohibited. Offenders will be held liable for payment of damages. All rights reserved in the event of the grant of a patent, utility model or ornamental design registration.

**VOLVO**  
VOLVO CAR CORPORATION

Document title		SPA_Issue25_Release1	
9A_Interior_Lights_CEM			
Document Type	DRAW/ELSY	Edited	March/15/2023
Release Status		RELEASED	
Document No	33409142	Issue	035
		Page No	153/177



# 9A Interior Lights Doors Front

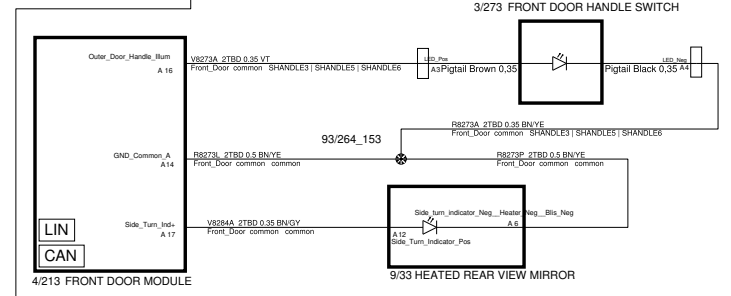
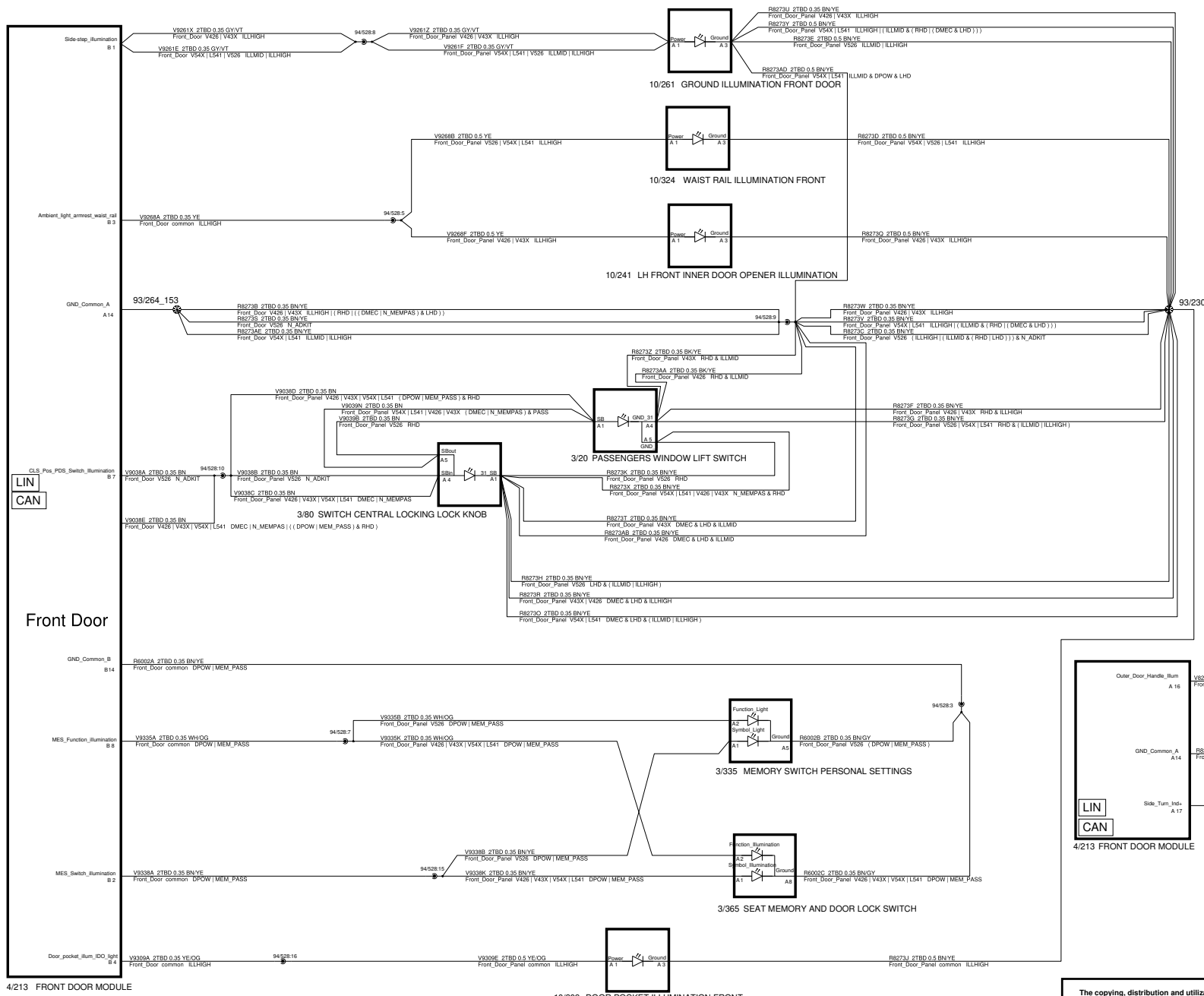

The copying, distribution and utilization of this document as well as the communication of its contents to others without expressed authorization is prohibited. Offenders will be held liable for payment of damages. All rights reserved in the event of the grant of a patent, utility model or ornamental design registration.		<b>Document title</b> SPA_Issue25_Release1 9A_Interior_Lights_Doors_Front	
<b>Document Type</b> DRAW/ELSY		<b>Edited</b> March/15/2023	
<b>RELEASED</b>			
<b>Document No</b> 33409142	<b>Issue</b> 035	<b>Page No</b> 155/177	



# 9A Interior Lights Doors Front Right

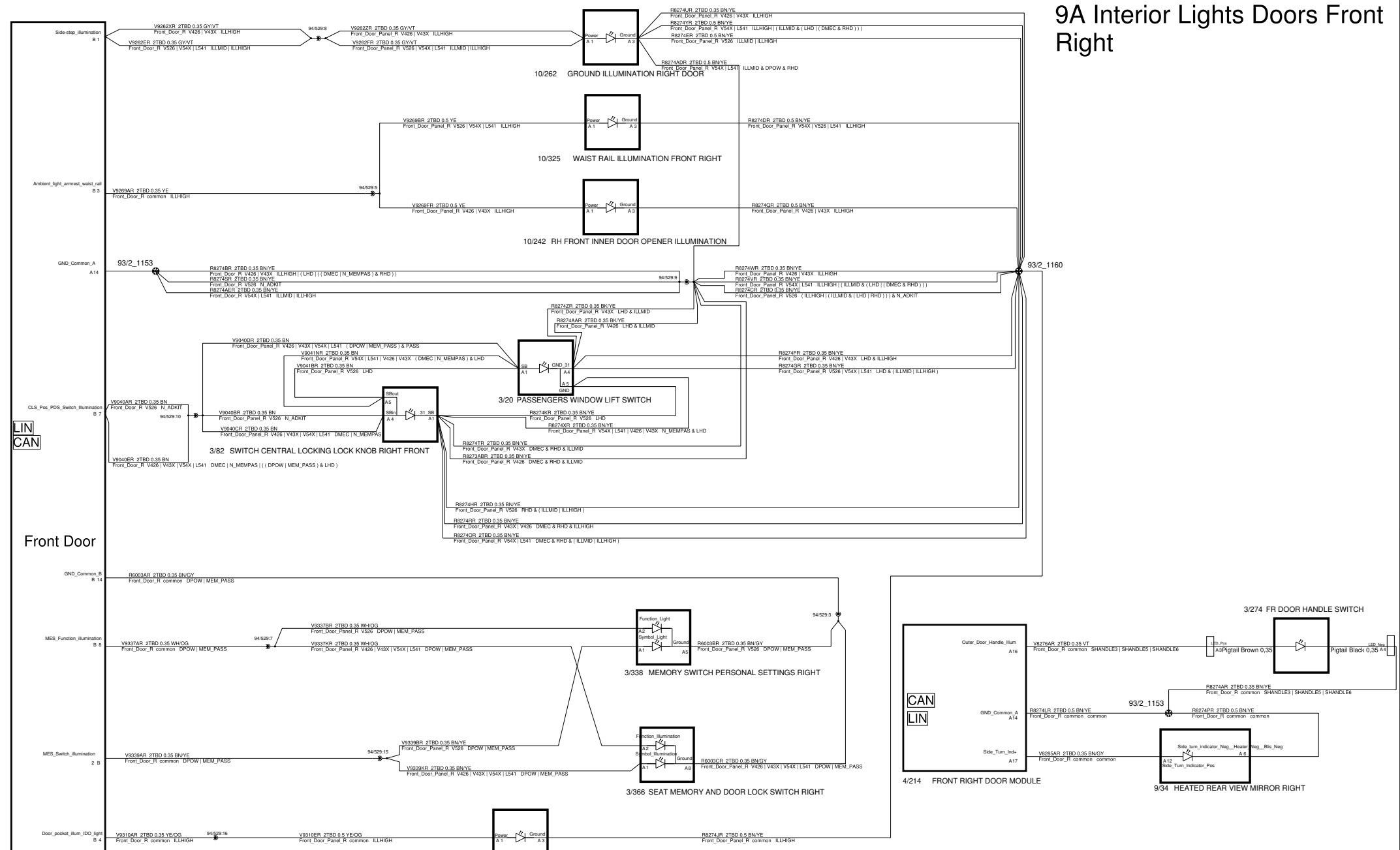

<p>The copying, distribution and utilization of this document as well as the communication of its contents to others without expressed authorization is prohibited. Offenders will be held liable for payment of damages. All rights reserved in the event of the grant of a patent, utility model or ornamental design registration.</p>		<p>Document title SPA_Issue25_Release1</p>	
		<p>9A_Interior_Lights_Doors_Front_Right</p>	
<p>Document Type DRAW/ELSY</p>		<p>Edited March/15/2023</p>	
<p>Release Status RELEASED</p>			
<p>Document No 33409142</p>		<p>Issue 035</p>	<p>Page No 156/177</p>

**VOLVO**  
VOLVO CAR CORPORATION

# 9A Interior Lights Doors Rear

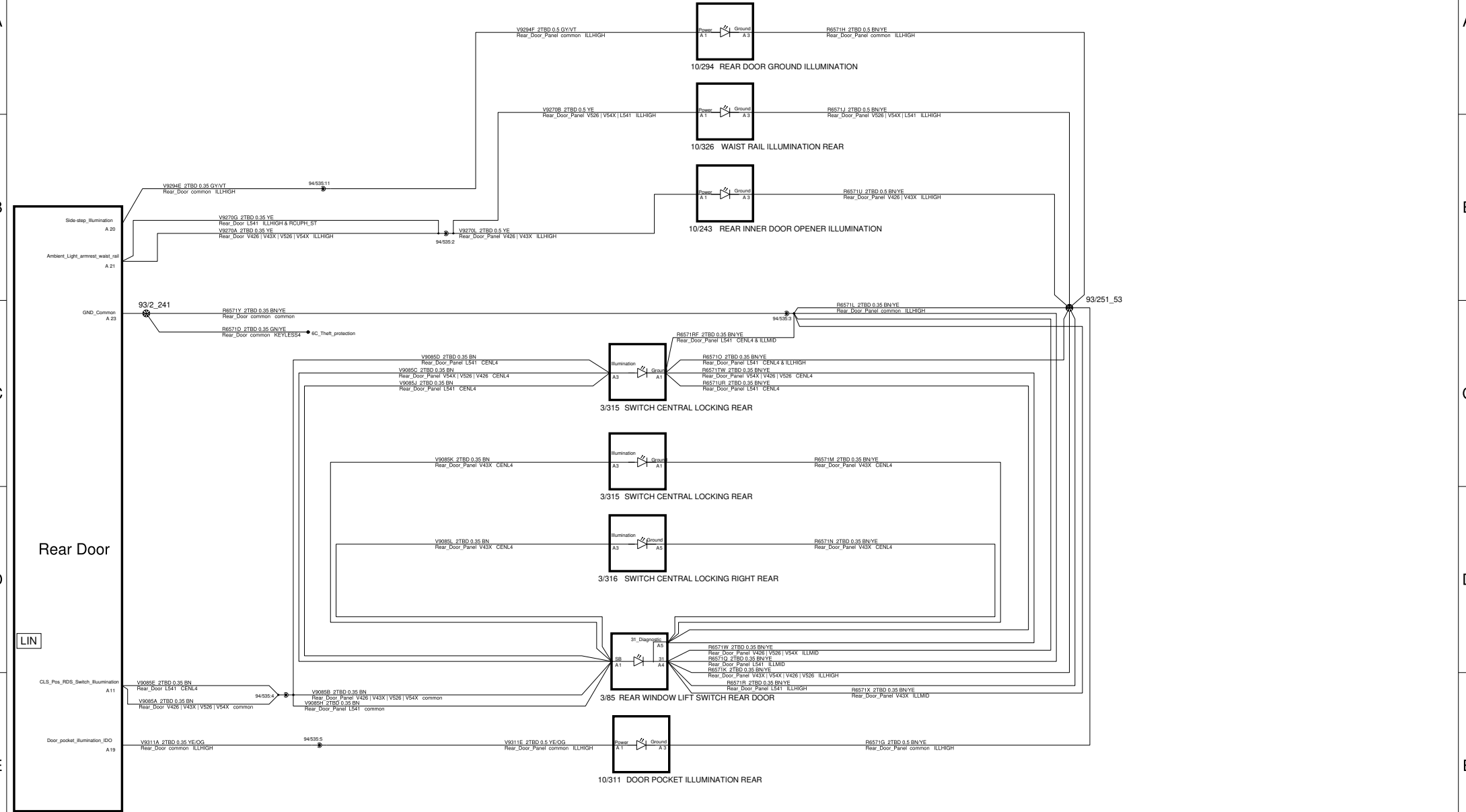

4/215 REAR DOOR MODULE

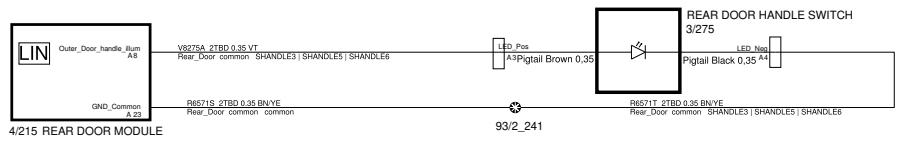

4/215 REAR DOOR MODULE

<p>The copying, distribution and utilization of this document as well as the communication of its contents to others without expressed authorization is prohibited. Offenders will be held liable for payment of damages. All rights reserved in the event of the grant of a patent, utility model or ornamental design registration.</p> <p><b>VOLVO</b> VOLVO CAR CORPORATION</p>		<p><b>Document title</b> SPA_Issue25_Release1 9A_Interior_Lights_Doors_Rear</p>	
		<p><b>Document Type</b> DRAW/ELSY</p>	<p><b>Edited</b> March/15/2023</p>
<p><b>Release Status</b> RELEASED</p>		<p><b>Document No</b> 33409142</p>	<p><b>Issue</b> 035</p>
		<p><b>Page No</b> 157/177</p>	

# 9H Instr/Control Switch Lighting

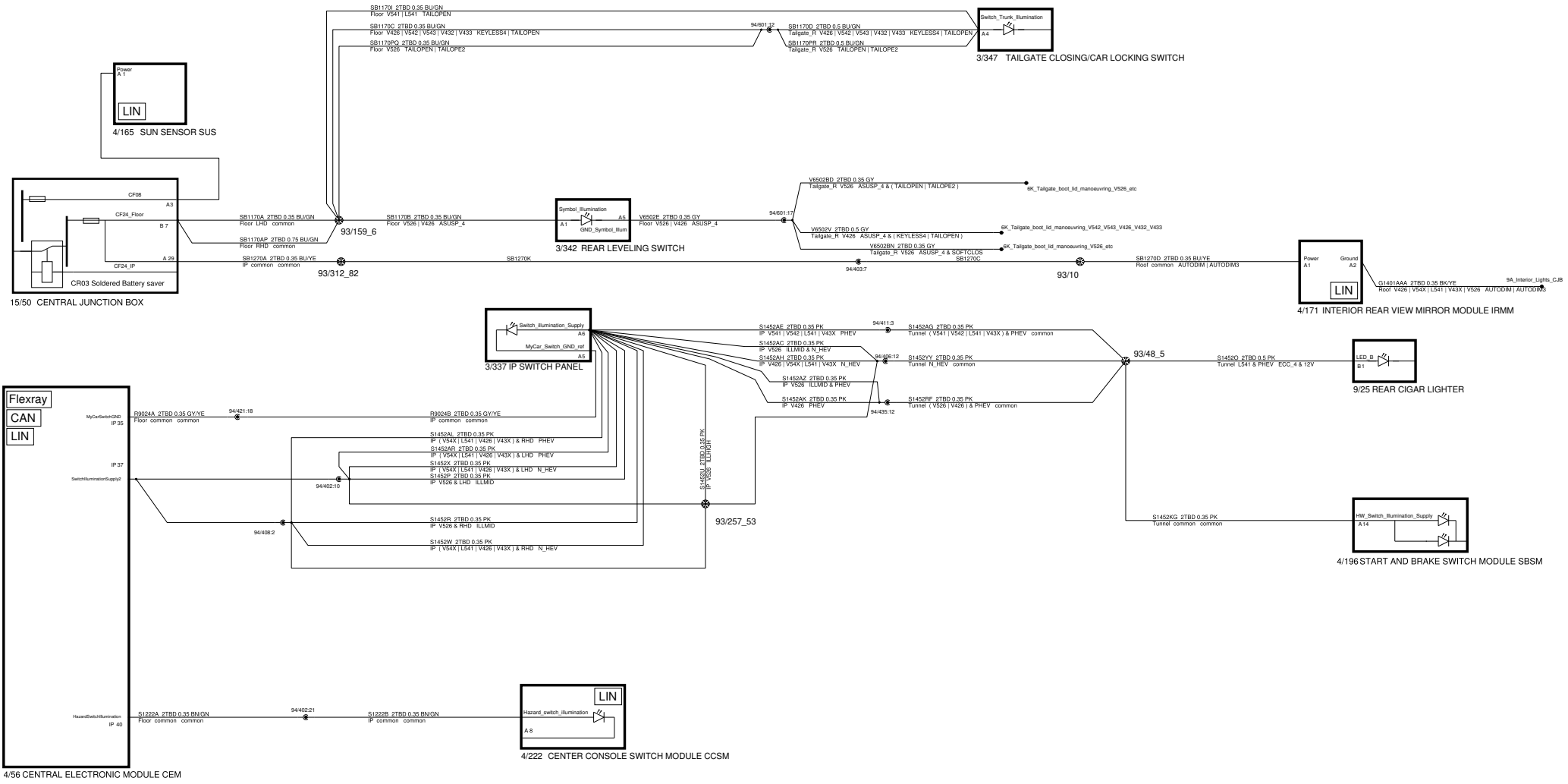

 VOLVO CAR CORPORATION	The copying, distribution and utilization of this document as well as the communication of its contents to others without expressed authorization is prohibited. Offenders will be held liable for payment of damages. All rights reserved in the event of the grant of a patent, utility model or ornamental design registration.		
	<b>Document title</b> SPA_Issue25_Release1 9H_Instr_Control_Switch_Lighting		
	<b>Document Type</b> DRAW/ELSY	<b>Edited</b> March/21/2023	
	<b>Release Status</b> RELEASED		
<b>Document No</b> 33409142	<b>Issue</b> 035	<b>Page No</b> 158/177	

# 10A Internal 7DCT Harness

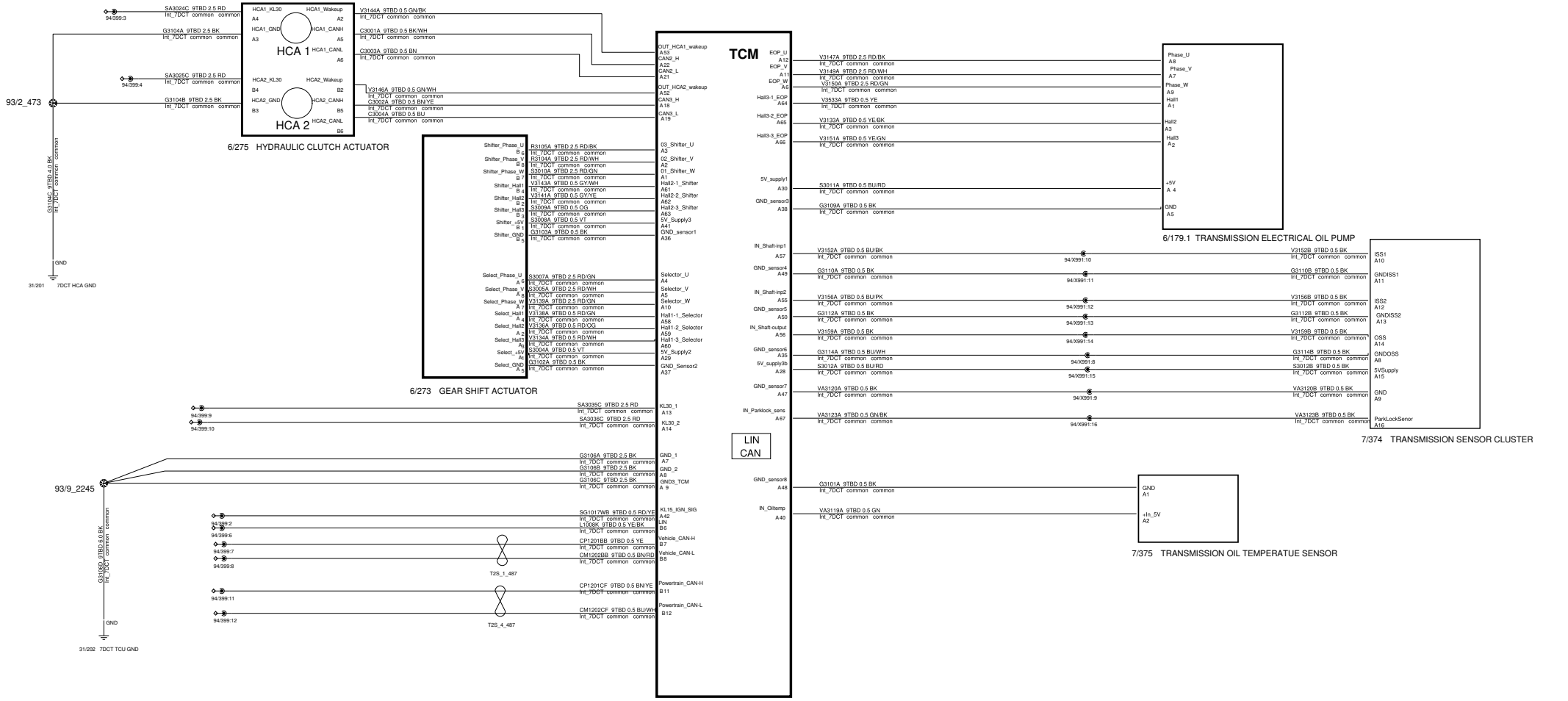

<p><b>VOLVO</b> VOLVO CAR CORPORATION</p>	<p><b>Document title</b> SPA_Issue25_Release1 10A_Internal_7DCT_Harness</p>	
	<p><b>Document Type</b> DRAW/ELSY</p>	<p><b>Edited</b> April/23/2023</p>
	<p><b>Release Status</b> RELEASED</p>	
	<p><b>Document No</b> 33409142</p>	<p><b>Issue</b> 035 <b>Page No</b> 163/177</p>



# 10A Driver Seat Internal Harness LHD

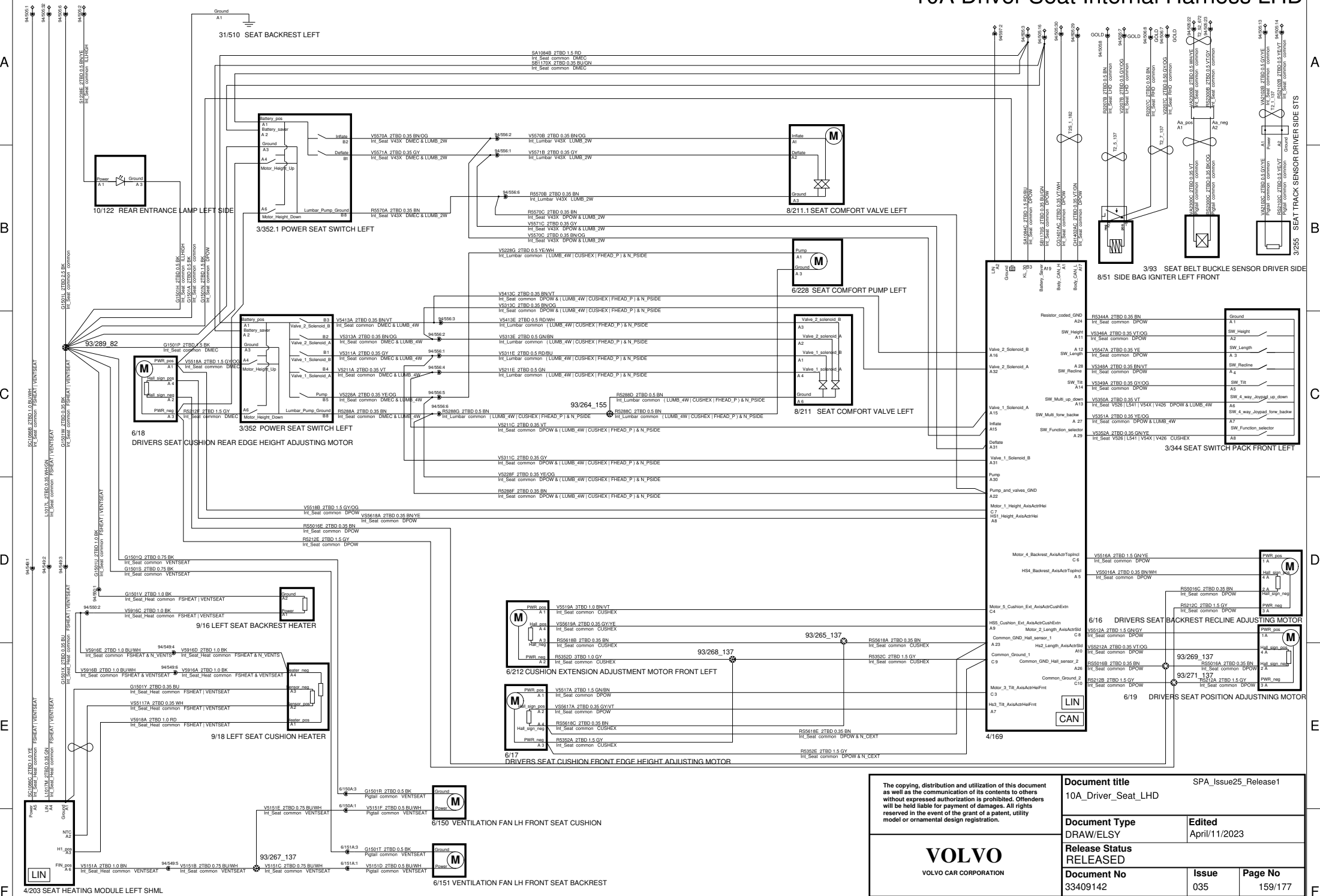

The copying, distribution and utilization of this document as well as the communication of its contents to others without expressed authorization is prohibited. Offenders will be held liable for payment of damages. All rights reserved in the event of the grant of a patent, utility model or ornamental design registration.

**VOLVO**  
VOLVO CAR CORPORATION

Document title		SPA_Issue25_Release1	
10A_Driver_Seat_LHD			
Document Type	DRAW/ELSY	Edited	April/11/2023
Release Status	RELEASED		
Document No	33409142	Issue	035
		Page No	159/177

# 10A Driver Seat Internal Harness Massage LHD

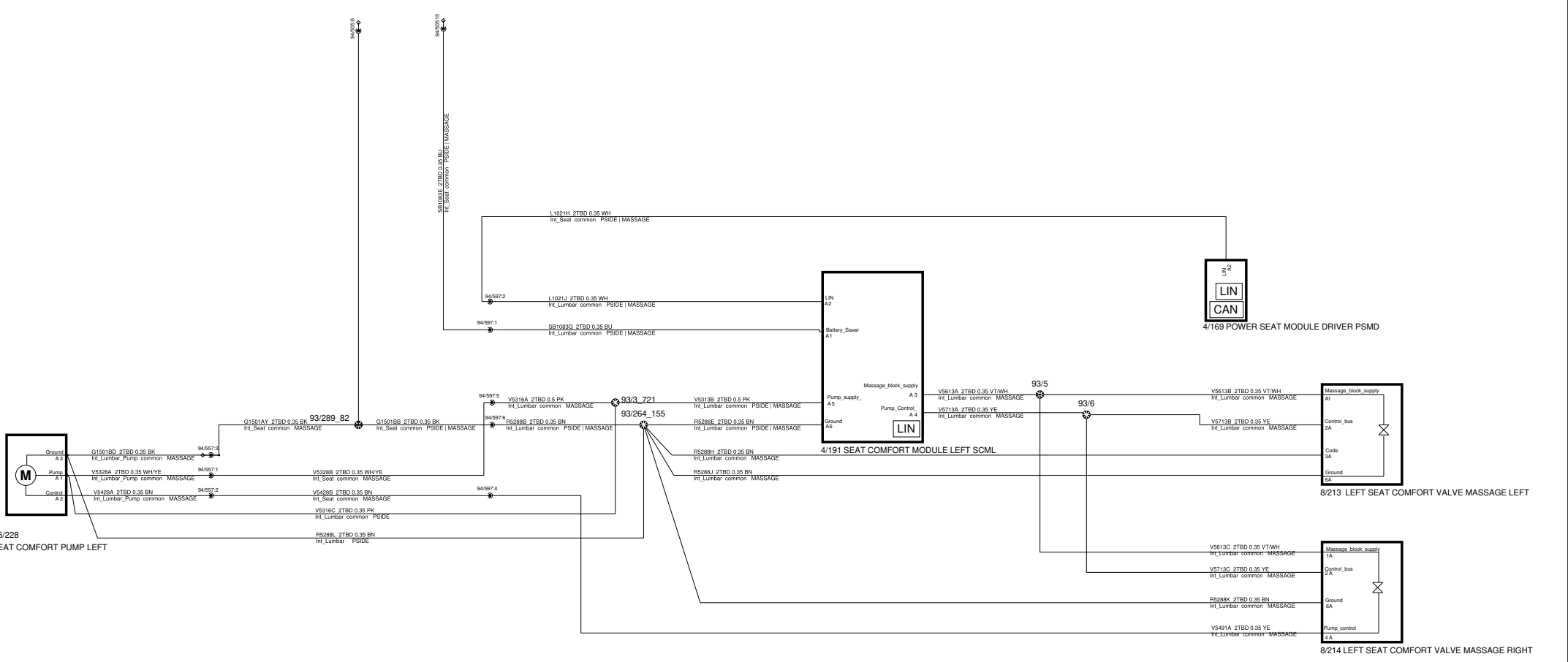

<p>The copying, distribution and utilization of this document as well as the communication of its contents to others without expressed authorization is prohibited. Offenders will be held liable for payment of damages. All rights reserved in the event of the grant of a patent, utility model or ornamental design registration.</p>		<p><b>Document title</b> SPA_Issue25_Release1 10A_Driver_Seat_Message_LHD</p>	
		<p><b>Document Type</b> DRAW/ELSY</p>	<p><b>Edited</b> April/11/2023</p>
<p><b>VOLVO</b> VOLVO CAR CORPORATION</p>		<p><b>Release Status</b> RELEASED</p>	
		<p><b>Document No</b> 33409142</p>	<p><b>Issue</b> 035</p>
		<p><b>Page No</b> 160/177</p>	



# 10A Interior HVAC harness ECC4

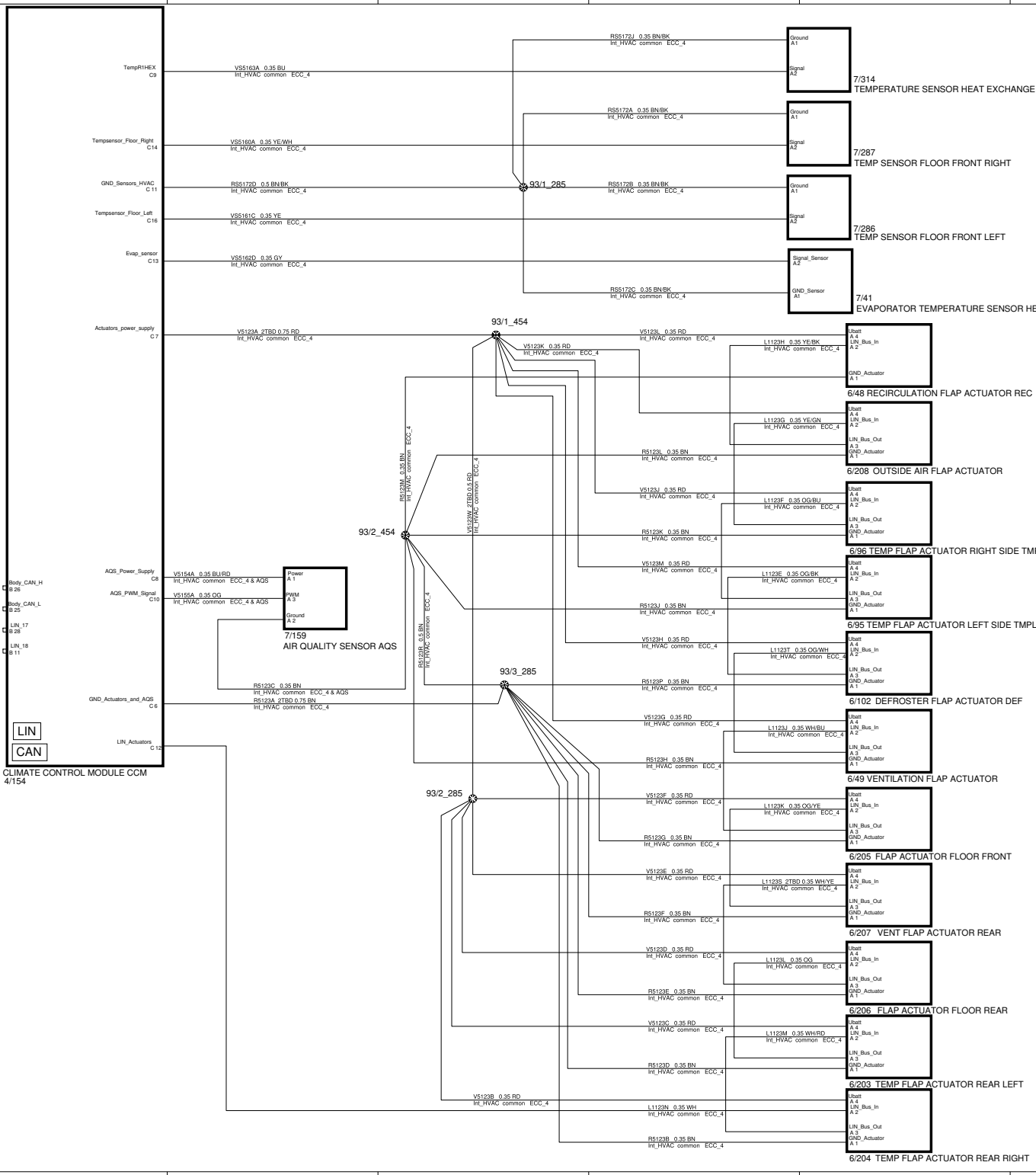

<p>The copying, distribution and utilization of this document as well as the communication of its contents to others without expressed authorization is prohibited. Offenders will be held liable for payment of damages. All rights reserved in the event of the grant of a patent, utility model or ornamental design registration.</p> <p><b>VOLVO</b> VOLVO CAR CORPORATION</p>		<b>Document title</b> SPA_Issue25_Release1 10A_HVAC_ECC4	
		<b>Document Type</b> DRAW/ELSY	<b>Edited</b> June/16/2021
<p><b>Release Status</b> RELEASED</p>		<b>Document No</b> 33409142	
		<b>Issue</b> 035	<b>Page No</b> 162/177
		VOLVO CAR CORPORATION	

A  
B  
C  
D  
E  
F

1 2 3 4 5 6 7 8

LIN  
CAN  
CLIMATE CONTROL MODULE CCM  
4/154

# 10A Passenger Seat Internal Harness LHD

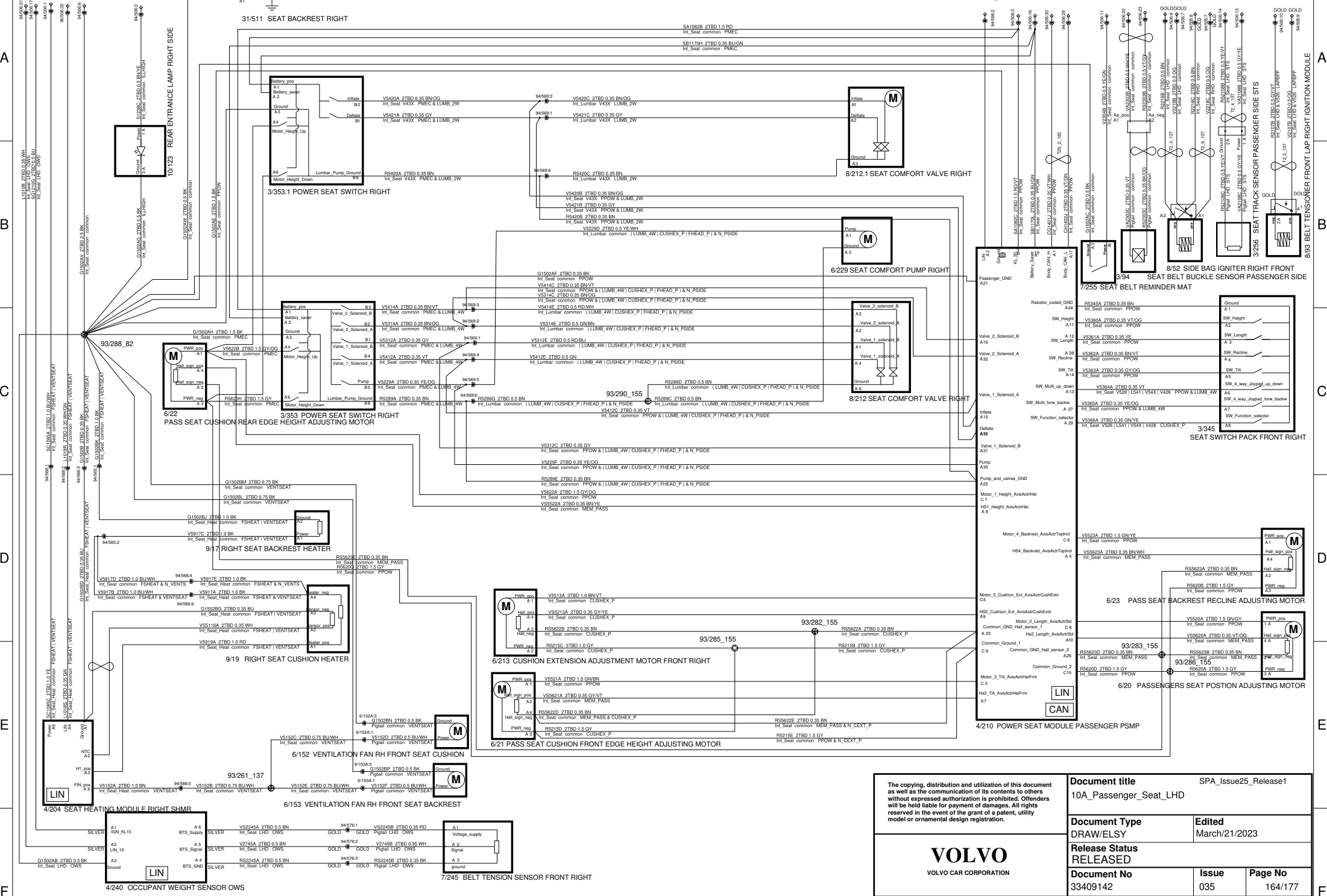

The copying, distribution and utilization of this document with or without the communication of its contents to others without expressed authorization is prohibited. Offenders will be held liable for payment of damages. All rights reserved in the event of the grant of a patent, utility model or ornamental design registration.



Document title		SPA_Issue25_Release1	
10A_Passenger_Seat_LHD			
Document Type	Edited		
DRAW/ELSY	March/21/2023		
Release Status			
RELEASED			
Document No	Issue	Page No	
33409142	035	164/177	

# 10A Passenger Seat Lumbar/Massage LHD

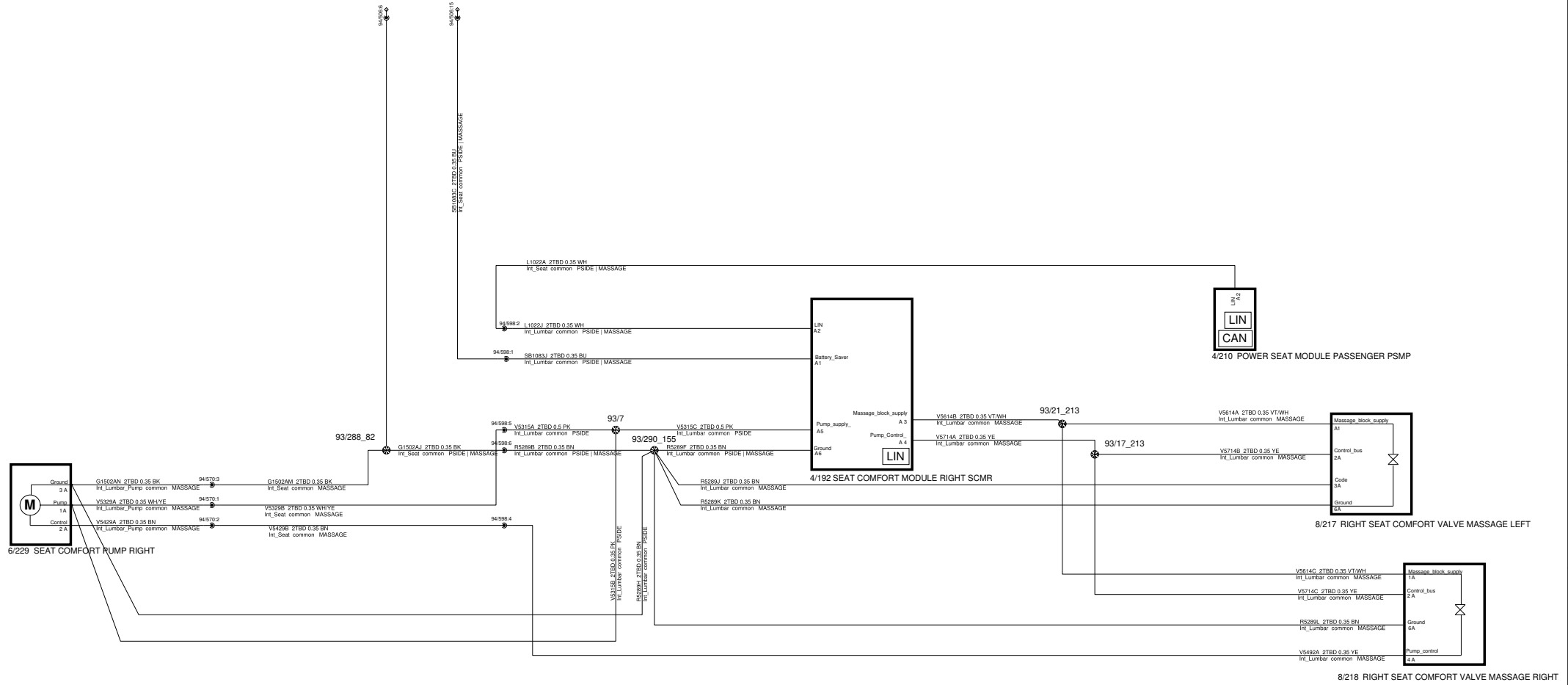

<p>The copying, distribution and utilization of this document as well as the communication of its contents to others without expressed authorization is prohibited. Offenders will be held liable for payment of damages. All rights reserved in the event of the grant of a patent, utility model or ornamental design registration.</p>		<p>Document title SPA_Issue25_Release1 10A_Passenger_Seat_Lumbar_Message_LHD</p>	
		<p>Document Type DRAW/ELSY</p>	<p>Edited April/11/2023</p>
<p><b>VOLVO</b> VOLVO CAR CORPORATION</p>		<p>Release Status RELEASED</p>	
		<p>Document No 33409142</p>	<p>Issue 035</p>
		<p>Page No 165/177</p>	

# 10A Rear Seat Internal Harness L541

## Proposal Rear Seat 2:nd row left L541

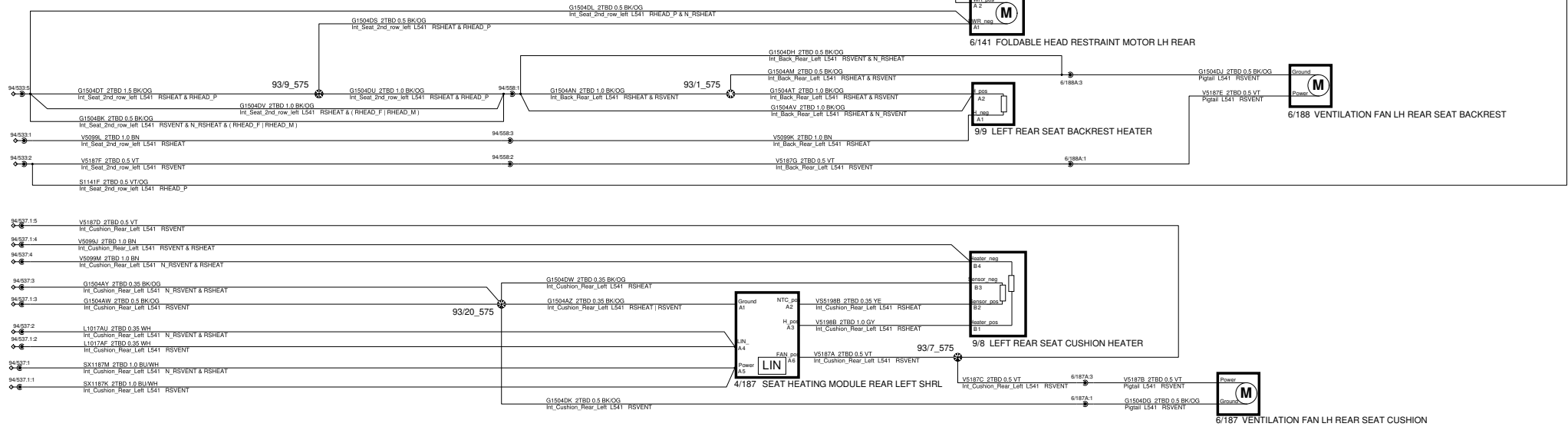

## Proposal Rear Seat 2:nd row right L541

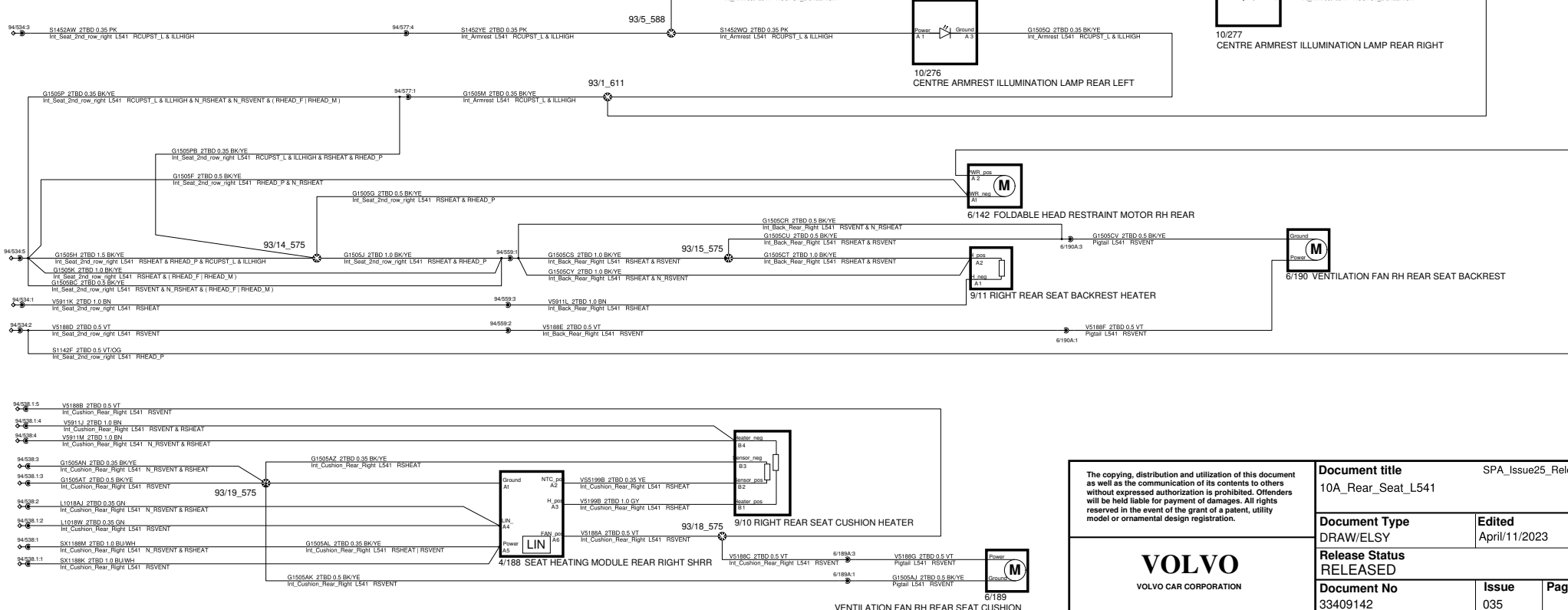

<p>The copying, distribution and utilization of this document as well as the communication of its contents to others without expressed authorization is prohibited. Offenders will be held liable for payment of damages. All rights reserved in the event of the grant of a patent, utility model or ornamental design registration.</p>		<p>Document title SPA_Issue25_Release1</p>	
		<p>10A_Rear_Seat_L541</p>	
<p>Document Type DRAW/ELSY</p>	<p>Edited April/11/2023</p>		
<p>Release Status RELEASED</p>			
<p>Document No 33409142</p>	<p>Issue 035</p>	<p>Page No 166/177</p>	



6/189

Rear Seat 2:nd row left

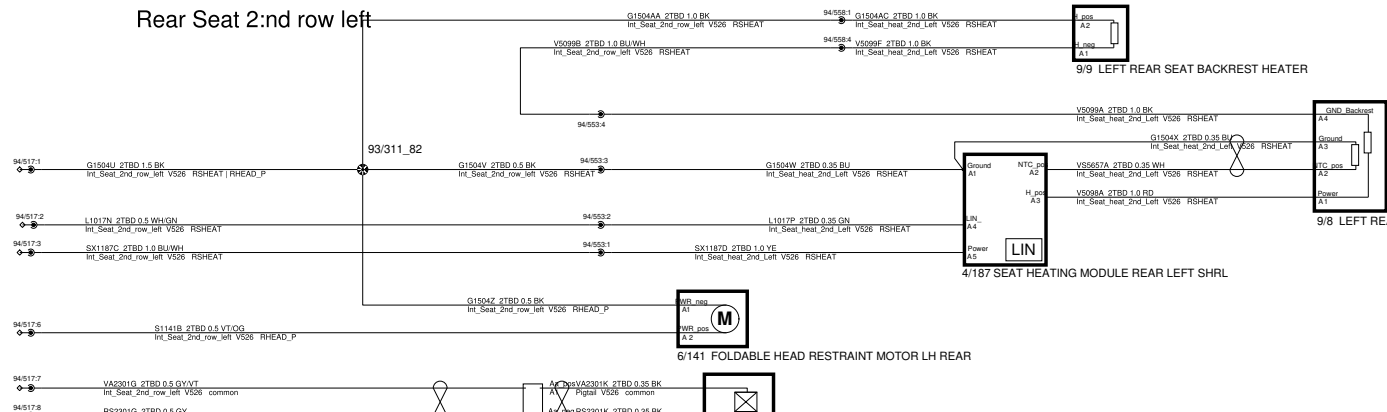

10A Rear Seat Internal Harness V526

Middle Seat 2:nd row

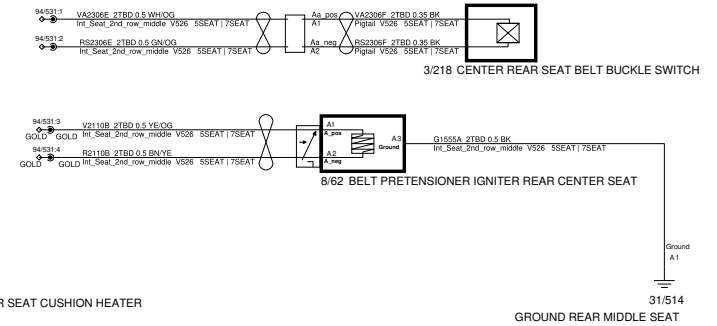

Rear Seat 2:nd row right

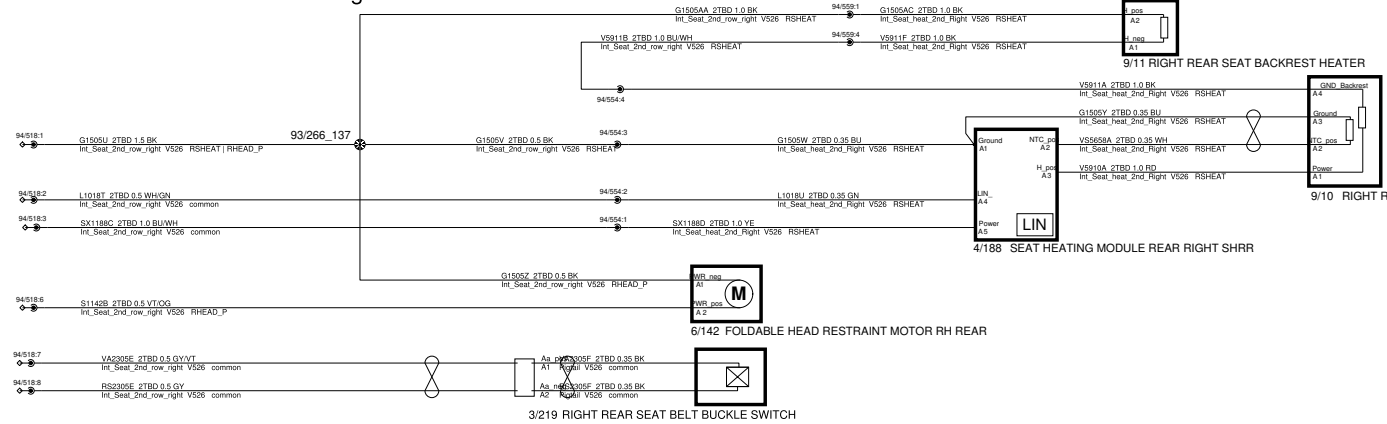

Rear Seat 3:rd Row

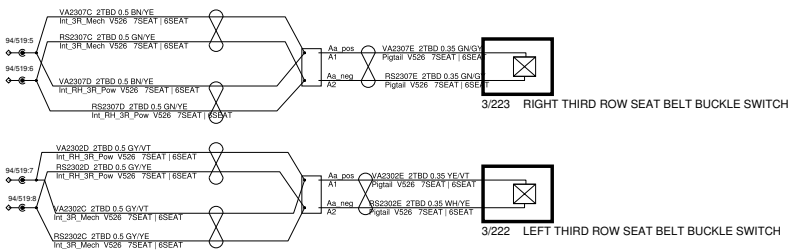

<p>The copying, distribution and utilization of this document as well as the communication of its contents to others without expressed authorization is prohibited. Offenders will be held liable for payment of damages. All rights reserved in the event of the grant of a patent, utility model or ornamental design registration.</p>	<p>Document title SPA_Issue25_Release1</p>	
	<p>10A_Rear_Seat_V526</p>	
<p><b>VOLVO</b> VOLVO CAR CORPORATION</p>	<p>Document Type DRAW/ELSY</p>	<p>Edited April/11/2023</p>
	<p>Release Status RELEASED</p>	
	<p>Document No 33409142</p>	<p>Issue 035</p>



# 10A Rear Seat Internal Harness V541

## Rear Seat 2:nd row left V541

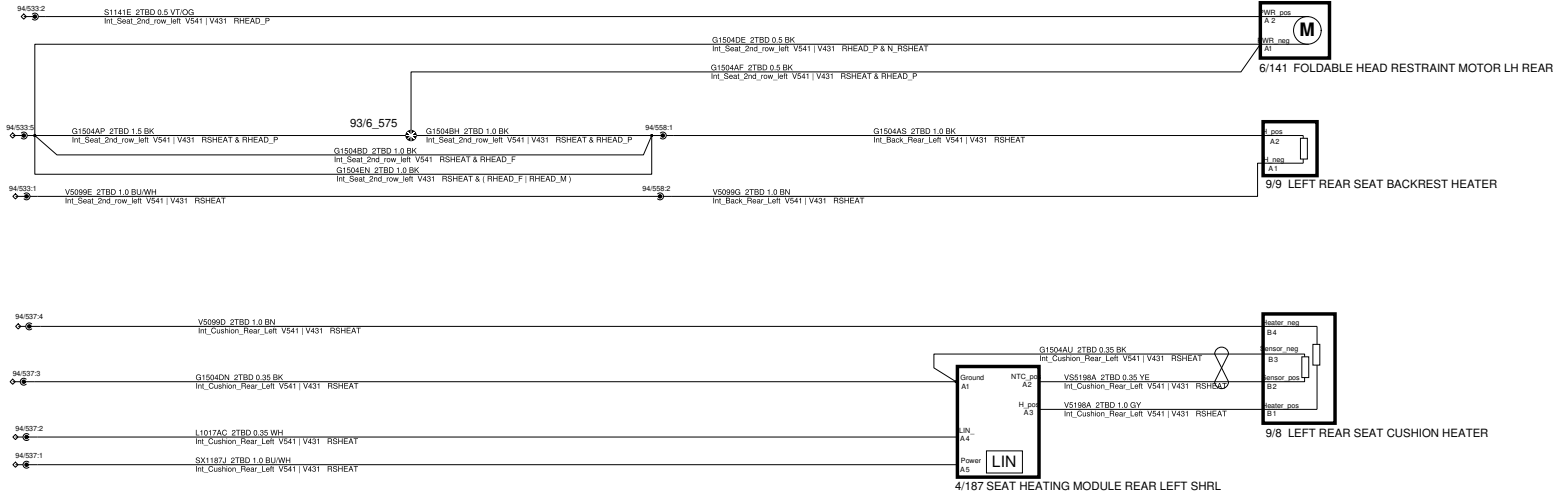

## Rear Seat 2:nd row right V541

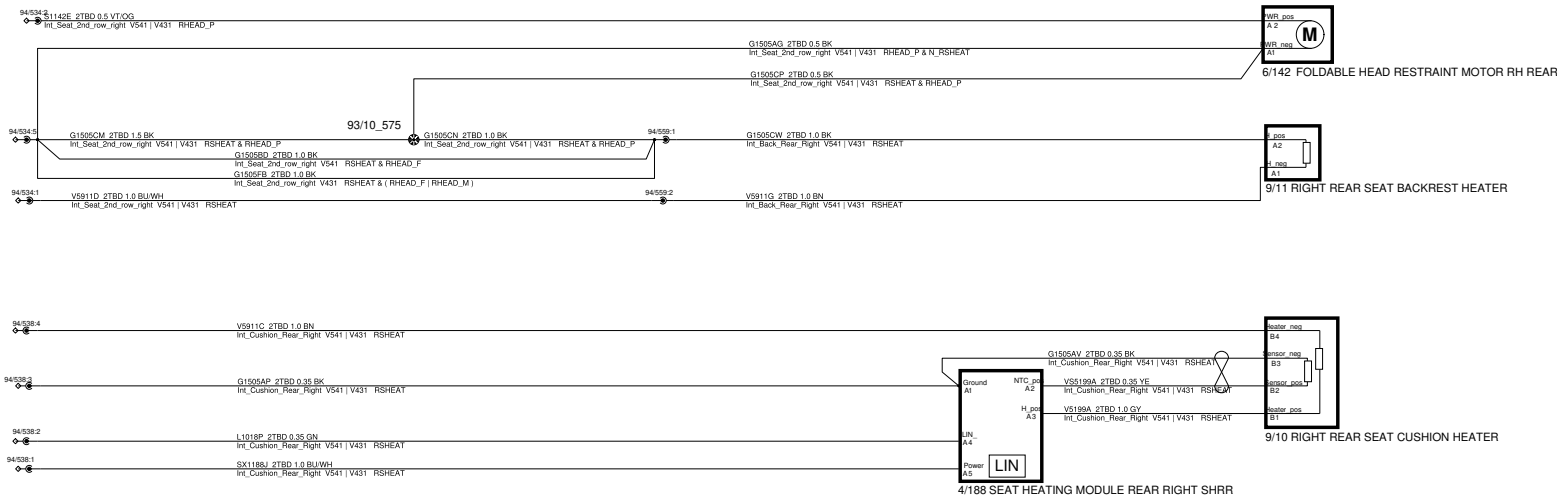

<p>The copying, distribution and utilization of this document as well as the communication of its contents to others without expressed authorization is prohibited. Offenders will be held liable for payment of damages. All rights reserved in the event of the grant of a patent, utility model or ornamental design registration.</p> <p><b>VOLVO</b> VOLVO CAR CORPORATION</p>	<b>Document title</b> SPA_Issue25_Release1 10A_Rear_Seat_V541_V431	
	<b>Document Type</b> DRAW/ELSY	<b>Edited</b> June/16/2021
	<b>Release Status</b> RELEASED	
	<b>Document No</b> 33409142	<b>Issue</b> 035

# 10A Rear Seat Internal Harness V542/V543/V426/V432/V433

## Rear Seat 2:nd row left V542/V543

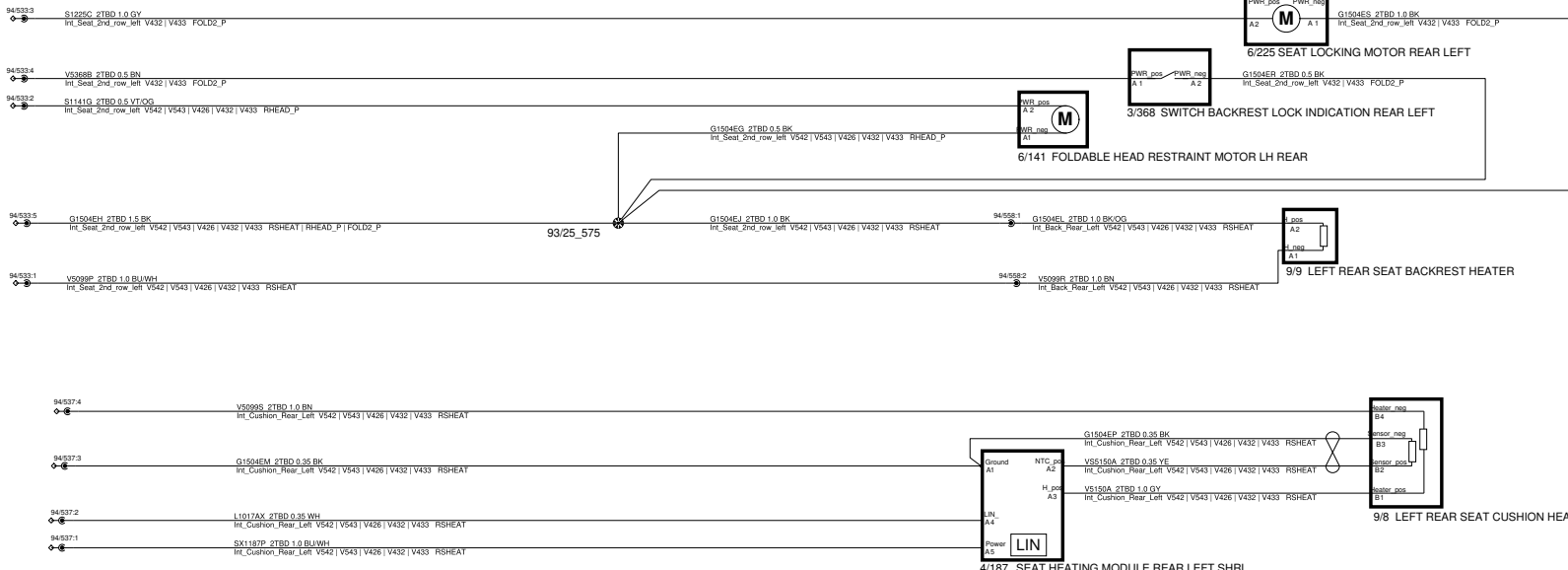

## Rear Seat 2:nd row right V542/V543

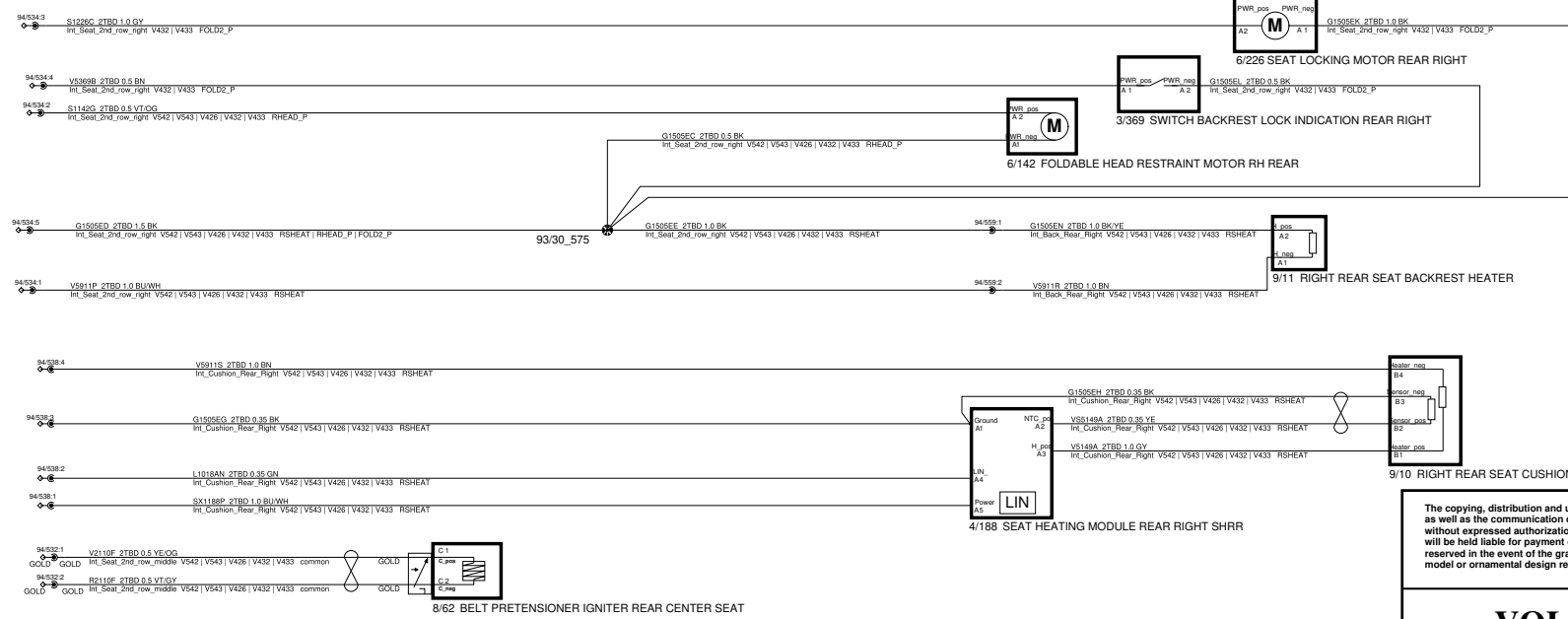

<p>The copying, distribution and utilization of this document as well as the communication of its contents to others without expressed authorization is prohibited. Offenders will be held liable for payment of damages. All rights reserved in the event of the grant of a patent, utility model or ornamental design registration.</p> <p style="text-align: center;"><b>VOLVO</b> VOLVO CAR CORPORATION</p>		<p>Document title SPA_Issue25_Release1 10A_Rear_Seat_V542_V543_V432_V433</p>	
		<p>Document Type DRAW/ELSY</p>	<p>Edited April/11/2023</p>
<p>Document No 33409142</p>		<p>Release Status RELEASED</p>	
		<p>Issue 035</p>	<p>Page No 169/177</p>

Police Floor Harness

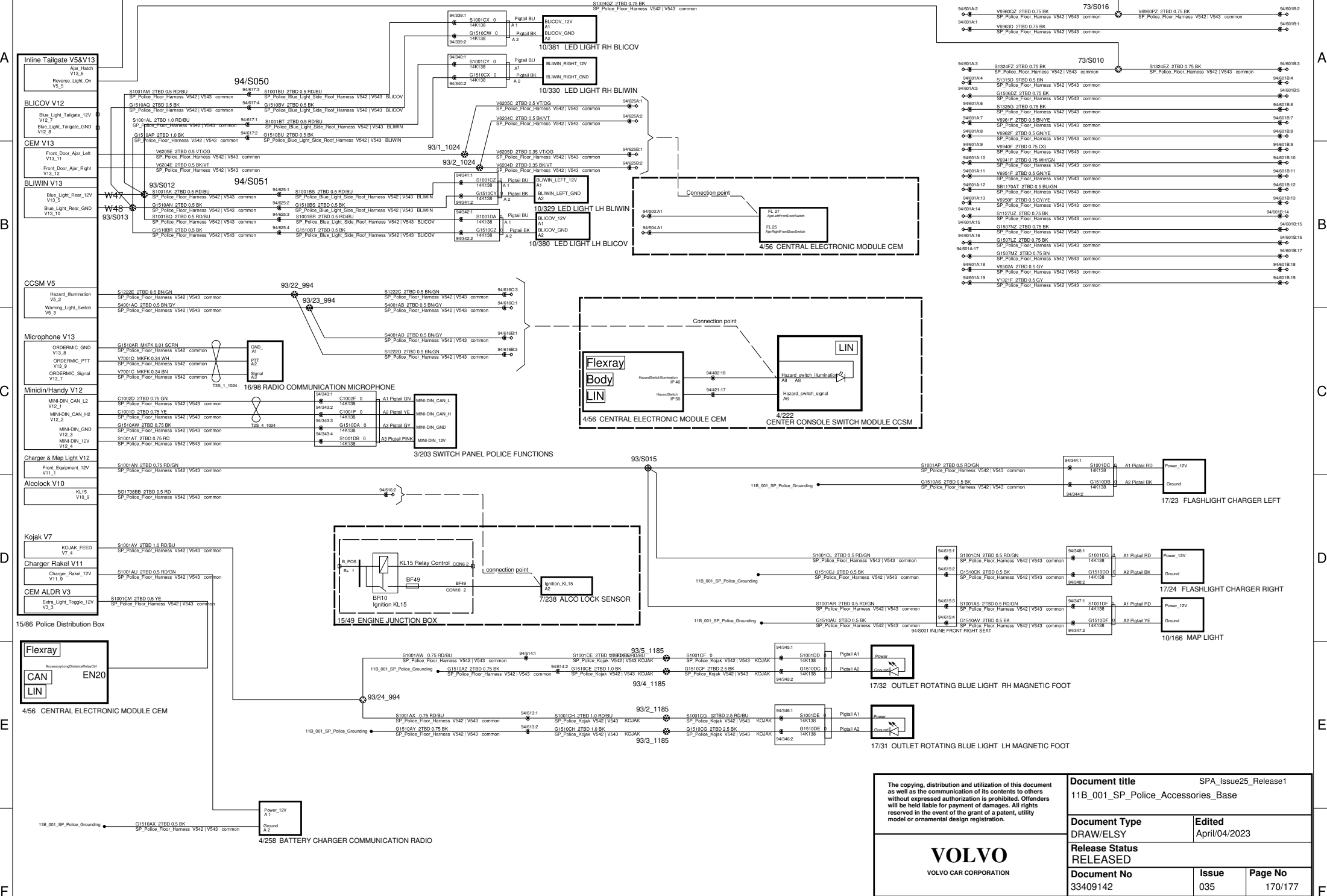

The copying, distribution and utilization of this document as well as the communication of its contents to others without expressed authorization is prohibited. Offenders will be held liable for payment of damages. All rights reserved in the event of the grant of a patent, utility model or ornamental design registration.		Document title		SPA_Issue25_Release1	
		Document Type		DRAW/ELSY	
		Release Status		RELEASED	
		Document No		33409142	
		Issue		035	
		Page No		170/177	

**VOLVO**  
VOLVO CAR CORPORATION

# 11B\_001\_SP Police Accessories Base 2

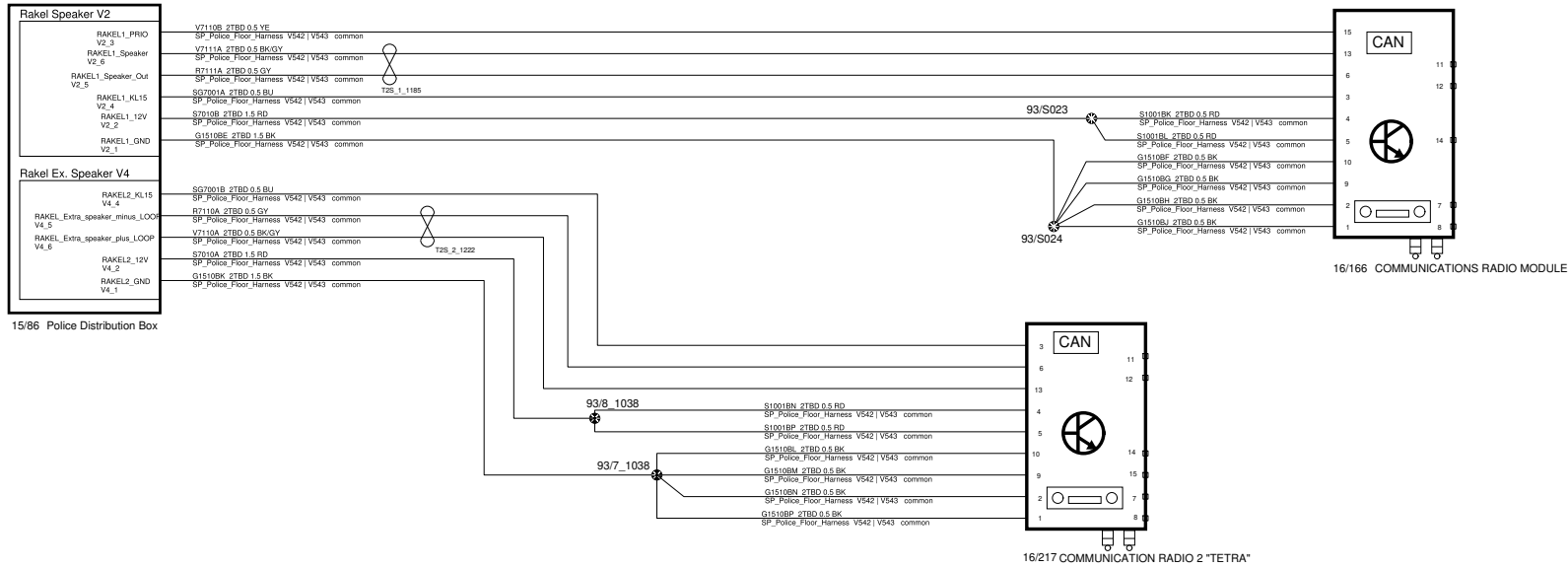

The copying, distribution and utilization of this document as well as the communication of its contents to others without expressed authorization is prohibited. Offenders will be held liable for payment of damages. All rights reserved in the event of the grant of a patent, utility model or ornamental design registration.	<b>Document title</b> SPA_Issue25_Release1 11B_001_SP_Police_Accessories_Base_2	
	<b>Document Type</b> DRAW/ELSY	<b>Edited</b> June/16/2021
 VOLVO CAR CORPORATION	<b>Release Status</b> RELEASED	
	<b>Document No</b> 33409142	<b>Issue</b> 035
	<b>Page No</b> 171/177	

# 11B\_001\_SP Police Accessories Engine Bay

## Engine Bay

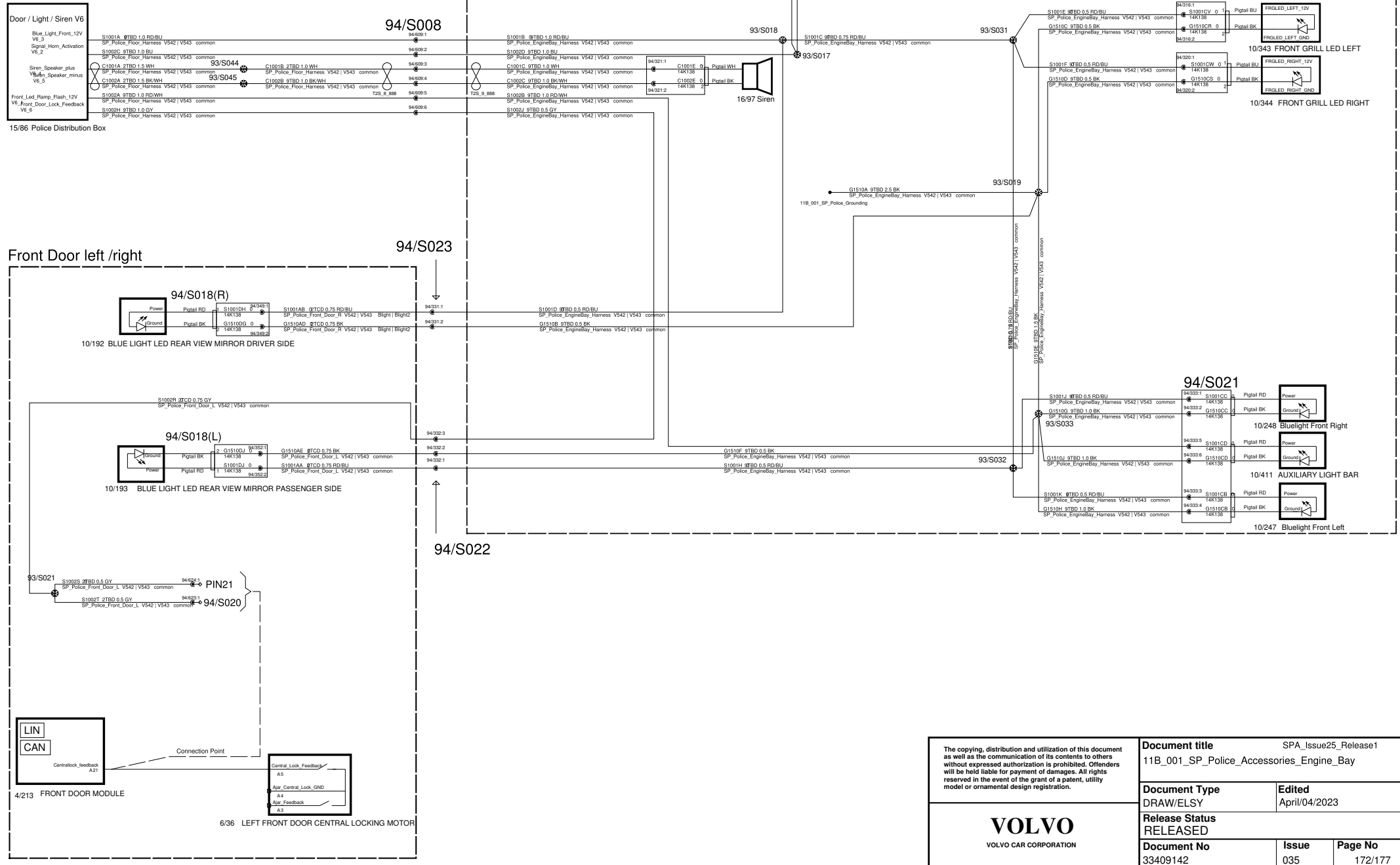

The copying, distribution and utilization of this document as well as the communication of its contents to others without expressed authorization is prohibited. Offenders will be held liable for payment of damages. All rights reserved in the event of the grant of a patent, utility model or ornamental design registration.

**VOLVO**  
VOLVO CAR CORPORATION

<b>Document title</b>		SPA_Issue25_Release1	
11B_001_SP_Police_Accessories_Engine_Bay			
<b>Document Type</b>	DRAW/ELSY	<b>Edited</b>	April/04/2023
<b>Release Status</b>		RELEASED	
<b>Document No</b>	33409142	<b>Issue</b>	035
		<b>Page No</b>	172/177

# 11B\_001\_SP Police Accessories Power Supply

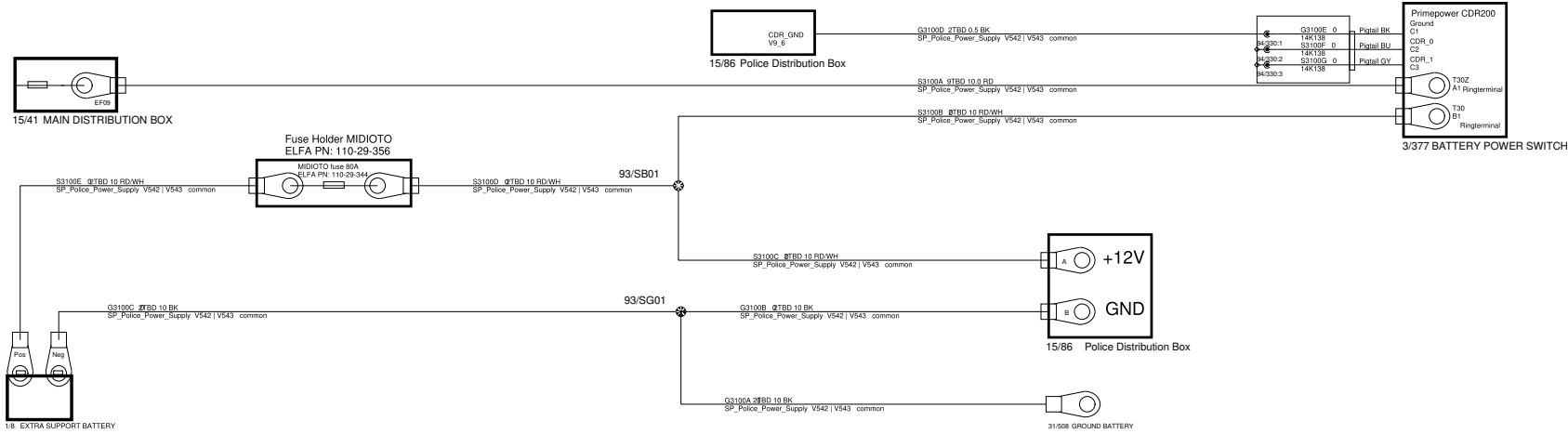

<p>The copying, distribution and utilization of this document as well as the communication of its contents to others without expressed authorization is prohibited. Offenders will be held liable for payment of damages. All rights reserved in the event of the grant of a patent, utility model or ornamental design registration.</p> <p><b>VOLVO</b> VOLVO CAR CORPORATION</p>	<b>Document title</b> SPA_Issue25_Release1 11B_001_SP_Police_Accessories_Power_Supply	
	<b>Document Type</b> DRAW/ELSY	<b>Edited</b> April/04/2023
	<b>Release Status</b> RELEASED	
	<b>Document No</b> 33409142	<b>Issue</b> 035

POLICE REAR DOOR/BUMPER HARNESS

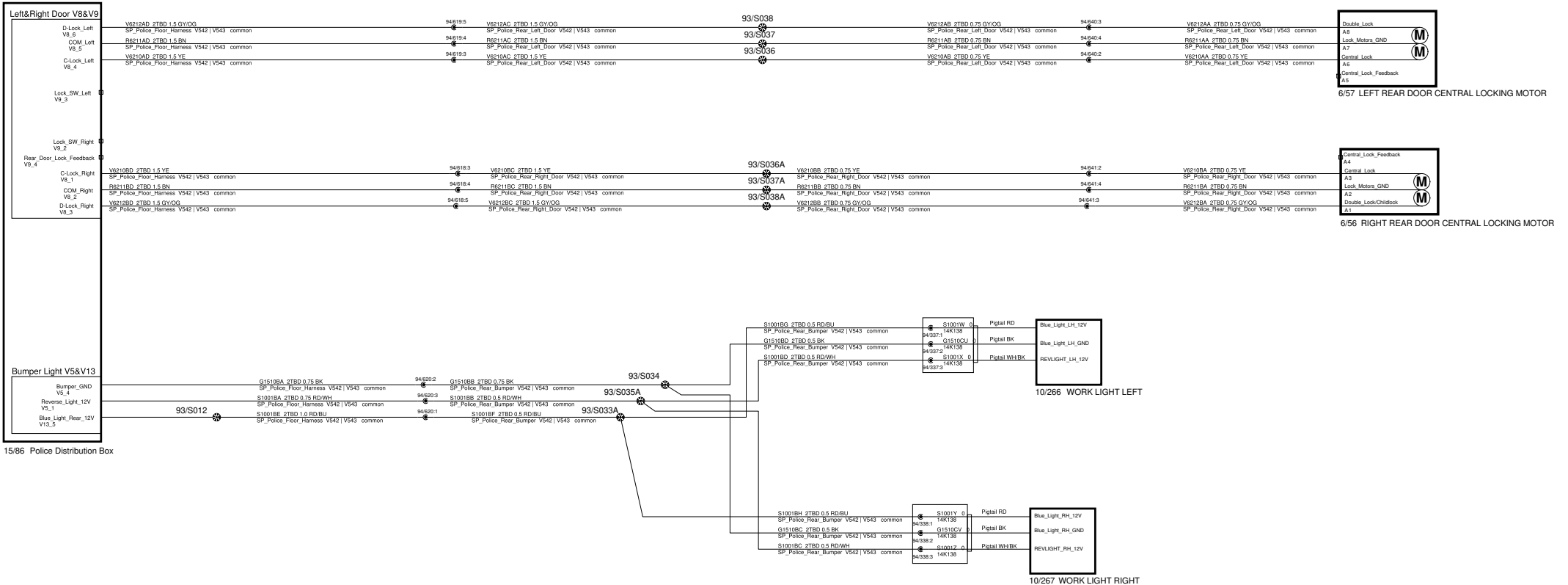

<p>The copying, distribution and utilization of this document as well as the communication of its contents to others without expressed authorization is prohibited. Offenders will be held liable for payment of damages. All rights reserved in the event of the grant of a patent, utility model or ornamental design registration.</p> <p><b>VOLVO</b> VOLVO CAR CORPORATION</p>	<p><b>Document title</b> SPA_Issue25_Release1 11B_001_SP_Police_Accessories_Rear_Door</p>		
	<p><b>Document Type</b> DRAW/ELSY</p>	<p><b>Edited</b> April/04/2023</p>	
	<p><b>Release Status</b> RELEASED</p>		
	<p><b>Document No</b> 33409142</p>	<p><b>Issue</b> 035</p>	<p><b>Page No</b> 174/177</p>

POLICE RAKEL ROOF SPEAKER / LIGHTBAR / ROOF TAILGATE / STOP LIGHT HARNESS

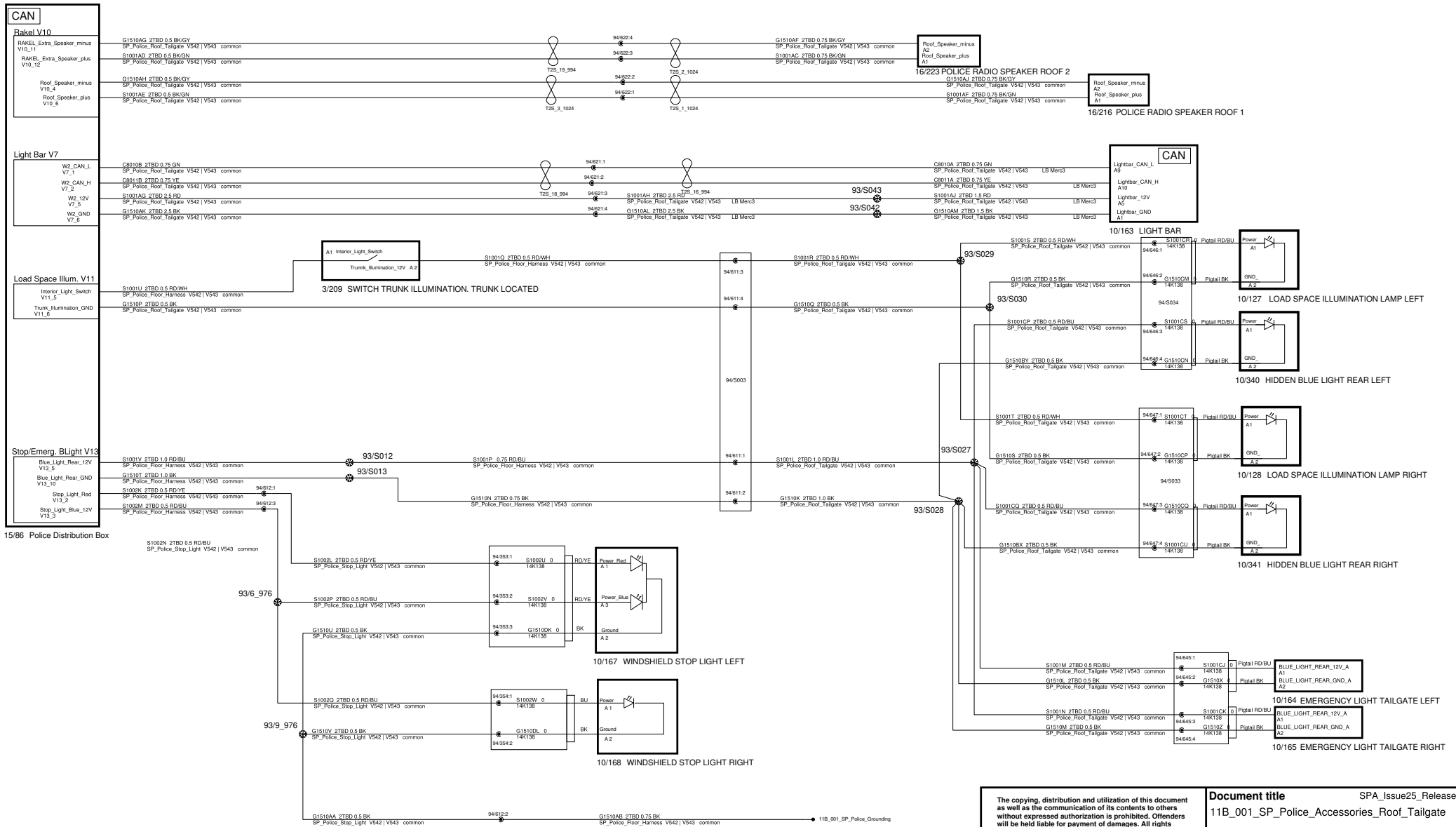

<p>The copying, distribution and utilization of this document as well as the communication of its contents to others without expressed authorization is prohibited. Offenders will be held liable for payment of damages. All rights reserved in the event of the grant of a patent, utility model or ornamental design registration.</p>		<p>Document title SPA_Issue25_Release1</p>	
		<p>11B_001_SP_Police_Accessories_Roof_Tailgate</p>	
<p>Document Type DRAW/ELSY</p>		<p>Edited April/04/2023</p>	
<p>Release Status RELEASED</p>			
<p>Document No 33409142</p>		<p>Issue 035</p>	<p>Page No 175/177</p>

**VOLVO**  
VOLVO CAR CORPORATION



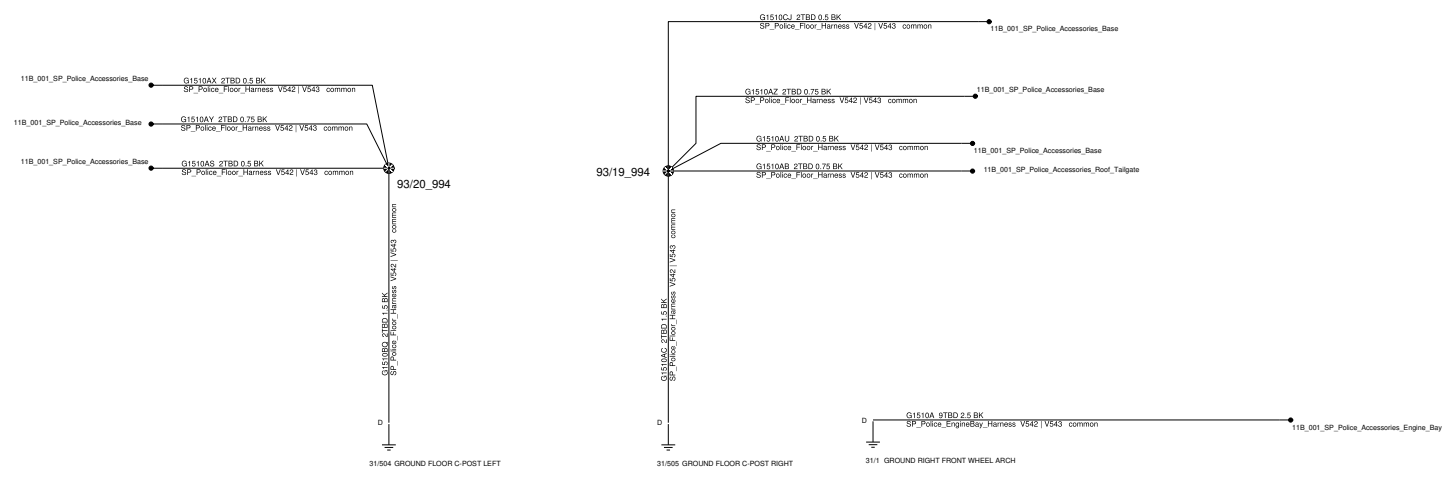

<p>The copying, distribution and utilization of this document as well as the communication of its contents to others without expressed authorization is prohibited. Offenders will be held liable for payment of damages. All rights reserved in the event of the grant of a patent, utility model or ornamental design registration.</p> <p><b>VOLVO</b> VOLVO CAR CORPORATION</p>	<p><b>Document title</b> SPA_Issue25_Release1 11B_001_SP_Police_Grounding</p>		
	<p><b>Document Type</b> DRAW/ELSY</p>	<p><b>Edited</b> June/16/2021</p>	
	<p><b>Release Status</b> RELEASED</p>		
	<p><b>Document No</b> 33409142</p>	<p><b>Issue</b> 035</p>	<p><b>Page No</b> 176/177</p>

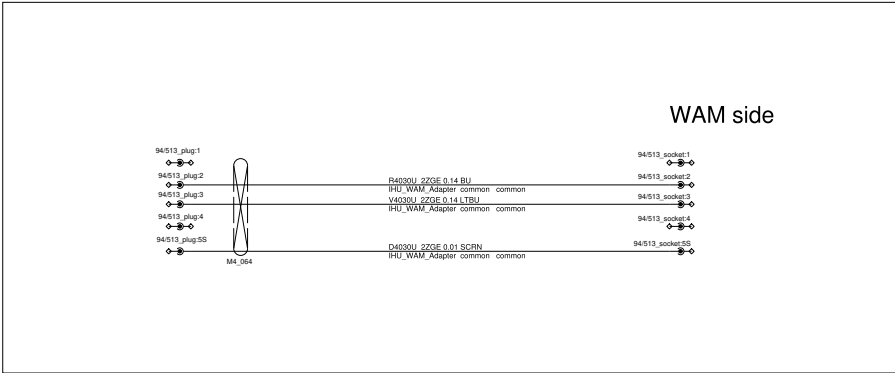

<p>The copying, distribution and utilization of this document as well as the communication of its contents to others without expressed authorization is prohibited. Offenders will be held liable for payment of damages. All rights reserved in the event of the grant of a patent, utility model or ornamental design registration.</p> <p><b>VOLVO</b> VOLVO CAR CORPORATION</p>	<p><b>Document title</b> SPA_Issue25_Release1 IHU_WAM_Service_Adapter_Harness</p>		
	<p><b>Document Type</b> DRAW/ELSY</p>	<p><b>Edited</b> April/03/2017</p>	
	<p><b>Release Status</b> RELEASED</p>		
	<p><b>Document No</b> 33409142</p>	<p><b>Issue</b> 035</p>	<p><b>Page No</b> 177/177</p>