

**Volvo Car USA LLC****Service Journal**

Bulletin Title		Ref NO	
Aftermarket Wiring Diagrams CMA MY24		SJ1001860	
Issuer (Dept.)	Car Market	Issue Date	Status Date
Service Operations	United States and Canada	4/25/23	4/25/23
Revisions		Page	
		Page 1 of 147	

**Background:**

As a result of delays in the production of aftermarket wiring diagrams, there is a risk of missing or incorrect wiring diagrams for certain customer functions for CMA MY24 (structure week 202317 - ).

Models included:

XC40 BEV, XC40 Non-BEV, C40

**Temporary Solution:**

In cases of missing or incorrect wiring diagrams in VIDA, refer to the cleaned-up system-based wiring diagrams from R&D attached as a PDF.

**Final Solution:**

Customer function-based wiring diagrams will continuously be updated and released to VIDA once they are finished.

# P319/V316/V317

## 623A\_PP | 624A\_VP

Sheet Name	Sheet Number	Sheet Name	Sheet Number
0A_P319_V316_V317	1	2P_Supplementary_Restraint_System_Igniters_HEV_PHEV	74
0B1_Overview_LHD	2	2P_Supplementary_Restraint_System_Igniters_N_HEV	75
0B2_Overview_RHD	3	2P_Supplementary_Restraint_System_Igniters_PHEV	76
1A1_Electrical_distribution_CJB_BEV	4	2R_Safety_Belt	77
1A1_Electrical_distribution_CJB_N_BEV	5	2S_Restraint	78
1A1_Electrical_distribution_EJB_BEV	6	3A_3C_Engine_management	79
1A1_Electrical_distribution_EJB_N_BEV	7	3A_3D_Engine_Management_(HEV)	80
1A3_System_relays_control_BEV	8	3A_3D_Engine_Management_VEP4_GEN3_(HEV)	81
1A3_System_relays_control_HEV	9	3A_Engine_Management_GEP3_(HEV)	82
1B1_Grounding_Engine_Body	10	3A_Engine_Management_VEP4_G3_(N_BEV)	83
1B2_Grounding_IP_Roof_Tunnel	11	3B_Management_BEV_Driveline	84
1B3_Grounding_Body_Front	12	3B_Management_Hybrid_Driveline_HEV	85
1B4_Grounding_Body_Rear_Tailgate	13	3D_Engine_thermal_management_BEV	86
1C1_EI_power_generating	14	3D_Engine_thermal_management_HEV	87
1D_Diagnostics	15	3E_Automatic_Gear_Shifting	88
1E_CAN_ABS_Braking	16	3E_Automatic_Gear_Shifting_7DCT	89
1E_CAN_Body	17	3G_4WD_Transmission	90
1E_CAN_Body_Exp	18	3M_Engine_Cranking_Control_(HEV)	91
1E_CAN_Chassie	19	3S_Fuel_Supply_Control	92
1E_CAN_Connectivity_Diagnostics	20	4A_Driver_Information	93
1E_CAN_Engine	21	4J1_Parking_Assistance_FAP	94
1E_CAN_Front_1	22	4J1_Parking_Assistance_NBEV	95
1E_CAN_Front_3	23	4J1_Parking_Assistance_PAS_PAS2	96
1E_CAN_Front_Exposed	24	4J2B_Lane_Change_Aid	97
1E_CAN_Mid_1	25	4J4_PAC_COAX	98
1E_CAN_Propulsion_1A_Front	26	5A_Climate_Control	99
1E_CAN_Propulsion_1B_Front_Hybrid	27	5A_Climate_Control_HEV_PHEV	100
1E_CAN_Propulsion_2_Centre	28	5A_Climate_Control_HVAC_ECC	101
1E_CAN_Rear_1	29	5B_Front_Seat_Comfort	102
1E_CAN_Safety_Exposed_BEV_48V_KERS	30	5B_Front_Seat_Comfort_PHEV	103
1E_CAN_Safety_Exposed_ICE_PHEV	31	5B_Rear_Seat_Comfort	104
1E_CAN_Safety_Protected	32	5F1_Passenger_Compartment_Pre-Conditioning	105
1E_FlexRay_Backbone_BEV_48V_KERS	33	5G_Steering_Wheel_Heating	106
1E_FlexRay_Backbone_ICE_PHEV	34	6A_Locking	107
1E_FlexRay_Front_2	35	6A_Locking_Front_Right	108
1E_FlexRay_Mid_2	36	6A_Locking_Rear_Right	109
1E_LIN_Body	37	6C1_Phone_As_Key	110
1E_LIN_Body_Infotainment_Powertrain	38	6C_Theft_protection	111
1E_LIN_Comfort	39	6D_Window_Manoeuvring	112
1E_LIN_MOST	40	6D_Window_Manoeuvring_Right	113
1E_LIN_POWERTRAIN_N_BEV	41	6F_Roof_Manoeuvring	114
1F1_Accessories_ALCPRP_TOWBAR	42	6K_Tailgate_and_boot_lid_manoeuvring_etc	115
1F2_Accessories_Towing_System_4/7-pole_US	43	6P_Voltage_outlet	116
1F3_Accessories_Rear_Park_Assist_Camera	44	7A_External_Amplifier	117
1F4_Accessories_USB_Hub_Installation_Aftermarket	45	7A_Infotainment	118
1F5_Accessories_Steering_Wheel_Heating	46	7A_Infotainment_N_ICUP	119
1H1_EI_Distribution_High_Voltage_BEV_623A_AWD	47	7B_Telematics_ICUP	120
1H1_EI_Distribution_High_Voltage_BEV_623A_RWD	48	7B_Telematics_N_ICUP	121
1H2_EI_Distribution_High_Voltage_PHEV	49	7C_DSRC	122
1K1_EI_Energy_Management_High_Voltage_BEV_623	50	7C_DSRC_N_ICUP	123
1K2_EI_Energy_Management_High_Voltage_BEV_3X	51	7F_Electronic_Toll_Collection	124
1K3_EI_Energy_Management_High_Voltage_PHEV	52	8A_Exterior_Light_Front	125
1L1_EI_generating_public_network_1X	53	8A_Exterior_Light_LED_Front	126
1L2_EI_generating_public_network_2X	54	8A_Exterior_Light_Rear_V316	127
1L3_EI_generating_public_network_V331_3X-4X_DC	55	8A_Exterior_Light_Rear_V331_V317	128
1L4_EI_generating_public_network_V331_3X_AC	56	8K_8H_8J_Lamp_windscreen_rear_window_cleaning	129
1L5_EI_generating_public_network_V331_4X_AC	57	8K_8H_8J_Lamp_windscreen_rear_window_cleaning_NBEV	130
1L6_EI_generating_public_network_V316_V317_3X-4X_DC	58	8N_8L_Windscreen_rear_window_defroster	131
1L7_EI_generating_public_network_V316_V317_3X_AC	59	8P_Sound_signaling	132
1L8_EI_generating_public_network_V316_V317_4X_AC	60	9A_Interior_Lights	133
1L9_EI_generating_public_network_V316_PHEV	61	9A_Interior_Lights_Doors	134
1M_EI_Distribution_Mid_Voltage	62	9A_Interior_Lights_Doors_Right	135
2A_Braking	63	9H_Instr_Control_Switch_Lighting	136
2A_Braking_48V_KERS	64	10A_Internal_7DCT_Harness	137
2A_Braking_F-TE	65	10A_Driver_Seat_Internal_Harness_High_LHD	138
2A_Braking_Hybrid	66	10A_Driver_Seat_Internal_Harness_High_RHD	139
2E2_Steering	67	10A_Driver_Seat_Internal_Harness_Mech_LHD	140
2E_Power_Steering	68	10A_Driver_Seat_Internal_Harness_Mech_RHD	141
2G_Levelling_control	69	10A_Interior_HVAC_Harness_VCC_2-ZONES_ECC	142
2M_Pedestrian_Protection	70	10A_Passenger_Seat_Internal_Harness_High_LHD	143
2N_Safety_Belt_Reminder	71	10A_Passenger_Seat_Internal_Harness_High_RHD	144
2O_Collision_Avoidance	72	10A_Passenger_Seat_Internal_Harness_Mech_LHD	145
2P_Supplementary_Restraint_System_Igniters	73	10A_Passenger_Seat_Internal_Harness_Mech_RHD	146

<p>The copying, distribution and utilization of this document as well as the communication of its contents to others without expressed authorization is prohibited. Offenders will be held liable for payment of damages. All rights reserved in the event of the grant of a patent, utility model or ornamental design registration.</p> <p><b>VOLVO</b> VOLVO CAR CORPORATION</p>	<b>Document title</b> 623A_PP_CC_04_06_2023	
	0A_P319_V316_V317	
	<b>Document Type</b> DRAW/ELSY	<b>Release Status</b> RELEASED
	Volvo Document No 33445458	<b>Edited</b> April/21/2023
<b>Issue</b> 035	<b>Page No</b> 1/146	



# 0B Overview RHD

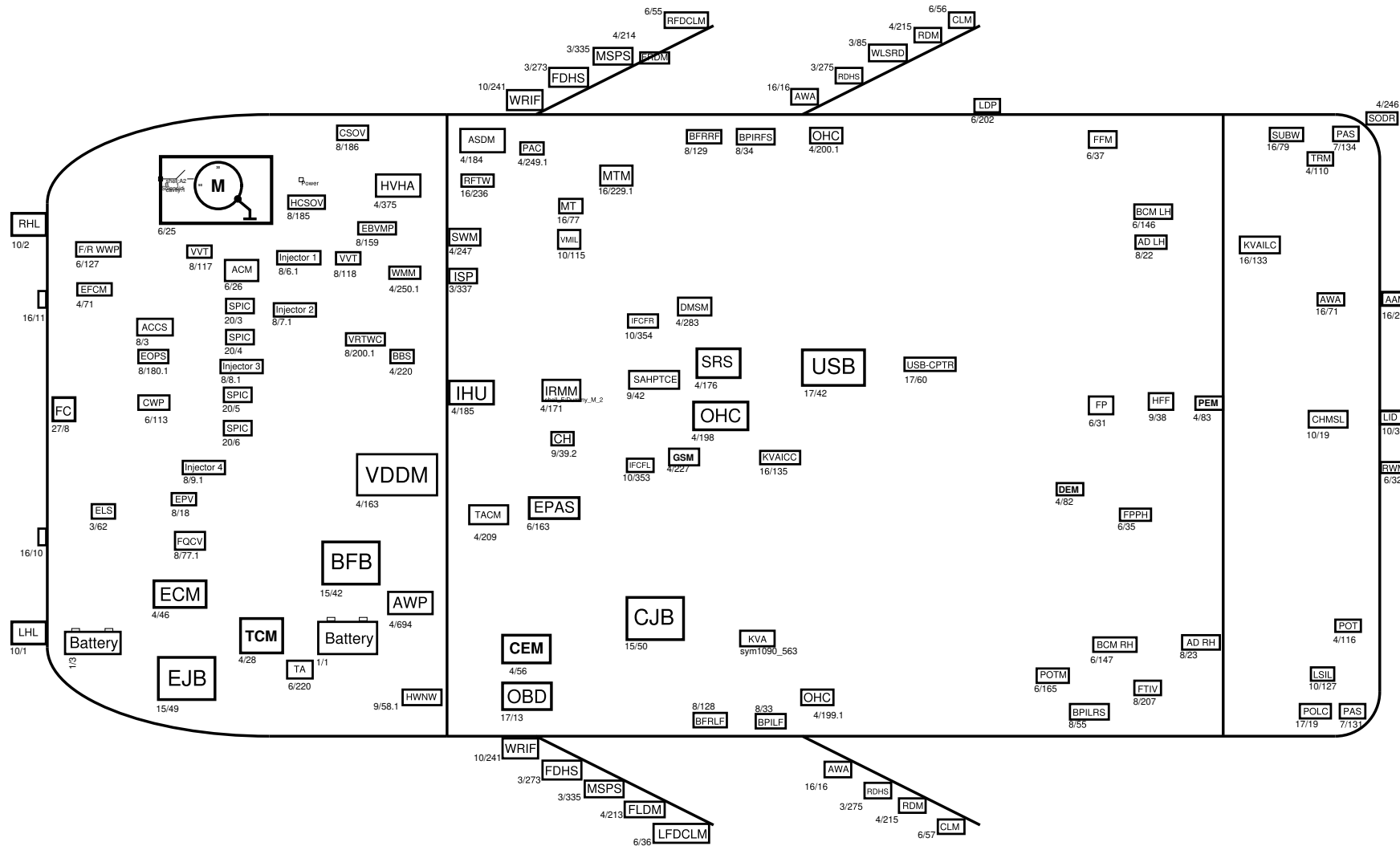

<p>The copying, distribution and utilization of this document as well as the communication of its contents to others without expressed authorization is prohibited. Offenders will be held liable for payment of damages. All rights reserved in the event of the grant of a patent, utility model or ornamental design registration.</p> <p><b>VOLVO</b> VOLVO CAR CORPORATION</p>	<p>Document title: 0B2_Overview_RHD</p>		<p>623A_PP_CC_04_06_2023</p>
	<p>Document Type: DRAW/ELSY</p>	<p>Release Status: RELEASED</p>	
	<p>Volvo Document No: 33445458</p>		<p>Edited: November/01/2021</p>
	<p>Issue: 035</p>		<p>Page No: 3/146</p>

# 1A1 Electrical distribution CJB BEV

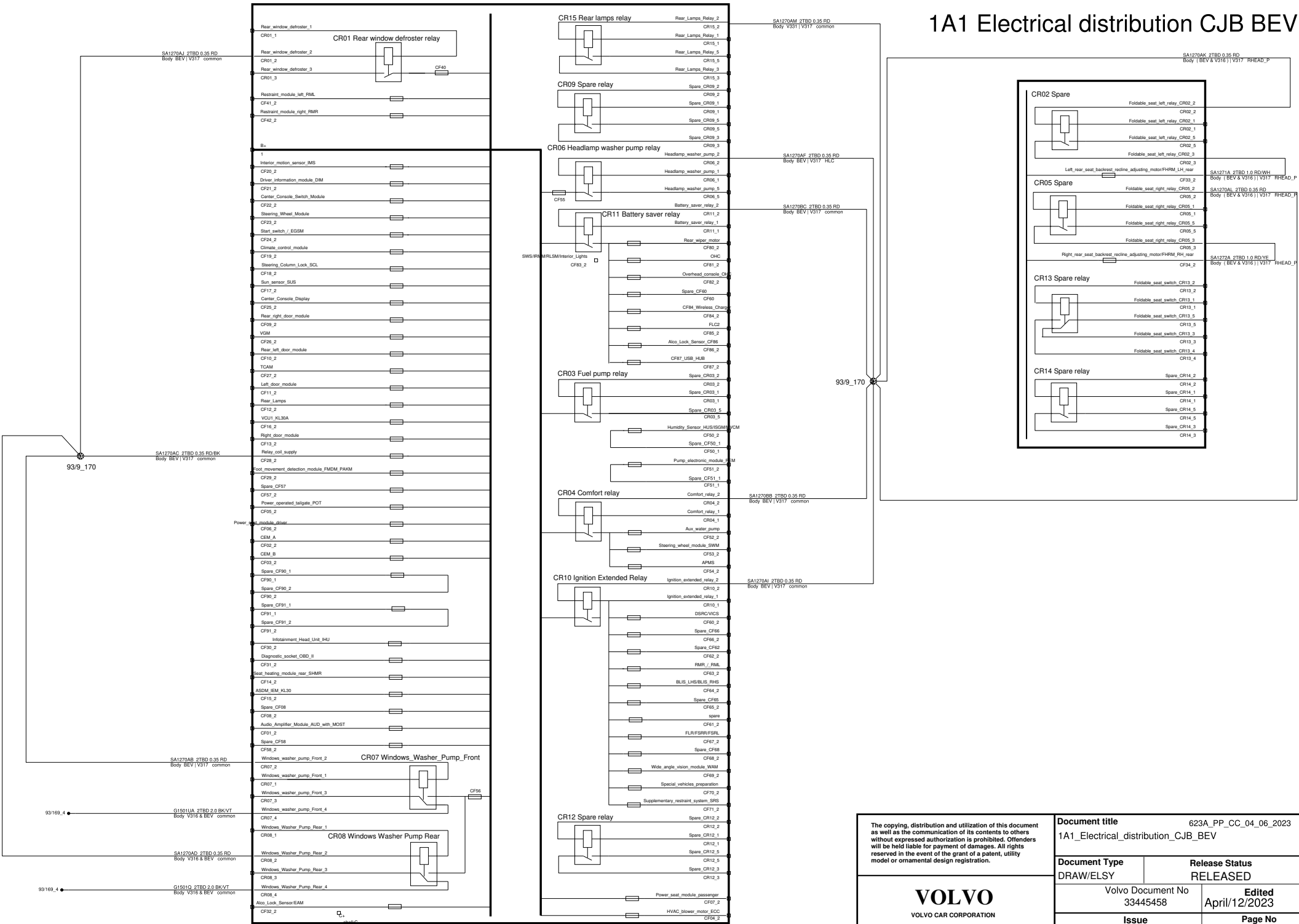

<p>The copying, distribution and utilization of this document as well as the communication of its contents to others without expressed authorization is prohibited. Offenders will be held liable for payment of damages. All rights reserved in the event of the grant of a patent, utility model or ornamental design registration.</p>		<p>Document title 623A_PP_CC_04_06_2023 1A1_Electrical_distribution_CJB_BEV</p>	
		<p>Document Type DRAW/ELSY</p>	<p>Release Status RELEASED</p>
<p><b>VOLVO</b> VOLVO CAR CORPORATION</p>		<p>Volvo Document No 33445458</p>	<p>Edited April/12/2023</p>
		<p>Issue 035</p>	<p>Page No 4/146</p>

# 1A1\_Electrical\_distribution\_CJB\_N\_BEV

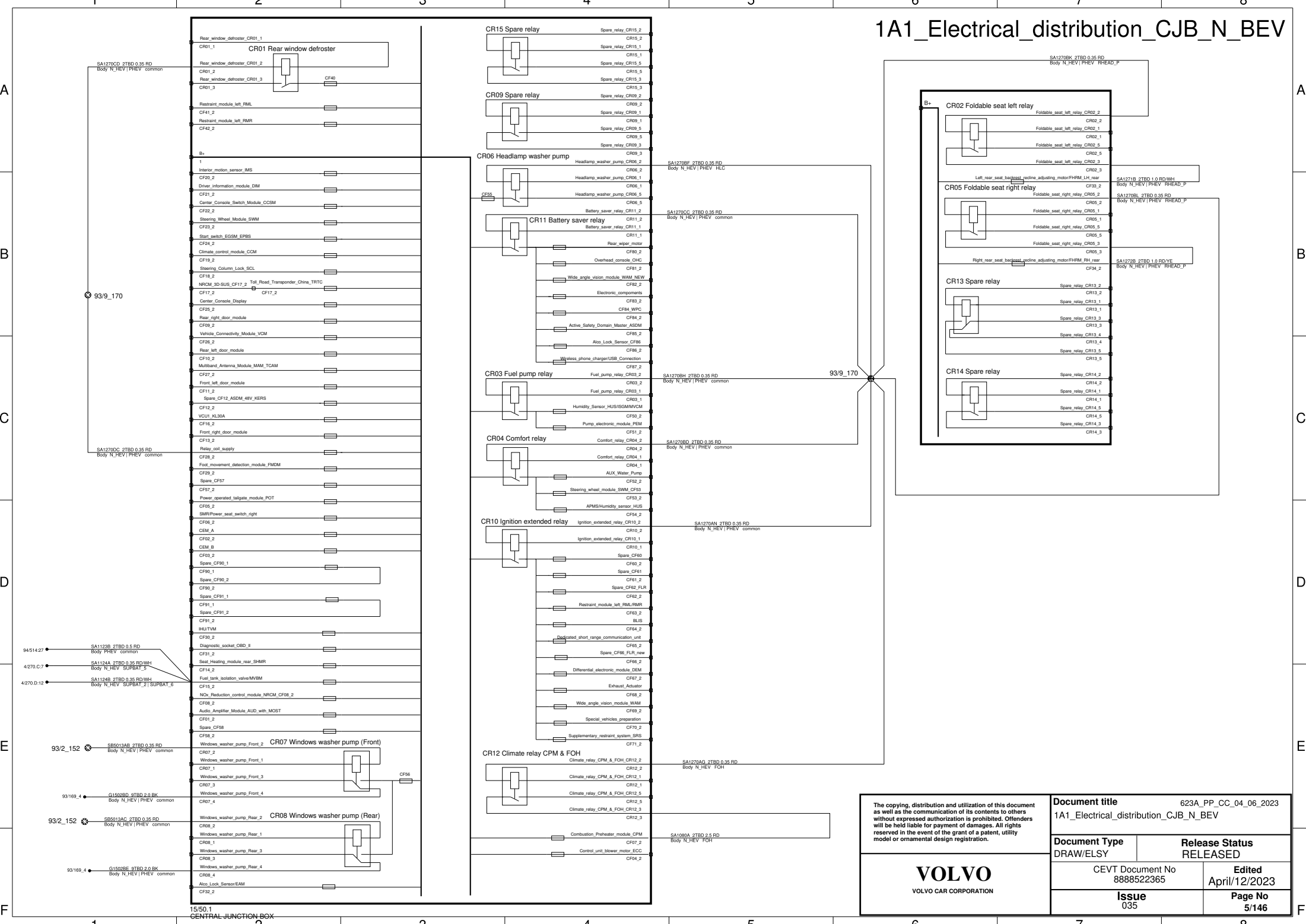

<p><b>VOLVO</b></p> <p>VOLVO CAR CORPORATION</p>	<p><b>Document title</b> 623A_PP_CC_04_06_2023</p> <p>1A1_Electrical_distribution_CJB_N_BEV</p>	
	<p><b>Document Type</b></p> <p>DRAW/ELSY</p>	<p><b>Release Status</b></p> <p>RELEASED</p>
	<p>CEVT Document No</p> <p>8888522365</p>	<p><b>Edited</b></p> <p>April/12/2023</p>
	<p><b>Issue</b></p> <p>035</p>	<p><b>Page No</b></p> <p>5/146</p>

# 1A1 Electrical distribution EJB BEV

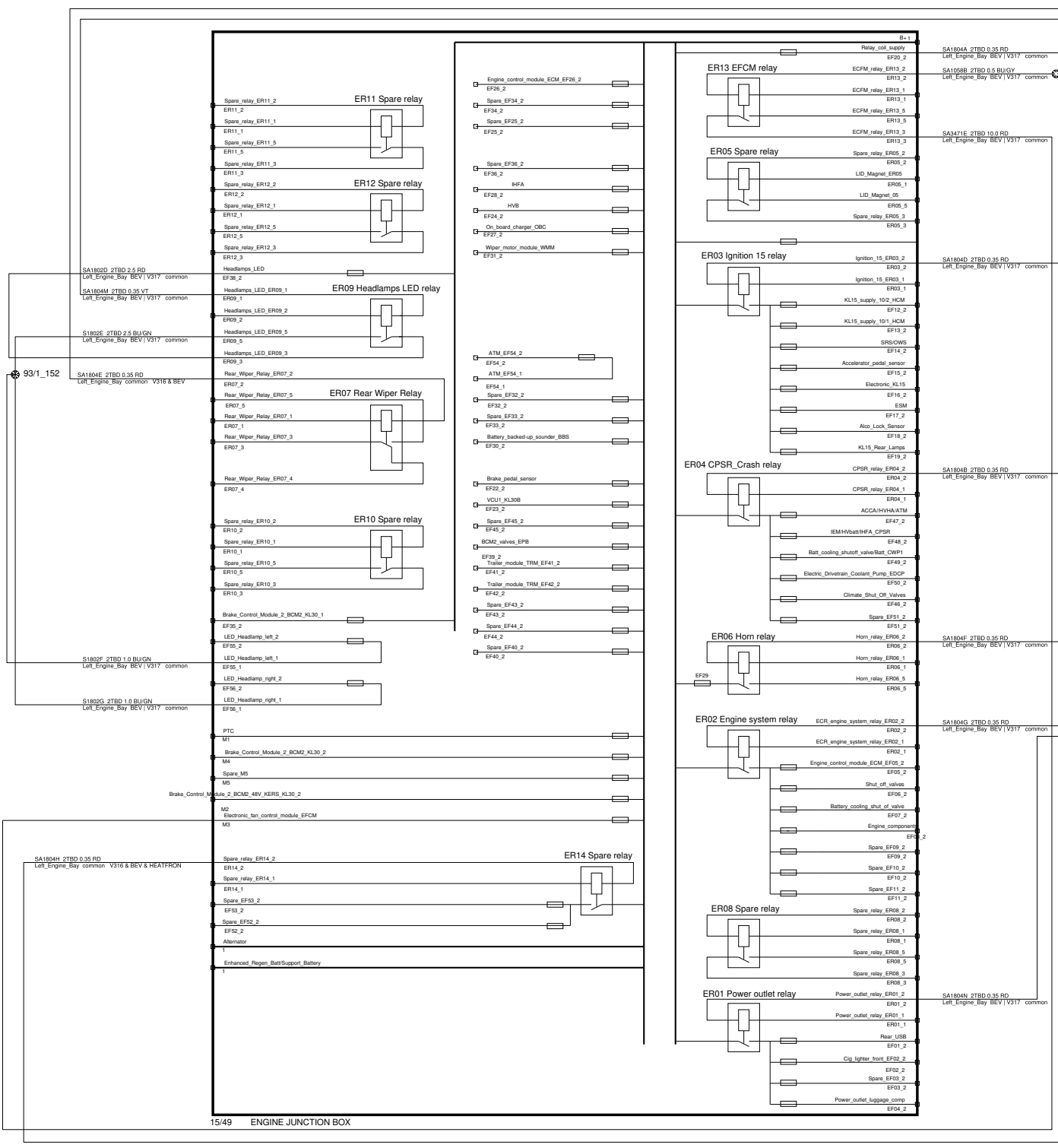

<p>The copying, distribution and utilization of this document as well as the communication of its contents to others without expressed authorization is prohibited. Offenders will be held liable for payment of damages. All rights reserved in the event of the grant of a patent, utility model or ornamental design registration.</p>		<p>Document title 623A_PP_CC_04_06_2023 1A1_Electrical_distribution_EJB_BEV</p>	
		<p>Document Type DRAW/ELSY</p>	<p>Release Status RELEASED</p>
<p><b>VOLVO</b> VOLVO CAR CORPORATION</p>		<p>Volvo Document No 33445458</p>	<p>Edited April/12/2023</p>
		<p>Issue 035</p>	<p>Page No 6/146</p>

A  
B  
C  
D  
E  
F

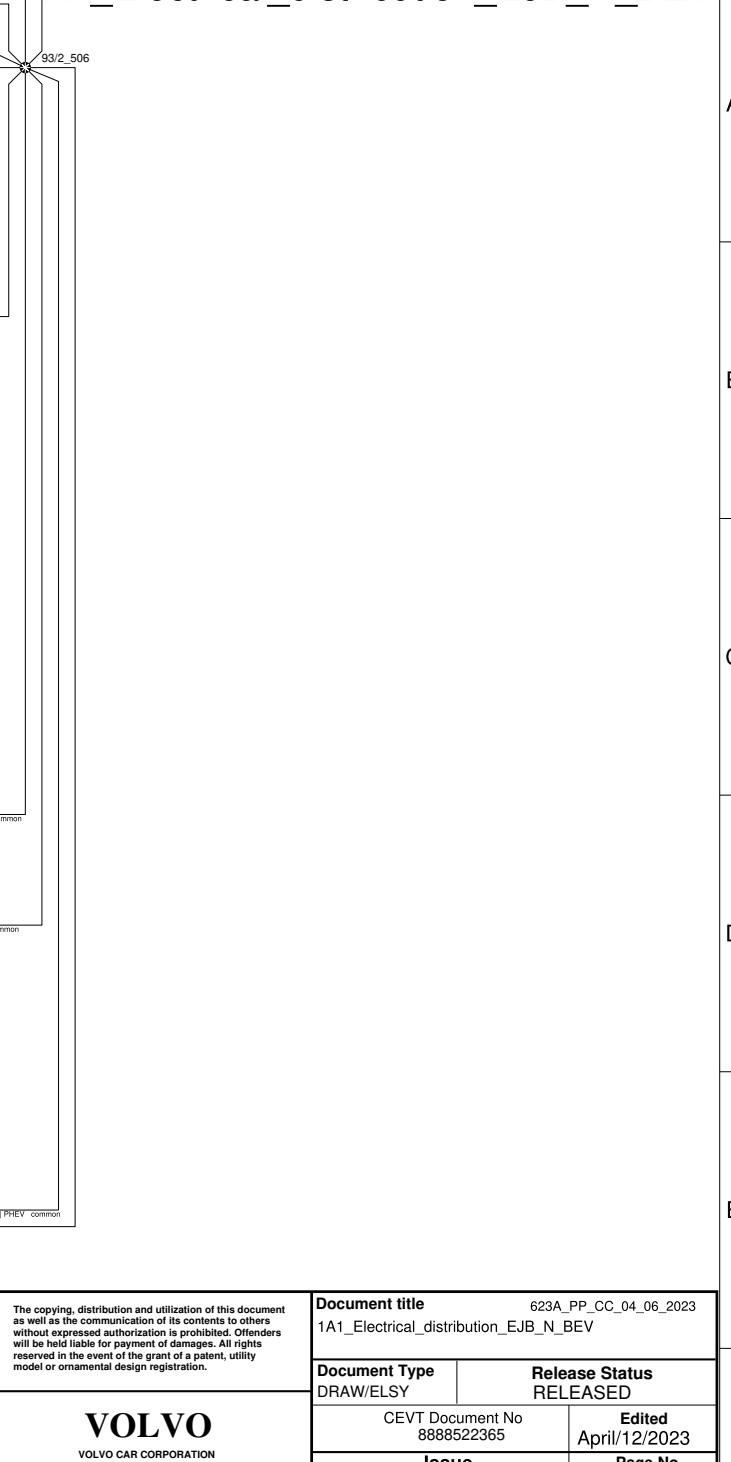
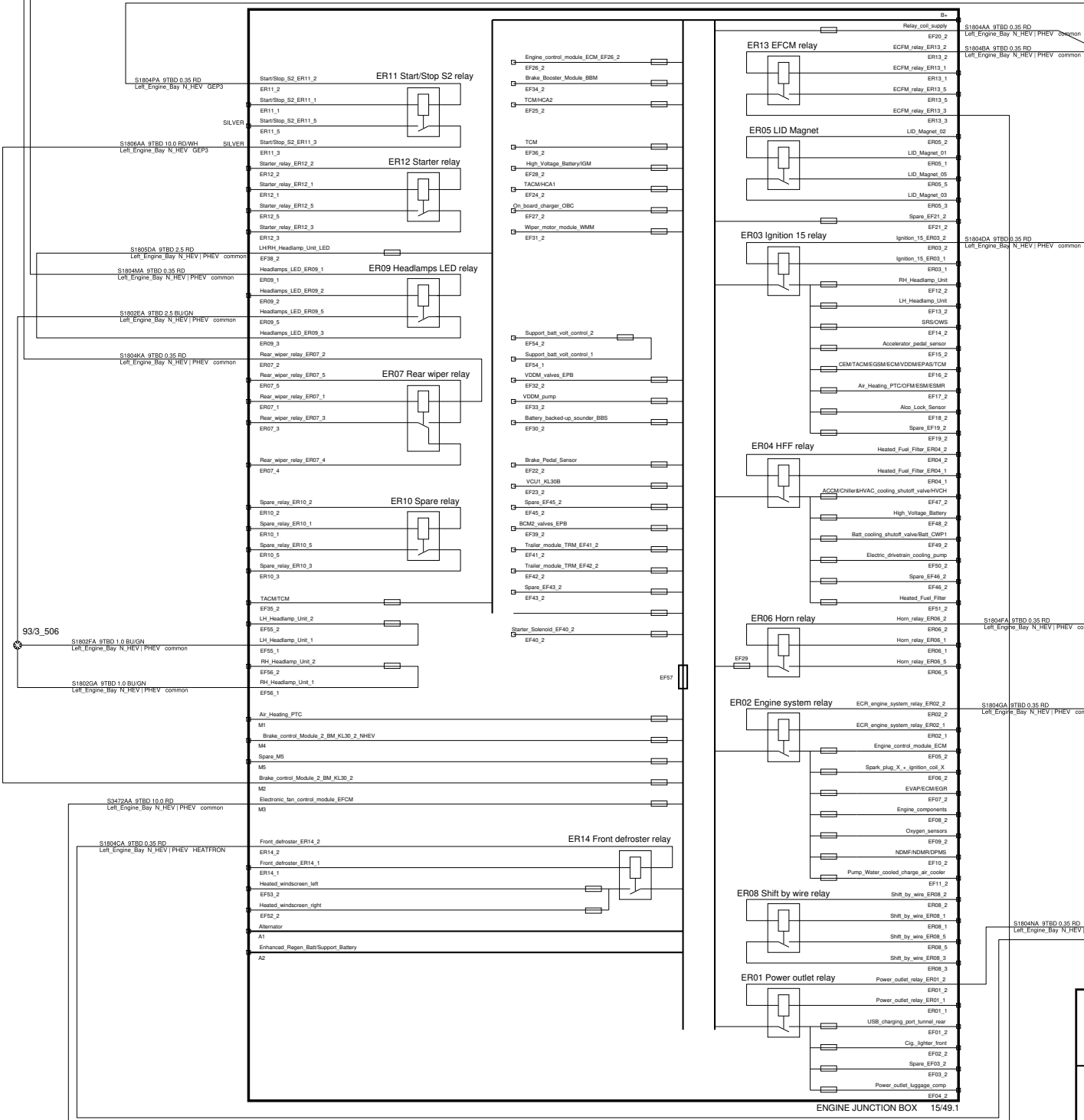

<p>The copying, distribution and utilization of this document as well as the communication of its contents to others without expressed authorization is prohibited. Offenders will be held liable for payment of damages. All rights reserved in the event of the grant of a patent, utility model or ornamental design registration.</p>		<p>Document title 623A_PP_CC_04_06_2023 1A1_Electrical_distribution_EJB_N_BEV</p>	
		<p>Document Type DRAW/ELSY</p>	<p>Release Status RELEASED</p>
<p><b>VOLVO</b> VOLVO CAR CORPORATION</p>		<p>CEVT Document No 8888522365</p>	<p>Edited April/12/2023</p>
		<p>Issue 035</p>	<p>Page No 7/146</p>



# 1A3 System relays control

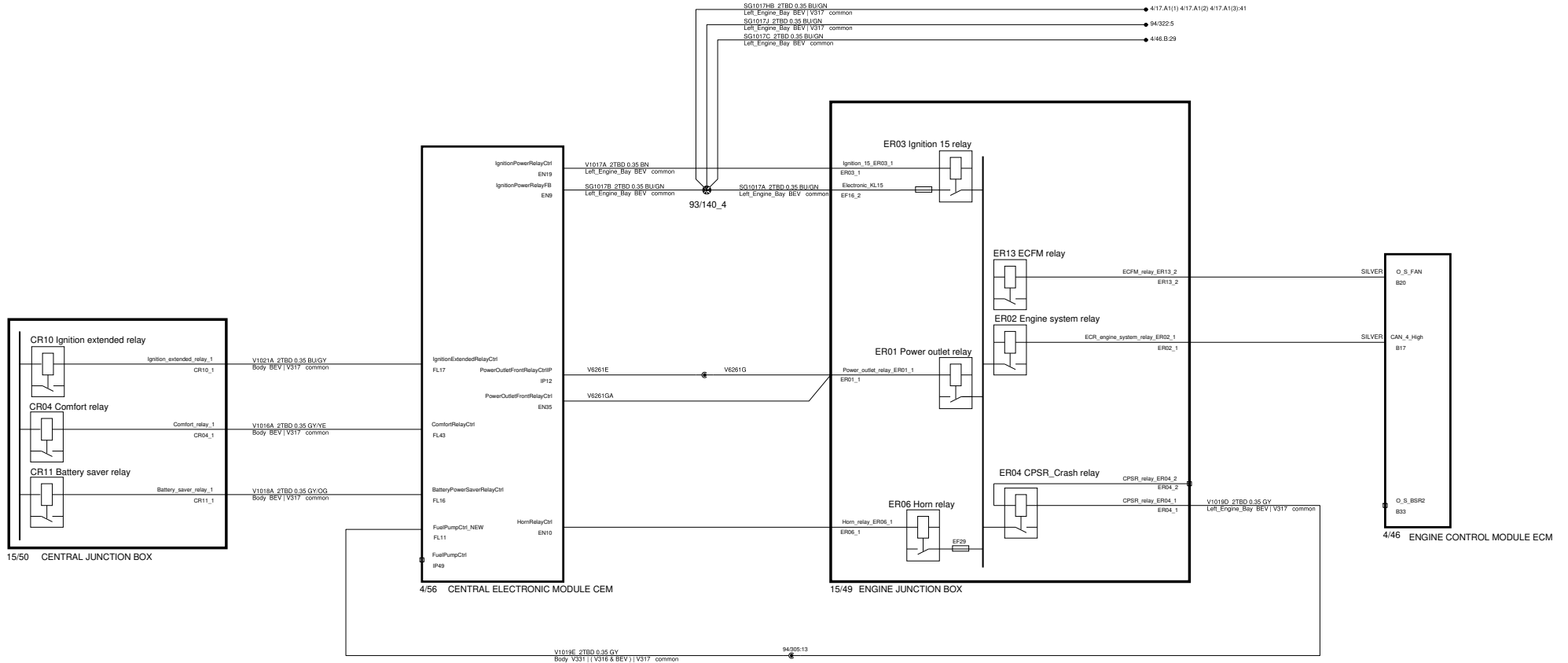

<p>The copying, distribution and utilization of this document as well as the communication of its contents to others without expressed authorization is prohibited. Offenders will be held liable for payment of damages. All rights reserved in the event of the grant of a patent, utility model or ornamental design registration.</p> <p><b>VOLVO</b> VOLVO CAR CORPORATION</p>	<p><b>Document title</b> 623A_PP_CC_04_06_2023 1A3_System_relays_control_BEV</p>	
	<p><b>Document Type</b> DRAW/ELSY</p>	<p><b>Release Status</b> RELEASED</p>
	<p>Volvo Document No 33445458</p>	<p><b>Edited</b> April/12/2023</p>
	<p><b>Issue</b> 035</p>	<p><b>Page No</b> 8/146</p>





# 1B Grounding IP, Tunnel & Roof

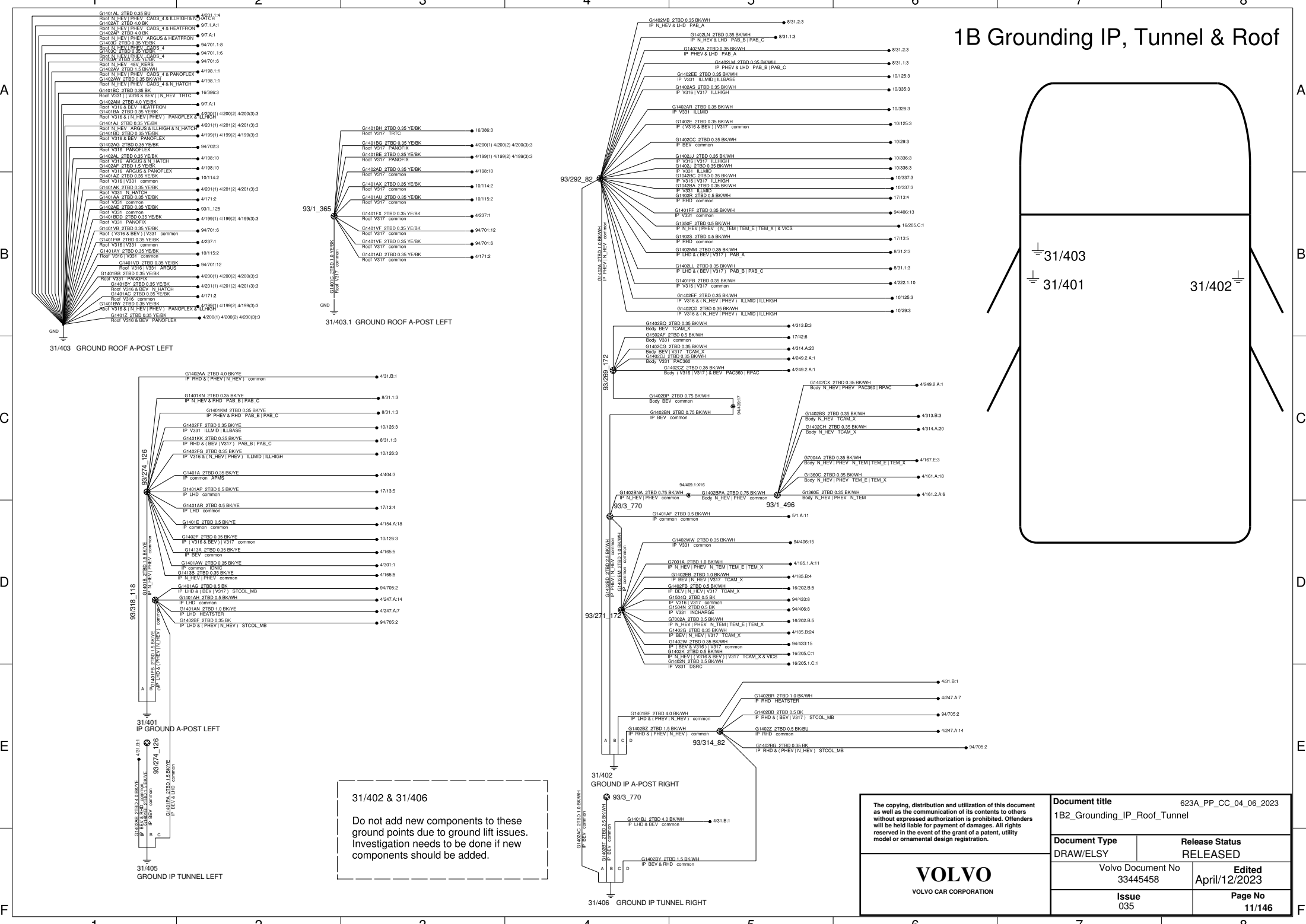

31/402 & 31/406

Do not add new components to these ground points due to ground lift issues. Investigation needs to be done if new components should be added.

The copying, distribution and utilization of this document as well as the communication of its contents to others without expressed authorization is prohibited. Offenders will be held liable for payment of damages. All rights reserved in the event of the grant of a patent, utility model or ornamental design registration.

**VOLVO**  
VOLVO CAR CORPORATION

Document title		623A_PP_CC_04_06_2023	
1B2_Grounding_IP_Roof_Tunnel			
Document Type	Release Status		
DRAW/ELSY	RELEASED		
Volvo Document No 33445458		Edited April/12/2023	
Issue 035	Page No 11/146		



# 1B Grounding Body Rear, Tailgate

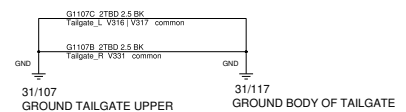
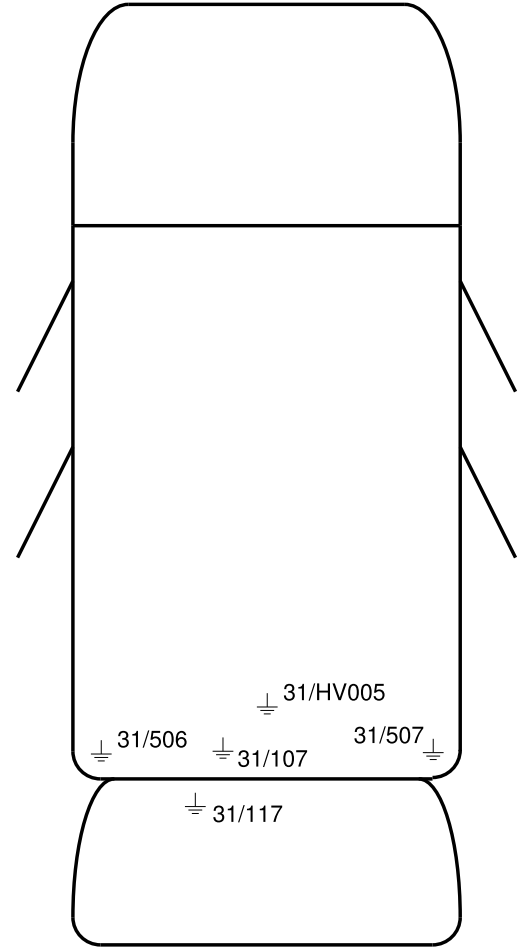
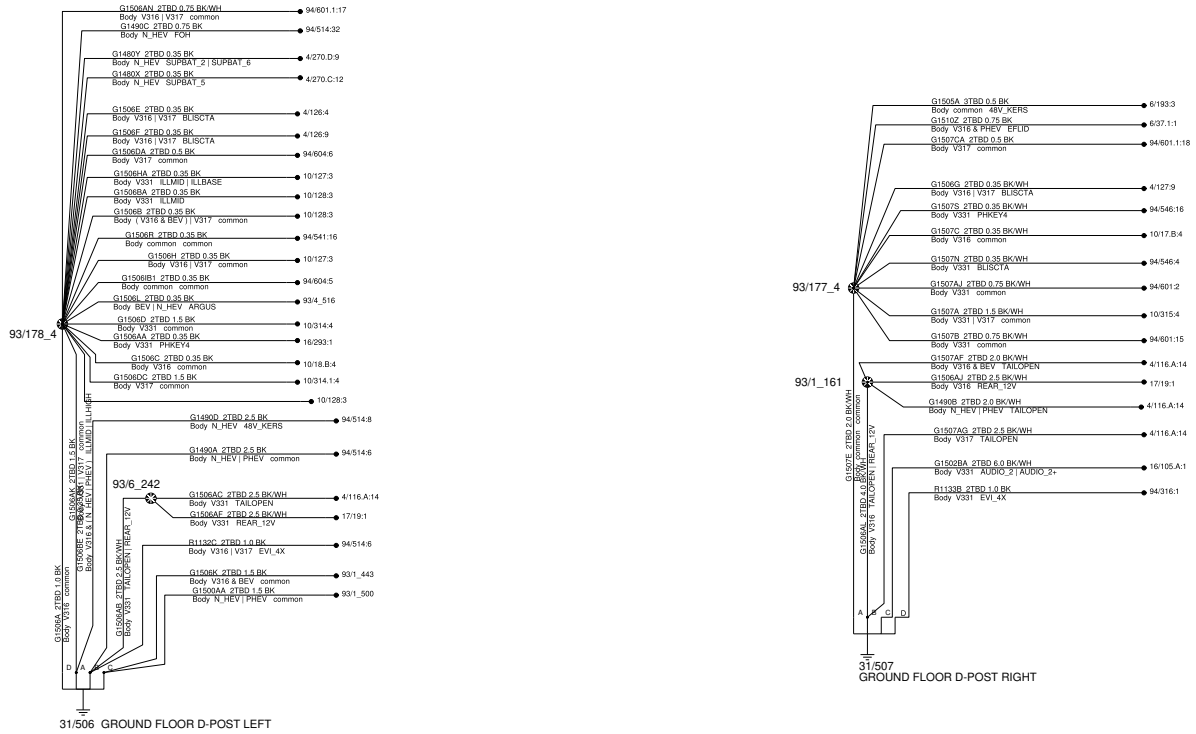

<p>The copying, distribution and utilization of this document as well as the communication of its contents to others without expressed authorization is prohibited. Offenders will be held liable for payment of damages. All rights reserved in the event of the grant of a patent, utility model or ornamental design registration.</p> <p><b>VOLVO</b> VOLVO CAR CORPORATION</p>	<p>Document title 623A_PP_CC_04_06_2023 1B4_Grounding_Body_Rear_Tailgate</p>	
	<p>Document Type DRAW/ELSY</p>	<p>Release Status RELEASED</p>
	<p>Volvo Document No 33445458</p>	<p>Edited April/12/2023</p>
	<p>Issue 035</p>	<p>Page No 13/146</p>

# 1C1 EI. Power generating

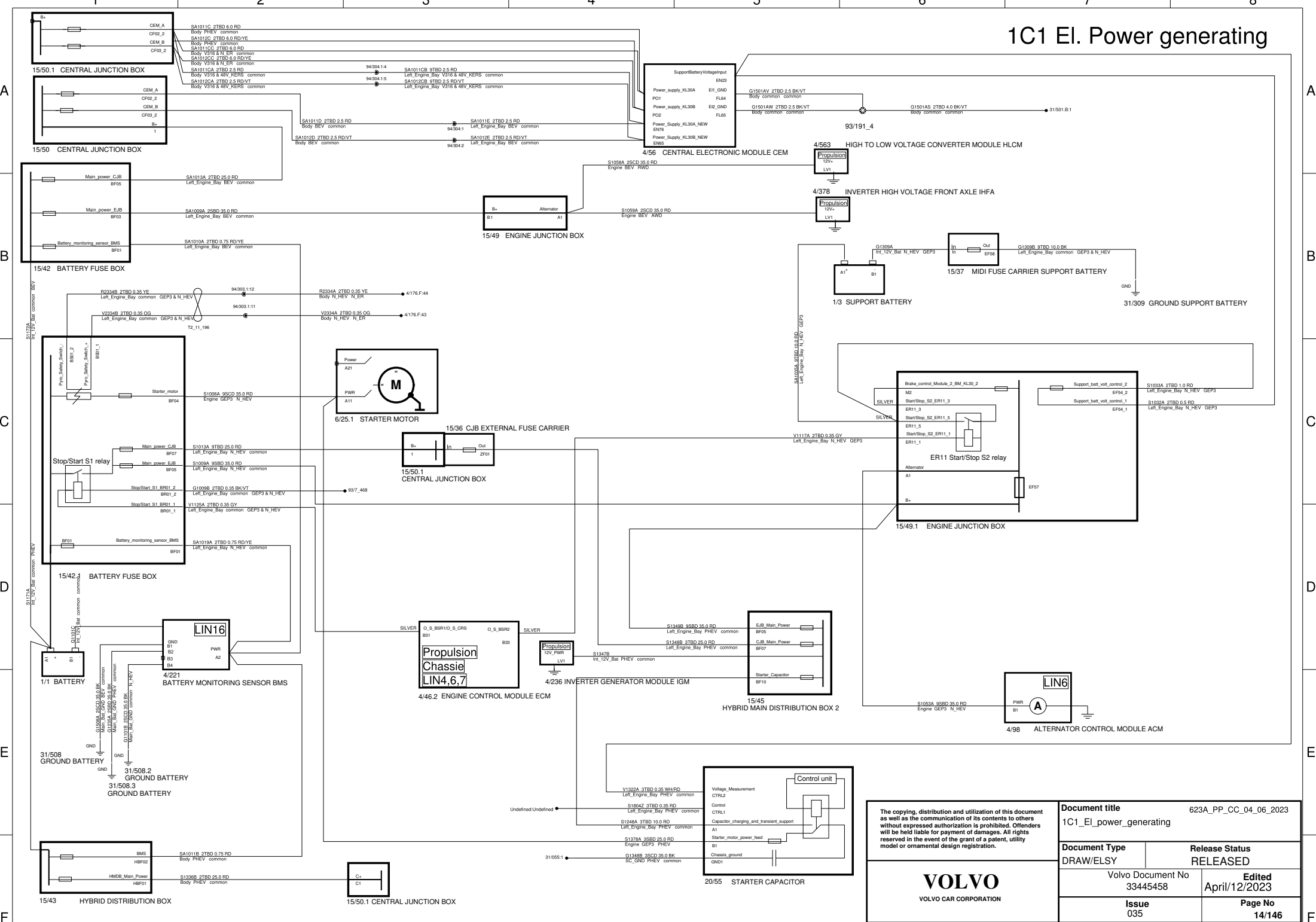

<p>The copying, distribution and utilization of this document as well as the communication of its contents to others without expressed authorization is prohibited. Offenders will be held liable for payment of damages. All rights reserved in the event of the grant of a patent, utility model or ornamental design registration.</p> <p><b>VOLVO</b> VOLVO CAR CORPORATION</p>		<p>Document title 623A_PP_CC_04_06_2023</p>	
		<p>1C1_EI_power_generating</p>	
<p>Document Type DRAW/ELSY</p>		<p>Release Status RELEASED</p>	
<p>Volvo Document No 33445458</p>		<p>Edited April/12/2023</p>	
<p>Issue 035</p>		<p>Page No 14/146</p>	

# 1D Diagnostics

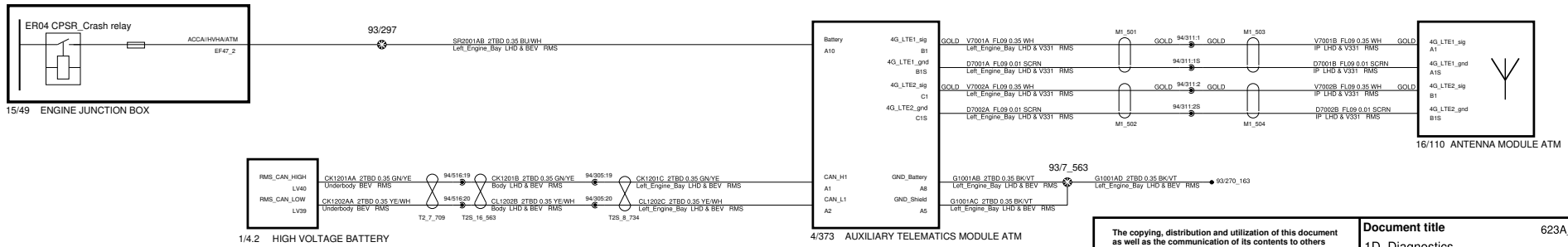
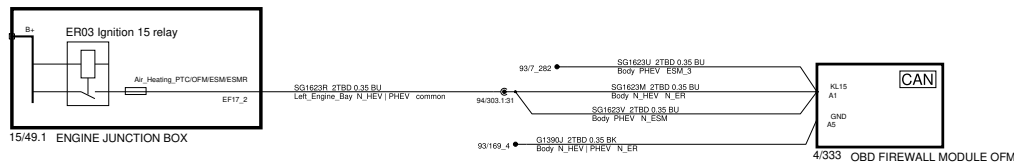
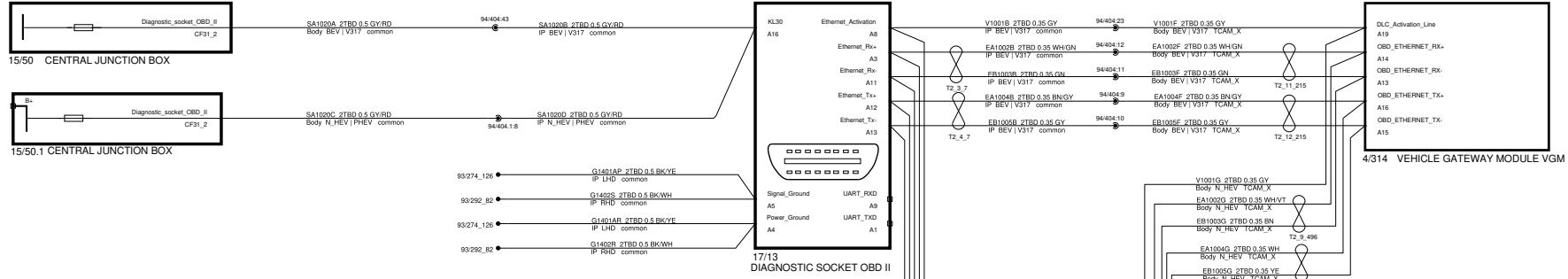

<p>The copying, distribution and utilization of this document as well as the communication of its contents to others without expressed authorization is prohibited. Offenders will be held liable for payment of damages. All rights reserved in the event of the grant of a patent, utility model or ornamental design registration.</p>		<p>Document title 1D_Diagnostics</p>		<p>623A_PP_CC_04_06_2023</p>	
		<p>Document Type DRAW/ELSY</p>		<p>Release Status RELEASED</p>	
<p><b>VOLVO</b> VOLVO CAR CORPORATION</p>		<p>Volvo Document No 33445458</p>		<p>Edited April/12/2023</p>	
		<p>Issue 035</p>		<p>Page No 15/146</p>	



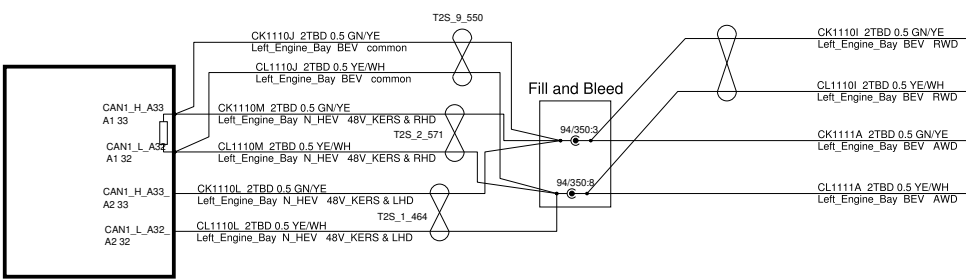
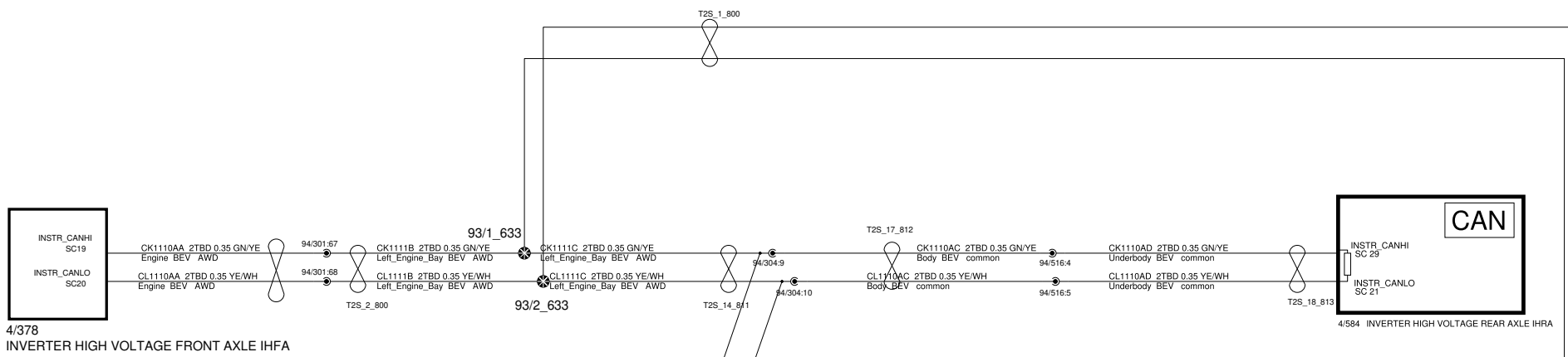

4/17  
BRAKE CONTROL MODULE 2 BCM2

<p>The copying, distribution and utilization of this document as well as the communication of its contents to others without expressed authorization is prohibited. Offenders will be held liable for payment of damages. All rights reserved in the event of the grant of a patent, utility model or ornamental design registration.</p> <p><b>VOLVO</b> VOLVO CAR CORPORATION</p>	<p><b>Document title</b> 623A_PP_CC_04_06_2023 1E_CAN_ABS_Braking</p>	
	<p><b>Document Type</b> DRAW/ELSY</p>	<p><b>Release Status</b> RELEASED</p>
	<p>CEVT Document No 8888522365</p>	<p><b>Edited</b> April/12/2023</p>
	<p><b>Issue</b> 035</p>	<p><b>Page No</b> 16/146</p>

# 1E Body CAN Exp

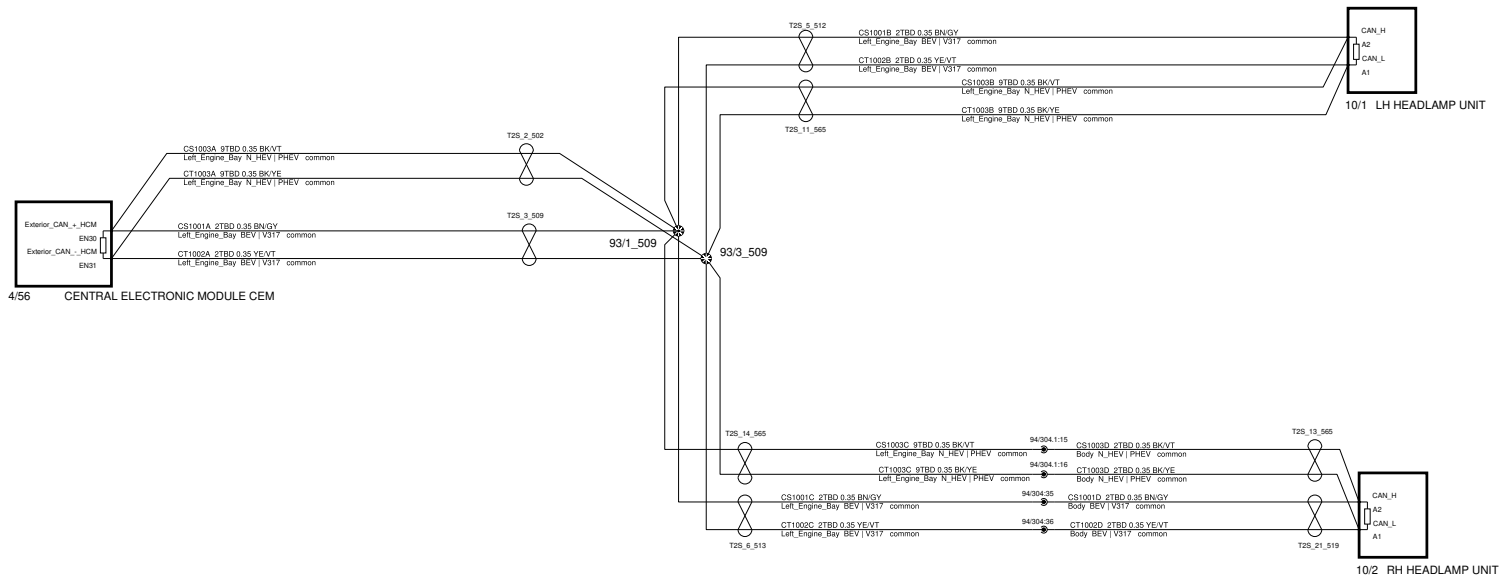

<p>The copying, distribution and utilization of this document as well as the communication of its contents to others without expressed authorization is prohibited. Offenders will be held liable for payment of damages. All rights reserved in the event of the grant of a patent, utility model or ornamental design registration.</p> <p><b>VOLVO</b> VOLVO CAR CORPORATION</p>	<b>Document title</b> 623A_PP_CC_04_06_2023 1E_CAN_Body_Exp	
	<b>Document Type</b> DRAW/ELSY	<b>Release Status</b> RELEASED
	Volvo Document No 33445458	<b>Edited</b> February/19/2021
	<b>Issue</b> 035	<b>Page No</b> 18/146

# 1E Body-CAN

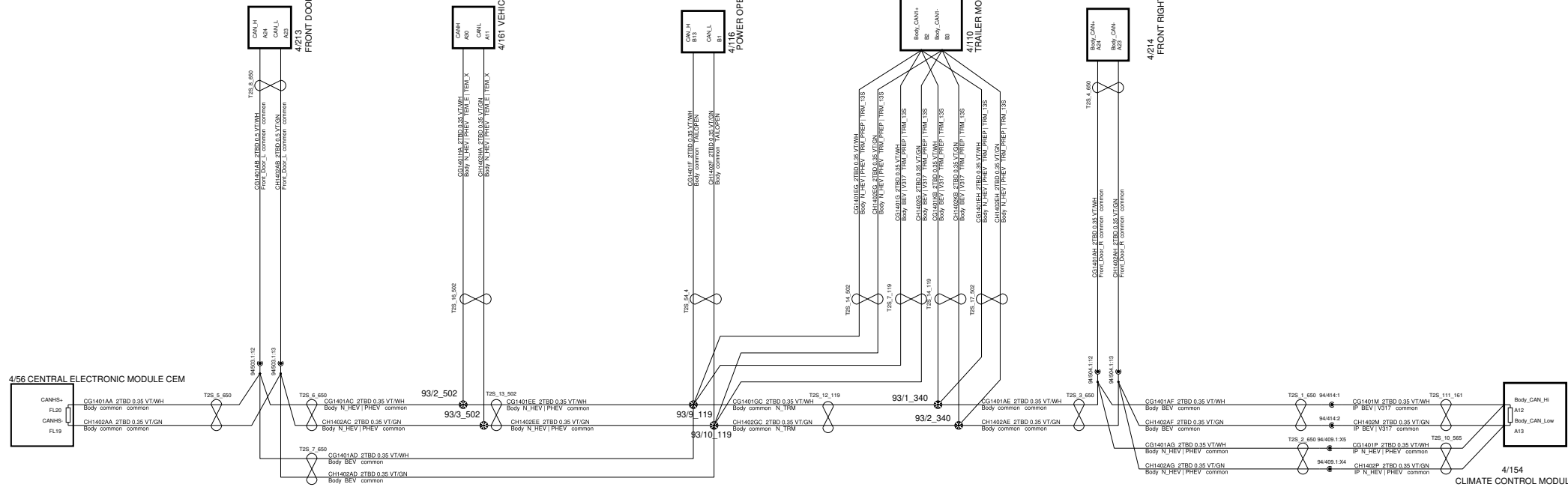

<p>The copying, distribution and utilization of this document as well as the communication of its contents to others without expressed authorization is prohibited. Offenders will be held liable for payment of damages. All rights reserved in the event of the grant of a patent, utility model or ornamental design registration.</p> <p><b>VOLVO</b> VOLVO CAR CORPORATION</p>	<b>Document title</b>		623A_PP_CC_04_06_2023
	1E_CAN_Body		
	<b>Document Type</b>	<b>Release Status</b>	
	DRAW/ELSY	RELEASED	
	Volvo Document No 33445458	<b>Edited</b> April/12/2023	
	<b>Issue</b> 035	<b>Page No</b> 17/146	

# 1E Chassie CAN

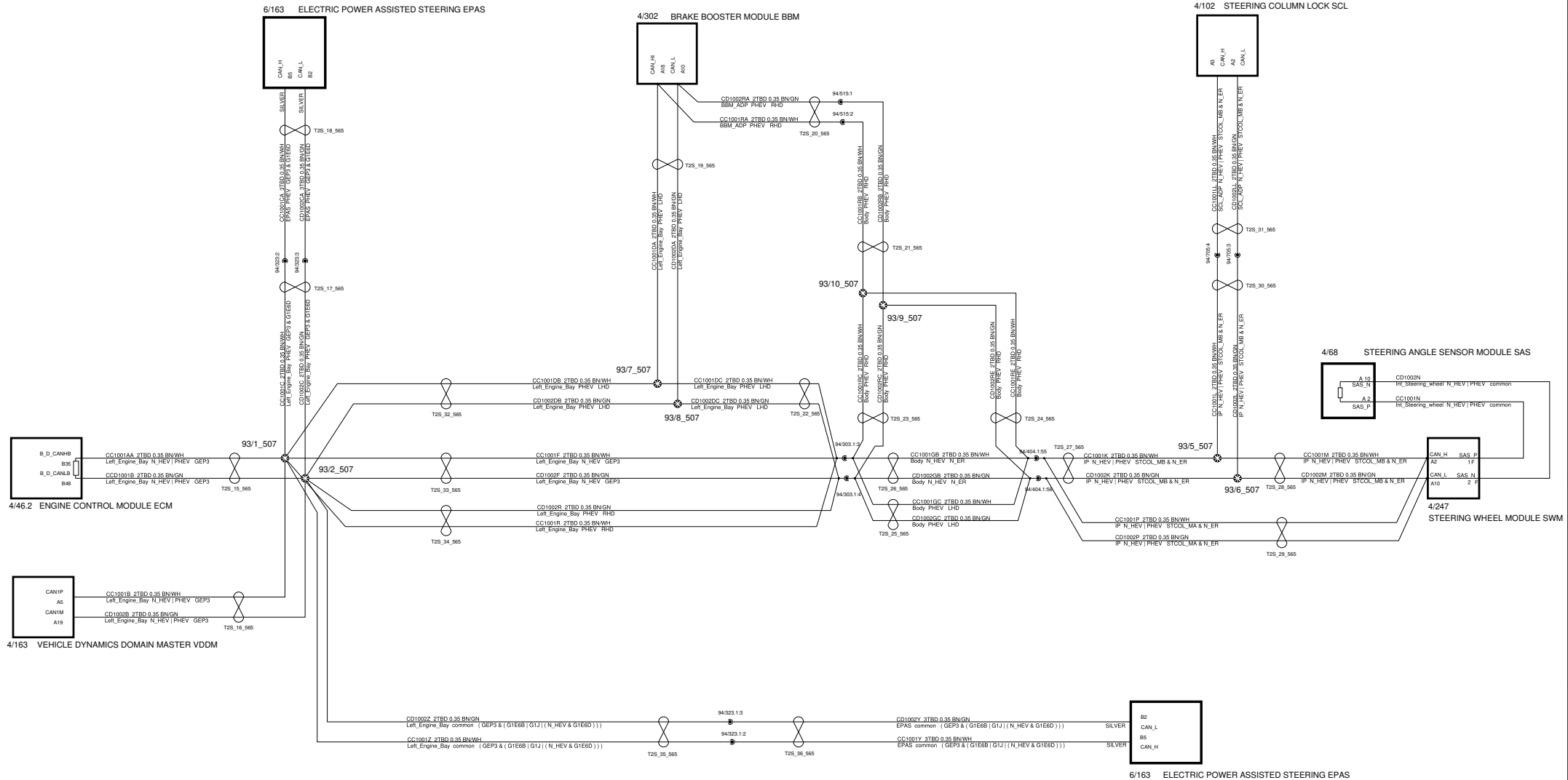

<p>The copying, distribution and utilization of this document as well as the communication of its contents to others without expressed authorization is prohibited. Offenders will be held liable for payment of damages. All rights reserved in the event of the grant of a patent, utility model or ornamental design registration.</p> <p><b>VOLVO</b> VOLVO CAR CORPORATION</p>	<b>Document title</b> 623A_PP_CC_04_06_2023	
	1E_CAN_Chassie	
	<b>Document Type</b> DRAW/ELSY	<b>Release Status</b> RELEASED
	CEVT Document No 8888522365	<b>Edited</b> April/04/2023
<b>Issue</b> 035	<b>Page No</b> 19/146	

# 1E Diagnostics and Connectivity CAN

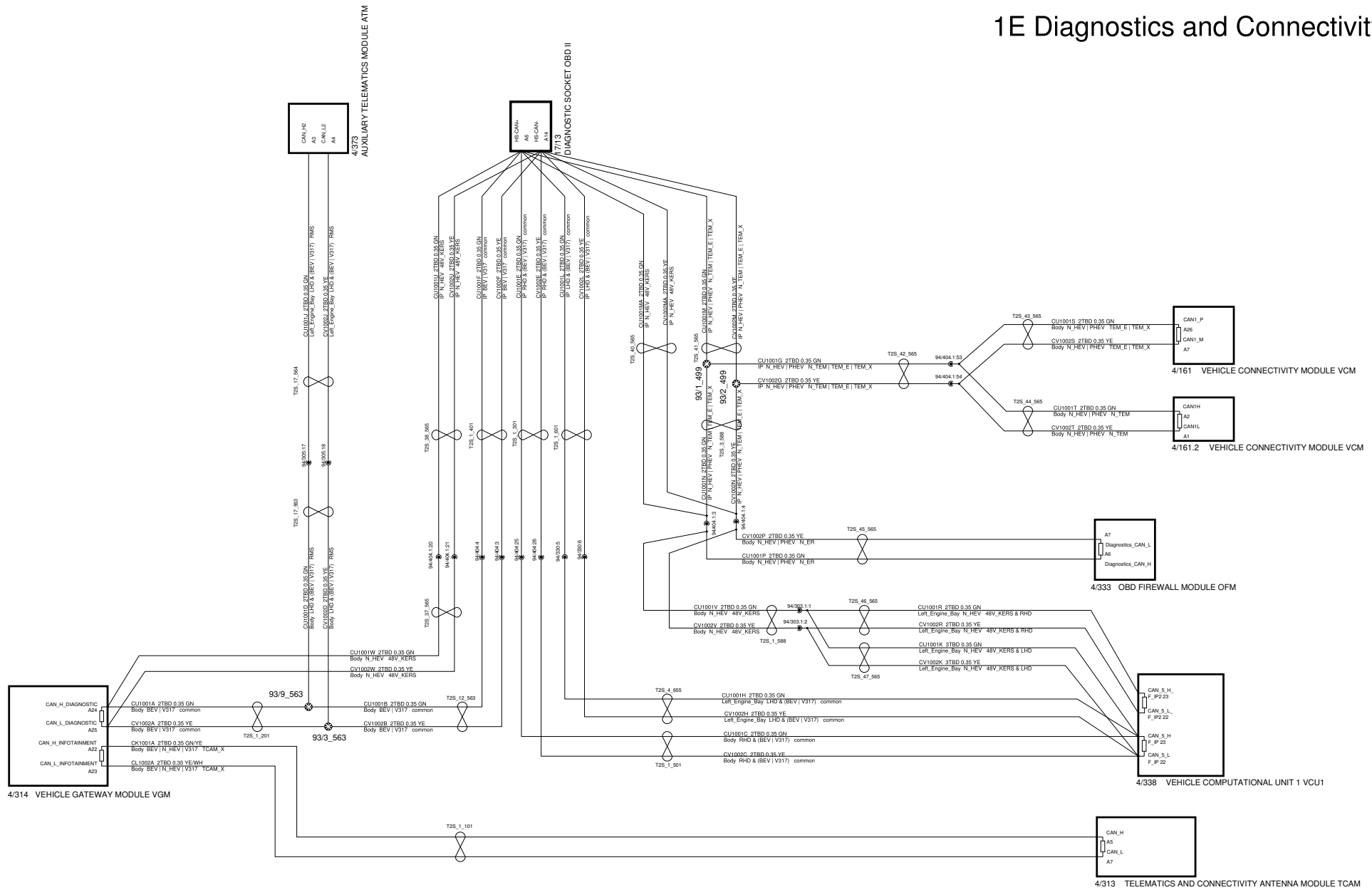

<p>The copying, distribution and utilization of this document as well as the communication of its contents to others without expressed authorization is prohibited. Offenders will be held liable for payment of damages. All rights reserved in the event of the grant of a patent, utility model or ornamental design registration.</p> <p><b>VOLVO</b> VOLVO CAR CORPORATION</p>		<p><b>Document title</b> 623A_PP_CC_04_06_2023 1E_CAN_Connectivity_Diagnostics</p>	
		<p><b>Document Type</b> DRAW/ELSY</p>	<p><b>Release Status</b> RELEASED</p>
		<p>Volvo Document No 33445458</p>	<p><b>Edited</b> April/12/2023</p>
		<p><b>Issue</b> 035</p>	<p><b>Page No</b> 20/146</p>

# 1E Engine CAN

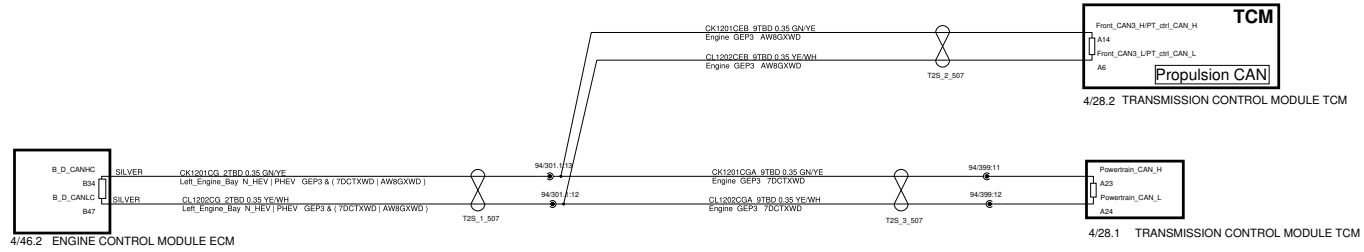

<p>The copying, distribution and utilization of this document as well as the communication of its contents to others without expressed authorization is prohibited. Offenders will be held liable for payment of damages. All rights reserved in the event of the grant of a patent, utility model or ornamental design registration.</p> <p><b>VOLVO</b> VOLVO CAR CORPORATION</p>	<b>Document title</b> 623A_PP_CC_04_06_2023 1E_CAN_Engine	
	<b>Document Type</b> DRAW/ELSY	<b>Release Status</b> RELEASED
	CEVT Document No 8888522365	<b>Edited</b> February/01/2021
	<b>Issue</b> 035	<b>Page No</b> 21/146

# 1E Front 1 CAN

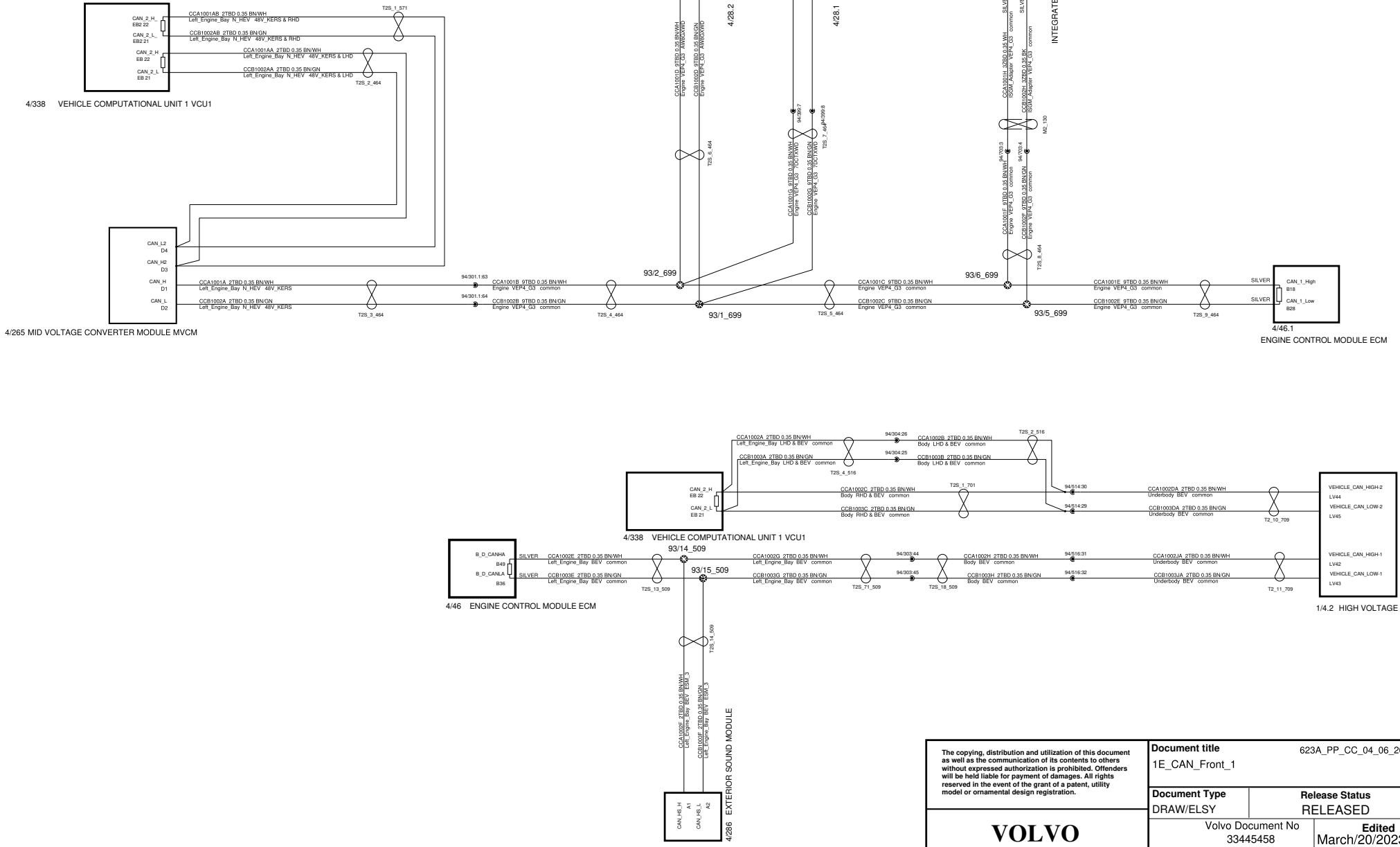

<p>The copying, distribution and utilization of this document as well as the communication of its contents to others without expressed authorization is prohibited. Offenders will be held liable for payment of damages. All rights reserved in the event of the grant of a patent, utility model or ornamental design registration.</p> <p><b>VOLVO</b> VOLVO CAR CORPORATION</p>		<p>Document title: 623A_PP_CC_04_06_2023 1E_CAN_Front_1</p>	
		<p>Document Type: DRAW/ELSY</p>	<p>Release Status: RELEASED</p>
<p>Volvo Document No: 33445458</p>		<p>Edited: March/20/2023</p>	
<p>Issue: 035</p>		<p>Page No: 22/146</p>	

# 1E Front 3 CAN

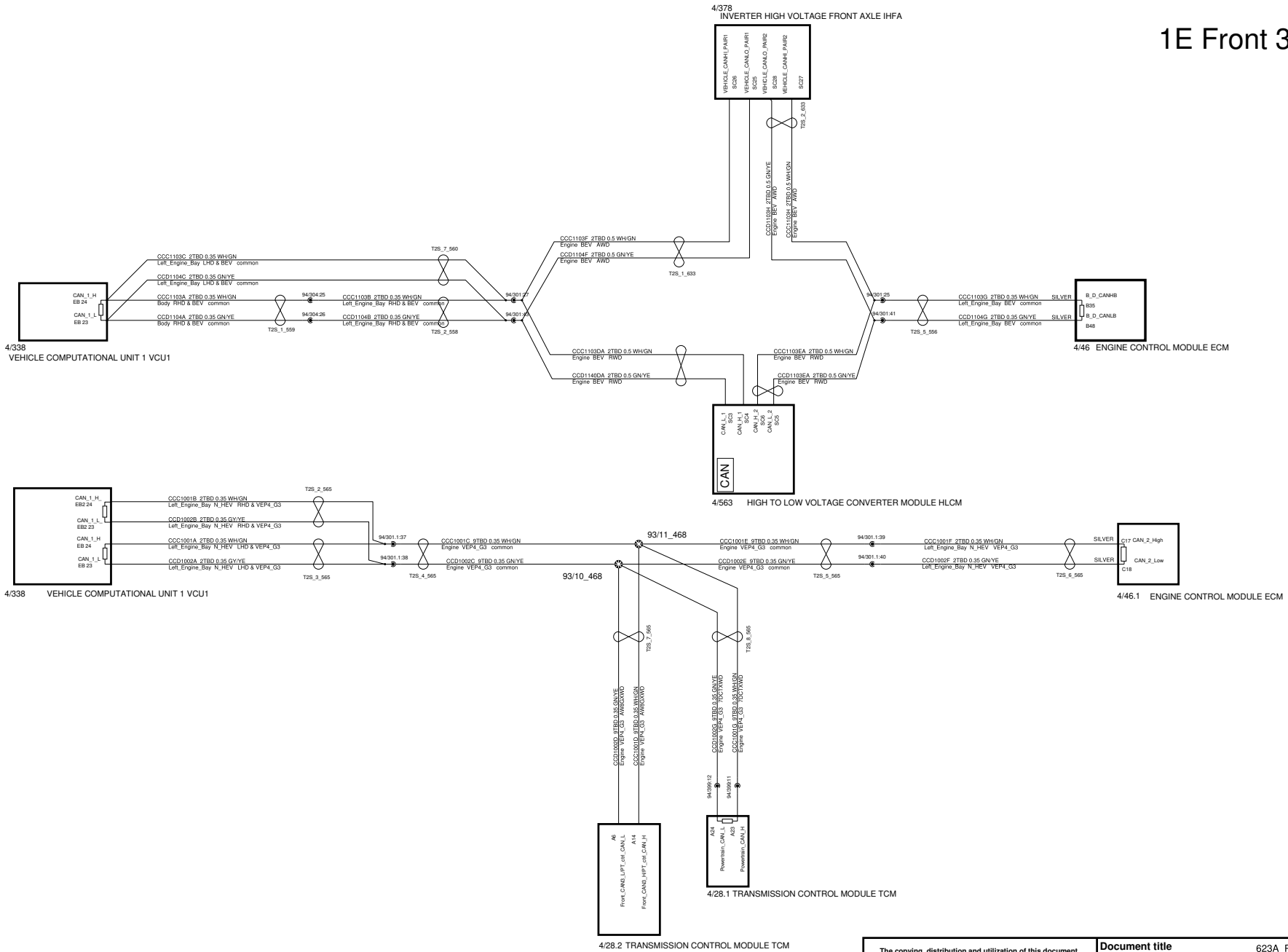

<p>The copying, distribution and utilization of this document as well as the communication of its contents to others without expressed authorization is prohibited. Offenders will be held liable for payment of damages. All rights reserved in the event of the grant of a patent, utility model or ornamental design registration.</p>		<p>Document title 623A_PP_CC_04_06_2023</p>	
		<p>1E_CAN_Front_3</p>	
<p>Document Type</p>		<p>Release Status</p>	
<p>DRAW/ELSY</p>		<p>RELEASED</p>	
<p>Volvo Document No 33445458</p>		<p>Edited March/21/2023</p>	
<p>Issue 035</p>		<p>Page No 23/146</p>	

**VOLVO**  
VOLVO CAR CORPORATION



# 1E Front CAN Exposed

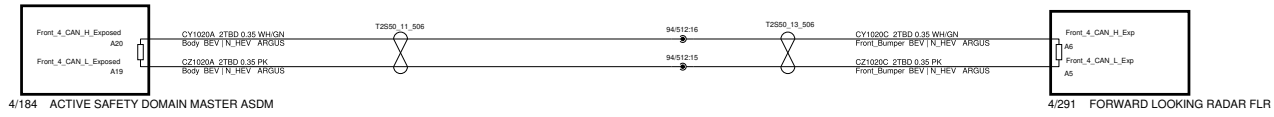

<p>The copying, distribution and utilization of this document as well as the communication of its contents to others without expressed authorization is prohibited. Offenders will be held liable for payment of damages. All rights reserved in the event of the grant of a patent, utility model or ornamental design registration.</p> <p><b>VOLVO</b> VOLVO CAR CORPORATION</p>	<b>Document title</b> 623A_PP_CC_04_06_2023 1E_CAN_Front_Exposed	
	<b>Document Type</b> DRAW/ELSY	<b>Release Status</b> RELEASED
	Volvo Document No 33445458	<b>Edited</b> September/30/2020
	<b>Issue</b> 035	<b>Page No</b> 24/146

# 1E Mid 1 CAN

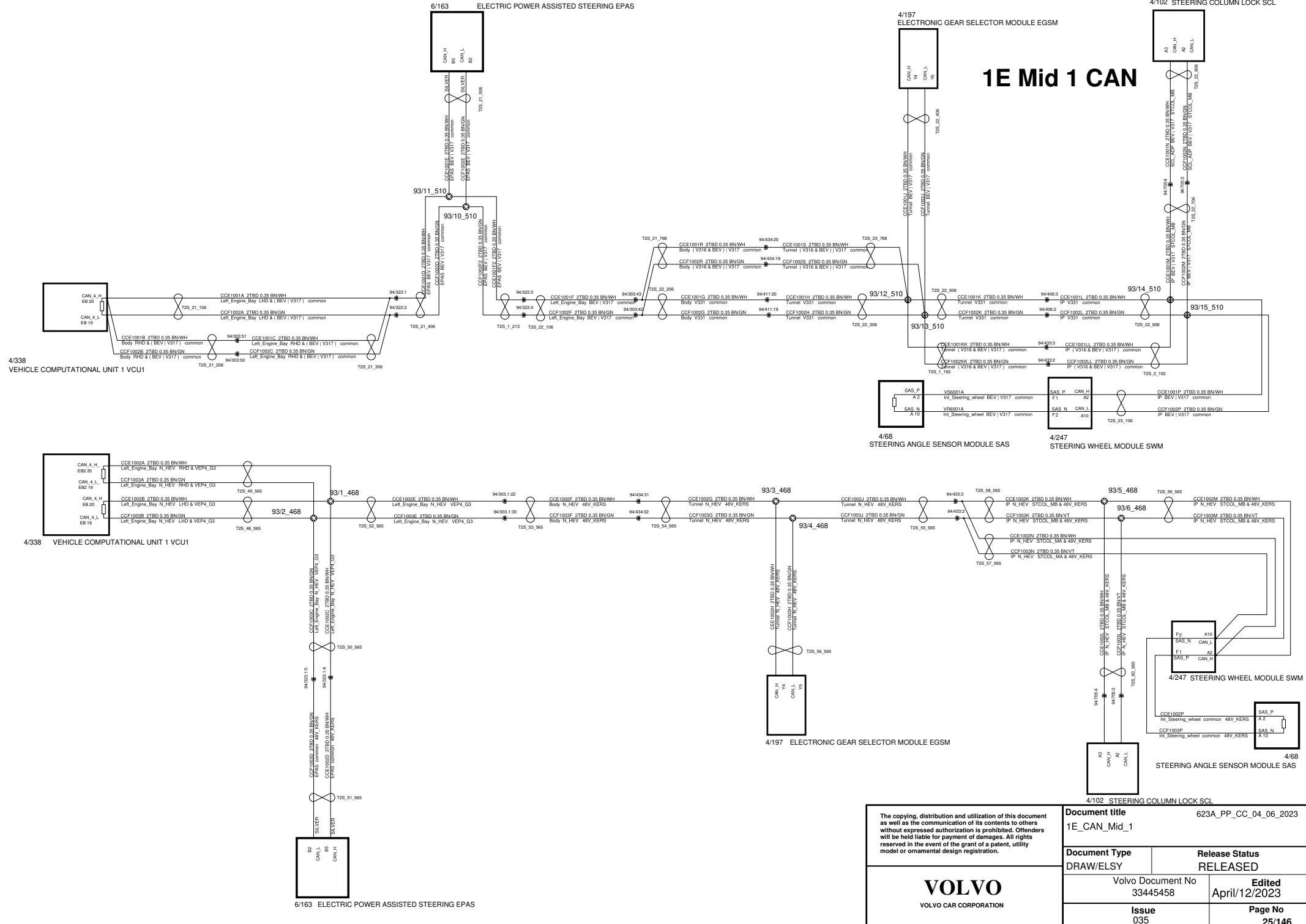

<p>The copying, distribution and utilization of this document as well as the communication of its contents to others without expressed authorization is prohibited. Offenders will be held liable for payment of damages. All rights reserved in the event of the grant of a patent, utility model or ornamental design registration.</p> <p><b>VOLVO</b> VOLVO CAR CORPORATION</p>		<p>Document title</p> <p>1E_CAN_Mid_1</p>	<p>623A_PP_CC_04_06_2023</p>
		<p>Document Type</p> <p>DRAW/ELSY</p>	<p>Release Status</p> <p>RELEASED</p>
		<p>Volvo Document No</p> <p>33445458</p>	<p>Edited</p> <p>April/12/2023</p>
		<p>Issue</p> <p>035</p>	<p>Page No</p> <p>25/146</p>

6/163 ELECTRIC POWER ASSISTED STEERING EPAS

4/197 ELECTRONIC GEAR SELECTOR MODULE EGSM

4/102 STEERING COLUMN LOCK SCL

4/68 STEERING ANGLE SENSOR MODULE SAS

4/247 STEERING WHEEL MODULE SWM

4/68 STEERING ANGLE SENSOR MODULE SAS

4/338 VEHICLE COMPUTATIONAL UNIT 1 VCU1

4/338 VEHICLE COMPUTATIONAL UNIT 1 VCU1

# 1E Propulsion CAN Front

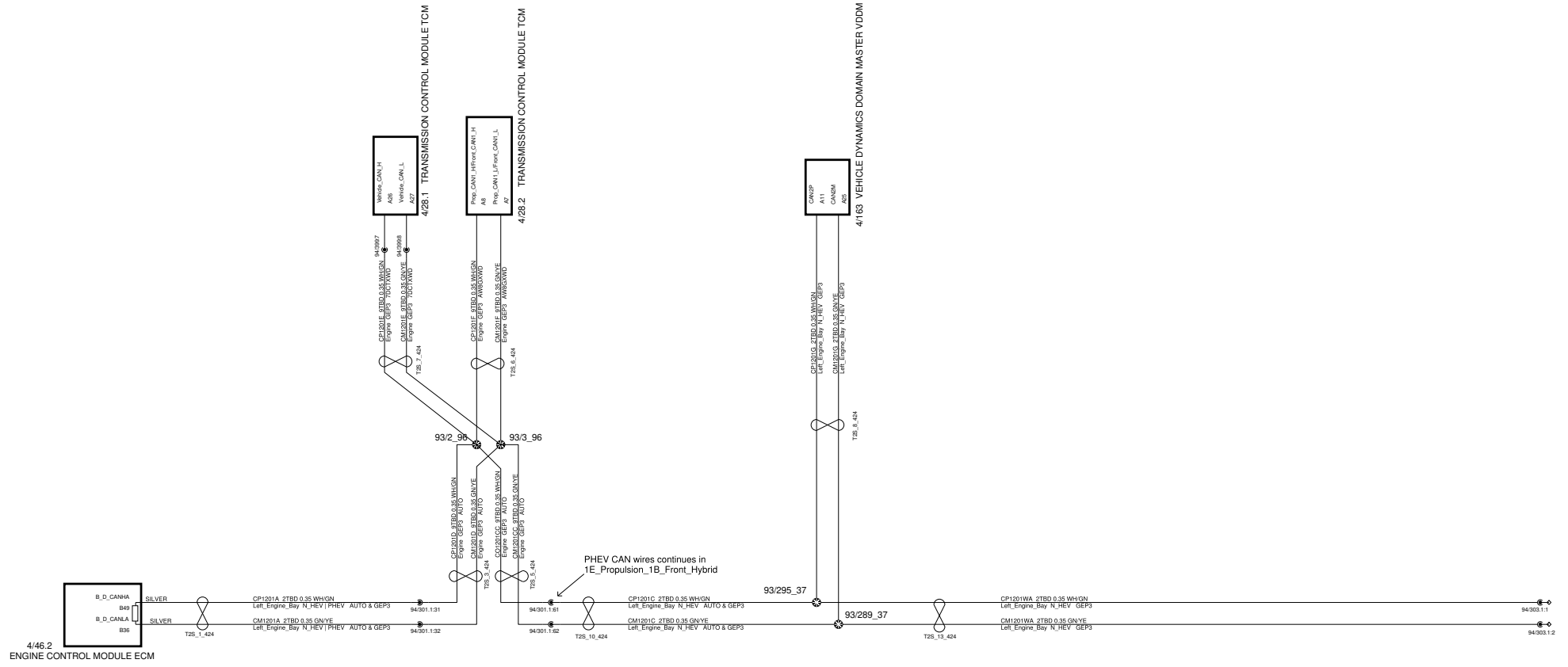

<p>The copying, distribution and utilization of this document as well as the communication of its contents to others without expressed authorization is prohibited. Offenders will be held liable for payment of damages. All rights reserved in the event of the grant of a patent, utility model or ornamental design registration.</p> <p><b>VOLVO</b> VOLVO CAR CORPORATION</p>	<p><b>Document title</b> 623A_PP_CC_04_06_2023 1E_CAN_Propulsion_1A_Front</p>	
	<p><b>Document Type</b> DRAW/ELSY</p>	<p><b>Release Status</b> RELEASED</p>
	<p>CEVT Document No 8888522365</p>	<p><b>Edited</b> April/12/2023</p>
	<p><b>Issue</b> 035</p>	<p><b>Page No</b> 26/146</p>

# 1E Propulsion CAN Front Hybrid

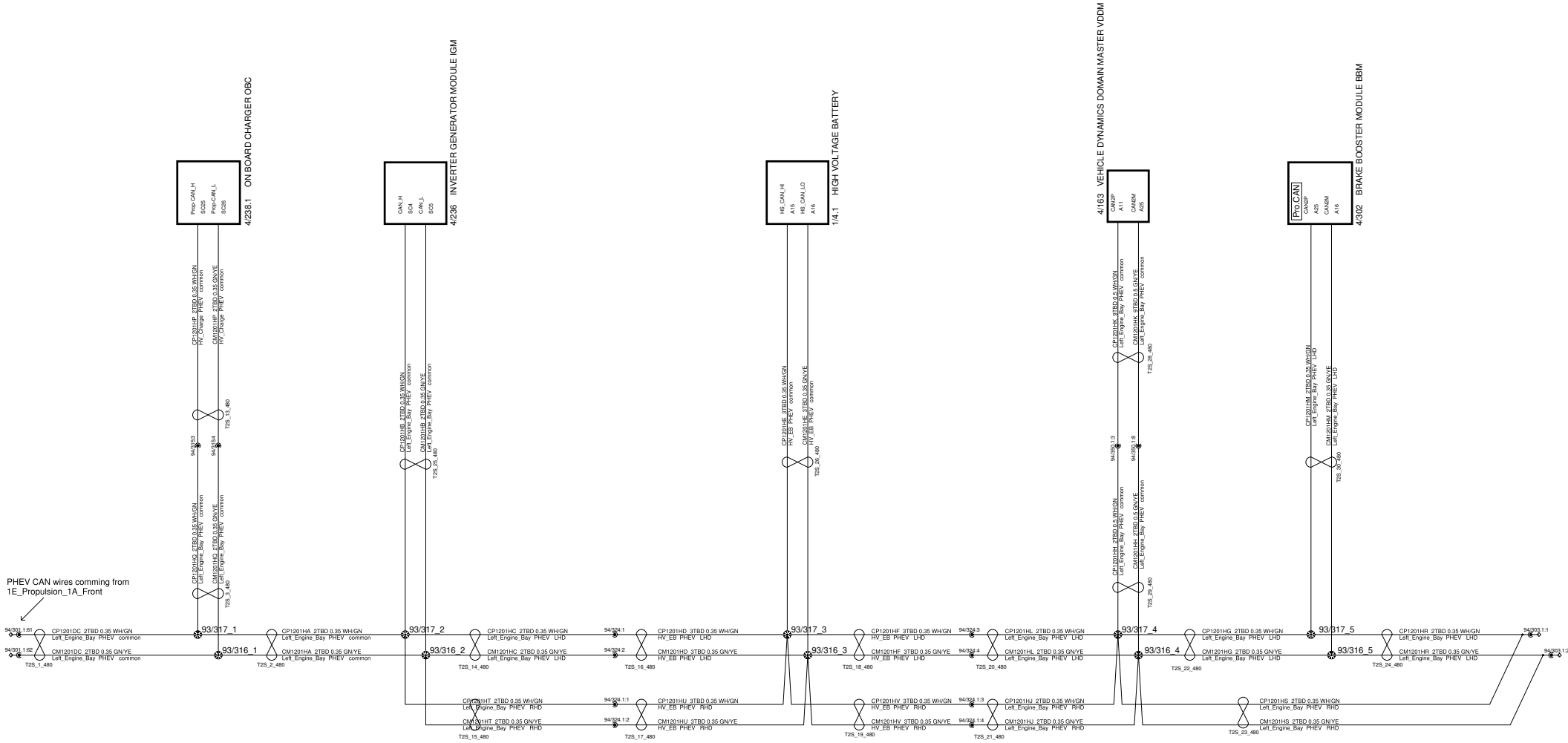

<p>The copying, distribution and utilization of this document as well as the communication of its contents to others without expressed authorization is prohibited. Offenders will be held liable for payment of damages. All rights reserved in the event of the grant of a patent, utility model or ornamental design registration.</p> <p><b>VOLVO</b> VOLVO CAR CORPORATION</p>	<p><b>Document title</b> 623A_PP_CC_04_06_2023 1E_CAN_Propulsion_1B_Front_Hybrid</p>	
	<p><b>Document Type</b> DRAW/ELSY</p>	<p><b>Release Status</b> RELEASED</p>
	<p>CEVT Document No 8888522365</p>	<p><b>Edited</b> March/29/2023</p>
	<p><b>Issue</b> 035</p>	<p><b>Page No</b> 27/146</p>



# 1E Rear 1 CAN

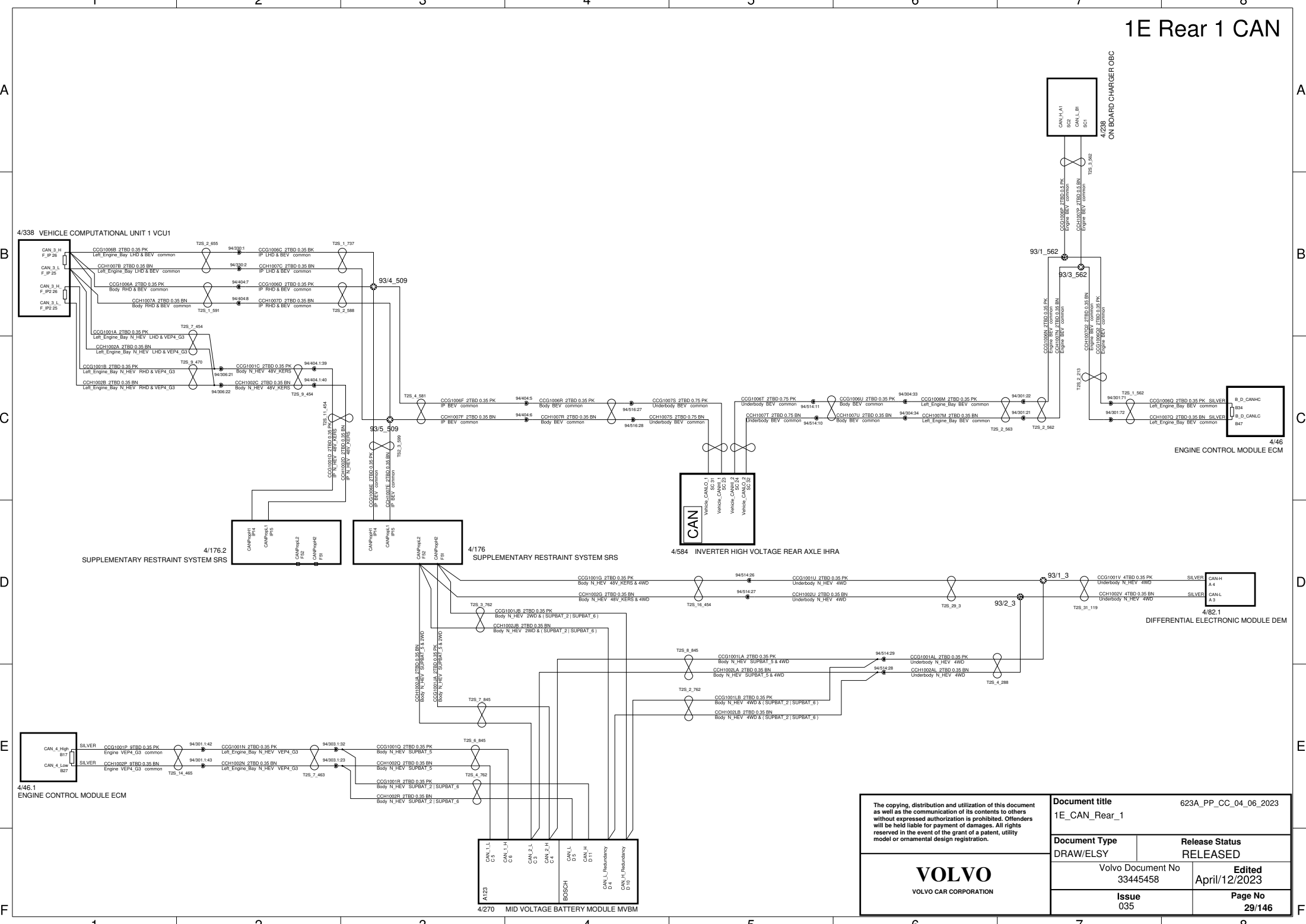

<p>The copying, distribution and utilization of this document as well as the communication of its contents to others without expressed authorization is prohibited. Offenders will be held liable for payment of damages. All rights reserved in the event of the grant of a patent, utility model or ornamental design registration.</p>		<p>Document title 623A_PP_CC_04_06_2023</p>	
		<p>1E_CAN_Rear_1</p>	
<p>Document Type DRAW/ELSY</p>		<p>Release Status RELEASED</p>	
<p>Volvo Document No 33445458</p>		<p>Edited April/12/2023</p>	
<p>Issue 035</p>		<p>Page No 29/146</p>	

**VOLVO**  
VOLVO CAR CORPORATION



# 1E Safety CAN Exposed ICE PHEV

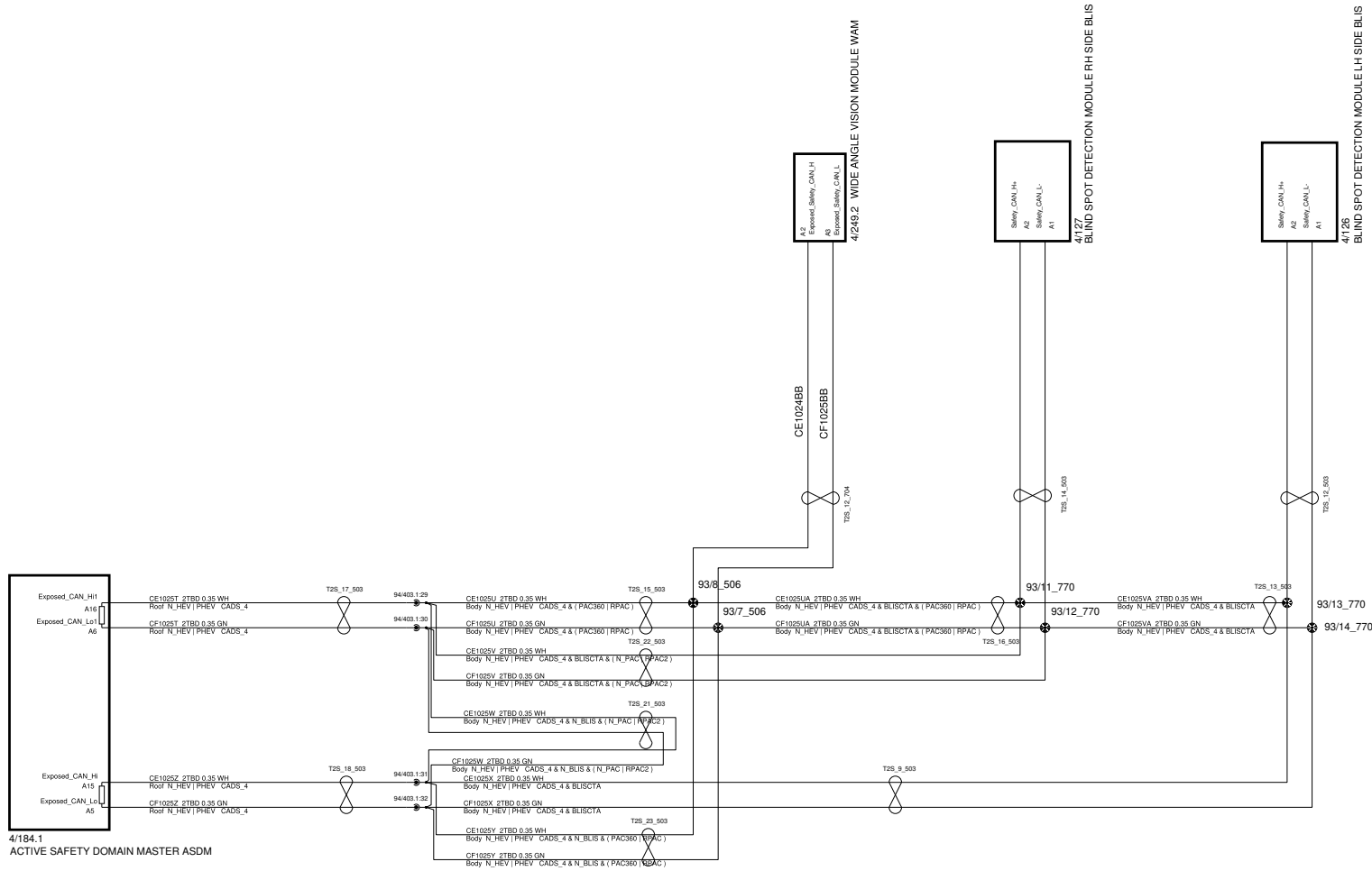

<b>VOLVO</b> VOLVO CAR CORPORATION	<b>Document title</b> 623A_PP_CC_04_06_2023 1E_CAN_Safety_Exposed_ICE_PHEV	
	<b>Document Type</b> DRAW/ELSY	<b>Release Status</b> RELEASED
	CEVT Document No 8888522365	Edited April/12/2023
	Issue 035	Page No 31/146





# 1E\_Backbone\_FlexRay BEV|48V KERS

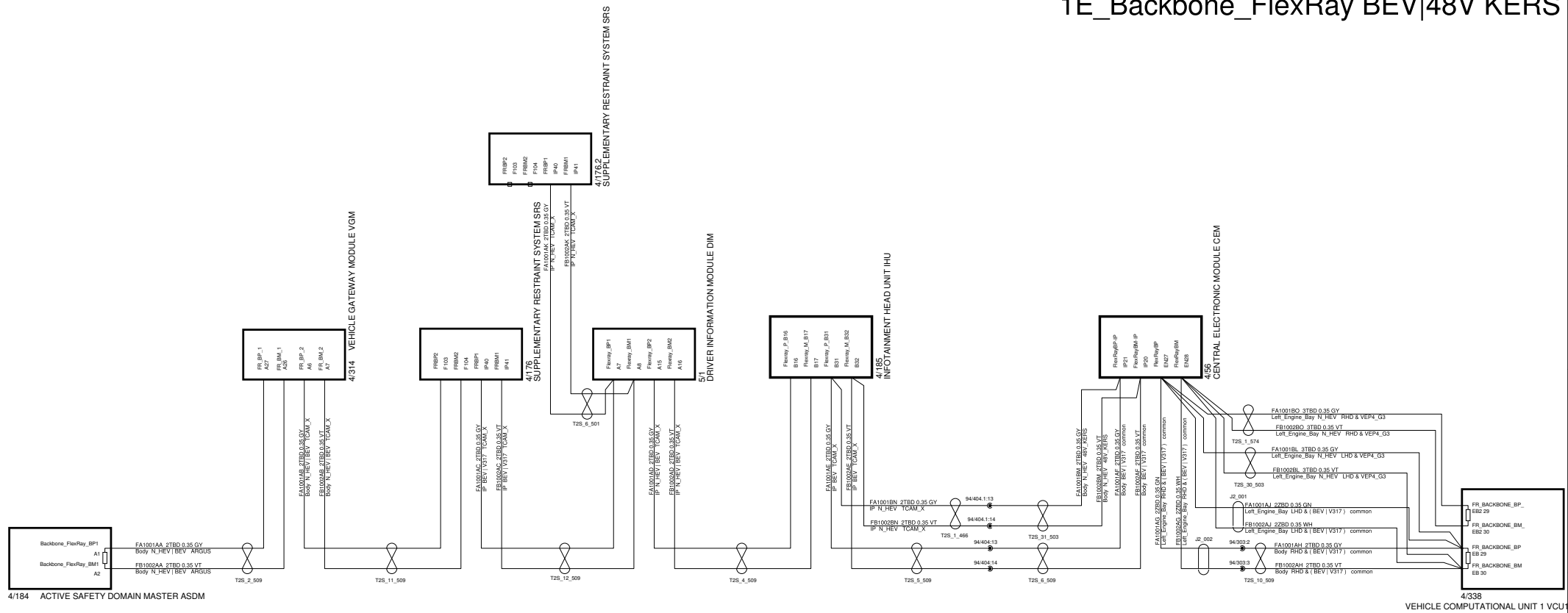

<p>The copying, distribution and utilization of this document as well as the communication of its contents to others without expressed authorization is prohibited. Offenders will be held liable for payment of damages. All rights reserved in the event of the grant of a patent, utility model or ornamental design registration.</p> <p><b>VOLVO</b> VOLVO CAR CORPORATION</p>	<b>Document title</b> 623A_PP_CC_04_06_2023	
	1E_FlexRay_Backbone_BEV_48V_KERS	
	<b>Document Type</b>	<b>Release Status</b>
	Volvo Document No 33445458	RELEASED
<b>Issue</b> 035	<b>Edited</b> April/12/2023	<b>Page No</b> 33/146

# 1E\_Backbone\_FlexRay\_ICE|PHEV

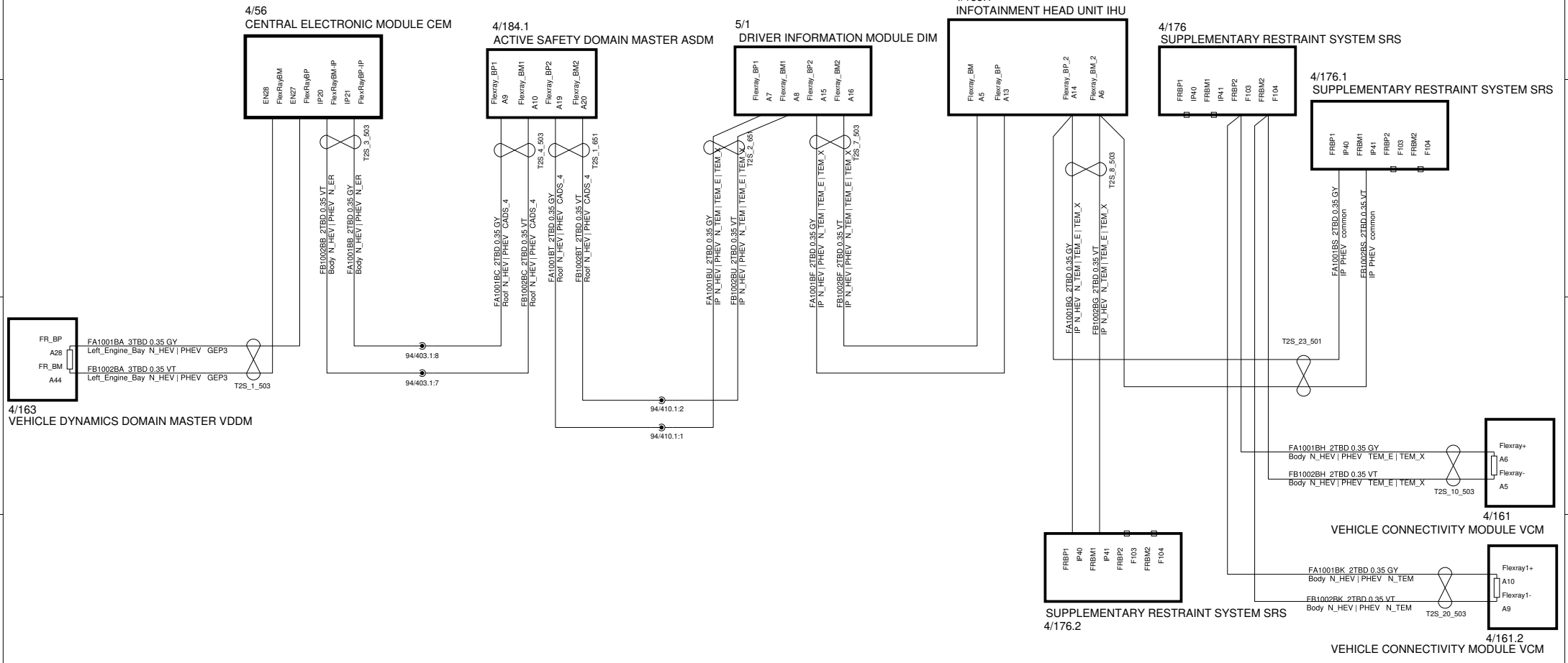

<p>The copying, distribution and utilization of this document as well as the communication of its contents to others without expressed authorization is prohibited. Offenders will be held liable for payment of damages. All rights reserved in the event of the grant of a patent, utility model or ornamental design registration.</p> <p><b>VOLVO</b> VOLVO CAR CORPORATION</p>	<p><b>Document title</b> 623A_PP_CC_04_06_2023 1E_FlexRay_Backbone_ICE_PHEV</p>	
	<p><b>Document Type</b> DRAW/ELSY</p>	<p><b>Release Status</b> RELEASED</p>
	<p>CEVT Document No 8888522365</p>	<p><b>Edited</b> April/12/2023</p>
	<p><b>Issue</b> 035</p>	<p><b>Page No</b> 34/146</p>

# 1E Front 2 FlexRay

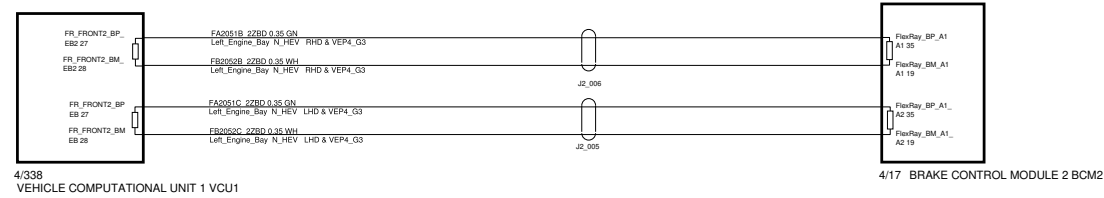
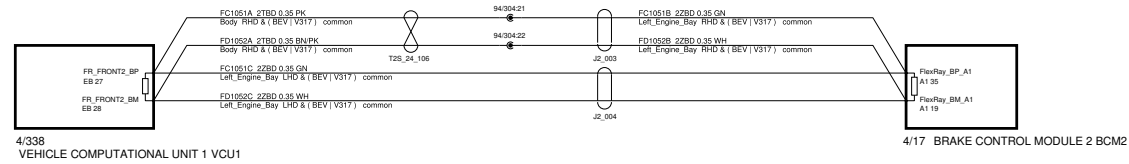

<p>The copying, distribution and utilization of this document as well as the communication of its contents to others without expressed authorization is prohibited. Offenders will be held liable for payment of damages. All rights reserved in the event of the grant of a patent, utility model or ornamental design registration.</p> <p><b>VOLVO</b> VOLVO CAR CORPORATION</p>	<p><b>Document title</b> 623A_PP_CC_04_06_2023</p> <p>1E_FlexRay_Front_2</p>	
	<p><b>Document Type</b></p> <p>DRAW/ELSY</p>	<p><b>Release Status</b></p> <p>RELEASED</p>
	<p>Volvo Document No 33445458</p>	<p><b>Edited</b> March/15/2023</p>
	<p><b>Issue</b> 035</p>	<p><b>Page No</b> 35/146</p>

# 1E Mid 2 FlexRay

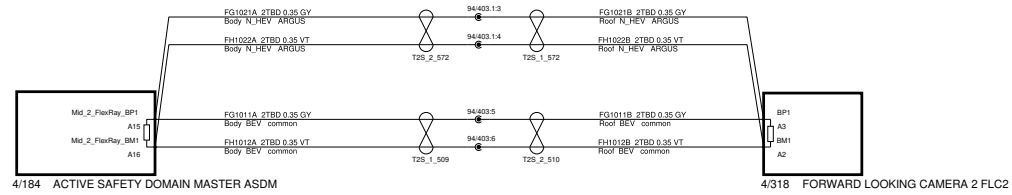

<p>The copying, distribution and utilization of this document as well as the communication of its contents to others without expressed authorization is prohibited. Offenders will be held liable for payment of damages. All rights reserved in the event of the grant of a patent, utility model or ornamental design registration.</p> <p style="text-align: center;"><b>VOLVO</b> VOLVO CAR CORPORATION</p>	<p><b>Document title</b> 623A_PP_CC_04_06_2023 1E_FlexRay_Mid_2</p>	
	<p><b>Document Type</b> DRAW/ELSY</p>	<p><b>Release Status</b> RELEASED</p>
	<p>Volvo Document No 33445458</p>	<p><b>Edited</b> March/15/2023</p>
	<p><b>Issue</b> 035</p>	<p><b>Page No</b> 36/146</p>

# 1E LIN Body Infotainment Powertrain

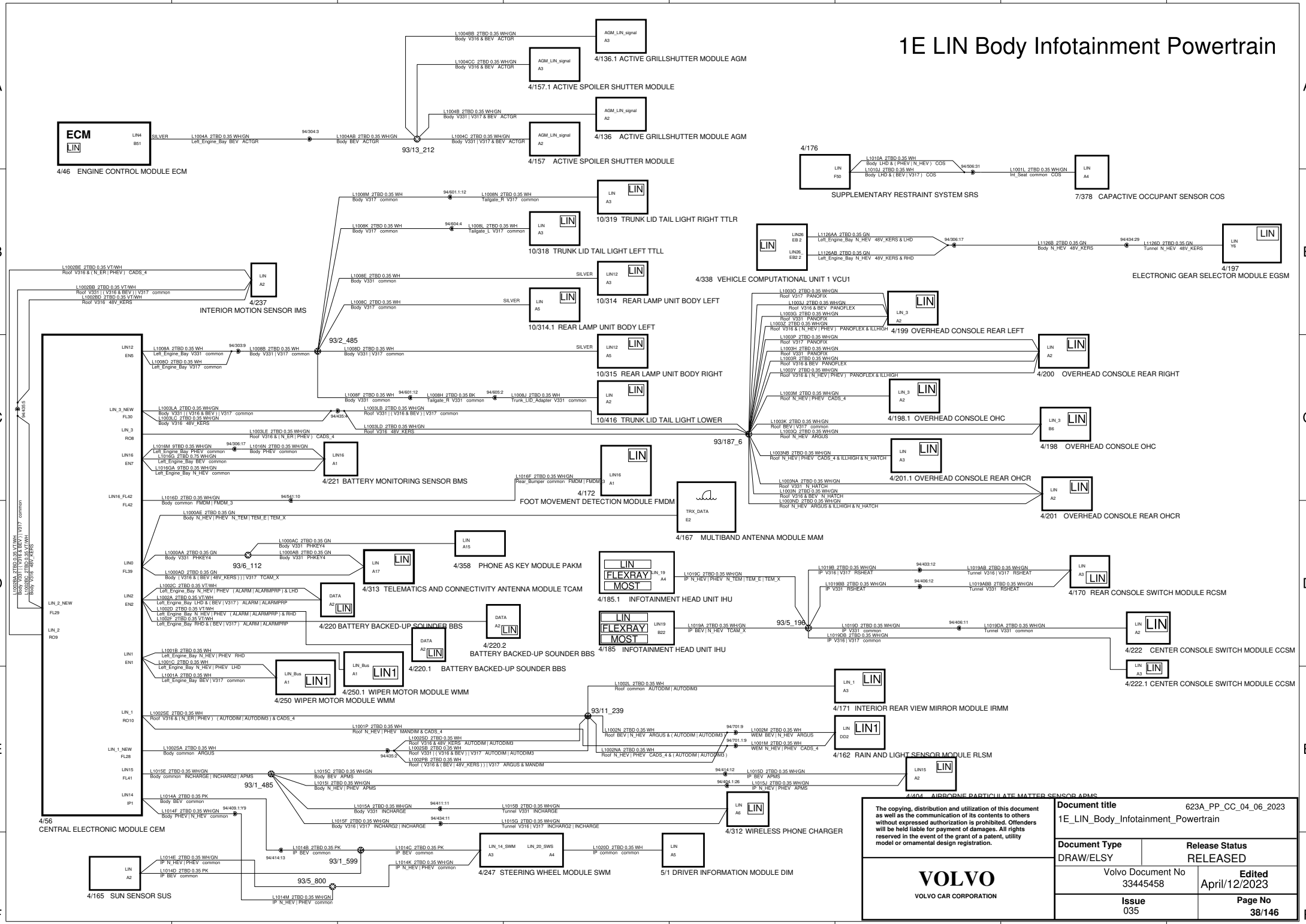

The copying, distribution and utilization of this document as well as the communication of its contents to others without expressed authorization is prohibited. Offenders will be held liable for payment of damages. All rights reserved in the event of the grant of a patent, utility model or ornamental design registration.



Document title		623A_PP_CC_04_06_2023	
1E_LIN_Body_Infotainment_Powertrain			
Document Type	Release Status		
DRAW/ELSY	RELEASED		
Issue	Volvo Document No	Edited	
035	33445458	April/12/2023	
		Page No	
		38/146	

# 1E LIN Body

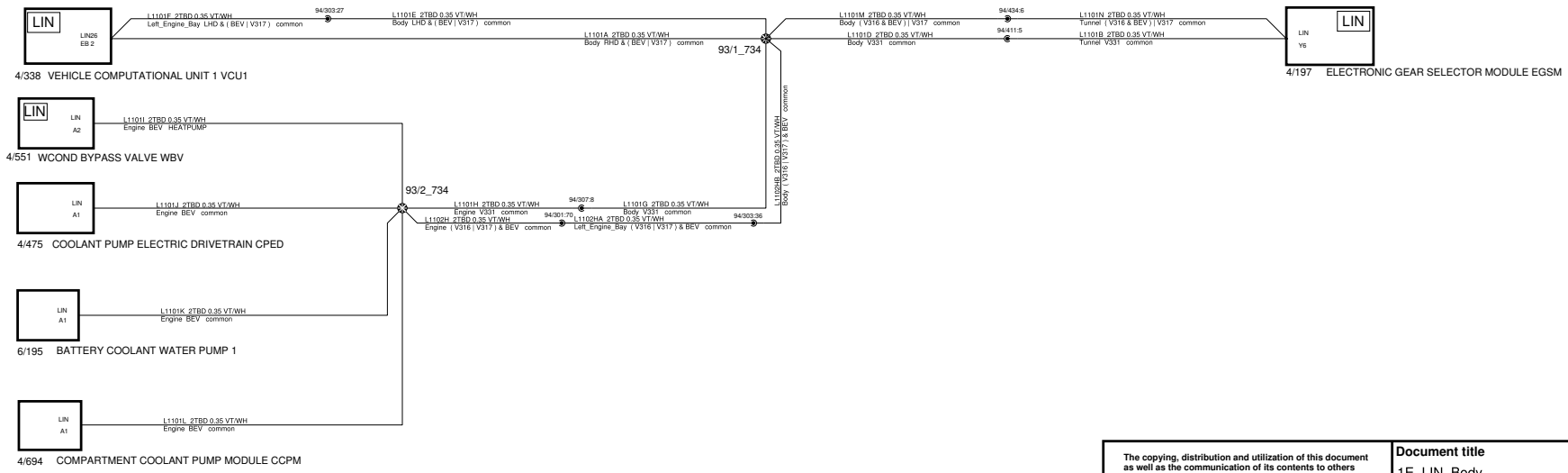
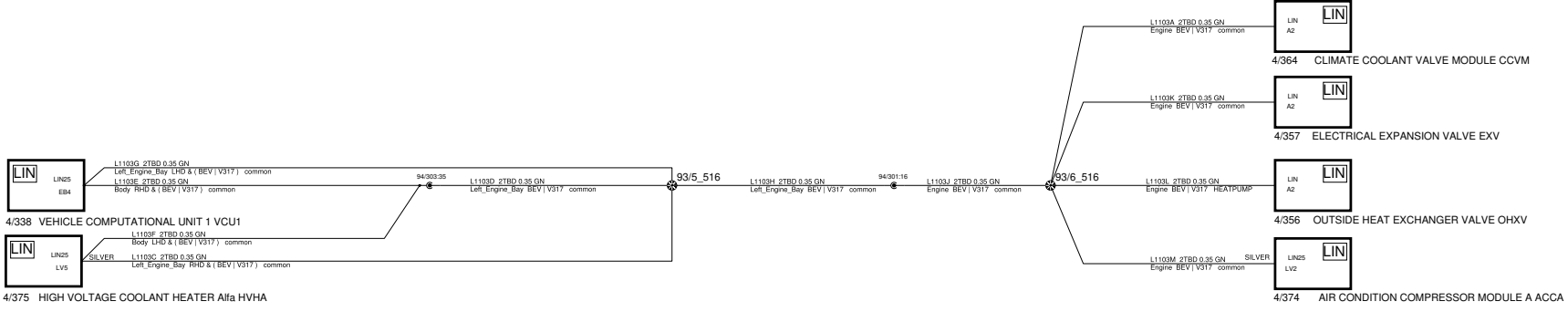

The copying, distribution and utilization of this document as well as the communication of its contents to others without expressed authorization is prohibited. Offenders will be held liable for payment of damages. All rights reserved in the event of the grant of a patent, utility model or ornamental design registration.		Document title 623A_PP_CC_04_06_2023	
		1E_LIN_Body	
<b>VOLVO</b> VOLVO CAR CORPORATION		Document Type DRAW/ELSY	Release Status RELEASED
		Volvo Document No 33445458	Edited April/12/2023
		Issue 035	Page No 37/146

# 1E LIN Comfort

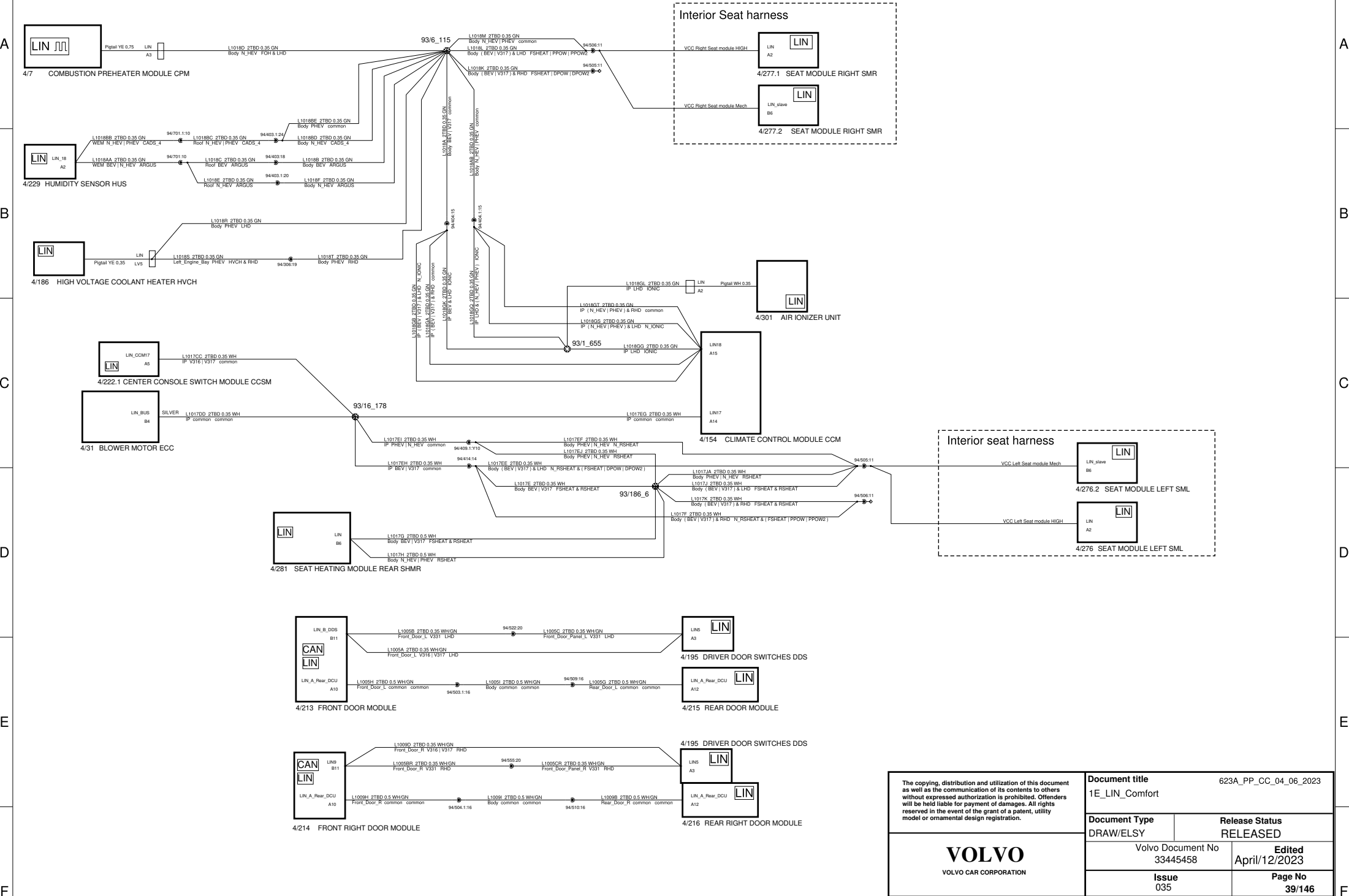

<p>The copying, distribution and utilization of this document as well as the communication of its contents to others without expressed authorization is prohibited. Offenders will be held liable for payment of damages. All rights reserved in the event of the grant of a patent, utility model or ornamental design registration.</p> <p><b>VOLVO</b> VOLVO CAR CORPORATION</p>		<p>Document title 1E_LIN_Comfort</p>		<p>623A_PP_CC_04_06_2023</p>	
		<p>Document Type DRAW/ELSY</p>		<p>Release Status RELEASED</p>	
		<p>Volvo Document No 33445458</p>		<p>Edited April/12/2023</p>	
		<p>Issue 035</p>		<p>Page No 39/146</p>	



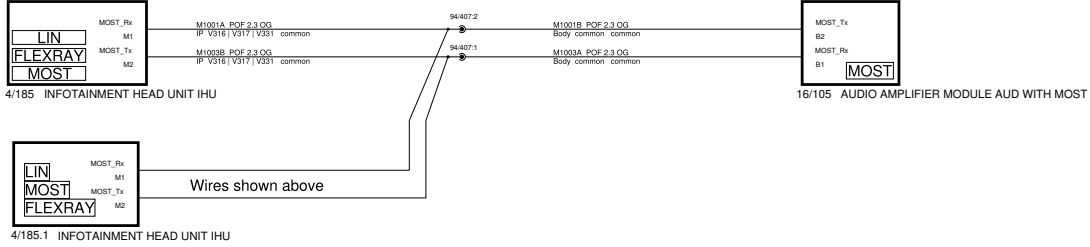

<p>The copying, distribution and utilization of this document as well as the communication of its contents to others without expressed authorization is prohibited. Offenders will be held liable for payment of damages. All rights reserved in the event of the grant of a patent, utility model or ornamental design registration.</p> <p><b>VOLVO</b> VOLVO CAR CORPORATION</p>	<p><b>Document title</b> 623A_PP_CC_04_06_2023</p> <p>1E_LIN_MOST</p>	
	<p><b>Document Type</b> DRAW/ELSY</p>	<p><b>Release Status</b> RELEASED</p>
	<p>Volvo Document No 33445458</p>	<p><b>Edited</b> November/01/2021</p>
	<p><b>Issue</b> 035</p>	<p><b>Page No</b> 40/146</p>

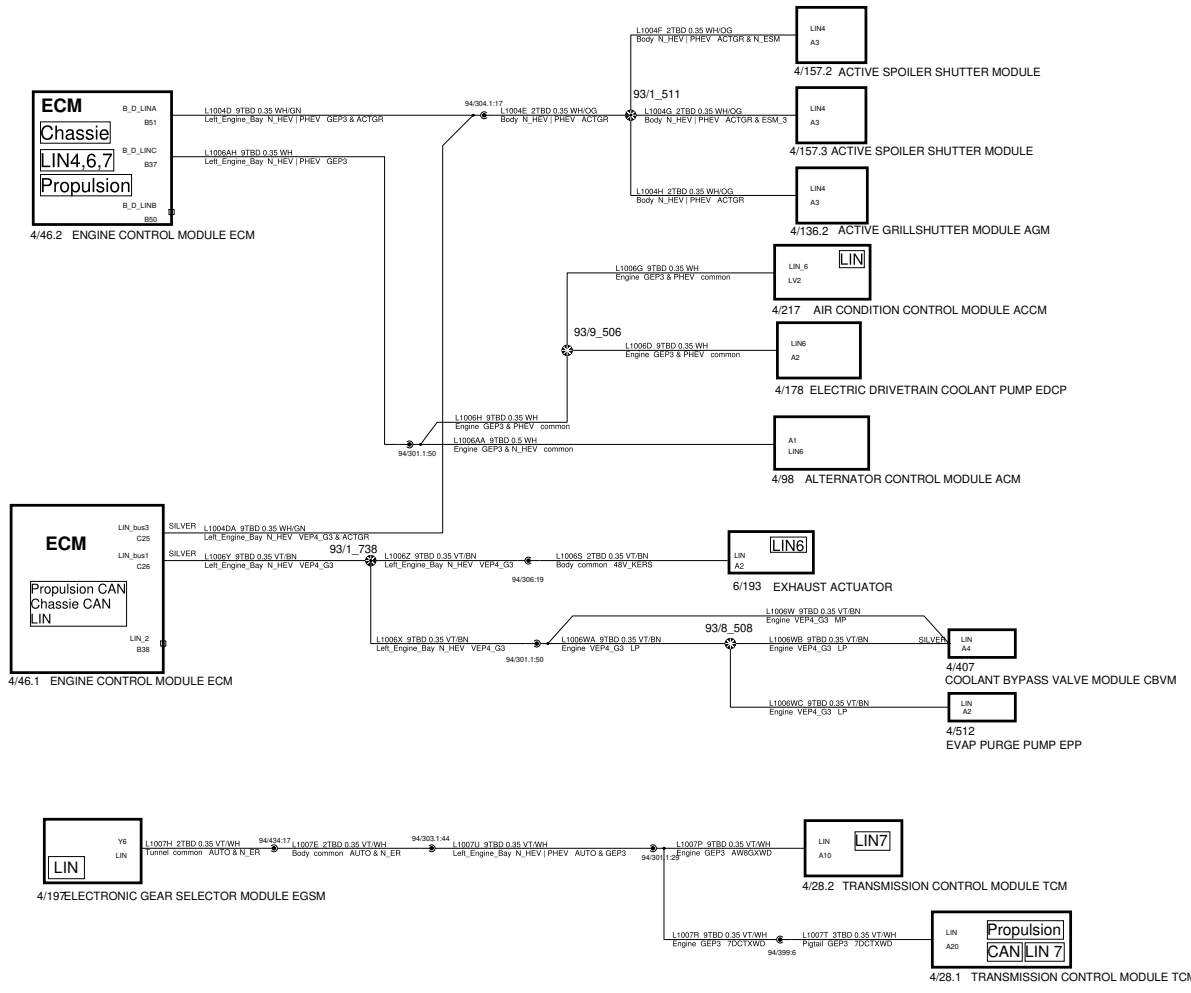

<p><b>VOLVO</b> VOLVO CAR CORPORATION</p>	<p><b>Document title</b> 623A_PP_CC_04_06_2023 1E_LIN_POWERTRAIN_N_BEV</p>	
	<p><b>Document Type</b> DRAW/ELSY</p>	<p><b>Release Status</b> RELEASED</p>
	<p>CEVT Document No 8888522365</p>	<p><b>Edited</b> April/12/2023</p>
	<p><b>Issue</b> 035</p>	<p><b>Page No</b> 41/146</p>

# 1F Accessories Preparation

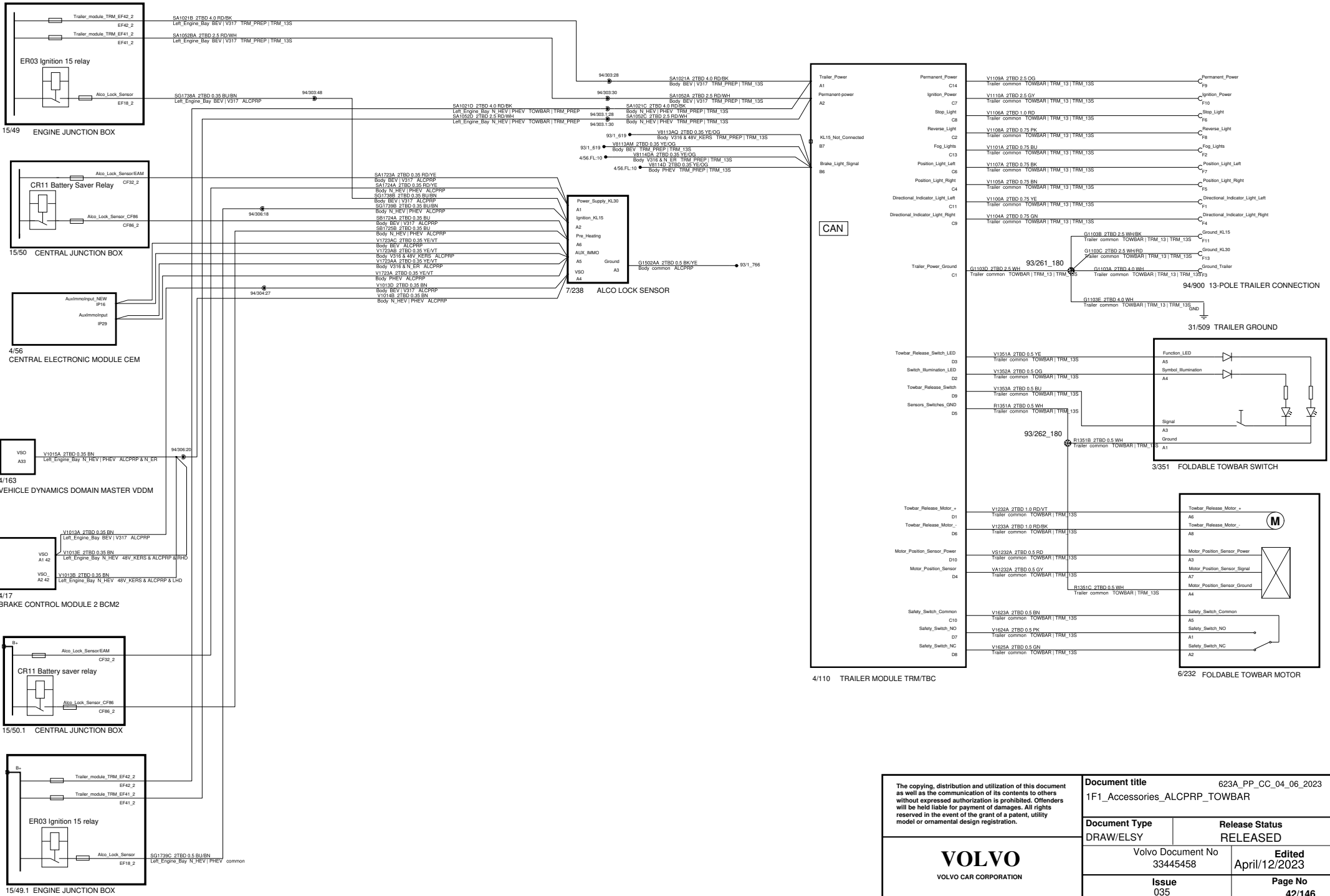

<p>The copying, distribution and utilization of this document as well as the communication of its contents to others without expressed authorization is prohibited. Offenders will be held liable for payment of damages. All rights reserved in the event of the grant of a patent, utility model or ornamental design registration.</p> <p><b>VOLVO</b> VOLVO CAR CORPORATION</p>	<p><b>Document title</b> 623A_PP_CC_04_06_2023 1F1_Accessories_ALCRPP_TOWBAR</p>	
	<p><b>Document Type</b> DRAW/ELSY</p>	<p><b>Release Status</b> RELEASED</p>
	<p>Volvo Document No 33445458</p>	<p><b>Edited</b> April/12/2023</p>
	<p><b>Issue</b> 035</p>	<p><b>Page No</b> 42/146</p>



15/49 ENGINE JUNCTION BOX

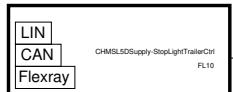

4/56 CENTRAL ELECTRONIC MODULE CEM

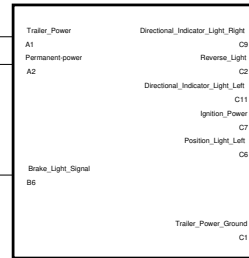

4/110 TRAILER MODULE TRM/TBC

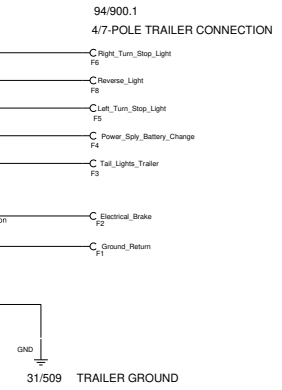
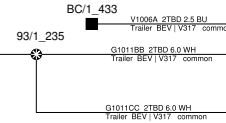

<p>The copying, distribution and utilization of this document as well as the communication of its contents to others without expressed authorization is prohibited. Offenders will be held liable for payment of damages. All rights reserved in the event of the grant of a patent, utility model or ornamental design registration.</p> <p><b>VOLVO</b> VOLVO CAR CORPORATION</p>	<p><b>Document title</b> 623A_PP_CC_04_06_2023 1F2_Assessories_Towing_System_4/7-pole_US</p>	
	<p><b>Document Type</b> DRAW/ELSY</p>	<p><b>Release Status</b> RELEASED</p>
	<p>CEVT Document No 8888522365</p>	<p><b>Edited</b> June/16/2021</p>
	<p><b>Issue</b> 035</p>	<p><b>Page No</b> 43/146</p>

# 1F3 Accessories Rear Park Assist Camera

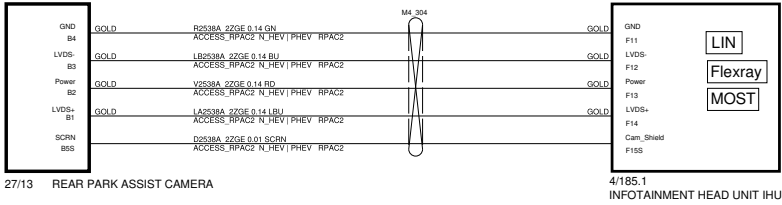

<p>The copying, distribution and utilization of this document as well as the communication of its contents to others without expressed authorization is prohibited. Offenders will be held liable for payment of damages. All rights reserved in the event of the grant of a patent, utility model or ornamental design registration.</p> <p><b>VOLVO</b> VOLVO CAR CORPORATION</p>	<b>Document title</b> 623A_PP_CC_04_06_2023 1F3_Accessories_Rear_Park_Assist_Camera	
	<b>Document Type</b> DRAW/ELSY	<b>Release Status</b> RELEASED
	CEVT Document No 8888522365	<b>Edited</b> November/01/2021
	<b>Issue</b> 035	<b>Page No</b> 44/146

# 1F4 Accessories USB Hub Installation Aftermarket

Intended solution to provide USB Hub to replace USB1 functionality  
[Valid up until structure 19W17]

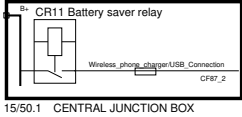

S8605A 2TBD 0.5 RD  
ACCESS\_USB\_HUB\_N\_HEV1PHEV\_USB\_1

G1370B 2TBD 0.5 BK  
ACCESS\_USB\_HUB\_RHD\_USB\_1  
G1380E 2TBD 0.5 BK  
ACCESS\_USB\_HUB\_LHD\_USB\_1

31/402 GROUND IP A-POST RIGHT

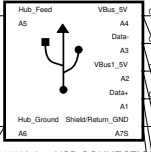

Wires shown on 7A Infotainment page

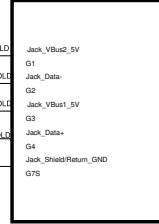

4/185 INFOTAINMENT HEAD UNIT IHU

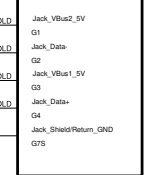

4/185.1 INFOTAINMENT HEAD UNIT IHU

<p>The copying, distribution and utilization of this document as well as the communication of its contents to others without expressed authorization is prohibited. Offenders will be held liable for payment of damages. All rights reserved in the event of the grant of a patent, utility model or ornamental design registration.</p> <p><b>VOLVO</b> VOLVO CAR CORPORATION</p>	<p><b>Document title</b> 623A_PP_CC_04_06_2023 1F4_Accessories_USB_Hub_Installation_Aftermarket</p>	
	<p><b>Document Type</b> DRAW/ELSY</p>	<p><b>Release Status</b> RELEASED</p>
	<p>CEVT Document No 8888522365</p>	<p><b>Edited</b> November/01/2021</p>
	<p><b>Issue</b> 035</p>	<p><b>Page No</b> 45/146</p>

# 1F5 Accessories Steering Wheel Heating

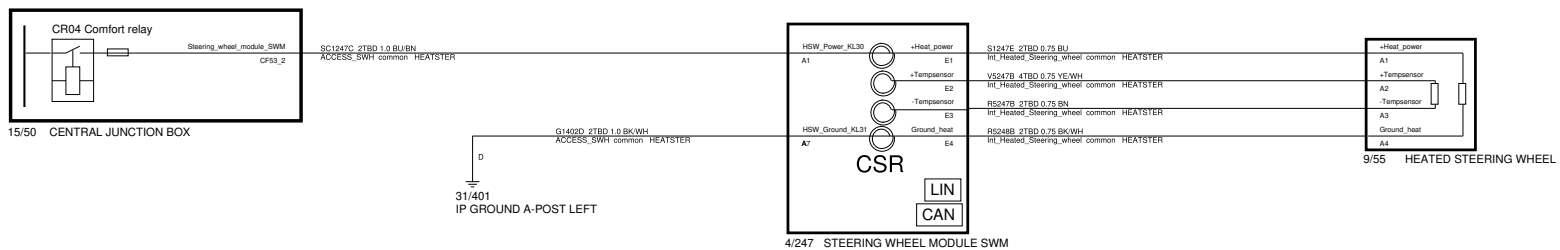

<p>The copying, distribution and utilization of this document as well as the communication of its contents to others without expressed authorization is prohibited. Offenders will be held liable for payment of damages. All rights reserved in the event of the grant of a patent, utility model or ornamental design registration.</p> <p><b>VOLVO</b> VOLVO CAR CORPORATION</p>	<p><b>Document title</b> 623A_PP_CC_04_06_2023 1F5_Accessories_Steering_Wheel_Heating</p>	
	<p><b>Document Type</b> DRAW/ELSY</p>	<p><b>Release Status</b> RELEASED</p>
	<p>CEVT Document No 8888522365</p>	<p><b>Edited</b> April/12/2023</p>
	<p><b>Issue</b> 035</p>	<p><b>Page No</b> 46/146</p>

# 1H EI Distribution High Voltage

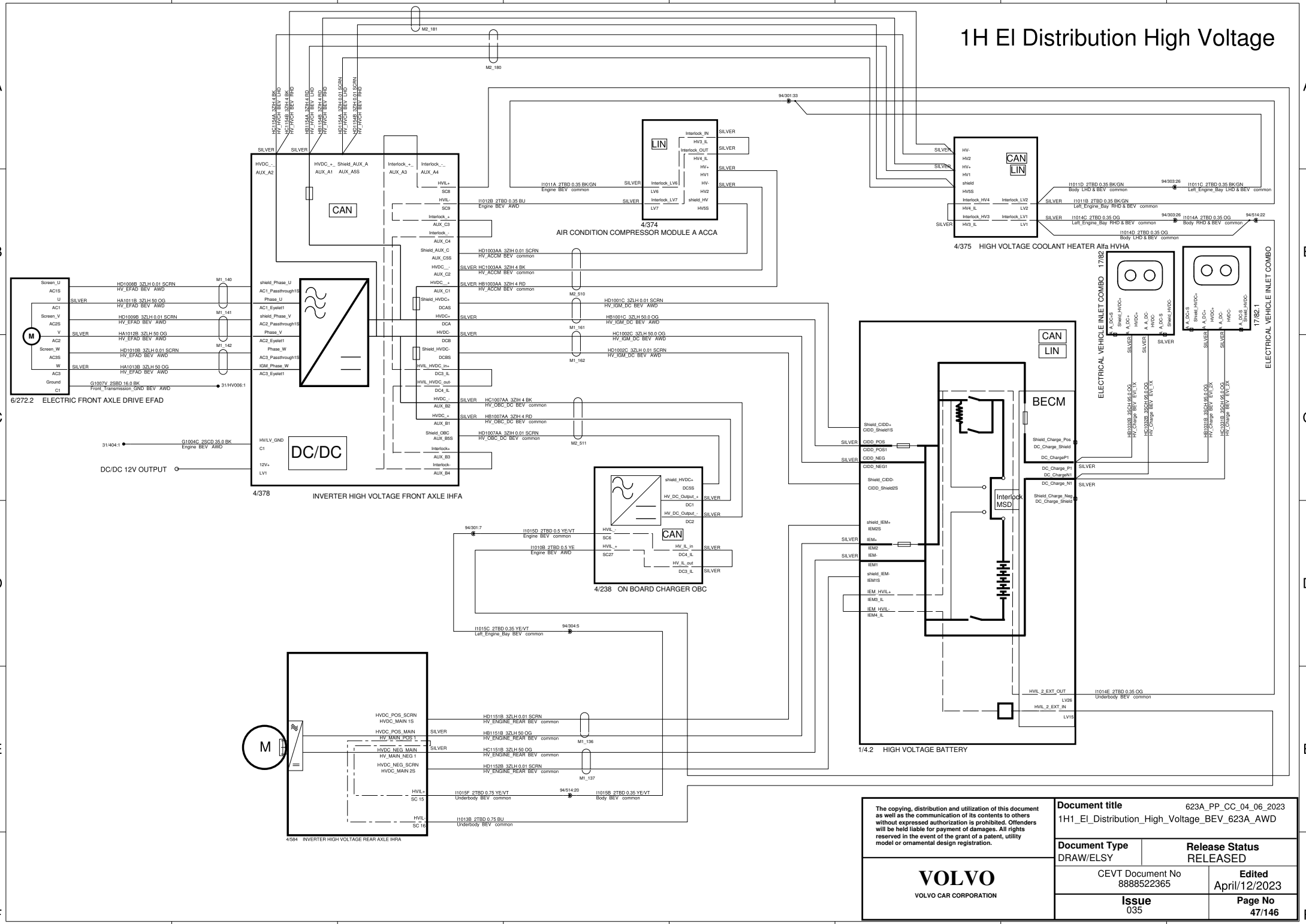

The copying, distribution and utilization of this document as well as the communication of its contents to others without expressed authorization is prohibited. Offenders will be held liable for payment of damages. All rights reserved in the event of the grant of a patent, utility model or ornamental design registration.

**VOLVO**  
VOLVO CAR CORPORATION

<b>Document title</b> 623A_PP_CC_04_06_2023 1H1_Ei_Distribution_High_Voltage_BEV_623A_AWD	
<b>Document Type</b> DRAW/ELSY	<b>Release Status</b> RELEASED
CEVT Document No 8888522365	<b>Edited</b> April/12/2023
<b>Issue</b> 035	<b>Page No</b> 47/146



# 1H EI Distribution High Voltage

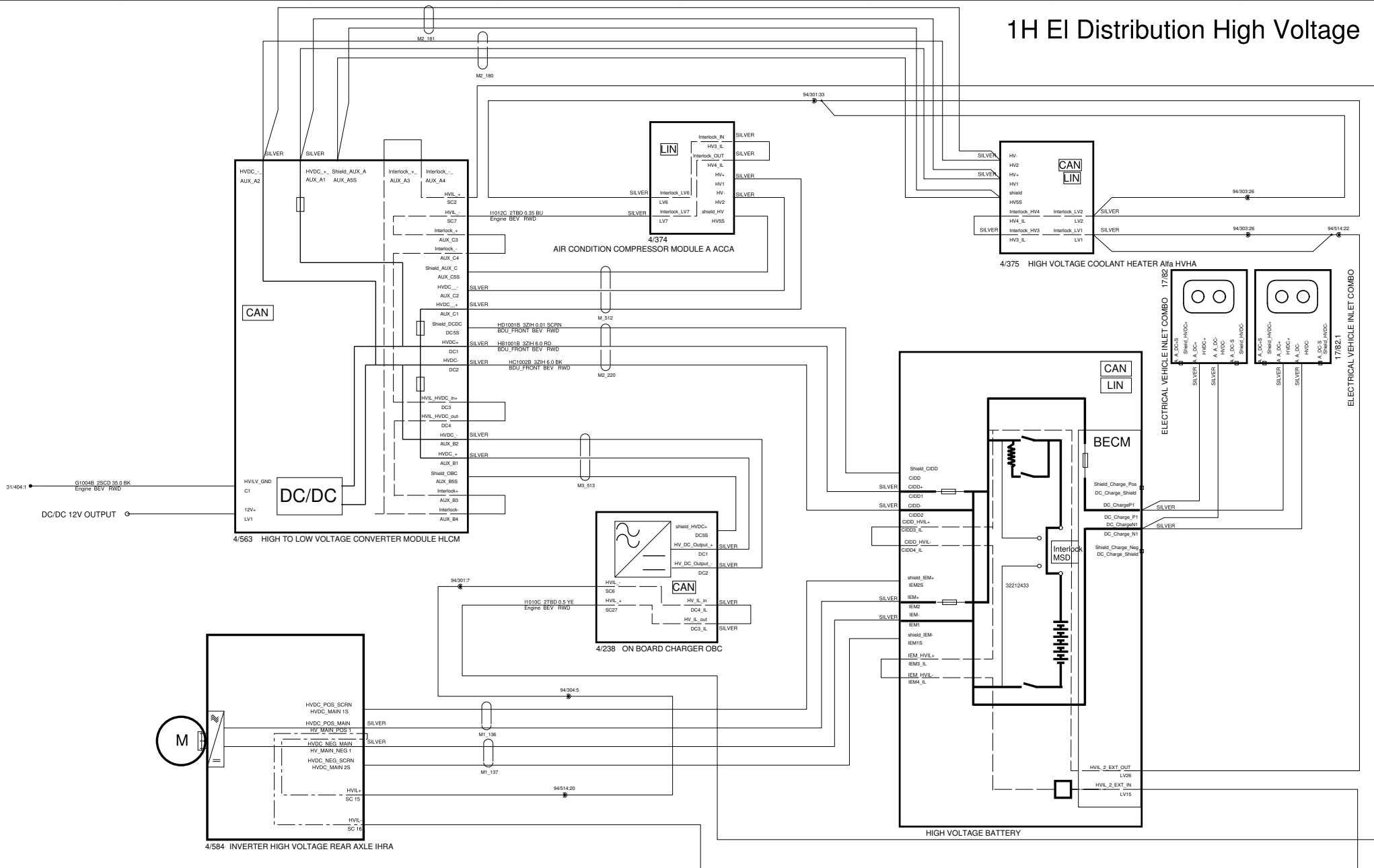

<p>The copying, distribution and utilization of this document as well as the communication of its contents to others without expressed authorization is prohibited. Offenders will be held liable for payment of damages. All rights reserved in the event of the grant of a patent, utility model or ornamental design registration.</p> <p><b>VOLVO</b> VOLVO CAR CORPORATION</p>	<p><b>Document title</b> 623A_PP_CC_04_06_2023 1H1_EI_Distribution_High_Voltage_BEV_623A_FWD</p>	
	<p><b>Document Type</b> DRAW/ELSY</p>	<p><b>Release Status</b> RELEASED</p>
	<p>CEVT Document No 8888522365</p>	<p><b>Edited</b> April/12/2023</p>
	<p><b>Issue</b> 035</p>	<p><b>Page No</b> 48/146</p>

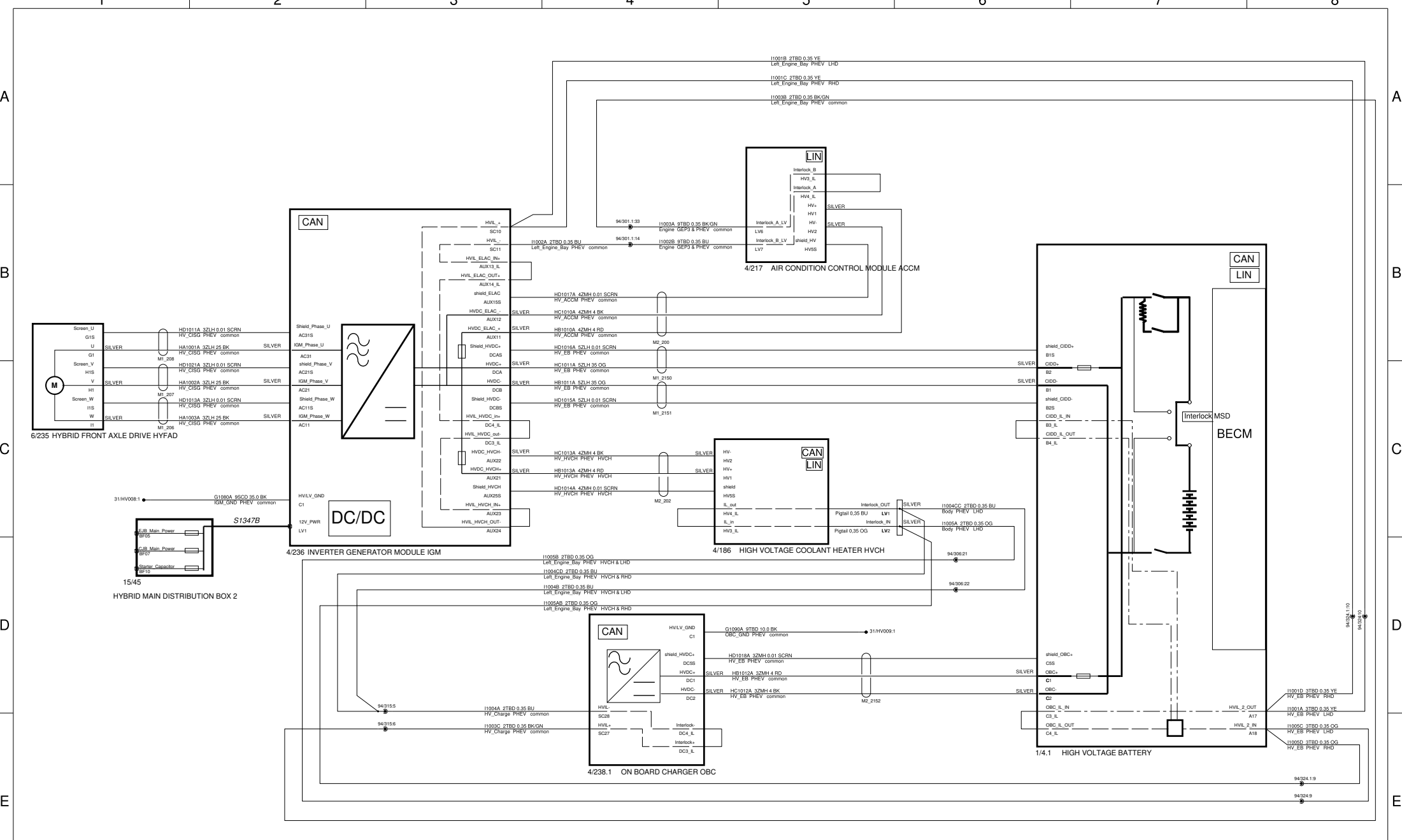

<p>The copying, distribution and utilization of this document as well as the communication of its contents to others without expressed authorization is prohibited. Offenders will be held liable for payment of damages. All rights reserved in the event of the grant of a patent, utility model or ornamental design registration.</p>		<p>Document title 623A_PP_CC_04_06_2023 1H2_EI_Distribution_High_Voltage_PHEV</p>	
		<p>Document Type DRAW/ELSY</p>	<p>Release Status RELEASED</p>
<p><b>VOLVO</b> VOLVO CAR CORPORATION</p>		<p>CEVT Document No 8888522365</p>	<p>Edited March/30/2023</p>
		<p>Issue 035</p>	<p>Page No 49/146</p>

# 1K EI Energy Management High Voltage 623

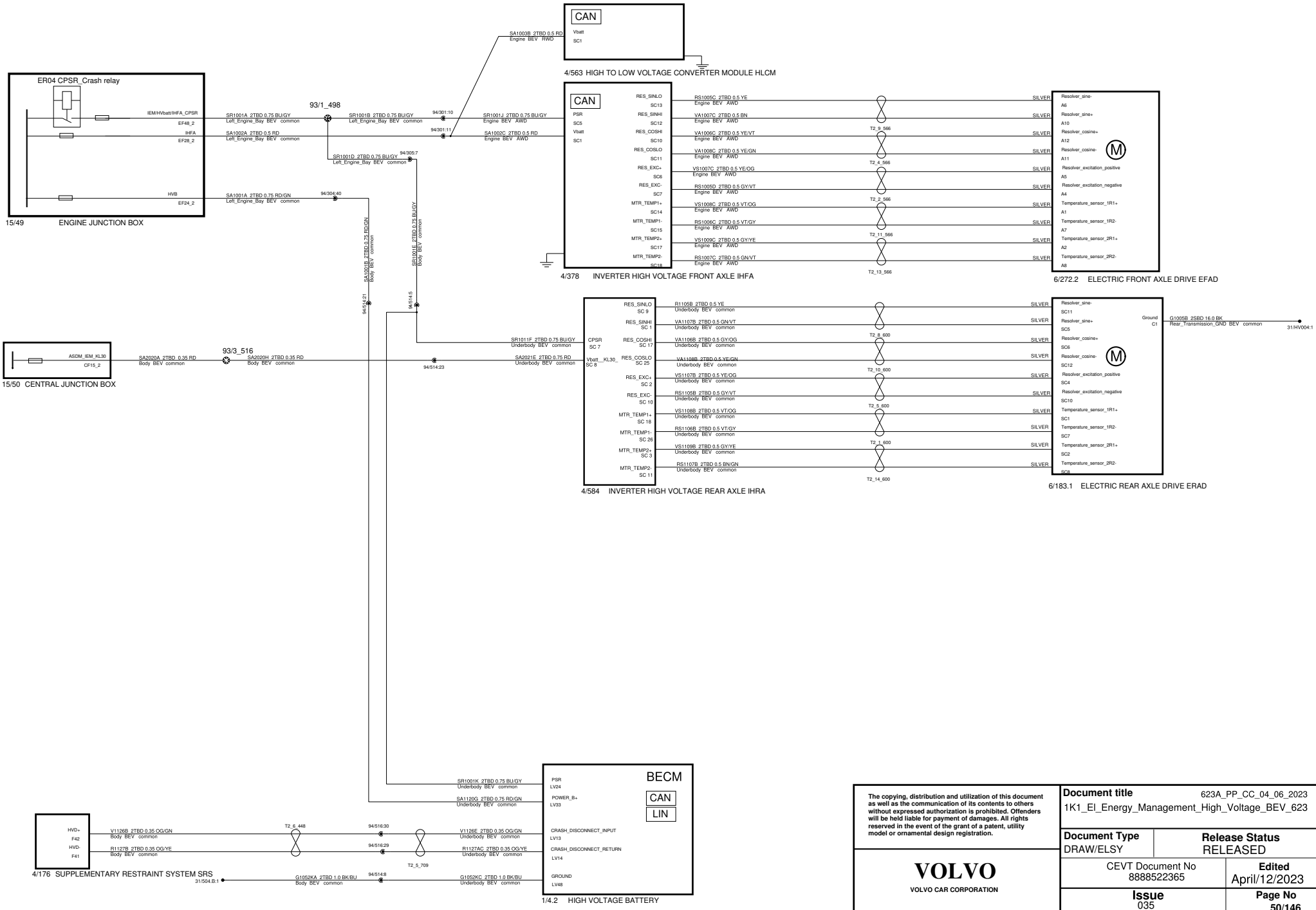

<p>The copying, distribution and utilization of this document as well as the communication of its contents to others without expressed authorization is prohibited. Offenders will be held liable for payment of damages. All rights reserved in the event of the grant of a patent, utility model or ornamental design registration.</p> <p><b>VOLVO</b> VOLVO CAR CORPORATION</p>		<p><b>Document title</b> 623A_PP_CC_04_06_2023 1K1_EI_Energy_Management_High_Voltage_BEV_623</p>	
		<p><b>Document Type</b> DRAW/ELSY</p>	<p><b>Release Status</b> RELEASED</p>
		<p>CEVT Document No 8888522365</p>	<p><b>Edited</b> April/12/2023</p>
		<p><b>Issue</b> 035</p>	<p><b>Page No</b> 50/146</p>

# 1K EI Energy Management High Voltage-China Market ARTEI-27579

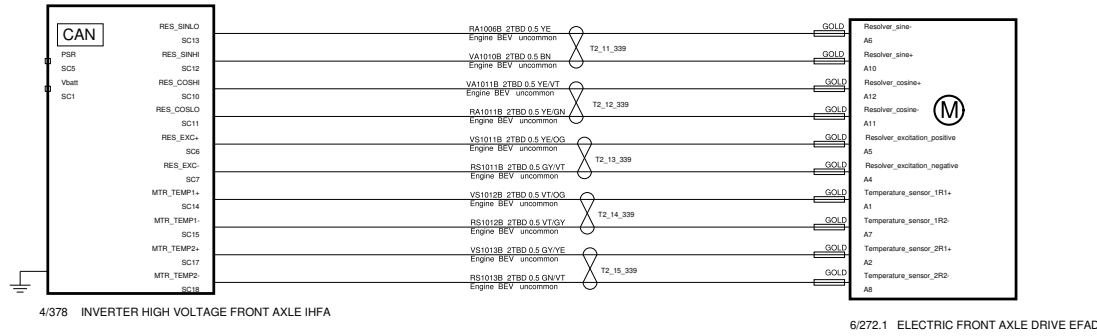

<p>The copying, distribution and utilization of this document as well as the communication of its contents to others without expressed authorization is prohibited. Offenders will be held liable for payment of damages. All rights reserved in the event of the grant of a patent, utility model or ornamental design registration.</p> <p><b>VOLVO</b> VOLVO CAR CORPORATION</p>	<b>Document title</b> 623A_PP_CC_04_06_2023 1K2_EI_Energy_Managemnet_High_Voltage_BEV_3X	
	<b>Document Type</b> DRAW/ELSY	<b>Release Status</b> RELEASED
	CEVT Document No 8888522365	<b>Edited</b> April/04/2023
	<b>Issue</b> 035	<b>Page No</b> 51/146

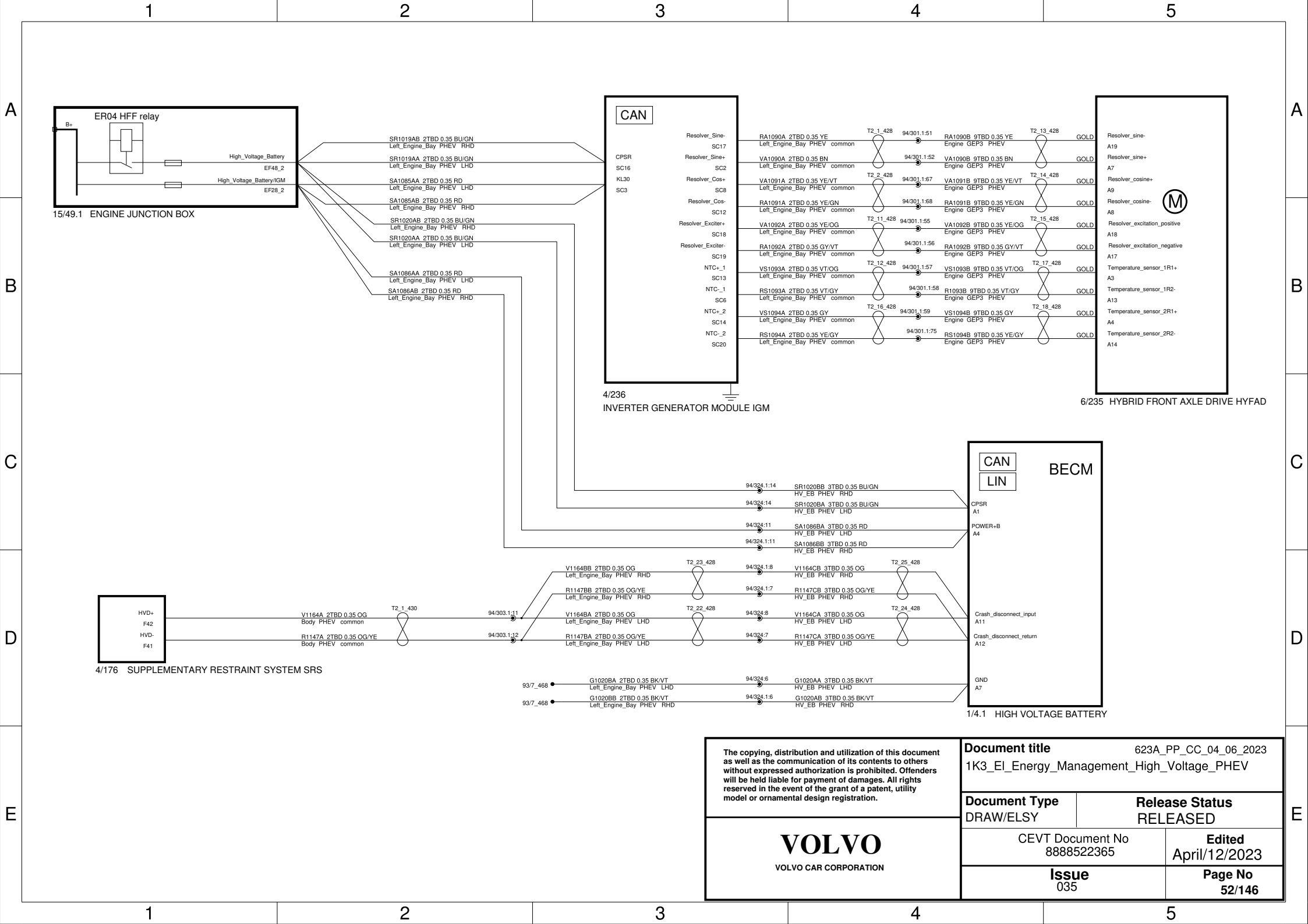

<p>The copying, distribution and utilization of this document as well as the communication of its contents to others without expressed authorization is prohibited. Offenders will be held liable for payment of damages. All rights reserved in the event of the grant of a patent, utility model or ornamental design registration.</p> <p><b>VOLVO</b> VOLVO CAR CORPORATION</p>	<p><b>Document title</b> 623A_PP_CC_04_06_2023 1K3_EI_Energy_Management_High_Voltage_PHEV</p>	
	<p><b>Document Type</b> DRAW/ELSY</p>	<p><b>Release Status</b> RELEASED</p>
	<p>CEVT Document No 8888522365</p>	<p><b>Edited</b> April/12/2023</p>
	<p><b>Issue</b> 035</p>	<p><b>Page No</b> 52/146</p>

DC Charging wires in sheet 1H

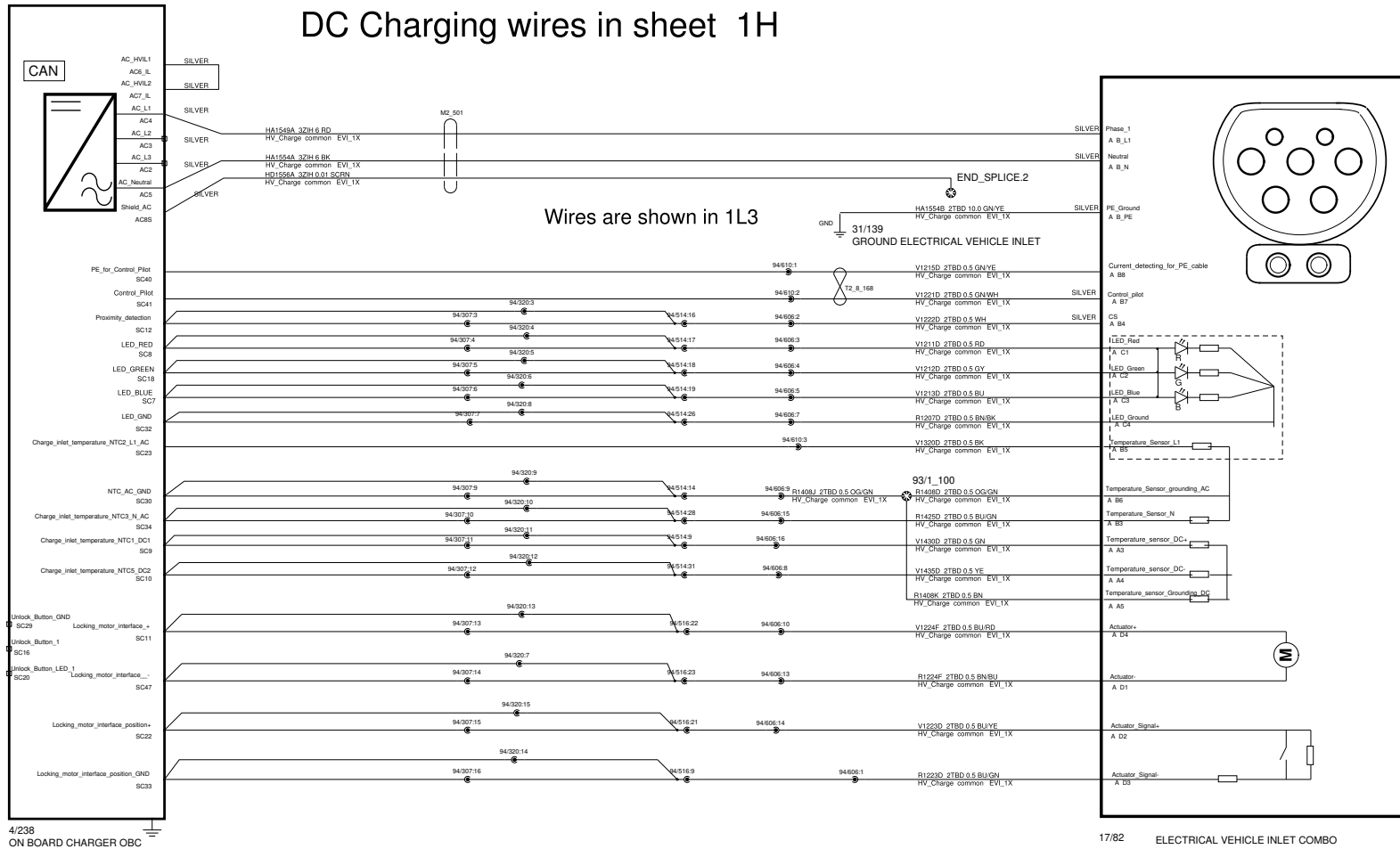

<p><b>VOLVO</b> VOLVO CAR CORPORATION</p>	<p><b>Document title</b> 623A_PP_CC_04_06_2023 1L1_EI_generating_public_network_1X</p>	
	<p><b>Document Type</b> DRAW/ELSY</p>	<p><b>Release Status</b> RELEASED</p>
	<p>CEVT Document No 8888522365</p>	<p><b>Edited</b> March/21/2023</p>
	<p><b>Issue</b> 035</p>	<p><b>Page No</b> 53/146</p>

# 1L3 EI generating public network

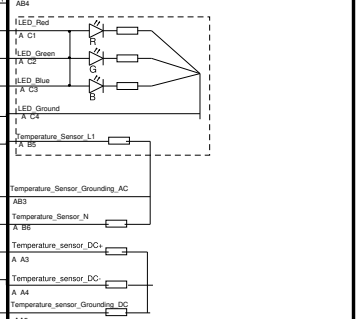
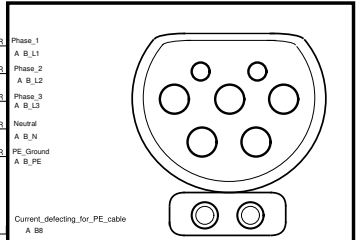
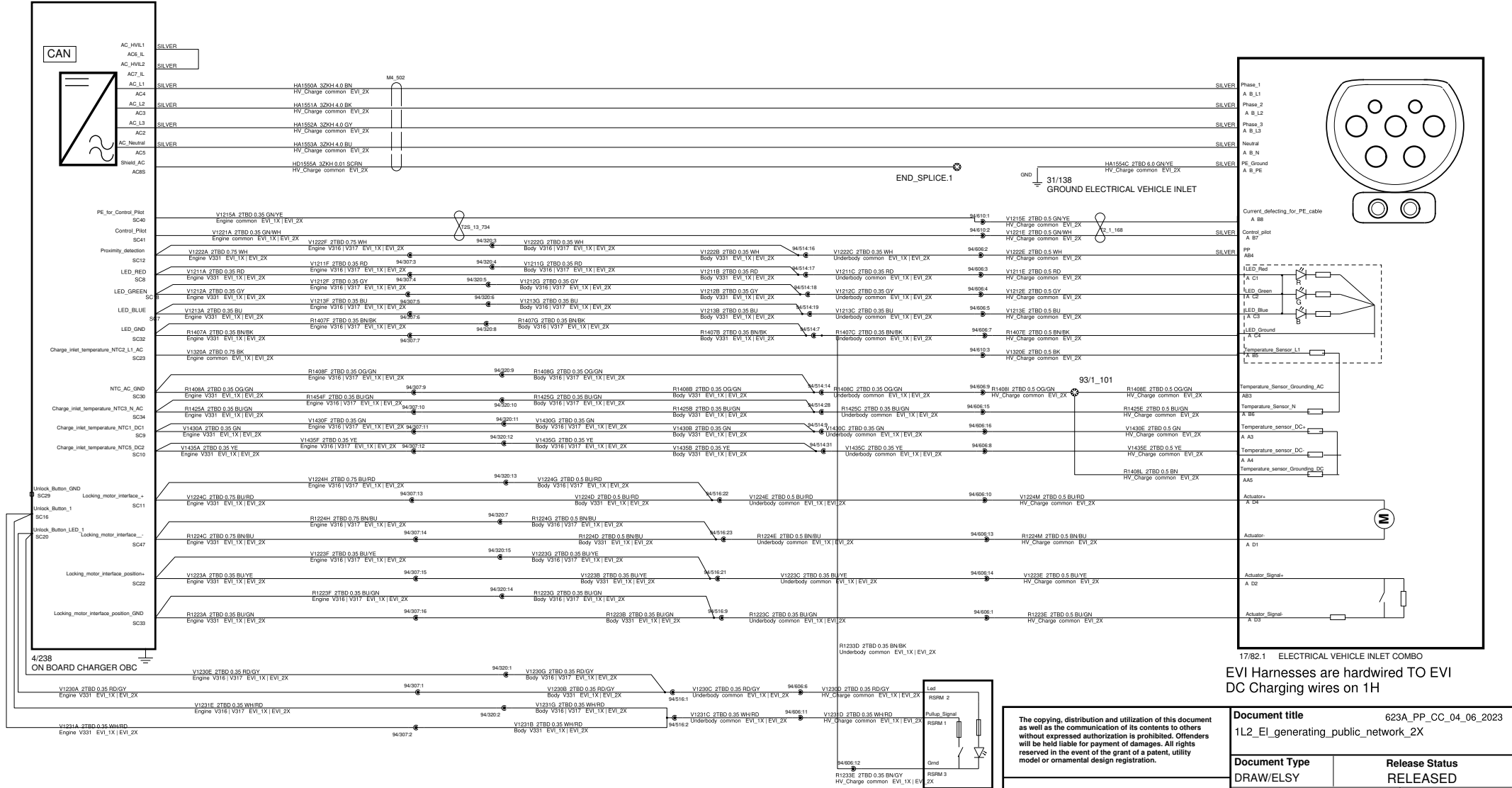

EV1 Harnesses are hardwired TO EV1 DC Charging wires on 1H

The copying, distribution and utilization of this document as well as the communication of its contents to others without expressed authorization is prohibited. Offenders will be held liable for payment of damages. All rights reserved in the event of the grant of a patent, utility model or ornamental design registration.

Document title: 623A\_PP\_CC\_04\_06\_2023  
1L2\_EI\_generating\_public\_network\_2X

Document Type	Release Status
DRAW/ELSY	RELEASED
Volvo Document No 33445458	Edited April/12/2023
Issue 035	Page No 54/146

**VOLVO**  
VOLVO CAR CORPORATION

3/447  
CHARGE CABLE RELEASE SWITCH

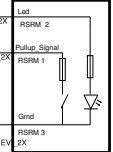

# 1L4 EI generating public network

EVI harnesses are hardwired to EVI

## GROUND ELECTRICAL VEHICAL INLET

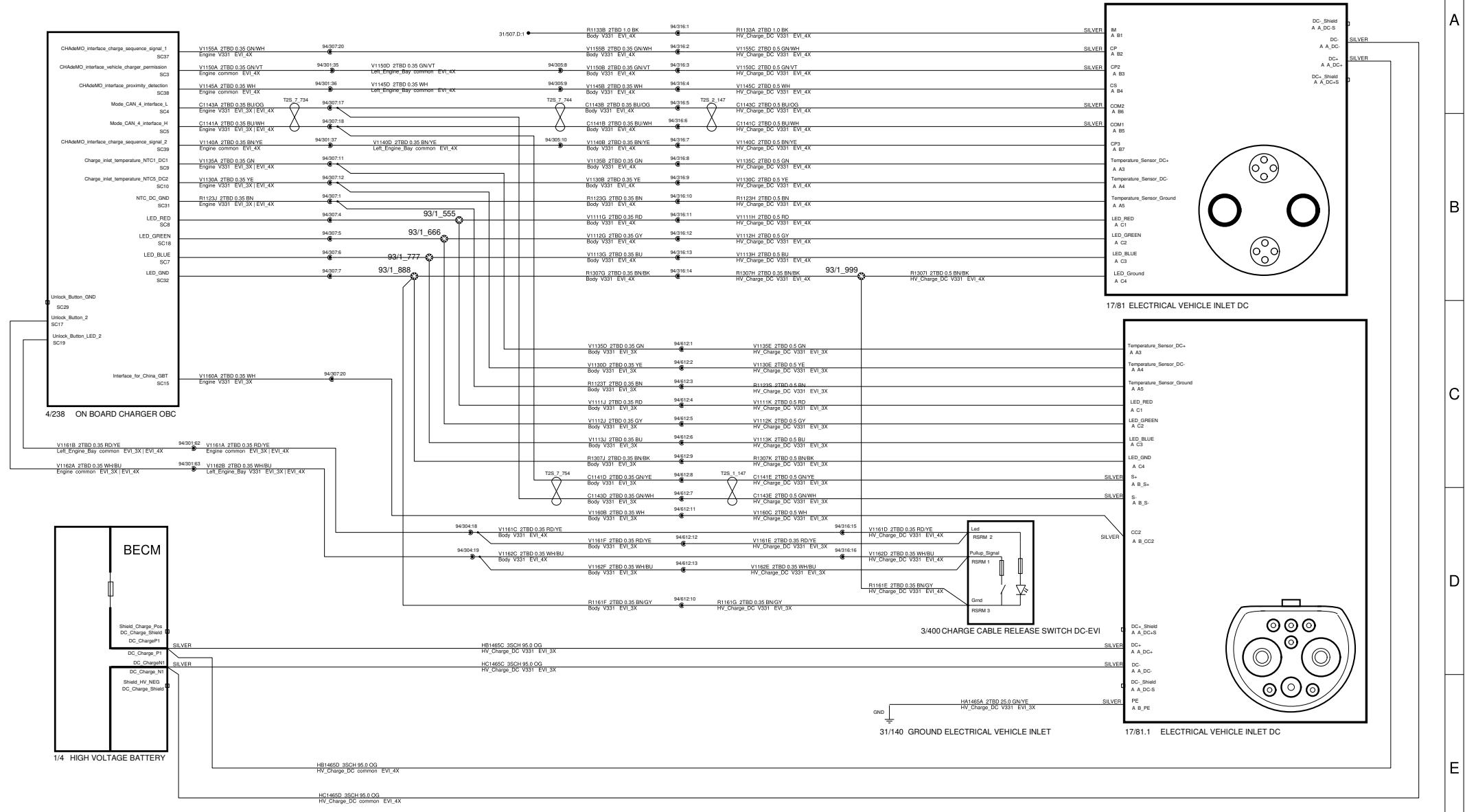

 VOLVO CAR CORPORATION	The copying, distribution and utilization of this document as well as the communication of its contents to others without expressed authorization is prohibited. Offenders will be held liable for payment of damages. All rights reserved in the event of the grant of a patent, utility model or ornamental design registration.		<b>Document title</b> 623A_PP_CC_04_06_2023 1L3_EI_generating_public_network_V331_3X-4X_DC	
	<b>Document Type</b> DRAW/ELSY		<b>Release Status</b> RELEASED	
	CEVT Document No 8888522365		Edited April/12/2023	
<b>Issue</b> 035		<b>Page No</b> 55/146		



# 1L7 EI generating public network

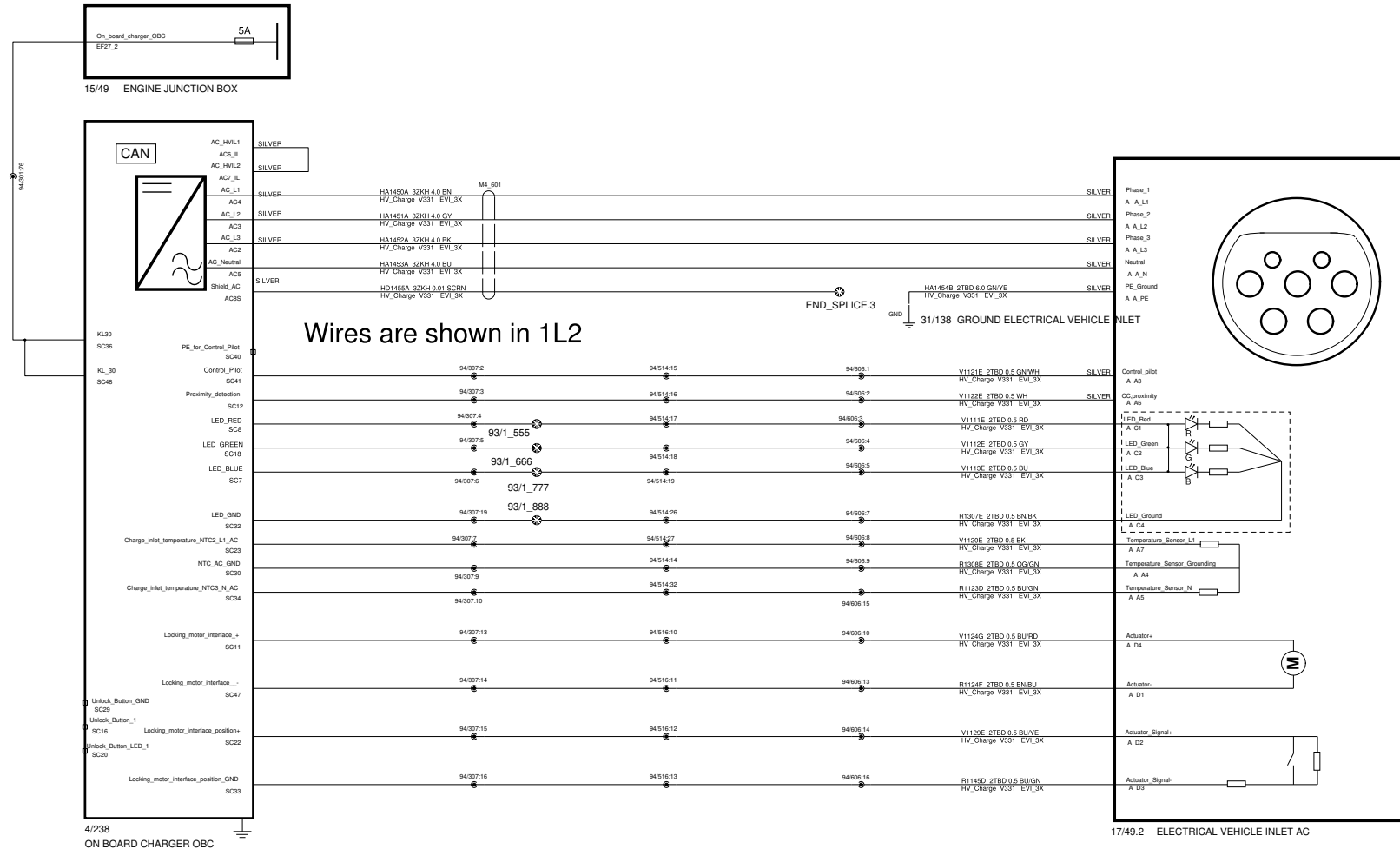

Wires are shown in 1L2

<p><b>VOLVO</b> VOLVO CAR CORPORATION</p>	<p>The copying, distribution and utilization of this document as well as the communication of its contents to others without expressed authorization is prohibited. Offenders will be held liable for payment of damages. All rights reserved in the event of the grant of a patent, utility model or ornamental design registration.</p>		<p><b>Document title</b> 623A_PP_CC_04_06_2023 1L4_EI_generating_public_network_V331_3X_AC</p>	
	<p><b>Document Type</b> DRAW/ELSY</p>		<p><b>Release Status</b> RELEASED</p>	
	<p>CEVT Document No 8888522365</p>		<p><b>Edited</b> April/12/2023</p>	
	<p><b>Issue</b> 035</p>		<p><b>Page No</b> 56/146</p>	



# 1L6 EI generating public network

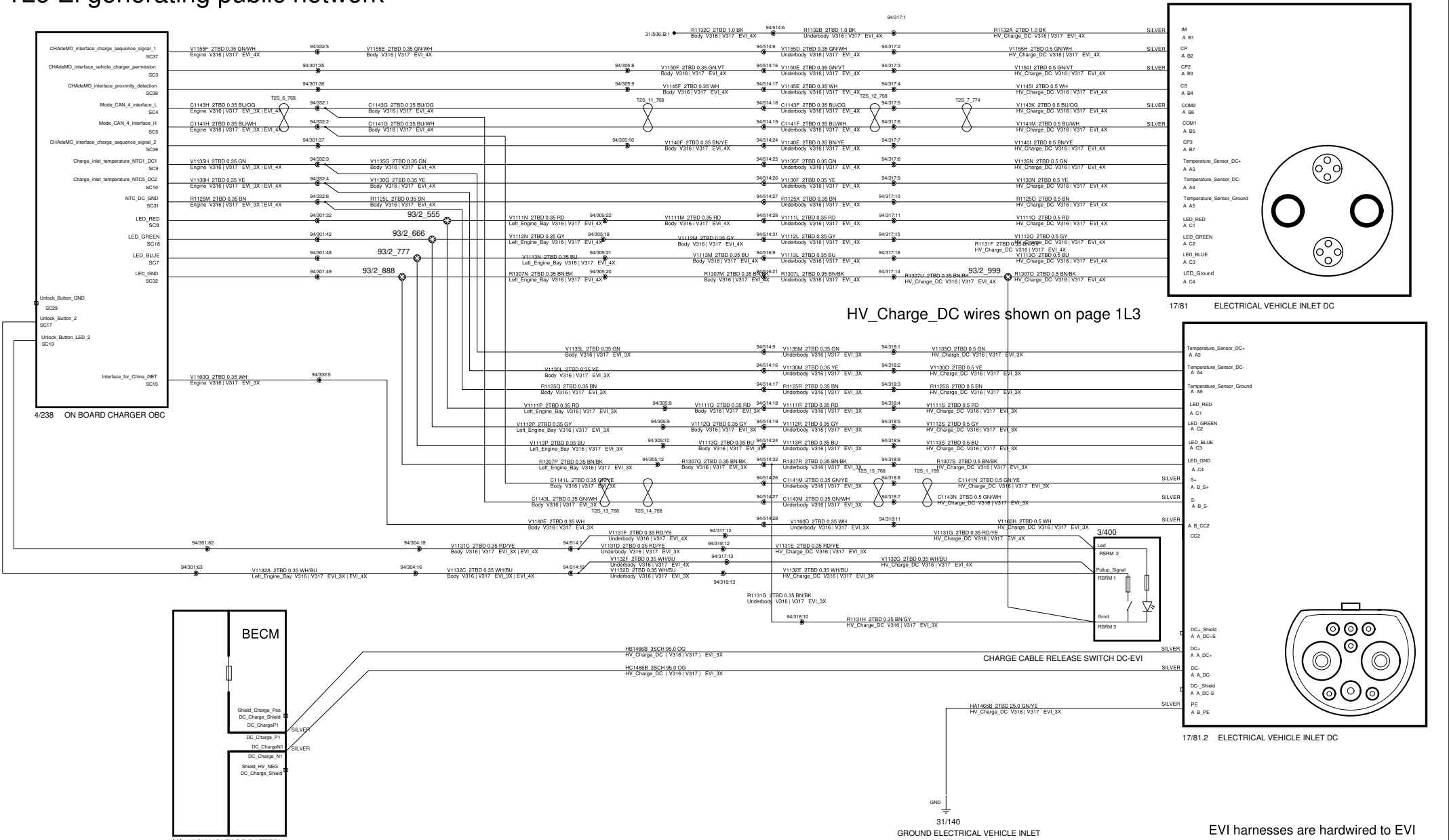

HV\_Charge\_DC wires shown on page 1L3

<p>The copying, distribution and utilization of this document as well as the communication of its contents to others without expressed authorization is prohibited. Offenders will be held liable for payment of damages. All rights reserved in the event of the grant of a patent, utility model or ornamental design registration.</p>		<p>Document title 623A_PP_CC_04_06_2023 1L6_EI_generating_public_network_V316_V317_3X-4X_DC</p>	
<p>Document Type DRAW/ELSY</p>		<p>Release Status RELEASED</p>	
<p>CEVT Document No 8888522365</p>		<p>Edited April/12/2023</p>	
<p>Issue 035</p>		<p>Page No 58/146</p>	



VOLVO CAR CORPORATION

EVI harnesses are hardwired to EVI

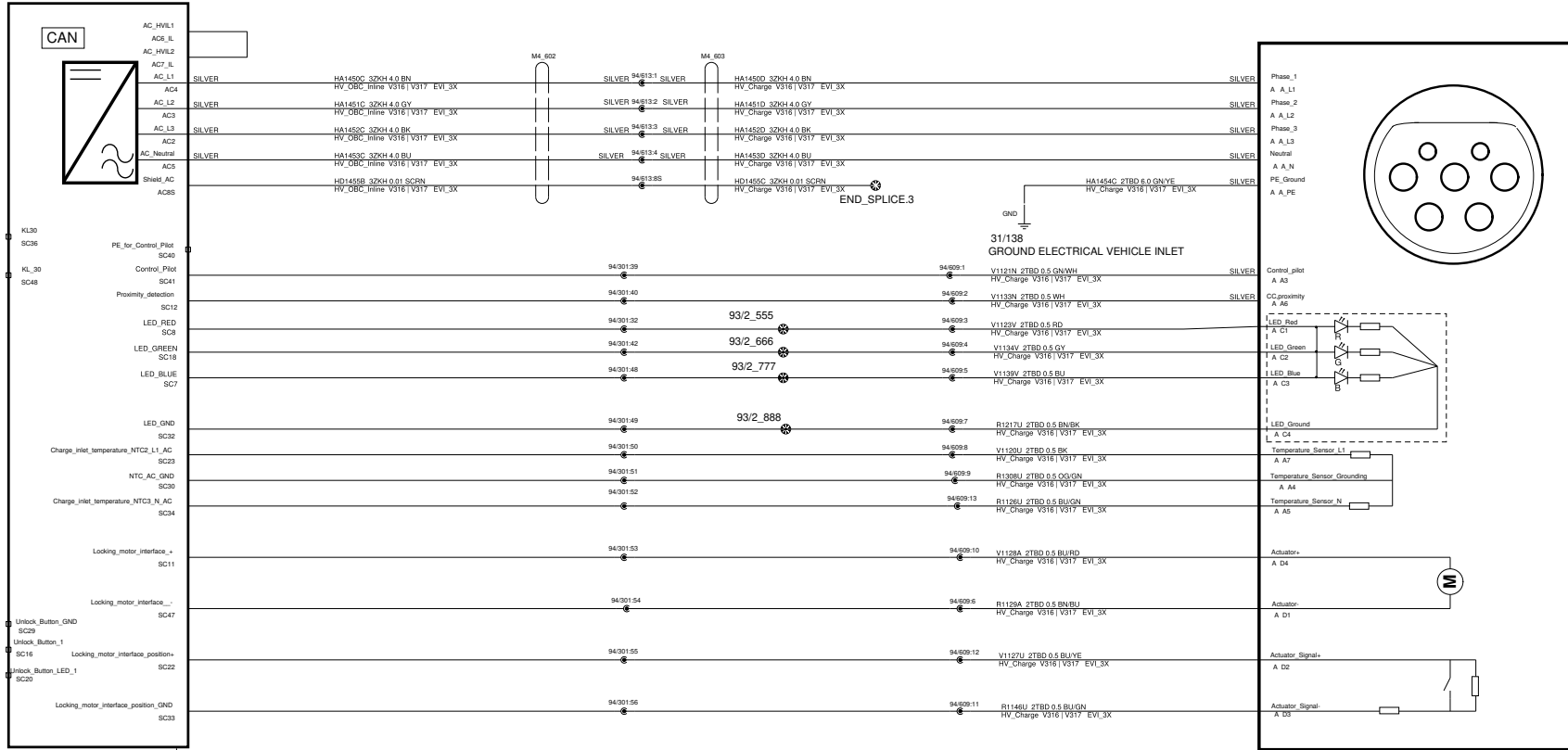

4/238  
ON BOARD CHARGER OBC

17/49.3  
ELECTRICAL VEHICLE INLET AC

<p>The copying, distribution and utilization of this document as well as the communication of its contents to others without expressed authorization is prohibited. Offenders will be held liable for payment of damages. All rights reserved in the event of the grant of a patent, utility model or ornamental design registration.</p> <p><b>VOLVO</b> VOLVO CAR CORPORATION</p>	<p><b>Document title</b> 623A_PP_CC_04_06_2023 1L7_EI_generating_public_network_V316_V317_3X_AC</p>	
	<p><b>Document Type</b> DRAW/ELSY</p>	<p><b>Release Status</b> RELEASED</p>
	<p>CEVT Document No 8888522365</p>	<p><b>Edited</b> April/13/2023</p>
	<p><b>Issue</b> 035</p>	<p><b>Page No</b> 59/146</p>

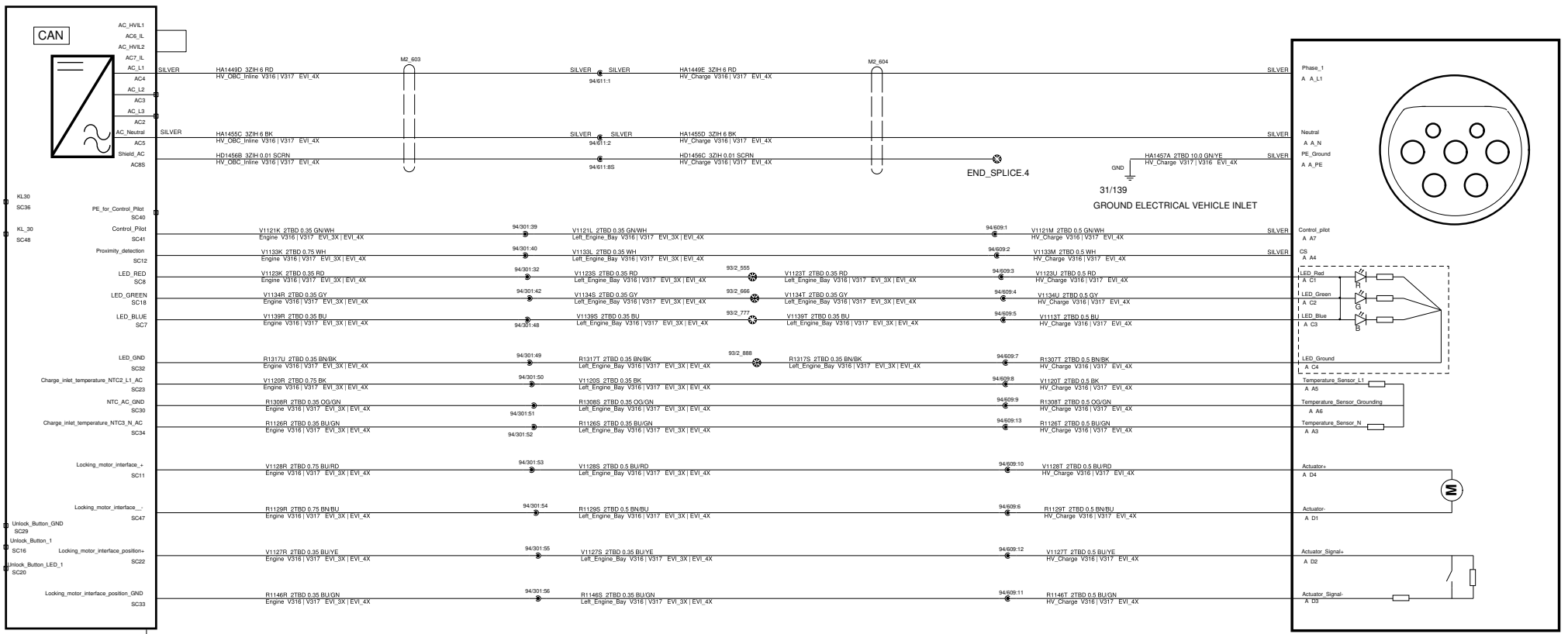

4/238  
ON BOARD CHARGER OBC

17/49 ELECTRICAL VEHICLE INLET AC

<p>The copying, distribution and utilization of this document as well as the communication of its contents to others without expressed authorization is prohibited. Offenders will be held liable for payment of damages. All rights reserved in the event of the grant of a patent, utility model or ornamental design registration.</p> <p><b>VOLVO</b> VOLVO CAR CORPORATION</p>	<p><b>Document title</b> 623A_PP_CC_04_06_2023 1L8_El_generating_public_network_V316_V317_4X_AC</p>	
	<p><b>Document Type</b> DRAW/ELSY</p>	<p><b>Release Status</b> RELEASED</p>
	<p>CEVT Document No 8888522365</p>	<p><b>Edited</b> April/13/2023</p>
	<p><b>Issue</b> 035</p>	<p><b>Page No</b> 60/146</p>

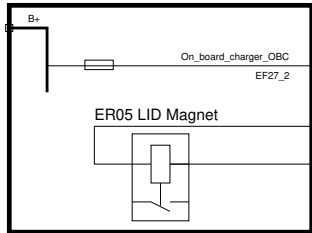

15/49.1 ENGINE JUNCTION BOX

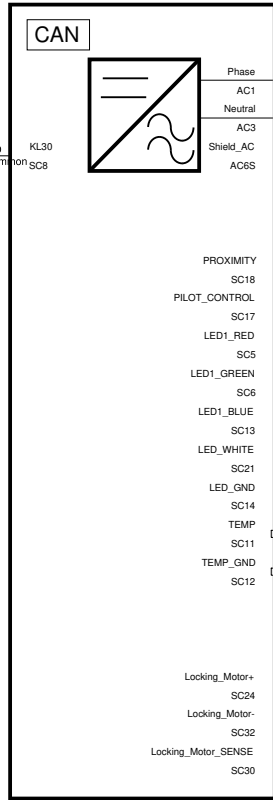

4/238.1 ON BOARD CHARGER OBC

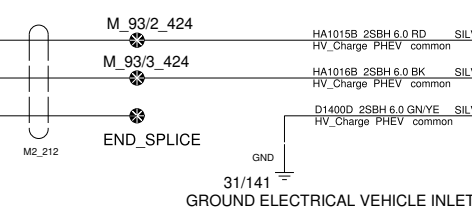

31/141 GROUND ELECTRICAL VEHICLE INLET

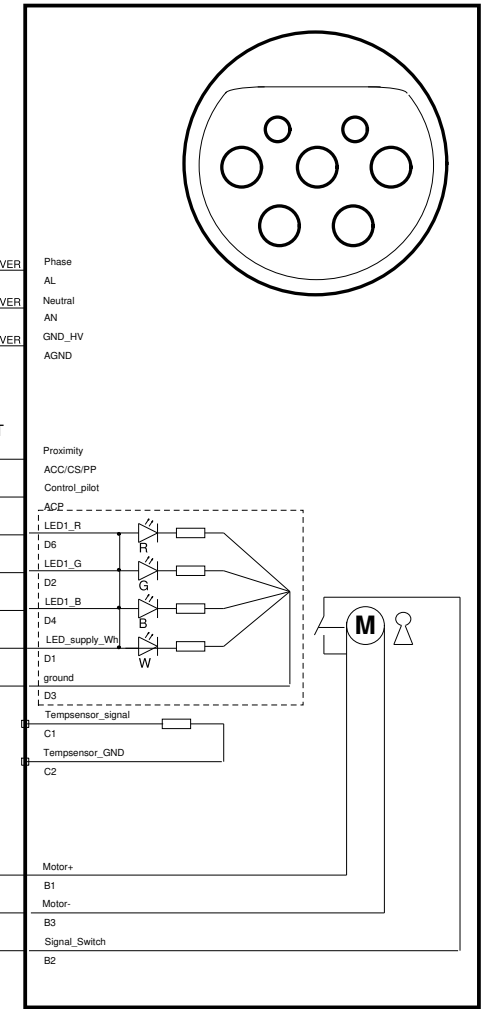

17/49.5 ELECTRICAL VEHICLE INLET

<p>The copying, distribution and utilization of this document as well as the communication of its contents to others without expressed authorization is prohibited. Offenders will be held liable for payment of damages. All rights reserved in the event of the grant of a patent, utility model or ornamental design registration.</p> <p><b>VOLVO</b> VOLVO CAR CORPORATION</p>	<p><b>Document title</b> 623A_PP_CC_04_06_2023 1L9_EI_generating_public_network_V316_PHEV</p>	
	<p><b>Document Type</b> DRAW/ELSY</p>	<p><b>Release Status</b> RELEASED</p>
	<p>CEVT Document No 8888522365</p>	<p><b>Edited</b> April/13/2023</p>
	<p><b>Issue</b> 035</p>	<p><b>Page No</b> 61/146</p>

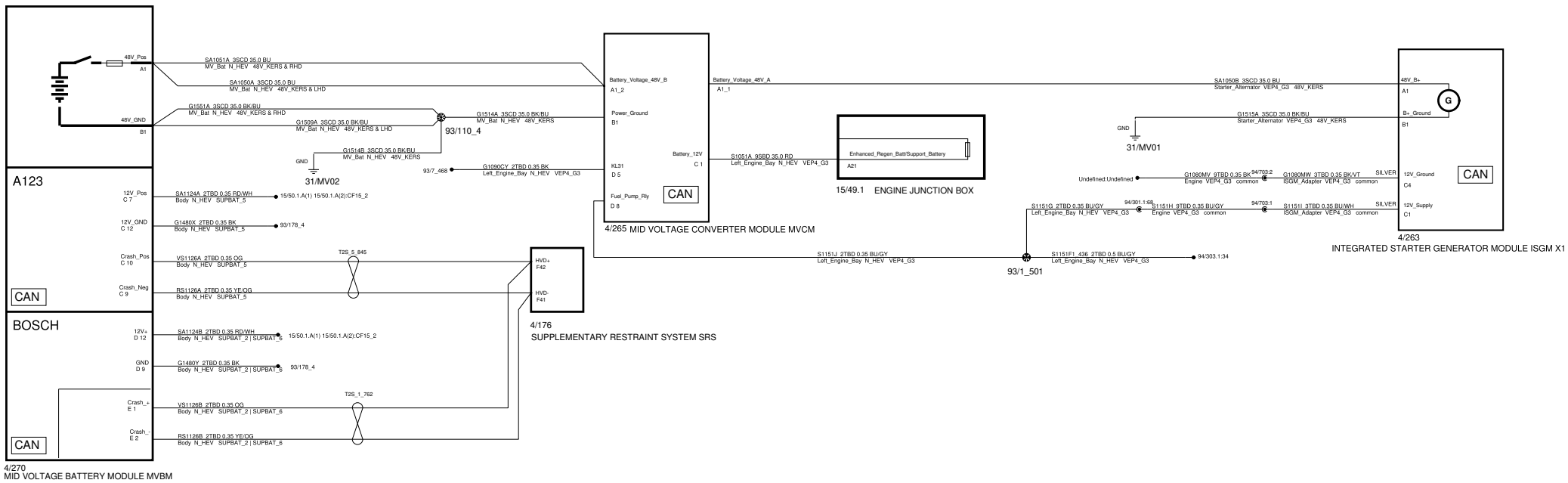

<p>The copying, distribution and utilization of this document as well as the communication of its contents to others without expressed authorization is prohibited. Offenders will be held liable for payment of damages. All rights reserved in the event of the grant of a patent, utility model or ornamental design registration.</p> <p><b>VOLVO</b> VOLVO CAR CORPORATION</p>	<b>Document title</b> 623A_PP_CC_04_06_2023 1M_EI_Distribution_Mid_Voltage	
	<b>Document Type</b> DRAW/ELSY	<b>Release Status</b> RELEASED
	CEVT Document No 8888522365	<b>Edited</b> April/13/2023
	<b>Issue</b> 035	<b>Page No</b> 62/146

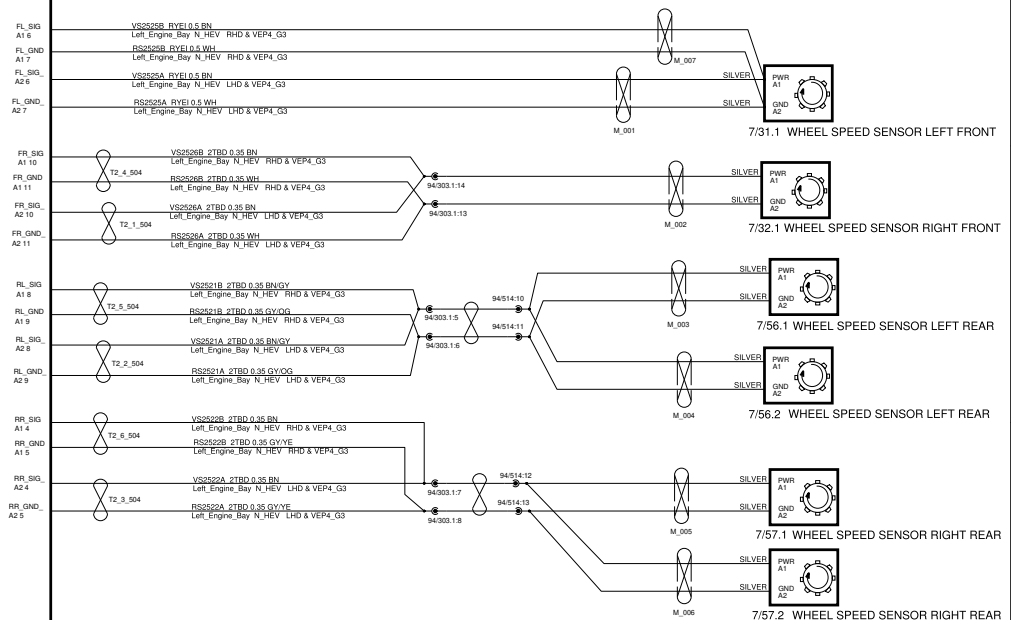
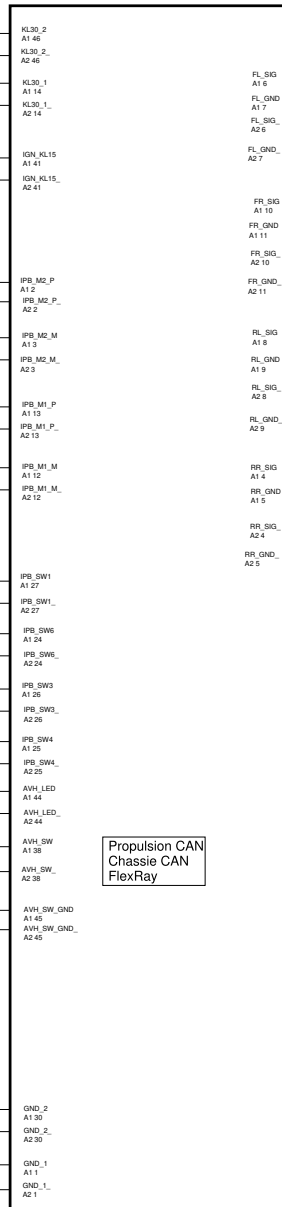
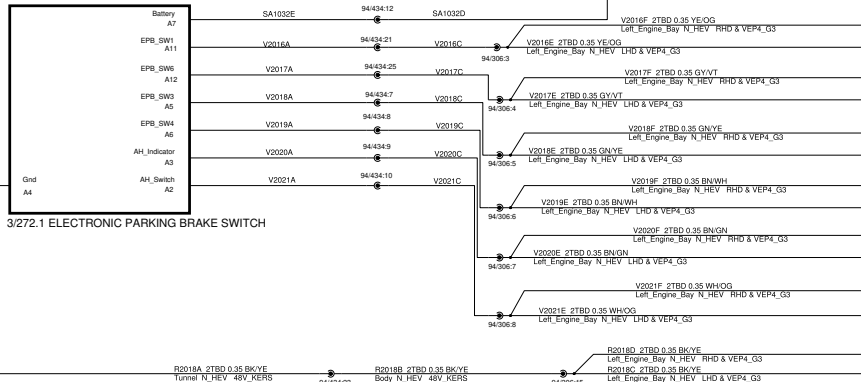
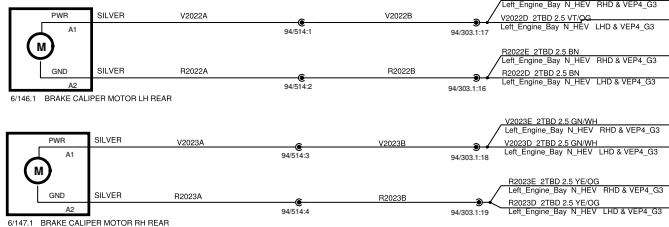
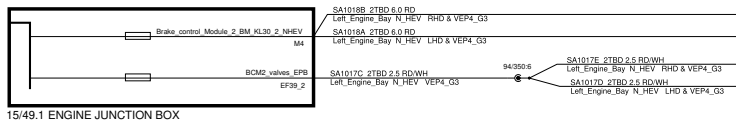

Propulsion CAN  
Chassis CAN  
FlexRay

<p>The copying, distribution and utilization of this document as well as the communication of its contents to others without expressed authorization is prohibited. Offenders will be held liable for payment of damages. All rights reserved in the event of the grant of a patent, utility model or ornamental design registration.</p>		<p>Document title 623A_PP_CC_04_06_2023</p>	
		<p>2A_Braking_48V_KERS</p>	
<p>Document Type DRAW/ELSY</p>		<p>Release Status RELEASED</p>	
<p>CEVT Document No 8888522365</p>		<p>Edited April/13/2023</p>	
<p>Issue 035</p>		<p>Page No 64/146</p>	

**VOLVO**  
VOLVO CAR CORPORATION



A

B

C

D

E

F

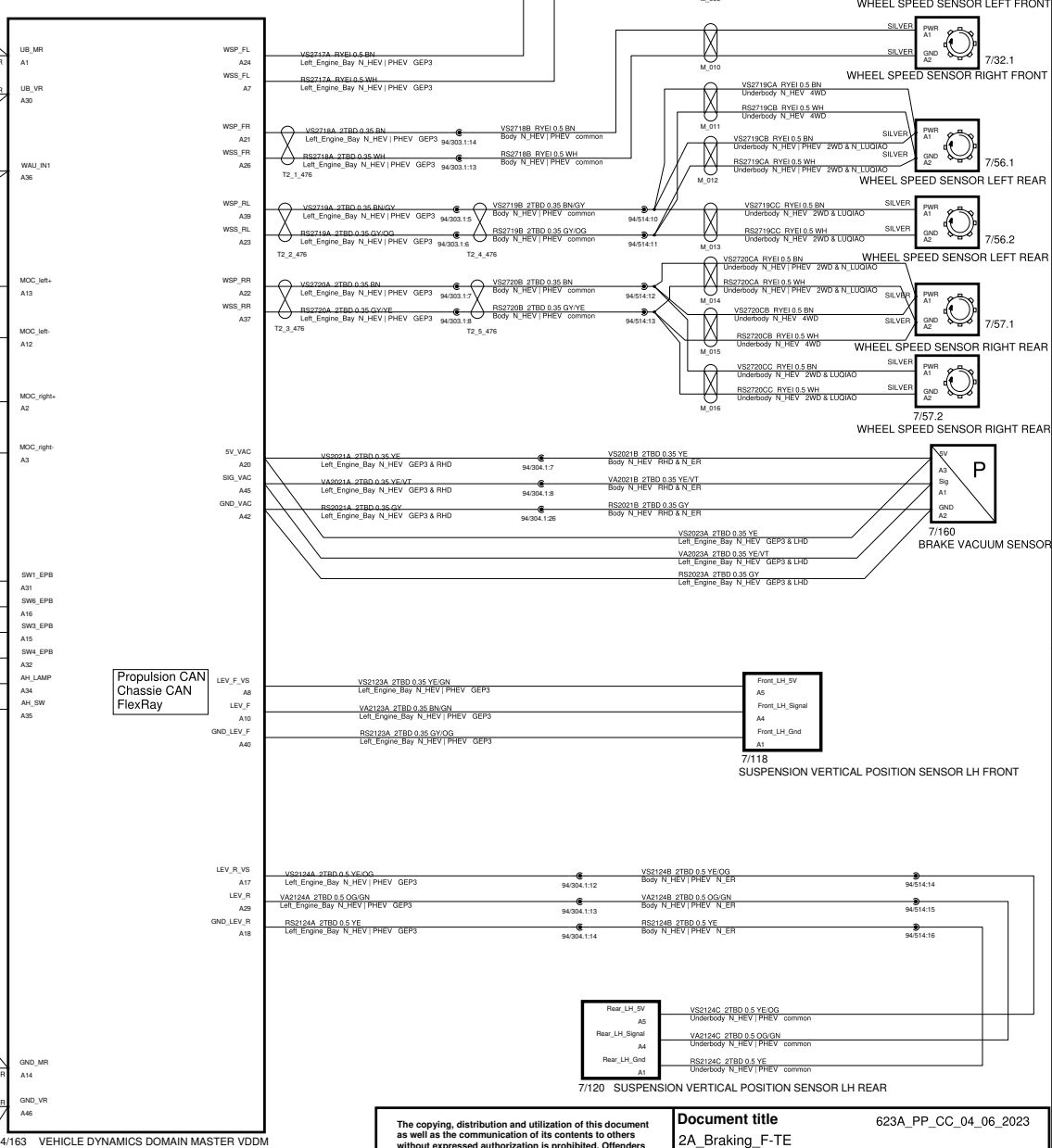
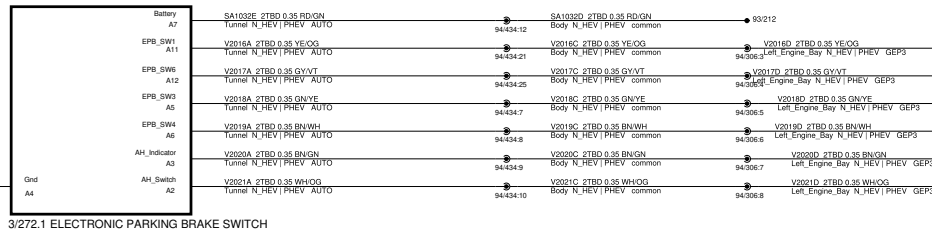
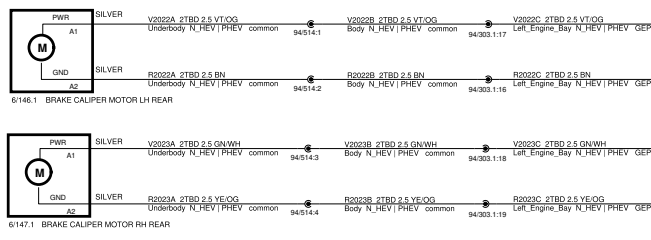
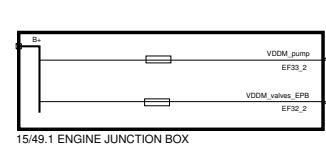

G1105G\_2TRBD.0.35 BK Tunnel N\_HEV|PHEV AUTO SW LER

<p>The copying, distribution and utilization of this document as well as the communication of its contents to others without expressed authorization is prohibited. Offenders will be held liable for payment of damages. All rights reserved in the event of the grant of a patent, utility model or ornamental design registration.</p> <p style="text-align: center;"><b>VOLVO</b> VOLVO CAR CORPORATION</p>		<p>Document title <b>2A_Braking_F-TE</b></p>		<p>623A_PP_CC_04_06_2023</p>	
		<p>Document Type <b>DRAW/ELSY</b></p>	<p>Release Status <b>RELEASED</b></p>		<p>Edited <b>April/13/2023</b></p>
		<p>CEVT Document No <b>8888522365</b></p>	<p>Issue <b>035</b></p>		<p>Page No <b>65/146</b></p>

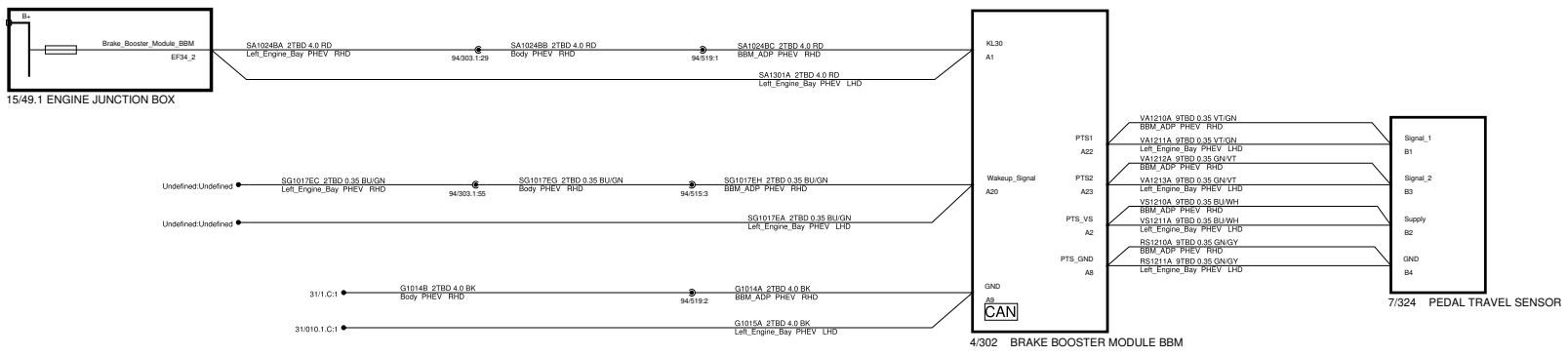

<p>The copying, distribution and utilization of this document as well as the communication of its contents to others without expressed authorization is prohibited. Offenders will be held liable for payment of damages. All rights reserved in the event of the grant of a patent, utility model or ornamental design registration.</p> <p><b>VOLVO</b> VOLVO CAR CORPORATION</p>	<b>Document title</b> 623A_PP_CC_04_06_2023 2A_Braking_Hybrid	
	<b>Document Type</b> DRAW/ELSY	<b>Release Status</b> RELEASED
	CEVT Document No 8888522365	<b>Edited</b> March/29/2023
	<b>Issue</b> 035	<b>Page No</b> 66/146

# 2A Braking

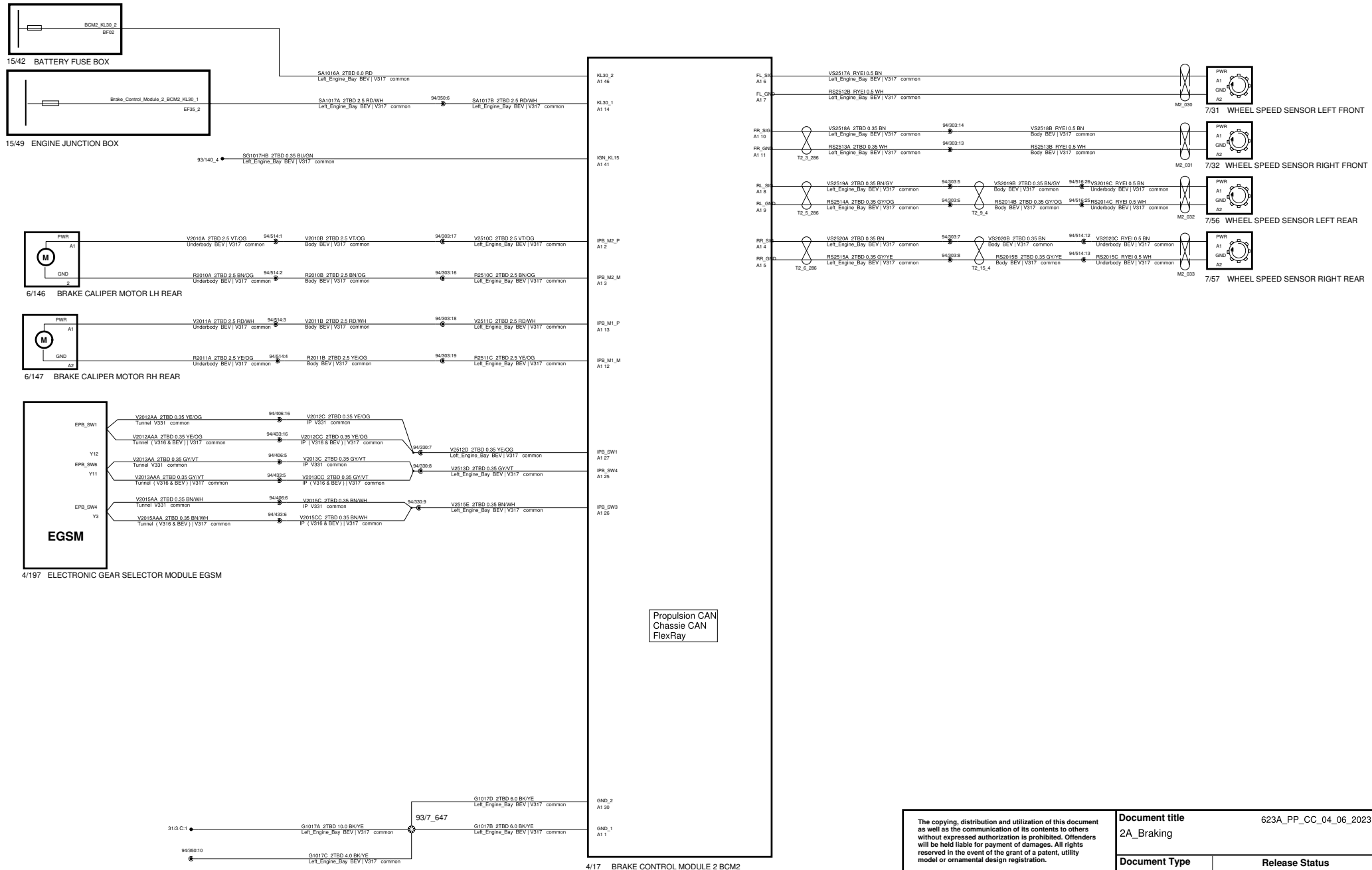

<p>The copying, distribution and utilization of this document as well as the communication of its contents to others without expressed authorization is prohibited. Offenders will be held liable for payment of damages. All rights reserved in the event of the grant of a patent, utility model or ornamental design registration.</p>		<b>Document title</b> 623A_PP_CC_04_06_2023 2A_Braking	
		<b>Document Type</b> DRAW/ELSY	<b>Release Status</b> RELEASED
<p><b>VOLVO</b> VOLVO CAR CORPORATION</p>		Volvo Document No 33445458	<b>Edited</b> April/13/2023
		<b>Issue</b> 035	<b>Page No</b> 63/146

4/17 BRAKE CONTROL MODULE 2 BCM2

# 2E Power Steering

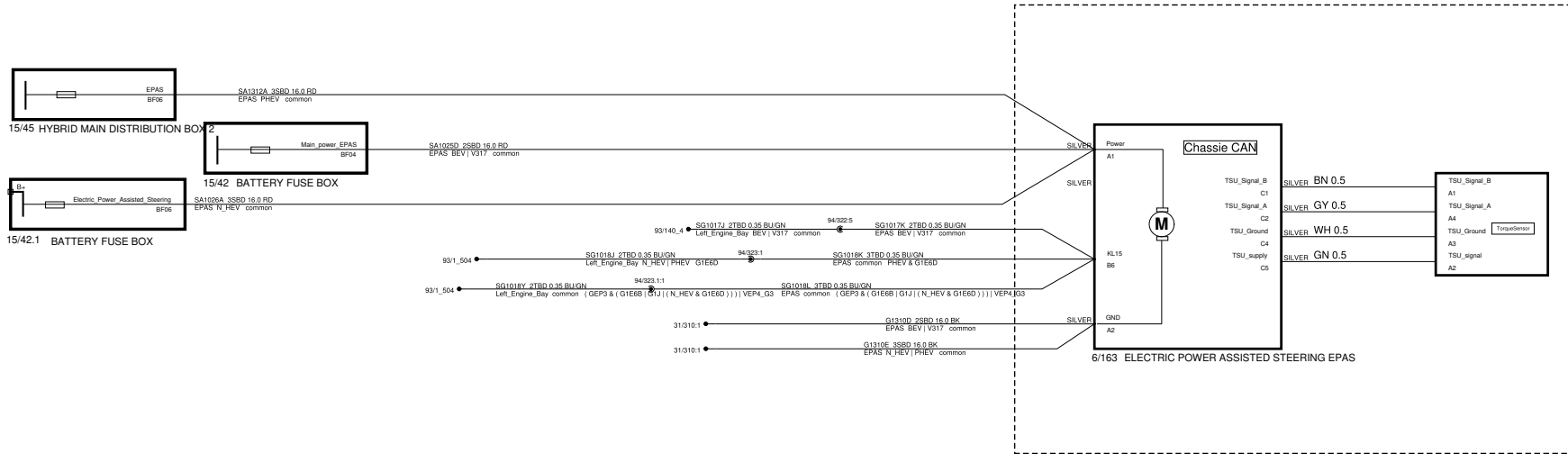

<p>The copying, distribution and utilization of this document as well as the communication of its contents to others without expressed authorization is prohibited. Offenders will be held liable for payment of damages. All rights reserved in the event of the grant of a patent, utility model or ornamental design registration.</p> <p><b>VOLVO</b> VOLVO CAR CORPORATION</p>	<p><b>Document title</b> 623A_PP_CC_04_06_2023 2E_Power_Steering</p>	
	<p><b>Document Type</b> DRAW/ELSY</p>	<p><b>Release Status</b> RELEASED</p>
	<p>Volvo Document No 33445458</p>	<p><b>Edited</b> April/13/2023</p>
	<p><b>Issue</b> 035</p>	<p><b>Page No</b> 68/146</p>

# 2E2 Steering

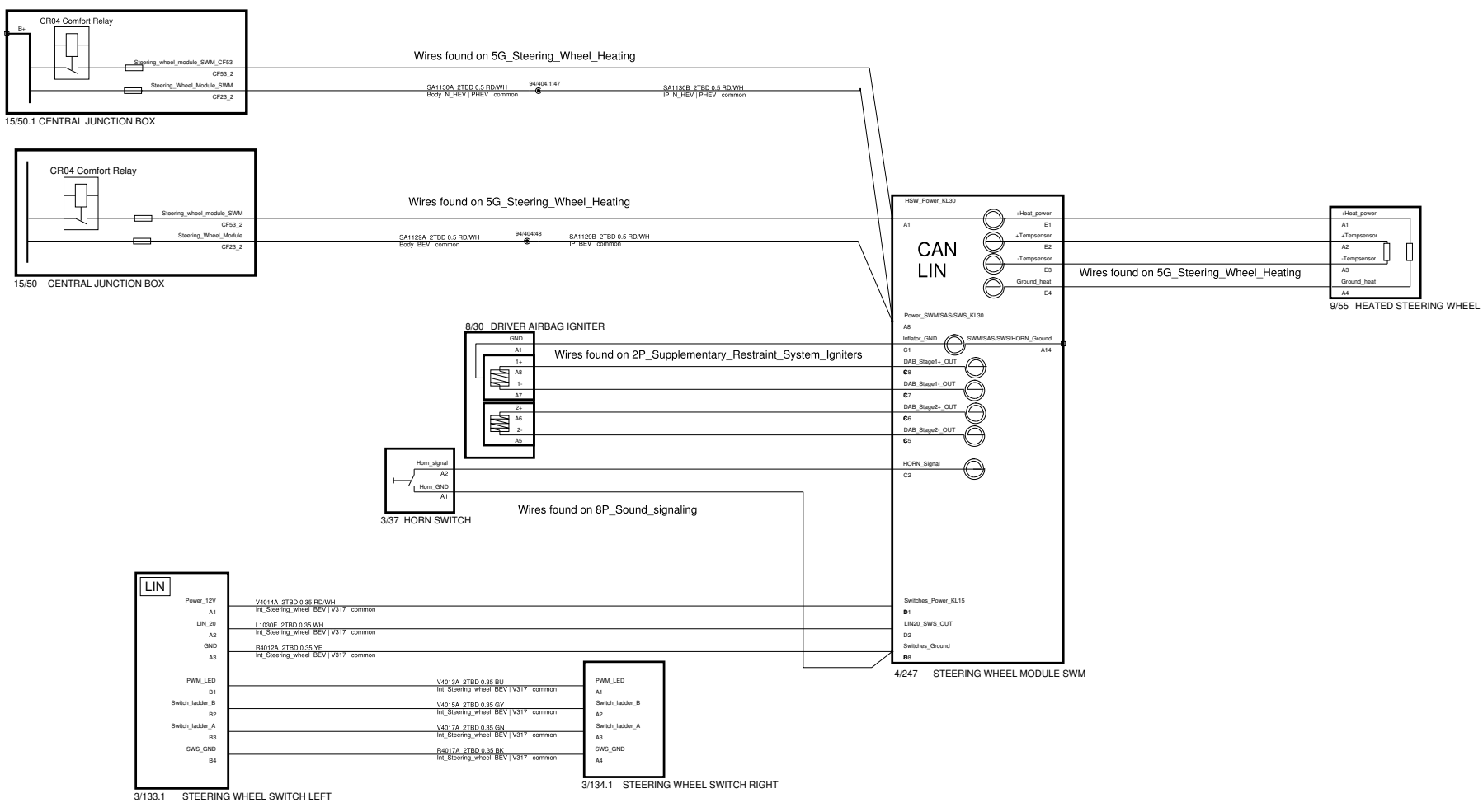

<p>The copying, distribution and utilization of this document as well as the communication of its contents to others without expressed authorization is prohibited. Offenders will be held liable for payment of damages. All rights reserved in the event of the grant of a patent, utility model or ornamental design registration.</p> <p><b>VOLVO</b> VOLVO CAR CORPORATION</p>	<b>Document title</b> 2E2_Steering		623A_PP_CC_04_06_2023
	<b>Document Type</b> DRAW/ELSY	<b>Release Status</b> RELEASED	
	Volvo Document No 33445458		<b>Edited</b> June/16/2021
	<b>Issue</b> 035	<b>Page No</b> 67/146	

# 2G Levelling Control

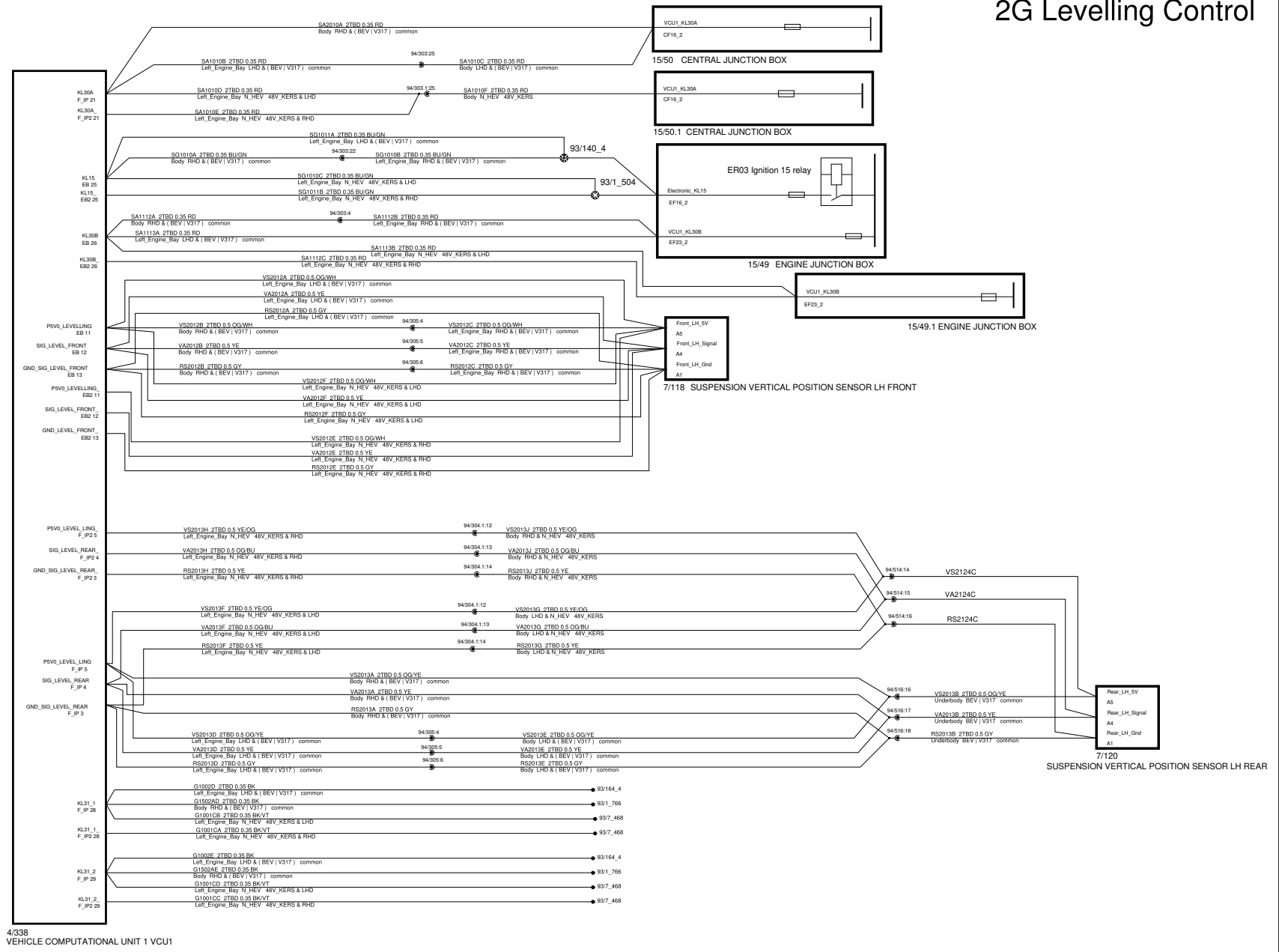

4/338  
VEHICLE COMPUTATIONAL UNIT 1 VCU1

<p>The copying, distribution and utilization of this document as well as the communication of its contents to others without expressed authorization is prohibited. Offenders will be held liable for payment of damages. All rights reserved in the event of the grant of a patent, utility model or ornamental design registration.</p> <p><b>VOLVO</b> VOLVO CAR CORPORATION</p>	<p>Document title 2G_Levelling_control</p>		<p>623A_PP_CC_04_06_2023</p>
	<p>Document Type DRAW/ELSY</p>	<p>Release Status RELEASED</p>	
	<p>Volvo Document No 33445458</p>		<p>Edited April/13/2023</p>
	<p>Issue 035</p>	<p>Page No 69/146</p>	

# 2M Pedestrian Protection

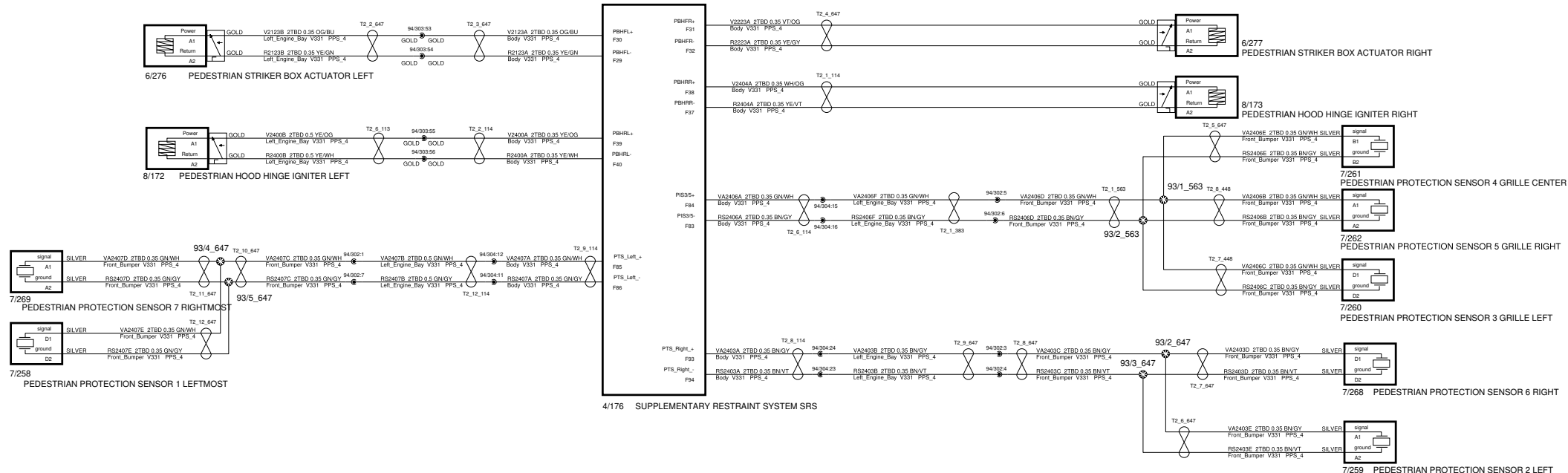

<p>The copying, distribution and utilization of this document as well as the communication of its contents to others without expressed authorization is prohibited. Offenders will be held liable for payment of damages. All rights reserved in the event of the grant of a patent, utility model or ornamental design registration.</p> <p><b>VOLVO</b> VOLVO CAR CORPORATION</p>	<b>Document title</b> 623A_PP_CC_04_06_2023	
	2M_Pedestrian_Protection	
	<b>Document Type</b> DRAW/ELSY	<b>Release Status</b> RELEASED
	Volvo Document No 33445458	<b>Edited</b> March/21/2023
<b>Issue</b> 035	<b>Page No</b> 70/146	





# 20 Collision Avoidance

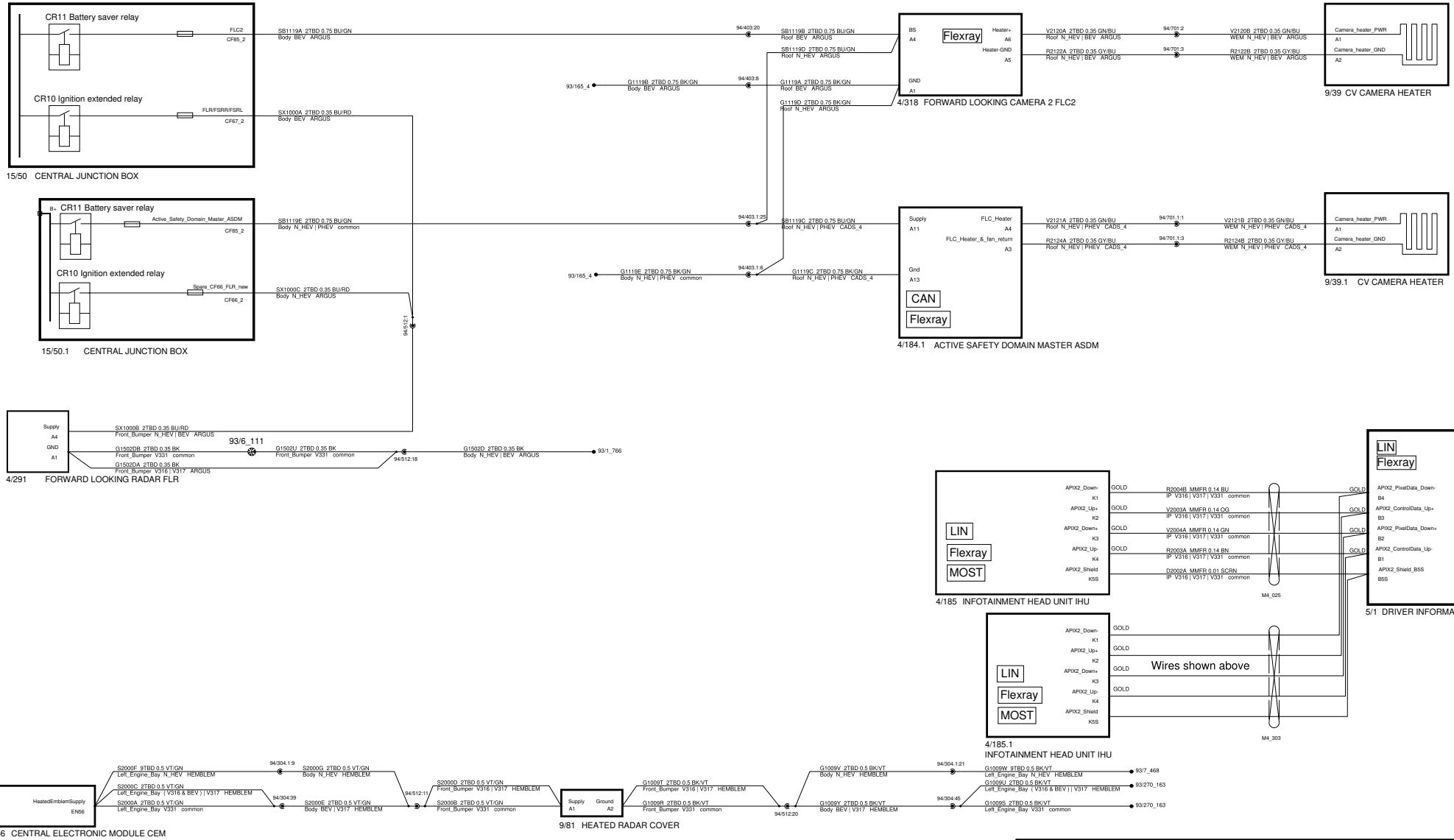

<p>The copying, distribution and utilization of this document as well as the communication of its contents to others without expressed authorization is prohibited. Offenders will be held liable for payment of damages. All rights reserved in the event of the grant of a patent, utility model or ornamental design registration.</p> <p><b>VOLVO</b> VOLVO CAR CORPORATION</p>	<p>Document title: 623A_PP_CC_04_06_2023 20_Collision_Avoidance</p>	
	<p>Document Type: DRAW/ELSY</p>	<p>Release Status: RELEASED</p>
	<p>Volvo Document No: 33445458</p>	<p>Edited: April/13/2023</p>
	<p>Issue: 035</p>	<p>Page No: 72/146</p>

# 2P Supplementary Restraint System Igniters HEV PHEV

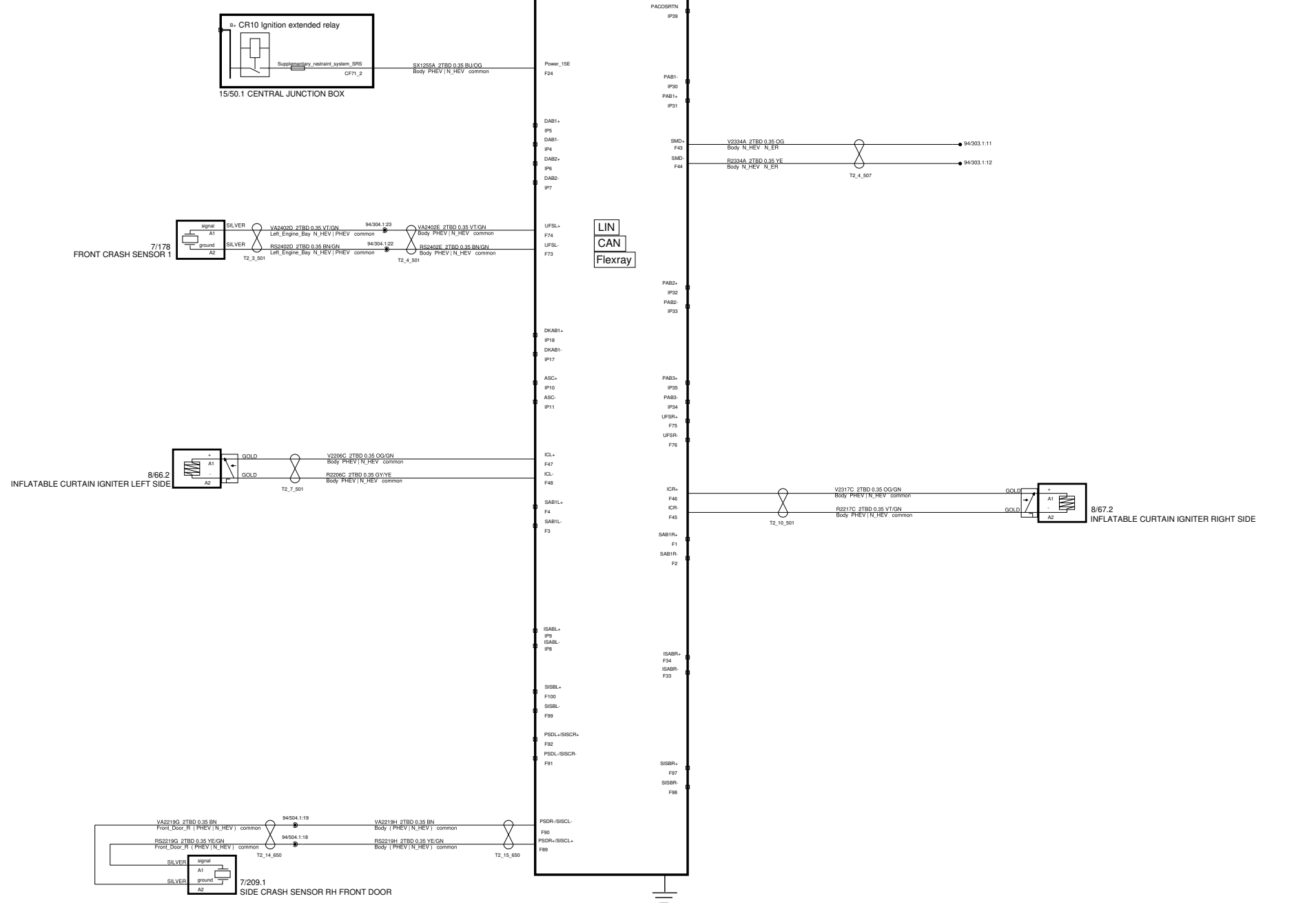

4/176 SUPPLEMENTARY RESTRAINT SYSTEM SRS

# 2P Supplementary Restraint System Igniters N\_HEV

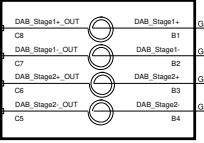
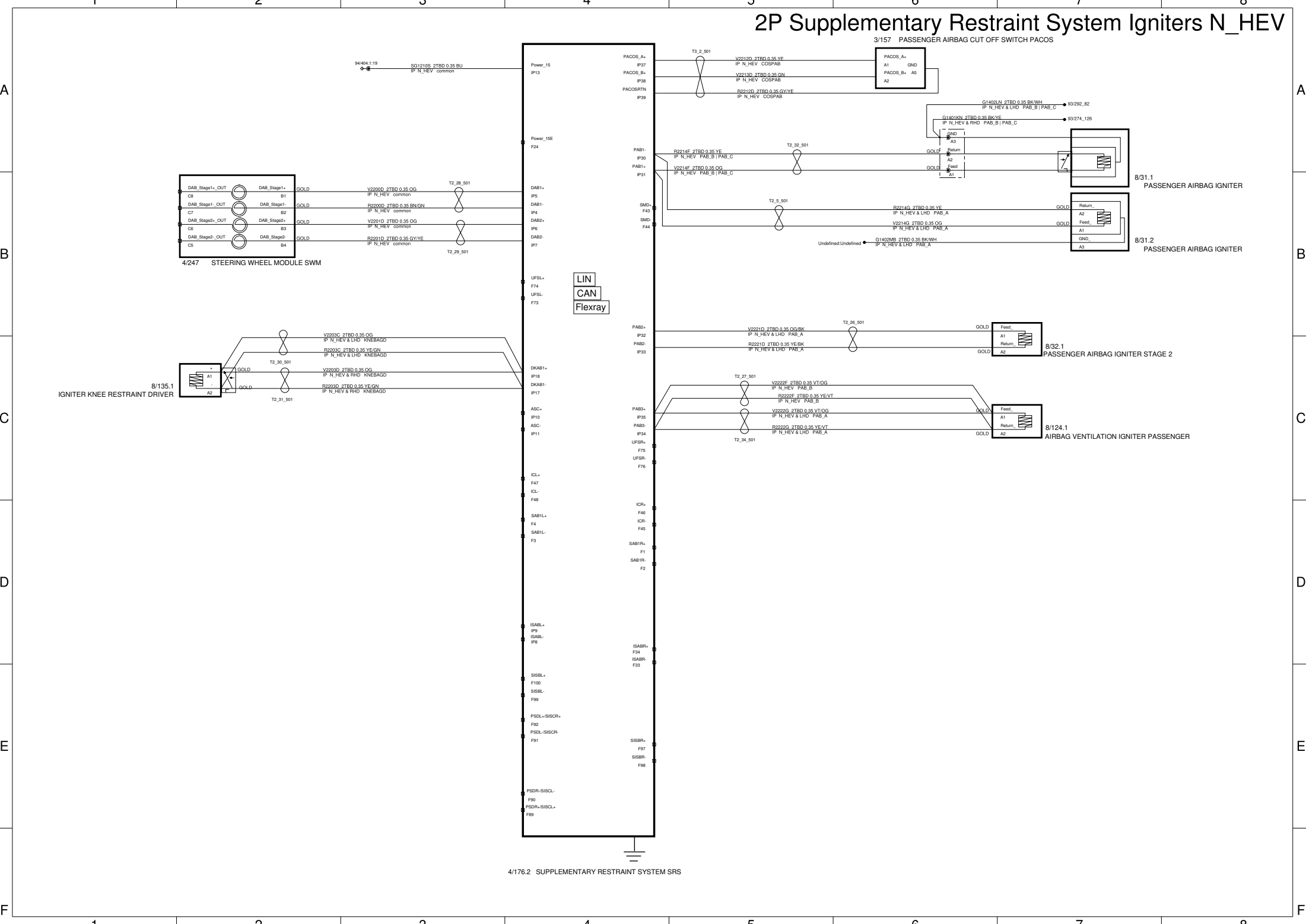

4/247 STEERING WHEEL MODULE SWM

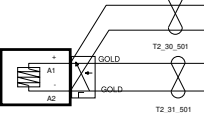

8/135.1 IGNITER KNEE RESTRAINT DRIVER

LIN  
CAN  
Flexray

4/176.2 SUPPLEMENTARY RESTRAINT SYSTEM SRS

3/157 PASSENGER AIRBAG CUT OFF SWITCH PACOS

8/31.1 PASSENGER AIRBAG IGNITER

8/31.2 PASSENGER AIRBAG IGNITER

8/32.1 PASSENGER AIRBAG IGNITER STAGE 2

8/124.1 AIRBAG VENTILATION IGNITER PASSENGER

# 2P Supplementary Restraint System Igniters PHEV

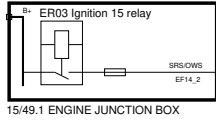

15/49.1 ENGINE JUNCTION BOX

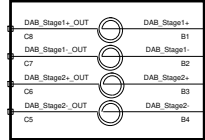

4/247 STEERING WHEEL MODULE SWM



8/135.1 IGNITER KNEE RESTRAINT DRIVER

4/176.1 SUPPLEMENTARY RESTRAINT SYSTEM SRS

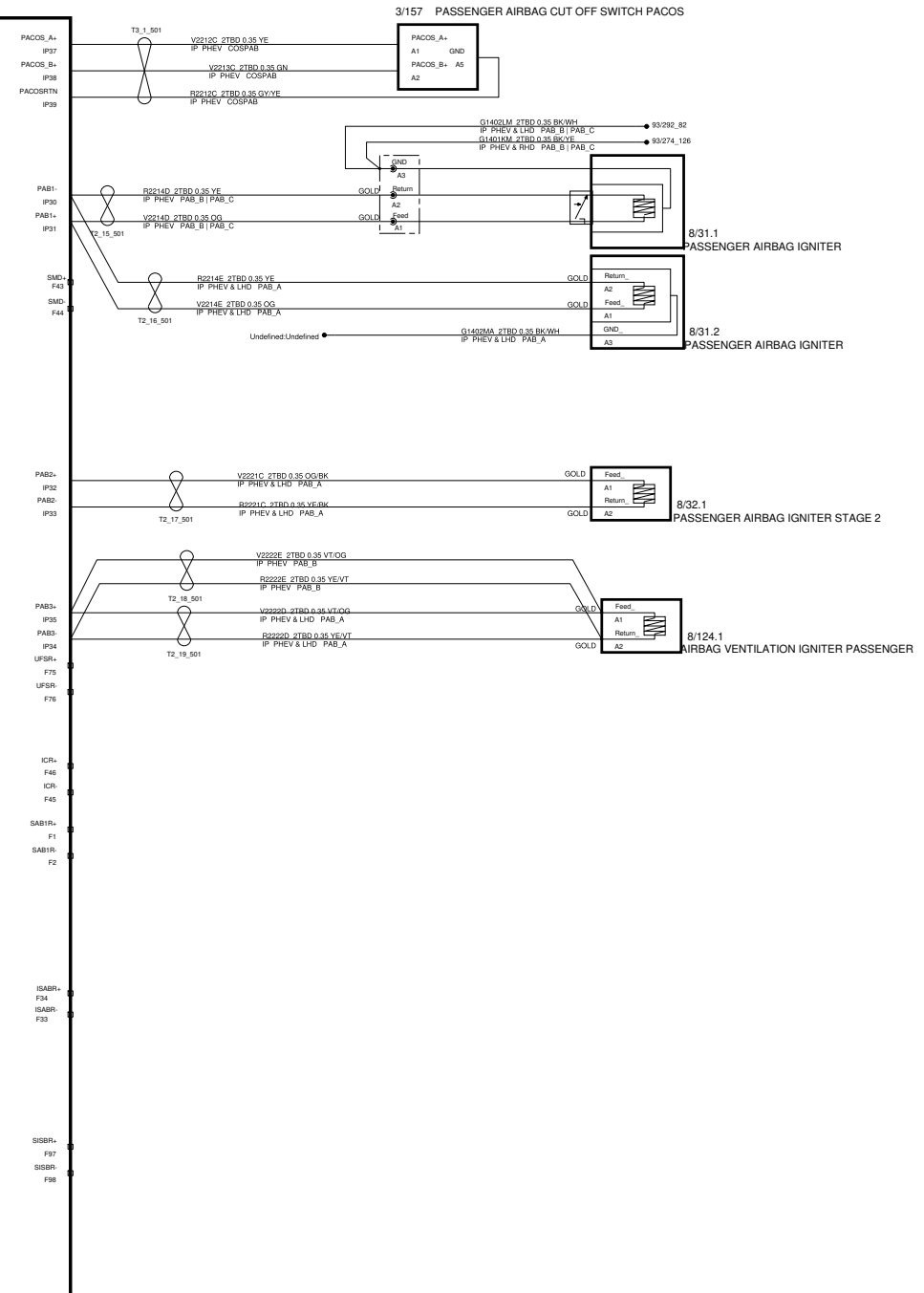
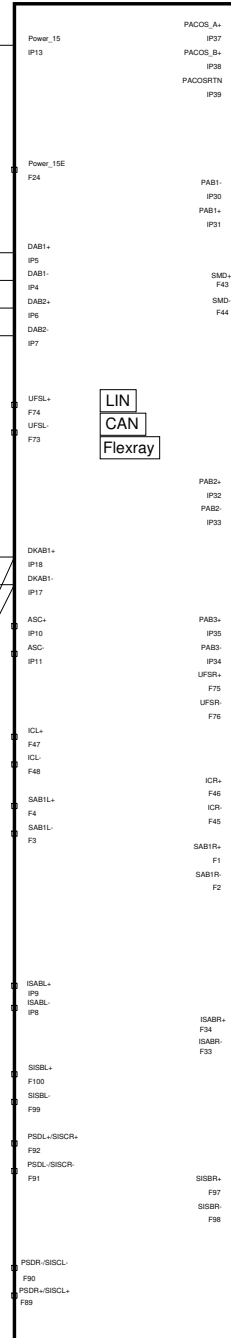

# 2P Supplementary Restraint System Igniters

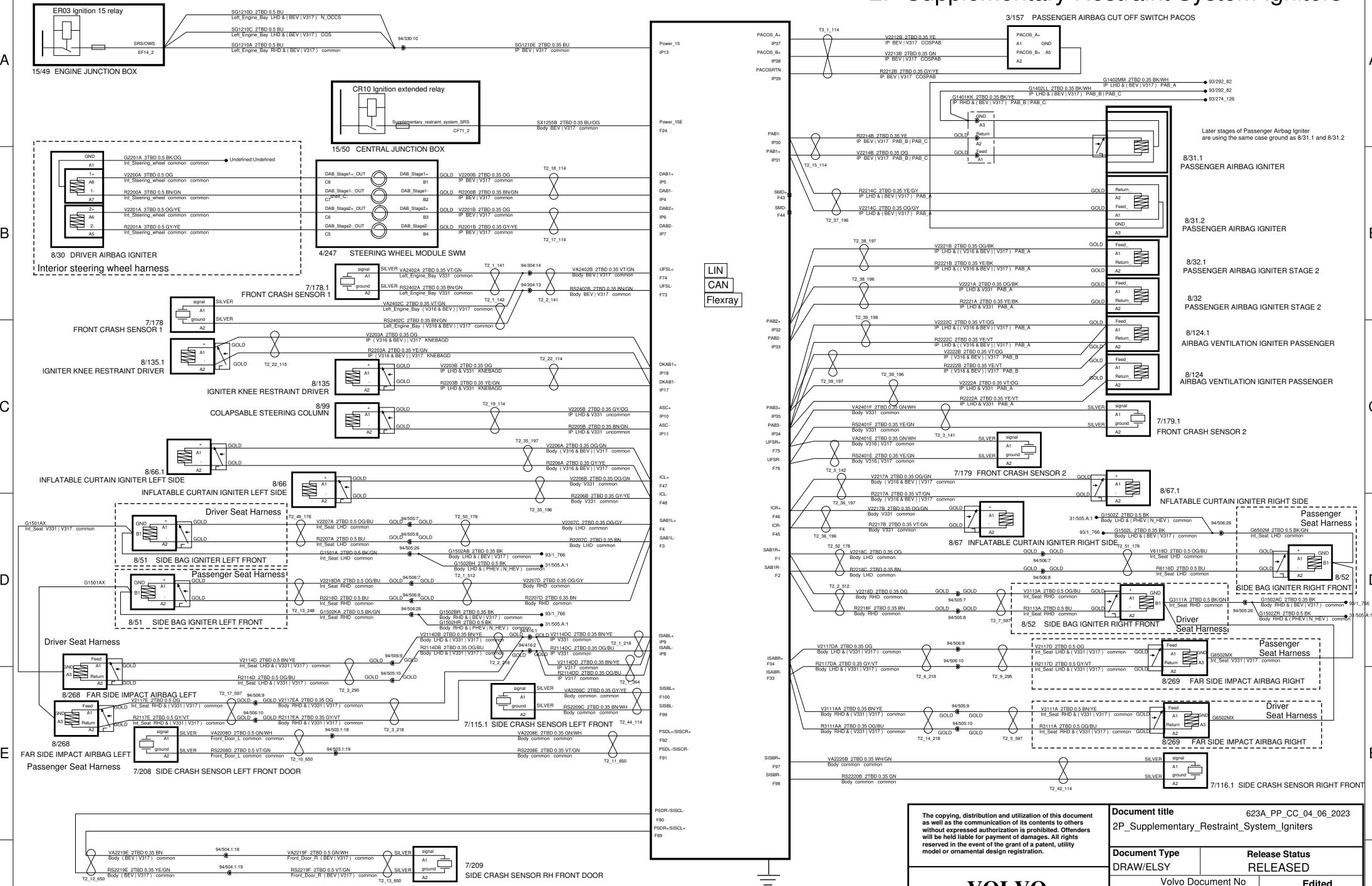

<p>The copying, distribution and utilization of this document as well as the communication of its contents to others without expressed authorization is prohibited. Offenders will be held liable for payment of damages. All rights reserved in the event of the grant of a patent, utility model or ornamental design registration.</p>		<p>Document title 2P_Supplementary_Restraint_System_Igniters</p>	<p>623A_PP_OC_04_06_2023</p>
<p>Document Type DRAW/ELSY</p>	<p>Release Status RELEASED</p>	<p>Volvo Document No 33445458</p>	<p>Edited April/13/2023</p>
<p>Issue 035</p>	<p>Page No 73/146</p>		



# 2S Restraint

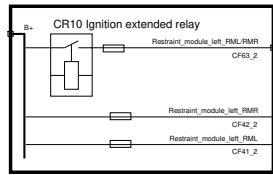

15/50.1 CENTRAL JUNCTION BOX

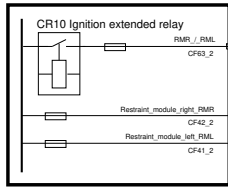

15/50 CENTRAL JUNCTION BOX

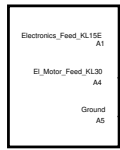

4/211 RESTRAINT MODULE LEFT RML

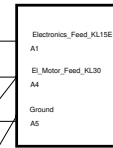

4/212 RESTRAINT MODULE RIGHT RMR

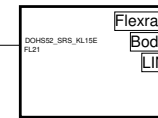

4/56 CENTRAL ELECTRONIC MODULE CEM

<p>The copying, distribution and utilization of this document as well as the communication of its contents to others without expressed authorization is prohibited. Offenders will be held liable for payment of damages. All rights reserved in the event of the grant of a patent, utility model or ornamental design registration.</p> <p><b>VOLVO</b> VOLVO CAR CORPORATION</p>	<p><b>Document title</b> 623A_PP_CC_04_06_2023 2S_Restraint</p>	
	<p><b>Document Type</b> DRAW/ELSY</p>	<p><b>Release Status</b> RELEASED</p>
	<p>Volvo Document No 33445458</p>	<p><b>Edited</b> March/21/2023</p>
	<p><b>Issue</b> 035</p>	<p><b>Page No</b> 78/146</p>

# 3A, 3C Engine Management

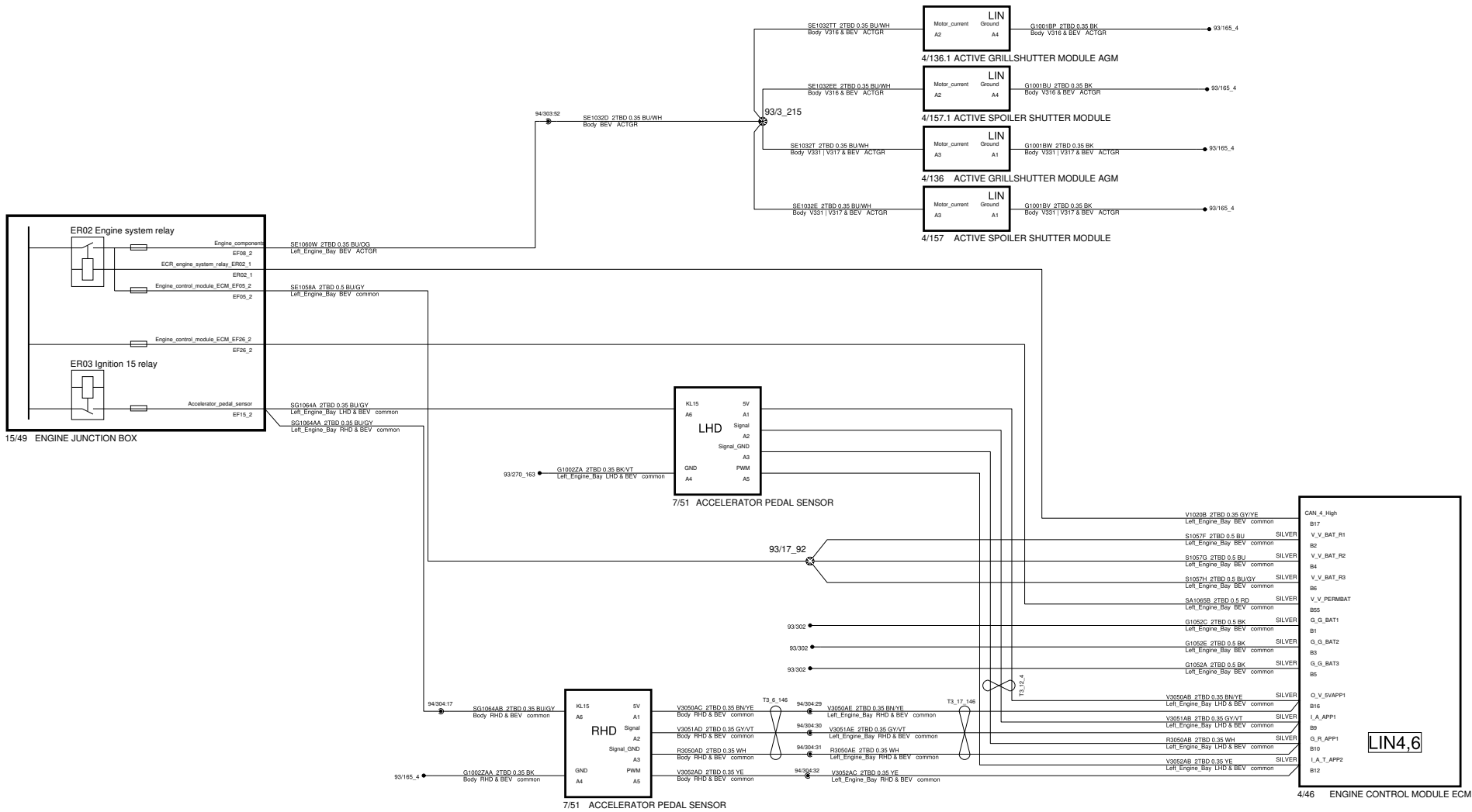

<p>The copying, distribution and utilization of this document as well as the communication of its contents to others without expressed authorization is prohibited. Offenders will be held liable for payment of damages. All rights reserved in the event of the grant of a patent, utility model or ornamental design registration.</p>		<p>Document title 623A_PP_CC_04_06_2023</p>	
		<p>3A_3C_Engine_management</p>	
<p>Document Type DRAW/ELSY</p>		<p>Release Status RELEASED</p>	
<p>Volvo Document No 33445458</p>		<p>Edited April/13/2023</p>	
<p>Issue 035</p>		<p>Page No 79/146</p>	

**VOLVO**  
VOLVO CAR CORPORATION



# 3A, 3D Engine Management (HEV)

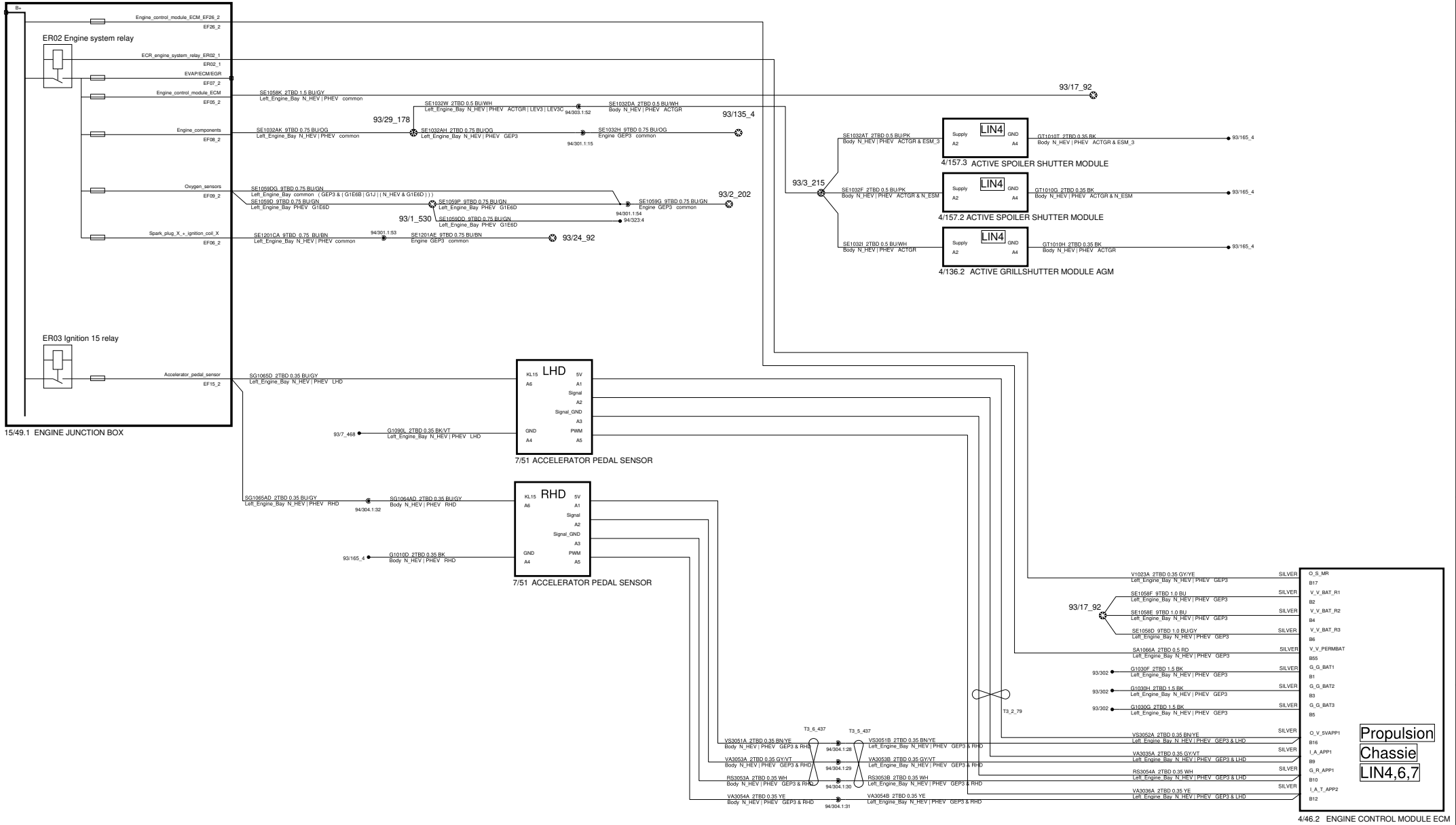

Wire ID	Wire Description	Material	Destination
V1020A	2TBD 0.35 GVYVE	SILVER	G.S. MR B17
SE1058F	9TBD 1.0 BU	SILVER	V_V_BAT_R1 B2
SE1058E	9TBD 1.0 BU	SILVER	V_V_BAT_R2 B4
SE1058D	9TBD 1.0 BLUGY	SILVER	V_V_BAT_R3 B6
SA1068A	2TBD 0.5 RD	SILVER	V_V_FERNBAT B55
G1030F	2TBD 1.5 BK	SILVER	G_G_BAT1 B1
G1030H	2TBD 1.5 BK	SILVER	G_G_BAT2 B3
G1030G	2TBD 1.5 BK	SILVER	G_G_BAT3 B5
V53052A	2TBD 0.35 BNLYE	SILVER	Q_V_SVAPP1 B16
V53051B	2TBD 0.35 BNLYE	SILVER	I.A_APP1 B9
VA3035A	2TBD 0.35 GVYVT	SILVER	G_R_APP1 B10
RS3054A	2TBD 0.35 WH	SILVER	I.A_APP2 B12
VA3036A	2TBD 0.35 YE	SILVER	

**Propulsion Chassis**  
LIN4,6,7

<p>The copying, distribution and utilization of this document as well as the communication of its contents to others without expressed authorization is prohibited. Offenders will be held liable for payment of damages. All rights reserved in the event of the grant of a patent, utility model or ornamental design registration.</p>		<p>Document title 623A_PP_CC_04_06_2023 3A_3D_Engine_Management_(HEV)</p>	
		<p>Document Type DRAW/ELSY</p>	<p>Release Status RELEASED</p>
<p><b>VOLVO</b> VOLVO CAR CORPORATION</p>		<p>CEVT Document No 8888522365</p>	<p>Edited April/13/2023</p>
		<p>Issue 035</p>	<p>Page No 80/146</p>

# 3A, 3D Engine Management VEP4 GEN3 (HEV)

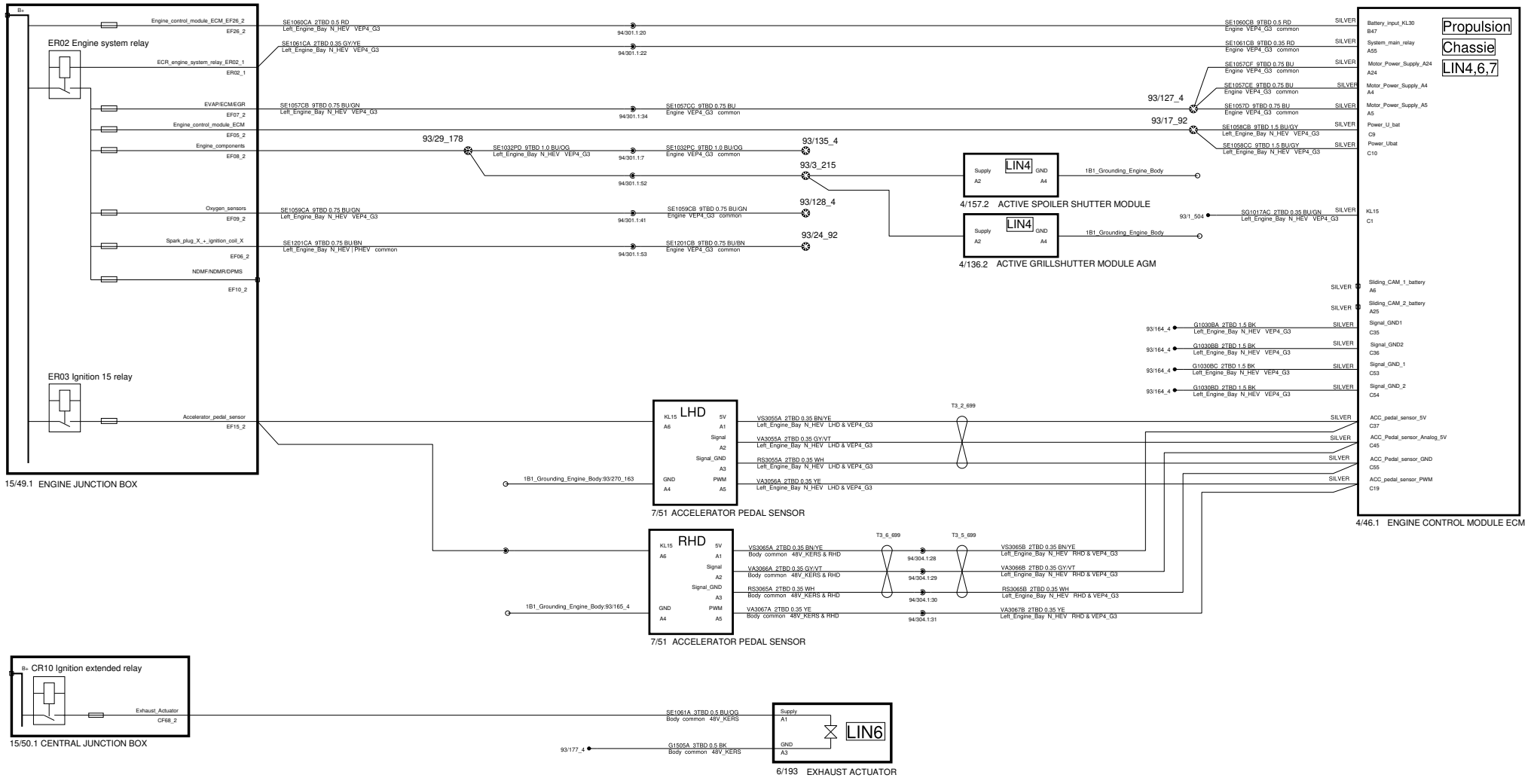

<b>VOLVO</b> VOLVO CAR CORPORATION	<b>Document title</b> 623A_PP_CC_04_06_2023 3A_3D_Engine_Management_VEP4_GEN3_(HEV)	
	<b>Document Type</b> DRAW/ELSY	<b>Release Status</b> RELEASED
	CEVT Document No 8888522365	Edited April/13/2023
	Issue 035	Page No 81/146

A

B

C

D

E

F

# 3A Engine Management GEP3 (HEV)

Propulsion  
Chassis  
LIN4,6,7

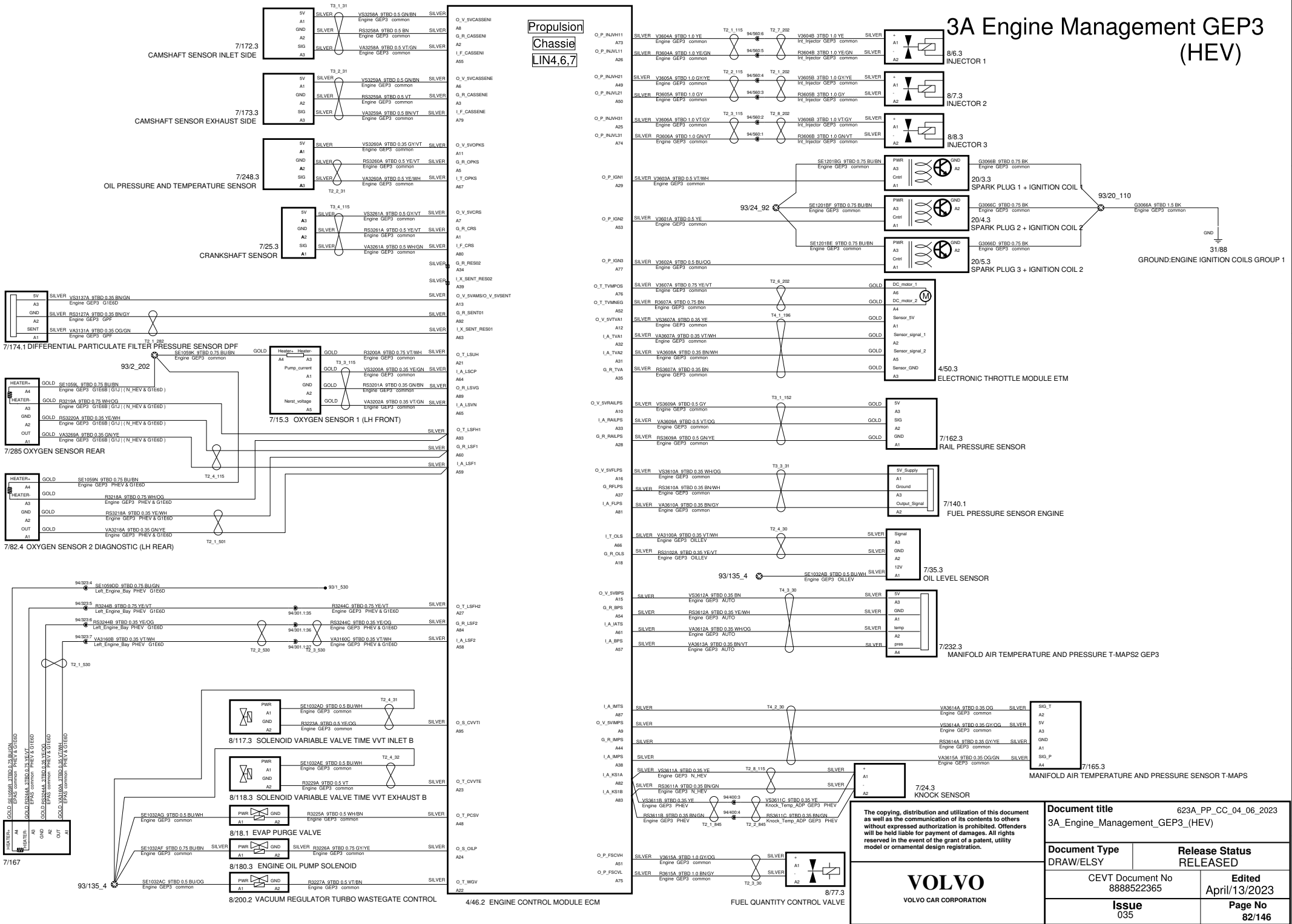

The copying, distribution and utilization of this document as well as the communication of its contents to others without expressed authorization is prohibited. Offenders will be held liable for payment of damages. All rights reserved in the event of the grant of a patent, utility model or ornamental design registration.

**VOLVO**  
VOLVO CAR CORPORATION

Document title 3A_Engine_Management_GEP3_(HEV)		623A_PP_CC_04_06_2023	
Document Type DRAW/ELSY	Release Status RELEASED		
Issue 035	CEVT Document No 8888522365	Edited April/13/2023	Page No 82/146

# 3A Engine Management VEP4\_G3 (HEV)

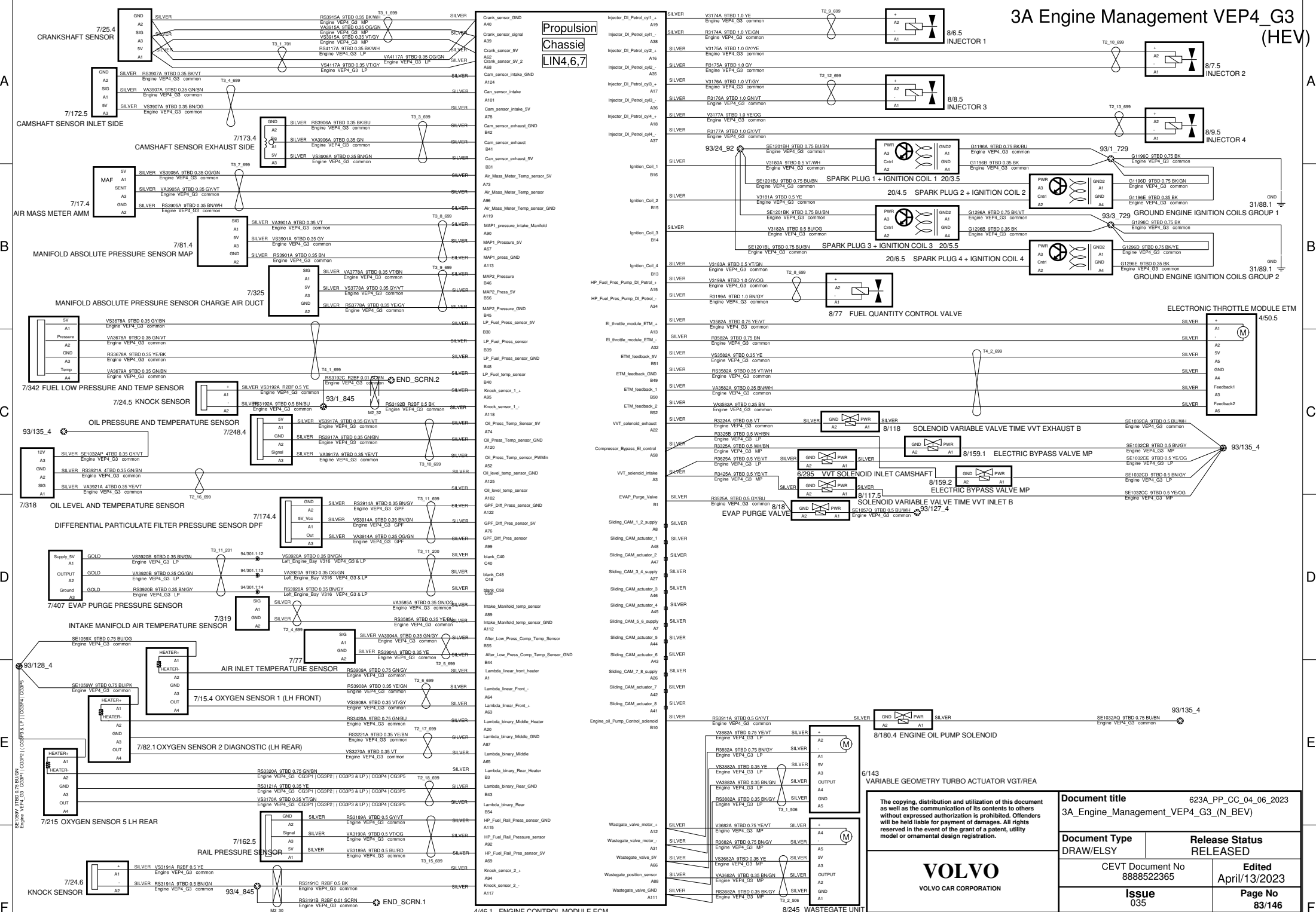

<p>The copying, distribution and utilization of this document as well as the communication of its contents to others without expressed authorization is prohibited. Offenders will be held liable for payment of damages. All rights reserved in the event of the grant of a patent, utility model or ornamental design registration.</p>		<p>Document title 623A_PP_CC_04_06_2023 3A_Engine_Management_VEP4_G3_(N_BEV)</p>
<p>Document Type DRAW/ELSY</p>	<p>Release Status RELEASED</p>	
<p>Issue 035</p>	<p>CEVT Document No 8888522365</p>	<p>Edited April/13/2023</p>
<p>Page No 83/146</p>	<p>Page No 83/146</p>	



VOLVO CAR CORPORATION

# 3B Management BEV Driveline

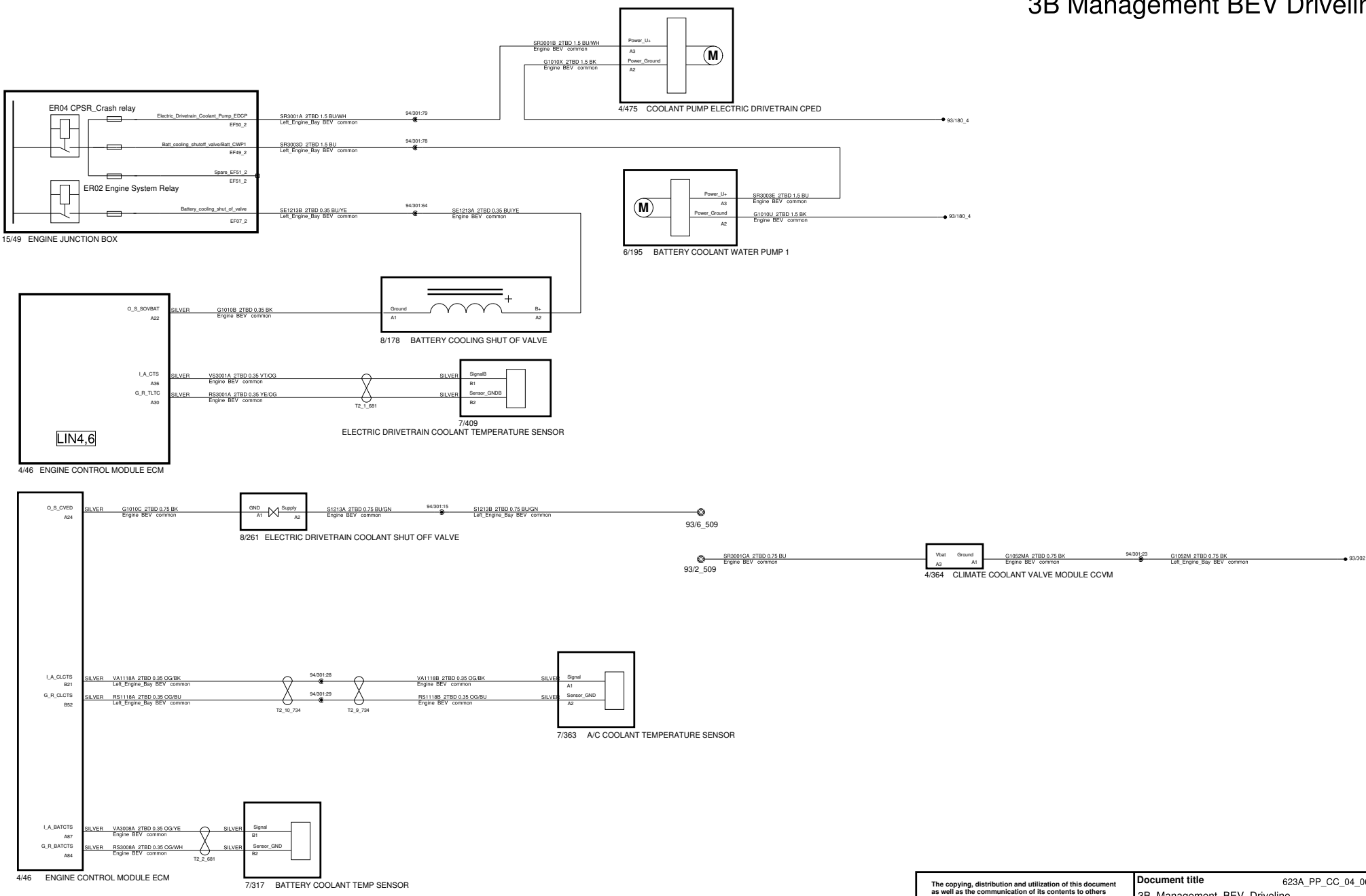

<p>The copying, distribution and utilization of this document as well as the communication of its contents to others without expressed authorization is prohibited. Offenders will be held liable for payment of damages. All rights reserved in the event of the grant of a patent, utility model or ornamental design registration.</p> <p><b>VOLVO</b> VOLVO CAR CORPORATION</p>	<p><b>Document title</b> 623A_PP_CC_04_06_2023 3B_Management_BEV_Driveline</p>	
	<p><b>Document Type</b> DRAW/ELSY</p>	<p><b>Release Status</b> RELEASED</p>
	<p>Volvo Document No 33445458</p>	<p><b>Edited</b> April/13/2023</p>
	<p><b>Issue</b> 035</p>	<p><b>Page No</b> 84/146</p>

# 3B Management Hybrid Driveline (PHEV)

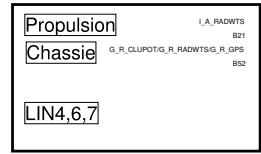

4/46.2 ENGINE CONTROL MODULE ECM

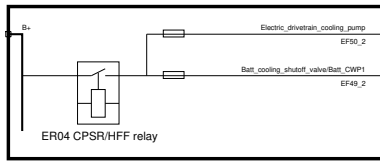

15/49.1 ENGINE JUNCTION BOX

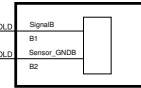

7/277 LT-COOLANT TEMP SENSOR

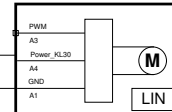

4/178 ELECTRIC DRIVETRAIN COOLANT PUMP EDCP

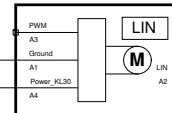

6/195.1 BATTERY COOLANT WATER PUMP 1

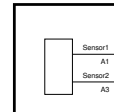

7/303 EXPANSION TANK LEVEL SENSOR HYBRID

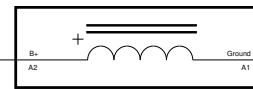

8/178 BATTERY COOLING SHUT OF VALVE

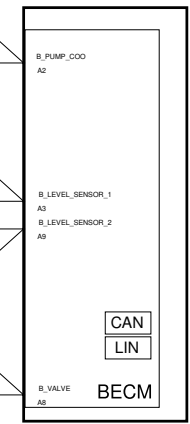

1/4.1 HIGH VOLTAGE BATTERY

<p>The copying, distribution and utilization of this document as well as the communication of its contents to others without expressed authorization is prohibited. Offenders will be held liable for payment of damages. All rights reserved in the event of the grant of a patent, utility model or ornamental design registration.</p> <p><b>VOLVO</b> VOLVO CAR CORPORATION</p>	<p><b>Document title</b> 623A_PP_CC_04_06_2023 3B_Management_Hybrid_Driveline_HEV</p>	
	<p><b>Document Type</b> DRAW/ELSY</p>	<p><b>Release Status</b> RELEASED</p>
	<p>CEVT Document No 8888522365</p>	<p><b>Edited</b> April/13/2023</p>
	<p><b>Issue</b> 035</p>	<p><b>Page No</b> 85/146</p>

# 3D Engine Thermal Management

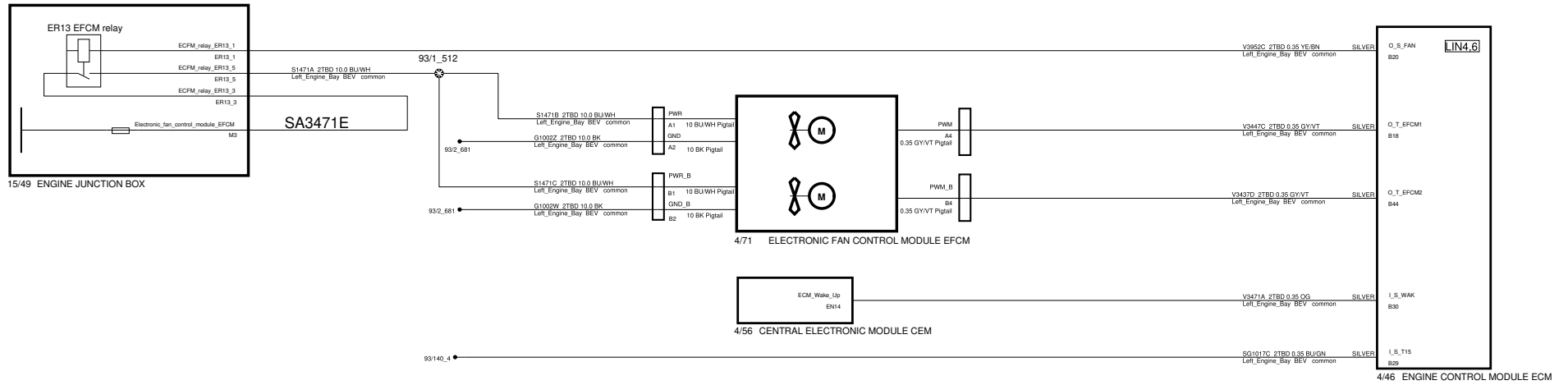

<p>The copying, distribution and utilization of this document as well as the communication of its contents to others without expressed authorization is prohibited. Offenders will be held liable for payment of damages. All rights reserved in the event of the grant of a patent, utility model or ornamental design registration.</p> <p><b>VOLVO</b> VOLVO CAR CORPORATION</p>	<b>Document title</b> 623A_PP_CC_04_06_2023 3D_Engine_thermal_management_BEV	
	<b>Document Type</b> DRAW/ELSY	<b>Release Status</b> RELEASED
	Volvo Document No 33445458	<b>Edited</b> April/13/2023
	<b>Issue</b> 035	<b>Page No</b> 86/146

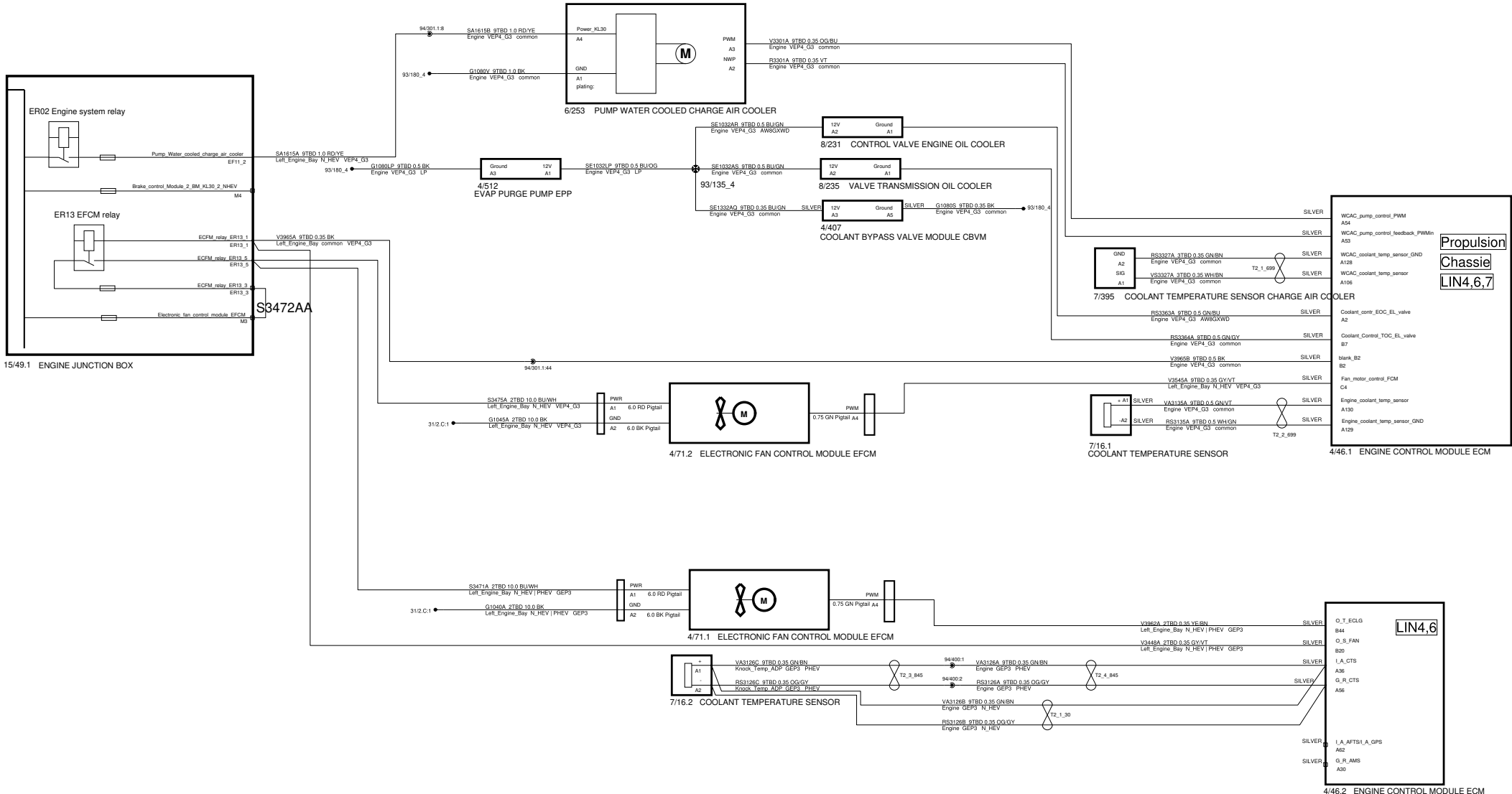

Propulsion  
Chassis  
LIN4,6,7

LIN4,6

The copying, distribution and utilization of this document as well as the communication of its contents to others without expressed authorization is prohibited. Offenders will be held liable for payment of damages. All rights reserved in the event of the grant of a patent, utility model or ornamental design registration.

**VOLVO**  
VOLVO CAR CORPORATION

Document title 623A\_PP\_CC\_04\_06\_2023  
3D\_Engine\_thermal\_management\_HEV

Document Type DRAW/ELSY Release Status RELEASED

CEVT Document No 8888522365 Edited April/13/2023

Issue 035 Page No 87/146



# 3E Automatic Gear Shifting 7DCT

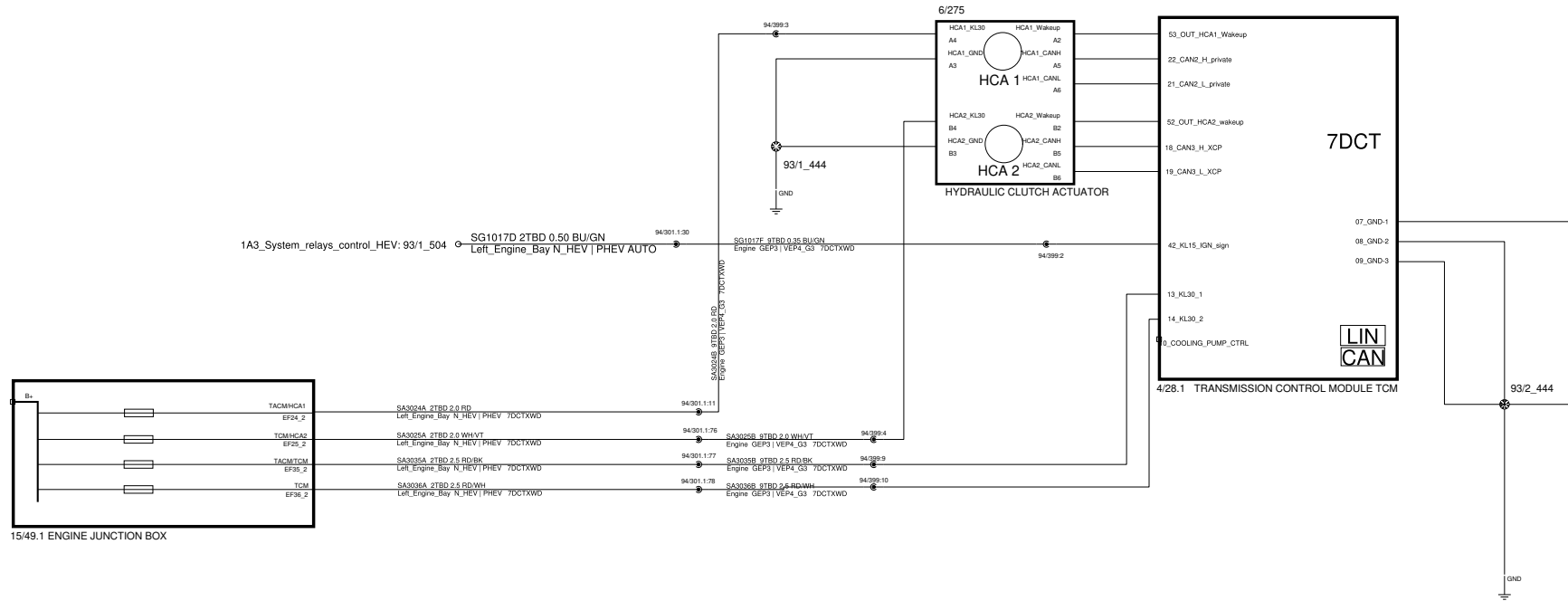

<p>The copying, distribution and utilization of this document as well as the communication of its contents to others without expressed authorization is prohibited. Offenders will be held liable for payment of damages. All rights reserved in the event of the grant of a patent, utility model or ornamental design registration.</p> <p><b>VOLVO</b> VOLVO CAR CORPORATION</p>	<p><b>Document title</b> 623A_PP_CC_04_06_2023 3E_Automatic_Gear_Shifting_7DCT</p>	
	<p><b>Document Type</b> DRAW/ELSY</p>	<p><b>Release Status</b> RELEASED</p>
	<p>CEVT Document No 8888522365</p>	<p><b>Edited</b> April/13/2023</p>
	<p><b>Issue</b> 035</p>	<p><b>Page No</b> 89/146</p>

# 3E Automatic Gear Shifting

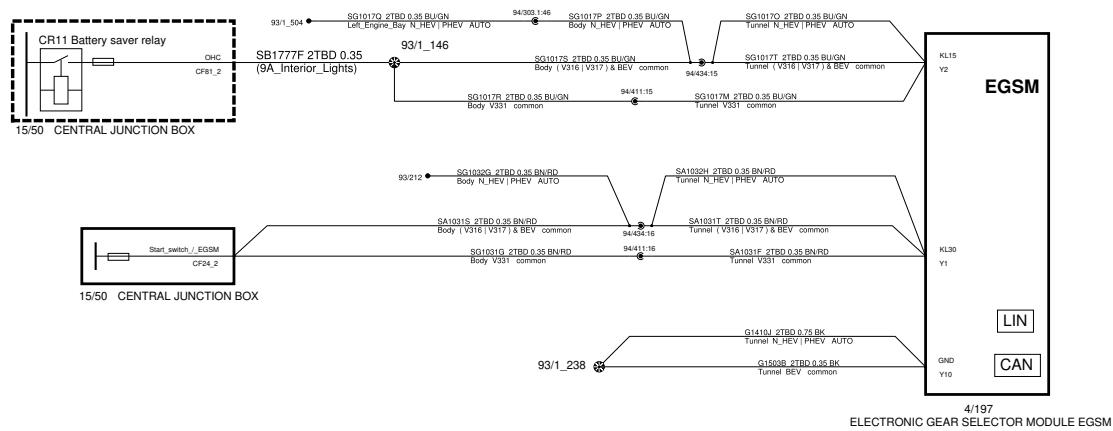
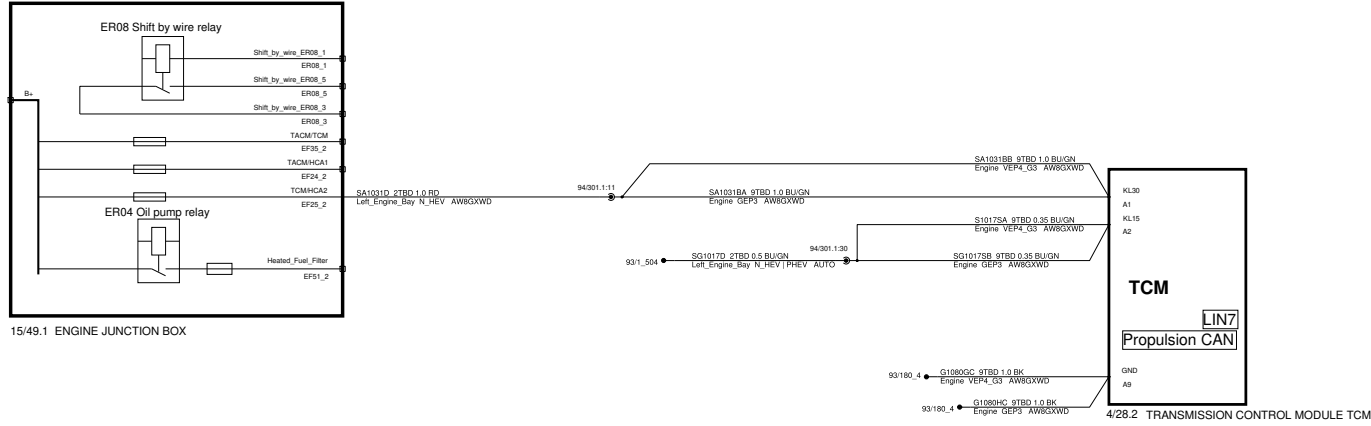

<p>The copying, distribution and utilization of this document as well as the communication of its contents to others without expressed authorization is prohibited. Offenders will be held liable for payment of damages. All rights reserved in the event of the grant of a patent, utility model or ornamental design registration.</p>		<p>Document title 623A_PP_CC_04_06_2023 3E_Automatic_Gear_Shifting</p>	
		<p>Document Type DRAW/ELSY</p>	<p>Release Status RELEASED</p>
<p><b>VOLVO</b> VOLVO CAR CORPORATION</p>		<p>Volvo Document No 33445458</p>	<p>Edited April/13/2023</p>
		<p>Issue 035</p>	<p>Page No 88/146</p>

# 3G 4WD Transmission

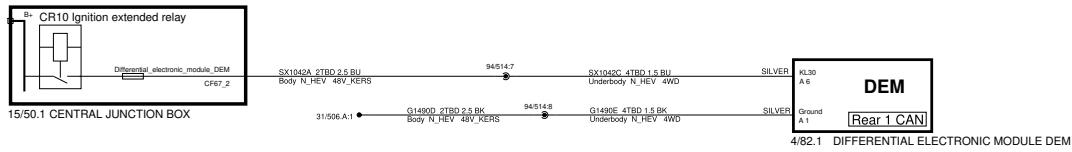

<p>The copying, distribution and utilization of this document as well as the communication of its contents to others without expressed authorization is prohibited. Offenders will be held liable for payment of damages. All rights reserved in the event of the grant of a patent, utility model or ornamental design registration.</p> <p><b>VOLVO</b> VOLVO CAR CORPORATION</p>	<b>Document title</b> 623A_PP_CC_04_06_2023 3G_4WD_Transmission	
	<b>Document Type</b> DRAW/ELSY	<b>Release Status</b> RELEASED
	CEVT Document No 8888522365	<b>Edited</b> April/13/2023
	<b>Issue</b> 035	<b>Page No</b> 90/146

# 3M Engine Cranking (HEV)

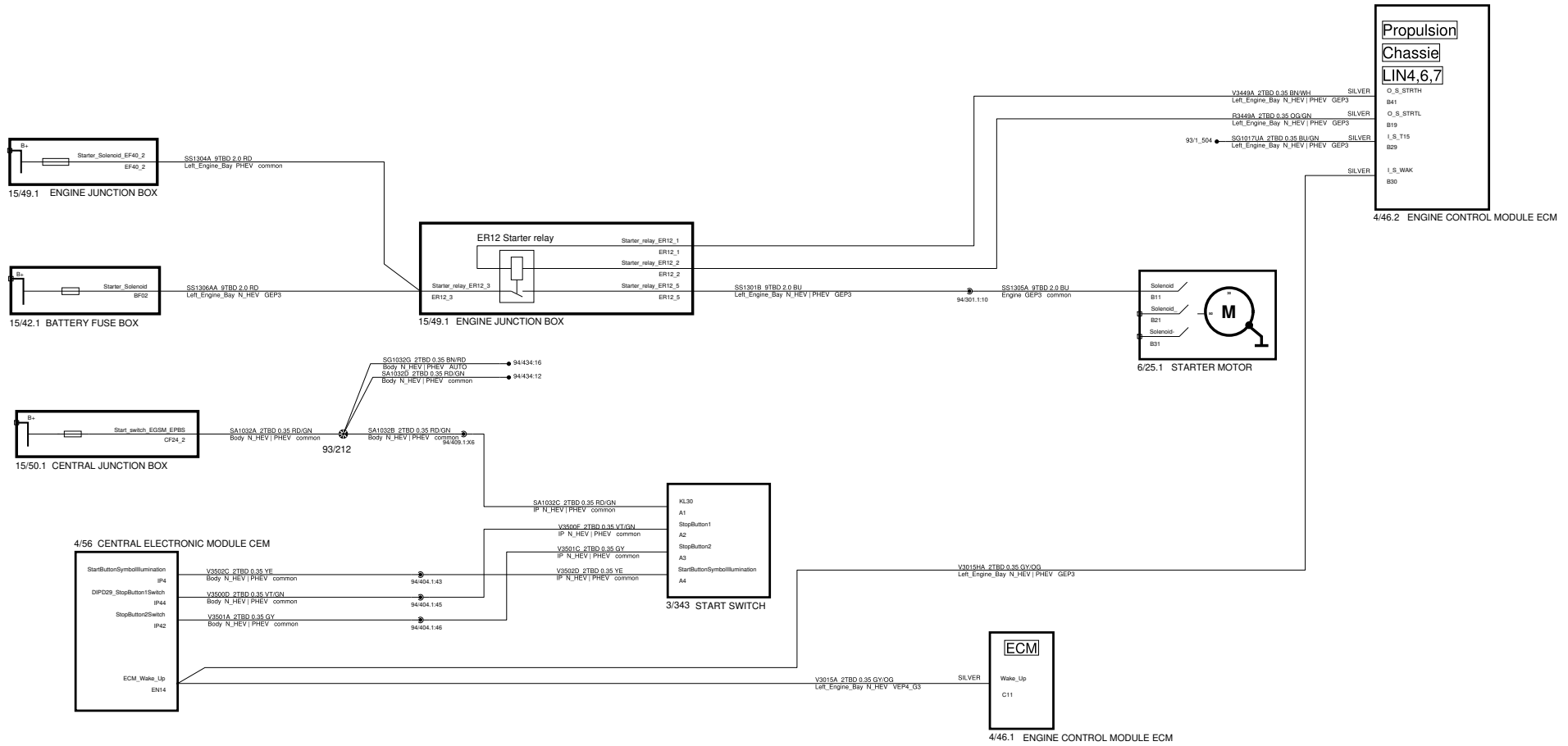

<b>VOLVO</b> VOLVO CAR CORPORATION	<b>Document title</b> 623A_PP_CC_04_06_2023 3M_Engine_Craking_Control_(HEV)	
	<b>Document Type</b> DRAW/ELSY	<b>Release Status</b> RELEASED
	CEVT Document No 8888522365	Edited April/13/2023
	Issue 035	Page No 91/146

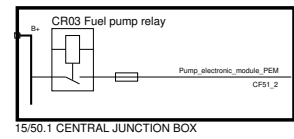
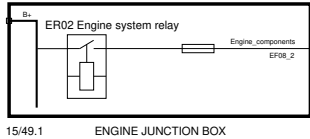
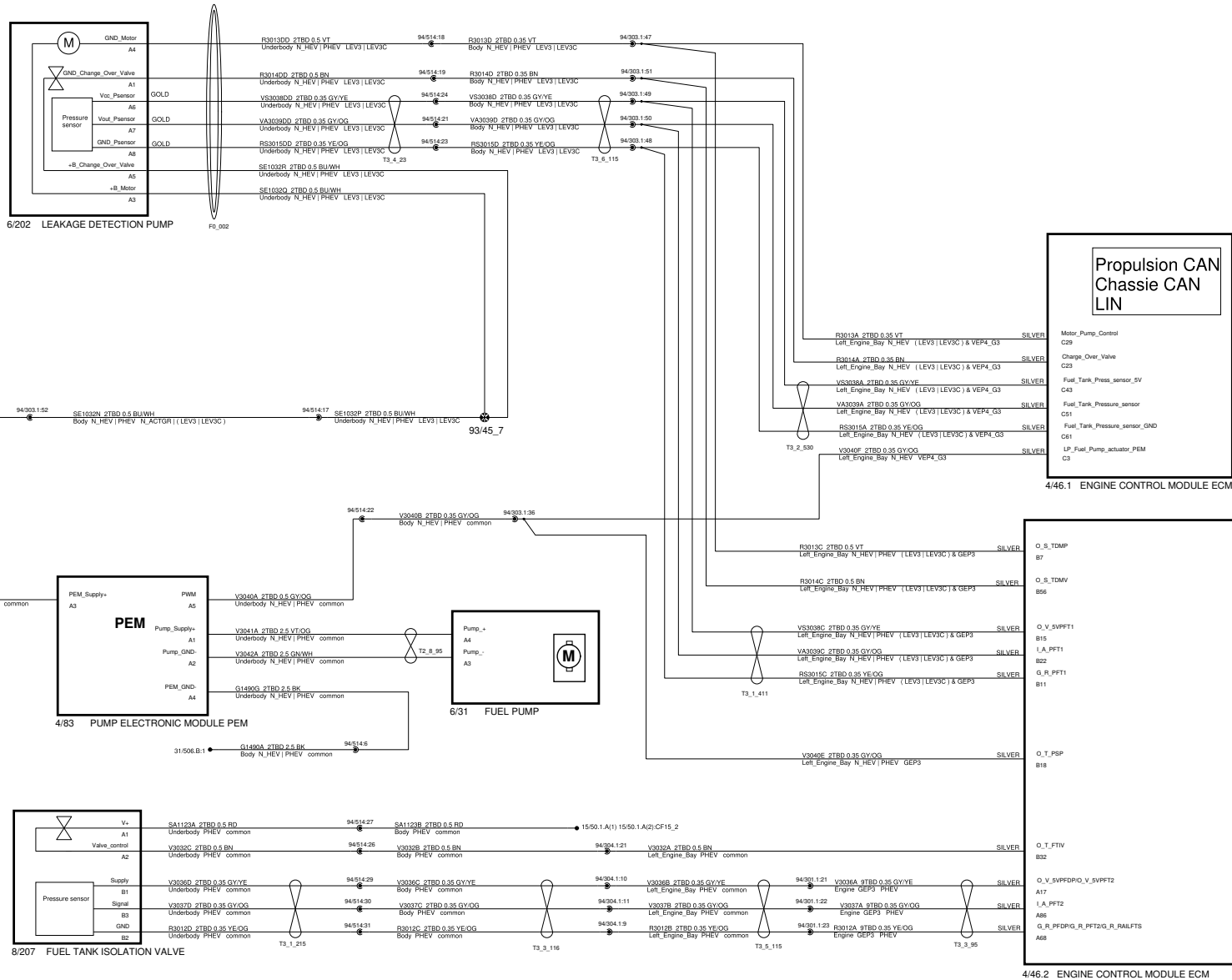

<p>The copying, distribution and utilization of this document as well as the communication of its contents to others without expressed authorization is prohibited. Offenders will be held liable for payment of damages. All rights reserved in the event of the grant of a patent, utility model or ornamental design registration.</p>		<p>Document title 623A_PP_CC_04_06_2023</p>	
		<p>3S_Fuel_Supply_Control</p>	
<p>Document Type DRAW/ELSY</p>		<p>Release Status RELEASED</p>	
<p>CEVT Document No 8888522365</p>		<p>Edited March/30/2023</p>	
<p>Issue 035</p>		<p>Page No 92/146</p>	

**VOLVO**  
VOLVO CAR CORPORATION

# 4A Driver information

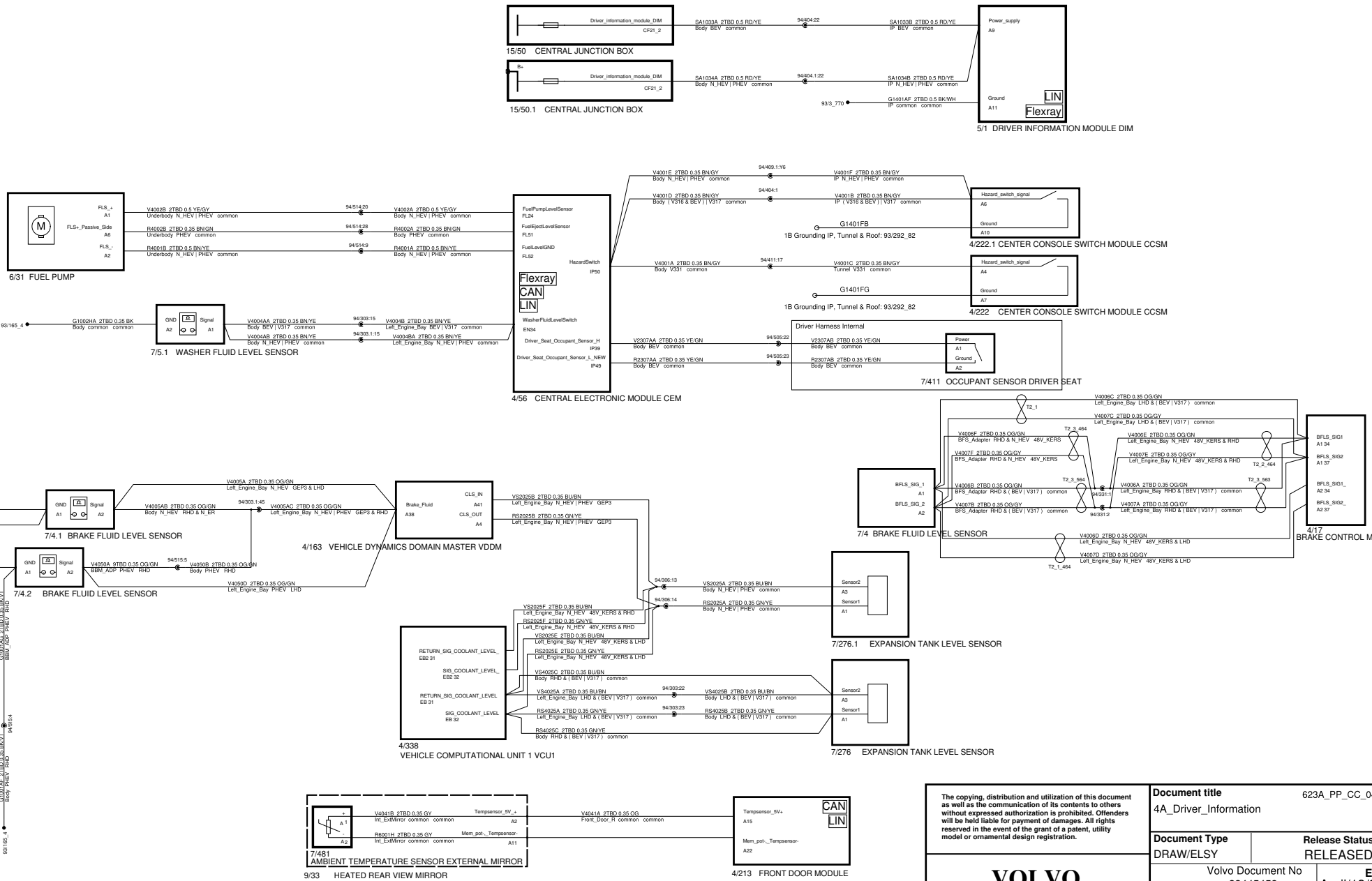

The copying, distribution and utilization of this document as well as the communication of its contents to others without expressed authorization is prohibited. Offenders will be held liable for payment of damages. All rights reserved in the event of the grant of a patent, utility model or ornamental design registration.		<b>Document title</b> 4A_Driver_Information	623A_PP_CC_04_06_2023
<b>Document Type</b> DRAW/ELSY	<b>Release Status</b> RELEASED		
Volvo Document No 33445458		<b>Edited</b> April/13/2023	
<b>Issue</b> 035		<b>Page No</b> 93/146	



# 4J1 Parking Assistance FAP

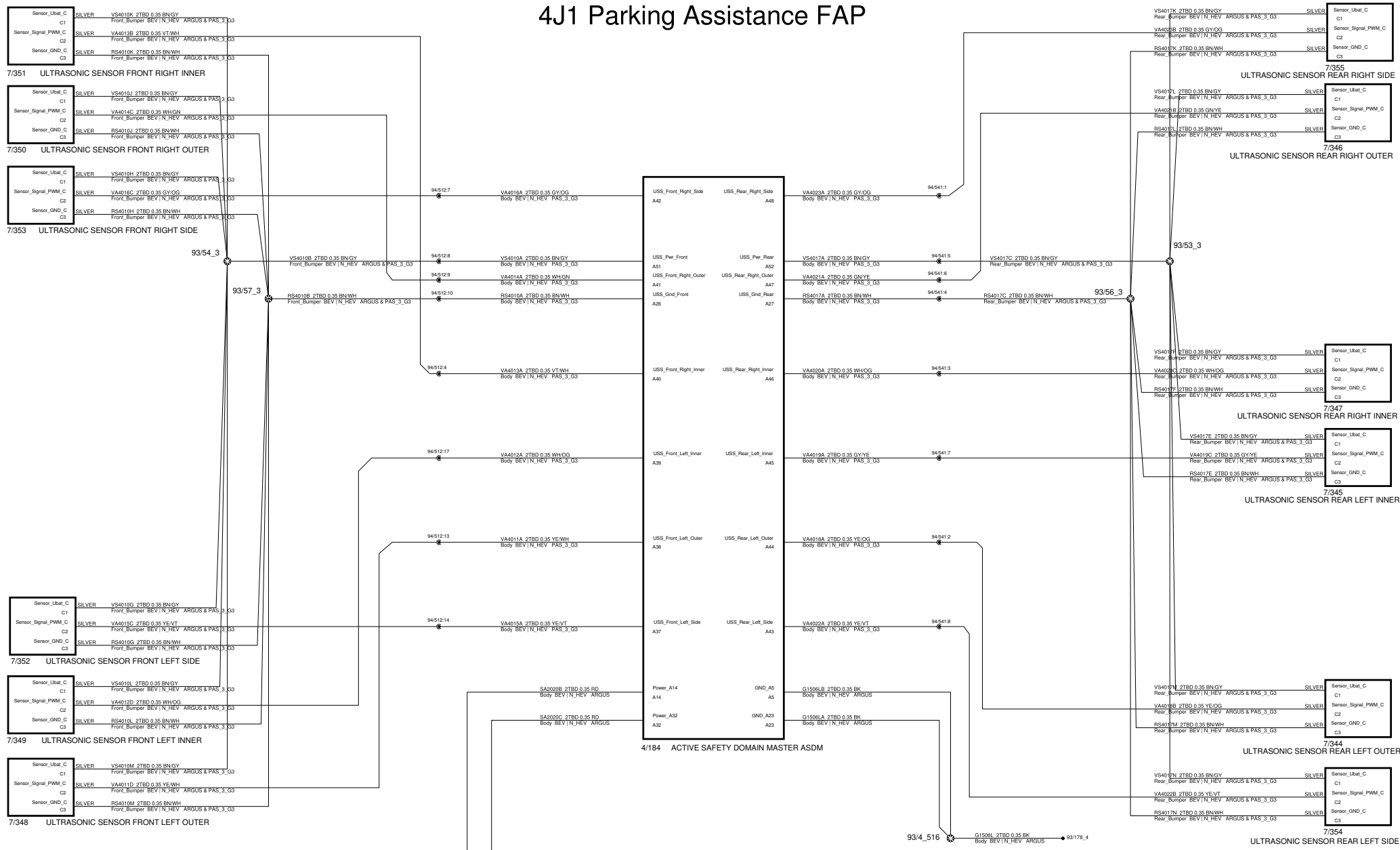

<p>The copying, distribution and utilization of this document as well as the communication of its contents to others without expressed authorization is prohibited. Offenders will be held liable for payment of damages. All rights reserved in the event of the grant of a patent, utility model or ornamental design registration.</p>		Document title		623A_PP_CC_04_06_2023
		4J1_Parking_Assistance_FAP		
Document Type		Release Status		
DRAW/ELSY		RELEASED		
Volvo Document No		Edited		
33445458		April/13/2023		
Issue		Page No		
035		94/146		

**VOLVO**  
VOLVO CAR CORPORATION

# 4J1 Parking Assistance NBEV

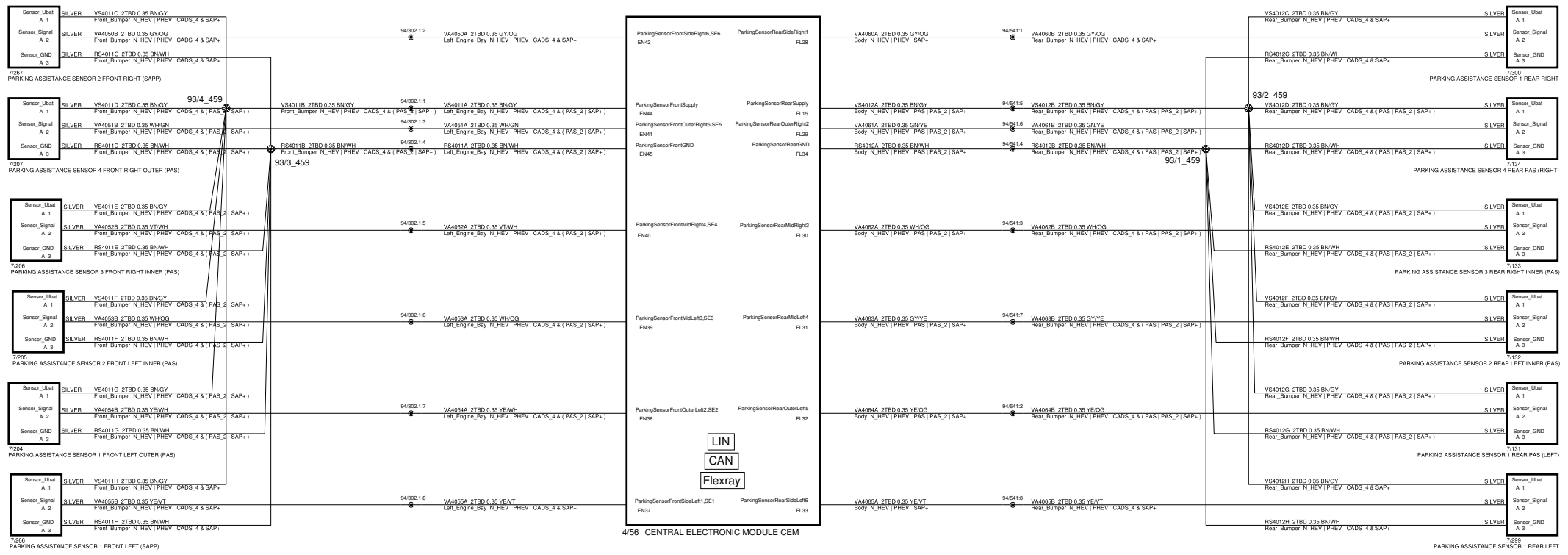

<p>The copying, distribution and utilization of this document as well as the communication of its contents to others without expressed authorization is prohibited. Offenders will be held liable for payment of damages. All rights reserved in the event of the grant of a patent, utility model or ornamental design registration.</p>		<p>Document title 623A_PP_CC_04_06_2023</p>	
		<p>4J1_Parking_Assistance_NBEV</p>	
<p>Document Type DRAW/ELSY</p>		<p>Release Status RELEASED</p>	
<p>CEVT Document No 8888522365</p>		<p>Edited June/16/2021</p>	
<p>Issue 035</p>		<p>Page No 95/146</p>	

**VOLVO**  
VOLVO CAR CORPORATION



# 4J1 Parking Assistance PAS PAS\_2

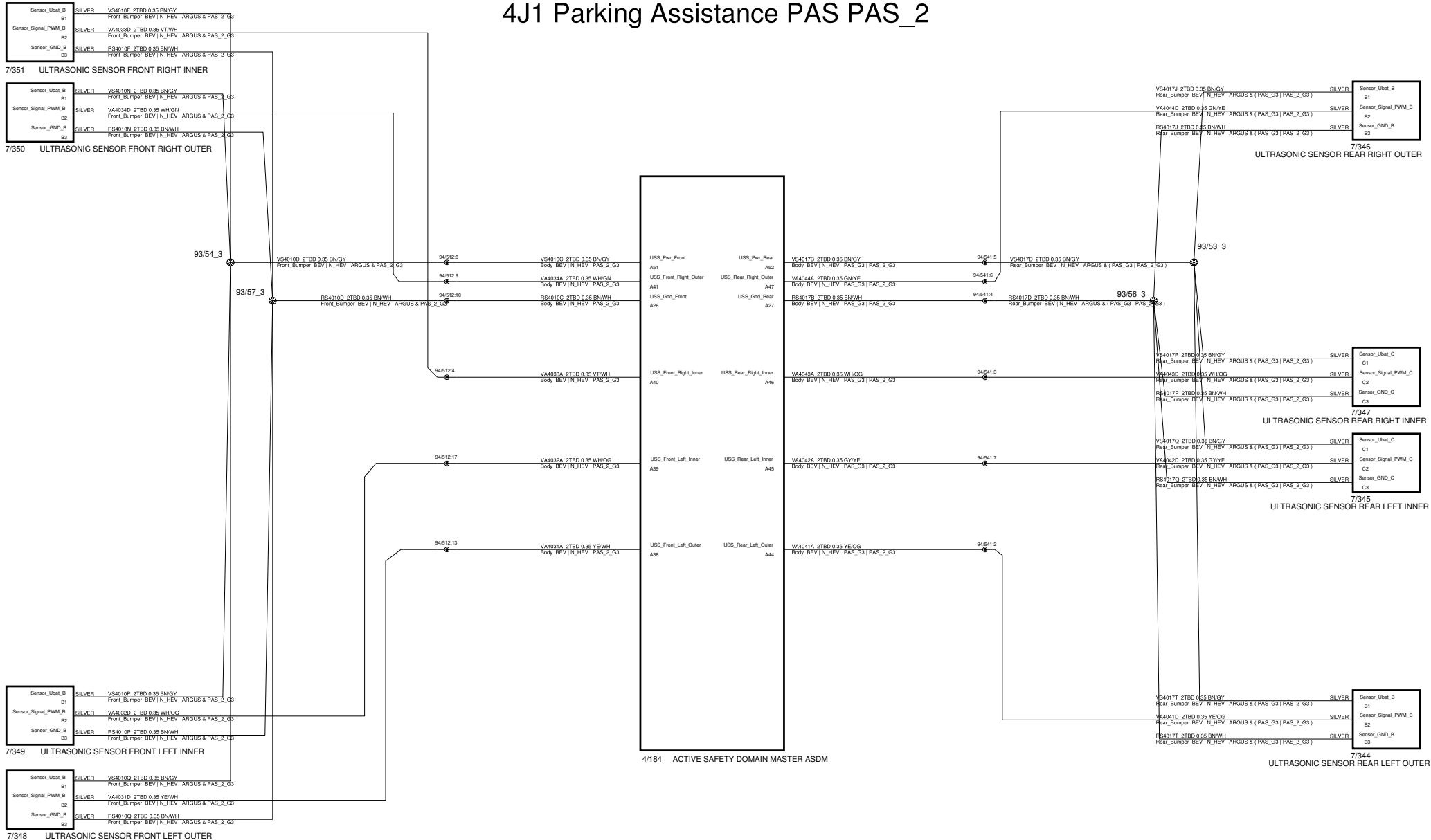

<p>The copying, distribution and utilization of this document as well as the communication of its contents to others without expressed authorization is prohibited. Offenders will be held liable for payment of damages. All rights reserved in the event of the grant of a patent, utility model or ornamental design registration.</p> <p><b>VOLVO</b> VOLVO CAR CORPORATION</p>	<p><b>Document title</b> 623A_PP_GC_04_06_2023 4J1_Parking_Assistance_PAS_PAS2</p>	
	<p><b>Document Type</b> DRAW/ELSY</p>	<p><b>Release Status</b> RELEASED</p>
	<p>CEVT Document No 8888522365</p>	<p><b>Edited</b> June/16/2021</p>
	<p><b>Issue</b> 035</p>	<p><b>Page No</b> 96/146</p>

# 4J2B Lane Change Aid

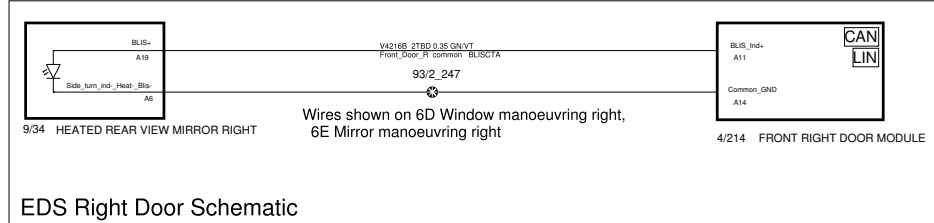
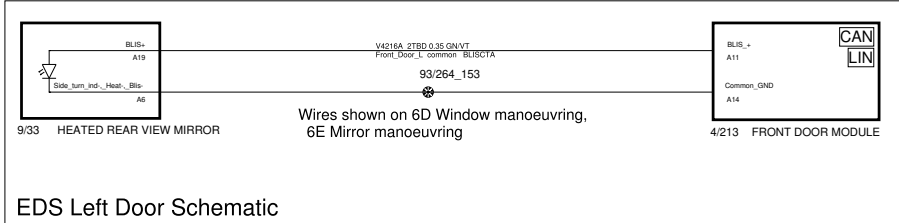
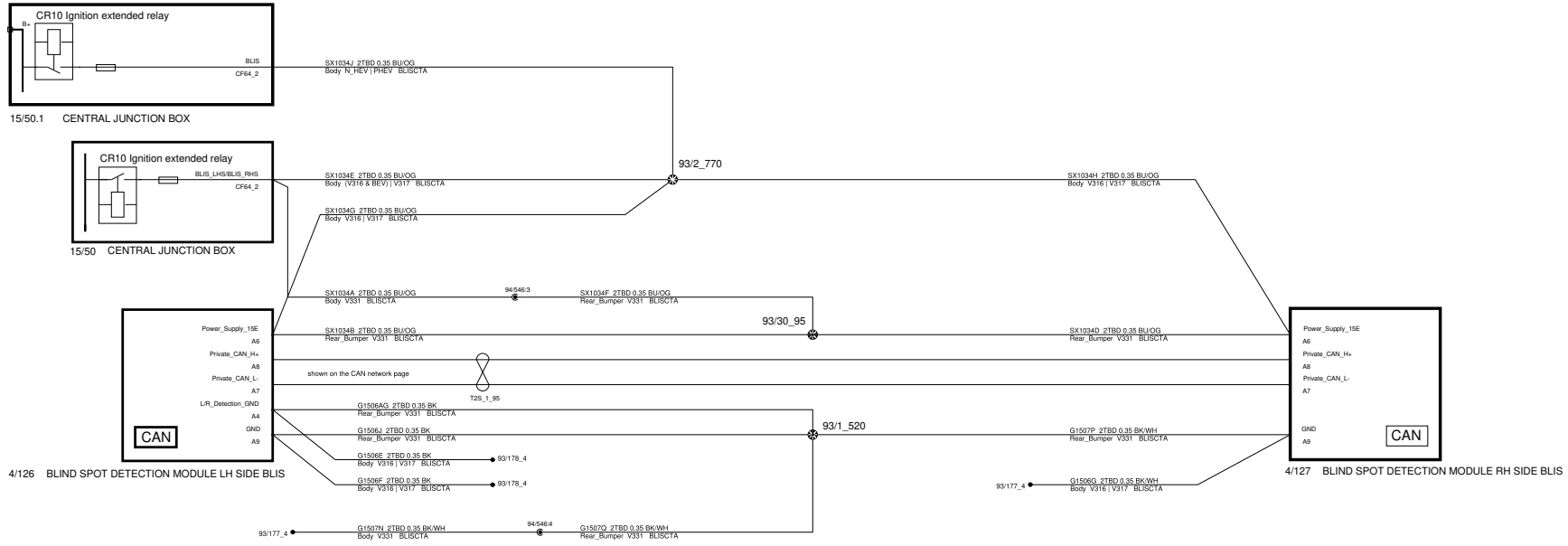

<p>The copying, distribution and utilization of this document as well as the communication of its contents to others without expressed authorization is prohibited. Offenders will be held liable for payment of damages. All rights reserved in the event of the grant of a patent, utility model or ornamental design registration.</p>		<p>Document title 623A_PP_CC_04_06_2023</p>	
		<p>4J2B_Lane_Change_Aid</p>	
<p>Document Type DRAW/ELSY</p>		<p>Release Status RELEASED</p>	
<p>Volvo Document No 33445458</p>		<p>Edited April/13/2023</p>	
<p>Issue 035</p>		<p>Page No 97/146</p>	

**VOLVO**  
VOLVO CAR CORPORATION

# 4J4 PAC Visualisation/Driver Assistance COAX

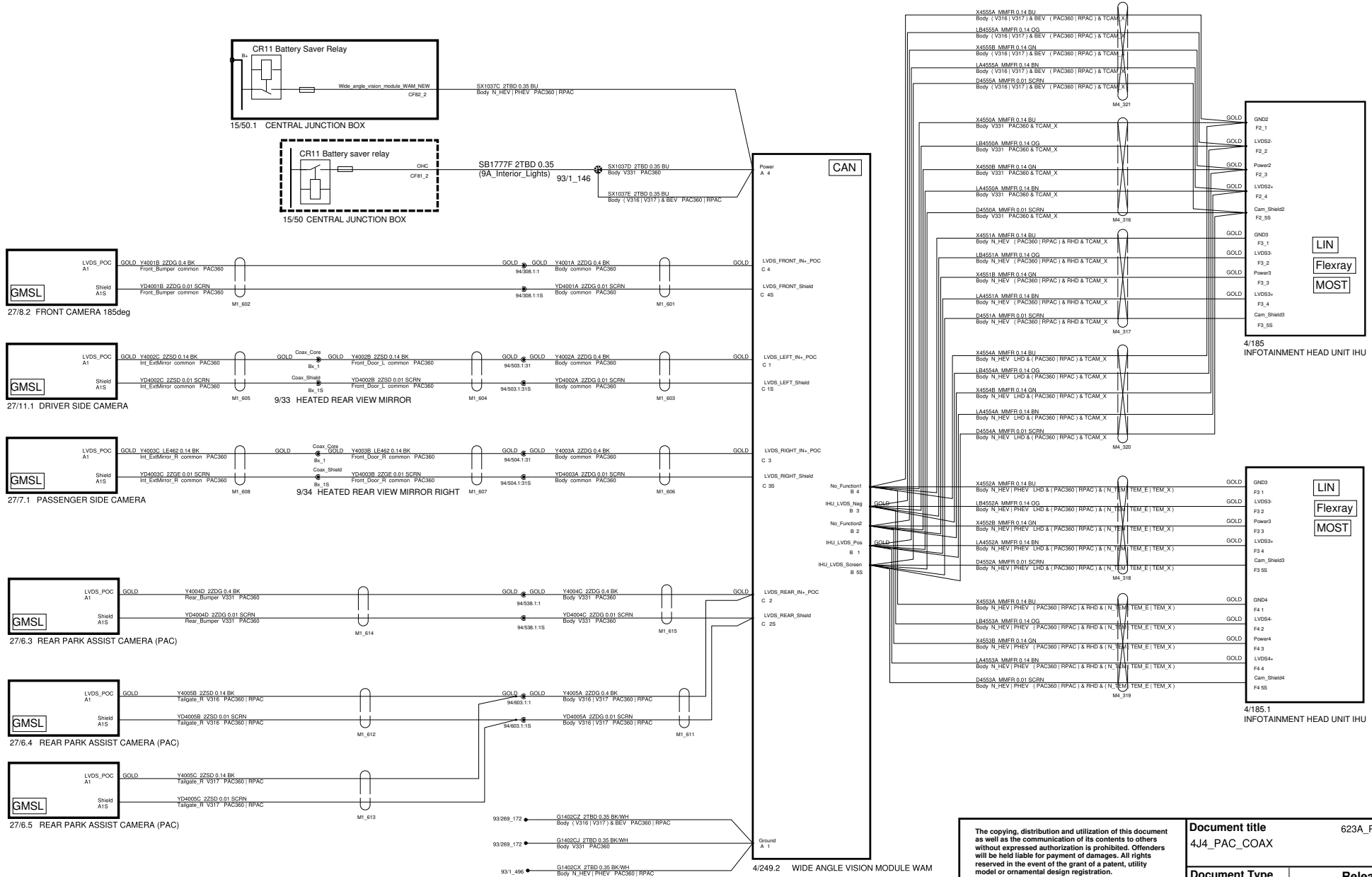

<p>The copying, distribution and utilization of this document as well as the communication of its contents to others without expressed authorization is prohibited. Offenders will be held liable for payment of damages. All rights reserved in the event of a patent, utility model or ornamental design registration.</p>		<p><b>Document title</b> 623A_PP_CO_04_06_2023</p>	
		<p><b>4J4_PAC_COAX</b></p>	
<p><b>Document Type</b> DRAW/ELSY</p>		<p><b>Release Status</b> RELEASED</p>	
<p>CEVT Document No 8888522365</p>		<p><b>Edited</b> April/13/2023</p>	
<p><b>Issue</b> 035</p>		<p><b>Page No</b> 98/146</p>	

**VOLVO**  
VOLVO CAR CORPORATION

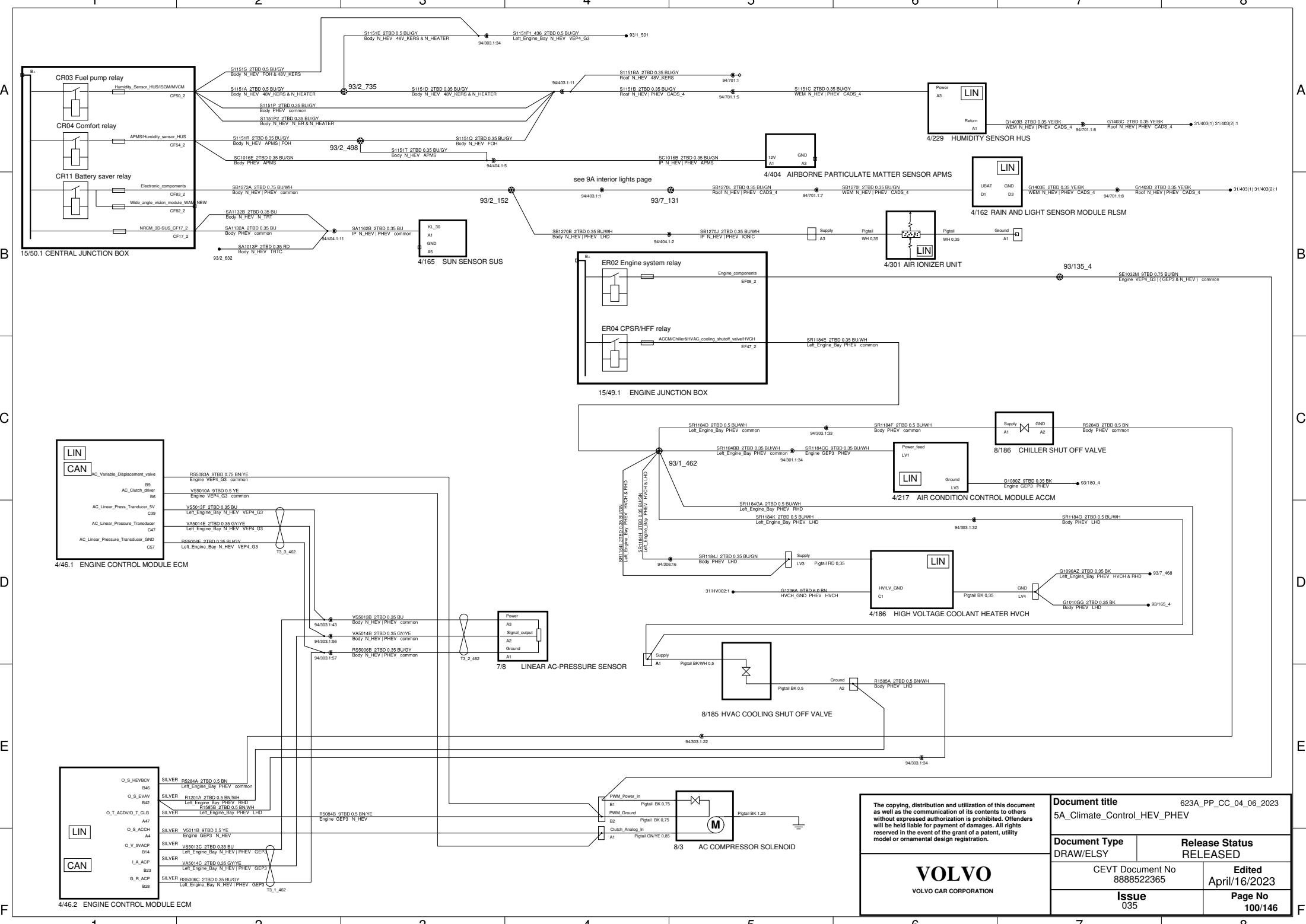

The copying, distribution and utilization of this document as well as the communication of its contents to others without expressed authorization is prohibited. Offenders will be held liable for payment of damages. All rights reserved in the event of a patent, utility model or ornamental design registration.

**VOLVO**  
VOLVO CAR CORPORATION

<b>Document title</b> 623A_PP_CC_04_06_2023 5A_Climate_Control_HEV_PHEV	
<b>Document Type</b> DRAW/ELSY	<b>Release Status</b> RELEASED
CEVT Document No 8888522365	<b>Edited</b> April/16/2023
<b>Issue</b> 035	<b>Page No</b> 100/146

# 5A Climate Control HVAC ECC

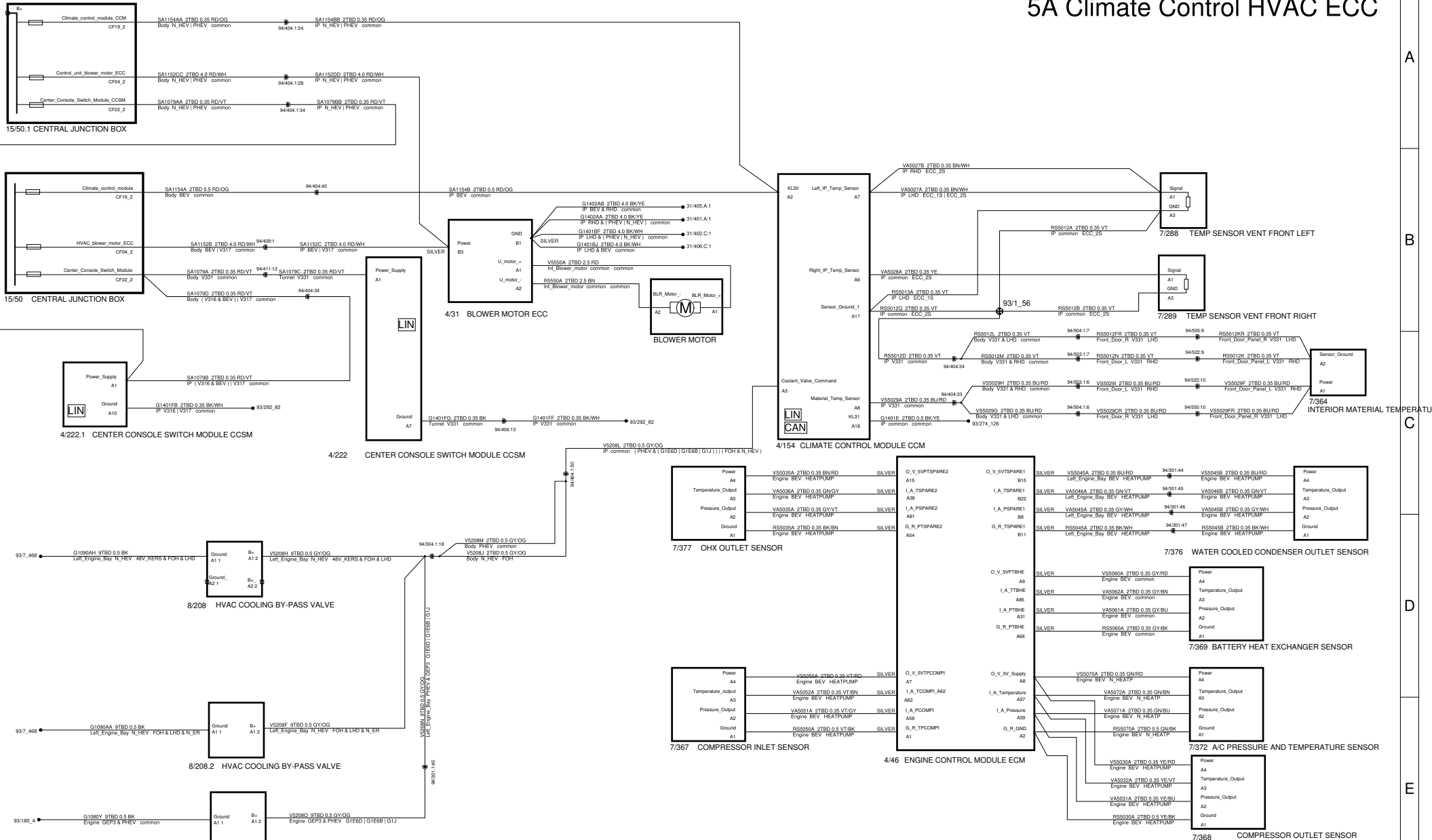

The copying, distribution and utilization of this document as well as the communication of its contents to others without expressed authorization is prohibited. Offenders will be held liable for payment of damages. All rights reserved in the event of the grant of a patent, utility model or ornamental design registration.

**Document title** 623A\_PP\_CC\_04\_06\_2023  
**5A\_Climate\_Control\_HVAC\_ECC**

<b>Document Type</b> DRAW/ELSY	<b>Release Status</b> RELEASED
<b>Issue</b> 035	<b>Page No</b> 101/146

**VOLVO**  
VOLVO CAR CORPORATION

Volvo Document No 33445458 Edited April/19/2023

# 5A Climate Control

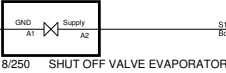
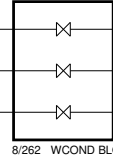
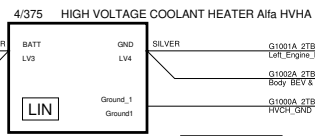
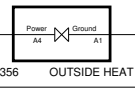
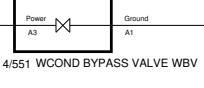
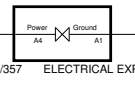
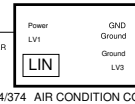
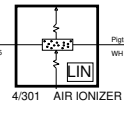
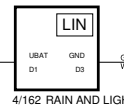
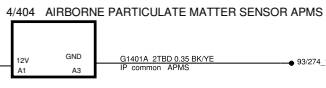
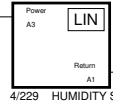
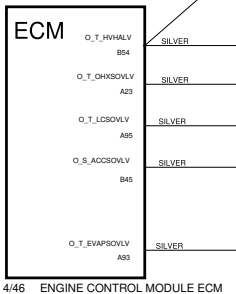
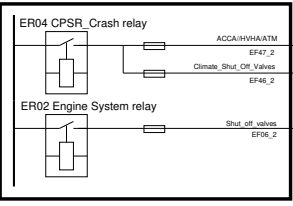
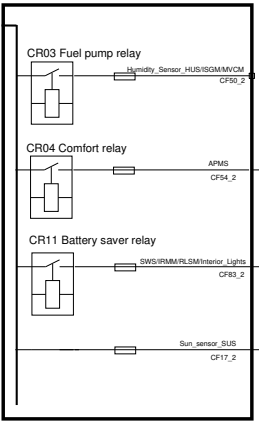
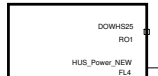

The copying, distribution and utilization of this document as well as the communication of its contents to others without expressed authorization is prohibited. Offenders will be held liable for payment of damages. All rights reserved in the event of the grant of a patent, utility model or ornamental design registration.

**VOLVO**  
VOLVO CAR CORPORATION

<b>Document title</b>		623A_PP_CC_04_06_2023	
5A_Climate_Control		RELEASED	
<b>Document Type</b>	Volvo Document No		<b>Release Status</b>
DRAW/ELSY	33445458		Edited
Issue		Page No	
035		99/146	

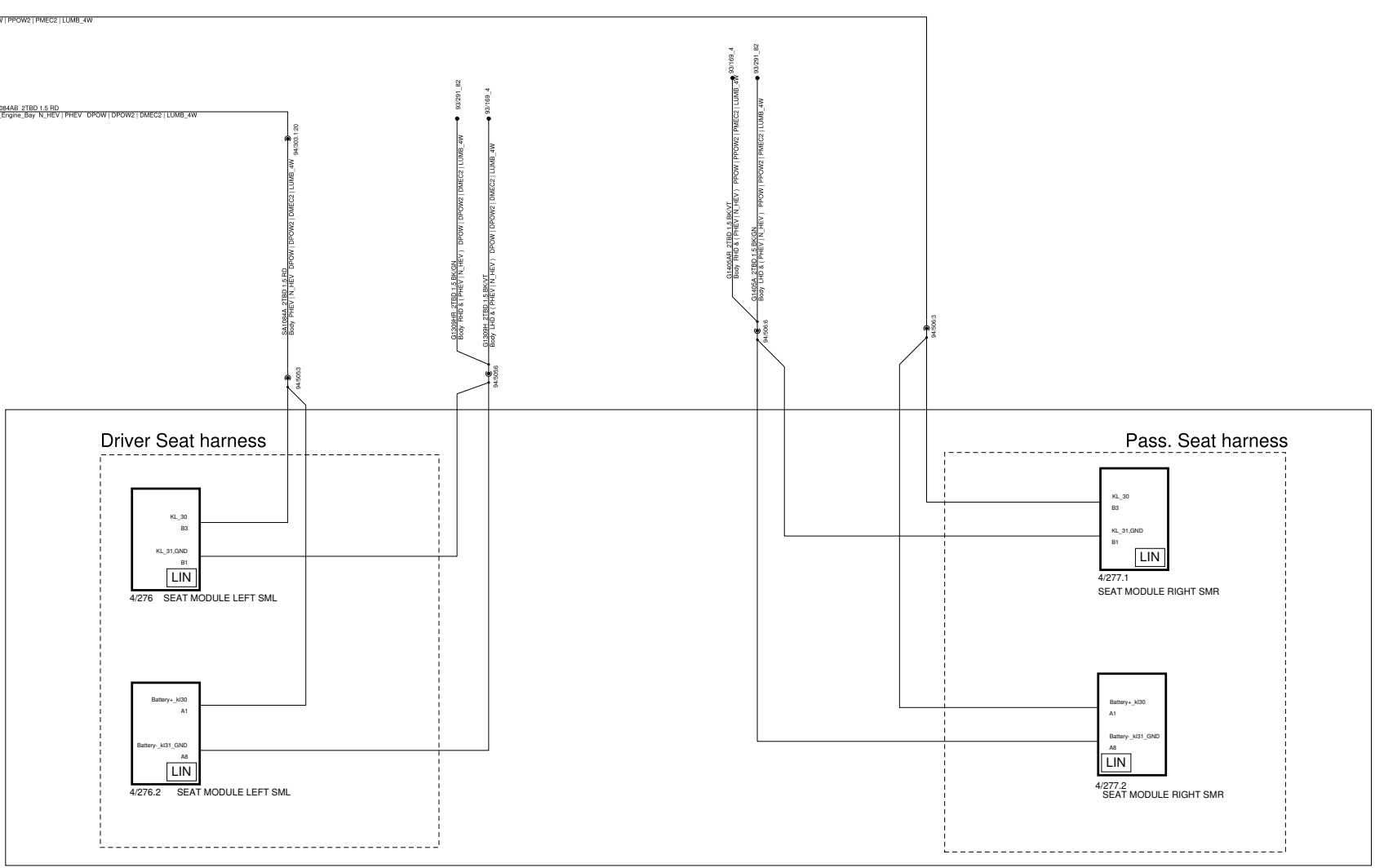
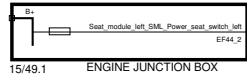
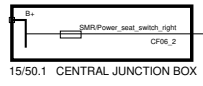

<p>The copying, distribution and utilization of this document as well as the communication of its contents to others without expressed authorization is prohibited. Offenders will be held liable for payment of damages. All rights reserved in the event of the grant of a patent, utility model or ornamental design registration.</p> <p><b>VOLVO</b> VOLVO CAR CORPORATION</p>	<p><b>Document title</b> 623A_PP_CC_04_06_2023</p> <p>5B_Front_Seat_Comfort_PHEV</p>	
	<p><b>Document Type</b> DRAW/ELSY</p>	<p><b>Release Status</b> RELEASED</p>
	<p>CEVT Document No 8888522365</p>	<p><b>Edited</b> April/16/2023</p>
	<p><b>Issue</b> 035</p>	<p><b>Page No</b> 103/146</p>

# 5B Front Seat Comfort

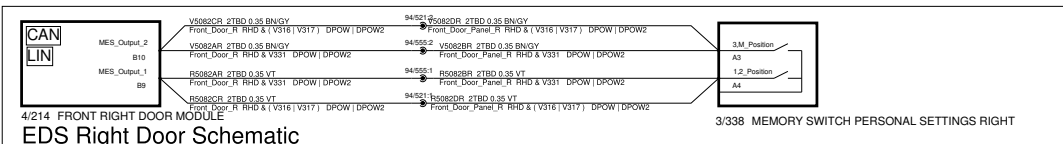
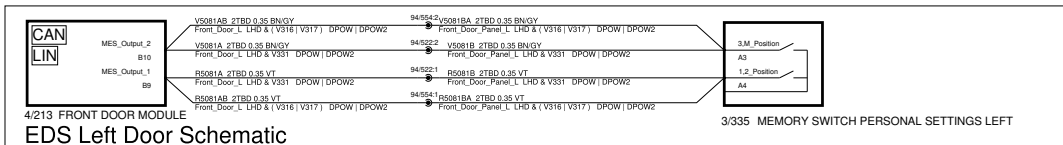
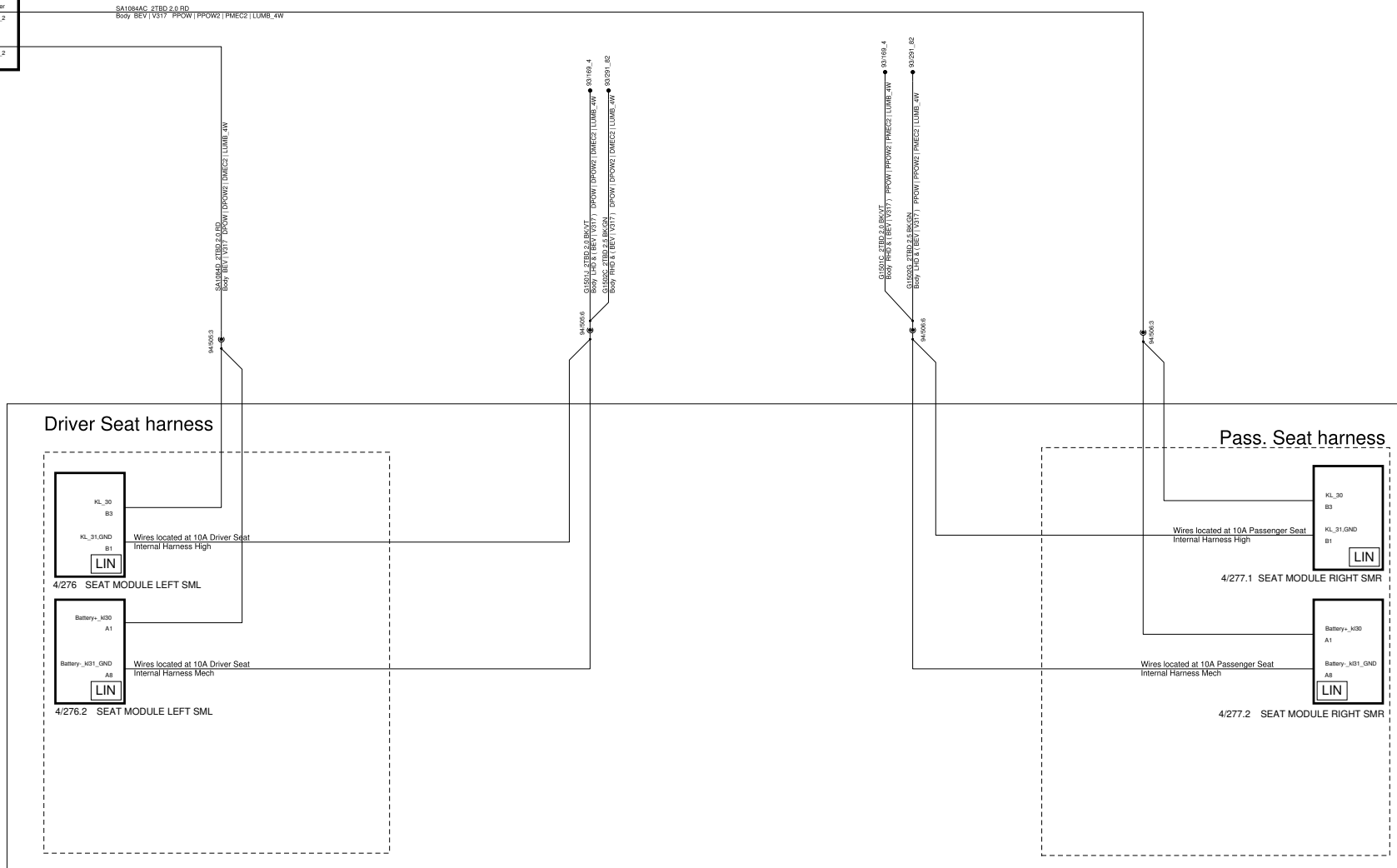
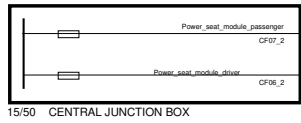

<p>The copying, distribution and utilization of this document as well as the communication of its contents to others without expressed authorization is prohibited. Offenders will be held liable for payment of damages. All rights reserved in the event of the grant of a patent, utility model or ornamental design registration.</p>		<p><b>Document title</b></p> <p>623A_PP_CC_04_06_2023</p>	
		<p><b>Document Type</b></p> <p>DRAW/ELSY</p>	<p><b>Release Status</b></p> <p>RELEASED</p>
<p><b>VOLVO</b></p> <p>VOLVO CAR CORPORATION</p>		<p>Volvo Document No</p> <p>33445458</p>	<p><b>Edited</b></p> <p>April/16/2023</p>
		<p><b>Issue</b></p> <p>035</p>	<p><b>Page No</b></p> <p>102/146</p>



# 5B Rear Seat Comfort

## Rear Seat Harness

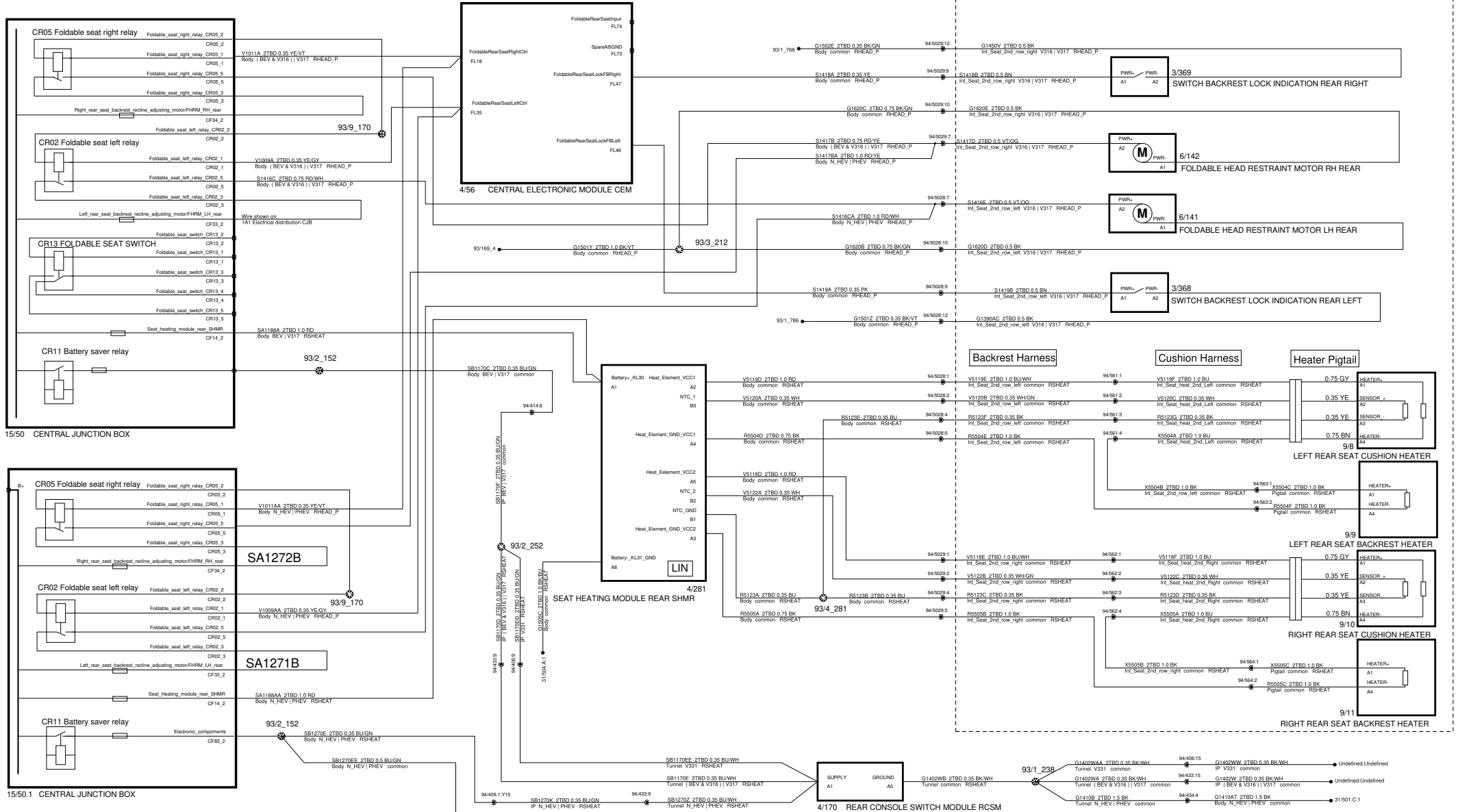

Continues through  
 - 8A\_Exterior\_Light\_Front  
 - 9A\_Interior\_Lights

<p>The copying, distribution and utilization of this document as well as the communication of its contents to others without expressed authorization is prohibited. Offenders will be held liable for payment of damages. All rights reserved in the event of the grant of a patent, utility model or ornamental design registration.</p>		<p>Document title 5B_Rear_Seat_Comfort</p> <p>623A_PP_CC_04_06_2023</p>	
<p>Document Type DRAW/ELSY</p>		<p>Release Status RELEASED</p>	
<p>Volvo Document No 33445458</p>		<p>Edited April/16/2023</p>	
<p>Issue 035</p>		<p>Page No 104/146</p>	



VOLVO CAR CORPORATION

# 5F1 Passenger Compartment Pre-Conditioning

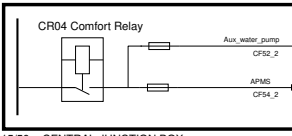

15/50 CENTRAL JUNCTION BOX

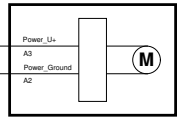

4/694 COMPARTMENT COOLANT PUMP MODULE CCPM

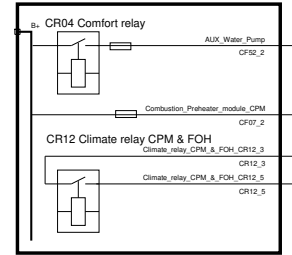

15/50.1 CENTRAL JUNCTION BOX

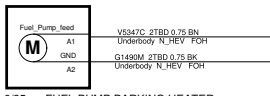

6/35 FUEL PUMP PARKING HEATER

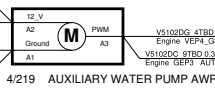

4/219 AUXILIARY WATER PUMP AWP

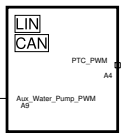

4/154 CLIMATE CONTROL MODULE CCM

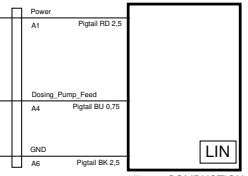

4/7 COMBUSTION PREHEATER MODULE CPM

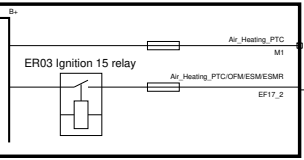

15/49.1 ENGINE JUNCTION BOX

<b>VOLVO</b> VOLVO CAR CORPORATION	<b>Document title</b> 623A_PP_CC_04_06_2023 5F1_Passenger_Compartment_Pre-Conditioning	
	<b>Document Type</b> DRAW/ELSY	<b>Release Status</b> RELEASED
	Volvo Document No 33445458	<b>Edited</b> April/16/2023
	<b>Issue</b> 035	<b>Page No</b> 105/146

# 5G Steering Wheel Heating

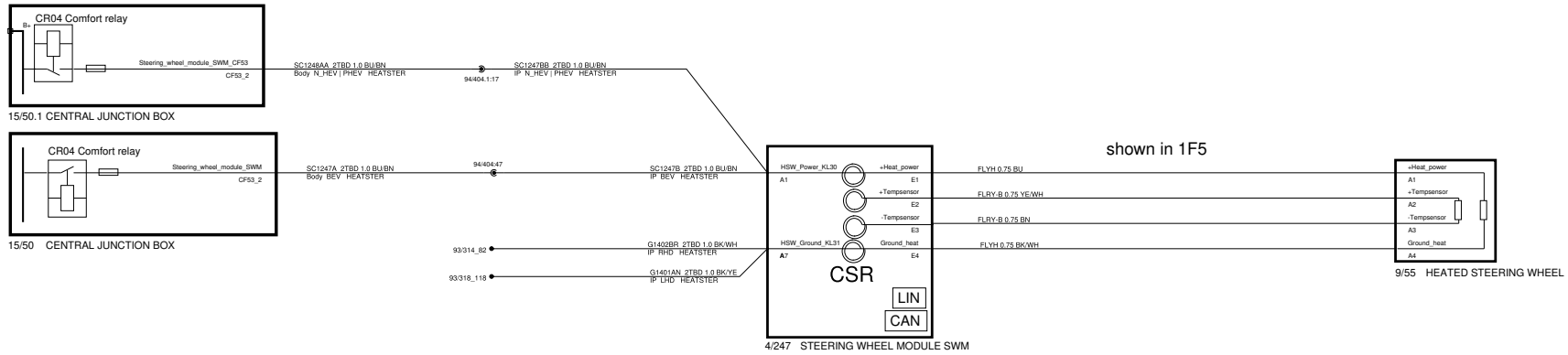

<p>The copying, distribution and utilization of this document as well as the communication of its contents to others without expressed authorization is prohibited. Offenders will be held liable for payment of damages. All rights reserved in the event of the grant of a patent, utility model or ornamental design registration.</p> <p><b>VOLVO</b> VOLVO CAR CORPORATION</p>	<b>Document title</b> 623A_PP_CC_04_06_2023 5G_Steering_Wheel_Heating	
	<b>Document Type</b> DRAW/ELSY	<b>Release Status</b> RELEASED
	Volvo Document No 33445458	<b>Edited</b> April/16/2023
	<b>Issue</b> 035	<b>Page No</b> 106/146

# 6A Locking Front Right

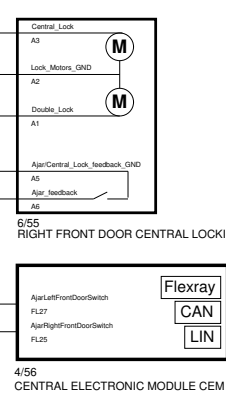
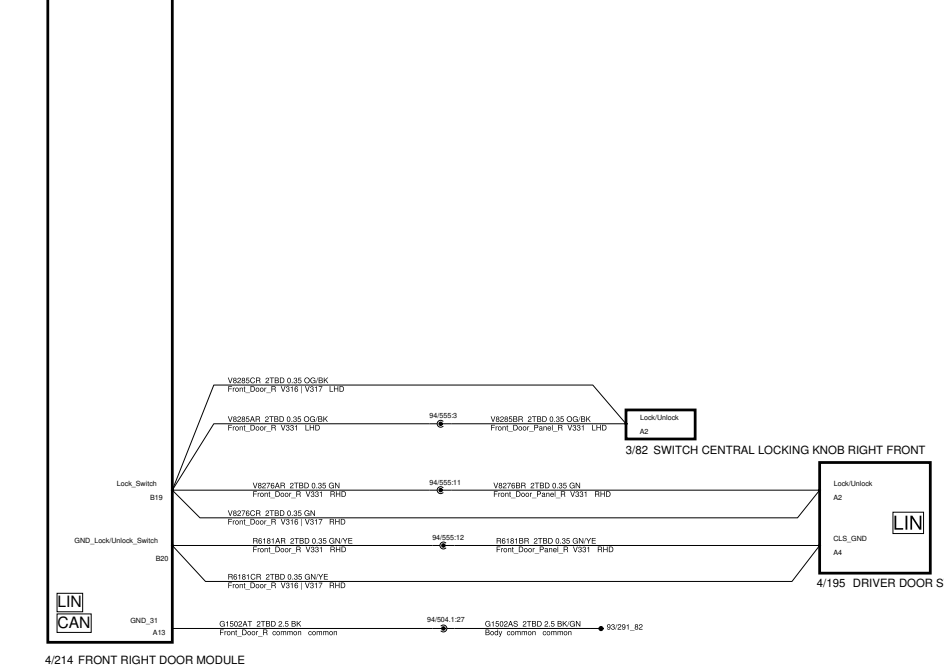
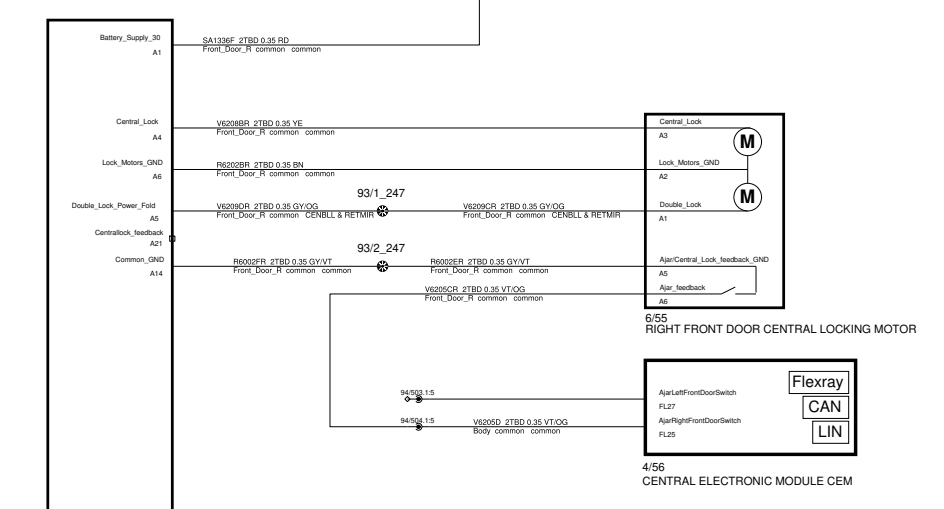
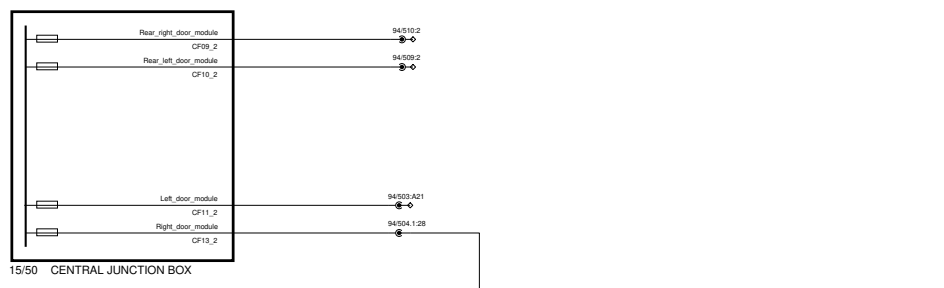

<p>The copying, distribution and utilization of this document as well as the communication of its contents to others without expressed authorization is prohibited. Offenders will be held liable for payment of damages. All rights reserved in the event of the grant of a patent, utility model or ornamental design registration.</p> <p><b>VOLVO</b> VOLVO CAR CORPORATION</p>	<b>Document title</b> 623A_PP_CC_04_06_2023	
	6A_Locking_Front_Right	
	<b>Document Type</b> DRAW/ELSY	<b>Release Status</b> RELEASED
	CEVT Document No 8888522365	<b>Edited</b> April/16/2023
<b>Issue</b> 035	<b>Page No</b> 108/146	

# 6A Locking Rear Right

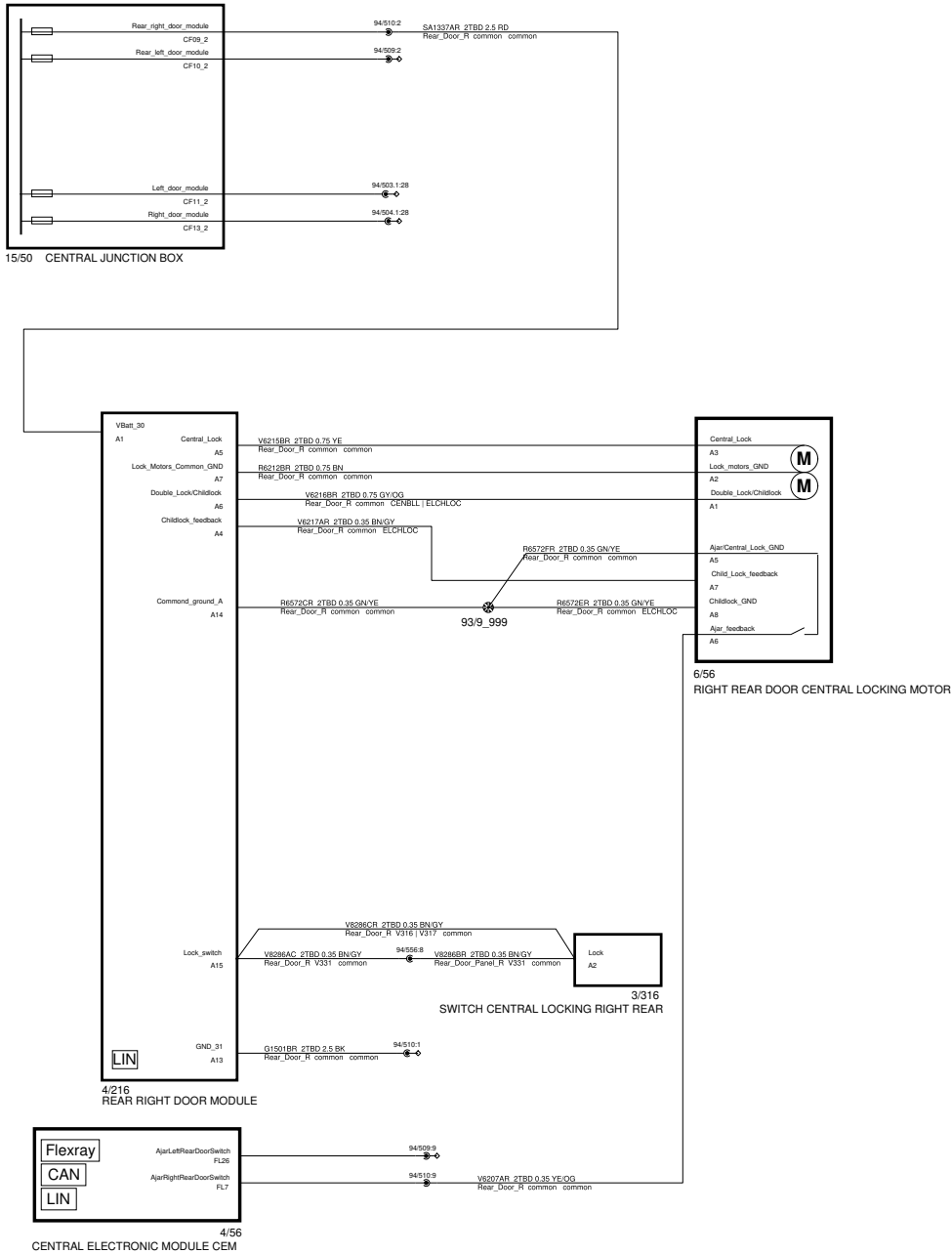

<p>The copying, distribution and utilization of this document as well as the communication of its contents to others without expressed authorization is prohibited. Offenders will be held liable for payment of damages. All rights reserved in the event of the grant of a patent, utility model or ornamental design registration.</p> <p><b>VOLVO</b> VOLVO CAR CORPORATION</p>	<b>Document title</b> 623A_PP_CC_04_06_2023	
	6A_Locking_Rear_Right	
	<b>Document Type</b> DRAW/ELSY	<b>Release Status</b> RELEASED
	CEVT Document No 8888522365	<b>Edited</b> April/16/2023
<b>Issue</b> 035	<b>Page No</b> 109/146	

# 6A Locking

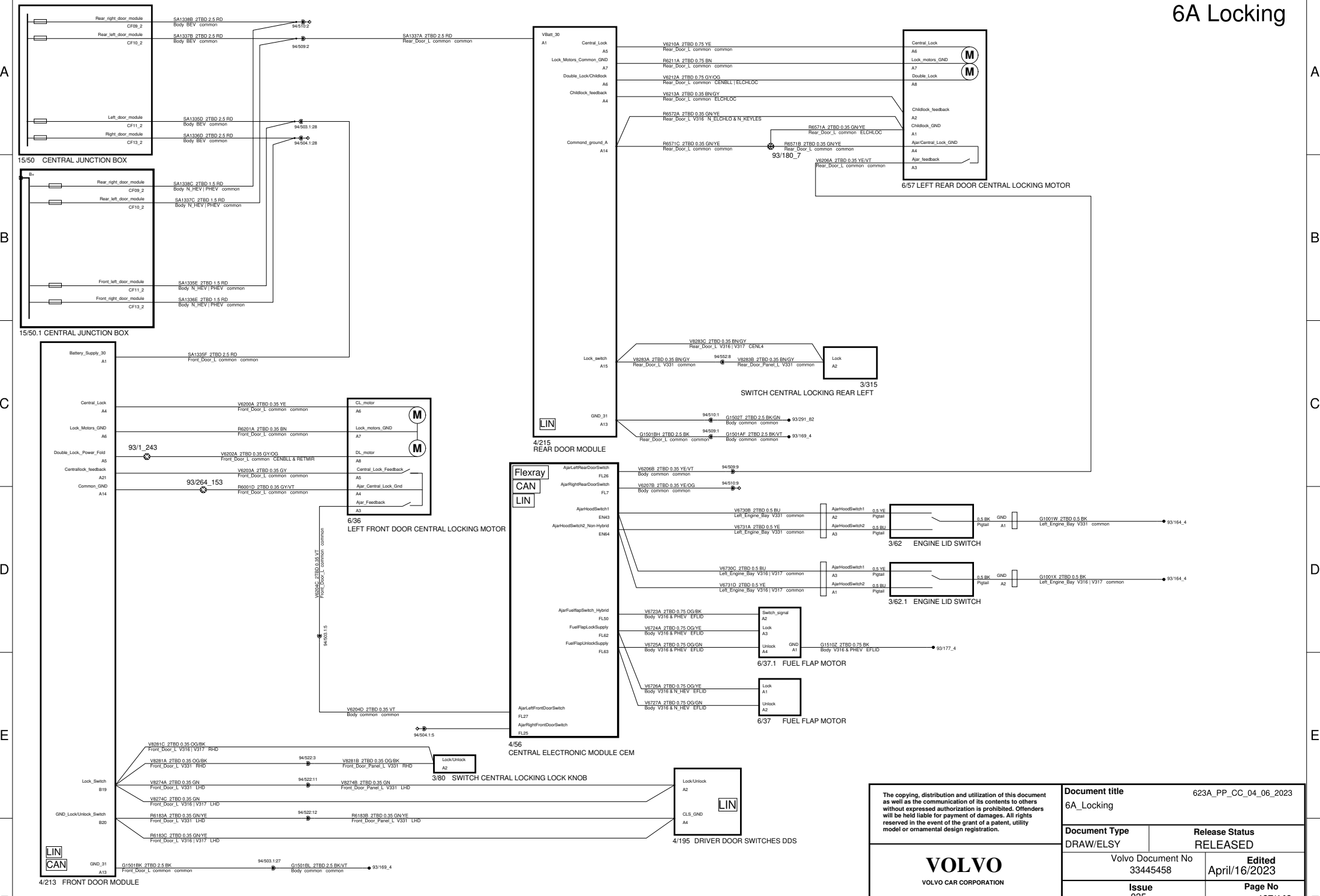

<p>The copying, distribution and utilization of this document as well as the communication of its contents to others without expressed authorization is prohibited. Offenders will be held liable for payment of damages. All rights reserved in the event of the grant of a patent, utility model or ornamental design registration.</p>		<p><b>Document title</b> 6A_Locking</p>	<p>623A_PP_CC_04_06_2023</p>
<p><b>Document Type</b> DRAW/ELSY</p>	<p><b>Release Status</b> RELEASED</p>		
<p><b>VOLVO</b> VOLVO CAR CORPORATION</p>		<p>Volvo Document No 33445458</p>	<p><b>Edited</b> April/16/2023</p>
		<p><b>Issue</b> 035</p>	<p><b>Page No</b> 107/146</p>

# 6C Theft Protection

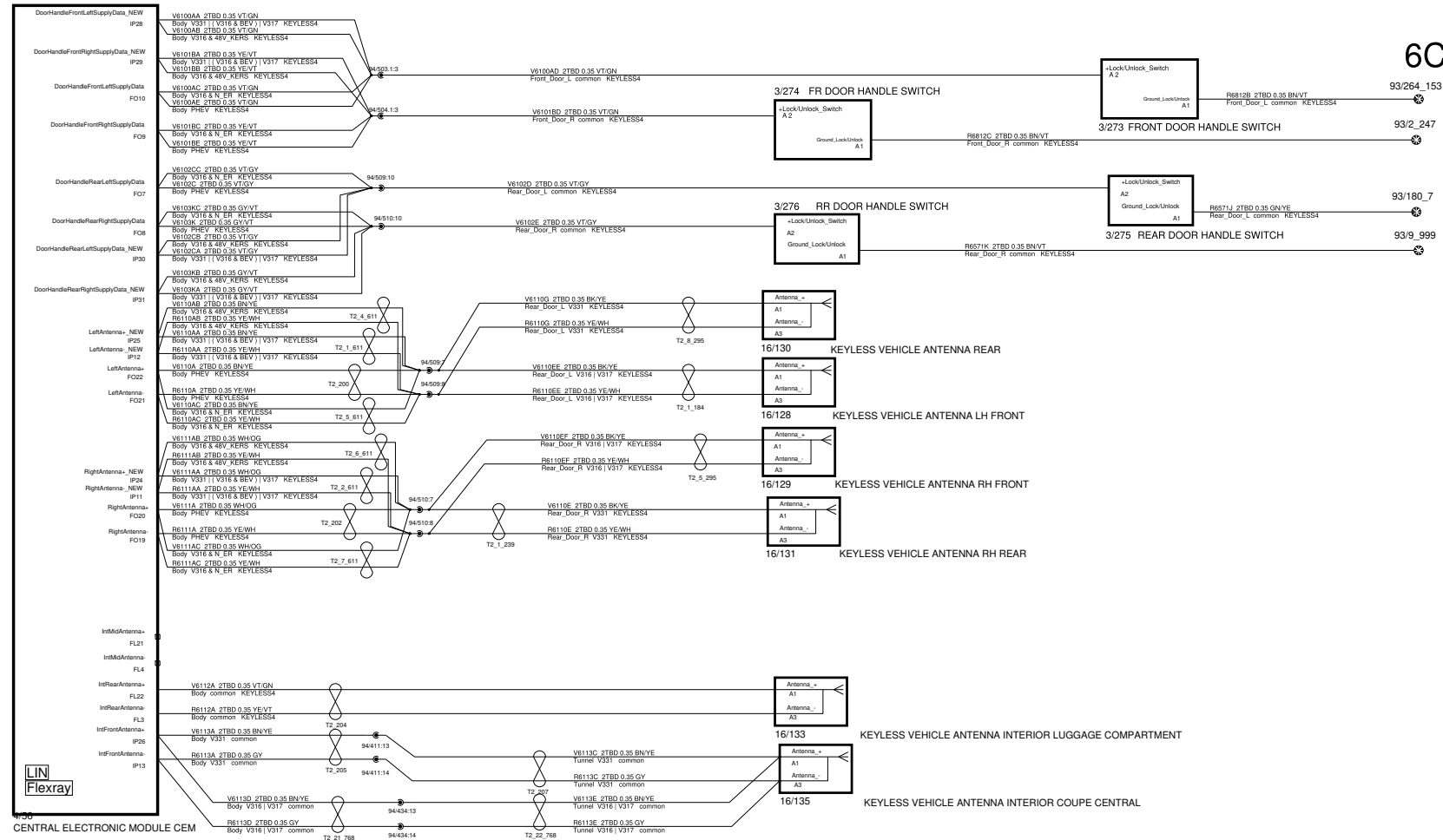

## Passive unlocking

## Immobilizing

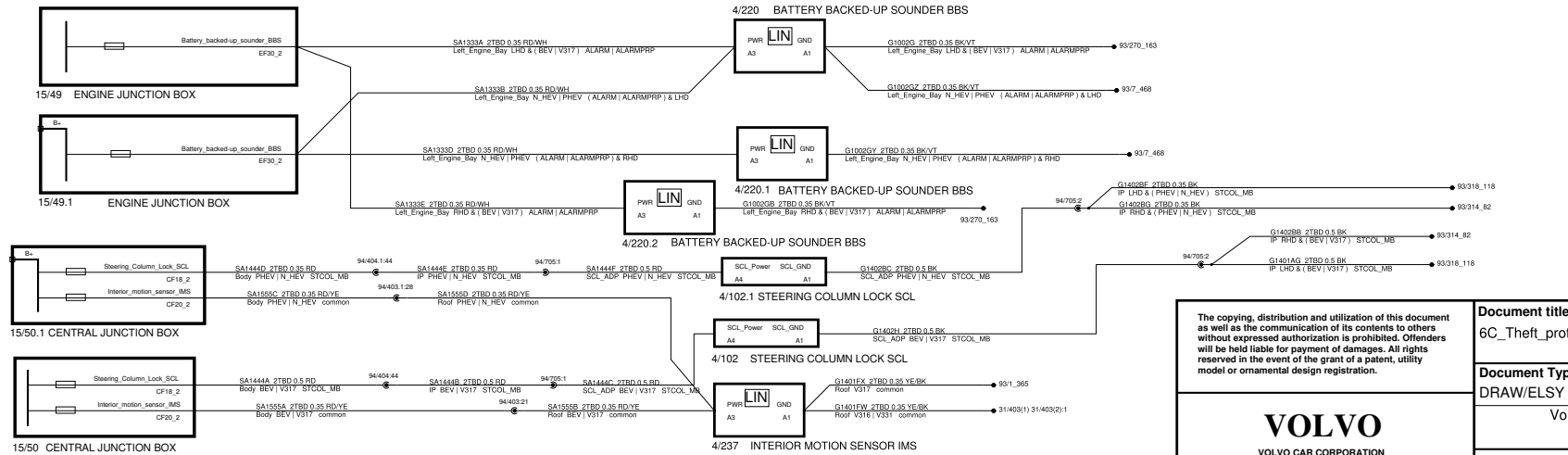

<p>The copying, distribution and utilization of this document as well as the communication of its contents to others without expressed authorization is prohibited. Offenders will be held liable for payment of damages. All rights reserved in the event of the grant of a patent, utility model or ornamental design registration.</p>		<p>Document title 6C_Theft_protection</p>	<p>623A_PP_CC_04_06_2023</p>
<p>Document Type DRAW/ELSY</p>	<p>Release Status RELEASED</p>		
<p>Volvo Document No 33445458</p>		<p>Edited April/16/2023</p>	
<p>Issue 035</p>		<p>Page No 111/146</p>	

**VOLVO**  
VOLVO CAR CORPORATION

# 6C1 Phone As Key

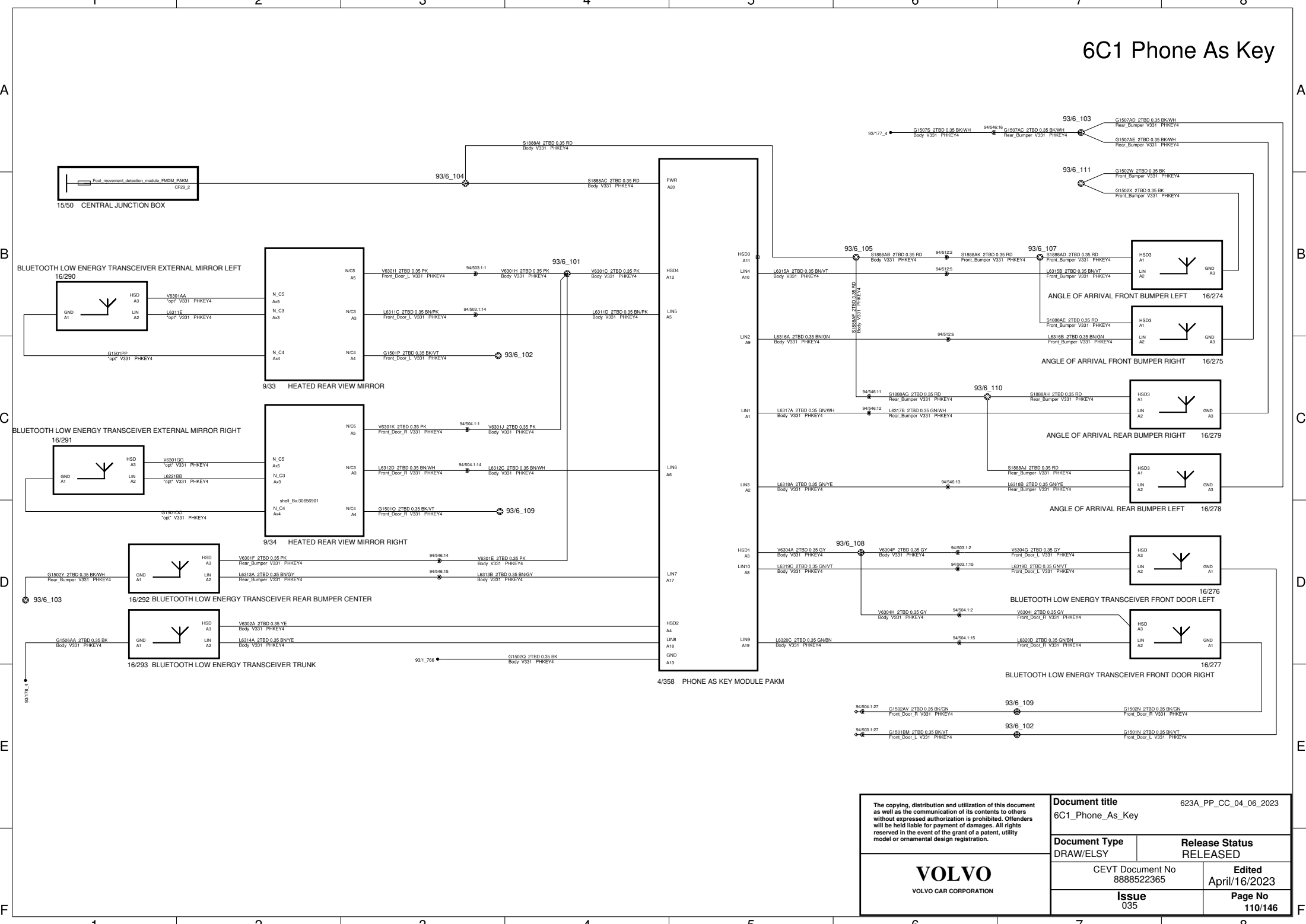

<p>The copying, distribution and utilization of this document as well as the communication of its contents to others without expressed authorization is prohibited. Offenders will be held liable for payment of damages. All rights reserved in the event of the grant of a patent, utility model or ornamental design registration.</p>		<p>Document title 623A_PP_CC_04_06_2023</p>	
		<p>6C1_Phone_As_Key</p>	
<p>Document Type DRAW/ELSY</p>		<p>Release Status RELEASED</p>	
<p>CEVT Document No 8888522365</p>		<p>Edited April/16/2023</p>	
<p>Issue 035</p>		<p>Page No 110/146</p>	

**VOLVO**  
VOLVO CAR CORPORATION



# 6D Window manoeuvring 6E Mirror manoeuvring

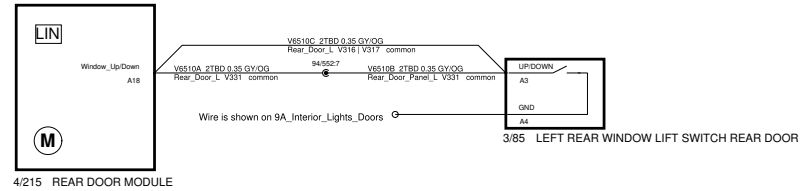
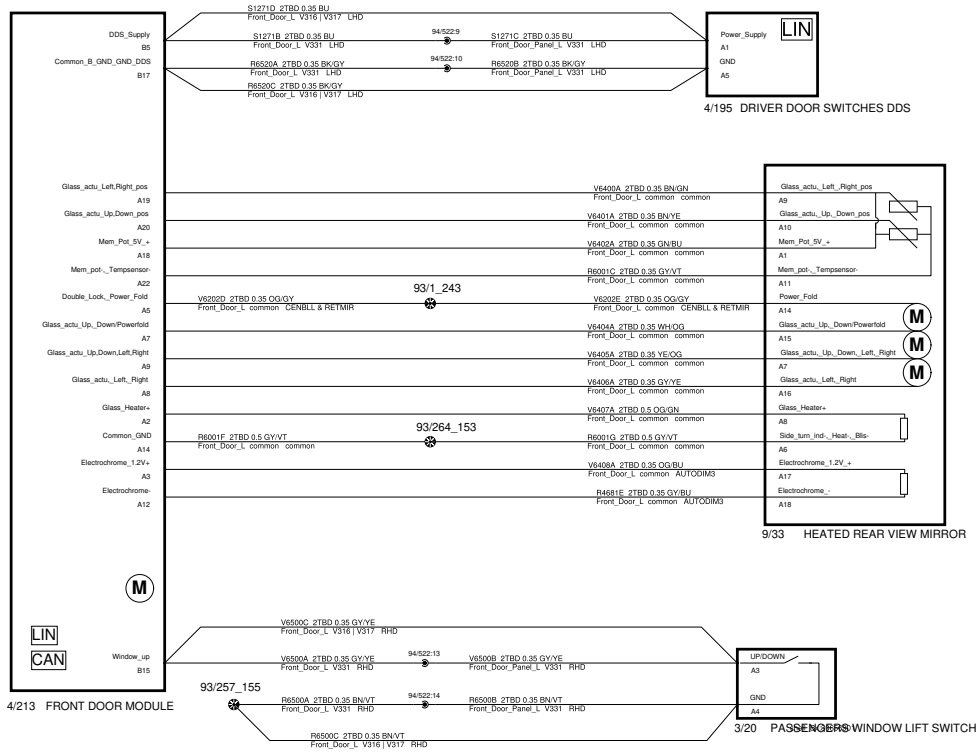

<p>The copying, distribution and utilization of this document as well as the communication of its contents to others without expressed authorization is prohibited. Offenders will be held liable for payment of damages. All rights reserved in the event of the grant of a patent, utility model or ornamental design registration.</p> <p><b>VOLVO</b> VOLVO CAR CORPORATION</p>	<b>Document title</b> 623A_PP_CC_04_06_2023	
	6D_Window_Manoeuving	
	<b>Document Type</b> DRAW/ELSY	<b>Release Status</b> RELEASED
	Volvo Document No 33445458	<b>Edited</b> April/16/2023
	<b>Issue</b> 035	<b>Page No</b> 112/146

# 6D Window manoeuvring Right 6E Mirror manoeuvring Right

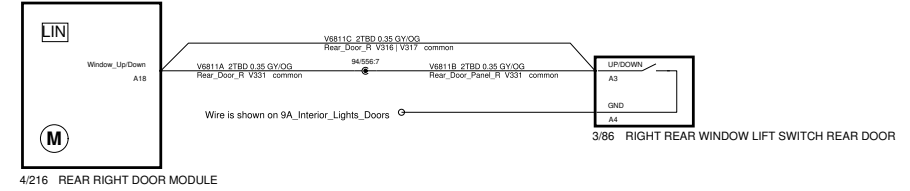
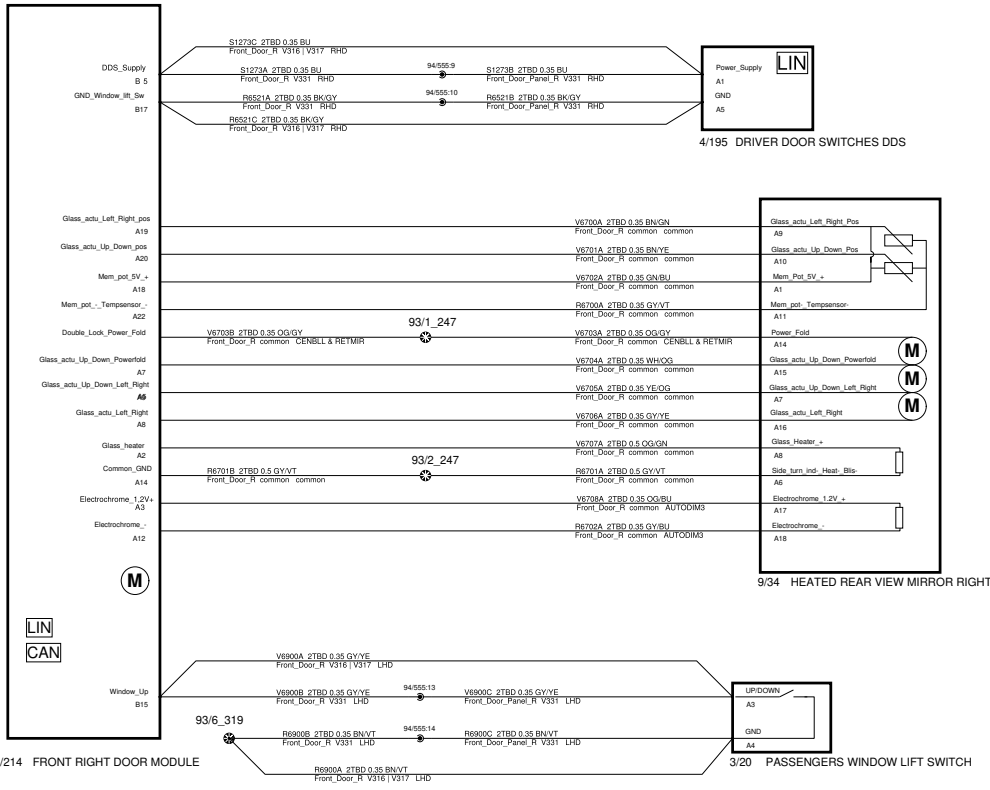

<p>The copying, distribution and utilization of this document as well as the communication of its contents to others without expressed authorization is prohibited. Offenders will be held liable for payment of damages. All rights reserved in the event of the grant of a patent, utility model or ornamental design registration.</p> <p><b>VOLVO</b> VOLVO CAR CORPORATION</p>	<p><b>Document title</b> 623A_PP_CC_04_06_2023 6D_Window_Manoevring_Right</p>	
	<p><b>Document Type</b> DRAW/ELSY</p>	<p><b>Release Status</b> RELEASED</p>
	<p>CEVT Document No 8888522365</p>	<p><b>Edited</b> April/16/2023</p>
	<p><b>Issue</b> 035</p>	<p><b>Page No</b> 113/146</p>

# 6F Roof Manoeuvring

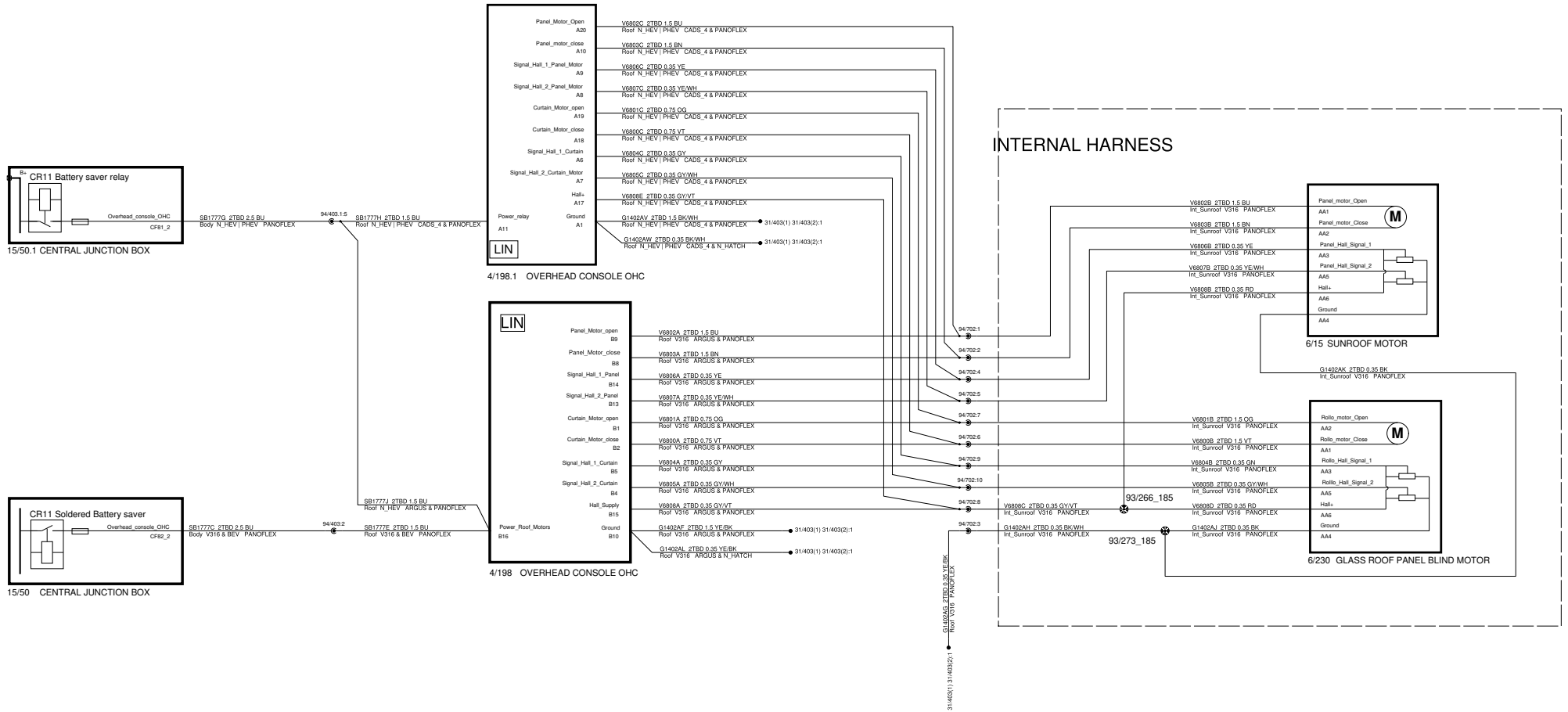

<p>The copying, distribution and utilization of this document as well as the communication of its contents to others without expressed authorization is prohibited. Offenders will be held liable for payment of damages. All rights reserved in the event of the grant of a patent, utility model or ornamental design registration.</p> <p><b>VOLVO</b> VOLVO CAR CORPORATION</p>	<b>Document title</b> 623A_PP_CC_04_06_2023	
	6F_Roof_Manoeuvring	
	<b>Document Type</b> DRAW/ELSY	<b>Release Status</b> RELEASED
	CEVT Document No 8888522365	<b>Edited</b> June/16/2021
	<b>Issue</b> 035	<b>Page No</b> 114/146

# 6K Tailgate & Boot Lid Manoeuvring 6N Luggage Concealing

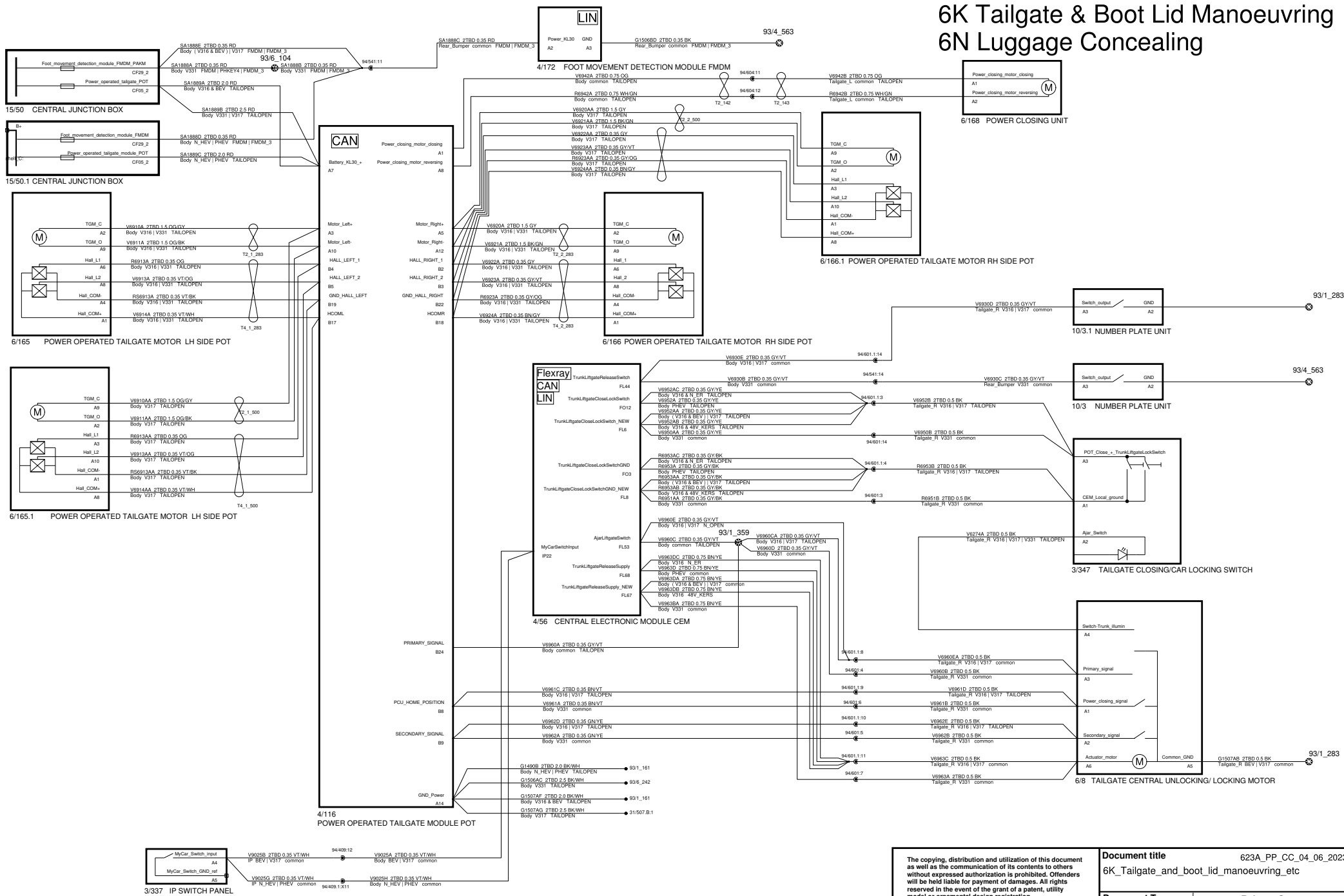

<p>The copying, distribution and utilization of this document as well as the communication of its contents to others without expressed authorization is prohibited. Offenders will be held liable for payment of damages. All rights reserved in the event of the grant of a patent, utility model or ornamental design registration.</p>		<p>Document title 6K_Tailgate_and_boot_lid_manoeuvring_etc</p>	
<p>Document Type DRAW/ELSY</p>		<p>Release Status RELEASED</p>	
<p>Volvo Document No 33445458</p>		<p>Edited April/16/2023</p>	
<p>Issue 035</p>		<p>Page No 115/146</p>	

**VOLVO**  
VOLVO CAR CORPORATION

A  
B  
C  
D  
E  
F

A  
B  
C  
D  
E  
F

# 6P Voltage Outlet

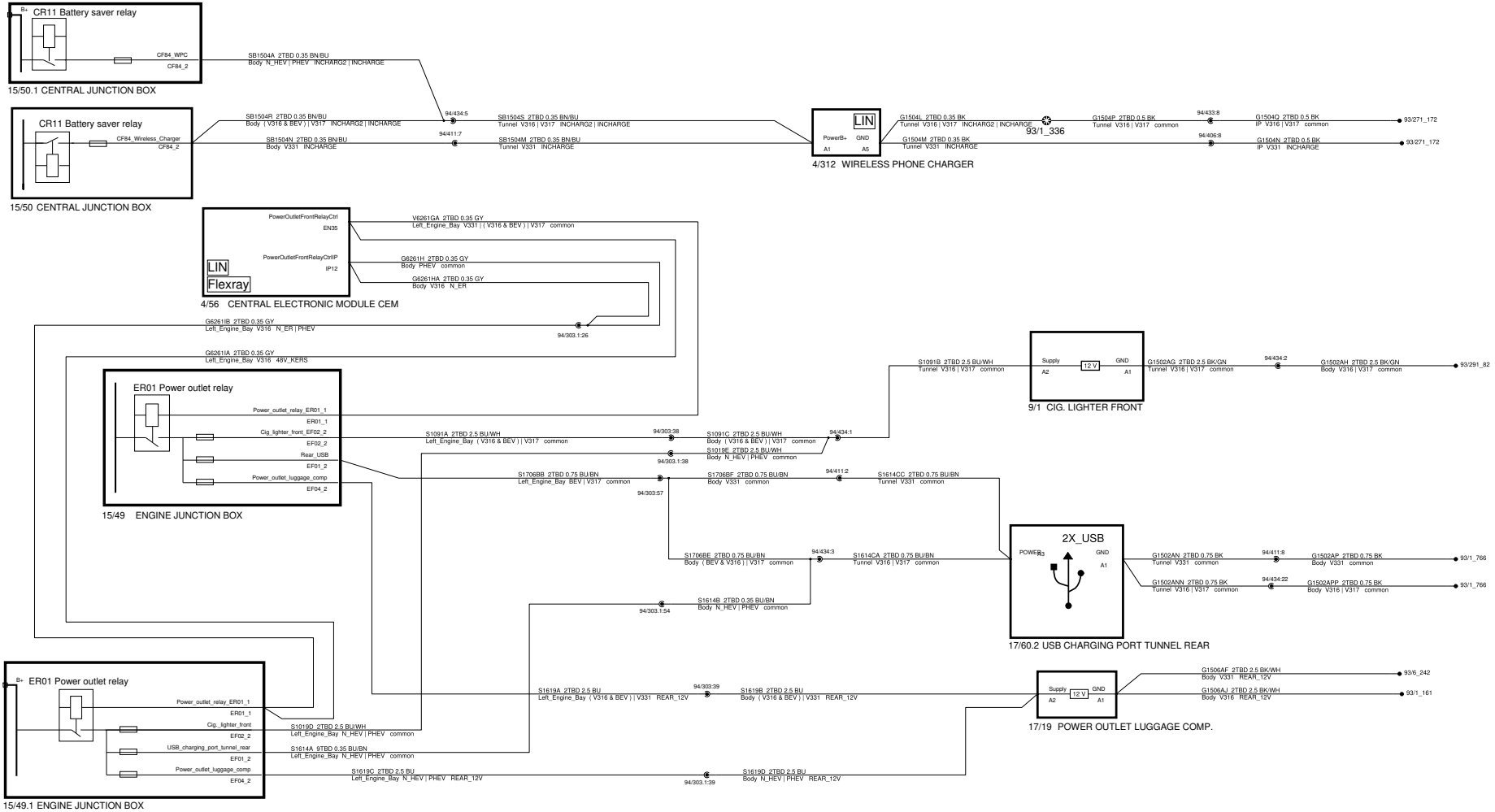

<p>The copying, distribution and utilization of this document as well as the communication of its contents to others without expressed authorization is prohibited. Offenders will be held liable for payment of damages. All rights reserved in the event of the grant of a patent, utility model or ornamental design registration.</p> <p><b>VOLVO</b> VOLVO CAR CORPORATION</p>	<b>Document title</b>		623A_PP_CC_04_06_2023
	6P_Voltage_outlet		
	<b>Document Type</b>	<b>Release Status</b>	
	DRAW/ELSY	RELEASED	
Volvo Document No 33445458		<b>Edited</b> April/16/2023	
<b>Issue</b> 035		<b>Page No</b> 116/146	

# 7A External Amplifier

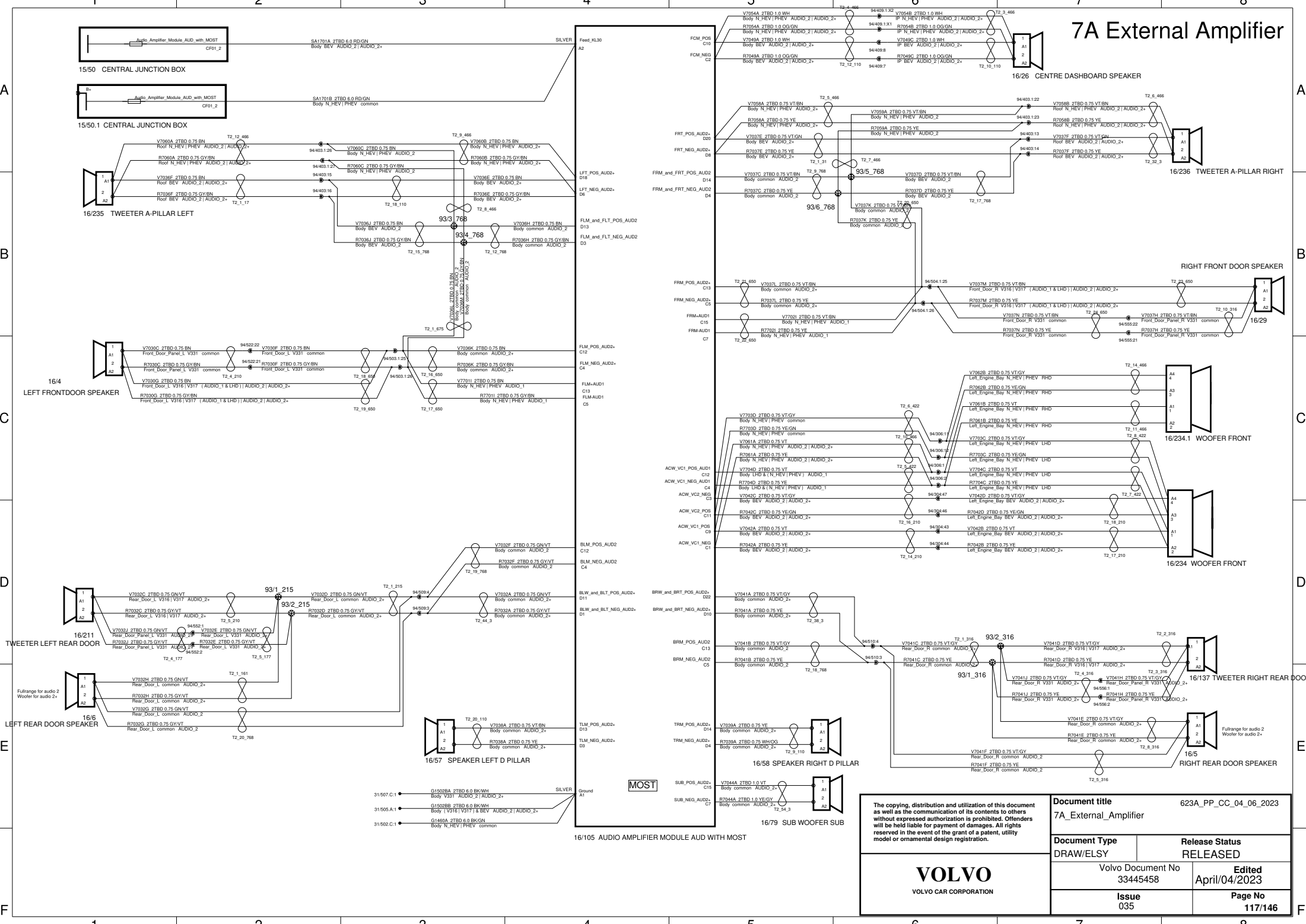

The copying, distribution and utilization of this document as well as the communication of its contents to others without expressed authorization is prohibited. Offenders will be held liable for payment of damages. All rights reserved in the event of the grant of a patent, utility model or ornamental design registration.

**Document title** 7A\_External\_Amplifier

**623A\_PP\_CC\_04\_06\_2023**

Document Type	Release Status
DRAW/ELSY	RELEASED
Volvo Document No 33445458	Edited April/04/2023
Issue 035	Page No 117/146

**VOLVO**  
VOLVO CAR CORPORATION

# 7A Infotainment IHU 3.0/N\_iCUP

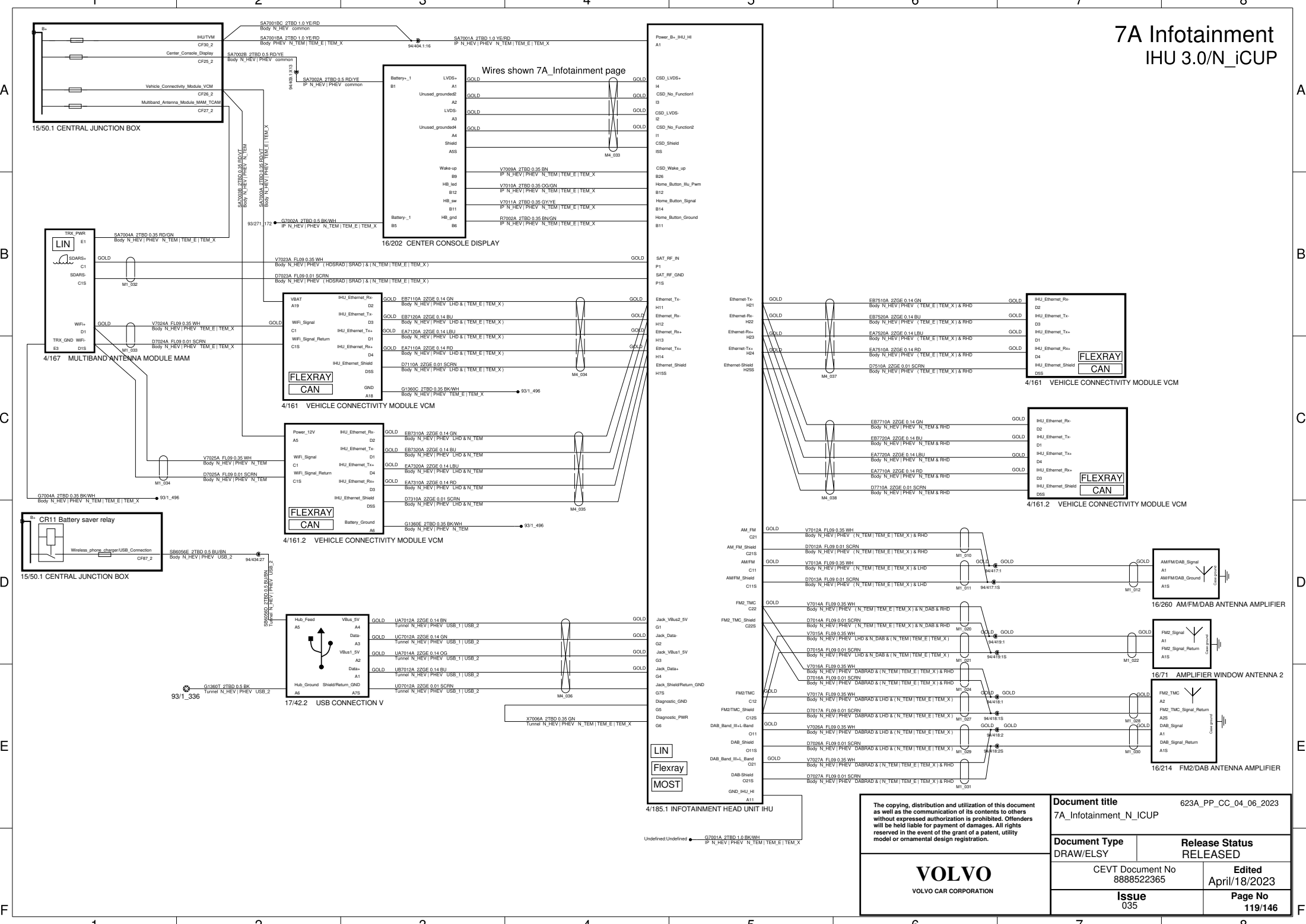

The copying, distribution and utilization of this document as well as the communication of its contents to others without expressed authorization is prohibited. Offenders will be held liable for payment of damages. All rights reserved in the event of the grant of a patent, utility model or ornamental design registration.

<b>Document title</b> 7A_Infotainment_N_ICUP		623A_PP_CC_04_06_2023	
<b>Document Type</b> DRAW/ELSY		<b>Release Status</b> RELEASED	
CEVT Document No 8888522365		Edited April/18/2023	
<b>Issue</b> 035		Page No 119/146	

**VOLVO**  
VOLVO CAR CORPORATION

Undefined/Undefind ● G7001A 2TRBD 1.0 BK/W/H  
IP\_N.HEV1|PHEV\_N\_TEM|TEM\_E|TEM\_X

# 7A Infotainment IHU 4.0/iCUP

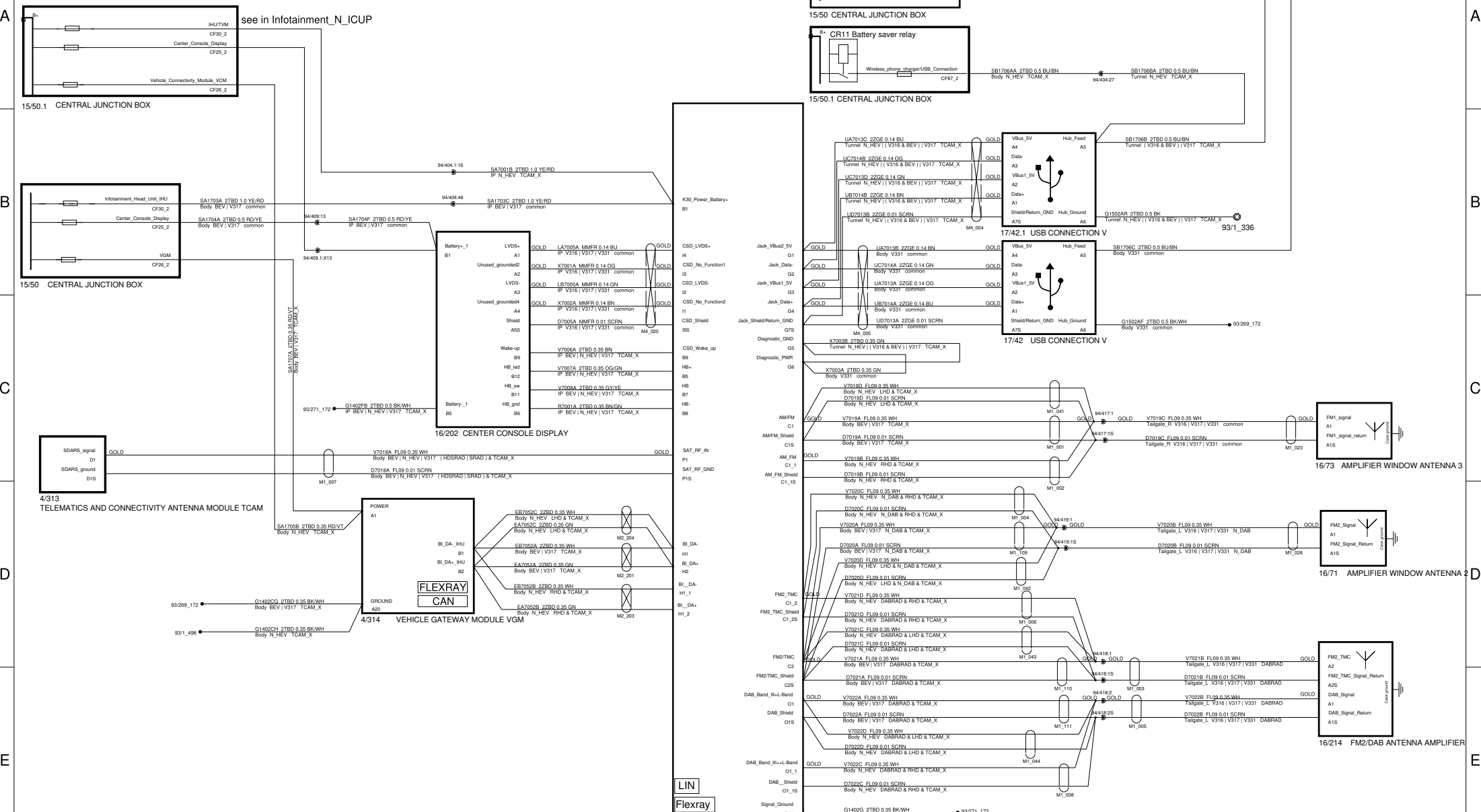

<p>The copying, distribution and utilization of this document as well as the communication of its contents to others without expressed authorization is prohibited. Offenders will be held liable for payment of damages. All rights reserved in the event of the grant of a patent, utility model or ornamental design registration.</p>		<p>Document title 7A_Infotainment</p>	<p>623A_PP_CC_04_06_2023</p>
<p>Document Type DRAW/ELSY</p>	<p>Volvo Document No 33445458</p>	<p>Release Status RELEASED</p>	
<p>Issue 035</p>	<p>Page No 118/146</p>	<p>Edited April/18/2023</p>	

**VOLVO**  
VOLVO CAR CORPORATION



# 7B Telematics

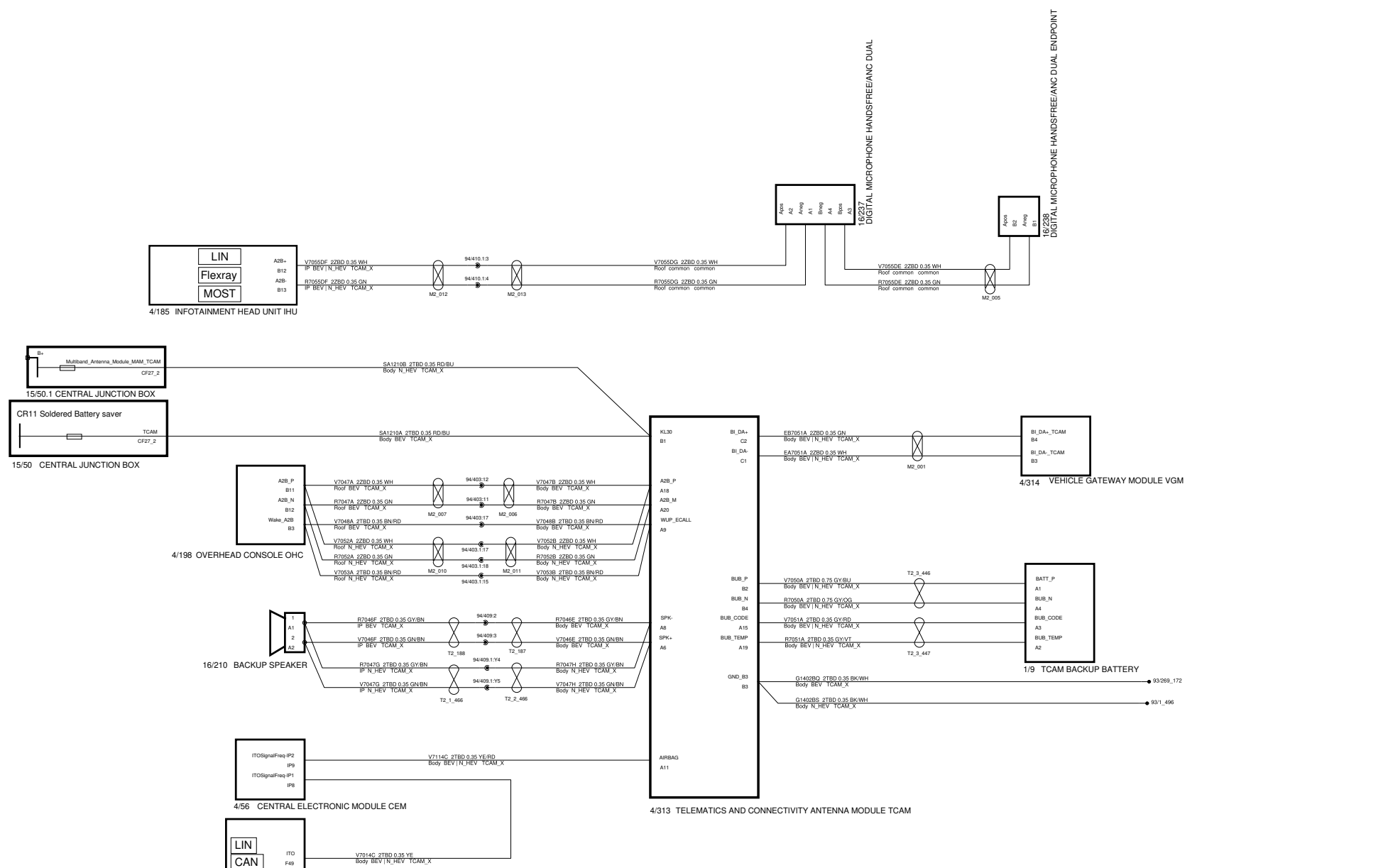

<p>The copying, distribution and utilization of this document as well as the communication of its contents to others without expressed authorization is prohibited. Offenders will be held liable for payment of damages. All rights reserved in the event of the grant of a patent, utility model or ornamental design registration.</p> <p><b>VOLVO</b> VOLVO CAR CORPORATION</p>	<b>Document title</b> 623A_PP_CC_04_06_2023	
	7B_Telematics_ICUP	
	<b>Document Type</b> DRAW/ELSY	<b>Release Status</b> RELEASED
	Volvo Document No 33445458	<b>Edited</b> April/18/2023
<b>Issue</b> 035	<b>Page No</b> 120/146	

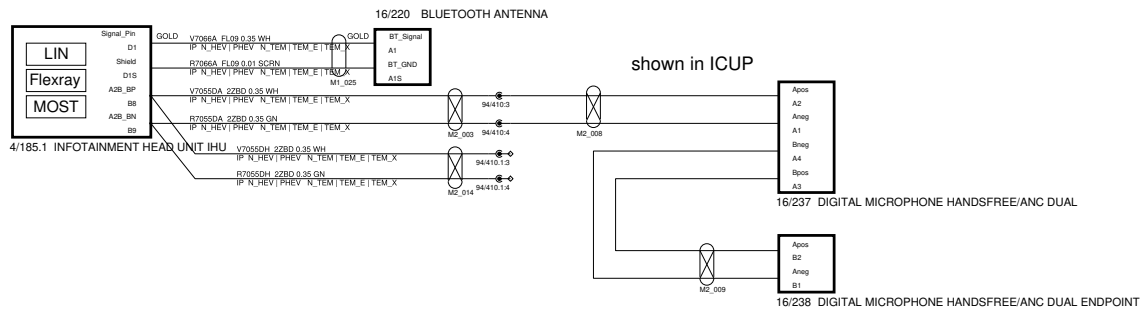
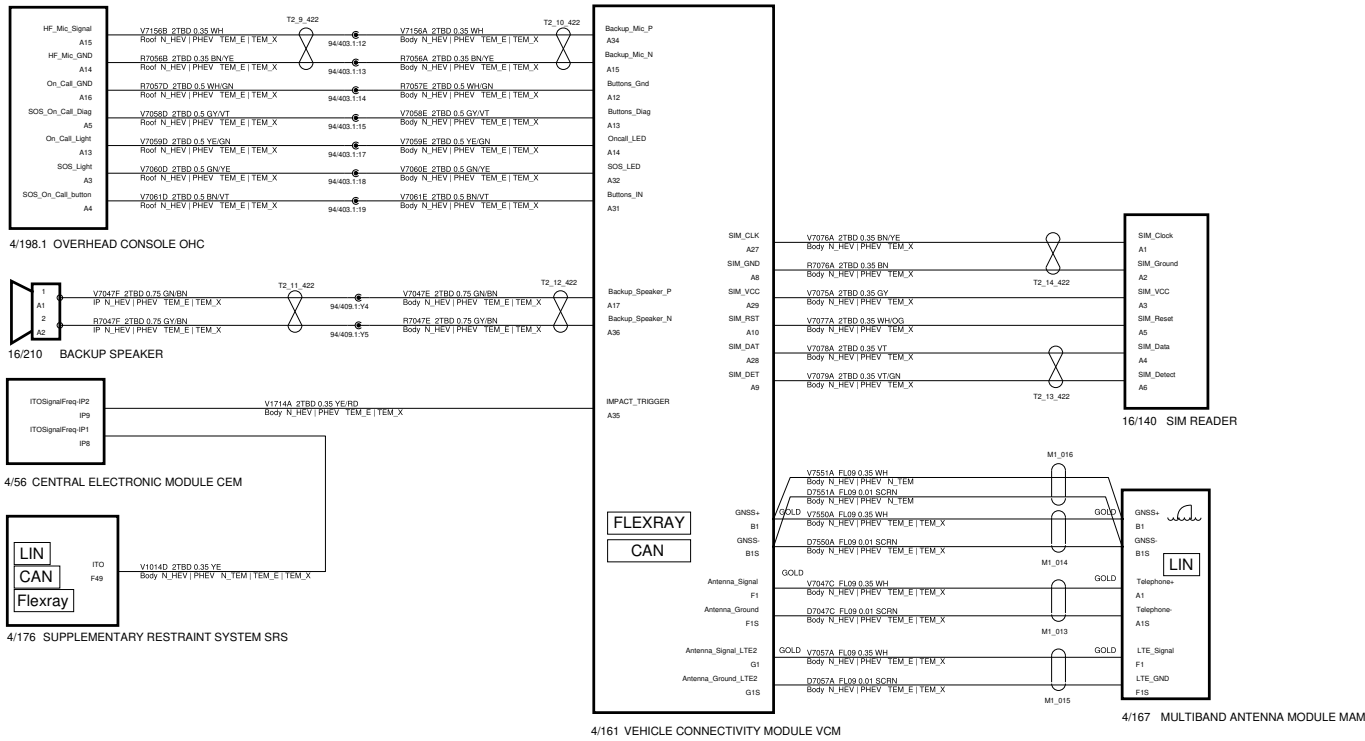

<p><b>VOLVO</b> VOLVO CAR CORPORATION</p>	<p>The copying, distribution and utilization of this document as well as the communication of its contents to others without expressed authorization is prohibited. Offenders will be held liable for payment of damages. All rights reserved in the event of the grant of a patent, utility model or ornamental design registration.</p>		<p><b>Document title</b> 7B_Telematics_N_ICUP</p>	<p>623A_PP_CC_04_06_2023</p>
	<p><b>Document Type</b> DRAW/ELSY</p>	<p><b>Release Status</b> RELEASED</p>		
	<p>CEVT Document No 8888522365</p>		<p><b>Edited</b> April/18/2023</p>	
	<p><b>Issue</b> 035</p>		<p><b>Page No</b> 121/146</p>	

# 7C DSRC IHU 3.0/\_NiCUP

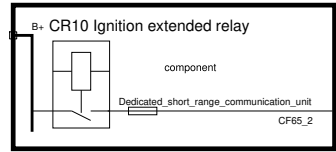

15/50.1 CENTRAL JUNCTION BOX

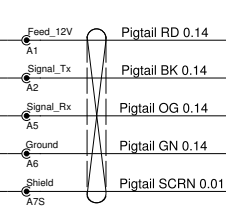
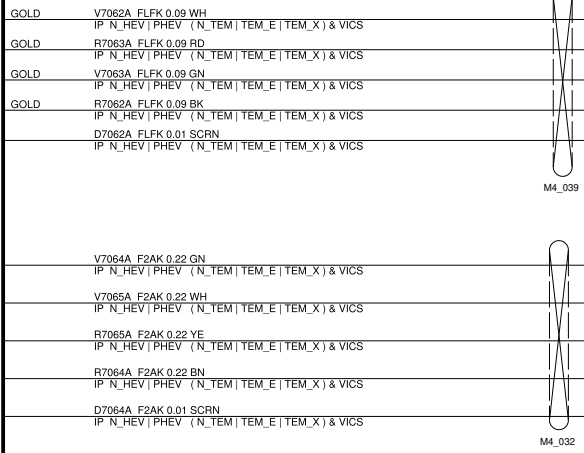
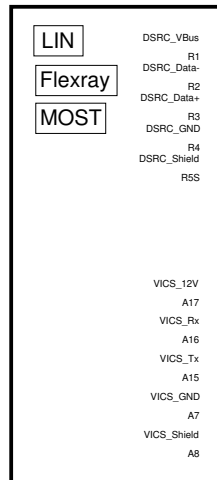
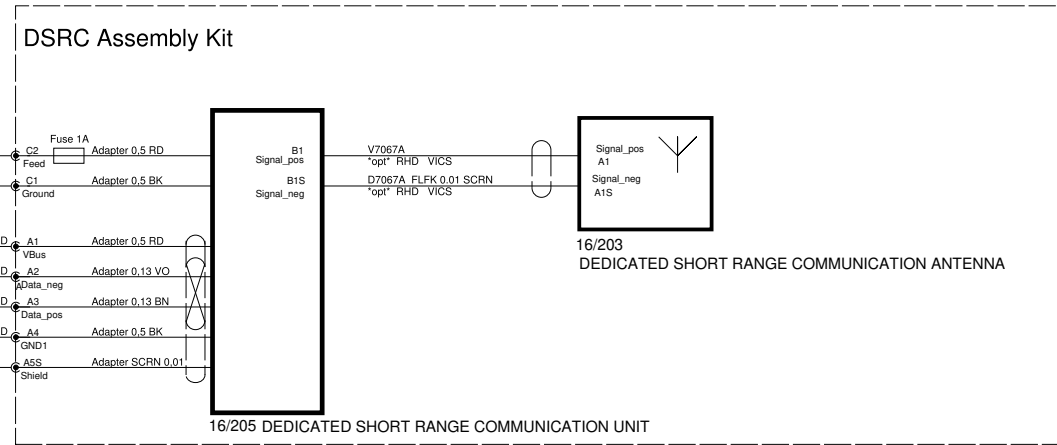

<p>The copying, distribution and utilization of this document as well as the communication of its contents to others without expressed authorization is prohibited. Offenders will be held liable for payment of damages. All rights reserved in the event of the grant of a patent, utility model or ornamental design registration.</p> <p><b>VOLVO</b> VOLVO CAR CORPORATION</p>	<p><b>Document title</b> 623A_PP_CC_04_06_2023 7C_DSRC_N_iCUP</p>	
	<p><b>Document Type</b> DRAW/ELSY</p>	<p><b>Release Status</b> RELEASED</p>
	<p>CEVT Document No 8888522365</p>	<p><b>Edited</b> April/18/2023</p>
	<p><b>Issue</b> 035</p>	<p><b>Page No</b> 123/146</p>

# 7C DSRC IHU 4.0/iCUP

A

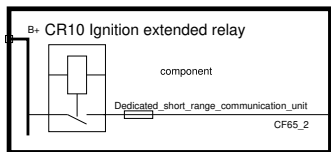

15/50.1 CENTRAL JUNCTION BOX

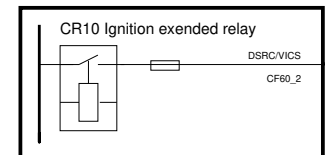

15/50 CENTRAL JUNCTION BOX

B

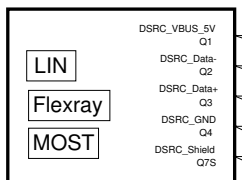

4/185  
INFOTAINMENT HEAD UNIT IHU

C

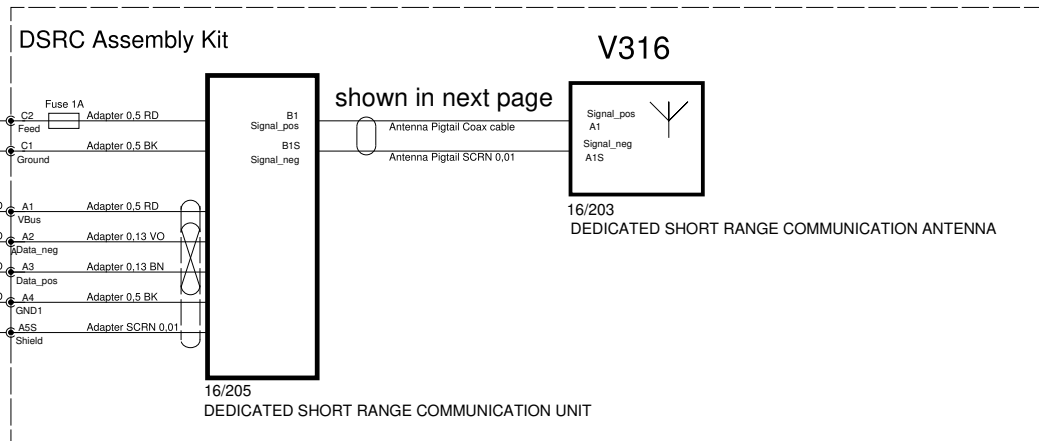

D

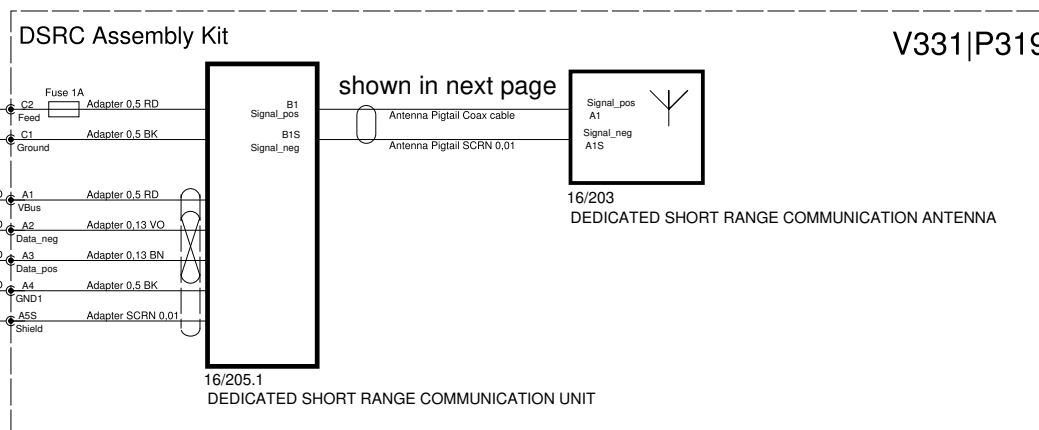

E

<p>The copying, distribution and utilization of this document as well as the communication of its contents to others without expressed authorization is prohibited. Offenders will be held liable for payment of damages. All rights reserved in the event of the grant of a patent, utility model or ornamental design registration.</p> <p><b>VOLVO</b> VOLVO CAR CORPORATION</p>	<b>Document title</b> 623A_PP_CC_04_06_2023	
	7C_DSRC	
	<b>Document Type</b> DRAW/ELSY	<b>Release Status</b> RELEASED
	CEVT Document No 8888522365	<b>Edited</b> April/18/2023
	<b>Issue</b> 035	<b>Page No</b> 122/146

1

2

3

4

5

# 7F Electronic Toll Collection

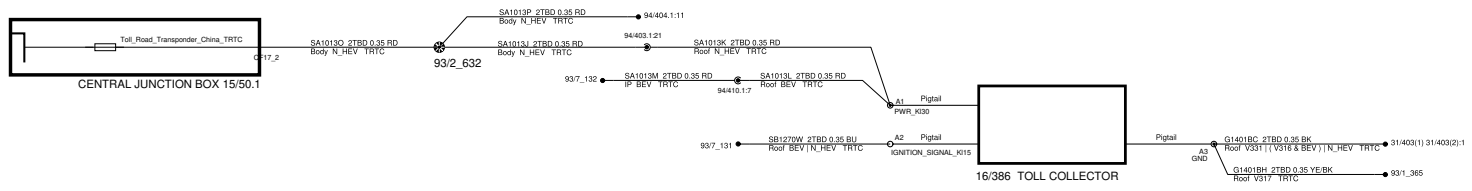

<p>The copying, distribution and utilization of this document as well as the communication of its contents to others without expressed authorization is prohibited. Offenders will be held liable for payment of damages. All rights reserved in the event of the grant of a patent, utility model or ornamental design registration.</p> <p><b>VOLVO</b> VOLVO CAR CORPORATION</p>	<b>Document title</b> 623A_PP_CC_04_06_2023 7F_Electronic_Toll_Collection	
	<b>Document Type</b> DRAW/ELSY	<b>Release Status</b> RELEASED
	CEVT Document No 8888522365	<b>Edited</b> April/18/2023
	<b>Issue</b> 035	<b>Page No</b> 124/146

# 8A Exterior Light Front

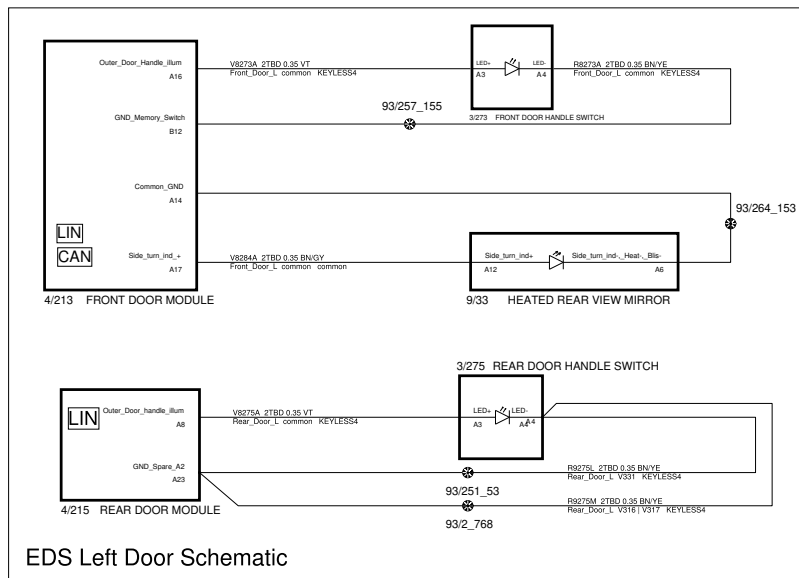
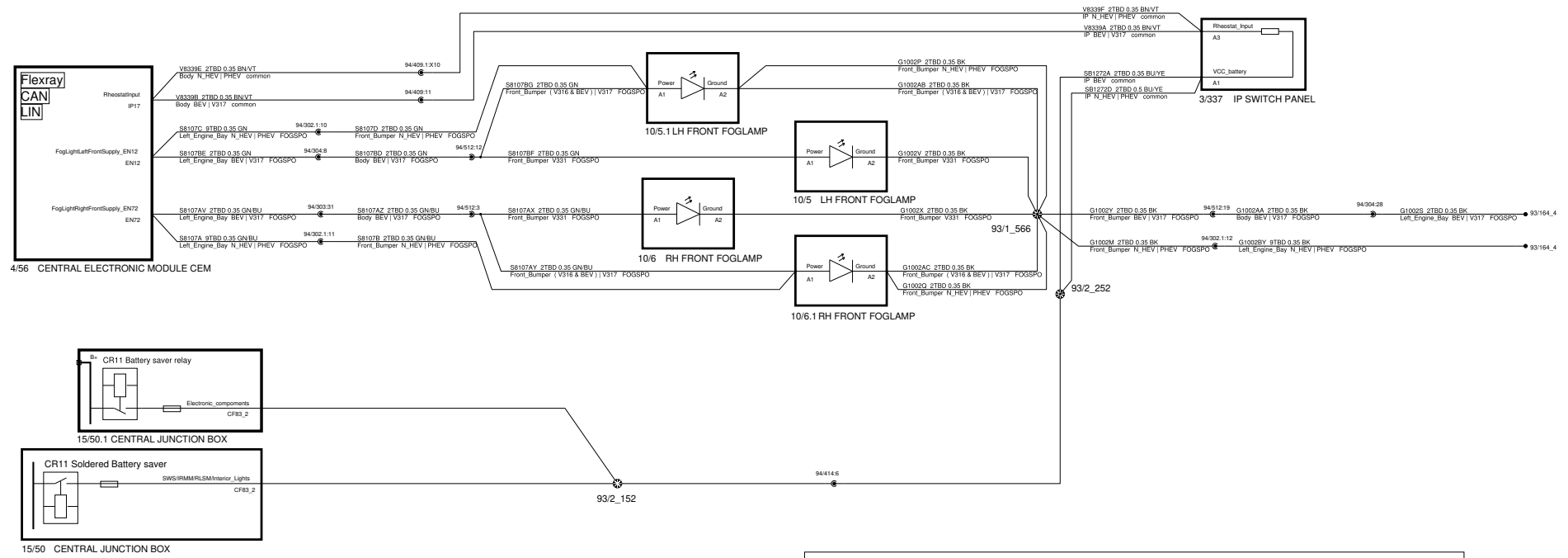

EDS Left Door Schematic

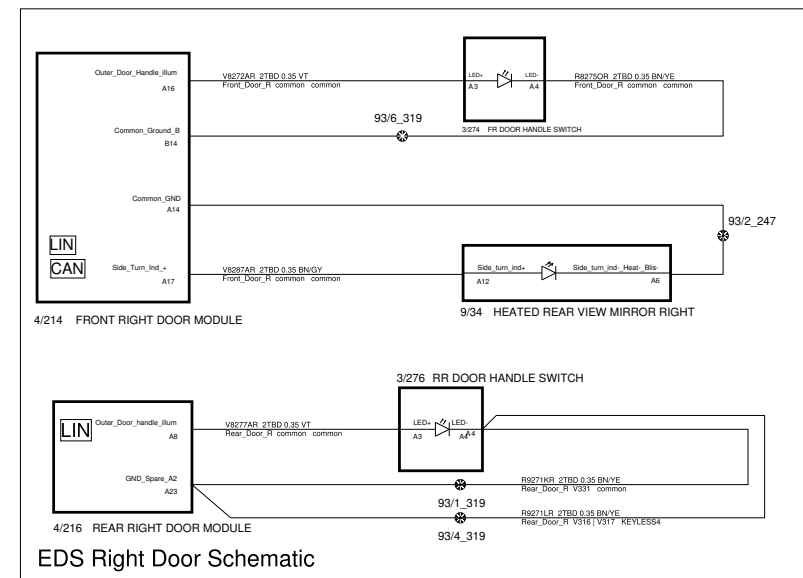

EDS Right Door Schematic

The copying, distribution and utilization of this document as well as the communication of its contents to others without expressed authorization is prohibited. Offenders will be held liable for payment of damages. All rights reserved in the event of the grant of a patent, utility model or ornamental design registration.

**VOLVO**  
VOLVO CAR CORPORATION

Document title  
8A\_Exterior\_Light\_Front

623A\_PP\_CC\_04\_06\_2023

Document Type

Release Status

DRAW/ELSY

RELEASED

Volvo Document No  
33445458

Edited  
April/18/2023

Issue  
035

Page No  
125/146

# 8A Exterior Light LED Front

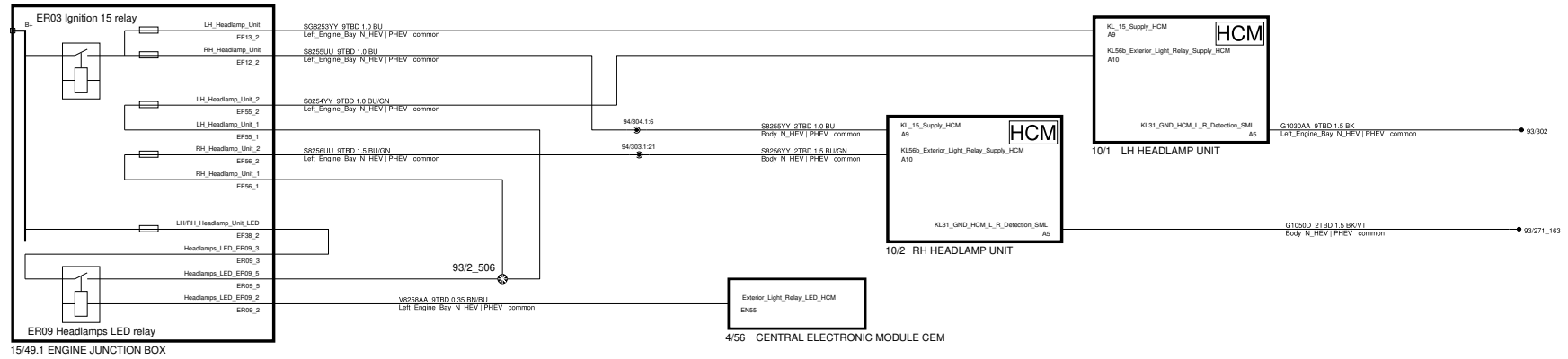
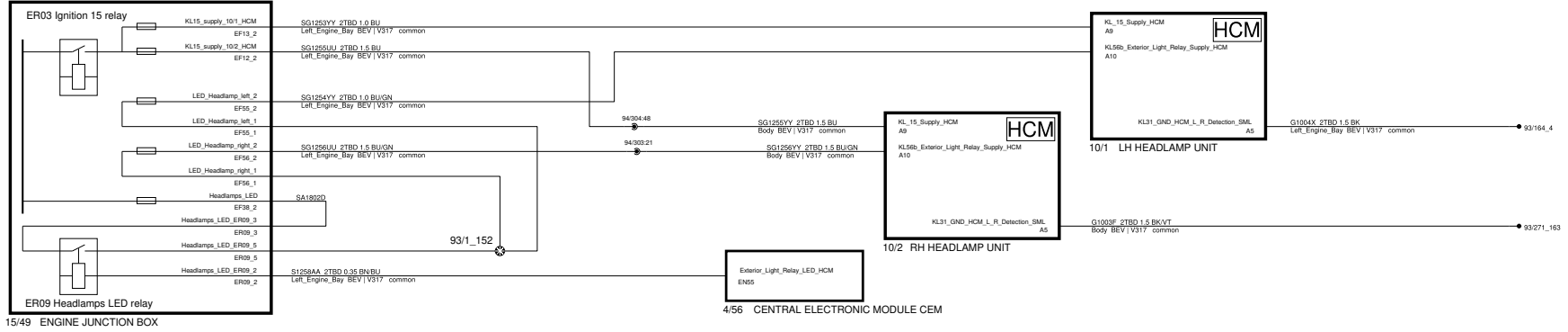

<p>The copying, distribution and utilization of this document as well as the communication of its contents to others without expressed authorization is prohibited. Offenders will be held liable for payment of damages. All rights reserved in the event of the grant of a patent, utility model or ornamental design registration.</p> <p><b>VOLVO</b> VOLVO CAR CORPORATION</p>	<b>Document title</b> 623A_PP_CC_04_06_2023	
	8A_Exterior_Light_LED_Front	
	<b>Document Type</b> DRAW/ELSY	<b>Release Status</b> RELEASED
	Volvo Document No 33445458	<b>Edited</b> April/18/2023
<b>Issue</b> 035	<b>Page No</b> 126/146	

# 8A Exterior Light Rear V316

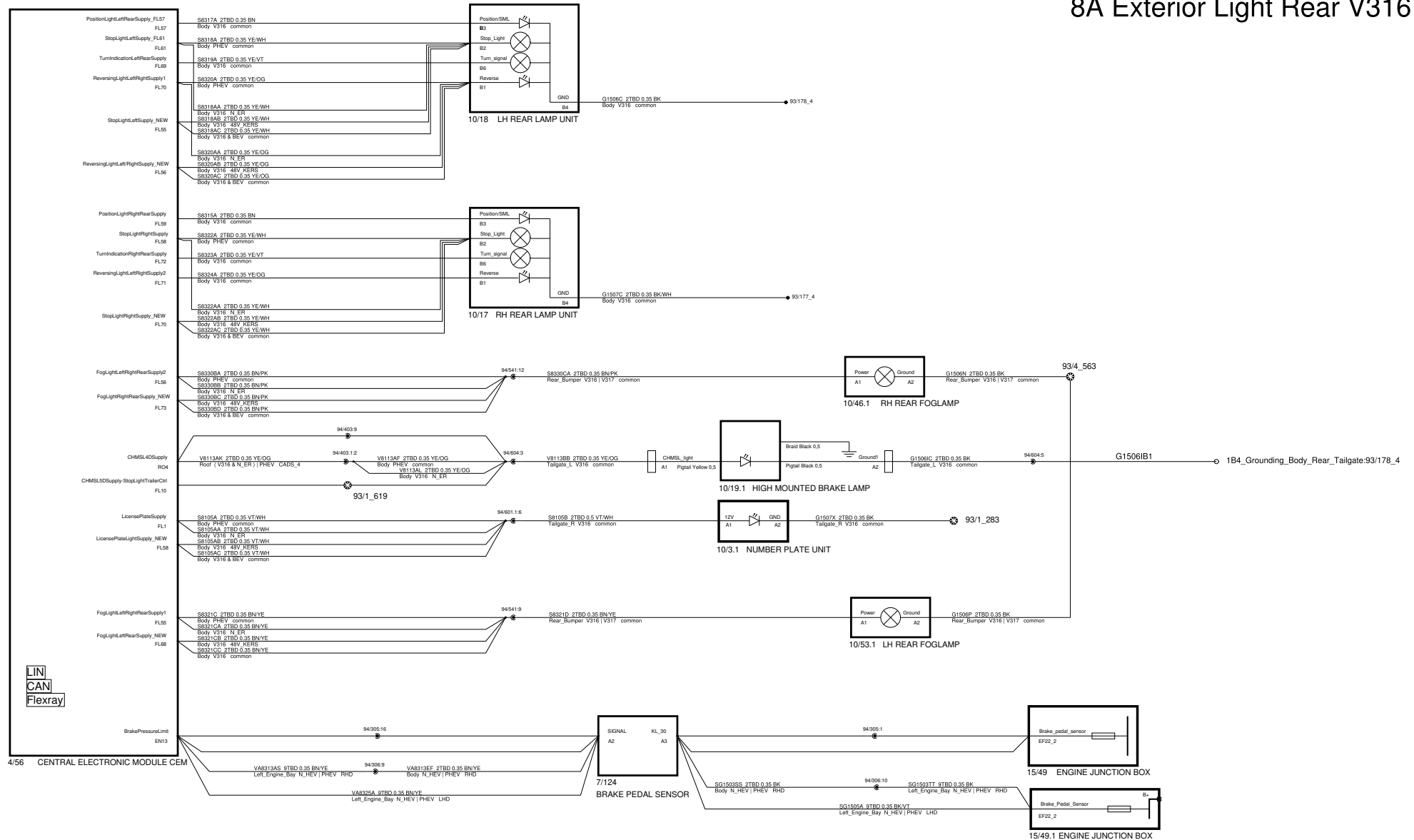

<p>The copying, distribution and utilization of this document as well as the communication of its contents to others without expressed authorization is prohibited. Offenders will be held liable for payment of damages. All rights reserved in the event of the grant of a patent, utility model or ornamental design registration.</p> <p><b>VOLVO</b> VOLVO CAR CORPORATION</p>		<p><b>Document title</b> 623A_PP_CC_04_06_2023 8A_Exterior_Light_Rear_V316</p>	
		<p><b>Document Type</b> DRAW/ELSY</p>	<p><b>Release Status</b> RELEASED</p>
		<p>CEVT Document No 8888522365</p>	<p><b>Edited</b> April/18/2023</p>
		<p><b>Issue</b> 035</p>	<p><b>Page No</b> 127/146</p>



# 8A Exterior Light Rear V331

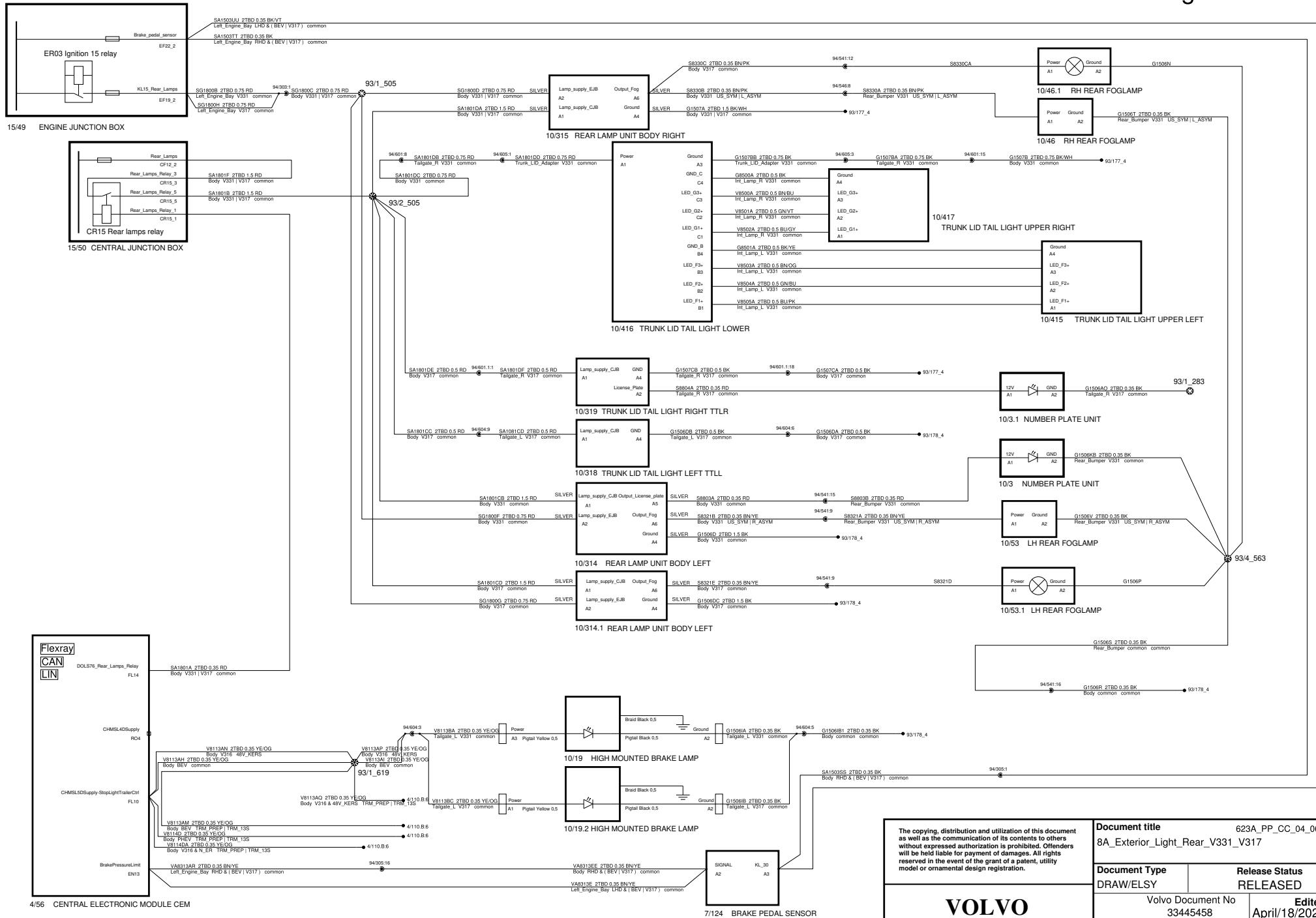

<p>The copying, distribution and utilization of this document as well as the communication of its contents to others without expressed authorization is prohibited. Offenders will be held liable for payment of damages. All rights reserved in the event of the grant of a patent, utility model or ornamental design registration.</p>		<p>Document title 623A_PP_CC_04_06_2023</p>	
		<p>8A_Exterior_Light_Rear_V331_V317</p>	
<p>Document Type DRAW/ELSY</p>		<p>Release Status RELEASED</p>	
<p>Volvo Document No 33445458</p>		<p>Edited April/18/2023</p>	
<p>Issue 035</p>		<p>Page No 128/146</p>	

**VOLVO**  
VOLVO CAR CORPORATION

A

B

C

D

E

F

A

B

C

D

E

F

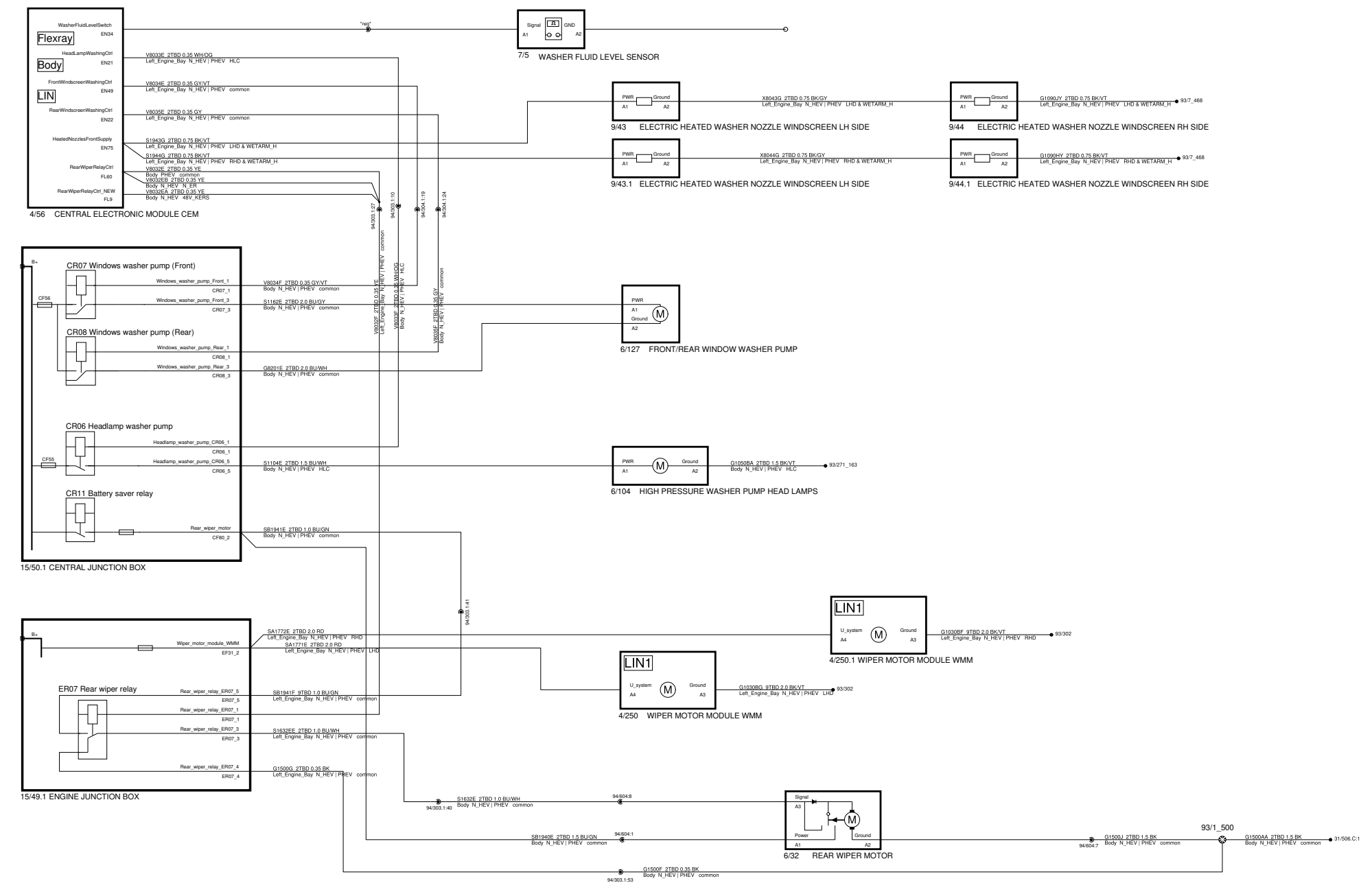

# 8K Lamp cleaning control 8H Windscreen cleaning control 8J Rear window cleaning

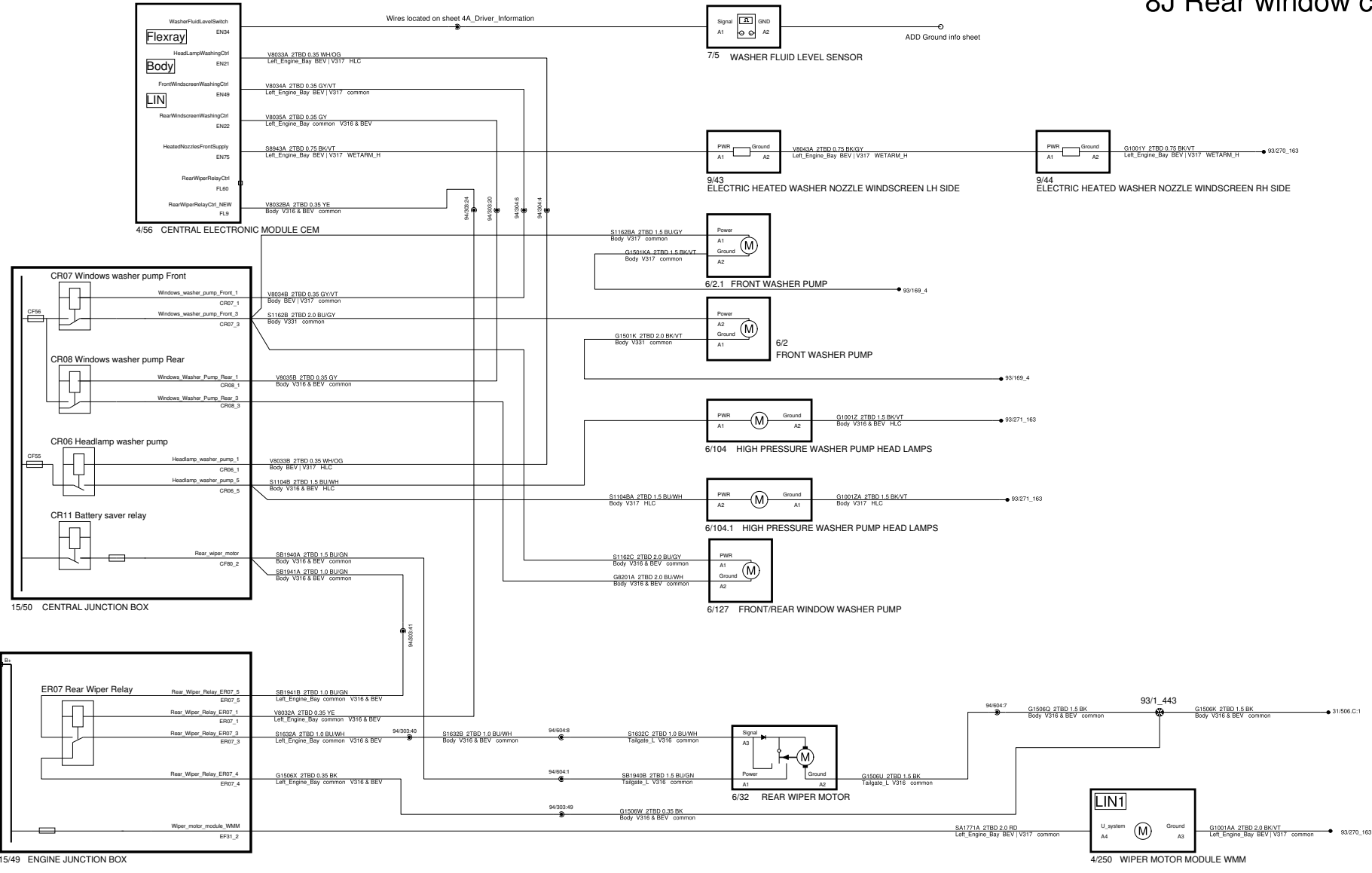

<p>The copying, distribution and utilization of this document as well as the communication of its contents to others without expressed authorization is prohibited. Offenders will be held liable for payment of damages. All rights reserved in the event of the grant of a patent, utility model or ornamental design registration.</p>		<p>Document title 623A_PP_CC_04_06_2023 8K_8H_8J_Lamp_windscreen_rear_window_cleaning</p>	
		<p>Document Type DRAW/ELSY</p>	<p>Release Status RELEASED</p>
<p><b>VOLVO</b> VOLVO CAR CORPORATION</p>		<p>Volvo Document No 33445458</p>	<p>Edited April/18/2023</p>
		<p>Issue 035</p>	<p>Page No 129/146</p>

# 8N Windscreen defroster control 8L Rear window defroster control

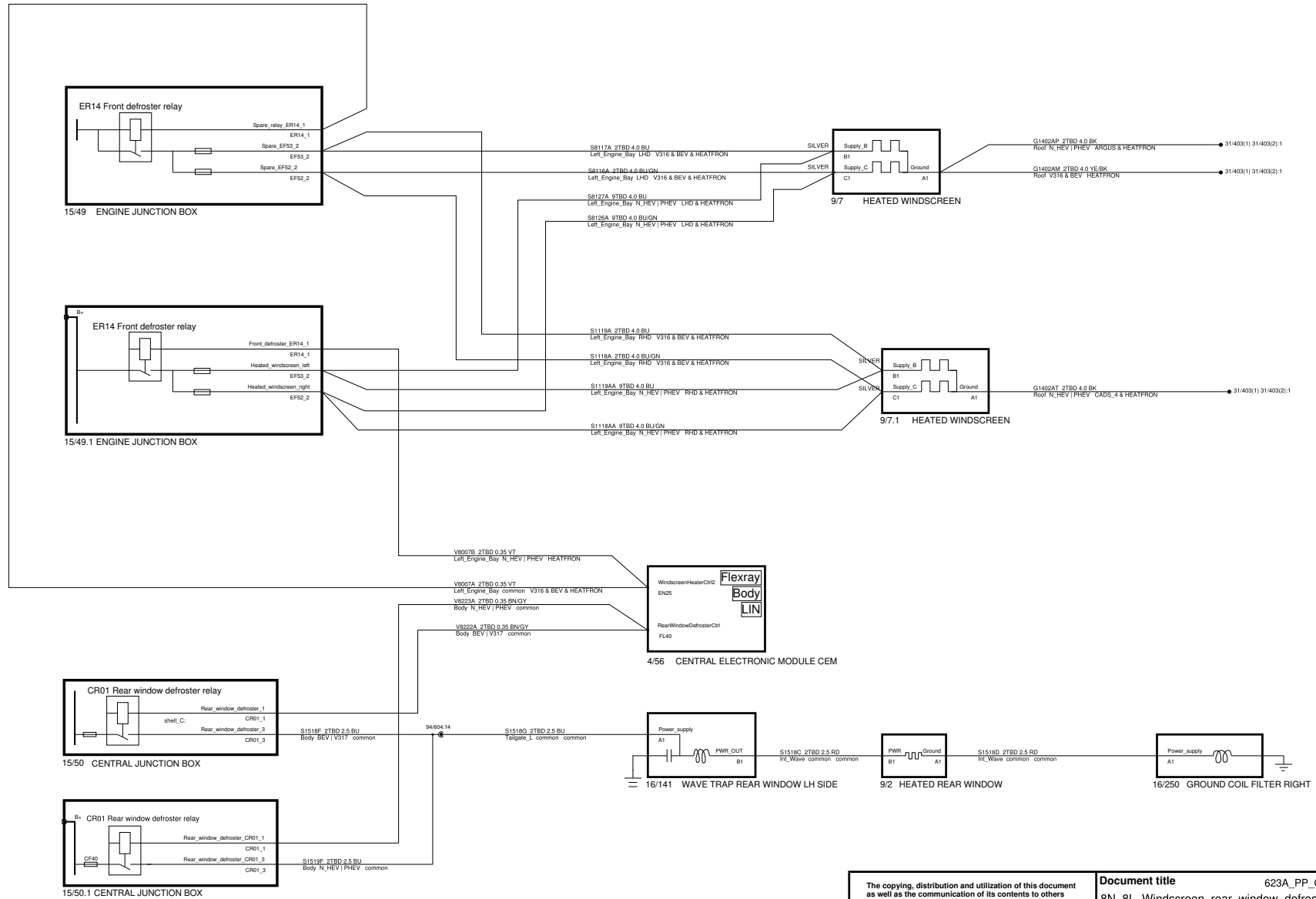

The copying, distribution and utilization of this document as well as the communication of its contents to others without expressed authorization is prohibited. Offenders will be held liable for payment of damages. All rights reserved in the event of the grant of a patent, utility model or ornamental design registration.

**VOLVO**  
VOLVO CAR CORPORATION

<b>Document title</b> 8N_8L_Windscreen_rear_window_defroster		623A_PP_CC_04_06_2023	
<b>Document Type</b> DRAW/ELSY	<b>Release Status</b> RELEASED		
Volvo Document No 33445458		<b>Edited</b> April/18/2023	
<b>Issue</b> 035		<b>Page No</b> 131/146	

# 8P Sound Signaling

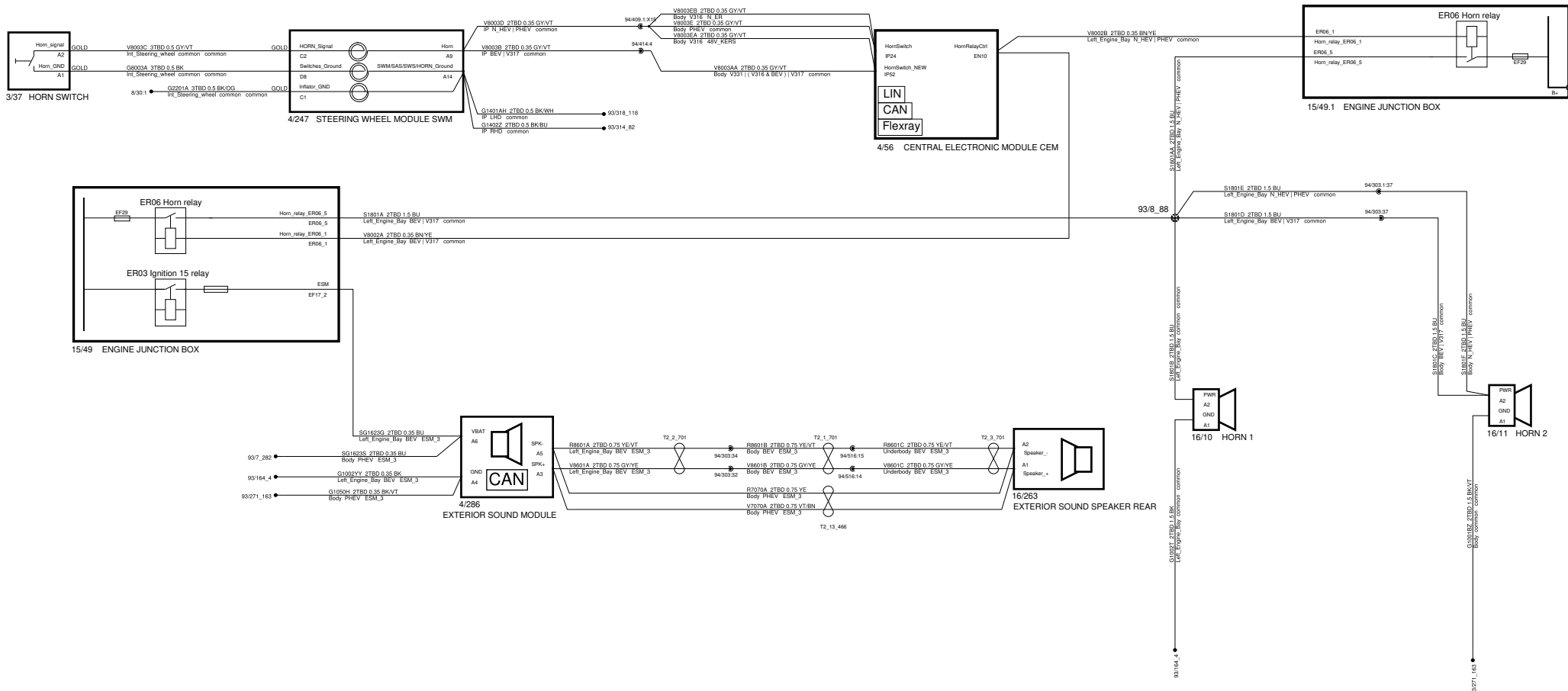

<b>VOLVO</b> VOLVO CAR CORPORATION	<b>Document title</b> 8P_Sound_signaling		623A_PP_CC_04_06_2023
	<b>Document Type</b> DRAW/ELSY		<b>Release Status</b> RELEASED
	Volvo Document No 33445458		Edited April/18/2023
	Issue 035		Page No 132/146

The copying, distribution and utilization of this document as well as the communication of its contents to others without expressed authorization is prohibited. Offenders will be held liable for payment of damages. All rights reserved in the event of the grant of a patent, utility model or ornamental design registration.

# 9A Interior Lights

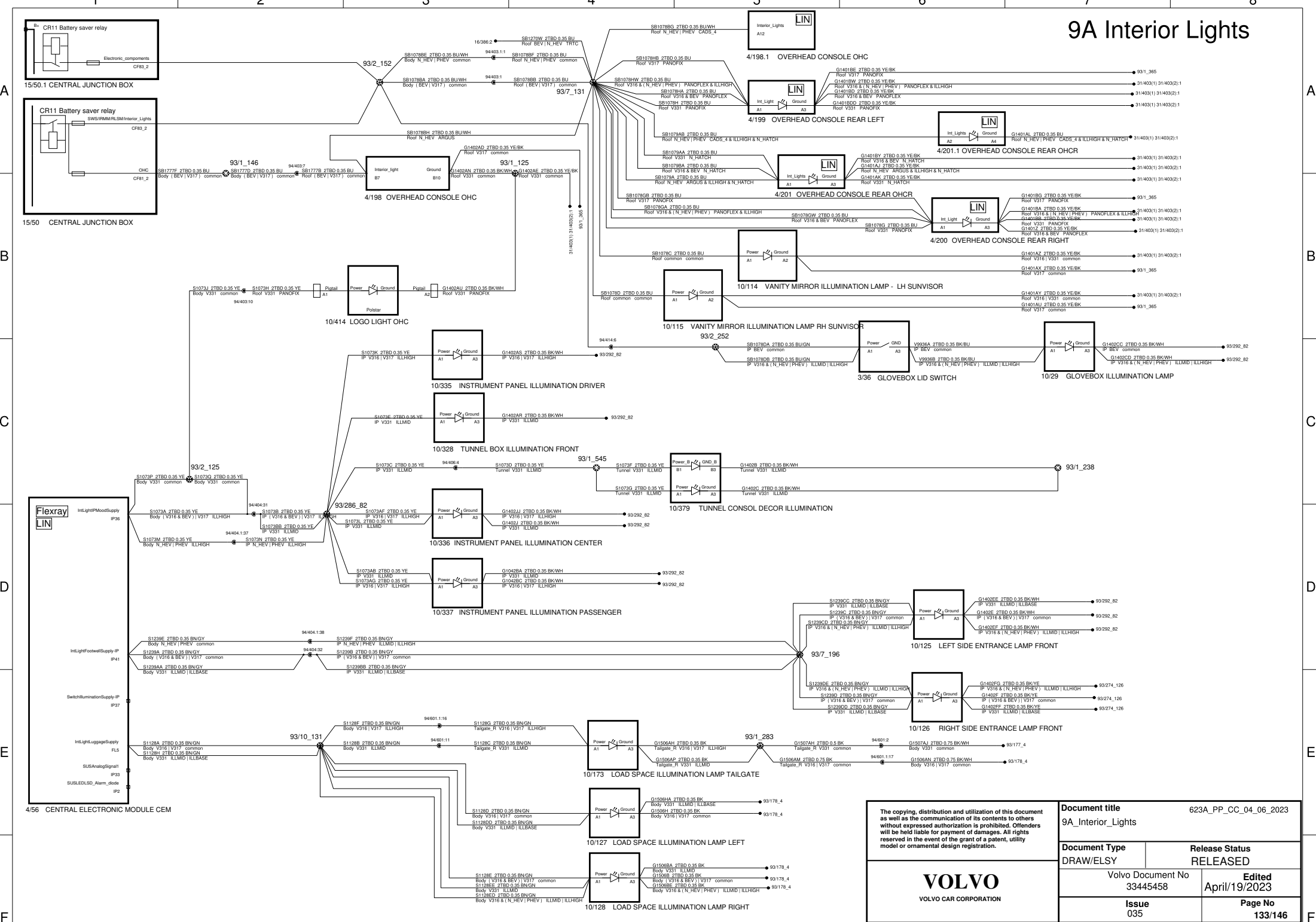

<p>The copying, distribution and utilization of this document as well as the communication of its contents to others without expressed authorization is prohibited. Offenders will be held liable for payment of damages. All rights reserved in the event of the grant of a patent, utility model or ornamental design registration.</p>		Document title	623A_PP_CC_04_06_2023
		9A_Interior_Lights	
Document Type	Release Status		
DRAW/ELSY	RELEASED		
Volvo Document No		Edited	
33445458		April/19/2023	
Issue		Page No	
035		133/146	



# 9A Interior Lights Doors

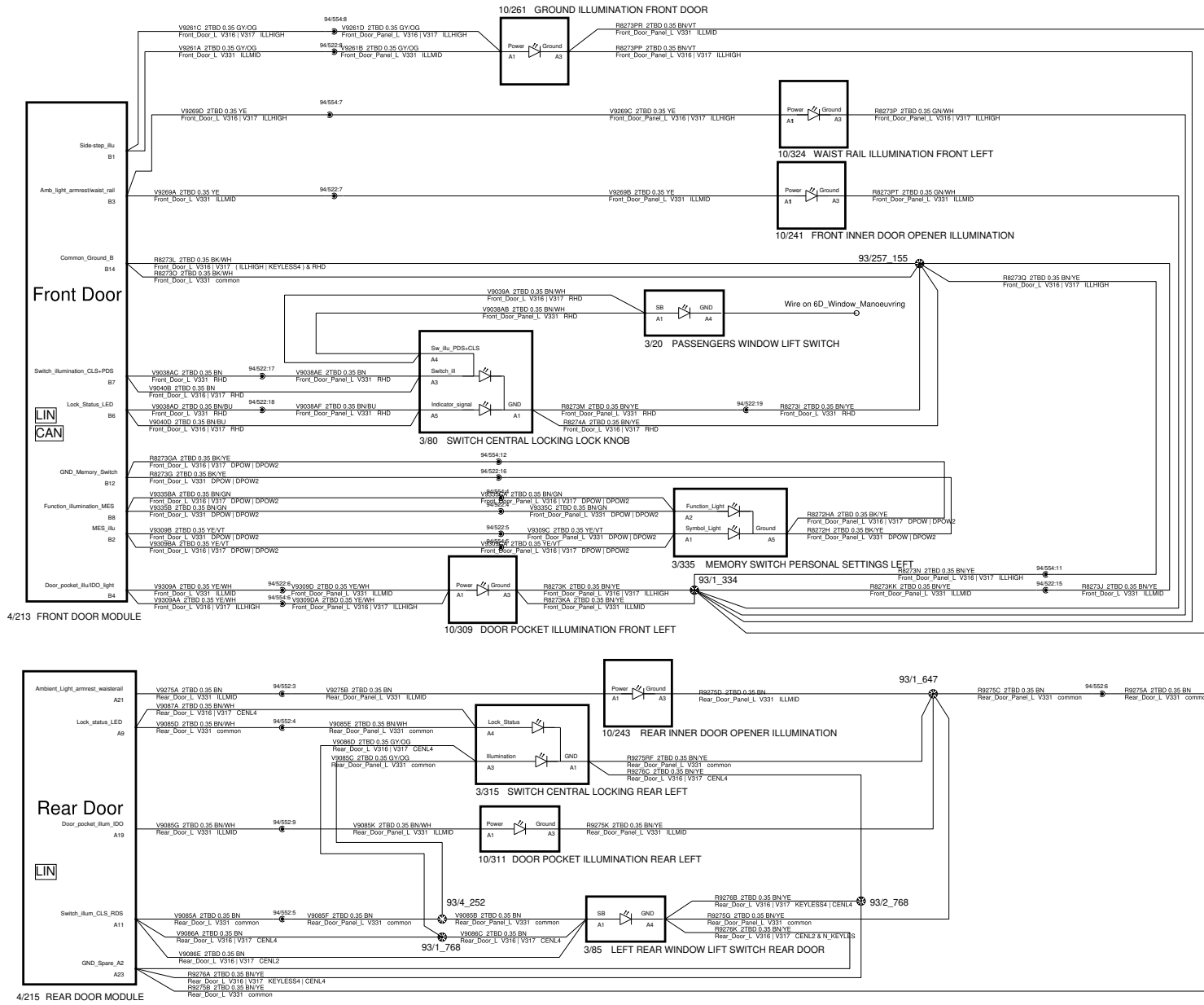

<p>The copying, distribution and utilization of this document as well as the communication of its contents to others without expressed authorization is prohibited. Offenders will be held liable for payment of damages. All rights reserved in the event of the grant of a patent, utility model or ornamental design registration.</p>		<p>Document title 9A_Interior_Lights_Doors</p>		<p>623A_PP_CC_04_06_2023</p>	
		<p>Document Type DRAW/ELSY</p>	<p>Release Status RELEASED</p>		
<p><b>VOLVO</b> VOLVO CAR CORPORATION</p>		<p>Volvo Document No 33445458</p>	<p>Edited April/11/2023</p>		
		<p>Issue 035</p>	<p>Page No 134/146</p>		

# 9A Interior Lights Doors Right

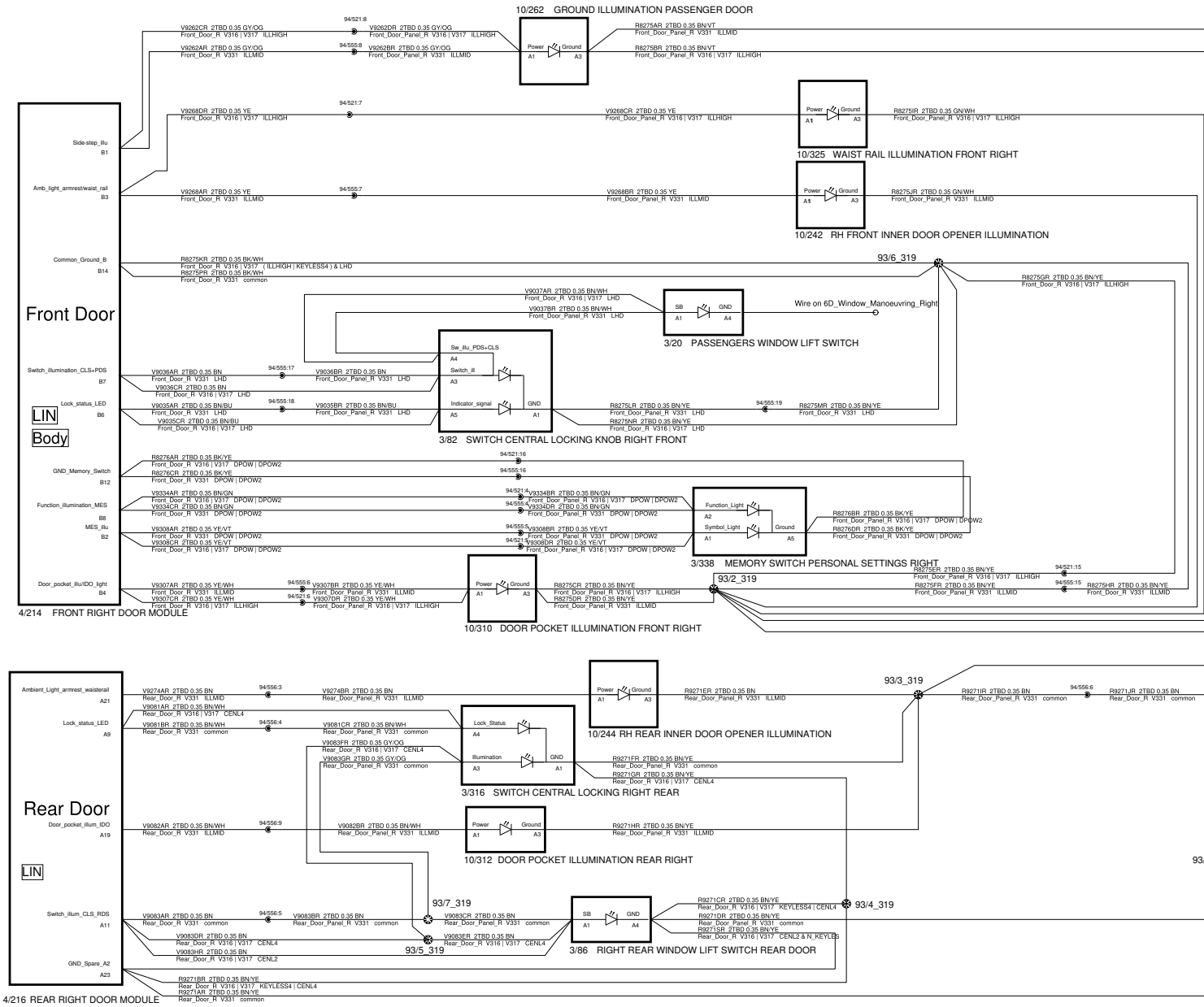

<p>The copying, distribution and utilization of this document as well as the communication of its contents to others without expressed authorization is prohibited. Offenders will be held liable for payment of damages. All rights reserved in the event of the grant of a patent, utility model or ornamental design registration.</p>		<p><b>Document title</b> 623A_PP_CC_04_06_2023 9A_Interior_Lights_Doors_Right</p>	
		<p><b>Document Type</b> DRAW/ELSY</p>	<p><b>Release Status</b> RELEASED</p>
<p><b>VOLVO</b> VOLVO CAR CORPORATION</p>		<p>CEVT Document No 8888522365</p>	<p><b>Edited</b> April/11/2023</p>
		<p><b>Issue</b> 035</p>	<p><b>Page No</b> 135/146</p>



# 9H Instr/Control Switch Lighting

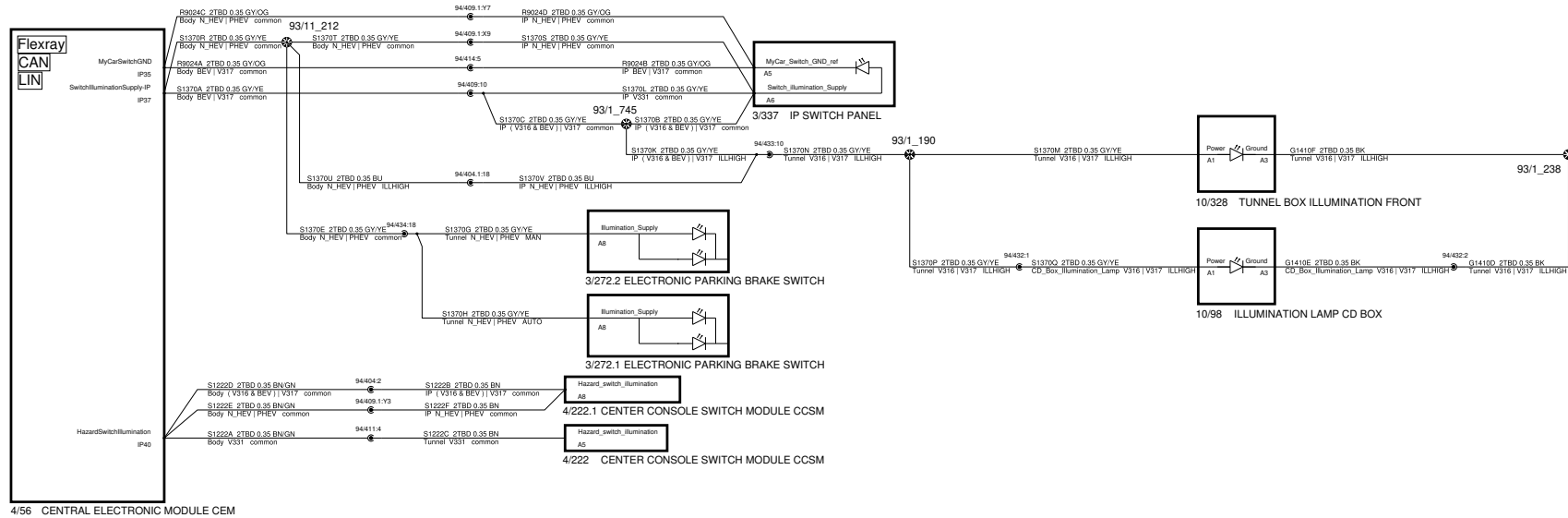
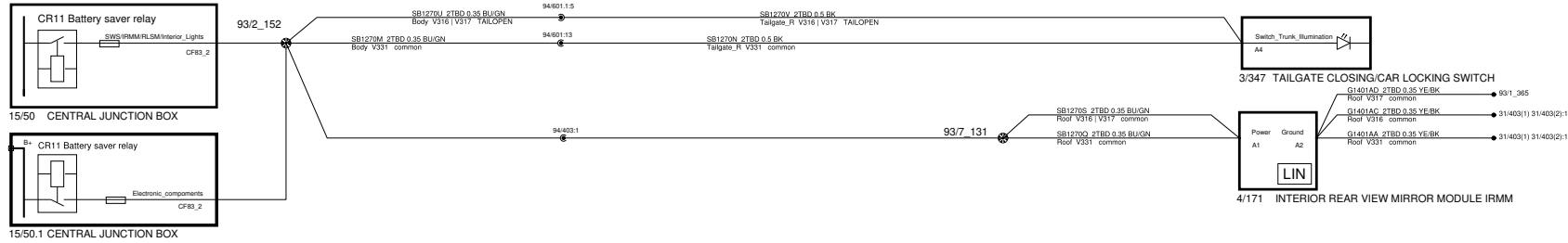

<p>The copying, distribution and utilization of this document as well as the communication of its contents to others without expressed authorization is prohibited. Offenders will be held liable for payment of damages. All rights reserved in the event of the grant of a patent, utility model or ornamental design registration.</p>		<p>Document title 623A_PP_CC_04_06_2023</p>	
		<p>9H_Instr_Control_Switch_Lighting</p>	
<p>Document Type DRAW/ELSY</p>		<p>Release Status RELEASED</p>	
<p>Volvo Document No 33445458</p>		<p>Edited April/19/2023</p>	
<p>Issue 035</p>		<p>Page No 136/146</p>	
<p><b>VOLVO</b> VOLVO CAR CORPORATION</p>			

# 10A Internal 7DCT Harness

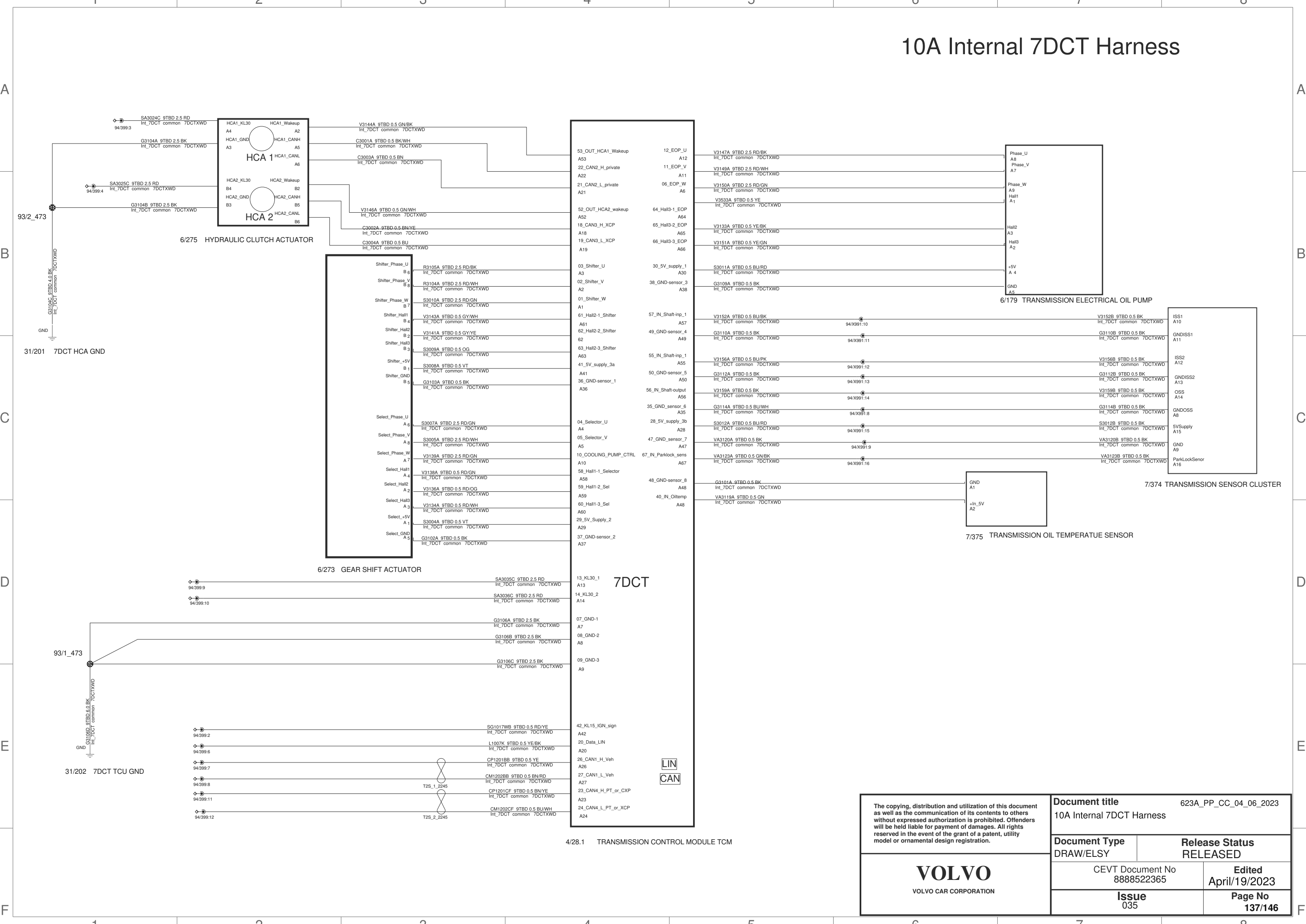

4/28.1 TRANSMISSION CONTROL MODULE TCM

7/375 TRANSMISSION OIL TEMPERATUE SENSOR

7/774 TRANSMISSION SENSOR CLUSTER

6/179 TRANSMISSION ELECTRICAL OIL PUMP

6/275 HYDRAULIC CLUTCH ACTUATOR

6/273 GEAR SHIFT ACTUATOR

7DCT

LIN  
CAN

<p>The copying, distribution and utilization of this document as well as the communication of its contents to others without expressed authorization is prohibited. Offenders will be held liable for payment of damages. All rights reserved in the event of the grant of a patent, utility model or ornamental design registration.</p>		<p><b>Document title</b> 623A_PP_CC_04_06_2023</p>	
		<p>10A Internal 7DCT Harness</p>	
<p><b>Document Type</b> DRAW/ELSY</p>		<p><b>Release Status</b> RELEASED</p>	
<p>CEVT Document No 8888522365</p>		<p><b>Edited</b> April/19/2023</p>	
<p><b>Issue</b> 035</p>		<p><b>Page No</b> 137/146</p>	

**VOLVO**  
VOLVO CAR CORPORATION

# 10A Driver Seat Internal Harness High LHD

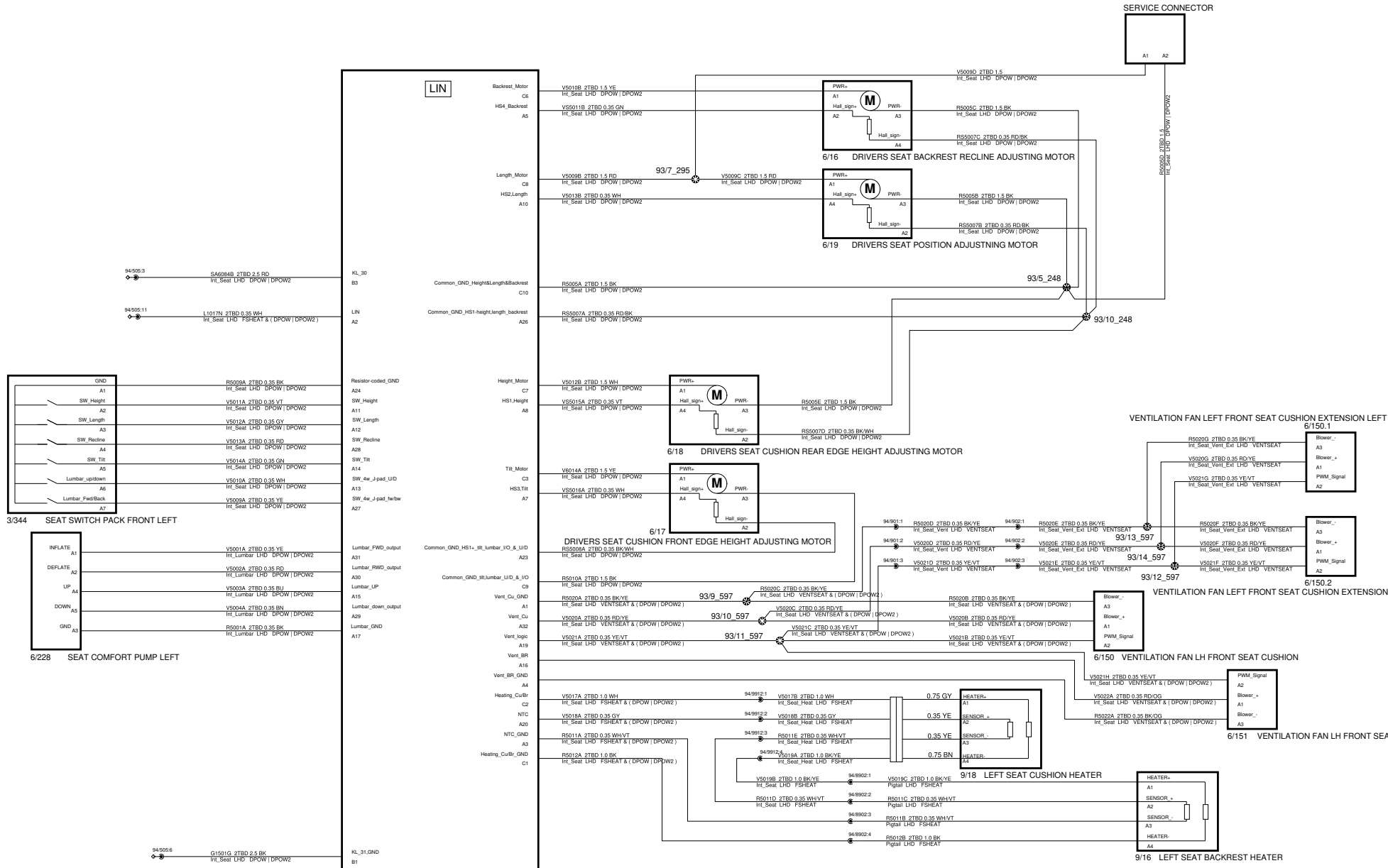

The copying, distribution and utilization of this document as well as the communication of its contents to others without expressed authorization is prohibited. Offenders will be held liable for payment of damages. All rights reserved in the event of the grant of a patent, utility model or ornamental design registration.

**Document title** 623A\_PP\_OC\_04\_06\_2023  
**10A\_Driver\_Seat\_Internal\_Harness\_High\_LHD**

Document Type	Release Status
DRAW/ELSY	RELEASED
Volvo Document No 33445458	Edited April/11/2023
Issue 035	Page No 138/146

**VOLVO**  
VOLVO CAR CORPORATION

# 10A Driver Seat Internal Harness High RHD

SERVICE CONNECTOR

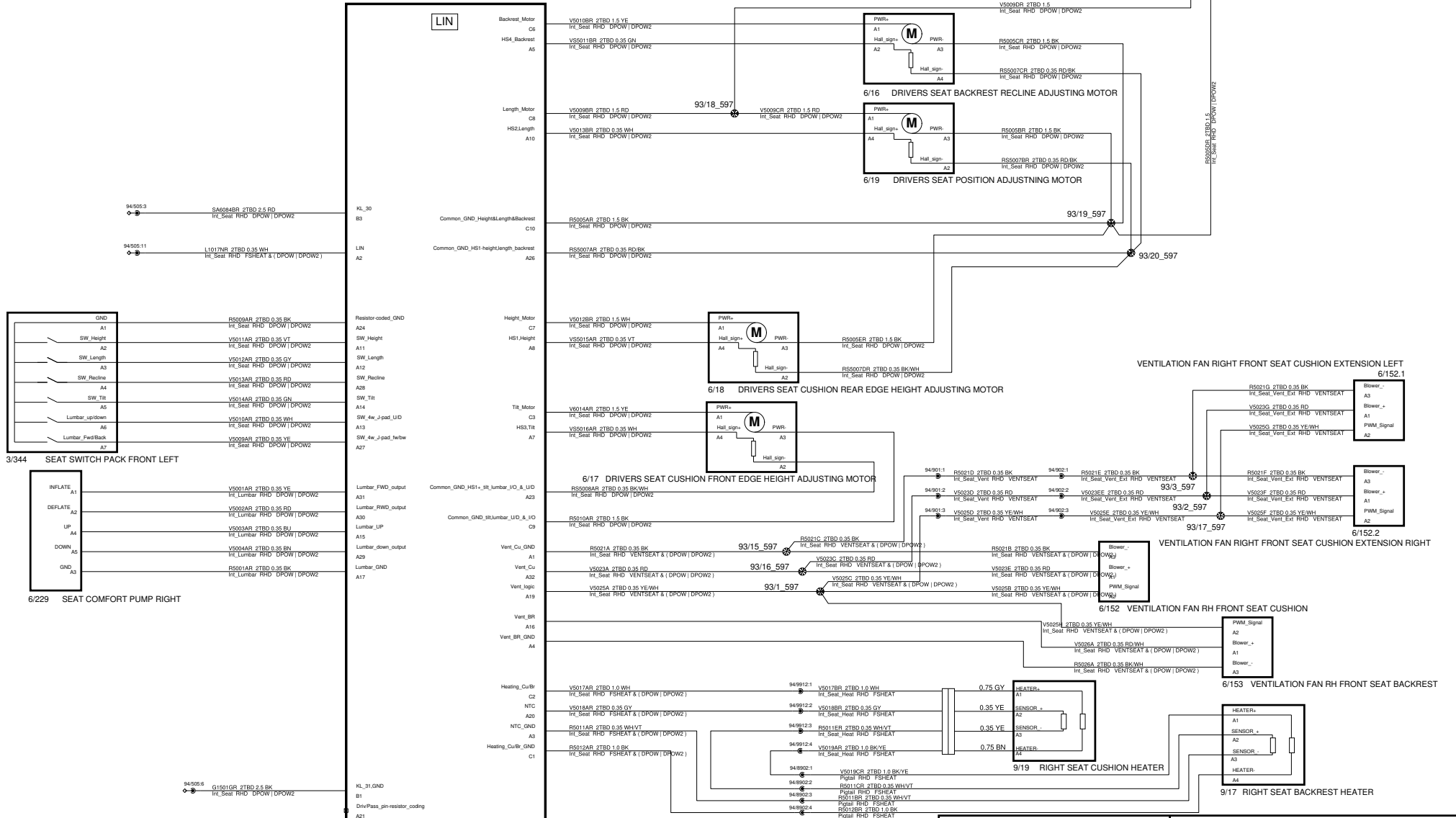

<p>The copying, distribution and utilization of this document as well as the communication of its contents to others without expressed authorization is prohibited. Offenders will be held liable for payment of damages. All rights reserved in the event of the grant of a patent, utility model or ornamental design registration.</p>		<p><b>Document title</b> 623A_PP_CC_04_06_2023 10A_Driver_Seat_Internal_Harness_High_RHD</p>	
<p><b>Document Type</b> DRAW/ELSY</p>		<p><b>Release Status</b> RELEASED</p>	
<p><b>VOLVO</b> VOLVO CAR CORPORATION</p>		<p>Volvo Document No 33445458</p>	<p><b>Edited</b> April/11/2023</p>
<p><b>Issue</b> 035</p>		<p><b>Page No</b> 139/146</p>	

A  
B  
C  
D  
E  
F

A  
B  
C  
D  
E  
F

1 2 3 4 5 6 7 8

# 10A Driver Seat Internal Harness Mech LHD

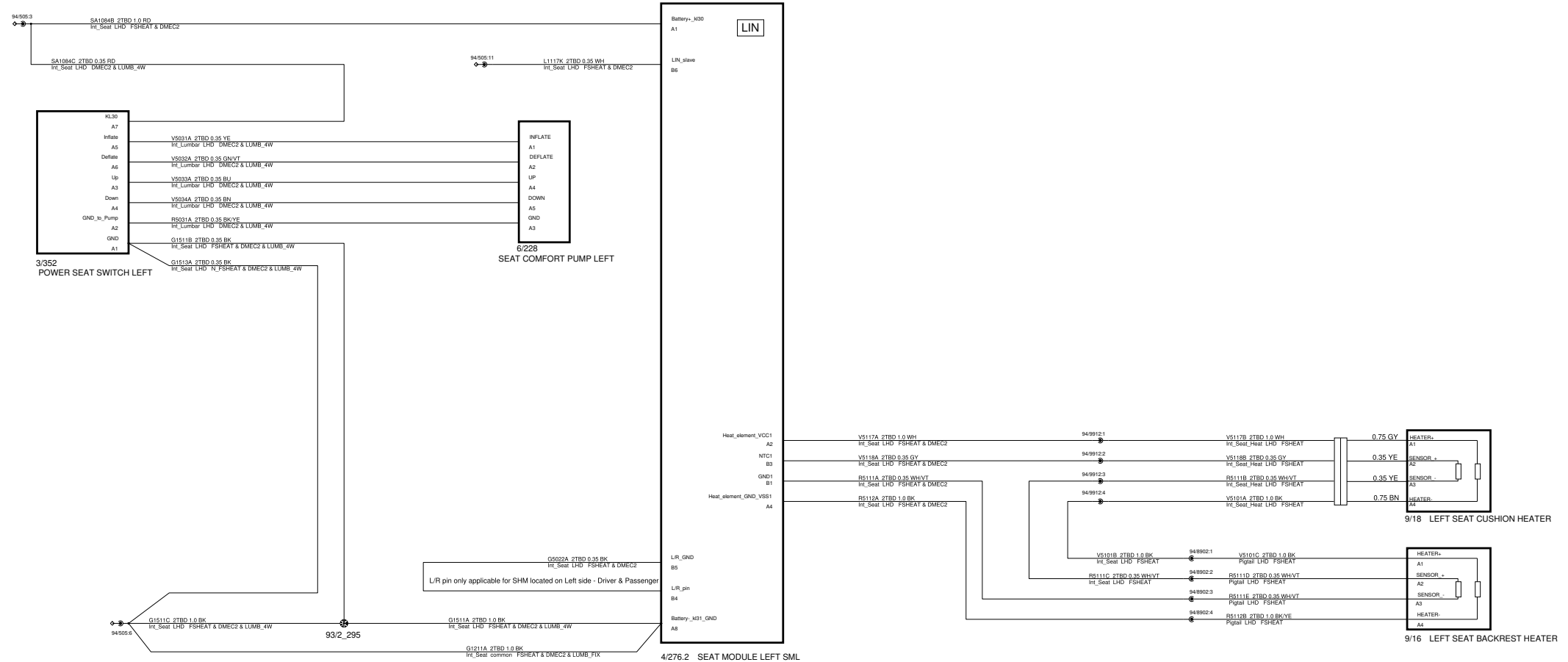

<p>The copying, distribution and utilization of this document as well as the communication of its contents to others without expressed authorization is prohibited. Offenders will be held liable for payment of damages. All rights reserved in the event of the grant of a patent, utility model or ornamental design registration.</p> <p><b>VOLVO</b> VOLVO CAR CORPORATION</p>	<b>Document title</b> 623A_PP_CC_04_06_2023	
	10A_Driver_Seat_Internal_Harness_Mech_LHD	
	<b>Document Type</b> DRAW/ELSY	<b>Release Status</b> RELEASED
	Volvo Document No 33445458	<b>Edited</b> April/19/2023
	<b>Issue</b> 035	<b>Page No</b> 140/146

# 10A Driver Seat Internal Harness Mech RHD

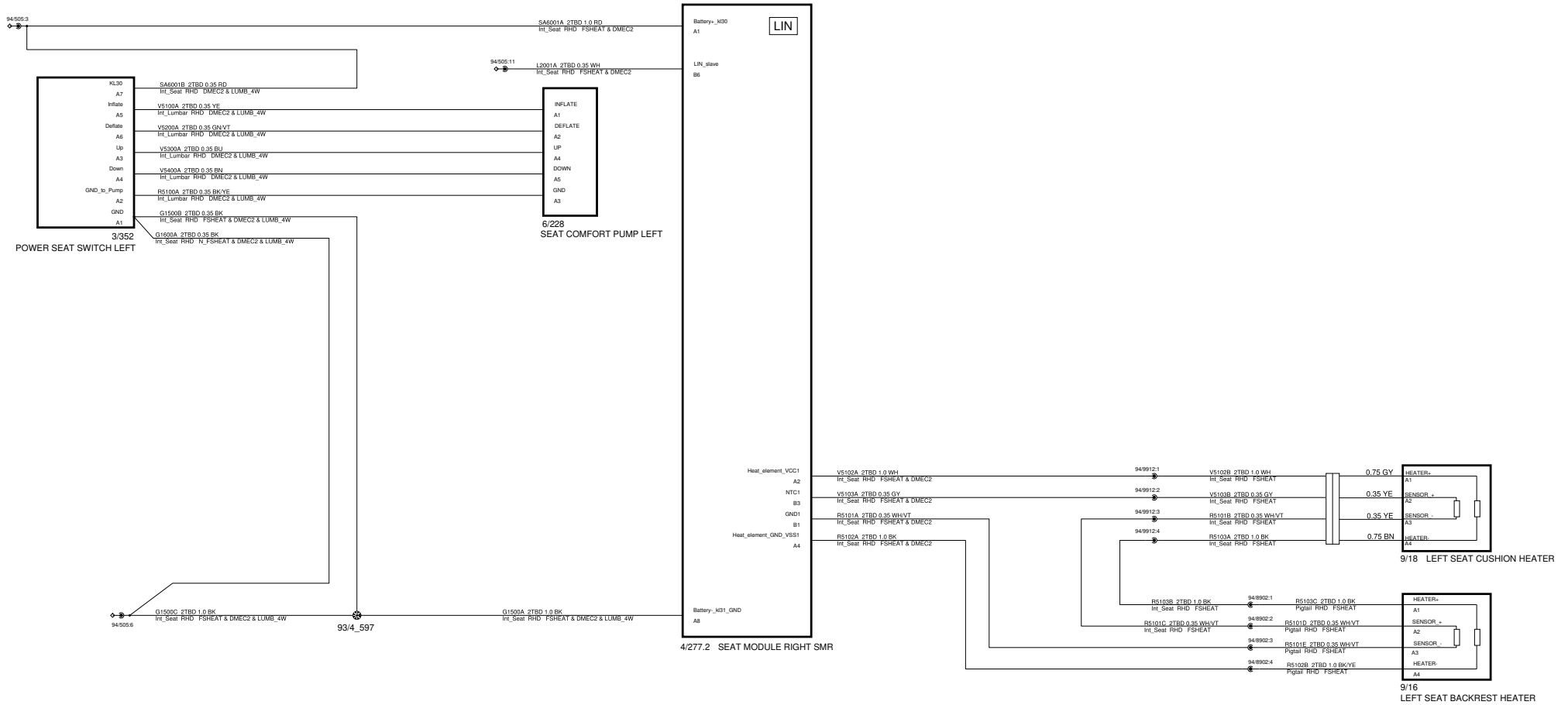

<p>The copying, distribution and utilization of this document as well as the communication of its contents to others without expressed authorization is prohibited. Offenders will be held liable for payment of damages. All rights reserved in the event of the grant of a patent, utility model or ornamental design registration.</p> <p><b>VOLVO</b> VOLVO CAR CORPORATION</p>	<p><b>Document title</b> 623A_PP_CC_04_06_2023 10A_Driver_Seat_Internal_Harness_Mech_RHD</p>	
	<p><b>Document Type</b> DRAW/ELSY</p>	<p><b>Release Status</b> RELEASED</p>
	<p>Volvo Document No 33445458</p>	<p><b>Edited</b> April/10/2023</p>
	<p><b>Issue</b> 035</p>	<p><b>Page No</b> 141/146</p>

# 10A Interior HVAC harness 2 ZONEs ECC

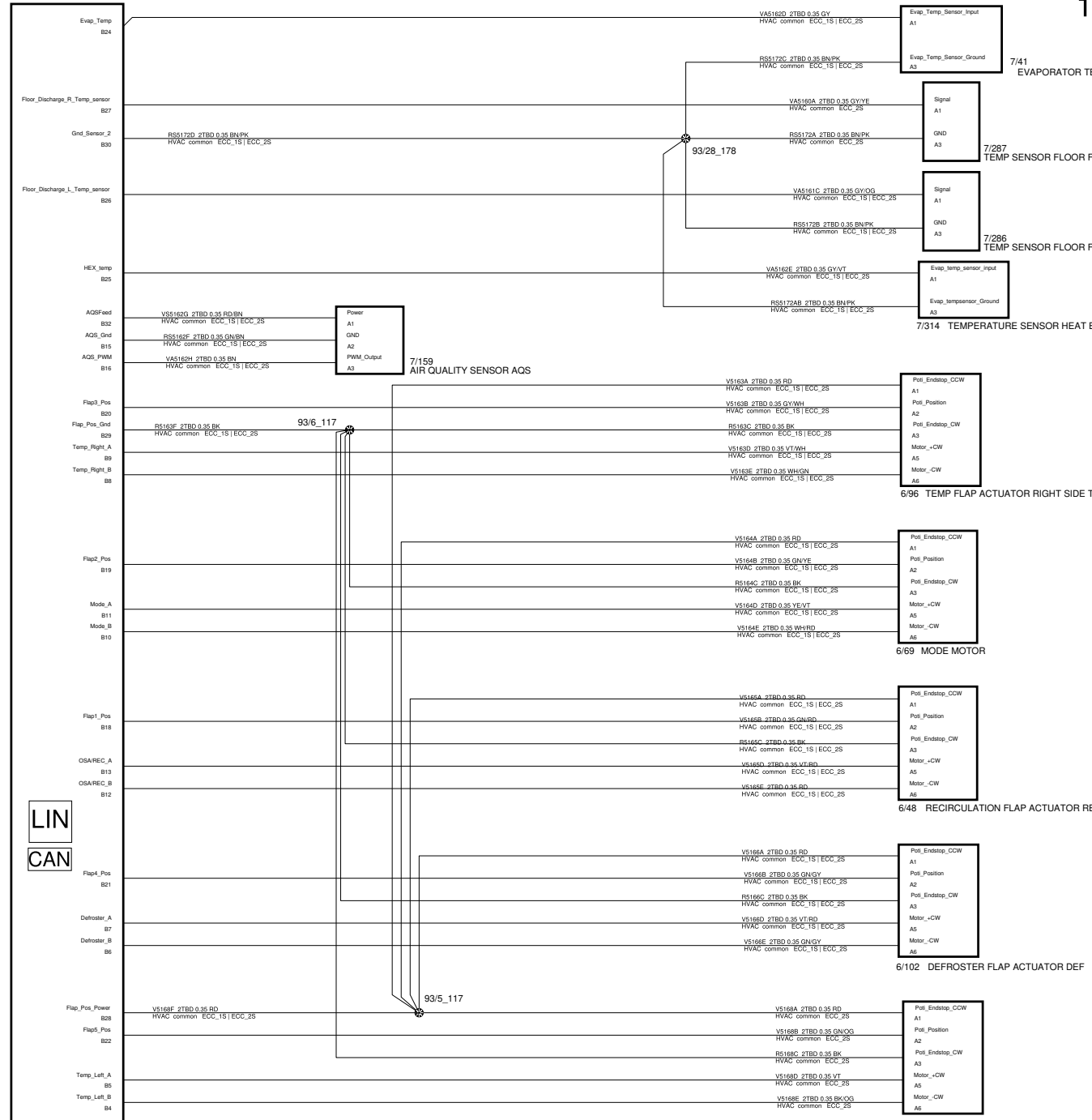

<p>The copying, distribution and utilization of this document as well as the communication of its contents to others without expressed authorization is prohibited. Offenders will be held liable for payment of damages. All rights reserved in the event of the grant of a patent, utility model or ornamental design registration.</p>		<b>Document title</b> 623A_PP_CC_04_06_2023 10A_Interior_HVAC_Harness_VCC_2-ZONES_ECC	
		<b>Document Type</b> DRAW/ELSY	<b>Release Status</b> RELEASED
<p><b>VOLVO</b> VOLVO CAR CORPORATION</p>		Volvo Document No 33445458	<b>Edited</b> June/16/2021
		<b>Issue</b> 035	<b>Page No</b> 142/146

4/154 CLIMATE CONTROL MODULE CCM

6/95 TEMP FLAP ACTUATOR LEFT SIDE TMPL/EATC

# 10A Passenger Seat Internal Harness High LHD

SERVICE CONNECTOR

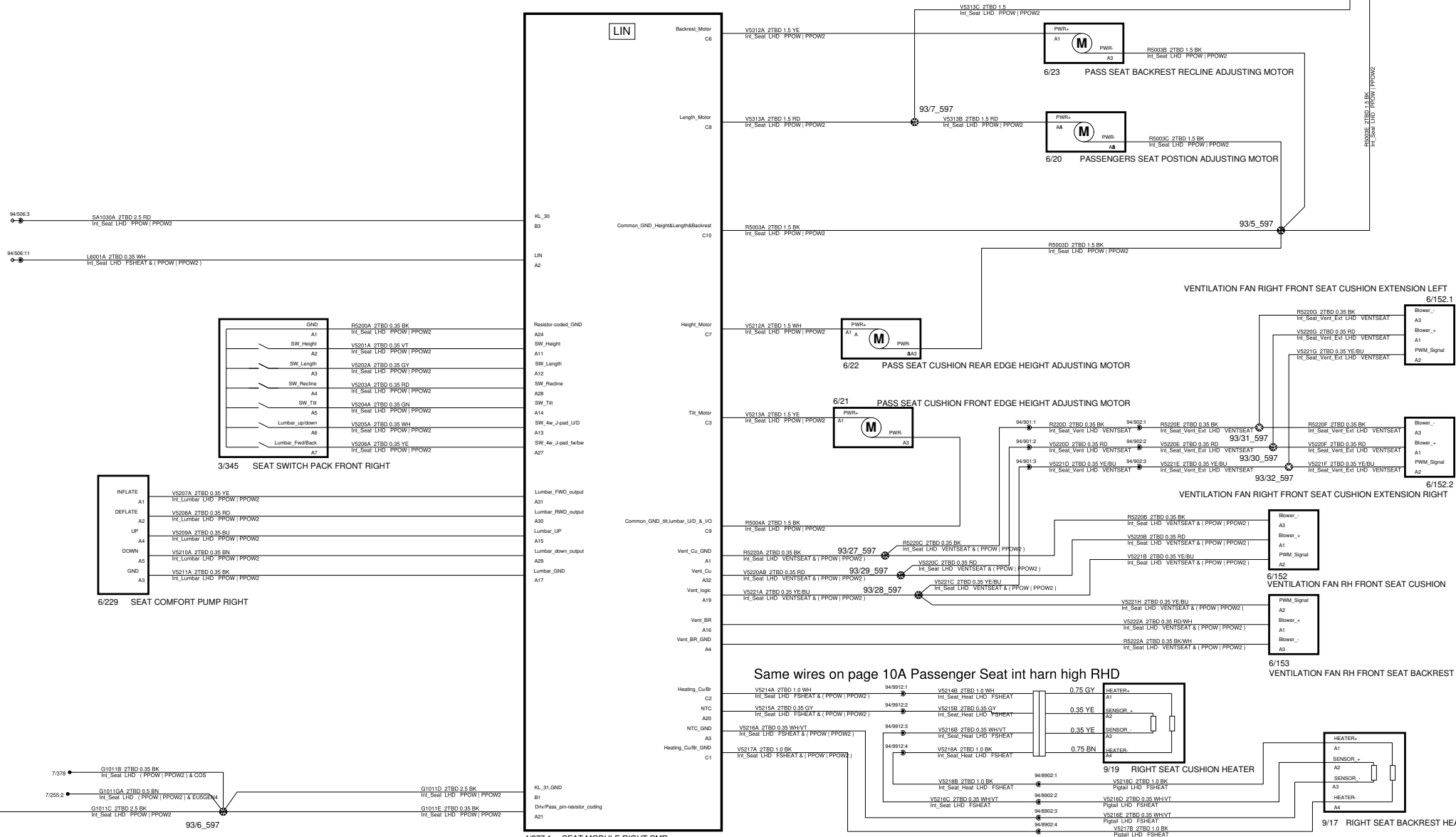

<p>The copying, distribution and utilization of this document as well as the communication of its contents to others without expressed authorization is prohibited. Offenders will be held liable for payment of damages. All rights reserved in the event of the grant of a patent, utility model or ornamental design registration.</p>		<p>Document title 623A_PP_CC_04_06_2023 10A_Passenger_Seat_Internal_Harness_High_LHD</p>	
		<p>Document Type DRAW/ELSY</p>	<p>Release Status RELEASED</p>
<p>VOLVO VOLVO CAR CORPORATION</p>		<p>Volvo Document No 33445458</p>	<p>Edited April/19/2023</p>
<p>Issue No 035</p>		<p>Page No 143/146</p>	



# 10A Passenger Seat Internal Harness High RHD

SERVICE CONNECTOR

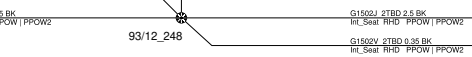
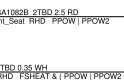
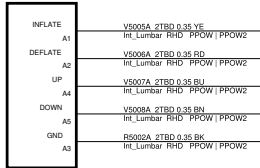
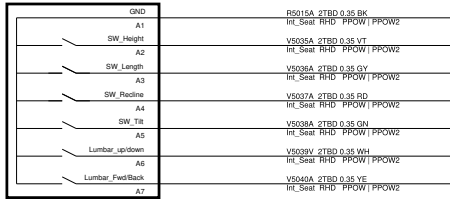
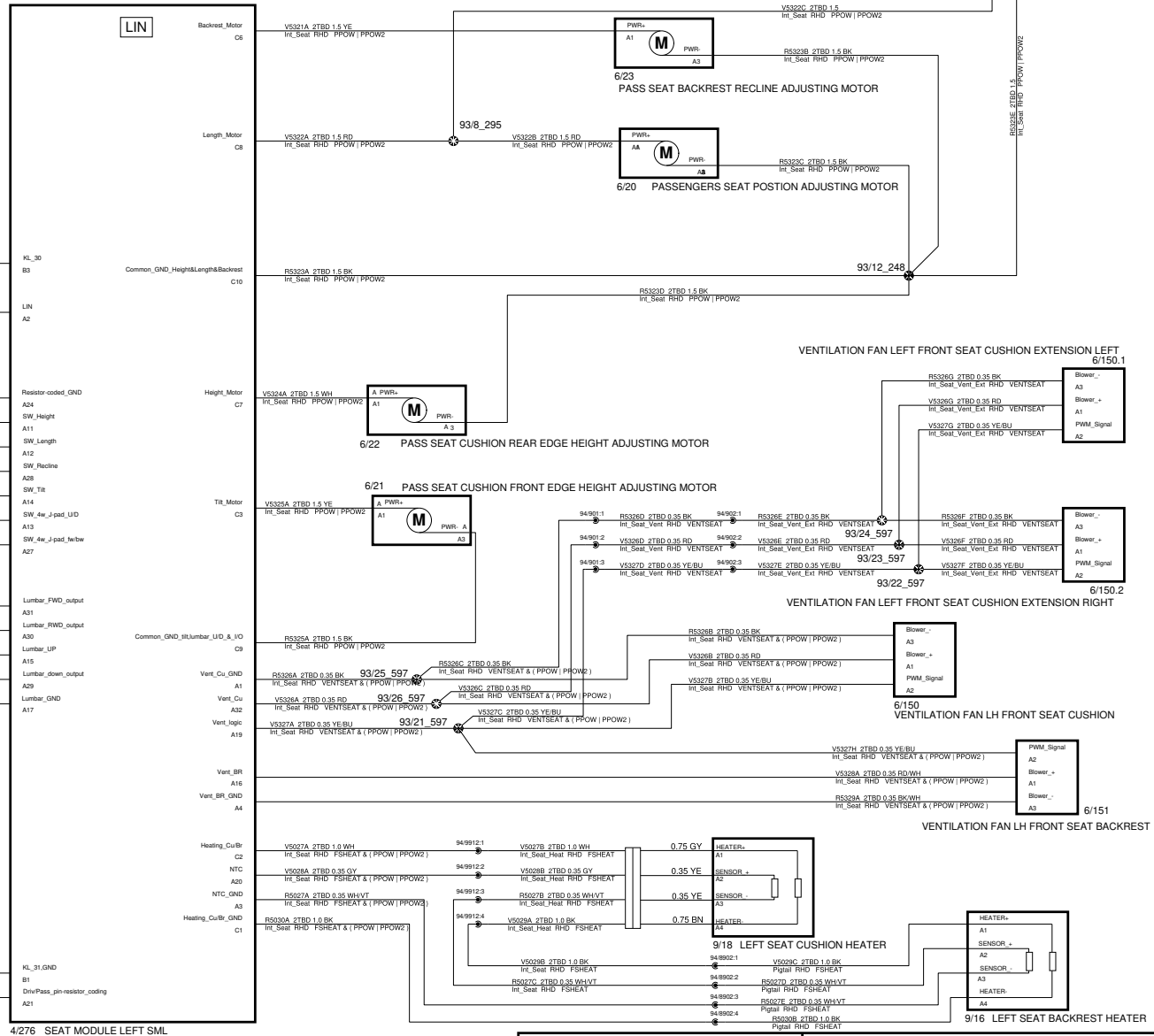

4/276 SEAT MODULE LEFT SML

The copying, distribution and utilization of this document as well as the communication of its contents to others without expressed authorization is prohibited. Offenders will be held liable for payment of damages. All rights reserved in the event of the grant of a patent, utility model or ornamental design registration.

**VOLVO**  
VOLVO CAR CORPORATION

**Document title** 623A\_PP\_OC\_04\_06\_2023  
10A\_Passenger\_Seat\_Internal\_Harness\_High\_RHD

Document Type	Release Status
DRAW/ELSY	RELEASED
Volvo Document No 33445458	Edited April/19/2023
Issue 035	Page No 144/146

# 10A Passenger Seat Internal Harness Mech LHD

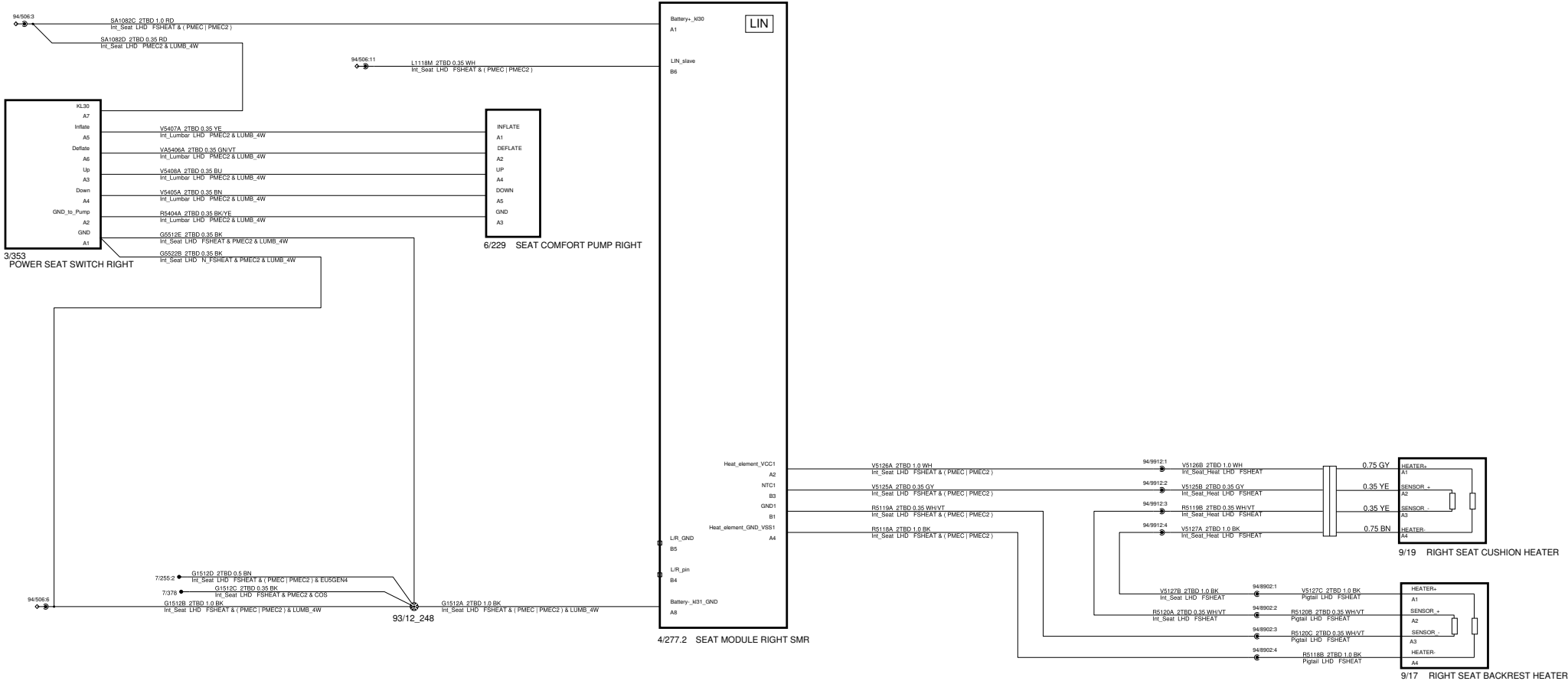

<p>The copying, distribution and utilization of this document as well as the communication of its contents to others without expressed authorization is prohibited. Offenders will be held liable for payment of damages. All rights reserved in the event of the grant of a patent, utility model or ornamental design registration.</p> <p><b>VOLVO</b> VOLVO CAR CORPORATION</p>	<p>Document title 623A_PP_CC_04_06_2023 10A_Passenger_Seat_Internal_Harness_Mech_LHD</p>	
	<p>Document Type DRAW/ELSY</p>	<p>Release Status RELEASED</p>
	<p>Volvo Document No 33445458</p>	<p>Edited April/19/2023</p>
	<p>Issue 035</p>	<p>Page No 145/146</p>

# 10A Passenger Seat Internal Harness Mech RHD

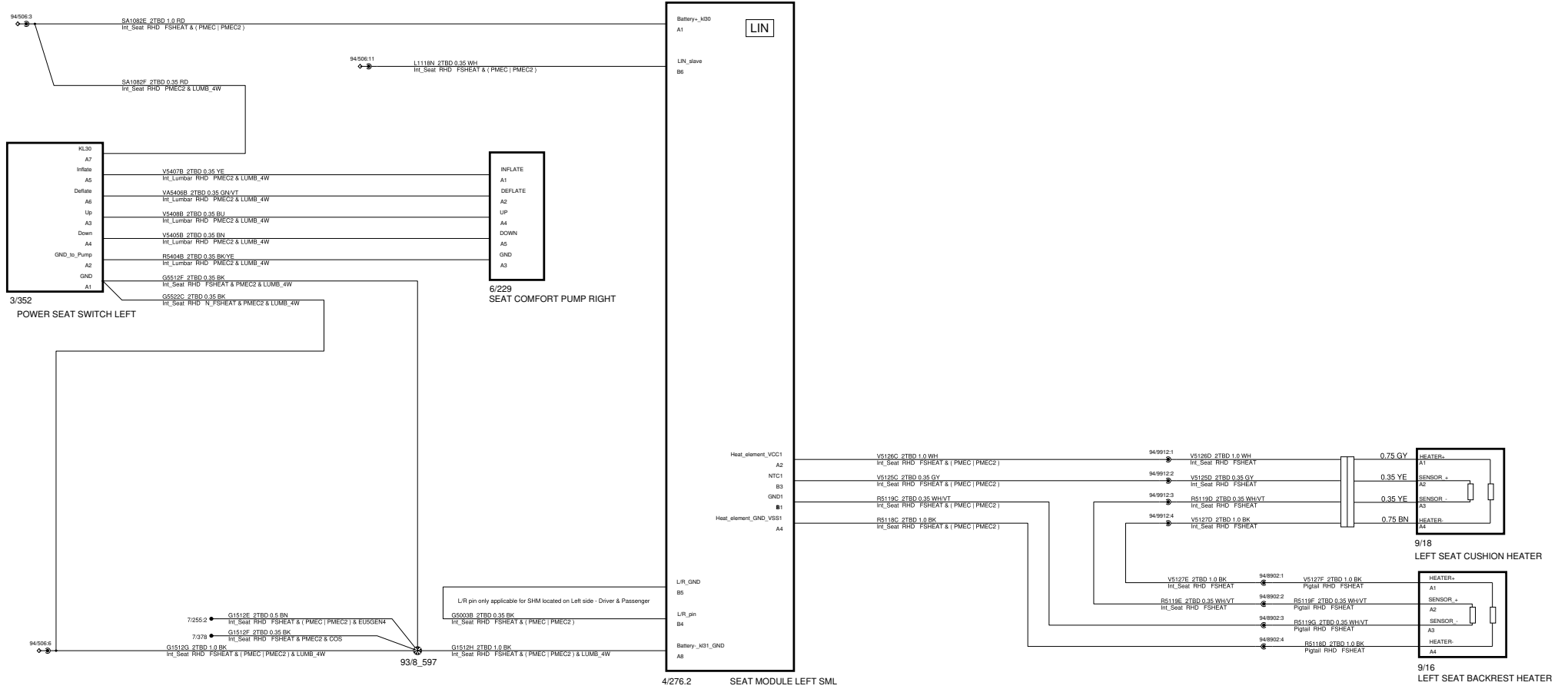

<p>The copying, distribution and utilization of this document as well as the communication of its contents to others without expressed authorization is prohibited. Offenders will be held liable for payment of damages. All rights reserved in the event of the grant of a patent, utility model or ornamental design registration.</p> <p><b>VOLVO</b> VOLVO CAR CORPORATION</p>	<p><b>Document title</b> 623A_PP_CC_04_06_2023 10A_Passenger_Seat_Internal_Harness_Mech_RHD</p>	
	<p><b>Document Type</b> DRAW/ELSY</p>	<p><b>Release Status</b> RELEASED</p>
	<p>Volvo Document No 33445458</p>	<p><b>Edited</b> April/19/2023</p>
	<p><b>Issue</b> 035</p>	<p><b>Page No</b> 146/146</p>