



TECHNICAL SERVICE BULLETIN

Classification: AN22-018A	Reference: ITB22-027A	Date: April 13, 2023
------------------------------	--------------------------	-------------------------

ENABLING WIRELESS APPLE CARPLAY® FEATURES

This bulletin has been amended. See **AMENDMENT HISTORY** on the last page.
Please discard previous versions of this bulletin.

APPLIED VEHICLES: 2020-2021 QX80 (Z62)

SERVICE INFORMATION

To enable wireless use of current Apple CarPlay® features, follow the **SERVICE PROCEDURE** in this bulletin.

HINT: Depending on the software version, the AV Control Unit may need to be updated. Perform step 1 on page 2 to check the software version.

IMPORTANT: This service is not covered under warranty.

Bulletins are intended for use by qualified technicians, not 'do-it-yourselfers'. Qualified technicians are properly trained individuals who have the equipment, tools, safety instruction, and know-how to do a job properly and safely. **NOTE:** If you believe that a described condition may apply to a particular vehicle, DO NOT assume that it does. See your Infiniti retailer to determine if this applies to your vehicle.

SERVICE PROCEDURE

1. Confirm the current software version of the AV Control Unit is 2992 or newer.

IMPORTANT: Refer to the vehicle tables in ITB23-010 for the software history list, software version check procedure, the latest infotainment update-software and update procedure.

- If the current software version is 2992 or newer, the AV Control Unit does not require an update. Proceed to step 2 to configure the AV Control Unit for Wireless CarPlay.
- If the current software version is older than 2992, update the AV Control Unit to the latest software version, and then proceed to step 2 to configure the AV Control Unit for Wireless CarPlay.

Configure Wireless CarPlay

2. Connect a battery maintainer/smart charger to the vehicle.
3. Connect the VI to the vehicle.
4. Start C-III plus.
5. Wait for the VI to be recognized (Figure 1).
 - The serial number will display when the VI is recognized.
6. Select **Re/programming, Configuration**.

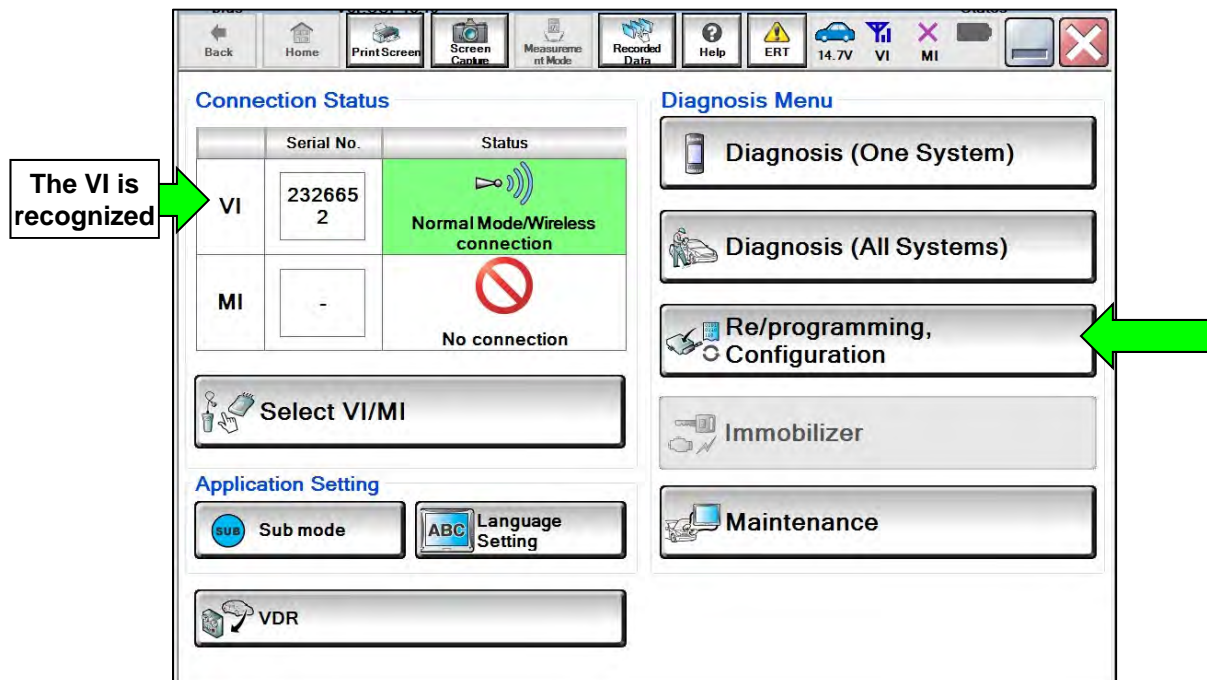

Figure 1

7. Check the box to confirm the precaution instructions have been read, and then select **Next**.

HINT: Use the arrows (if needed) to view and read all the precautions.

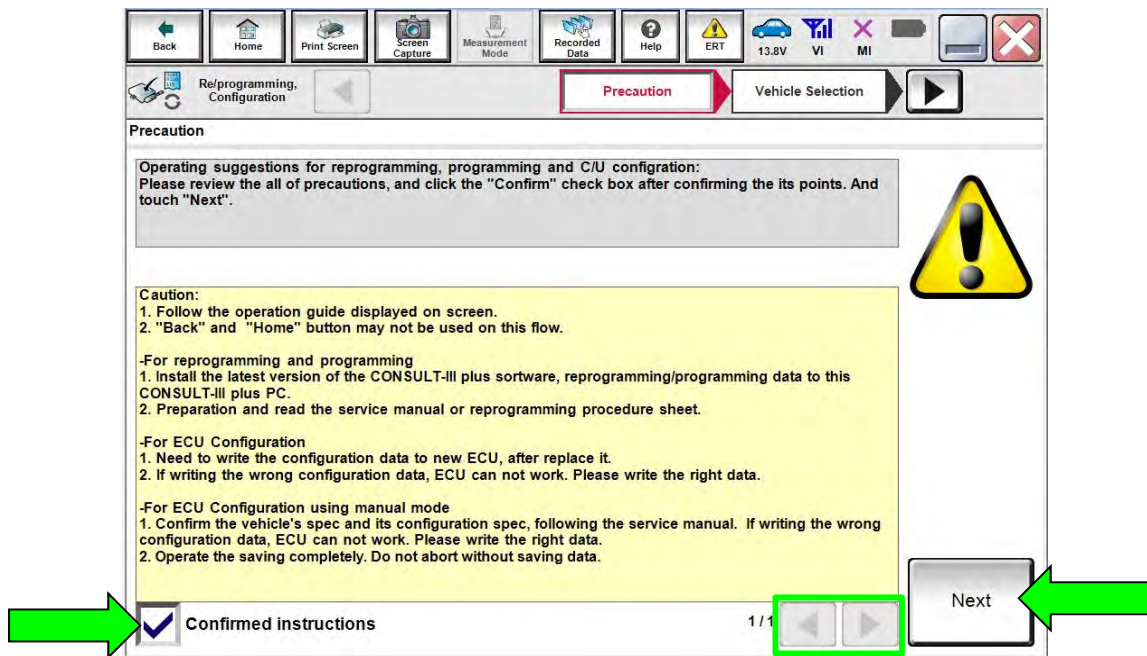

Figure 2

8. Select **Manual Selection(Vehicle Name)**, select the applicable **Vehicle Name** and **Model Year**, and then select **Select**.

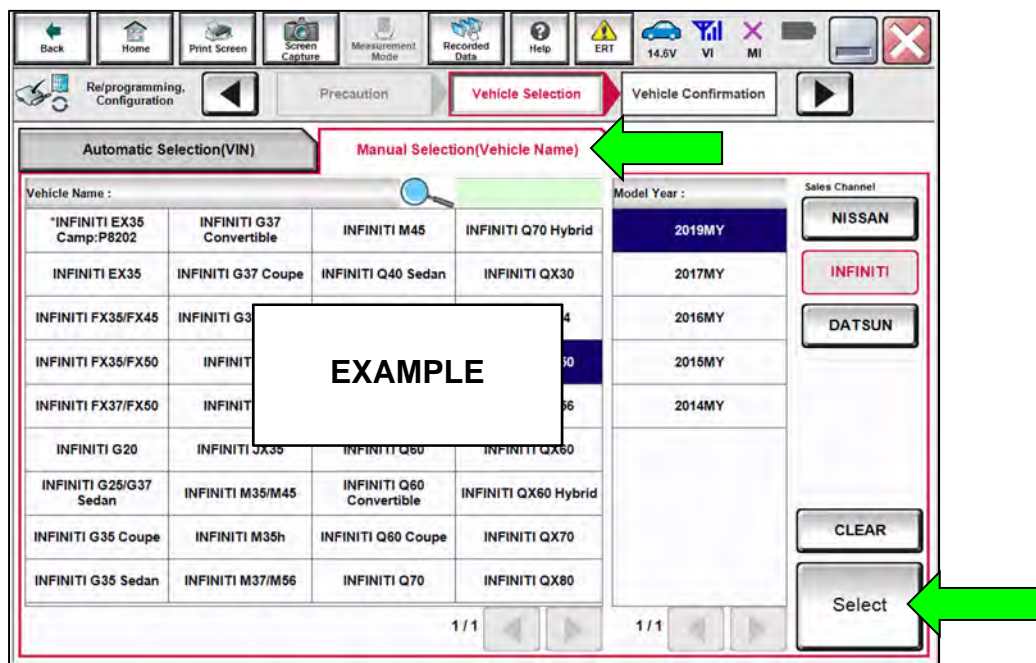

Figure 3

9. Confirm the **VIN or Chassis #** is correct, and then select **Confirm**.

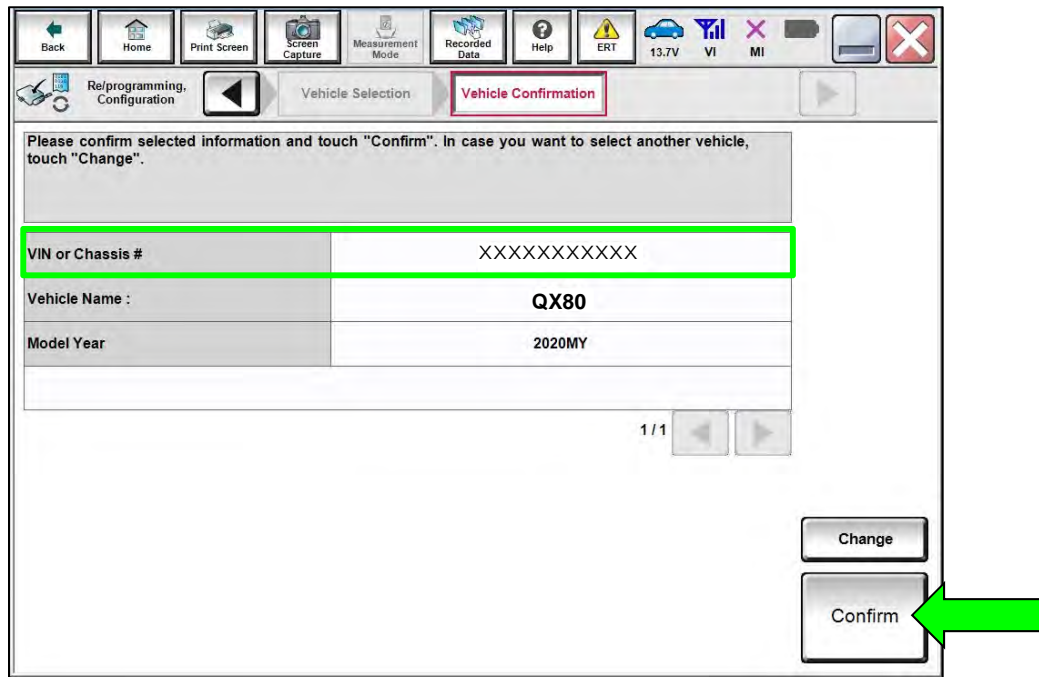

Figure 4

10. Confirm the VIN is correct for the vehicle, and then select **Confirm**.

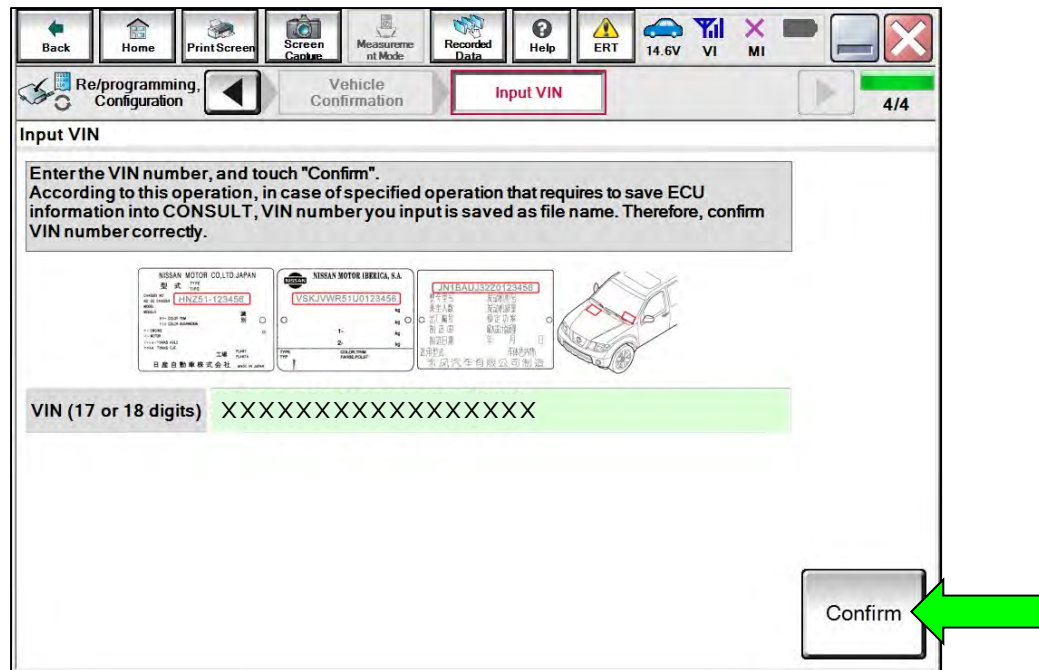

Figure 5

11. Select **MULTI AV**.

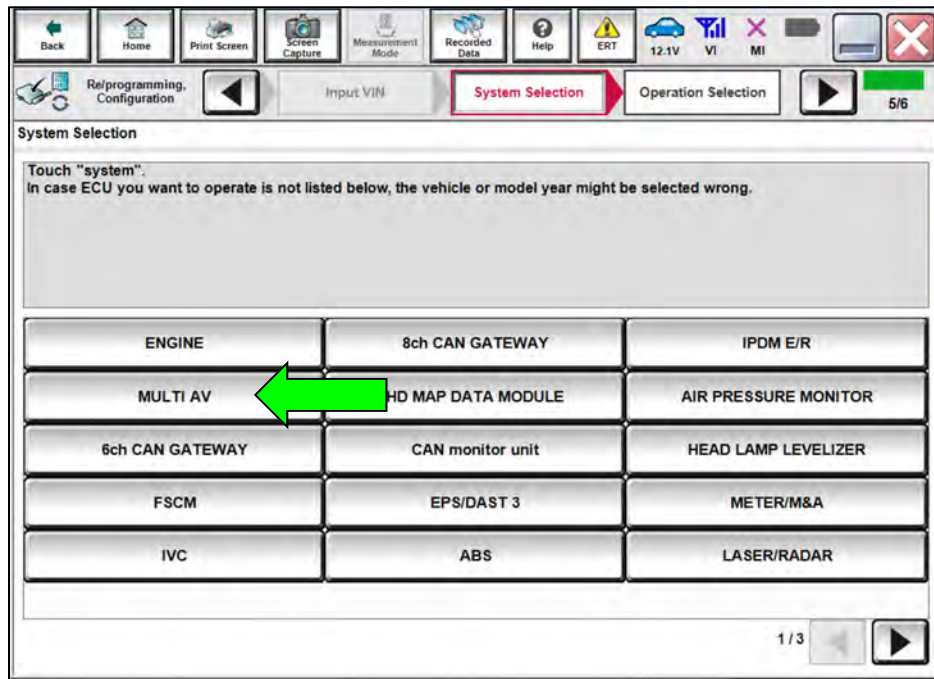

Figure 6

12. Select **Before ECU Replacement** under **VEHICLE CONFIGURATION**.

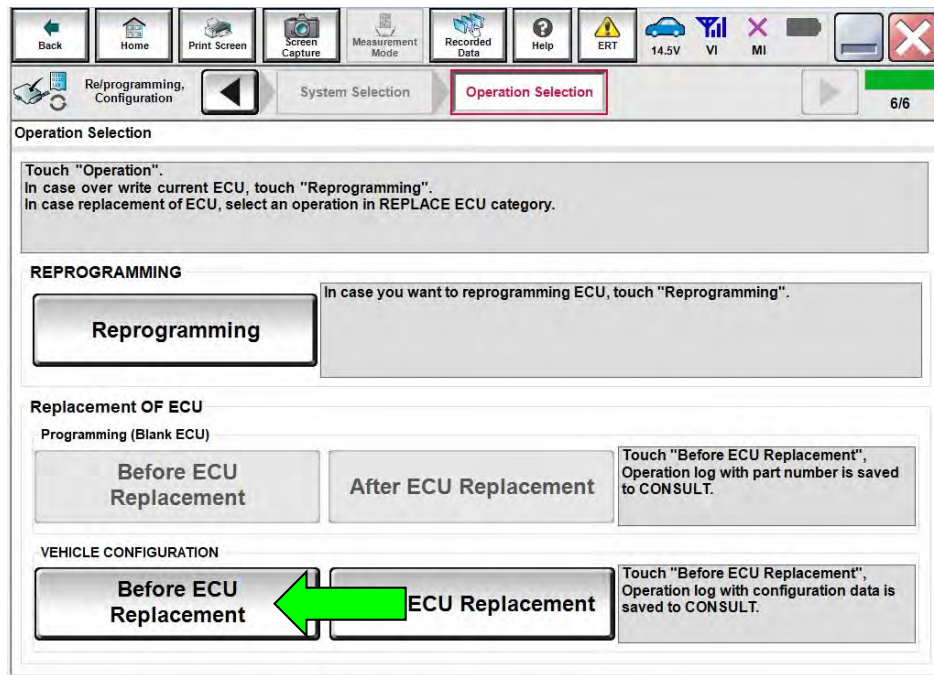

Figure 7

13. Scroll through each of the pages of configuration items and write down each of the **Items** and its **Setting Value**.

- If a printer is connected to the CONSULT PC, you may select **Print**.

IMPORTANT: Write down or print all the configuration settings, as these settings will be used in step 17 on page 7.

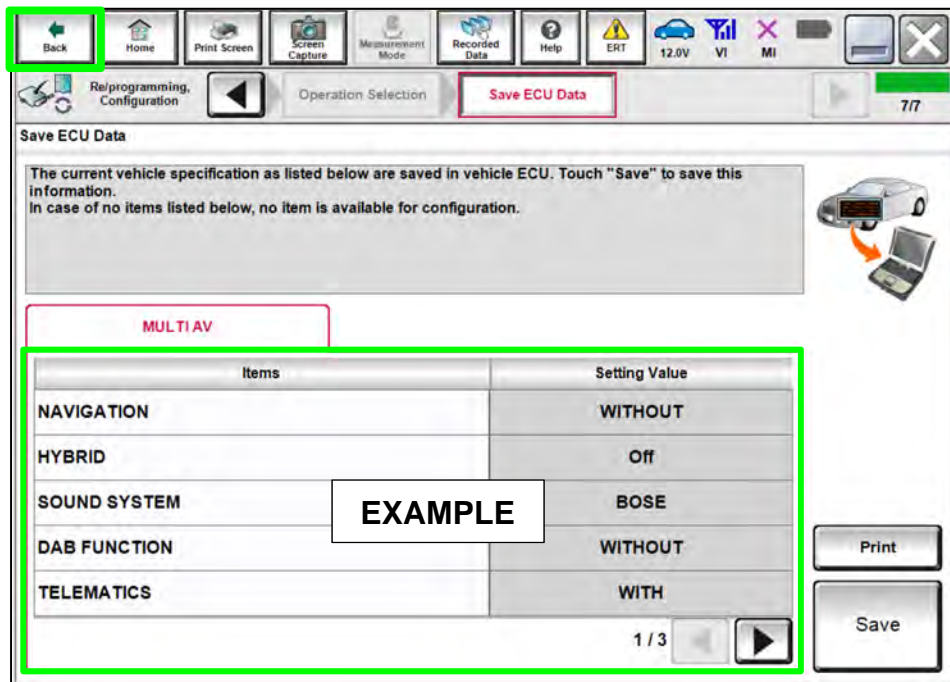

Figure 8

14. After the current configurations have been written down or printed, select **Back** in the upper LH corner of the screen (Figure 8).

15. Select **After ECU Replacement** under **VEHICLE CONFIGURATION**.

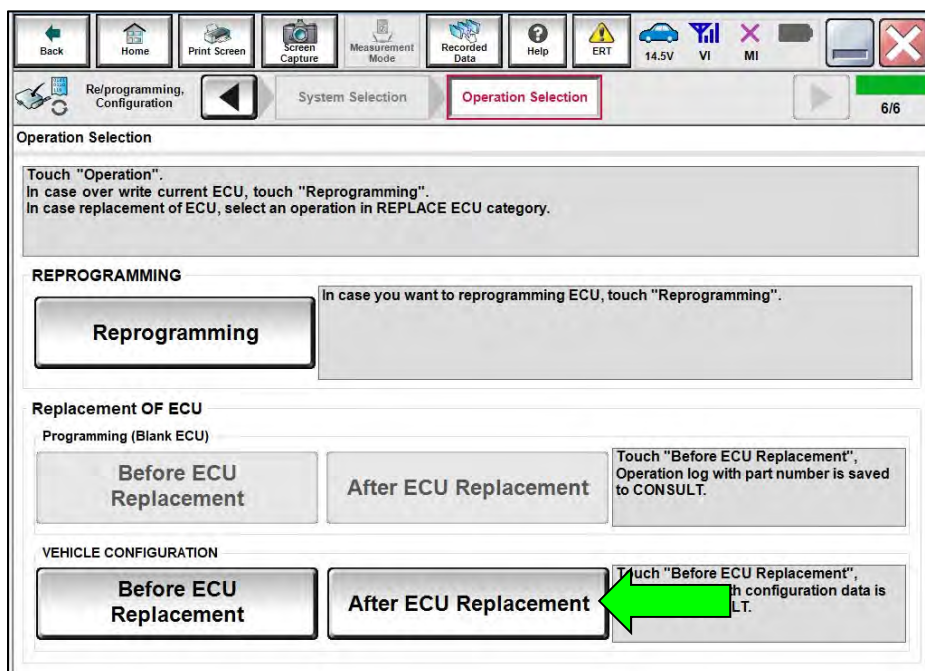

Figure 9

16. Select **Manual selection**.

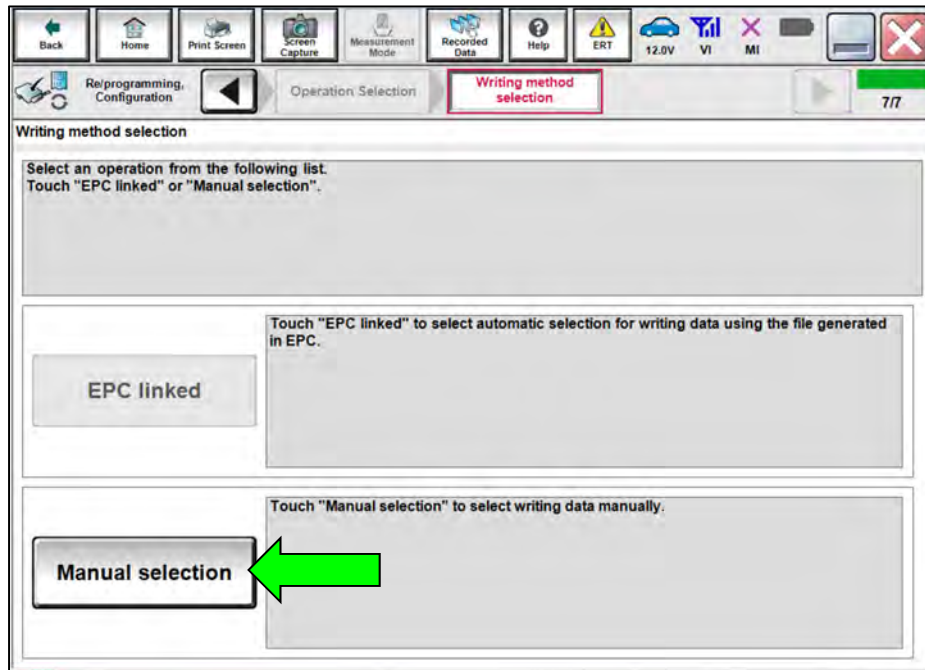

Figure 10

17. Use the drop down menus to select the configuration options that were printed or written down in step 13 on page 6, and then select **Next**.

IMPORTANT: The default **Setting Value** for **Wireless CarPlay** is "WITHOUT". Be sure to change this **Setting Value** to "WITH" (Figure 11).

HINT: If needed, refer to the table on page 14, and select the applicable specification for the vehicle you are working on.

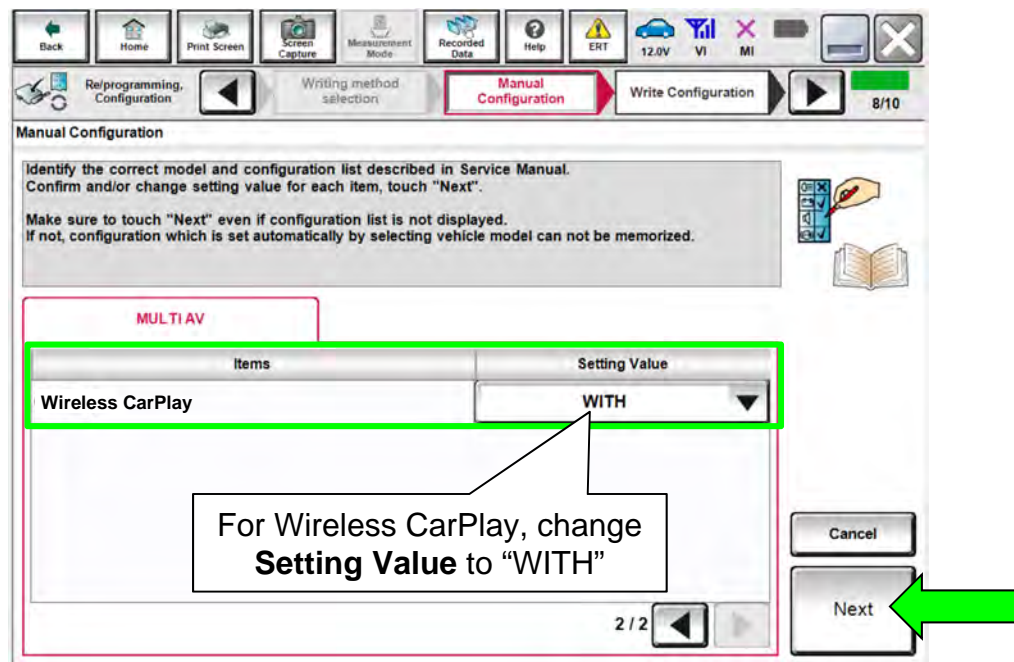

Figure 11

18. Confirm the configuration displayed is correct, and then select **OK**.

IMPORTANT: Be sure the **Setting Value** for **Wireless CarPlay** is “WITH” before selecting **OK**.

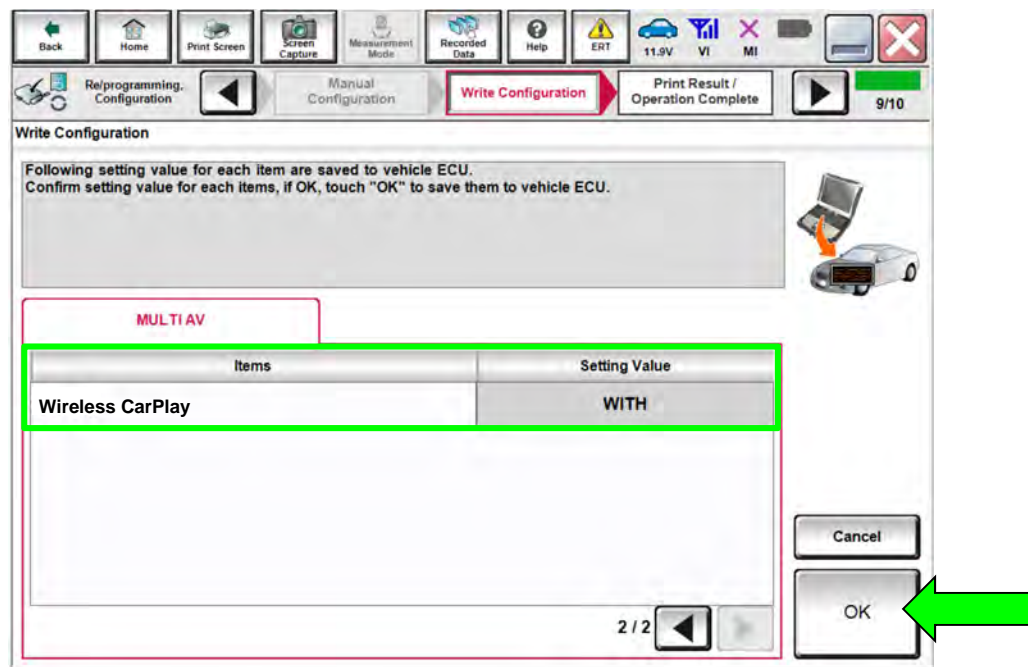

Figure 12

19. Allow configuration to transfer to the vehicle.

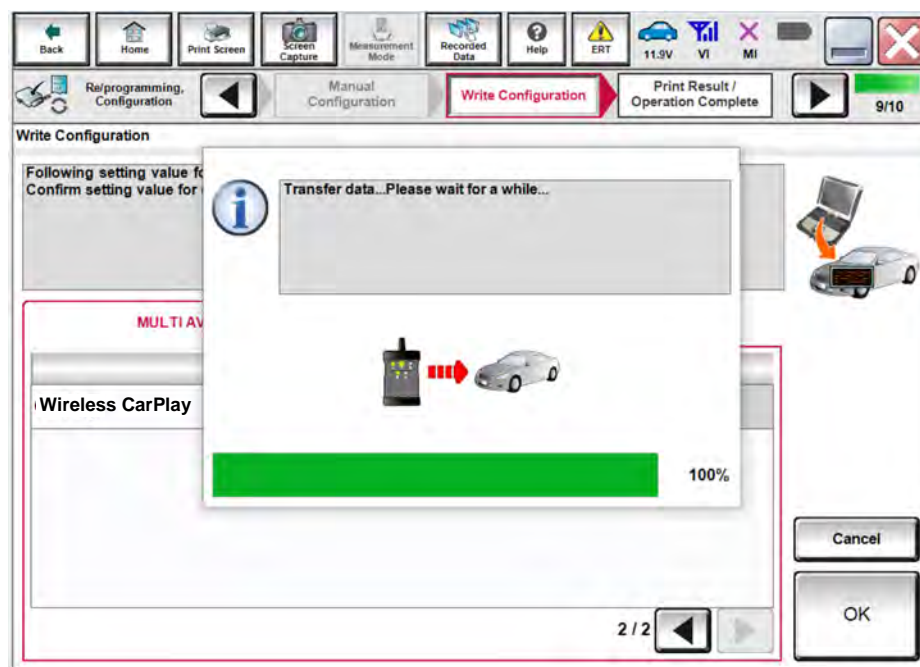

Figure 13

20. Select **End**.

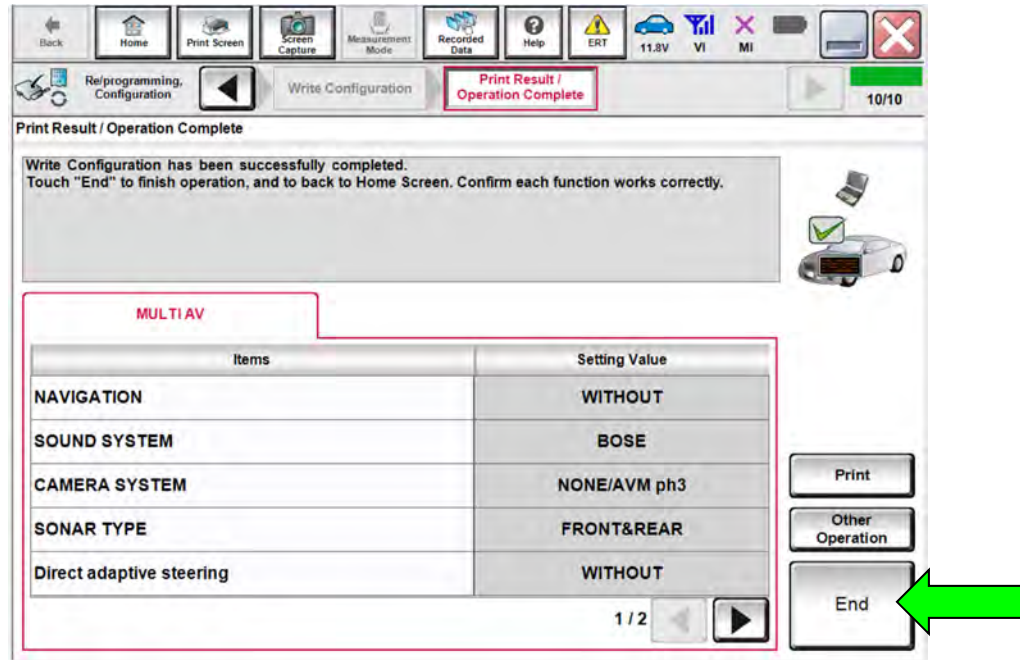

Figure 14

Erase DTCs

21. Select **Diagnosis (All Systems)**.

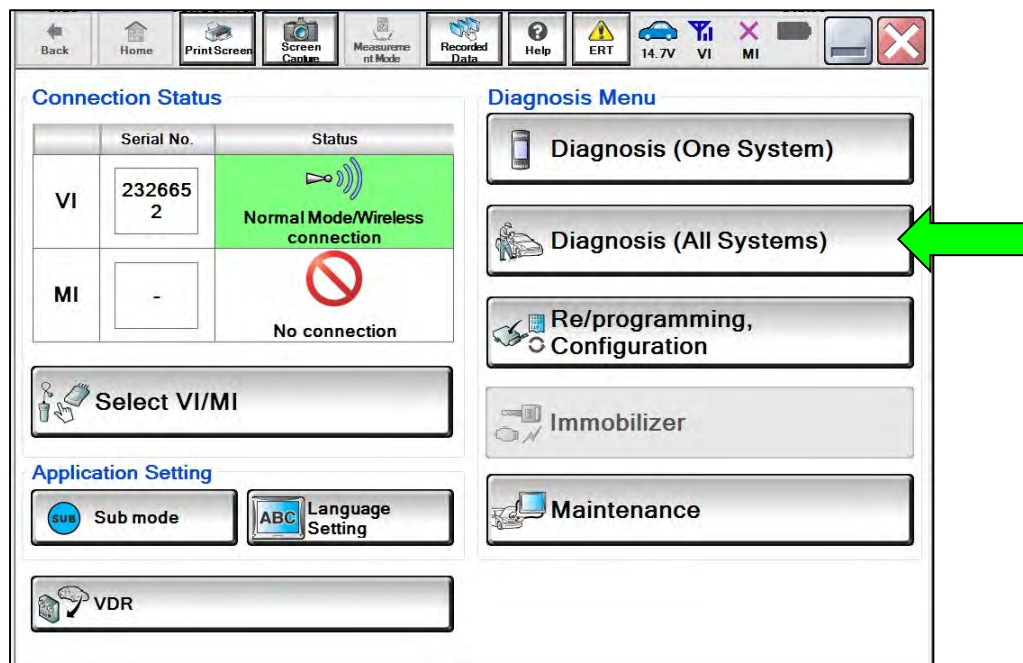

Figure 15

22. Select Automatic Selection(VIN).

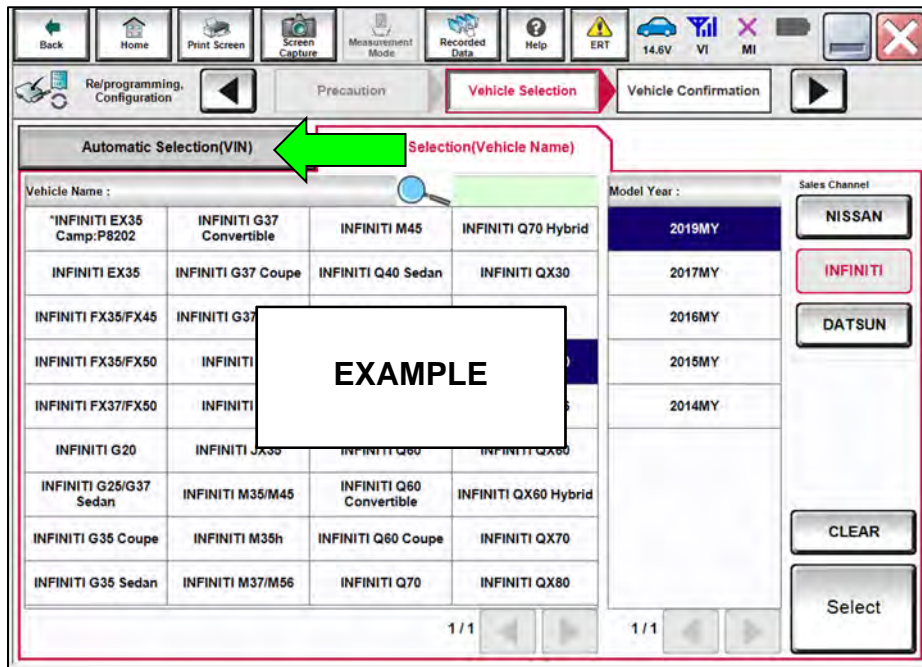

Figure 16

23. Allow the CONSULT to perform automatic VIN selection.

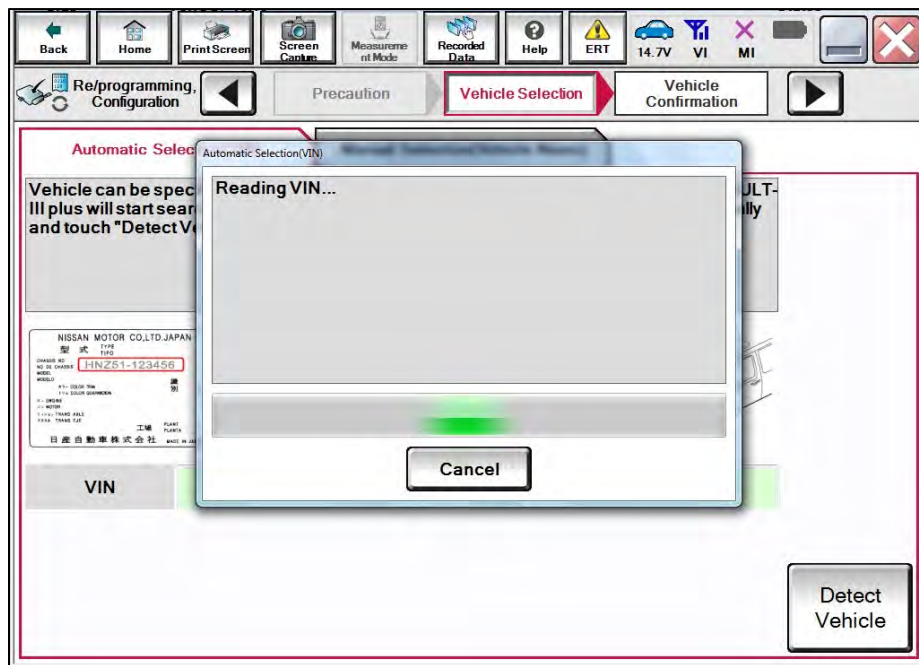

Figure 17

24. Confirm the **VIN or Chassis #** is correct, and then select **Confirm**.

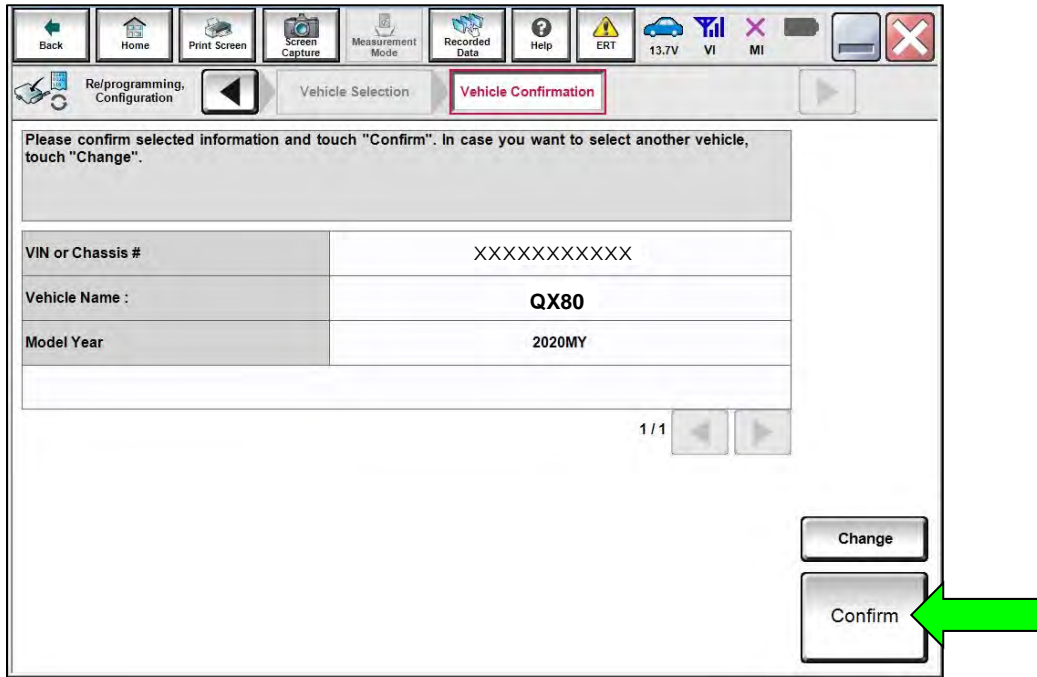

Figure 18

25. Select **ERASE**.

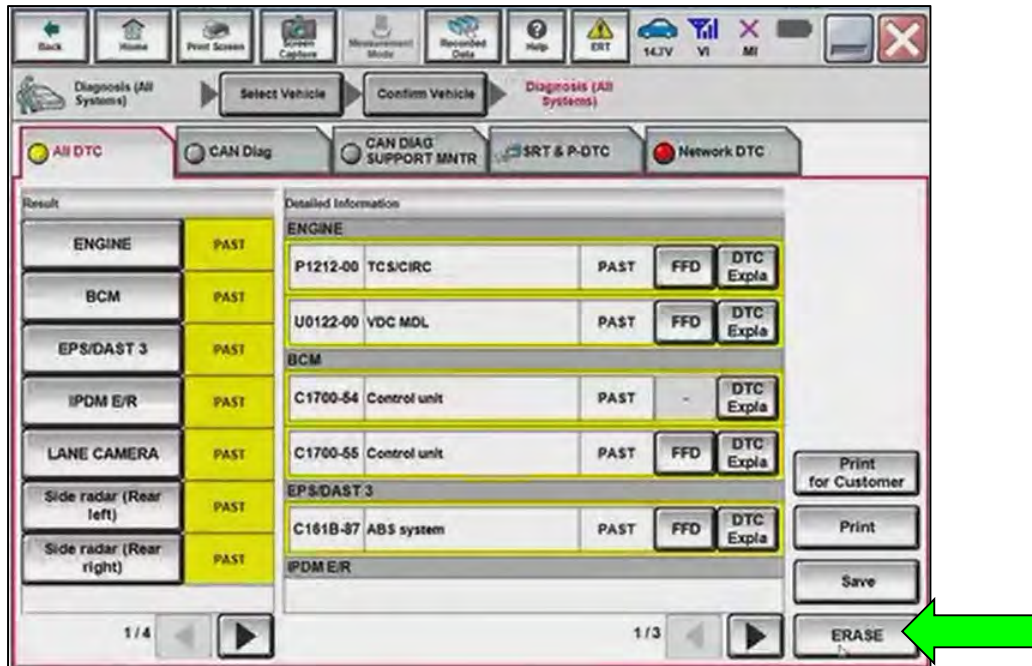

Figure 19

26. Select **Execute**.

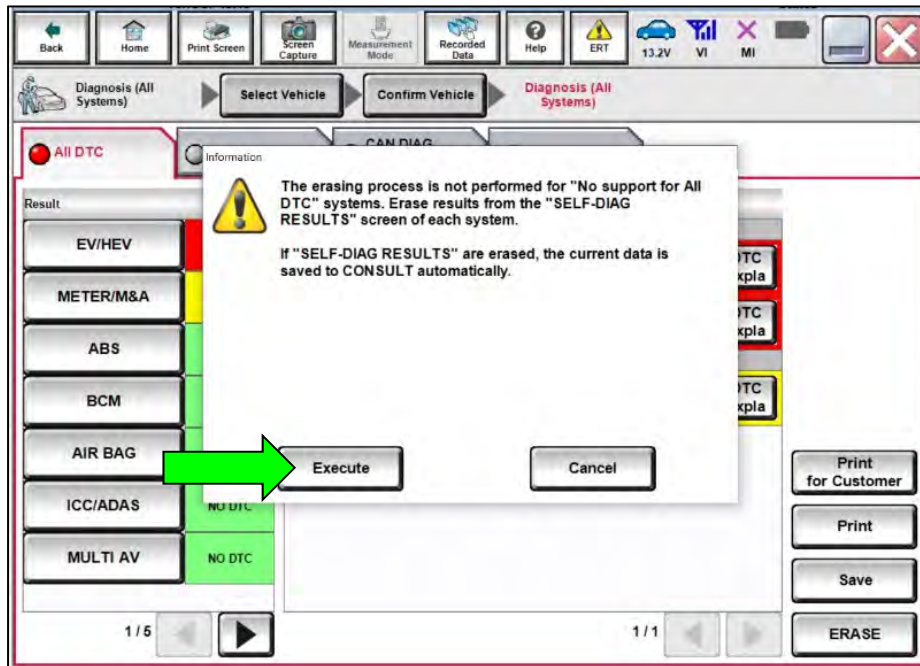

Figure 20

27. Select **Close**.

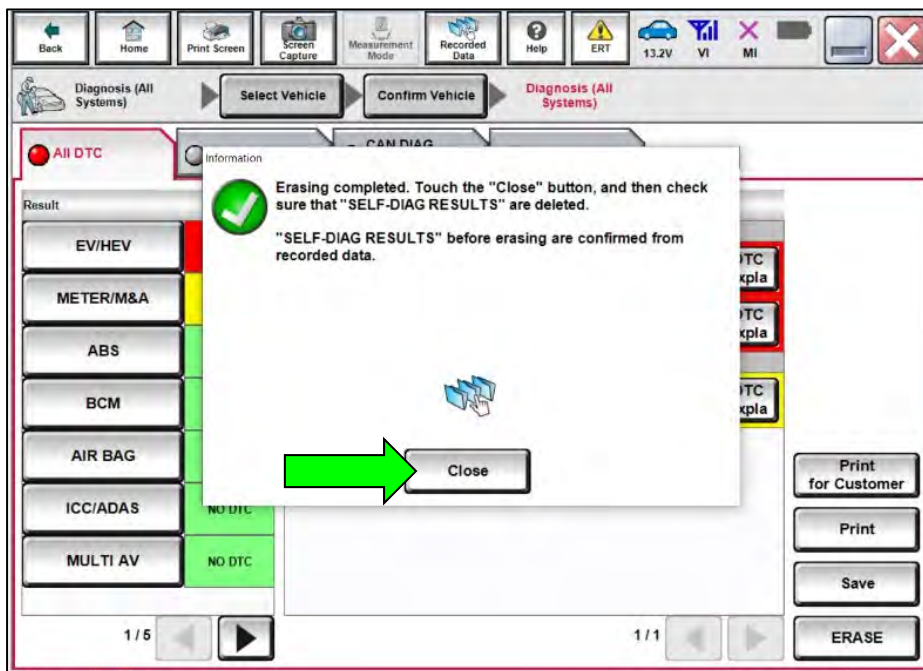

Figure 21

28. Close C-III plus.

29. Remove the VI from the vehicle.

30. Disconnect the battery maintainer/smart charger.

Calibrate Onboard Navigation

IMPORTANT: Perform this procedure only if the software update was performed.

31. Using a suitable tool, detach the Upper Ventilator Grille but do not remove it.

32. Disconnect the Sunload Sensor harness.

NOTICE

To avoid damage to the Sunload Sensor harness, it must be disconnected before performing the next steps. If not disconnected, damage to Sunload Sensor harness may occur.

33. Remove the Upper Ventilator Grille.

NOTICE

To avoid damage to the Instrument Panel and/or Center Speaker, the Upper Ventilator Grille must be completely removed before performing the next steps. If not removed, damage to the Instrument Panel and/or Center Speaker may occur.

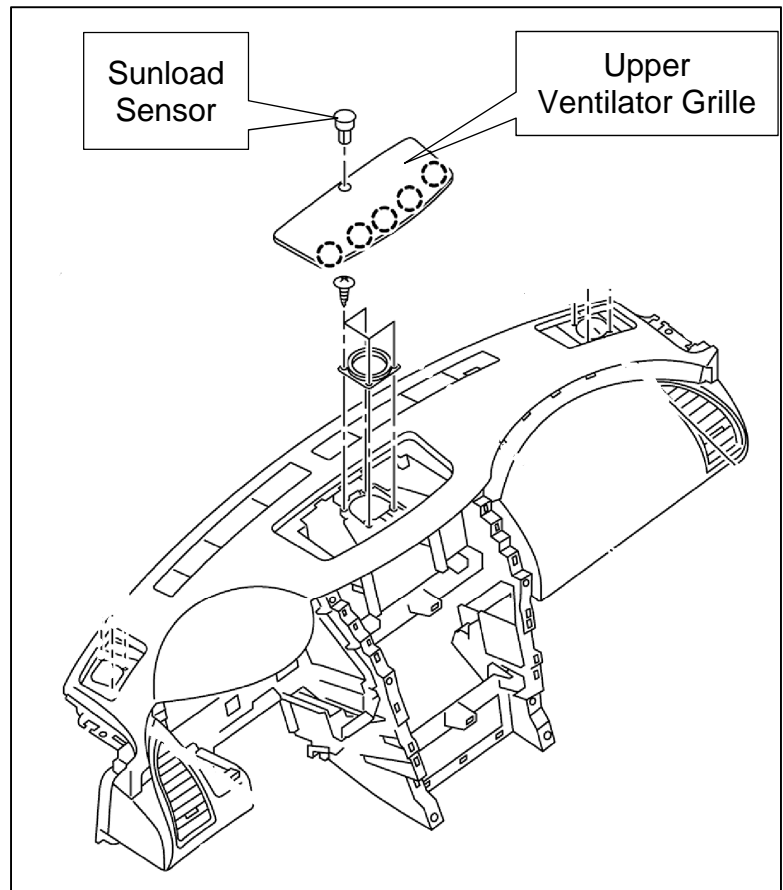

Figure 22

34. Turn the headlamps ON.
35. Drive the vehicle 3-6 miles AND for a minimum of 10 minutes.
36. Turn the engine OFF, and wait 5 minutes before proceeding to the next step.
HINT: The ignition must also be OFF during this time.
37. Drive the vehicle a short distance (approximately $\frac{1}{4}$ mile).
38. Confirm the navigation system is displaying the correct location.
 - If the correct location is not displayed, perform steps 35-38 again.
39. Turn the headlamps OFF.
40. Reattach the Sunload Sensor harness and the Upper Ventilator Grille.

2020 QX80 (Z62)

MANUAL SETTING ITEM		DETAIL
Items	Setting Value	
TELEMATICS	WITH	Models with telematics system
	WITHOUT	Models without telematics system
ANTI-THEFT CONTROL	WITH	Models with anti-theft system
	WITHOUT	Models without anti-theft system
Mobile entertainment system	WITH	Models with rear entertainment system
	WITHOUT	Models without rear entertainment system
FEB SYSTEM	OFF	Models without forward emergency brake system
	ON	Models with forward emergency brake system
AUDIO AMP TYPE	4ch AMP	Models with 13 speakers
	BosePerformance AMP	Models with 17 speakers
DESTINATION	U.S.A	For United States of America
	Canada	For Canada
	EUR	For Europe
	Russia	For Russia
	Mexico	For Mexico
	LAM	For Latin America
	Vietnam	For Vietnam
Wireless CarPlay	WITHOUT	Set this item to WITH.
	WITH	

2021 QX80 (Z62)

MANUAL SETTING ITEM		DETAIL
Items	Setting Value	
TELEMATICS	WITH	Models with telematics system
	WITHOUT	Models without telematics system
DAB FUNCTION	WITH	Applicable
	WITHOUT	Not applicable
Mobile entertainment system	WITH	Models with rear entertainment system
	WITHOUT	Models without rear entertainment system
FEB SYSTEM	OFF	Models without forward emergency brake system
	ON	Models with forward emergency brake system
NAVIGATION	WITH	Models with navigation system
	WITHOUT	Models without navigation system
AUDIO AMP TYPE	4ch AMP	Models with 13 speakers
	BosePerformance AMP	Models with 17 speakers
DESTINATION	U.S.A	For United States of America
	Canada	For Canada
	EUR	For Europe
	Russia	For Russia
	Mexico	For Mexico
	LAM	For Latin America
	GCC	For The Middle East (Gulf Cooperation Council)
Vietnam	For Vietnam	
Wireless CarPlay	WITHOUT	Set this item to WITH.
	WITH	

AMENDMENT HISTORY

PUBLISHED DATE	REFERENCE	DESCRIPTION
June 30, 2022	ITB22-027	Original bulletin published
April 13, 2023	ITB22-027A	Changes made throughout