

# Technical Service Bulletin

Mazda North American Operations  
Irvine, CA 92618-2922



<b>Subject:</b>  POWER OUTER MIRROR DOES NOT FOLD IN	<b>Bulletin No.:</b> 09-010/23
	<b>Last Issued :</b> 02/09/2023

## BULLETIN NOTES

This bulletin supersedes the previously issued bulletin(s) listed below. The changes are noted in Red.

Previous TSBs:	Date(s) Issued:
09-029/22	11/21/22 and 08/09/22

## APPLICABLE MODEL(S)/VINS

2019-2020 Mazda6 (with folding mirrors) with VINS from JM1GL\*\*\*\*\*500001 to 523650

## DESCRIPTION

Some vehicles may exhibit a condition where the power outer mirror will not fold in and/or out when the outer mirror holding switch (1) is operated.

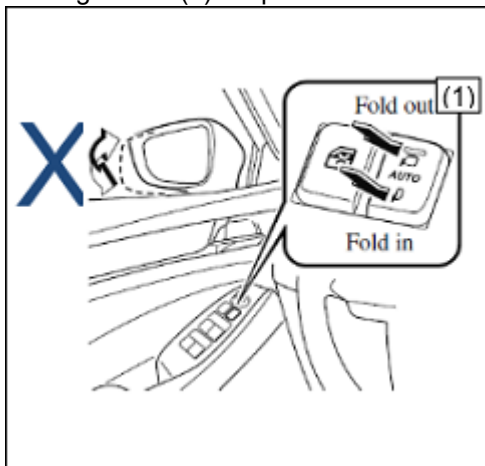

This may be caused by:

1. The electric fold-in unit inside the outer mirror may be damaged by corrosion from water entry due to insufficient water tightness.
2. The electric fold-in unit may interfere with the outer mirror frame due to improper installation of the electric fold-in unit.
3. The friction around the shaft of the folding mechanism may increase.

**CONSUMER NOTICE:** The information and instructions in this bulletin are intended for use by skilled technicians. Mazda technicians utilize the proper tools/ equipment and take training to correctly and safely maintain Mazda vehicles. These instructions should not be performed by "do-it-yourselfers." Customers should not assume this bulletin applies to their vehicle or that their vehicle will develop the described concern. To determine if the information applies, customers should contact their nearest authorized Mazda dealership. Mazda North American Operations reserves the right to alter the specifications and contents of this bulletin without obligation or advance notice. All rights reserved. No part of this bulletin may be reproduced in any form or by any means, electronic or mechanical--including photocopying and recording and the use of any kind of information storage and retrieval system ---without permission in writing.

To eliminate this concern, the following changes have been implemented:

1. The overlapping part of the water-proof sealing inside the electric fold-in unit (it cannot be seen from the outside) has been extended and the flange (1) has been attached instead of a water proof seal.

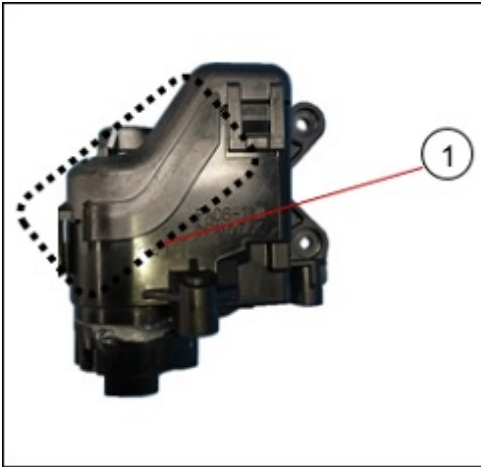

2. The height of the mirror frame rib has been changed.
3. The material of the washer has been changed and another washer has been added to the shaft.

Customers having this concern should have their vehicle repaired using the following repair procedure.

**CONSUMER NOTICE:** The information and instructions in this bulletin are intended for use by skilled technicians. Mazda technicians utilize the proper tools/ equipment and take training to correctly and safely maintain Mazda vehicles. These instructions should not be performed by "do-it-yourselfers." Customers should not assume this bulletin applies to their vehicle or that their vehicle will develop the described concern. To determine if the information applies, customers should contact their nearest authorized Mazda dealership. Mazda North American Operations reserves the right to alter the specifications and contents of this bulletin without obligation or advance notice. All rights reserved. No part of this bulletin may be reproduced in any form or by any means, electronic or mechanical---including photocopying and recording and the use of any kind of information storage and retrieval system ---without permission in writing.

## REPAIR PROCEDURE

1. Verify the customer concern.
2. Remove the power outer mirror according to instructions on MGSS (POWER OUTER MIRROR REMOVAL/ INSTALLATION).

### NOTE:

- Before removing the mirror, ensure the power outer mirror is set in the driving position (not in the fold-in position) as it cannot be disassembled if it is set in the fold-in position.
- There is no need to disconnect the negative battery terminal since the repair is performed with the ignition OFF. DO NOT turn the ignition ON while the outer mirror assembly is removed.
- Always take care when removing or installing the outer mirror from/to the base according to the instructions on MGSS (OUTER MIRROR GLASS REMOVAL).

**Attention for Vehicles Equipped with Side Camera, refer to "related content" in MGSS for details.**

## CAUTIONS WHEN REPAIRING POWER OUTER MIRROR FOLDING MALFUNCTIONS

1. There are two different tabs located in the mirror when replacing the mirror garnish (TAB A & TAB B). When removing the garnish, follow the instructions in MGSS ([OUTER MIRROR GARNISH REMOVAL/ INSTALLATION]) to ensure the tabs are not damaged during repair:  
Mazda6 - ([OUTER MIRROR GARNISH REMOVAL/ INSTALLATION])

Illustration indicates the left side of CX-5 (KF)

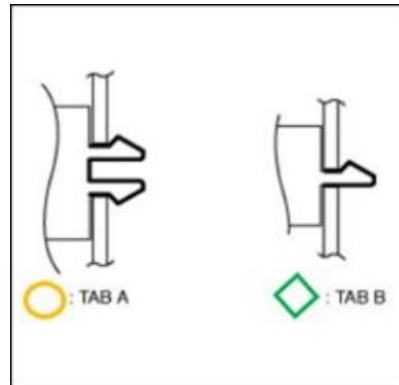
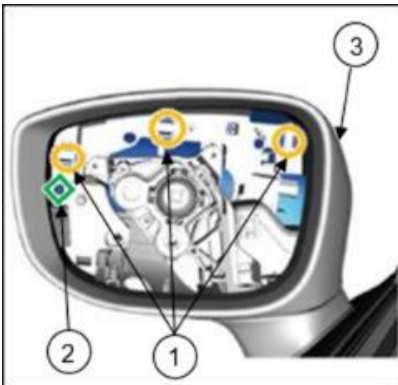

- (1) TAB A
- (2) TAB B
- (3) Upper outer mirror garnish

2. Screw in the outer mirror base and the inner base, then tighten the screws after placing the inner base on the outer mirror base.

**CONSUMER NOTICE:** The information and instructions in this bulletin are intended for use by skilled technicians. Mazda technicians utilize the proper tools/ equipment and take training to correctly and safely maintain Mazda vehicles. These instructions should not be performed by "do-it-yourselfers." Customers should not assume this bulletin applies to their vehicle or that their vehicle will develop the described concern. To determine if the information applies, customers should contact their nearest authorized Mazda dealership. Mazda North American Operations reserves the right to alter the specifications and contents of this bulletin without obligation or advance notice. All rights reserved. No part of this bulletin may be reproduced in any form or by any means, electronic or mechanical---including photocopying and recording and the use of any kind of information storage and retrieval system ---without permission in writing.

**CAUTION:** DO NOT use electric tools to tighten the screws (1) as they may be damaged if over tightened and may cause the outer mirror to malfunction while folding. When the tightening stops halfway, loosen the screw once, and then tighten it again.

3. Install the grommet (1) properly.

**CAUTION:** Improper grommet installation may cause the motor to malfunction due to water intrusion.

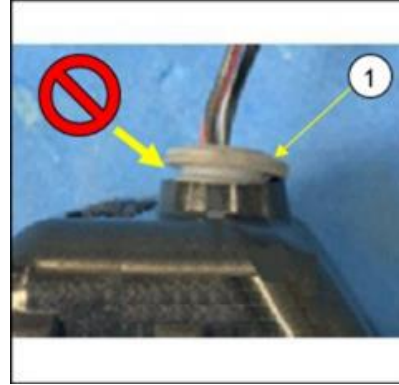
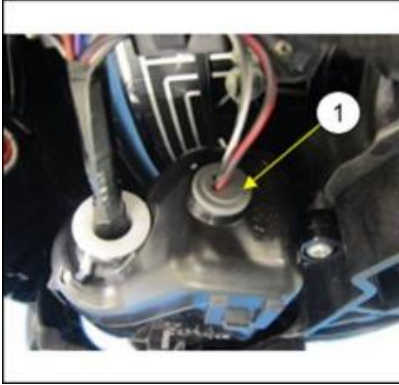

(1) Grommet

Improper installation



Rust occurs and progresses from the upper area of the motor.

**CONSUMER NOTICE:** The information and instructions in this bulletin are intended for use by skilled technicians. Mazda technicians utilize the proper tools/ equipment and take training to correctly and safely maintain Mazda vehicles. These instructions should not be performed by "do-it-yourselfers." Customers should not assume this bulletin applies to their vehicle or that their vehicle will develop the described concern. To determine if the information applies, customers should contact their nearest authorized Mazda dealership. Mazda North American Operations reserves the right to alter the specifications and contents of this bulletin without obligation or advance notice. All rights reserved. No part of this bulletin may be reproduced in any form or by any means, electronic or mechanical---including photocopying and recording and the use of any kind of information storage and retrieval system ---without permission in writing.

4. Replace the upper base cover with a new one as mounting tabs will be deformed or damaged when the original cover is removed.

**CAUTION:** Using the original upper base cover may cause the outer mirror to malfunction while folding due to insufficient tab engagement (part interference).

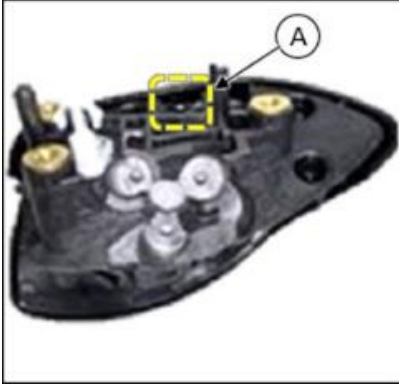

DETAIL A  
(1) Damaged tab

5. Install the base cover to the inner base properly.

**NOTE:** There have been cases of improper installation (1), resulting the outer mirror to malfunction while folding (part interference).

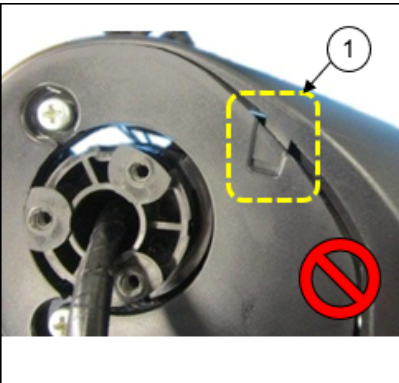

6. Install the screws in the reverse order of removal.

**CONSUMER NOTICE:** The information and instructions in this bulletin are intended for use by skilled technicians. Mazda technicians utilize the proper tools/ equipment and take training to correctly and safely maintain Mazda vehicles. These instructions should not be performed by "do-it-yourselfers." Customers should not assume this bulletin applies to their vehicle or that their vehicle will develop the described concern. To determine if the information applies, customers should contact their nearest authorized Mazda dealership. Mazda North American Operations reserves the right to alter the specifications and contents of this bulletin without obligation or advance notice. All rights reserved. No part of this bulletin may be reproduced in any form or by any means, electronic or mechanical---including photocopying and recording and the use of any kind of information storage and retrieval system ---without permission in writing.

**REMOVAL****NOTE:**

- Removal of the outer mirror glass can be facilitated by warming the back of the glass to approx. 50°C {122°F} to 60°C {140°F} degrees using **a hair dryer or a heat gun**.
- Be careful not to overheat the outer mirror as temperatures higher than 60°C {140°F} degrees could deform it.

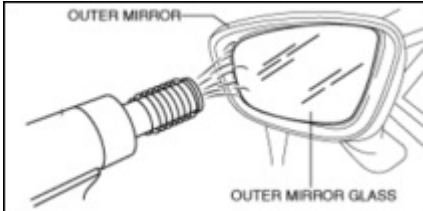
**Reference information**

**NOTE:** To prevent breakage during removal of the outer mirror glass, it is recommended to use a suction cup and pull at the two areas shown by the arrows.



1. Remove the outer mirror garnish according to the instructions on MGSS (OUTER MIRROR GARNISH REMOVAL/INSTALLATION).

**NOTE:** The procedure below is explained using pictures of a LH power outer mirror. The basic procedure is same for LH and RH power outer mirrors.

**CONSUMER NOTICE:** The information and instructions in this bulletin are intended for use by skilled technicians. Mazda technicians utilize the proper tools/ equipment and take training to correctly and safely maintain Mazda vehicles. These instructions should not be performed by "do-it-yourselfers." Customers should not assume this bulletin applies to their vehicle or that their vehicle will develop the described concern. To determine if the information applies, customers should contact their nearest authorized Mazda dealership. Mazda North American Operations reserves the right to alter the specifications and contents of this bulletin without obligation or advance notice. All rights reserved. No part of this bulletin may be reproduced in any form or by any means, electronic or mechanical---including photocopying and recording and the use of any kind of information storage and retrieval system ---without permission in writing.



2. Remove the seal rubber (1) from the power outer mirror base (2).

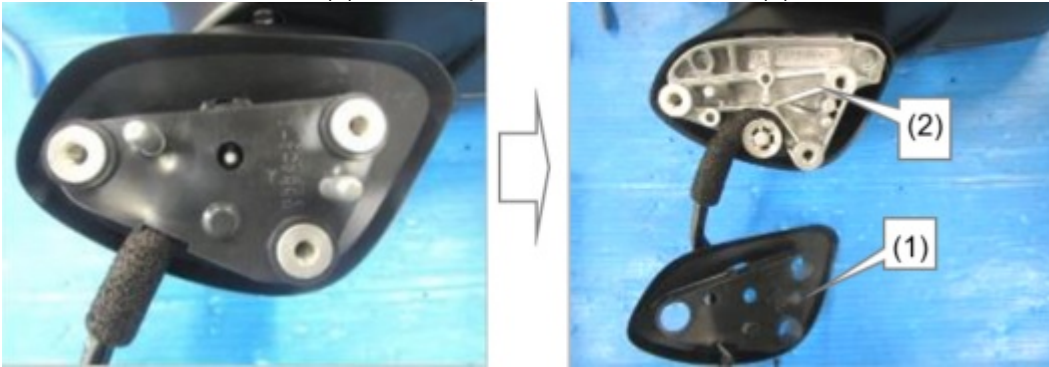

3. Using pliers, remove the push nut (1) from the power outer mirror base.



4. Pull out the base cover-lower in the direction of the arrow shown in the figure.



**CONSUMER NOTICE:** The information and instructions in this bulletin are intended for use by skilled technicians. Mazda technicians utilize the proper tools/ equipment and take training to correctly and safely maintain Mazda vehicles. These instructions should not be performed by "do-it-yourselfers." Customers should not assume this bulletin applies to their vehicle or that their vehicle will develop the described concern. To determine if the information applies, customers should contact their nearest authorized Mazda dealership. Mazda North American Operations reserves the right to alter the specifications and contents of this bulletin without obligation or advance notice. All rights reserved. No part of this bulletin may be reproduced in any form or by any means, electronic or mechanical---including photocopying and recording and the use of any kind of information storage and retrieval system ---without permission in writing.

5. Peel off the two seal packings (1) from the harness.

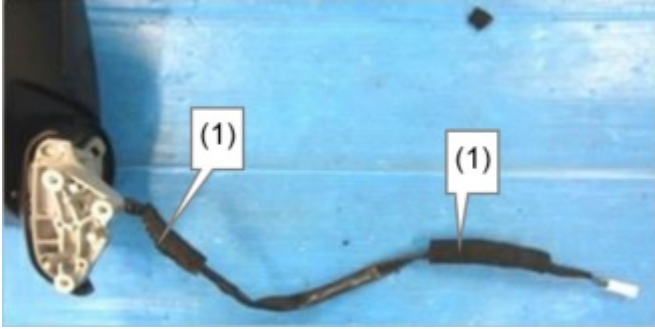

6. Remove the three screws circled in the figure, then remove the inner base (1) passing the harness (2) through it.

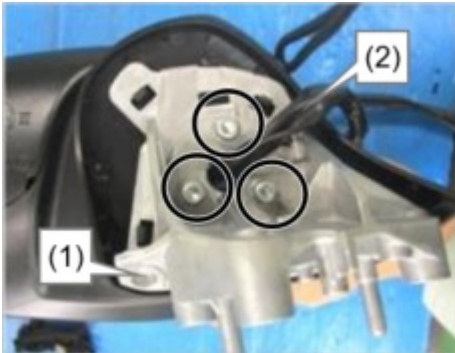

7. Disengage the four tabs circled in the figure, then remove the base cover-upper (1) from the inner base (2).



**CONSUMER NOTICE:** The information and instructions in this bulletin are intended for use by skilled technicians. Mazda technicians utilize the proper tools/ equipment and take training to correctly and safely maintain Mazda vehicles. These instructions should not be performed by "do-it-yourselfers." Customers should not assume this bulletin applies to their vehicle or that their vehicle will develop the described concern. To determine if the information applies, customers should contact their nearest authorized Mazda dealership. Mazda North American Operations reserves the right to alter the specifications and contents of this bulletin without obligation or advance notice. All rights reserved. No part of this bulletin may be reproduced in any form or by any means, electronic or mechanical---including photocopying and recording and the use of any kind of information storage and retrieval system ---without permission in writing.



## 8. Remove the mirror harnesses.

a. For outer mirror with side camera only: Disconnect the connector (1).

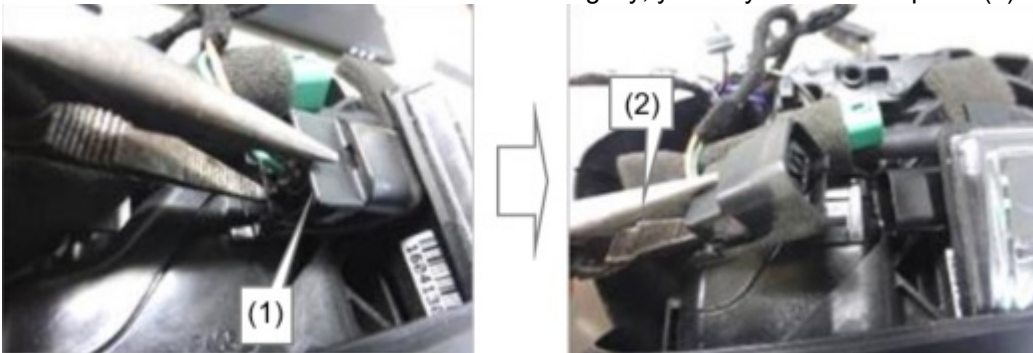

b. While pushing the lock, disconnect the connector (1).

**NOTE:** Since the connector is connected tightly, you may need to use pliers (2).

c. Remove the screw (1) and then remove the lower outer mirror garnish (2).

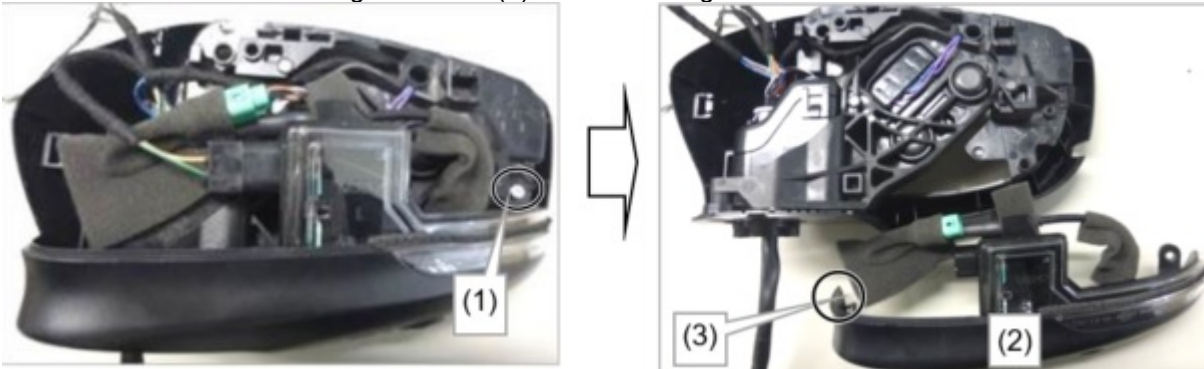
**NOTE:** DO NOT damage the hook (3) while removing.

**CONSUMER NOTICE:** The information and instructions in this bulletin are intended for use by skilled technicians. Mazda technicians utilize the proper tools/ equipment and take training to correctly and safely maintain Mazda vehicles. These instructions should not be performed by "do-it-yourselfers." Customers should not assume this bulletin applies to their vehicle or that their vehicle will develop the described concern. To determine if the information applies, customers should contact their nearest authorized Mazda dealership. Mazda North American Operations reserves the right to alter the specifications and contents of this bulletin without obligation or advance notice. All rights reserved. No part of this bulletin may be reproduced in any form or by any means, electronic or mechanical--including photocopying and recording and the use of any kind of information storage and retrieval system ---without permission in writing.

d. Remove the grommet (1) and pull out the mirror harness (2) while pushing the lock (3) with a small flat-blade screw driver.

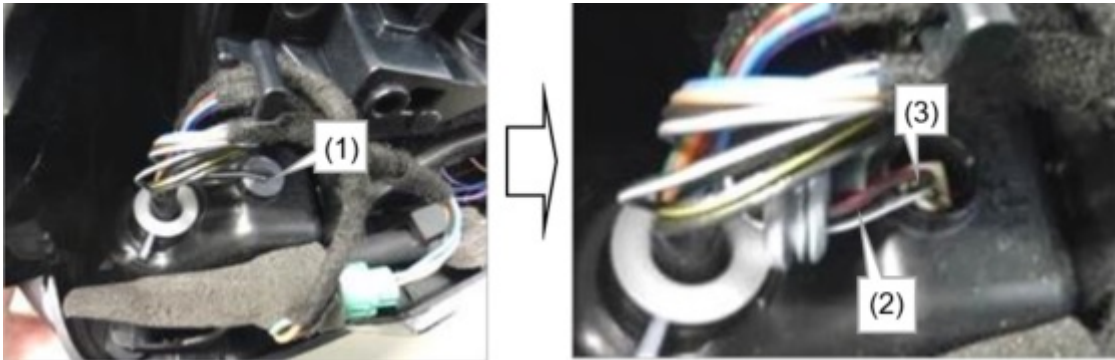

e. Pull out the mirror harness (1) and remove the connector (2).

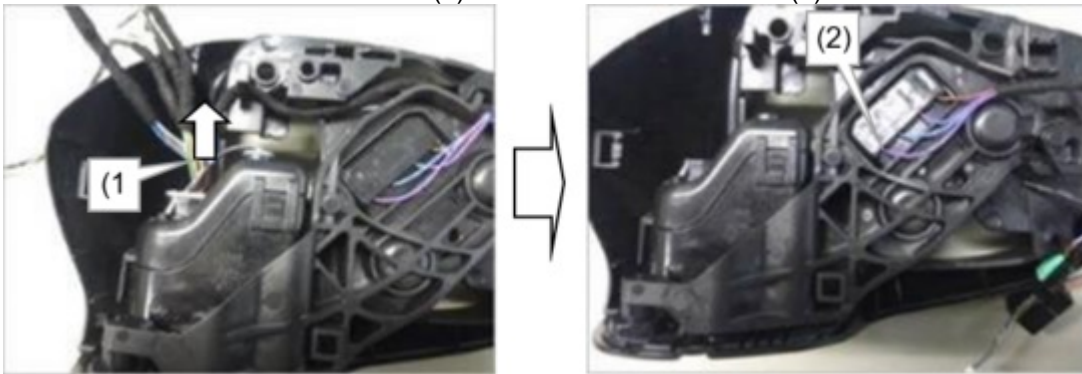

9. Remove the electric fold-in unit from the mirror body.

a. Remove screws circled in figures and remove the electric fold-in unit and the frame assembly in one unit.

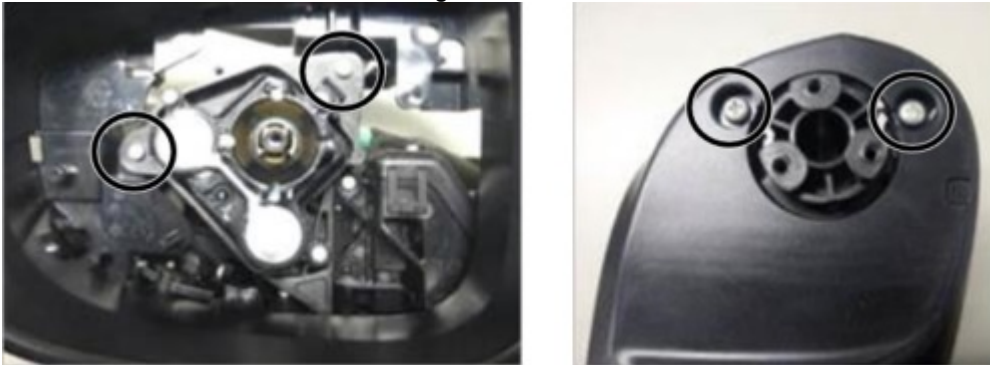

**CONSUMER NOTICE:** The information and instructions in this bulletin are intended for use by skilled technicians. Mazda technicians utilize the proper tools/ equipment and take training to correctly and safely maintain Mazda vehicles. These instructions should not be performed by "do-it-yourselfers." Customers should not assume this bulletin applies to their vehicle or that their vehicle will develop the described concern. To determine if the information applies, customers should contact their nearest authorized Mazda dealership. Mazda North American Operations reserves the right to alter the specifications and contents of this bulletin without obligation or advance notice. All rights reserved. No part of this bulletin may be reproduced in any form or by any means, electronic or mechanical--including photocopying and recording and the use of any kind of information storage and retrieval system ---without permission in writing.

- b. Remove screws circled in the left two figures, then separate the electric fold-in unit (1) from the frame assembly (2).

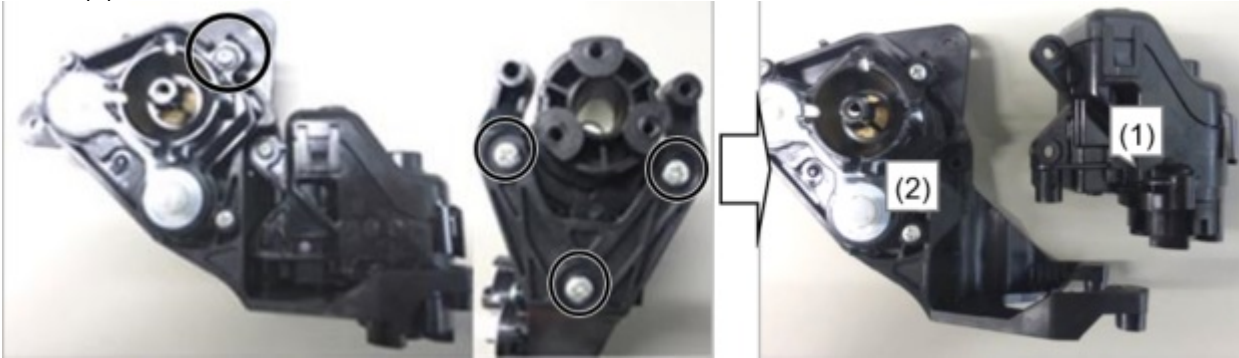

### Installation

10. Install a new electric fold-in unit from the KIT to the frame assembly and tighten the screws as shown in the figures.



11. Install the electric fold-in unit and frame assembly to the mirror body and tighten the screws as shown in the figures.

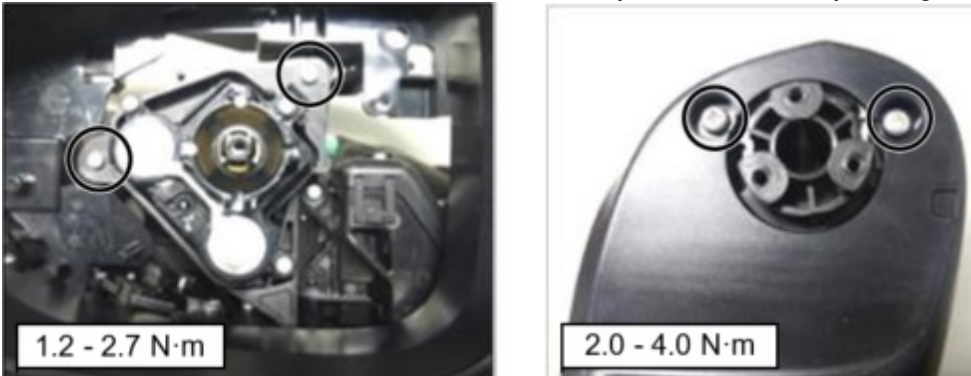

**CONSUMER NOTICE:** The information and instructions in this bulletin are intended for use by skilled technicians. Mazda technicians utilize the proper tools/ equipment and take training to correctly and safely maintain Mazda vehicles. These instructions should not be performed by "do-it-yourselfers." Customers should not assume this bulletin applies to their vehicle or that their vehicle will develop the described concern. To determine if the information applies, customers should contact their nearest authorized Mazda dealership. Mazda North American Operations reserves the right to alter the specifications and contents of this bulletin without obligation or advance notice. All rights reserved. No part of this bulletin may be reproduced in any form or by any means, electronic or mechanical---including photocopying and recording and the use of any kind of information storage and retrieval system ---without permission in writing.



## 12. Install the mirror harness.

- a. Install the connector (1) and install the mirror harness (2), then fit the harness in the clip (3).

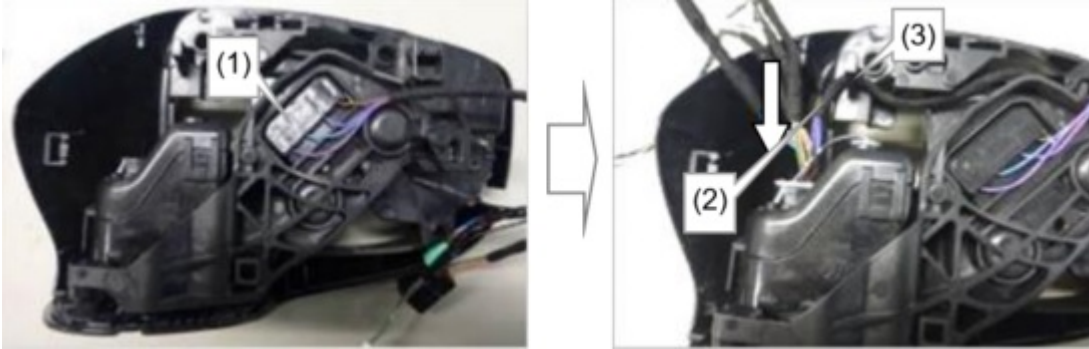

- b. Install the harness cap (1) without any clearance (2) remaining between the electric fold-in unit.

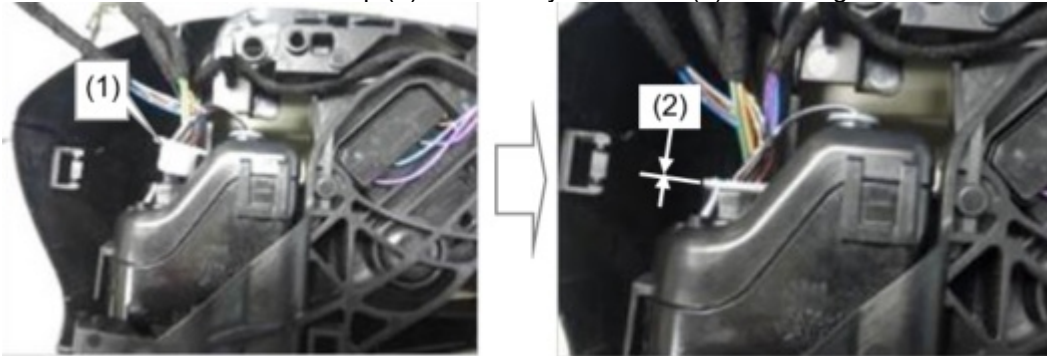

- c. Connect the connector (1) and install the grommet (2).

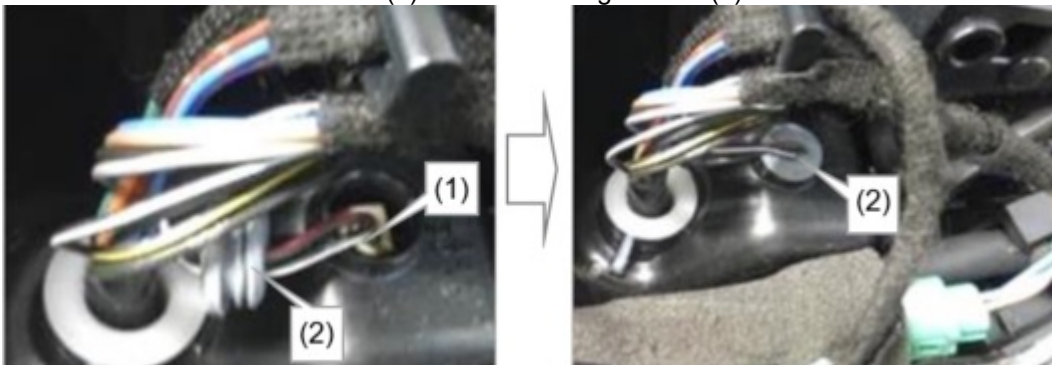

**CONSUMER NOTICE:** The information and instructions in this bulletin are intended for use by skilled technicians. Mazda technicians utilize the proper tools/ equipment and take training to correctly and safely maintain Mazda vehicles. These instructions should not be performed by "do-it-yourselfers." Customers should not assume this bulletin applies to their vehicle or that their vehicle will develop the described concern. To determine if the information applies, customers should contact their nearest authorized Mazda dealership. Mazda North American Operations reserves the right to alter the specifications and contents of this bulletin without obligation or advance notice. All rights reserved. No part of this bulletin may be reproduced in any form or by any means, electronic or mechanical---including photocopying and recording and the use of any kind of information storage and retrieval system ---without permission in writing.

d. Install the lower outer mirror garnish engaging the hook (1), then tighten the screw (2).



**NOTE:** Install the lower outer garnish in the correct position.

#### Samples of garnish installed incorrectly



e. Install the connector (1).

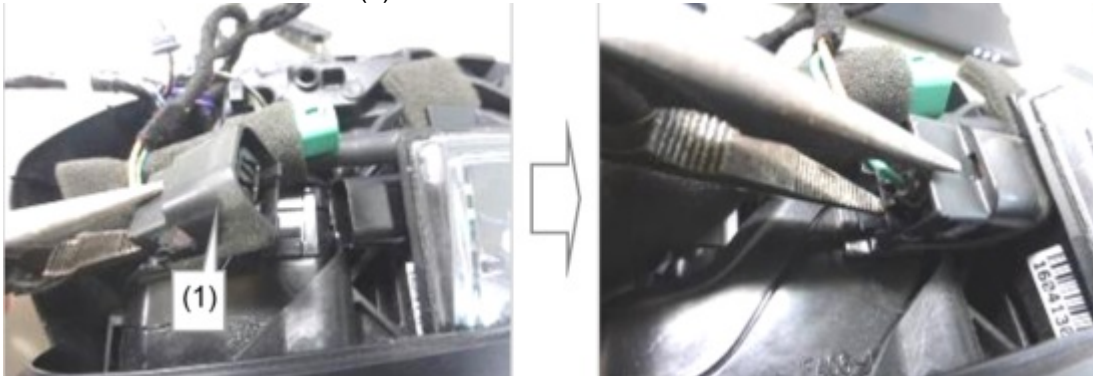

**CONSUMER NOTICE:** The information and instructions in this bulletin are intended for use by skilled technicians. Mazda technicians utilize the proper tools/ equipment and take training to correctly and safely maintain Mazda vehicles. These instructions should not be performed by "do-it-yourselfers." Customers should not assume this bulletin applies to their vehicle or that their vehicle will develop the described concern. To determine if the information applies, customers should contact their nearest authorized Mazda dealership. Mazda North American Operations reserves the right to alter the specifications and contents of this bulletin without obligation or advance notice. All rights reserved. No part of this bulletin may be reproduced in any form or by any means, electronic or mechanical---including photocopying and recording and the use of any kind of information storage and retrieval system ---without permission in writing.



f. For vehicles with side camera only: Install the connector.

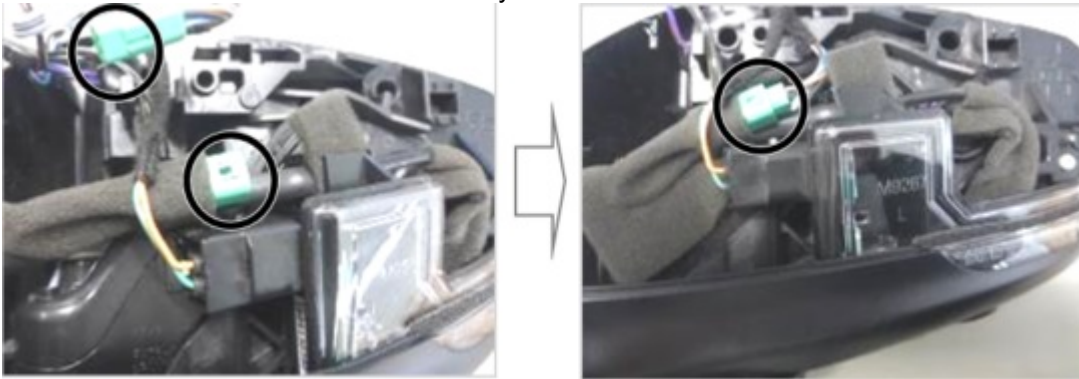

13. Install the inner base.

a. While aligning locators circled in figures, install a new base cover-upper (1) from the KIT to the inner base (2).

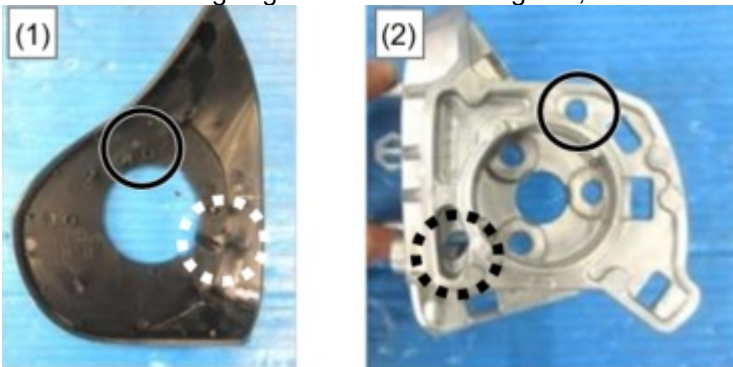

b. Install the inner base (1) to the mirror (2) while aligning the locators.  
**NOTE: DO NOT** pinch the harness (3).

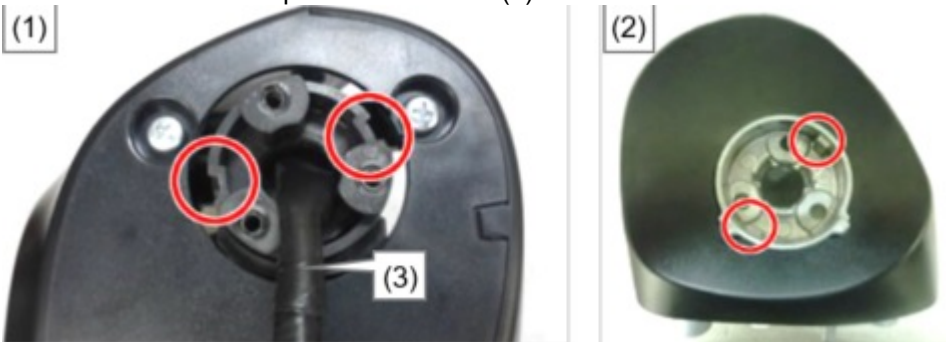

**CONSUMER NOTICE:** The information and instructions in this bulletin are intended for use by skilled technicians. Mazda technicians utilize the proper tools/ equipment and take training to correctly and safely maintain Mazda vehicles. These instructions should not be performed by "do-it-yourselfers." Customers should not assume this bulletin applies to their vehicle or that their vehicle will develop the described concern. To determine if the information applies, customers should contact their nearest authorized Mazda dealership. Mazda North American Operations reserves the right to alter the specifications and contents of this bulletin without obligation or advance notice. All rights reserved. No part of this bulletin may be reproduced in any form or by any means, electronic or mechanical---including photocopying and recording and the use of any kind of information storage and retrieval system ---without permission in writing.

c. Tighten the three screws.



14. Install a new packing (2) from the KIT to the position as shown in the figure.

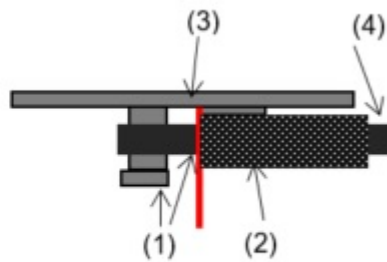

1	Hook for harness
2	Packing
3	Inner base
4	Harness

15. Install the base cover-lower (1) from the KIT to the inner base without clearance.

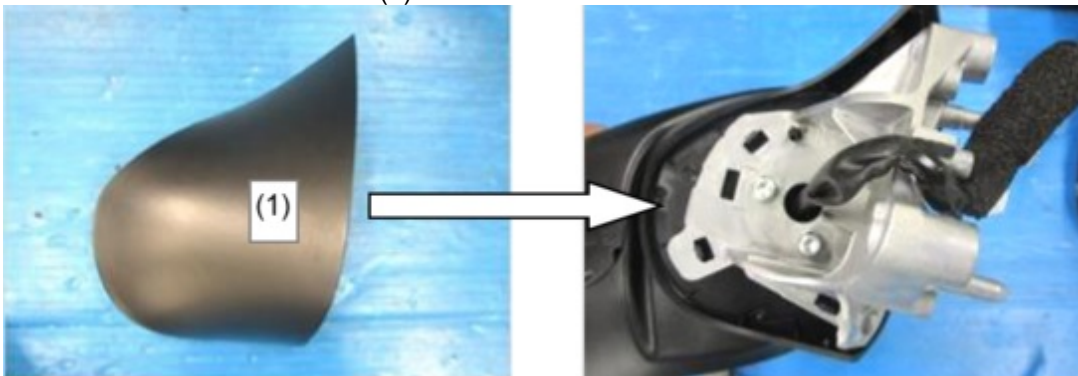

**CONSUMER NOTICE:** The information and instructions in this bulletin are intended for use by skilled technicians. Mazda technicians utilize the proper tools/ equipment and take training to correctly and safely maintain Mazda vehicles. These instructions should not be performed by "do-it-yourselfers." Customers should not assume this bulletin applies to their vehicle or that their vehicle will develop the described concern. To determine if the information applies, customers should contact their nearest authorized Mazda dealership. Mazda North American Operations reserves the right to alter the specifications and contents of this bulletin without obligation or advance notice. All rights reserved. No part of this bulletin may be reproduced in any form or by any means, electronic or mechanical--including photocopying and recording and the use of any kind of information storage and retrieval system ---without permission in writing.

16. After confirming that the harness is correctly routed, install the push nut (1) from the KIT.



**NOTE:** Using an appropriate size box socket, push the push nut (1) in until seated to the inner base (2) without clearance (3).

**-No Good with clearance-**



17. Install the seal rubber (1) and pull out the harness (2) through the slit as shown in the figure.

**NOTE:** The slit will be closed by the seal packing without any clearance.

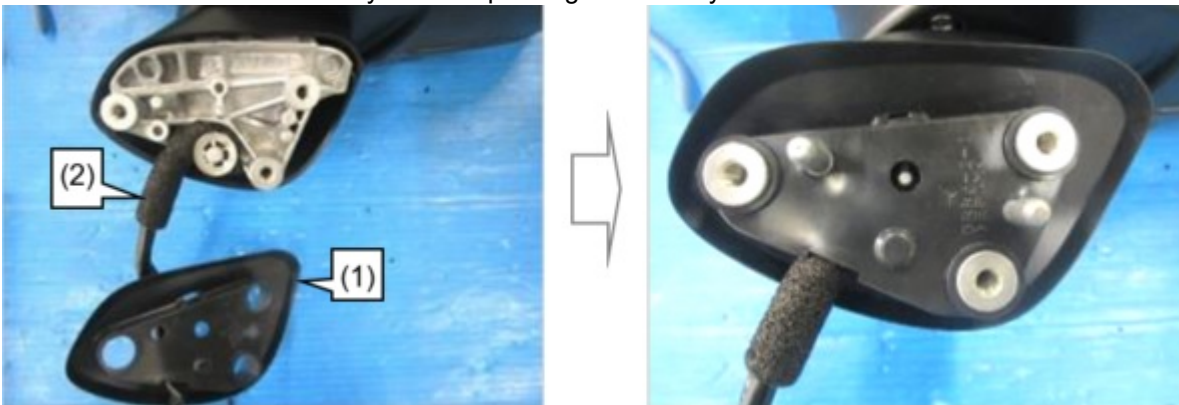

**CONSUMER NOTICE:** The information and instructions in this bulletin are intended for use by skilled technicians. Mazda technicians utilize the proper tools/ equipment and take training to correctly and safely maintain Mazda vehicles. These instructions should not be performed by "do-it-yourselfers." Customers should not assume this bulletin applies to their vehicle or that their vehicle will develop the described concern. To determine if the information applies, customers should contact their nearest authorized Mazda dealership. Mazda North American Operations reserves the right to alter the specifications and contents of this bulletin without obligation or advance notice. All rights reserved. No part of this bulletin may be reproduced in any form or by any means, electronic or mechanical---including photocopying and recording and the use of any kind of information storage and retrieval system ---without permission in writing.

**NOTE:** If the seal rubber (1) is correctly installed, the three bosses (2) on the inner base are 2mm projected from the seal rubber.

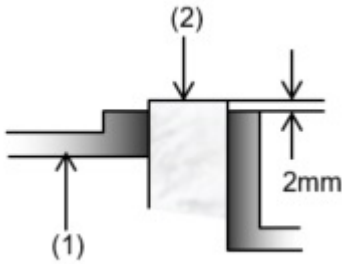

18. Install a new packing (1) from the KIT to the position on the harness as shown in the figure.

**NOTE:** Confirm that the length of the harness is  $410 \pm 10\text{mm}$ .

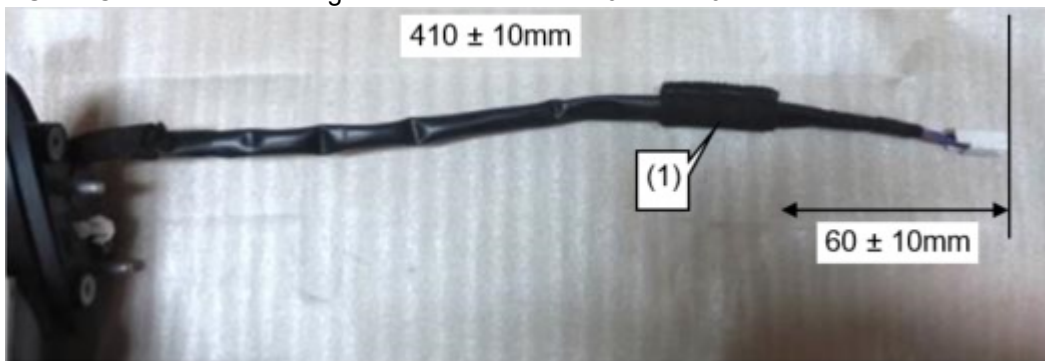

19. Install the outer mirror garnish according to instructions on MGSS (OUTER MIRROR GARNISH REMOVAL/ INSTALLATION).

20. Install the power outer mirror according to instructions on MGSS (POWER OUTER MIRROR REMOVAL/ INSTALLATION).

**NOTE:** Always take care when removing or installing the outer mirror from/to the base according to instructions on MGSS (OUTER MIRROR GLASS INSTALLATION).

**CONSUMER NOTICE:** The information and instructions in this bulletin are intended for use by skilled technicians. Mazda technicians utilize the proper tools/ equipment and take training to correctly and safely maintain Mazda vehicles. These instructions should not be performed by "do-it-yourselfers." Customers should not assume this bulletin applies to their vehicle or that their vehicle will develop the described concern. To determine if the information applies, customers should contact their nearest authorized Mazda dealership. Mazda North American Operations reserves the right to alter the specifications and contents of this bulletin without obligation or advance notice. All rights reserved. No part of this bulletin may be reproduced in any form or by any means, electronic or mechanical---including photocopying and recording and the use of any kind of information storage and retrieval system ---without permission in writing.



**Installation**

**NOTE:**

- Installation of the outer mirror glass can be facilitated by heating the outer mirror glass holder to approx. 50°C {122°F} to 60°C {140°F} degrees using **a hair drier or a heat gun**.
- Be careful not to overheat the outer mirror, as temperatures higher than 60°C {140°F} degrees could deform it.

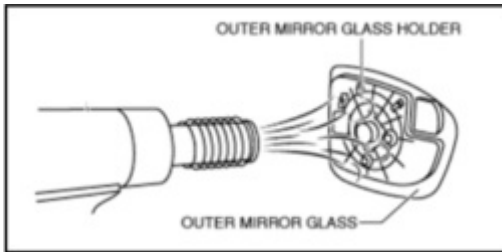

21. Repeat from the beginning of the repair procedure if necessary to repair the other side mirror.
22. For power outer mirror with side camera: Perform 360°view monitor system aiming according to the instructions on MGSS (360°VIEW MONITOR SYSTEM AIMING).
23. Verify the repair.

**PARTS INFORMATION**

Parts Number	Description	Qty.	Notes
GRY0-69-16ZC	Electric Fold-in Unit Kit	1	Left Mirror
GRY0-69-15ZC		1	Right Mirror

**NOTE:** The kit includes the following parts.

1. Electric Fold-in Unit
2. Seal Packing (2)
3. Base Cover #1
4. Base Cover #2
5. Push Nut

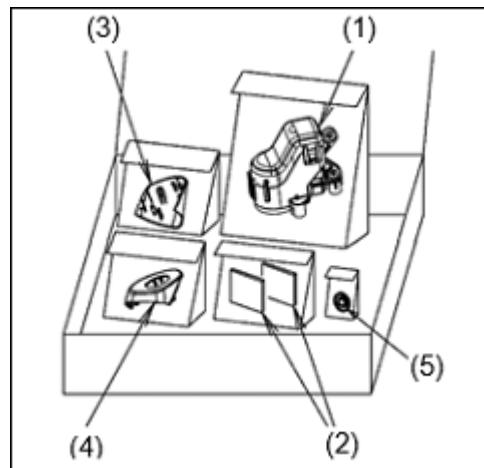

**CONSUMER NOTICE:** The information and instructions in this bulletin are intended for use by skilled technicians. Mazda technicians utilize the proper tools/ equipment and take training to correctly and safely maintain Mazda vehicles. These instructions should not be performed by "do-it-yourselfers." Customers should not assume this bulletin applies to their vehicle or that their vehicle will develop the described concern. To determine if the information applies, customers should contact their nearest authorized Mazda dealership. Mazda North American Operations reserves the right to alter the specifications and contents of this bulletin without obligation or advance notice. All rights reserved. No part of this bulletin may be reproduced in any form or by any means, electronic or mechanical---including photocopying and recording and the use of any kind of information storage and retrieval system ---without permission in writing.



**NOTE:** Since the modification has been implemented during the production of the part number with suffix B, it is necessary to check the suffix and the LOT number of the obtained parts as shown.

Part Number	For the repair
GRY*-69-1*Z	DO NOT use
GRY*-69-1*ZA	DO NOT use
GRY*-69-1*ZB	Depends on the LOT number
GRY*-69-1*ZC	To be used without checking the LOT number

LOT number	For the repair
0B19 or before	DO NOT use
0B20 or later	To be used

LOT number is printed on the label attached to the package.



The lot number is in **YMDD** format.

**Y** is the last digit of the year.

**M** is the month code A-L (A:Jan., B:Feb., C:Mar...).

**DD** is the date.

Example: 0C16 means 2020-March-16

Month code	Month	Month code	Month
A	January	G	July
B	February	H	August
C	March	I	September
D	April	J	October
E	May	K	November
F	June	L	December

**CONSUMER NOTICE:** The information and instructions in this bulletin are intended for use by skilled technicians. Mazda technicians utilize the proper tools/ equipment and take training to correctly and safely maintain Mazda vehicles. These instructions should not be performed by "do-it-yourselfers." Customers should not assume this bulletin applies to their vehicle or that their vehicle will develop the described concern. To determine if the information applies, customers should contact their nearest authorized Mazda dealership. Mazda North American Operations reserves the right to alter the specifications and contents of this bulletin without obligation or advance notice. All rights reserved. No part of this bulletin may be reproduced in any form or by any means, electronic or mechanical--including photocopying and recording and the use of any kind of information storage and retrieval system ---without permission in writing.

**WARRANTY INFORMATION****NOTE:**

- This warranty information applies only to verified customer complaints on vehicles eligible for warranty repair.
- This repair will be covered under Mazda's New Vehicle Limited Warranty term.
- Additional diagnostic time cannot be claimed for this repair.

Warranty Type	A
Symptom Code	64
Damage Code	9W
Part Number Main Cause	****-69-16Z* / ****-69-15Z* Select the applicable part number from "PARTS INFORMATION".
Quantity	1
Operation Number / Labor Hours:	<p>1) Without Side Camera          XXP3GARX / 0.6 Hrs. (One side)          XXP3GCRX / 1.1 Hrs. (Both Sides)</p> <p>2) With Side Camera          i. When camera aiming adjustment is completed by performing 360° view monitor system screen display verification procedure.          XXP3GERX / 0.8 Hrs. (One side)          XXP3GGRX / 1.4 Hrs. (Both Sides)          ii. When camera aiming adjustment is completed by performing 360° view monitor system screen display verification procedure &amp; Side Camera Aiming Procedure.          XXP3GJRX / 1.0 Hrs. (One side)          XXP3GLRX / 1.7 Hrs. (Both Sides)</p>

**CONSUMER NOTICE:** The information and instructions in this bulletin are intended for use by skilled technicians. Mazda technicians utilize the proper tools/ equipment and take training to correctly and safely maintain Mazda vehicles. These instructions should not be performed by "do-it-yourselfers." Customers should not assume this bulletin applies to their vehicle or that their vehicle will develop the described concern. To determine if the information applies, customers should contact their nearest authorized Mazda dealership. Mazda North American Operations reserves the right to alter the specifications and contents of this bulletin without obligation or advance notice. All rights reserved. No part of this bulletin may be reproduced in any form or by any means, electronic or mechanical--including photocopying and recording and the use of any kind of information storage and retrieval system ---without permission in writing.