



# QUALITY ACTION

# CAMPAIGN BULLETIN

## Stop Lamp CHMSL Harness Dealer Inventory

Reference: PC929

Date: January 18, 2023

**Attention: Dealer Principal, Sales, Service & Parts Managers**

Affected Models/Years:	Affected Population:	Dealer Inventory:	SERVICE COMM Activation date:	Stop Sale In Effect
2022-2023 Frontier (D41)	NA	<b>3,402</b>	January 18, 2023	<b>YES</b>

**\*\*\*\*\*Dealer Announcement\*\*\*\*\***

Nissan is conducting a dealer inventory quality action to add a relay to the stop lamp CHMSL harness and reprogram the ABS control module on specific MY2022-2023 Nissan Frontier vehicles identified in Service Comm and National Service History – Open Campaigns to prevent against a potential no start condition. Use the attached procedure to remedy any vehicles affected by this quality action prior to sale.

Affected vehicles are subject to stop sale and are either currently in dealer inventory or assigned and in transit to the dealer.

**\*\*\*\*\*What Dealers Should Do\*\*\*\*\***

**PLEASE FOLLOW THE ATTACHED INSTRUCTIONS:**

1. Verify if vehicles are affected by this quality action using Service Comm or DBS National Service History – Open Campaigns I.D. **PC929**
  - New vehicles in dealer inventory can also be identified using DBS (Sales-> Vehicle Inventory, and filter by Open Campaign).
    - Refer to NPSB 15-460 for additional information
  - **Please continue to check newly arriving inventory for campaign applicability.**
2. Please **do not drive, loan, sell or trade** the specific vehicles in dealer inventory subject to this quality action.
3. Use the attached procedure to remedy any vehicles affected by this quality action prior to sale.
4. Once remedied, dealers should submit the applicable warranty claim for the action performed to close the campaign notice in Service Comm/NSH and release the vehicle for sale.

**\*\*\*\* Dealer Responsibility \*\*\*\***

It is the dealer's responsibility to check Service Comm or DBS National Service History - Open Campaign using the appropriate campaign ID for the campaign status on each affected vehicle currently in new vehicle inventory.



## PC929 – 2022-2023 FRONTIER STOP LAMP CHMSL HARNESS

### REQUIRED SPECIAL TOOLS

Each dealer has been previously shipped:

- One Flameless Heat Gun, special tool J-46538 (NI-46538 ) (or suitable tool).

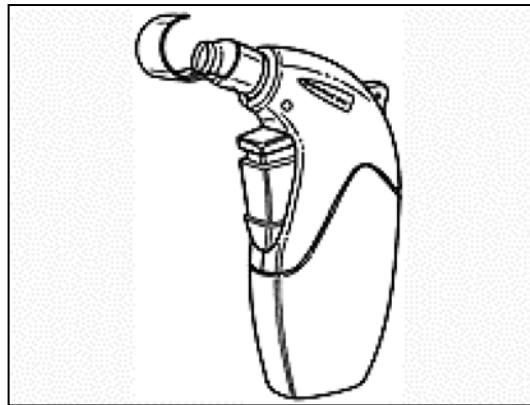

Figure 1

- Fluke Model 365, special tool NI-53364.

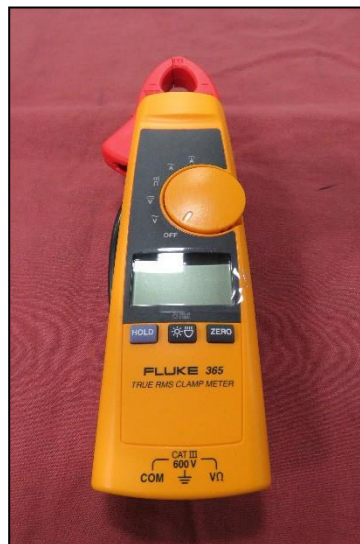

Figure 2

- Additional tools may be purchased from Tech•Mate online: [techmatetools.com](http://techmatetools.com), or by phone: 1-833-397-3493.

## INSTALL CENTER HIGH MOUNT STOP LAMP (CHMSL) RELAY AND JUMPER HARNESS:

1. Write down the radio settings.

Presets	1	2	3	4	5	6
AM						
FM 1						
FM 2						
XM 1						
XM 2						
XM 3						
Bass	Treble		Balance	Fade	Speed Sen. Vol.	

2. Open the vehicle's hood and place a fender cover or clean shop cloth on the passenger (RH) side fender.



Figure 3

3. Disconnect the negative battery cable

4. Remove the IPDM E/R and Relay Box covers.

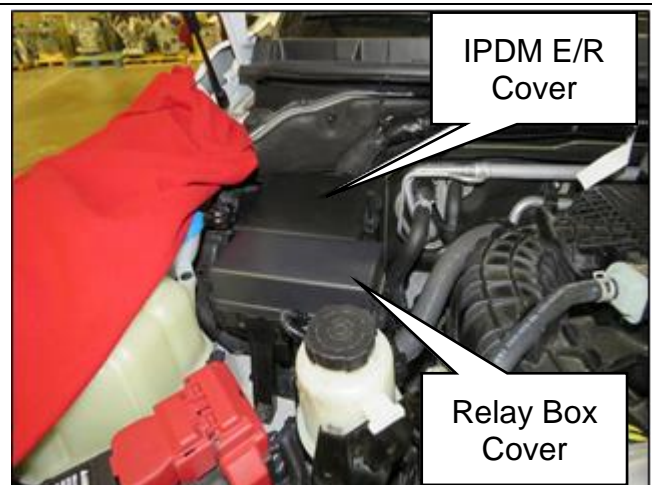

Figure 4

5. Disengage the EGI wire harness from the EGI wire harness retaining clip.

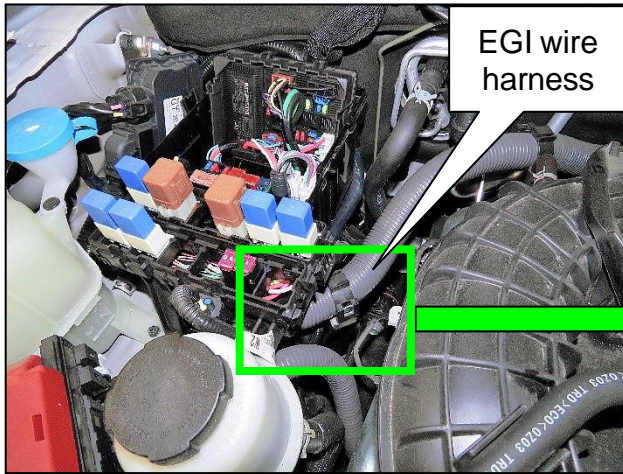

Figure 6

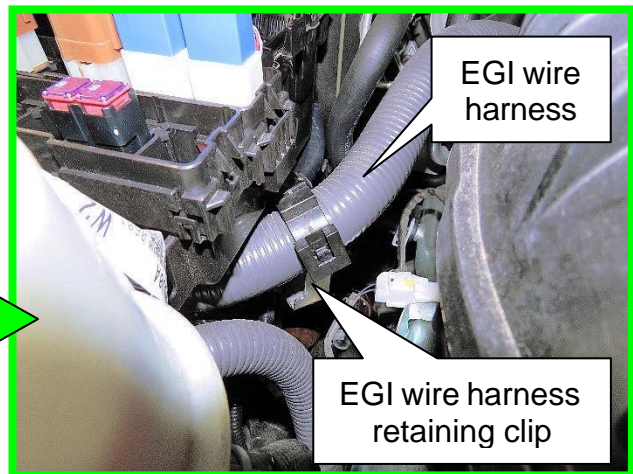

Figure 7

6. Lift up on the power steering reservoir to remove it from the holding bracket.

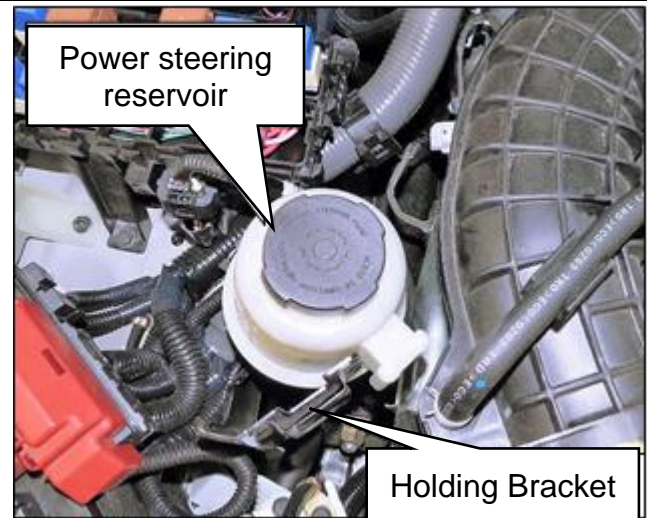

Figure 8

7. Remove the relay box mounting bolt.

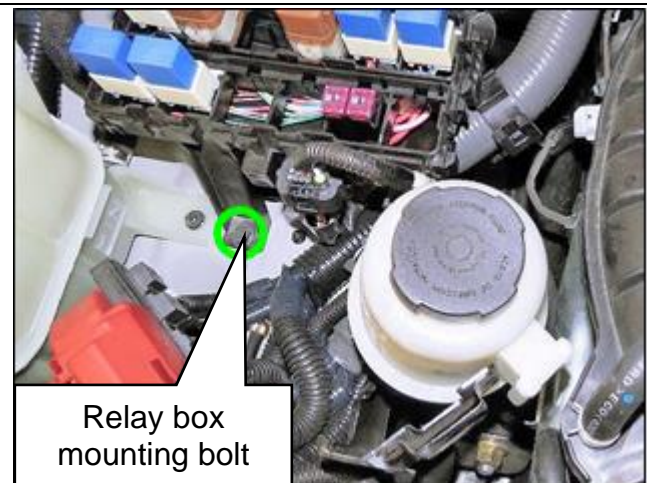

Figure 9



8. Lift up on the wire harness connector to remove it from the relay box.

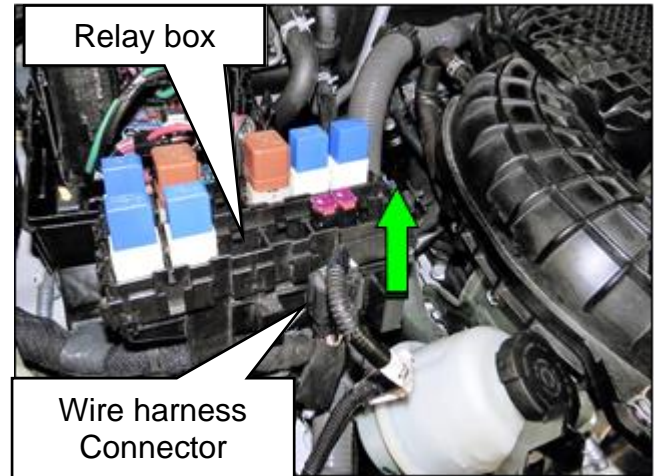

Figure 10

9. Using a flat-blade screwdriver or suitable tool, disengage the four (4) locks to open the relay box (Figure 11), and then remove the relay box lower assembly (Figure 12).

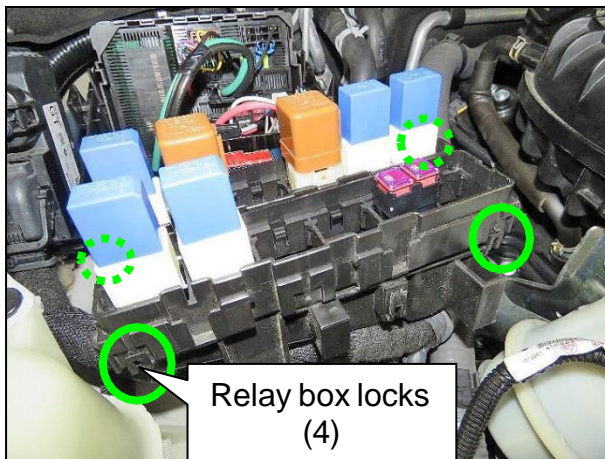

Figure 11

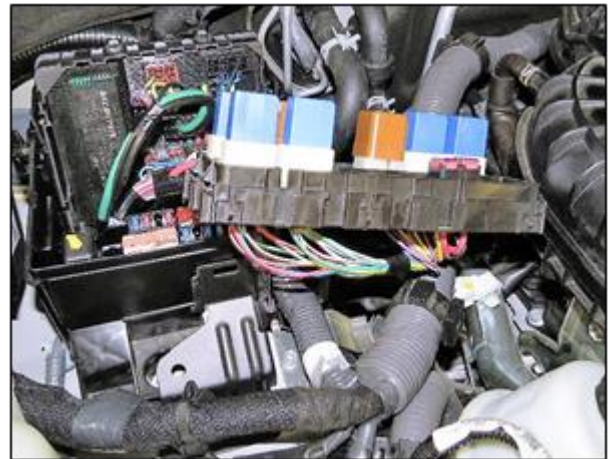

Figure 12

10. Remove the reverse lamp relay from the relay box.

- Figure 13 shown with relay removed

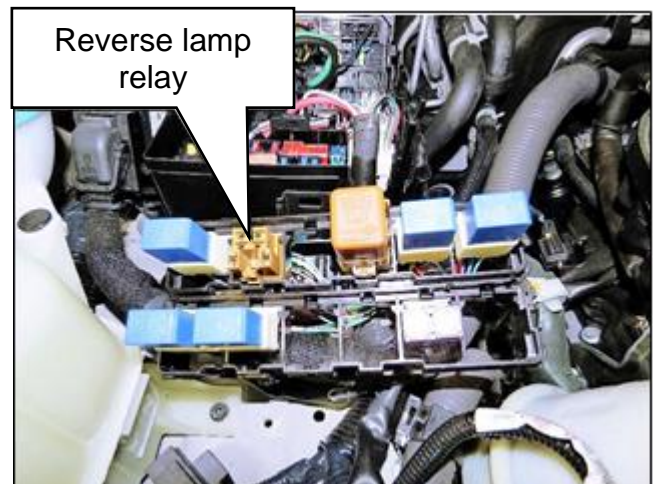

Figure 13

11. Turn the relay box over, remove the electrical tape from the relay box wire harness (Figure 14), and locate the pink wire from the reverse lamp relay connector (Figure 15).

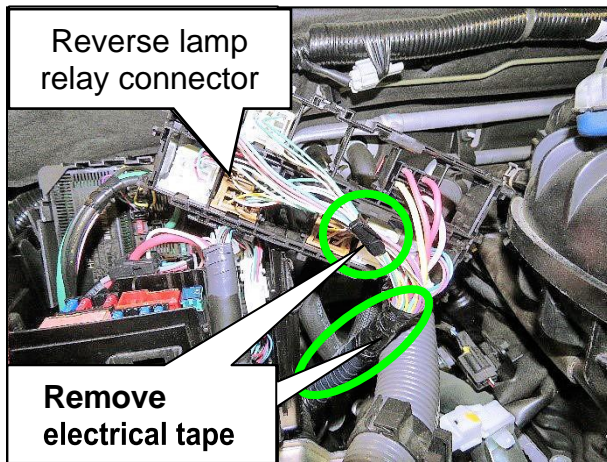

Figure 14

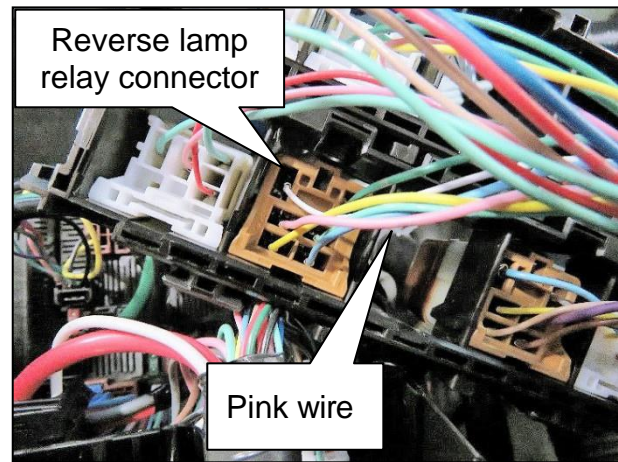

Figure 15

12. Cut the pink wire from the reverse lamp relay connector, and then remove 10 mm (0.4 in.) of insulation from the wire ends.

- Approximate location of pink wire cut shown in Figure 16

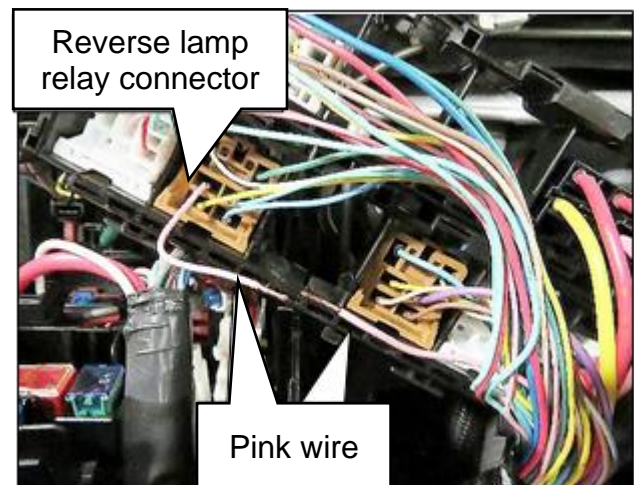

Figure 16

13. Twist together the red wire from the CHMSL jumper harness and the pink wire from the reverse lamp relay connector, and then slide on a solder sleeve, as shown in Figure 17.

- Obtain CHMSL jumper harness from parts. Refer to PARTS INFORMATION for part number

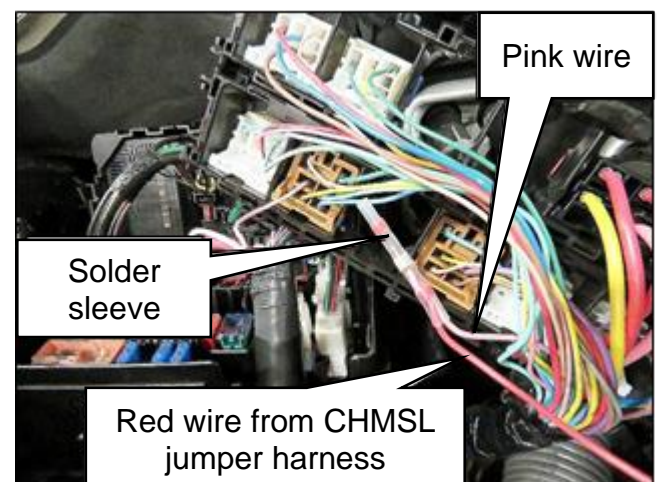

Figure 17



14. Insert the other end of the pink wire, from the reverse lamp relay connector, into the solder sleeve, and then using a flameless heat gun, special tool J-46538, heat the solder sleeve until the solder has been fully melted into the wires, as shown in Figure 18.

- If needed, refer to **Quick Reference for Using Solder Sleeve Connectors, steps 52-57**

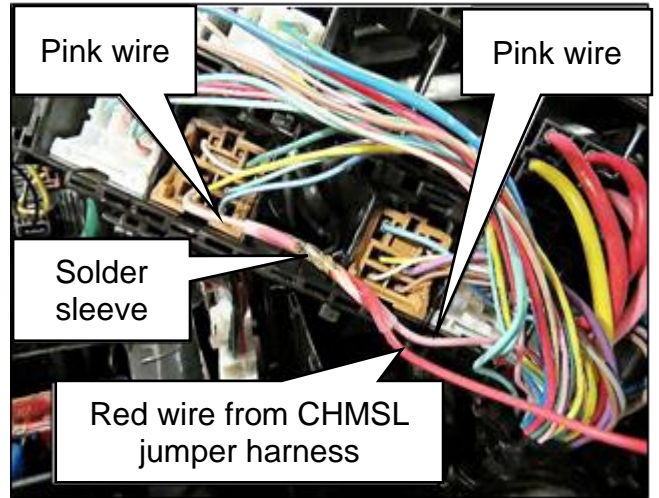

Figure 18

15. Remove the injector relay from the relay box.

- Figure 19 shown with relay removed



Figure 19

16. Turn the relay box over and locate the gray wire from the injector relay connector.

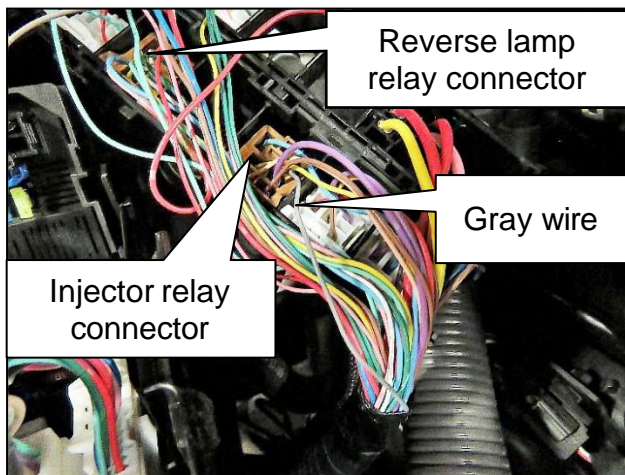

Figure 20

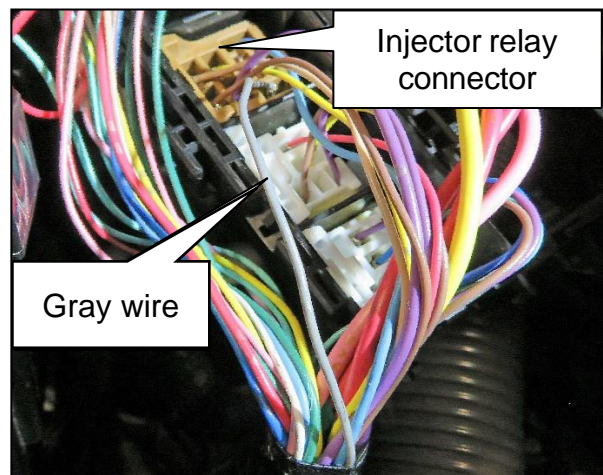

Figure 21



17. Cut the gray wire from the injector relay connector, and then remove 10 mm (0.4 in.) of insulation from the wire ends.

- Approximate location of gray wire cut shown in Figure 22

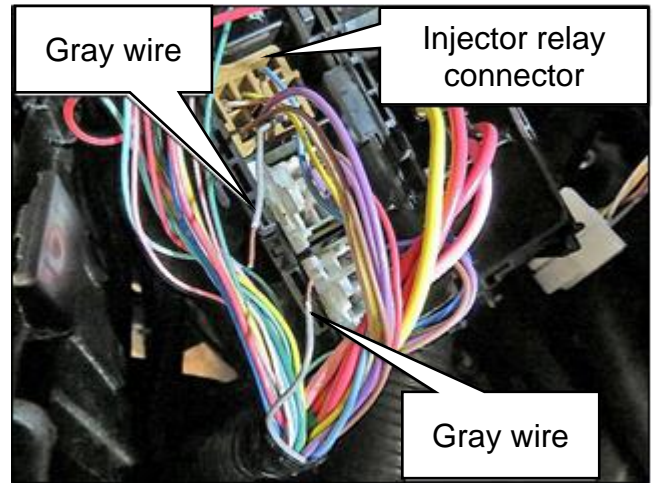

Figure 22

18. Twist together the gray wire from the CHMSL jumper harness and the gray wire from the injector relay connector and slide on a solder sleeve, as shown in Figure 23.

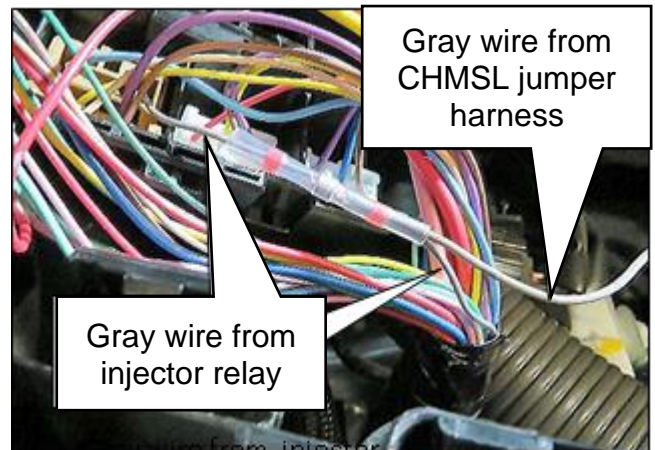

Figure 23

19. Insert the other end of the gray wire, from the injector relay connector, into the solder sleeve (Figure 23), and then using a flameless heat gun, special tool J-46538, heat the solder sleeve until the solder has been fully melted into the wires, as shown in Figure 24.

- If needed, refer to **Quick Reference for Using Solder Sleeve Connectors, steps 52-57**



Figure 24

20. Wrap both solder sleeve connectors with electrical tape, as shown in Figure 25.

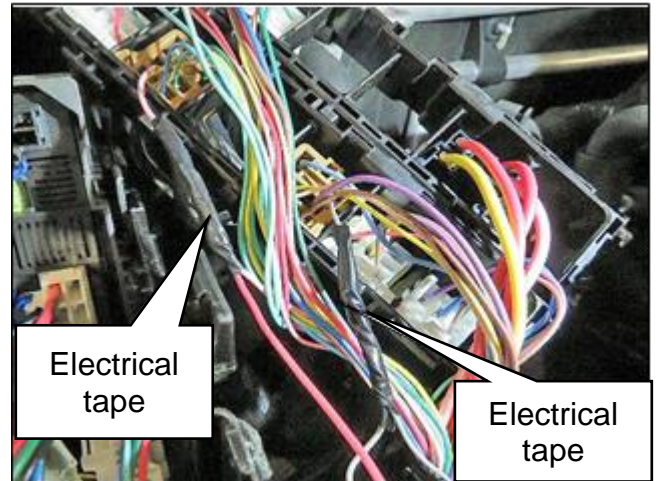

Figure 25

21. Insert the CHMSL relay connector from the CHMSL jumper harness into the open relay slot shown in Figure 26.

- Figure 26 shows CHMSL relay connector installed into the open relay slot

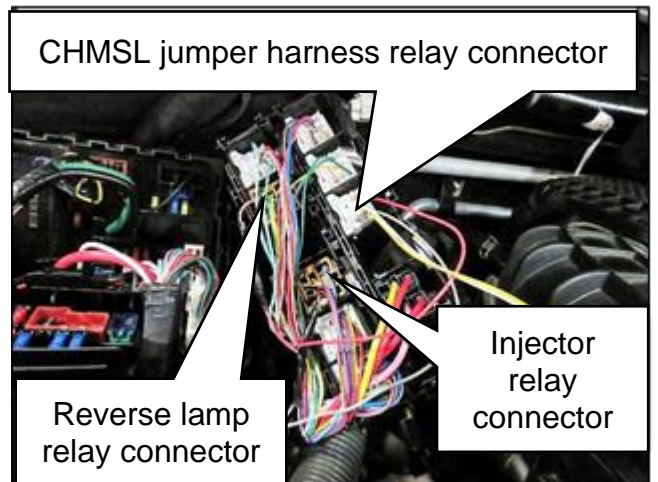

Figure 26

22. Tape together the relay box wire harness and the CHMSL jumper harness using electrical tape.

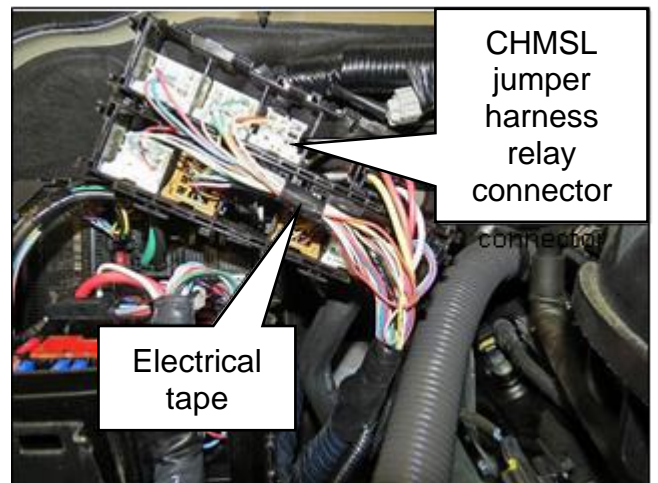

Figure 27



23. Reattach the lower assembly of the relay box to the upper assembly.
- **NOTE:** Make sure all four (4) relay box locks are connected and secured

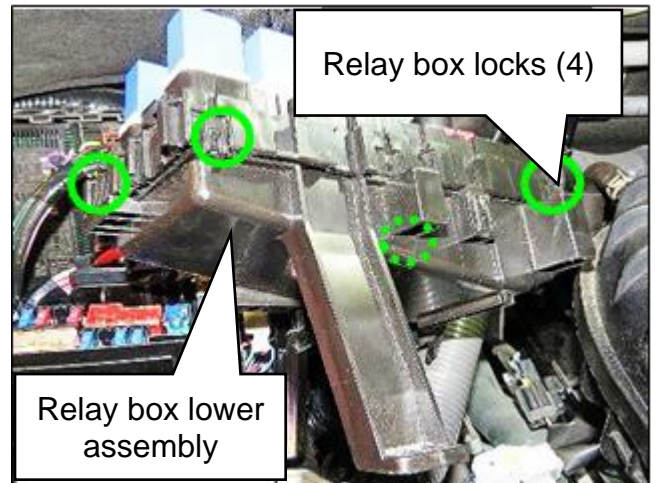

Figure 28

24. Tape the wire harness going into the relay box using electrical tape.

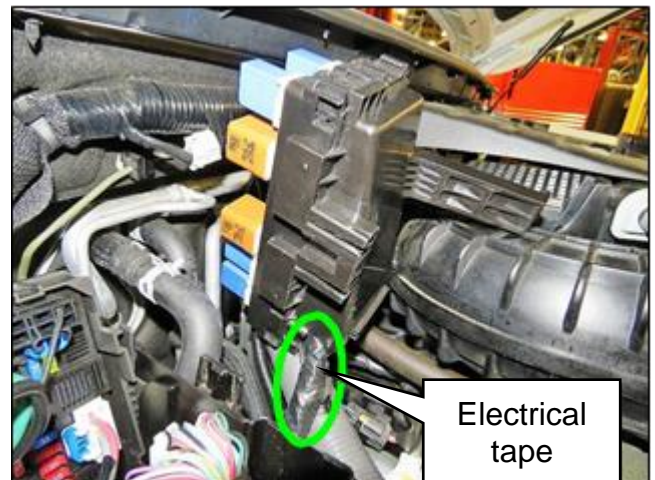

Figure 29

25. Reinstall the relay box, and then install the reverse lamp and injector relays.

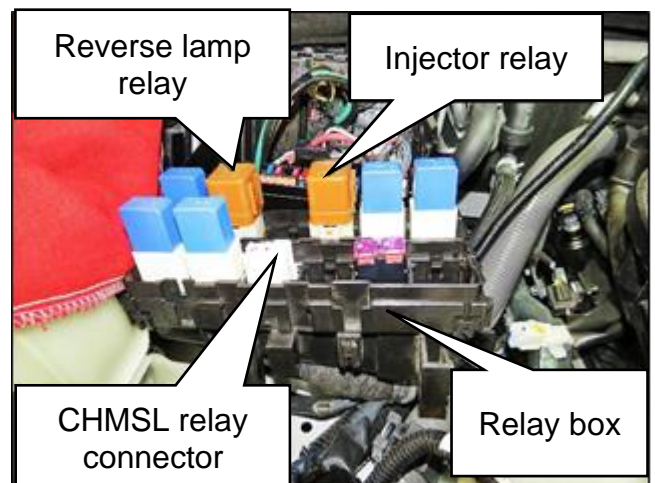

Figure 30



26. Route the CHMSL jumper harness next to the relay box wire harness, behind the IPDM E/R box, and up the bulkhead.

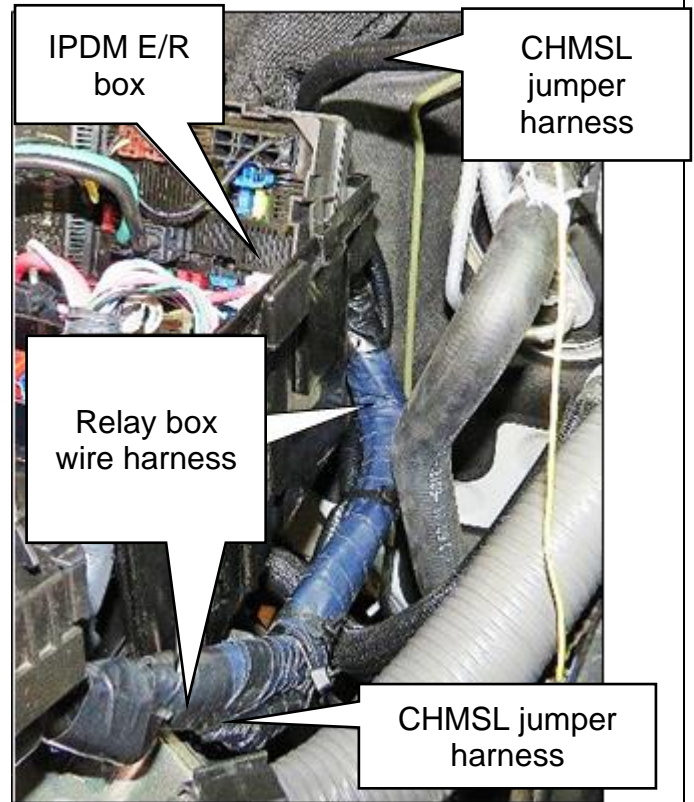

Figure 31

27. Secure the CHMSL jumper harness to the relay box wire harness using tie bands.

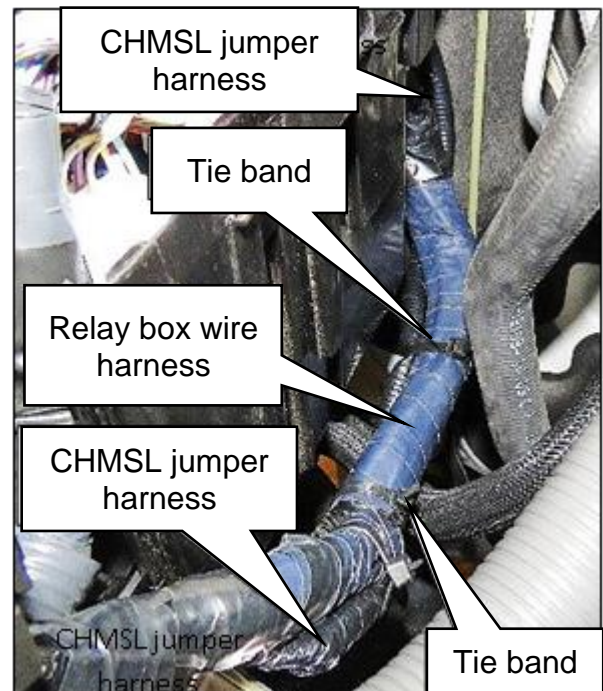

Figure 32

28. Remove the engine room wire harness retaining clip and the wire harness covering (Figure 33) to expose the wires in the engine room wire harness (Figure 34).

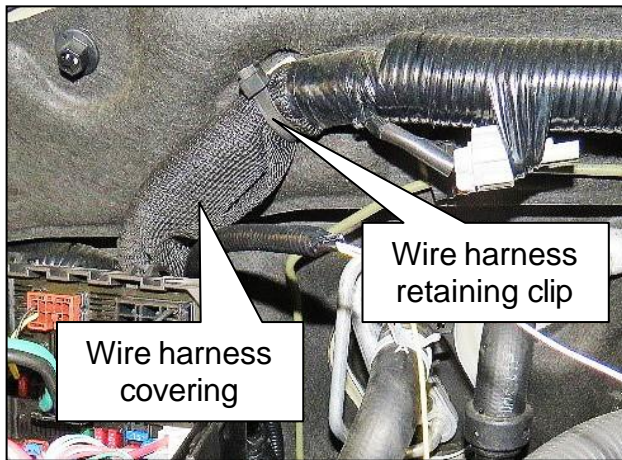

Figure 33

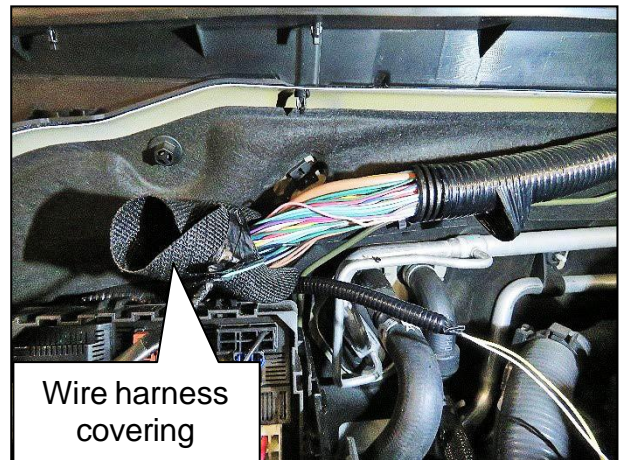

Figure 34

29. Using the Fluke Model 365 (ammeter), special tool NI-53364, identify the yellow stop lamp switch wire in the engine room wire harness as follows:

**IMPORTANT:** There are up to four (4) identical yellow wires in the engine room wire harness. The Fluke Model 365, special tool NI-53364, **must** be used to correctly identify the stop lamp switch wire.

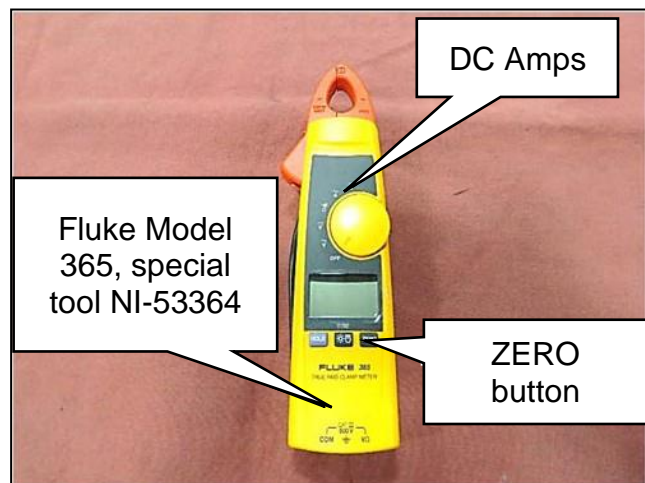

Figure 35

- a. Connect the negative battery terminal.
- b. Set the ammeter to DC Amps (Figure 35).
- c. Zero out the ammeter by pressing the **ZERO** button under the display (Figure 35).

d. Place one of the yellow wires in the ammeter's circumferential clamp, and then have a helper depress the brake pedal.

- The ammeter should have a reading of 0.8A – 1.0A with the brake pedal depressed.

**NOTE:** If there is not a reading of 0.8A – 1.0A, try a different yellow wire from the wire harness until the correct wire is located.

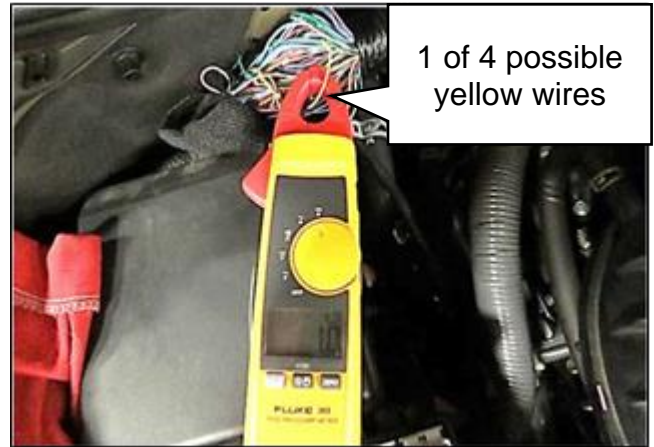

Figure 36

30. Remove the High-Mounted Stop Lamp assembly.

- Refer to the ESM: **DRIVER CONTROLS > EXTERIOR LIGHTING SYSTEM > REMOVAL AND INSTALLATION > HIGH-MOUNTED STOP LAMP > Removal and Installation**

31. Remove the high-mounted stop lamp assembly light bulb.

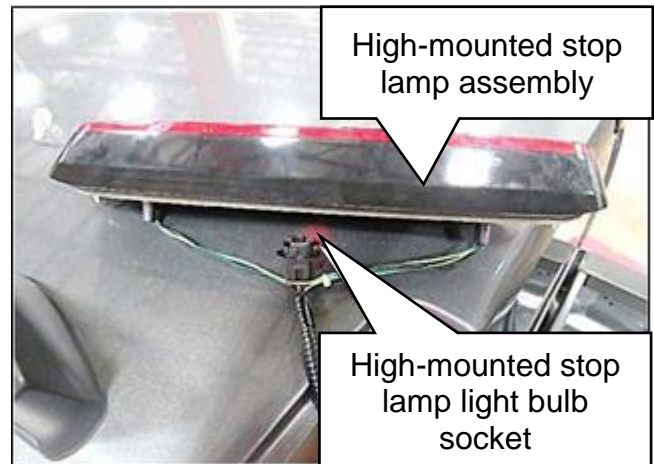

Figure 37



32. To validate the correct yellow wire has been identified in step 29:

- a. Have a helper depress the brake pedal.
- b. The ammeter should now have a reading of zero or near zero amps with the brake pedal depressed and the high-mounted stop lamp assembly light bulb removed.

**NOTE:** If there is not a reading of zero or near zero amps, try a different yellow wire from the wire harness until the correct wire is located.

- c. Using a suitable marker or tape, mark the wire.



Figure 38

33. Disconnect the negative battery terminal.

34. When the correct stop lamp switch yellow wire has been located (as validated in Steps 29 and 32) and the negative battery terminal disconnected, cut the yellow wire and remove 10 mm (**0.4 in.**) of insulation from the wire ends.

- Approximate location of yellow wire cut shown in Figure 39

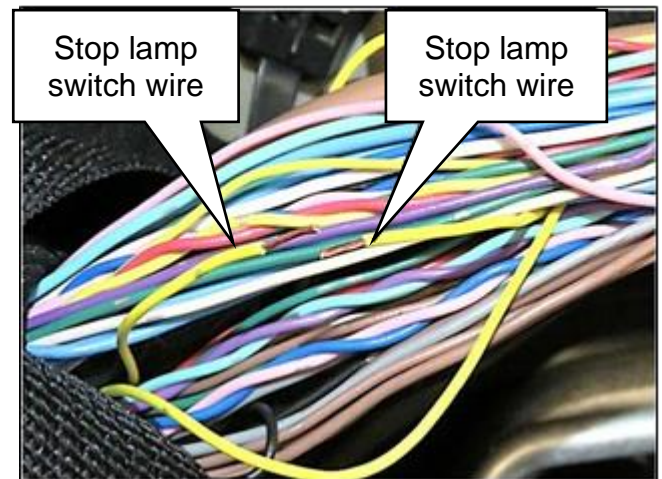

Figure 39

35. Remove 10 mm (**0.4 in.**) of insulation from the white and yellow wire ends from the CHMSL jumper harness.



Figure 40

36. Connect the CHMSL jumper harness' white wire to the driver (LH) side stop lamp switch yellow wire end using a solder sleeve connection.

- Heat the solder sleeve, using a flameless heat gun, special tool J-46538, until the solder has been fully melted into the wires, as shown in Figure 41
  - If needed, refer to **Quick Reference for Using Solder Sleeve Connectors, steps 52-57**

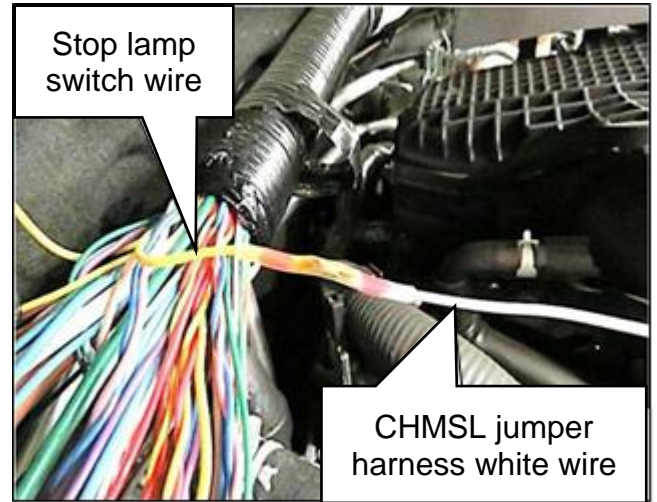

Figure 41

37. Connect the CHMSL jumper harness' yellow wire to the passenger (RH) side stop lamp switch yellow wire end using a solder sleeve connection.

- Heat the solder sleeve, using a flameless heat gun, special tool J-46538, until the solder has been fully melted into the wires, as shown in Figure 42
  - If needed, refer to **Quick Reference for Using Solder Sleeve Connectors, steps 52-57**

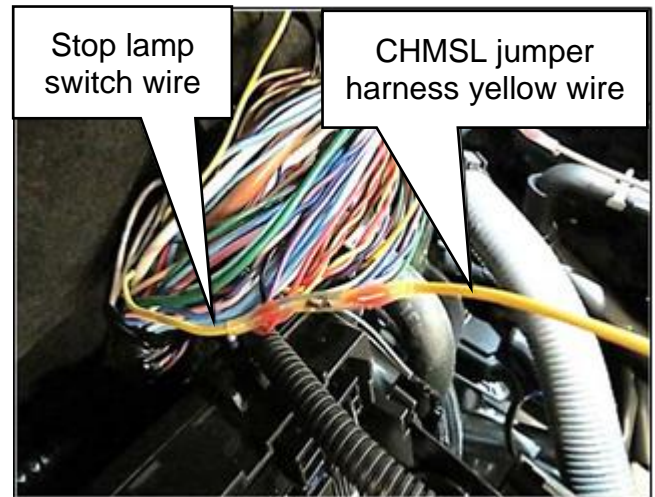

Figure 42

38. Insert the CHMSL relay from the **PARTS INFORMATION** table into the new CHMSL relay connector in the relay box.

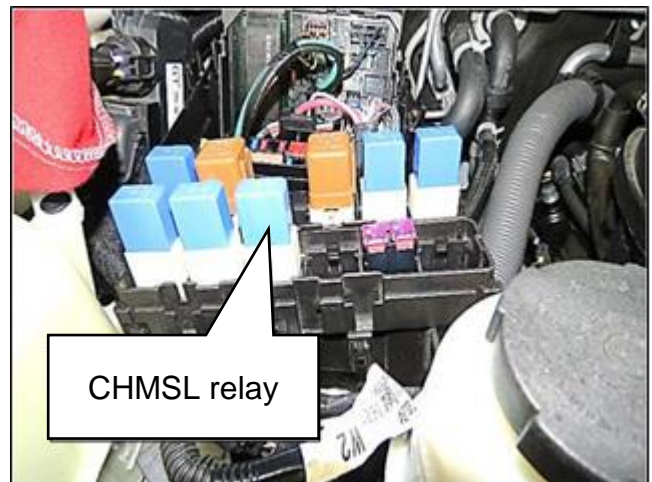

Figure 43

39. Connect the negative battery terminal

40. Install the high-mounted stop lamp assembly light bulb into the socket.

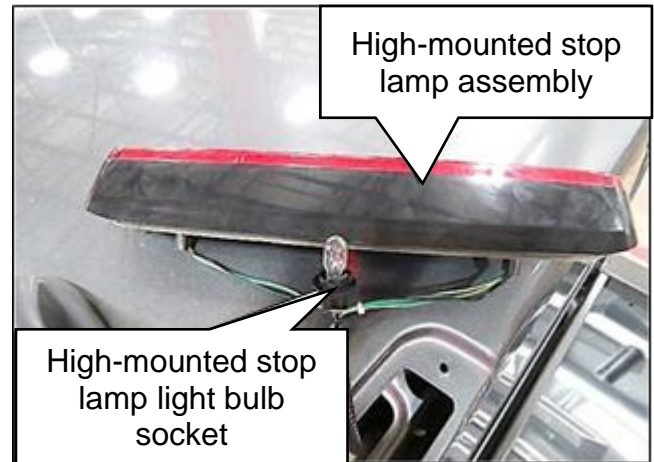

Figure 44

41. Install the high-mounted stop lamp assembly.

- Refer to the ESM: **DRIVER CONTROLS > EXTERIOR LIGHTING SYSTEM > REMOVAL AND INSTALLATION > HIGH-MOUNTED STOP LAMP > Removal and Installation**



42. Verify both tail lamps and the high mounted stop lamp assembly illuminate when the brakes are depressed.
- If all brake lights illuminate when the brake pedal is depressed, proceed to step 43.
  - If all the brake lights do not illuminate when the brake pedal is depressed, the incorrect yellow wire was cut.
    - a. Remove the CHMSL jumper harness solder sleeve connectors.
    - b. Reconnect the 2 yellow wire ends using a solder sleeve connector.
    - c. Perform steps 29 - 32, to determine the correct yellow wire to cut.



Figure 45

43. Wrap both solder sleeves connectors with electrical tape, as shown in Figure 46.

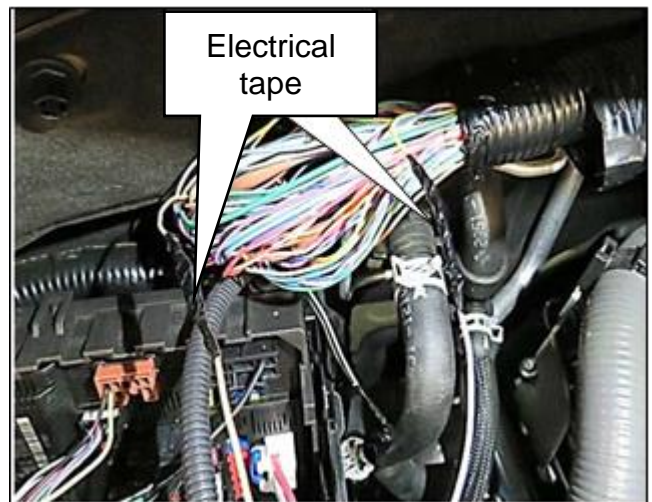

Figure 46



47. Reinstall the IPDM E/R and Relay Box covers.



Figure 50

48. Reinstall the power steering reservoir into the holding bracket.

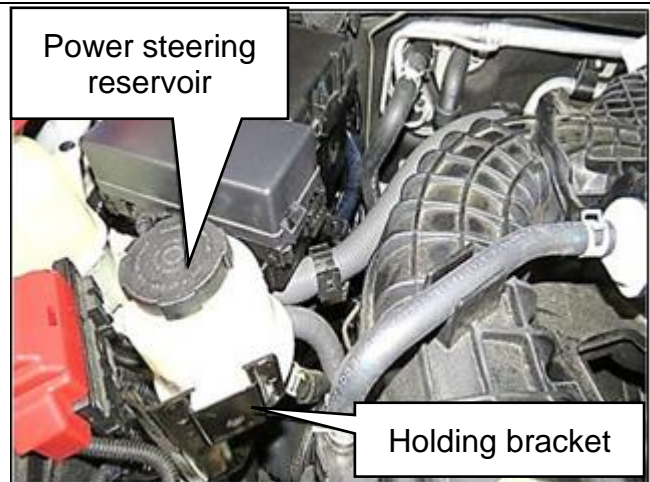

Figure 51

49. Remove the fender cover and close the hood.

50. Reset the clock and radio settings.

51. Perform **ADDITIONAL SERVICE WHEN REMOVING BATTERY NEGATIVE TERMINAL.**

- Refer to the ESM: **ELECTRICAL & POWER CONTROL > POWER SUPPLY, GROUND & CIRCUIT ELEMENTS > BASIC INSPECTION > INSPECTION AND ADJUSTMENT > ADDITIONAL SERVICE WHEN REMOVING BATTERY NEGATIVE TERMINAL**



## QUICK REFERENCE FOR USING SOLDER SLEEVE CONNECTORS

52. Check the gauge of the wire that is to be spliced, to determine the correct solder sleeve size.

CABLE SIZE (GAUGE AWG)	SOLDER SLEEVE COLOR	SOLDER SLEEVE IMAGE
26-30	White	
18-24	Red	
16-12	Blue	

Figure 52

53. Strip about 10 mm (**0.4 in.**) of insulation from the ends of the wires.

**NOTE:**

- Use the correct size opening in the wire crimper tool so you won't cut off any strands of wire.
- Less strands reduce the ability of the wire to handle the expected electrical load.

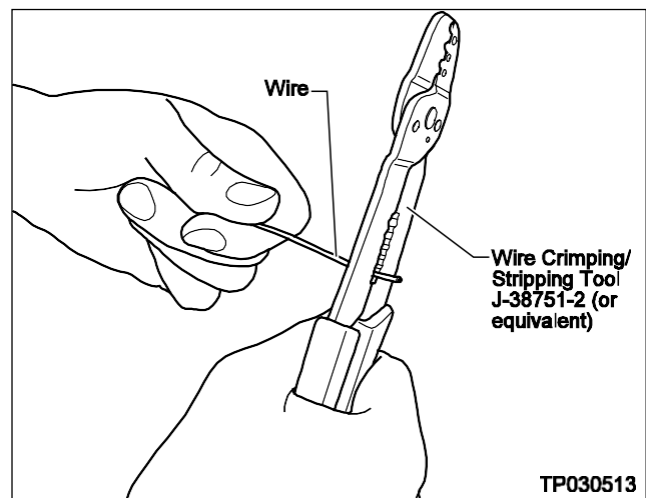

Figure 53

54. Slide a solder sleeve connector over the wire.

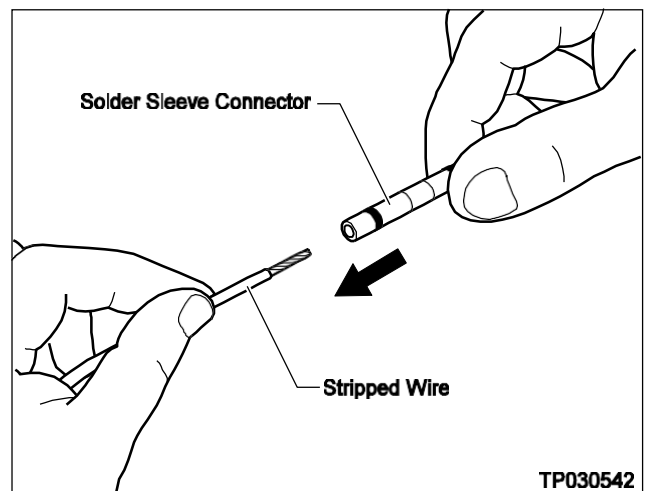

Figure 54

55. Make sure the wires are securely twisted together.

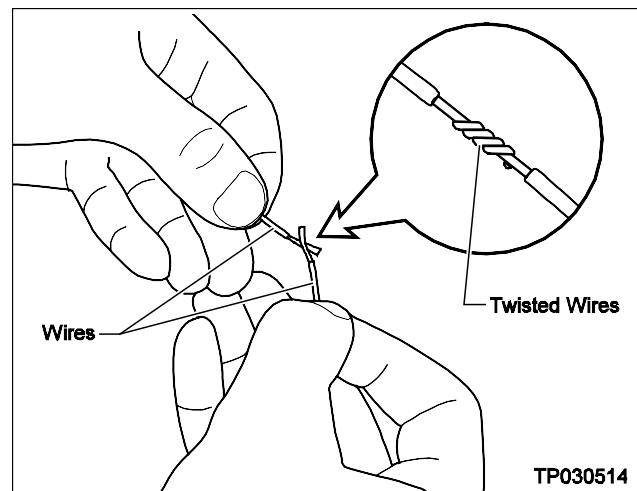

Figure 55

56. Position the solder sleeve connector so that the solder ring (in the connector) is centered around the exposed twisted wire area (Figure 56).

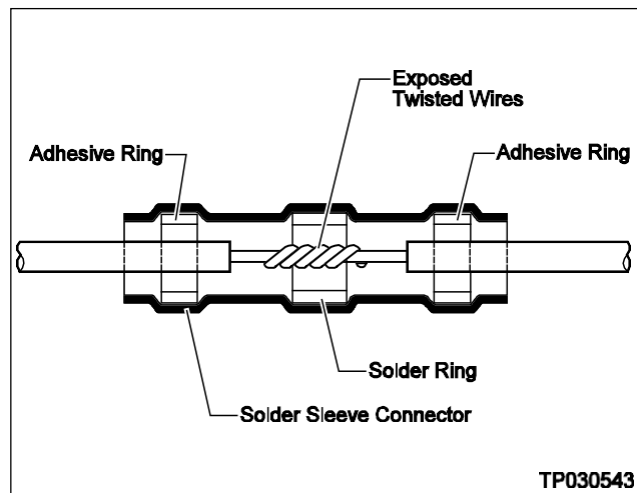

Figure 56

**CAUTION**

To avoid the risk of minor personal injury or property damage:

- The flameless heat gun and the solder sleeve connectors become HOT during the soldering process. Allow the gun and connectors to cool down before handling them.
- Be careful not to damage the solder sleeve connector or wires with the heat gun.
- Do NOT apply heat for more than 40 seconds.
- Do NOT overheat the connector or wires (i.e., severe darkening of connector sleeve or wire insulation).

57. Use the special tool Flameless Heat Gun J-46538 to heat the solder sleeve connector.

This operation will:

- Melt the solder (silver ring inside the solder sleeve connector) into the exposed twisted wire area.
- Melt the sealant (red rings inside solder connector) onto the wires.
- Shrink the plastic sleeve onto the wires.

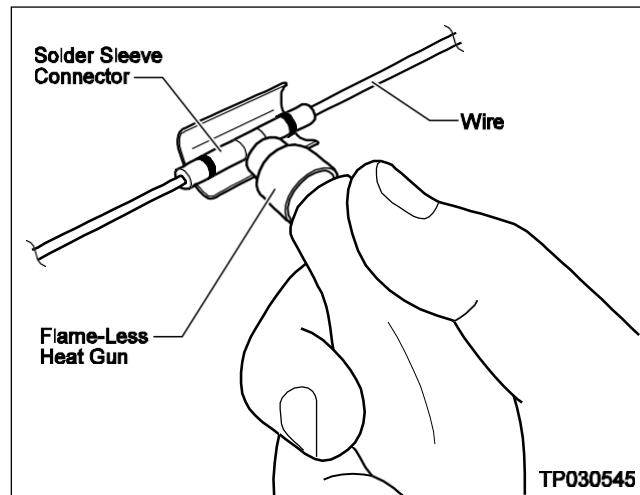

Figure 57

#### Important Soldering Tips:

- Position the solder sleeve connector in the middle of the heat gun's heat shield.
- Start heating the connector from the center and move back and forth (side to side) and around to allow even distribution of the heat to the entire connector.
- Make sure the solder completely flows into the exposed twisted wires and the adhesive properly seals the wire insulation to the connector sleeve. Stop applying the heat immediately after this happens.

### CONFIRM THE CURRENT ABS CONTROL MODULE PART NUMBER

**IMPORTANT:** Before starting, make sure:

- ASIST on the C-III plus has been synchronized (updated) to the current date.
- All C-III plus software updates (if any) have been installed.

#### **⚠ WARNING**

- Connect a battery maintainer or smart charger set to reflash mode or a similar setting. If the vehicle battery voltage drops below 12.0V or rises above 15.5V during reprogramming, the ABS Control Unit may be damaged.
- Be sure to turn off all vehicle electrical loads. If a vehicle electrical load remains on, the ABS Control Unit may be damaged.
- Be sure to connect the AC Adapter. If the C-III plus battery voltage drops during reprogramming, the process will be interrupted and the ABS Control Unit may be damaged.
- Turn off all external Bluetooth® devices (e.g., cell phones, printers, etc.) within range of the C-III plus and the VI. If Bluetooth® signal waves are within range of the C-III plus or VI during reprogramming, reprogramming may be interrupted and the ABS Control Unit may be damaged.



58. Connect a battery maintainer/smart charger to the vehicle.
59. Turn the ignition ON, engine OFF.
60. Connect the VI to the vehicle.
61. Start CONSULT-III plus (C-III plus) on the CONSULT PC.
  - a. The serial number will display when the VI is recognized (Figure 59 on page 24).
62. Select **Re/programming, Configuration**.

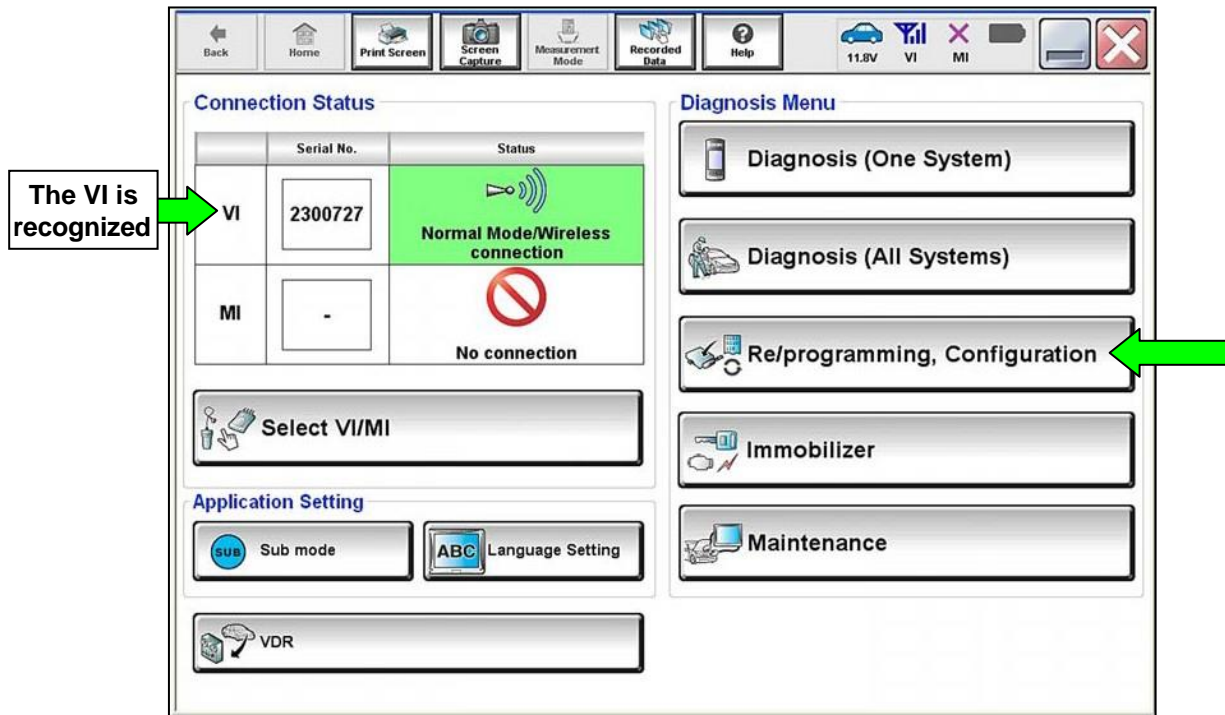

Figure 59

63. Check the box to confirm the precaution instructions have been read, and then select **Next**.

**NOTE:** Use the arrows (if needed) to view and read all the precautions.

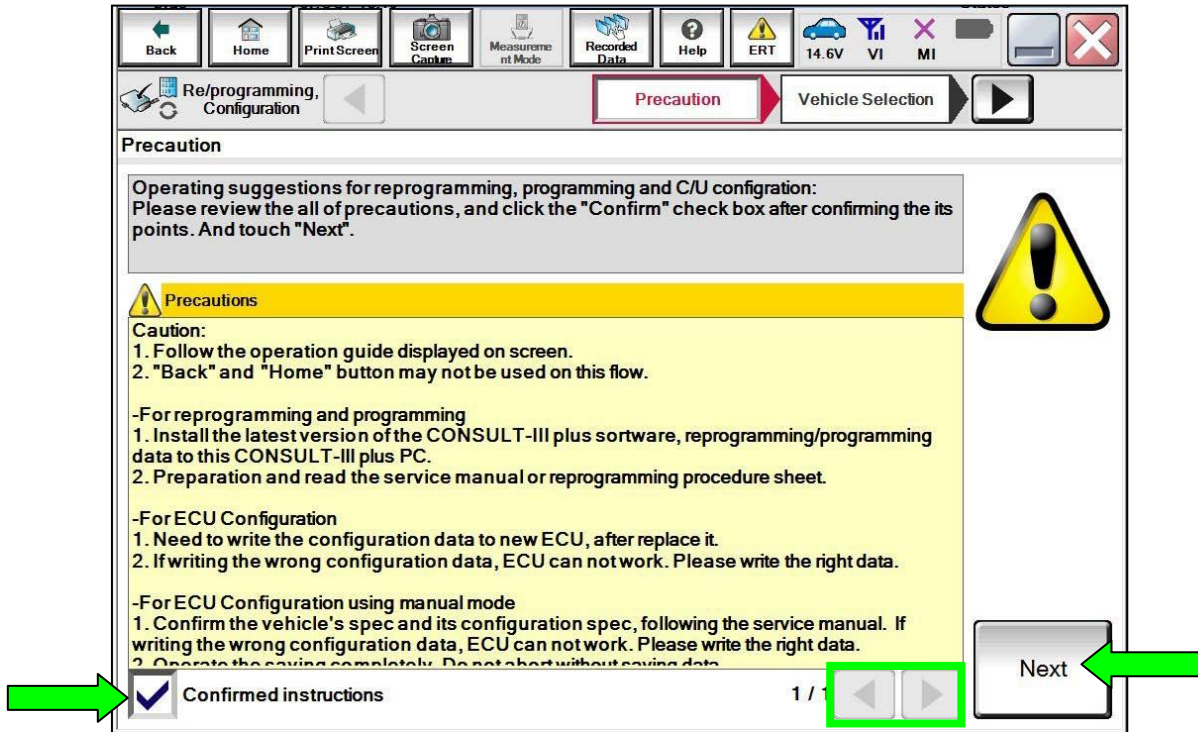

Figure 60

64. Select **Automatic Selection(VIN)**.

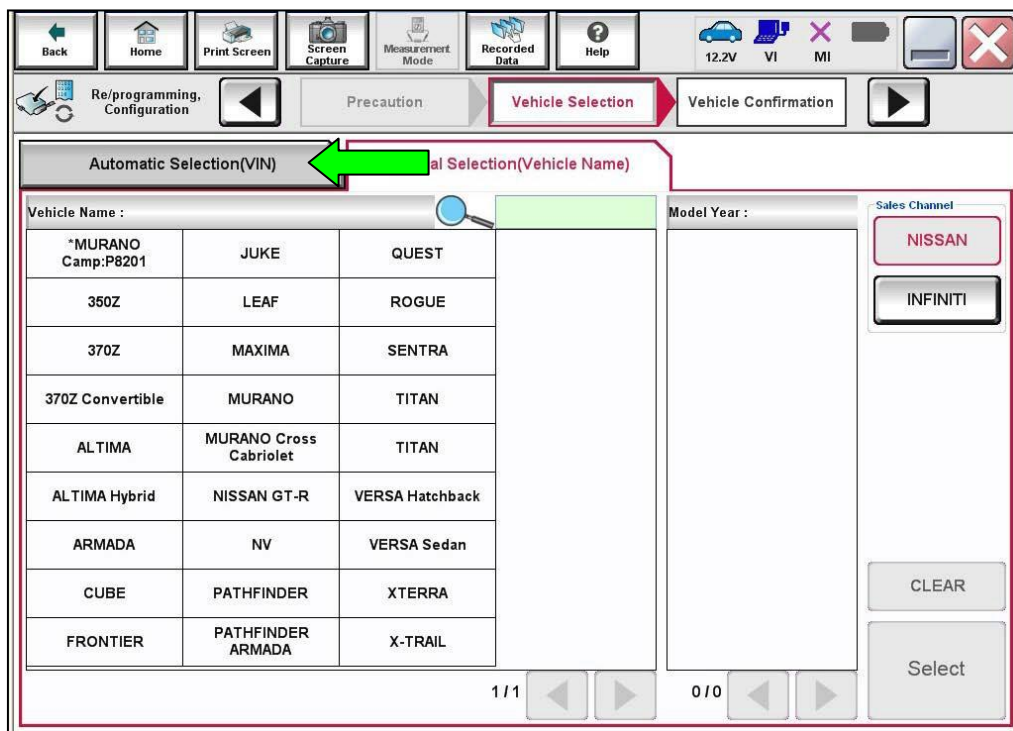

Figure 61

65. Confirm the **VIN or Chassis #** is correct, and then select **Confirm**.

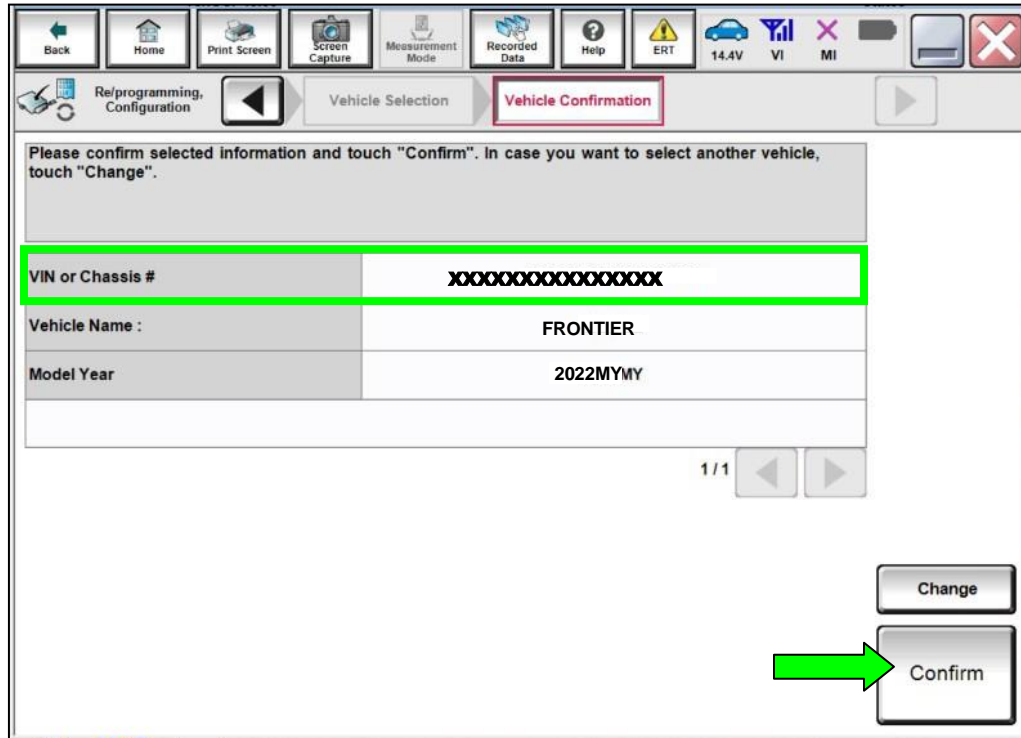

Figure 62

66. Confirm the VIN is correct for the vehicle, and then select **Confirm**.

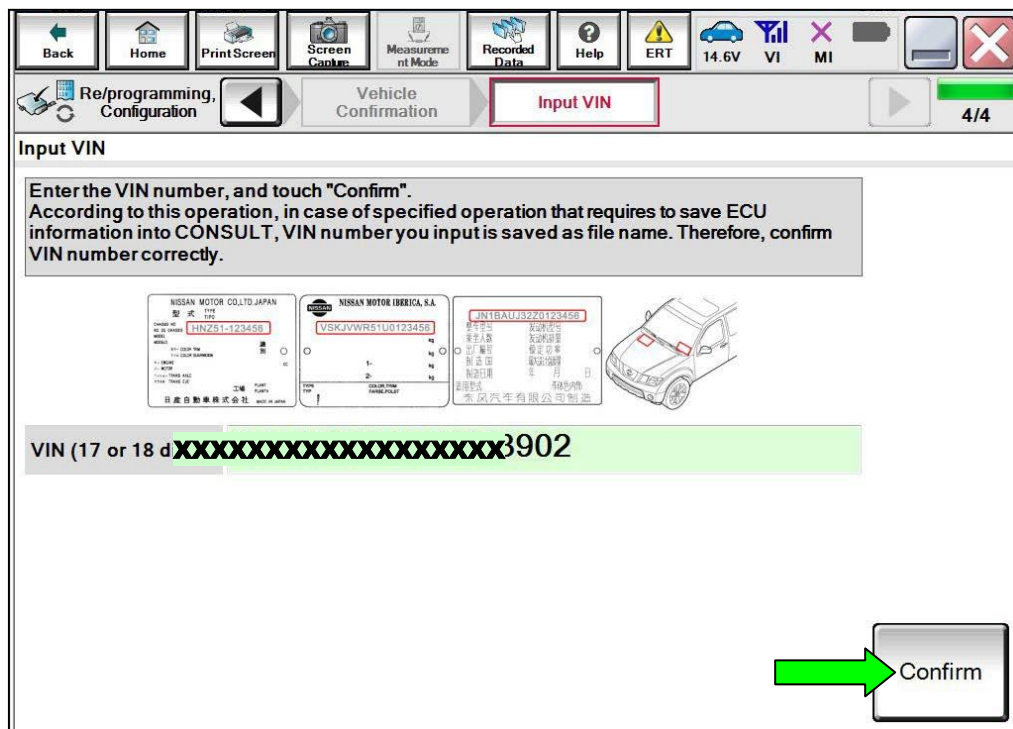

Figure 63



67. Select **ABS**.

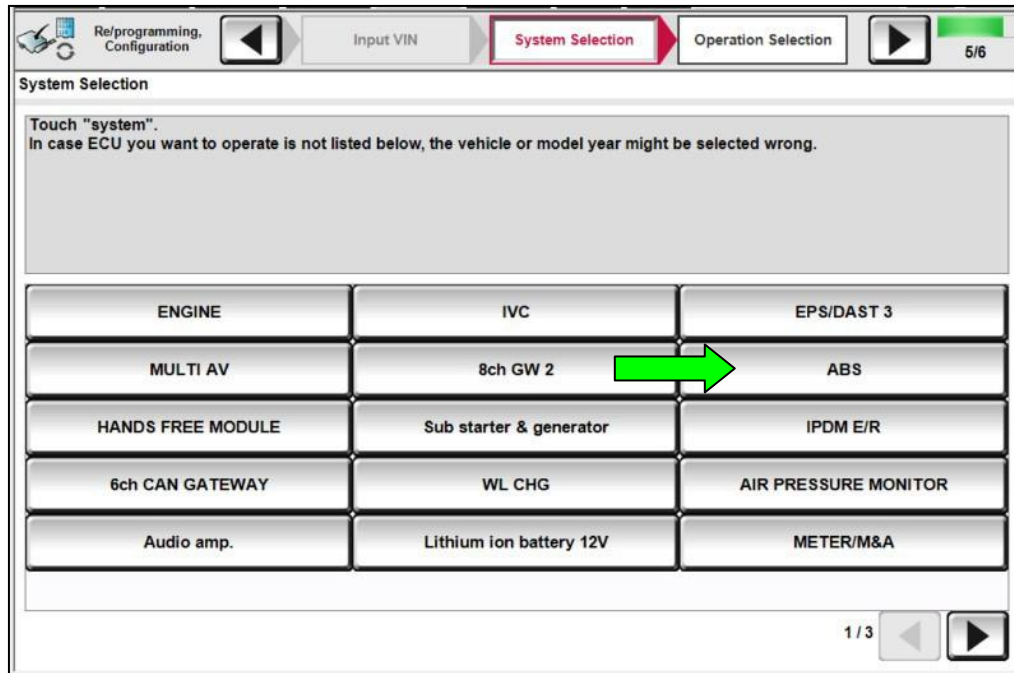

Figure 64

68. Select **Reprogramming**.

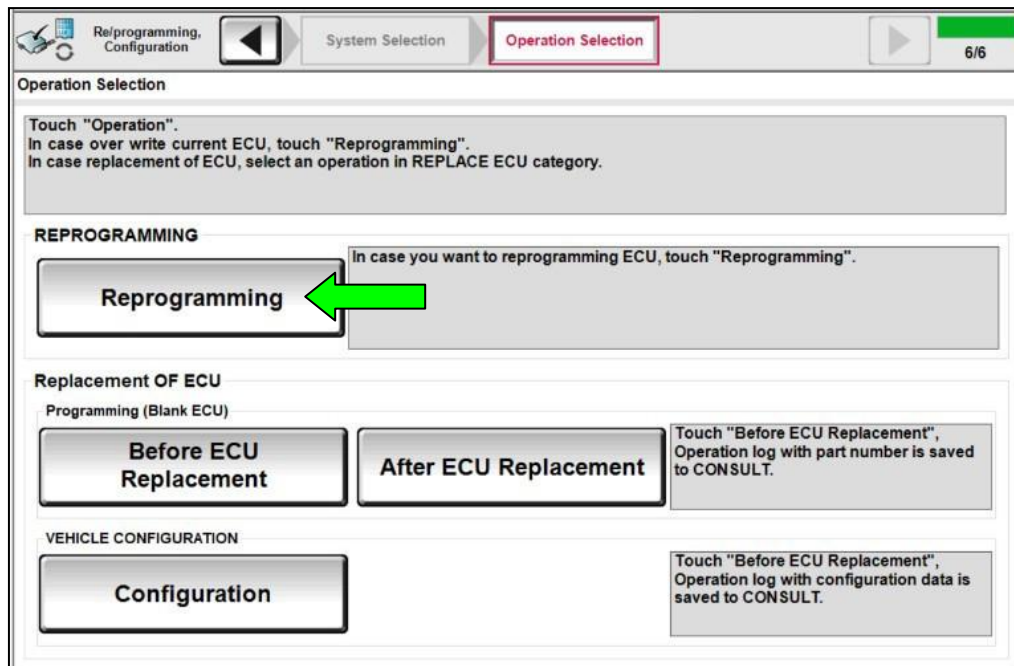

Figure 65

69. Find the ABS Control Module **Part Number** and write it on the repair order, and then select **Save**.

**NOTE:** This is the current Part Number (P/N).

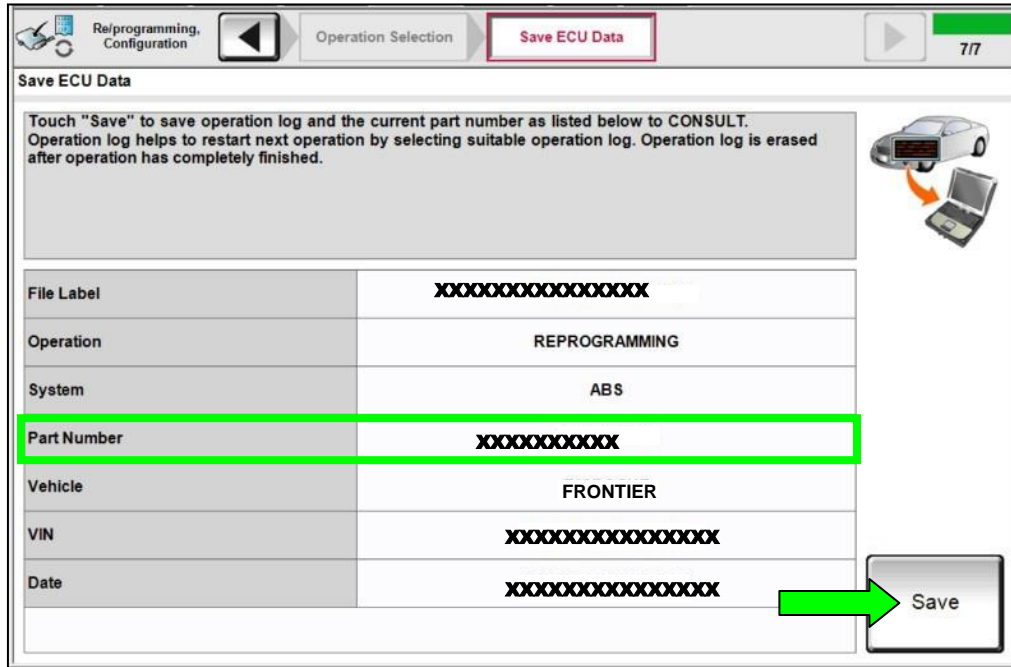

Figure 66

70. Compare the Part Number you wrote down in step 69 on page 26 to the numbers in **Table A** below.

- If there is a match, continue to step 71 to continue the reprogramming procedure
- If there is not a match, reprogramming is not needed, skip to step 81

**NOTE:** Check the ABS Control Module part number before reprogramming. Some vehicles may have the updated ABS control module part number.

**Table A**

MODEL	YEAR	CURRENT ABS CONTROL MODULE PART NUMBER BEFORE REPROGRAMMING: 46007-
Frontier	2022	9BU1C, 9BU2C, 9BU3C, 9BU4C 9BU1D, 9BU2D, 9BU3D, 9BU4D, 9BU6D

# REPROGRAM THE ABS CONTROL MODULE

71. Check the box to confirm the precaution instructions have been read, and then select **Next**.

**NOTE:** Use the arrows (if needed) to view and read all the precautions.

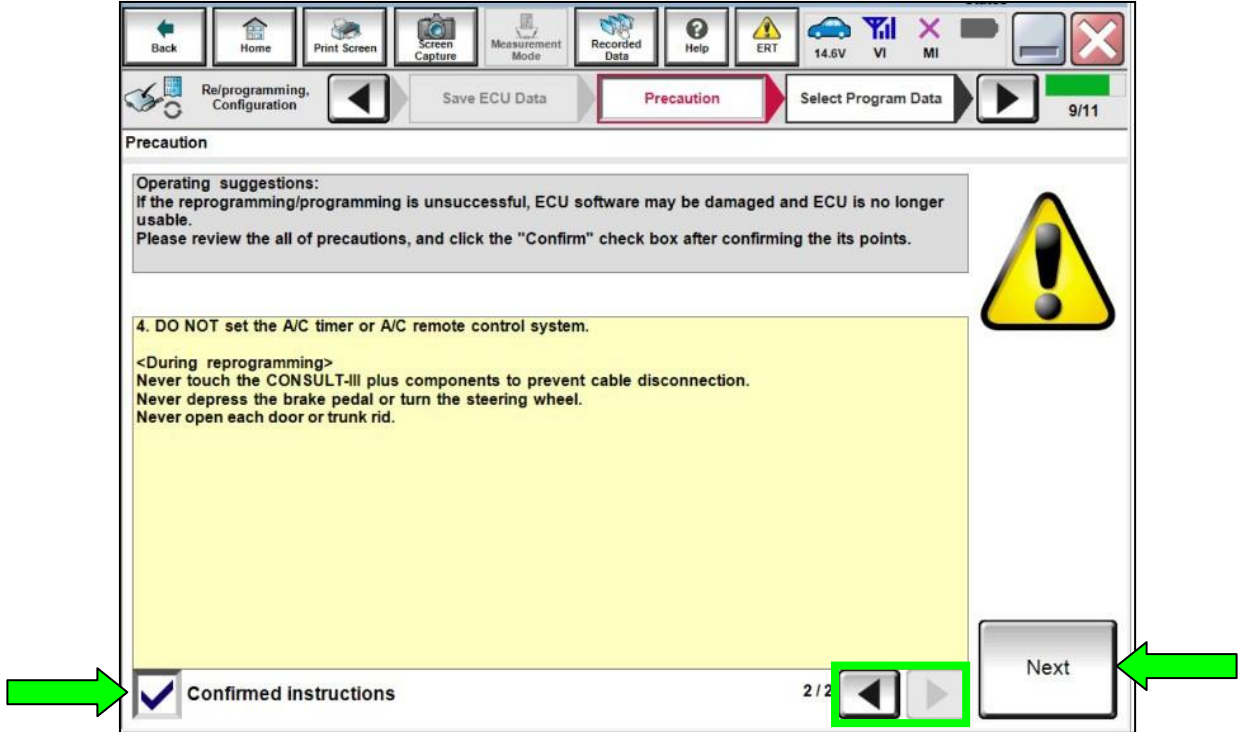

Figure 67

72. Confirm the battery charger is ON and the battery voltage is between 12V-15.5V, and then select **Next**.

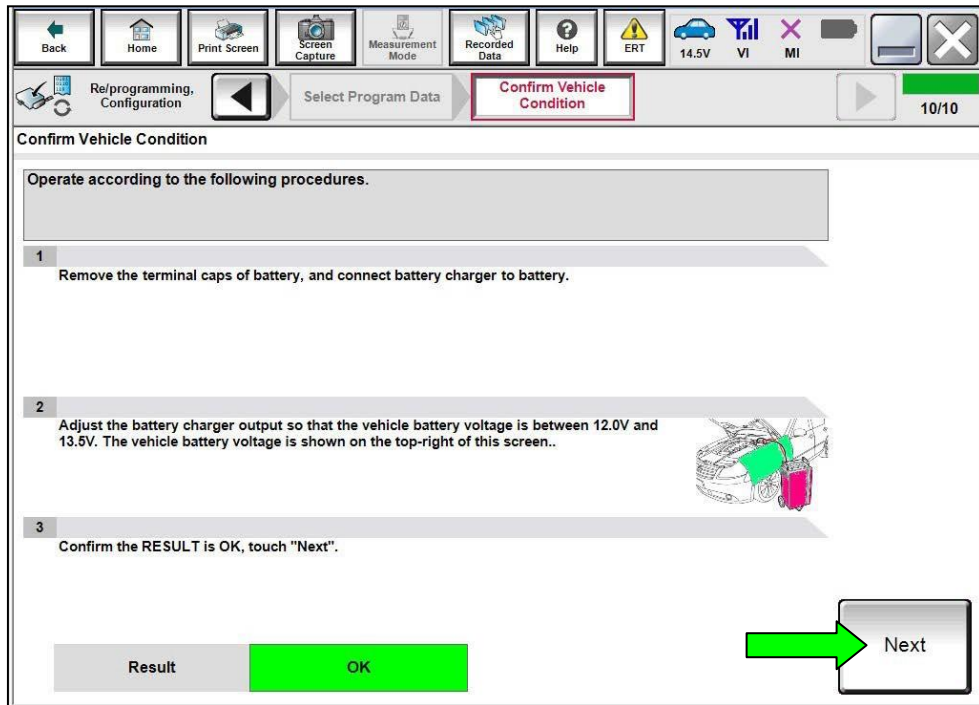

Figure 68



73. Confirm the **Judgment** for all the **Monitor Items** are “OK”, and then select **Start**.

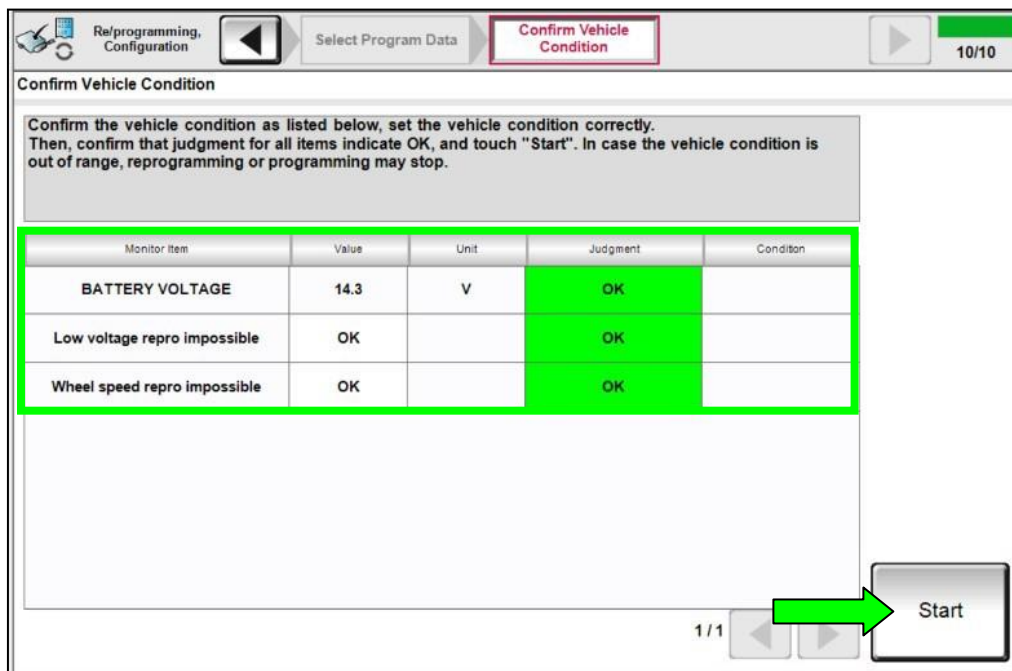

Figure 69

74. Select **USA/CANADA Dealers** from the drop down menu, and then select **OK**.

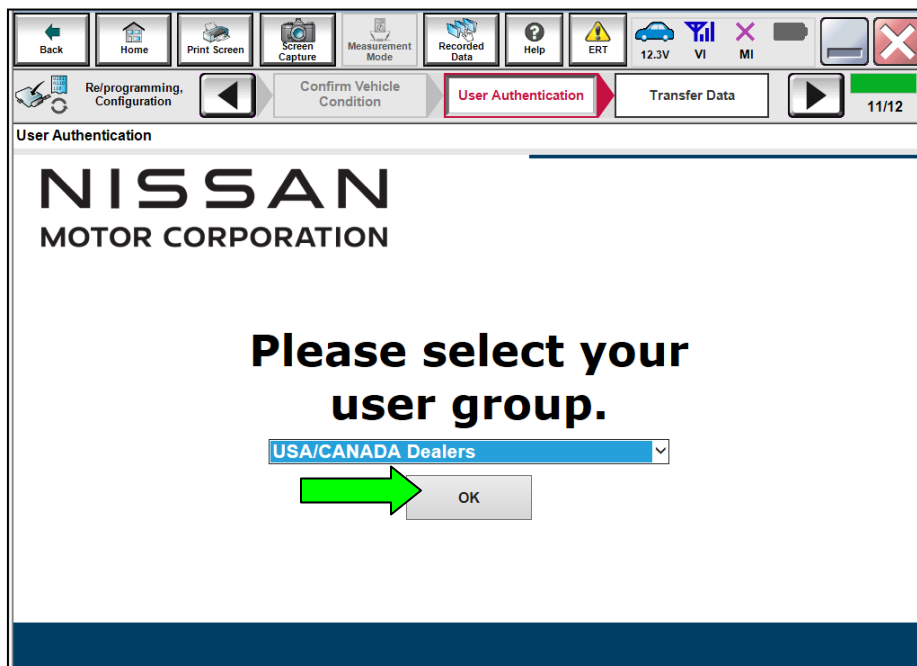

Figure 70

75. Login using your NNAAnet credentials and select **Submit**.

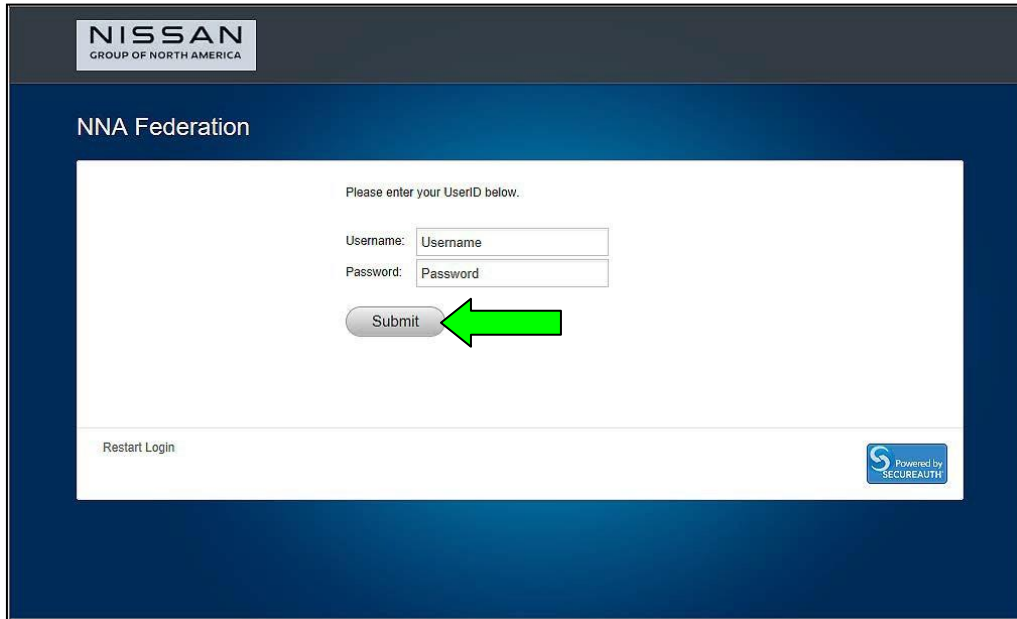

Figure 71

76. Allow **Transfer Data** to complete.

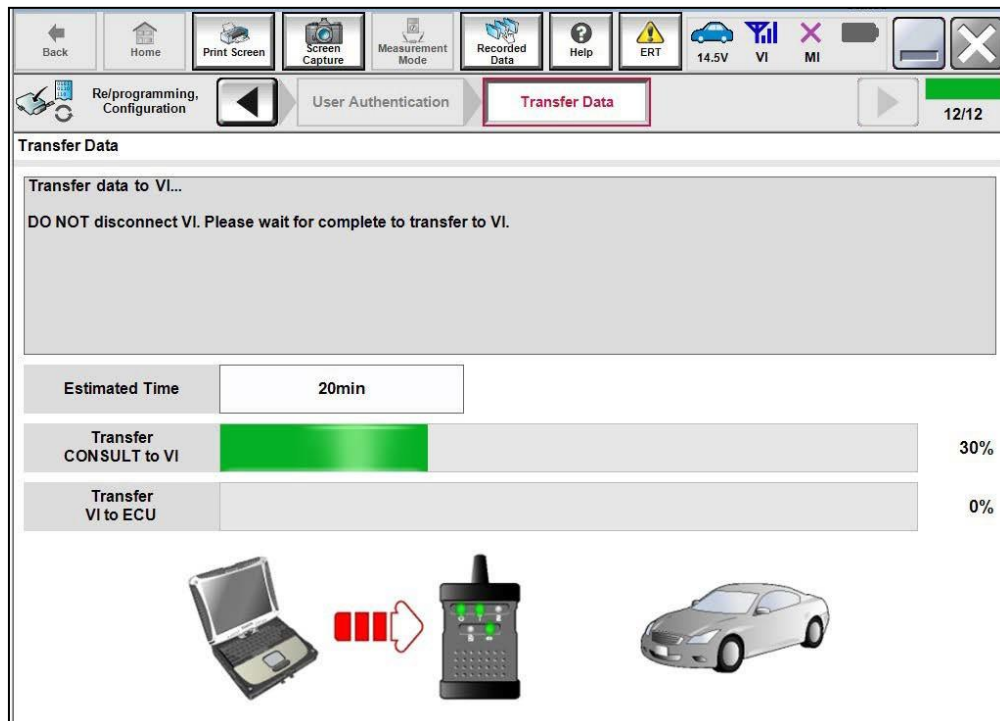

Figure 72

77. Once the reprogramming completes, select **Next**.

**NOTE:**

- If the screen in Figure 73 does not display (indicating that reprogramming did not complete), refer to the information on the next page.
- Additional steps/operations are required before CONSULT will provide the final reprogramming confirmation report. Continue with the reprogramming procedure (Step 78).

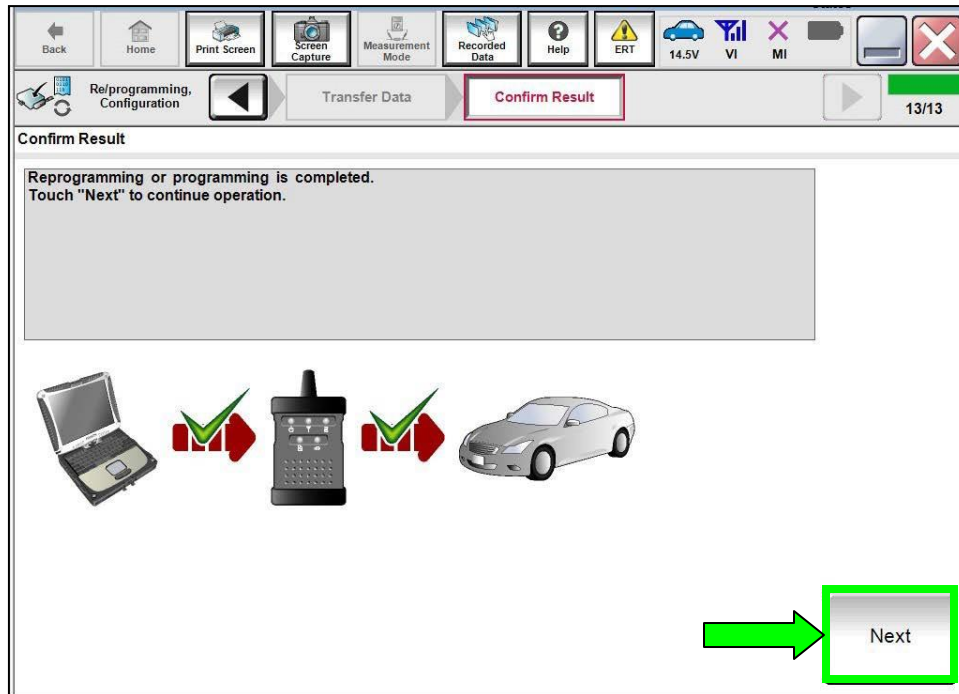

Figure 73

## ABS Control Module Recovery:

If reprogramming does not complete and the “!” symbol displays as shown in Figure 74:

- Check battery voltage (12.0 – 15.5V).
- Ignition is ON, Engine is OFF.
- External Bluetooth® devices are OFF.
- All electrical loads are OFF.
- Select **Retry** and follow the on screen instructions.

**NOTE:** **Retry** may not go through on first attempt and can be selected more than once.

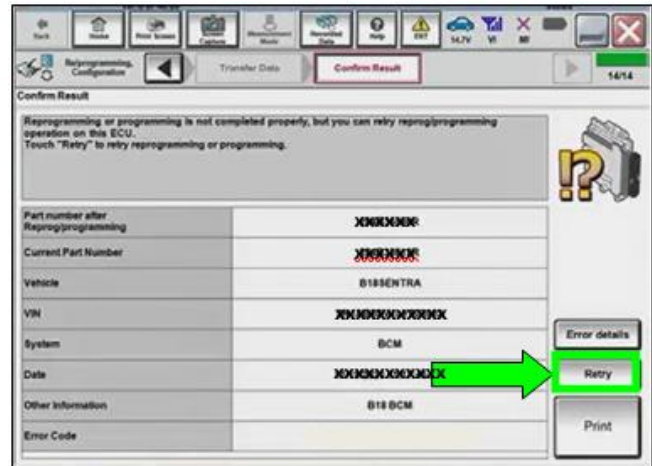

Figure 74

If reprogramming does not complete and the “X” symbol displays as shown in Figure 75:

- **Do not disconnect the VI or shut down C-III plus if reprogramming does not complete.**
- Check battery voltage (12.0 – 15.5V).
- CONSULT A/C adapter is plugged in.
- Ignition is ON, Engine is OFF.
- Transmission in Park.
- All C-III plus / VI cables are securely connected.
- All C-III plus updates are installed.
- Select **Home**, and then restart the reprogram procedure from the beginning.



Figure 75



78. Perform **Erase All DTCs**.

a. Follow the on-screen instructions as shown in Figure 76 and Figure 77.

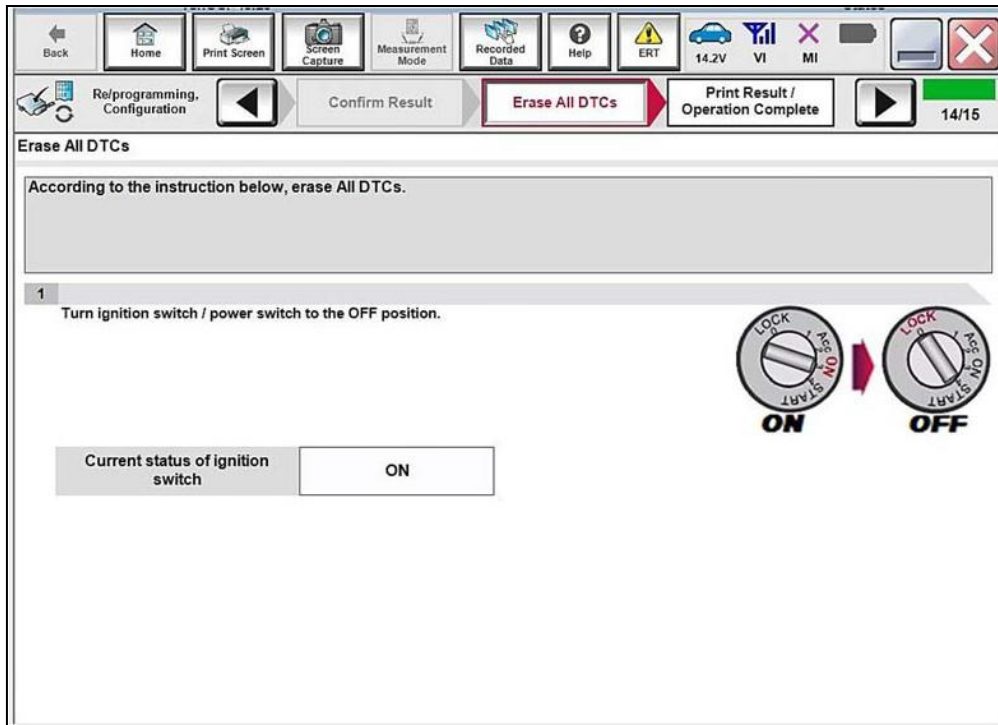

Figure 76

b. Select **Next**.

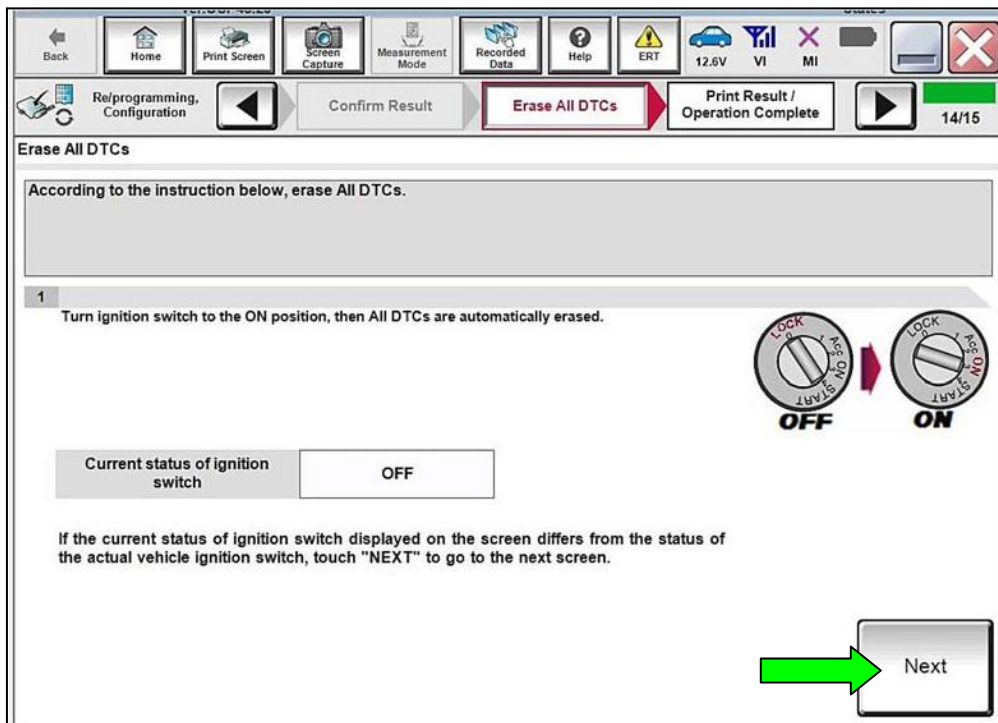

Figure 77

79. Select **Print** and attach the reprogramming results to the repair order, and then select **Confirm**.

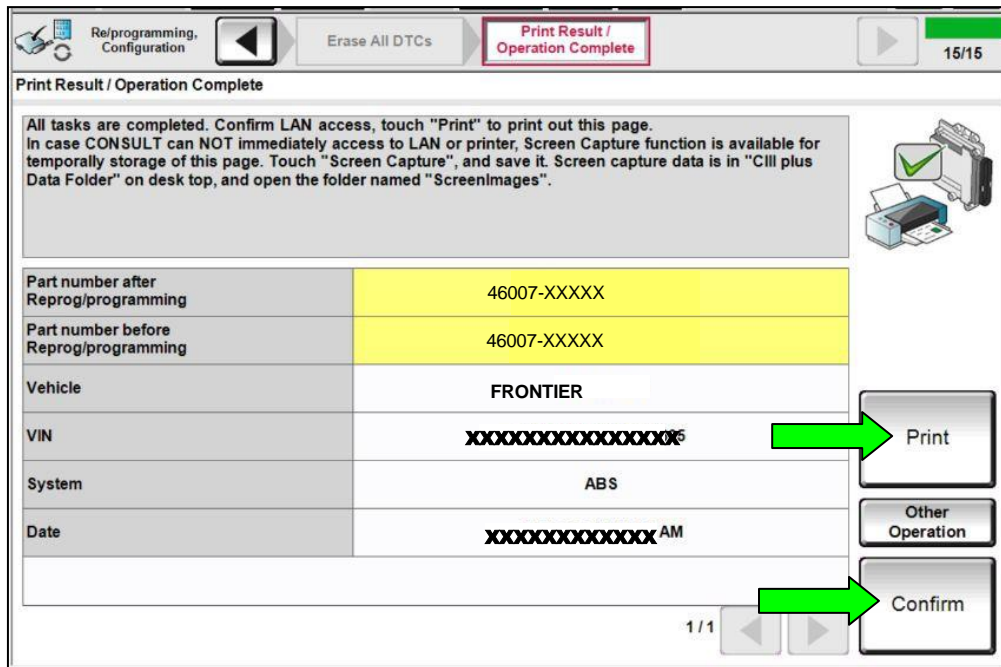

Figure 78

80. Select **Home**.

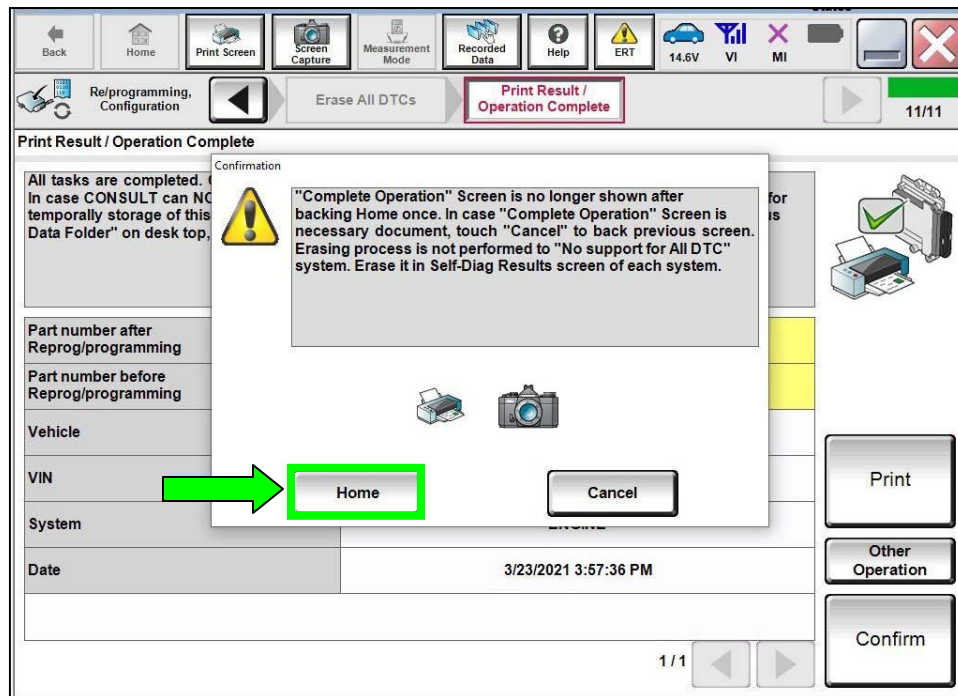

Figure 79

81. Remove the battery maintainer/smart charger.

82. Close the C-III plus application.

83. Disconnect the VI and remove it from the vehicle.

## **PARTS INFORMATION**

<b>Description</b>	<b>Part #</b>	<b>Quantity</b>
CHMSL JUMPER HARNESS	24009-9BU0A	1
IPDM BOX STICKER	24313-9BU9E	1
CHMSL RELAY	25230-79917	1
CLIP	25320-3KA0A	1
TERMINAL – JOINT (Red Solder Sleeve)	24361-7990A	4

## **CLAIMS INFORMATION**

**Submit a “CM” line claim using the following claims coding:**

<b>Campaign (“CM”) ID</b>	<b>Description:</b>	<b>Op Code</b>	<b>FRT</b>
<b>PC929</b>	Install Jumper Harness, CHMSL Relay, IPDM Sticker & Reprogram ABS Module	PC9290	1.7 Hr

