

**SIB 64 09 21**

2022-09-14

AC TEMPERATURE FLUCTUATION OR LOSS OF COOLING PHEV

This Service Information Bulletin (Revision 4) replaces SI B64 09 21 **dated June 2022**.

What's New (Specific text highlighted):

- Procedure, Parts sections: For the **G05** PHEV there is a repair kit available that includes the EKK, Air conditioning condenser with dryer flask, Compressor to condenser pressure line, expansion valve shutoff valve and an electrical expansion valve.

MODEL

E-Series	Model Description	Production Date	Engine
G05	X5 xDrive45e PHEV Sports Activity Vehicle	From Start of Production (SOP) to October 1, 2021	With XB1 engine
G20	3 Series 330e PHEV Sedan	From SOP to January 31, 2022	With XB1G engine

SITUATION

Please refer to the attached pdf (B64 09 21)

Supporting Materials

[picture_as_pdf B64 09 21_REV04.pdf](#)

AC TEMPERATURE FLUCTUATION OR LOSS OF COOLING PHEV

This Service Information Bulletin (Revision 4) replaces SI B64 09 21 **dated June 2022**.

What's New (Specific text highlighted):

- Procedure, Parts sections: For the **G05** PHEV there is a repair kit available that includes the EKK, Air conditioning condenser with dryer flask, Compressor to condenser pressure line, expansion valve shutoff valve and an electrical expansion valve.

MODEL

E-Series	Model Description	Production Date	Engine
G05	X5 xDrive45e PHEV Sports Activity Vehicle	From Start of Production (SOP) to October 1, 2021	With XB1 engine
G20	3 Series 330e PHEV Sedan	From SOP to January 31, 2022	With XB1G engine

SITUATION

On these Plug-in Hybrid Electric Vehicles (PHEV), the air conditioning cycles from cold to warm air while driving or while at a standstill. The vent outlet temperatures vary by 25 degrees Fahrenheit or more (38 F to 60 F+; 3 to 15+ Celsius) without changing any climate control settings.

A difference may be felt in cooling power compared from left to right.

In some cases, the air conditioning may have stopped blowing cold air altogether. A rattling noise may also be heard coming from the electrical coolant condenser (EKMV).

CAUSE

Air conditioning system is not sufficiently filled with refrigerant and/or is leaking.

The electric air conditioning compressor (EKK) and/or the water-cooled condenser (WCC) is obstructed by debris (fine particles).

CORRECTION

Perform the following checks to identify one or more of the following root causes.

- Locate and repair leaks
- Recharge system
 - For information on R-1234yf refrigerant refer to [SI B64 03 16](#)
 - For information servicing vehicles with R-1234yf refrigerant refer to [SI B04 02 16](#).
- Replace electric air conditioning compressor (EKK)
- Flush/Rinse air conditioning system to clean out debris
 - Use 'Rinse' instead of 'Flush' when searching in ISTA
 - When blowing through lines to remove foreign particles, it is recommended to use refrigerant with the AC flushing system. If the AC flushing system is not available and there was visible debris in the system; then the refrigerant lines, shutoff valve (G05 only) and expansion valves must be replaced.

Important Warning for Working on the High-Voltage (HV) systems on BMW Group vehicles:

Only properly trained personnel, who passed all applicable HV Technical Training Courses, should perform repairs which require disconnecting, or removal of High Voltage battery components on any

Hybrid or Electric Vehicle. Work performed on High Voltage systems by unqualified persons may result in severe injury or damage to the vehicle. Additional safety information is found in Repair Instruction 61 00... "Observe safety instructions when handling electric vehicles".

Additional Information:

Scheduled Maintenance, or Quality Certification 1 (Pre-Delivery Inspection) on Electric or Hybrid vehicles does not require HV technical training.

Prior to disconnecting, or the removal of any HV component, the HV system needs to be disabled and secured (by means of the HV Disconnect Switch) by a properly trained technician, who has a minimum HV Qualification level after completing the Technical Training Course ST1824 (Alternative Drive Part 1). Once the vehicle's HV system is disabled (the "Blitz" - lightning bolt icon displayed in instrument cluster, see below), a technician without HV Certification may remove a HV component (e.g., EH Heater, EKK Compressor, EME Control Unit, et.), except for the High Voltage Battery.



High Voltage Battery removal and rework can be performed ONLY by a HV Specialist Technician (certified by the Technical Training Course ST1825 – Alternative Drive Part 2), AND with a HV Battery Certification level corresponding to a specific Electric or Hybrid vehicle (e.g., to repair GEN4 battery of G05 PHEV, certification from Technical Training Course "ST2006 – SP44 HV Battery" is required).

PROCEDURE

This bulletin highlights some of the details of flushing the AC system. Always follow the ISTA Repair instructions for the step-by-step procedure.



Caution: High-voltage system.

Refer to the full warning statement above.

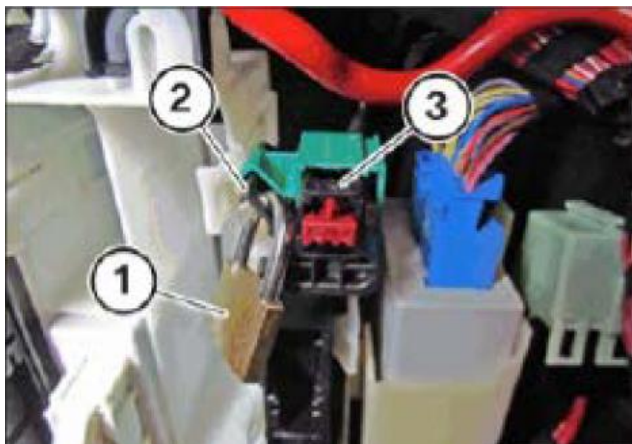

Caution: High-voltage system.

When working near high-voltage components (labelled accordingly by signs and/or orange coating), disconnect the high-voltage system and protect it from damage.

Use a padlock on the high voltage safety connector / interlock loop disconnect to prevent the high voltage system from being turned on during repairs.



Ensure that the check control message “High voltage system deactivated” appears in the instrument cluster (vehicle ignition in PAD mode) before you start work.

If the instrument cluster does not clearly show that the electrical system has been deactivated, do not start any work. Danger of death.

Perform the following checks to identify the root cause:

1. Reproduce the situation described above.
For maximum AC operation with minimal outside humidity influence, test system with the following settings:
 - Windows and sunroof closed
 - Fresh air on Recirc (recirculation) mode
 - Stratified air set between middle and maximum cold (blue)
 - Climate set to AUTO
 - MAX AC

2. Read out the temperature value of the evaporator temperature sensor via ISTA.
The path in ISTA is as follows:

Service functions -> Heating and air conditioning functions -> Temperature sensors -> Test module for heating and air conditioning functions: Run temperature sensors.

The target temperature is less than 8 degrees Celsius (approx. 46 F).

- **If the temperature value is plausible:** the air conditioning compressor is not faulty- Continue diagnosis.
- **If temperature value is implausible** (Never gets cold or goes below freezing)- go to step 3

Check temperature differential at the ventilation vents.

The difference between left and right should not be greater than 5 degrees Celsius (approx. 41 F).

Monitor the pressures at the connected air conditioning service device.

A low side pressure of 3-4 bar and a high side pressure of 8-15 bar is OK.

3. If one of the above checks deviates from the desired state, proceed as follows:

Check if there is sufficient refrigerant in the AC system.

If system is not sufficiently filled => Carry out leak detection, locate and repair leak.

A detailed pressure test (recommendation: nitrogen test) must be carried out.

If the tests above are not passed and there is a leak, then only the leaking components are to be replaced.

4. Check the high-pressure side hose between the AC compressor (EKMV) and the condenser (WCC) for damage or signs of leakage as seen in these pictures.

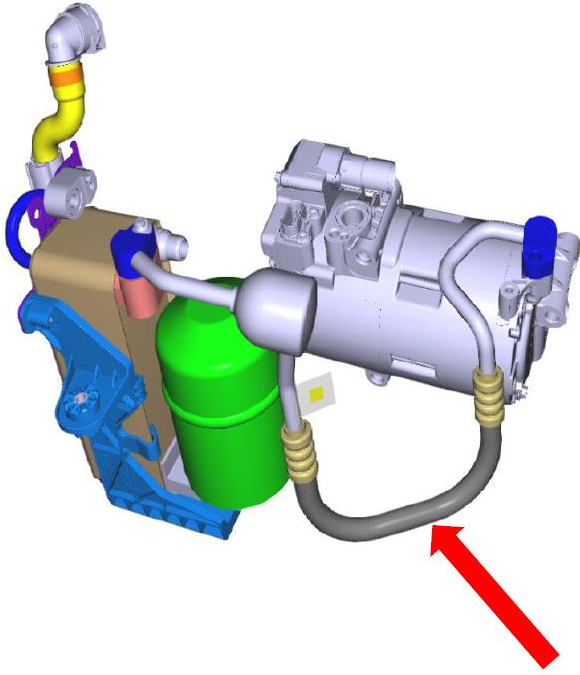

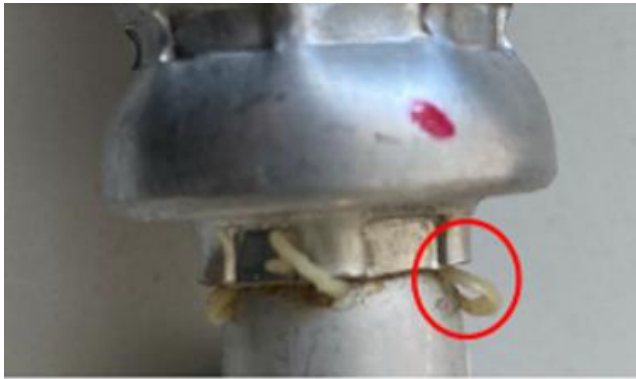

5. Important: If the leaking components include the eKMV and/or the pressure line between compressor and condenser the following components must be replaced together:
- EKK

- Condensator with desiccant
 - High Side Pressure line between the compressor and the condenser
6. If the tests under step 2 are not passed and there is no leakage, the following components are to be replaced together:
- EKK
 - Condensator with desiccant
 - High Side Pressure line between the compressor and the condenser
7. Proceed with
- step 8 **Procedure if flushing equipment is available for the refrigerant circuit**
- or
- step 30 **Procedure if NO flushing equipment is available for the refrigerant circuit**

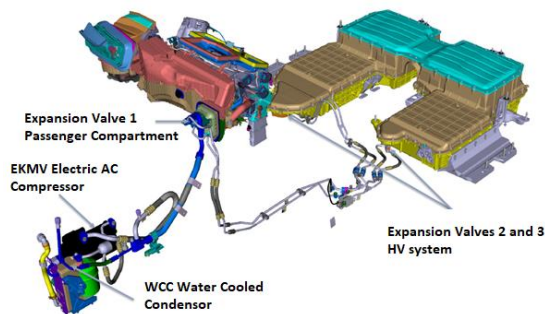

8. Procedure if flushing equipment is available for the refrigerant circuit

Observe **repair instructions**

- **64 50 770** "Flush refrigerant circuit PHEV"
- Evacuate refrigerant circuit (if not done already)



9. Remove and then bypass the air conditioning compressor with two flushing adapters.

- Mount the special tool **83 30 2 286 732** onto the high-pressure line (2) of the air conditioning compressor and secure with the M8 screw (1) that is on the vehicle
- Mount the special tool **83 30 2 286 730** onto the low-pressure line (4) of the air conditioning compressor and secure with the M8 screw (5) that is on the vehicle
- **M8 Bolts Torque 19 Nm.** Two persons, one holding the adapter and the other tightening to torque simplifies the process
- These adapters are connected via a jumper hose such as **83 30 2 285 575**

These two special tools are part of the BMW i basic adapter set **83 30 2 413 236**.

When servicing a **G05 hybrid vehicle a second special tool 83 30 2 286 732 is also required** so you will need two 83 30 2 413 236 kits. Refer to Repair Instructions

NOTE: These pictures are for example purposes. Some parts may differ in certain details depending on model.

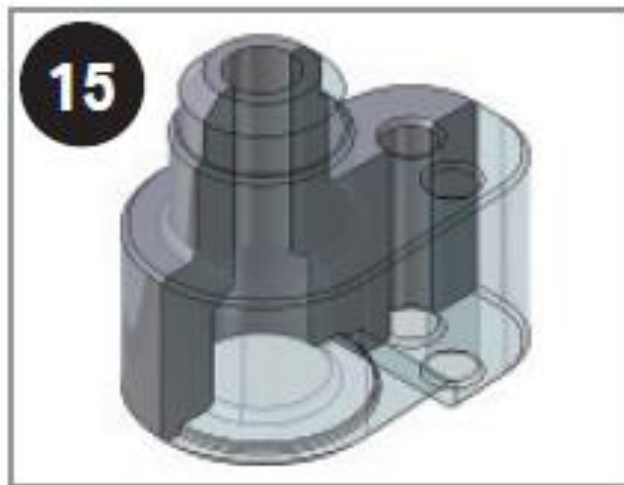
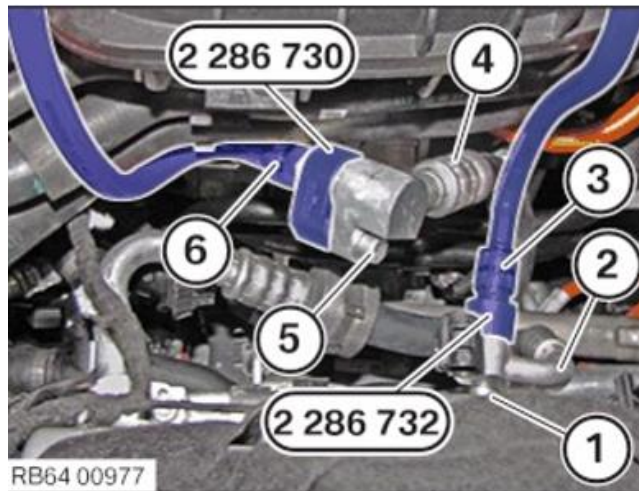

83 30 2 412 932



10. The condenser must be bypassed and replaced since it is a non-flushable component.

- Disconnect condenser hoses and bypass with flushing adapter **83 30 2 412 932** and **83 30 2 414 998**
- **M6 Bolts Torque 13 Nm.**
- Connect the two adapters with connecting hose **83 30 2 285 575**



11. Remove and then block off **EXPANSION VALVE #1** at the passenger compartment, with adapter **83 30 2 420 896**. This adapter is solid and blocks off flushing of the evaporator for the first flush cycle.

- Fasten with the M5 screws (1) of the expansion valve that has been previously removed
- **M5 Bolts Torque 5.5 Nm**

When mounting the refrigerant lines (3) onto the block off plate 1, secure them with the nut previously removed.



- **M6 nut Torque 13 Nm**

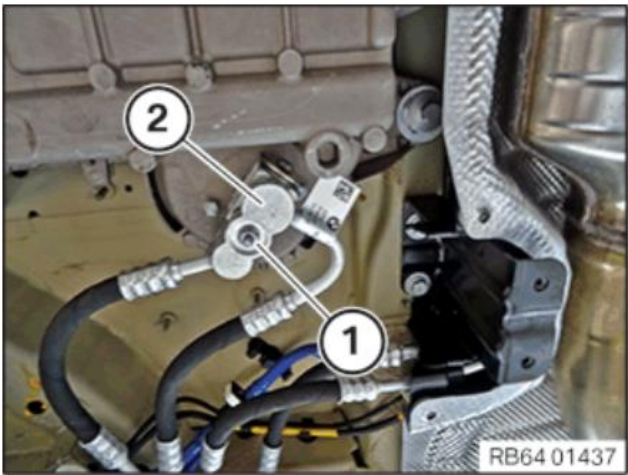
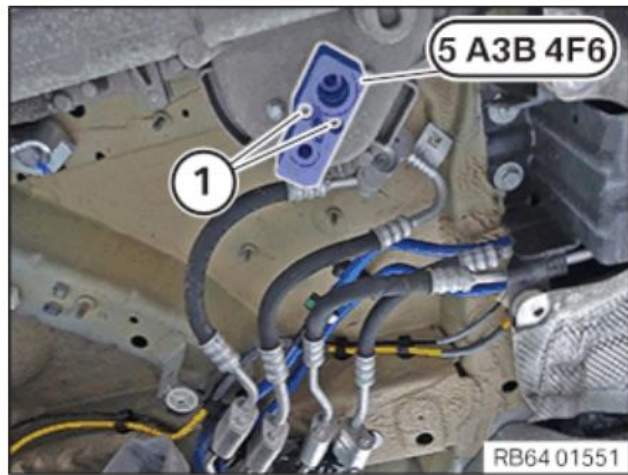
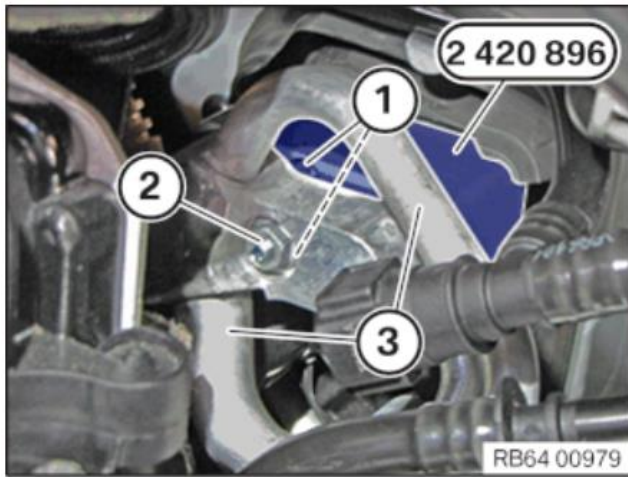

12. Remove and install flushing adapter **83 30 5 A3B 4F6** instead of **EXPANSION VALVE #2** at the high voltage battery.

- Fasten with the M5 screws (1) of the expansion valve that has been previously removed
- **M5 Bolts Torque 5.5 Nm**

When mounting the refrigerant lines (2) onto the adapter secure them with the nut previously removed.

- **M6 nut Torque 13 Nm**

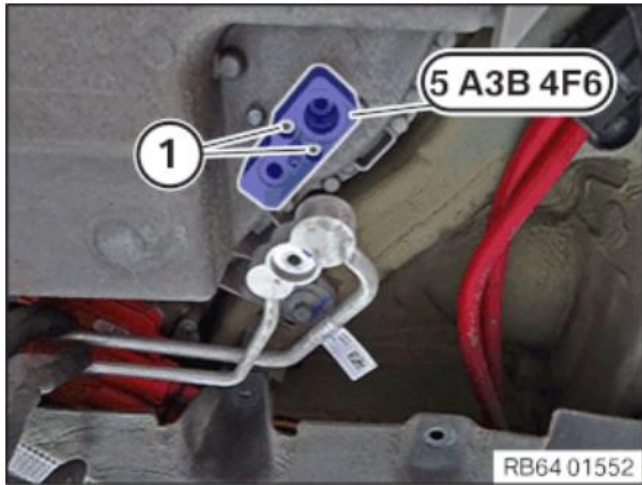

13. Remove and install flushing adapter **83 30 5 A3B 4F6** instead of **EXPANSION VALVE #3** at the high voltage battery.

- Fasten with the M5 screws (1) of the expansion valve that has been previously removed
- **M5 Bolts Torque 5.5 Nm**

When mounting the refrigerant lines (2) onto the adapter secure them with the nut previously removed.

- **M6 nut Torque 13 Nm**

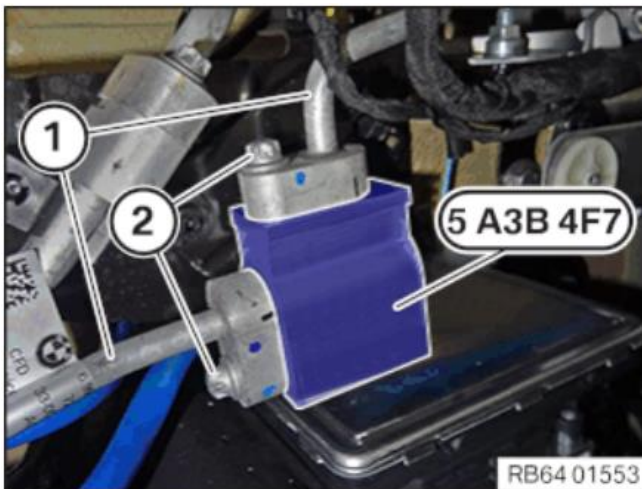
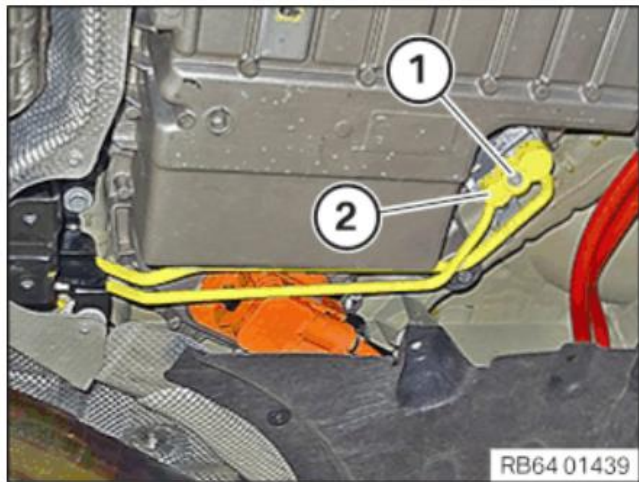

14. Remove and install special tool **83 30 5 A3B 4F7** instead of the **refrigerant shutoff valve**.

When mounting the refrigerant lines onto the special tool, secure them with the bolts previously removed.

- **M6 Bolts Torque 13 Nm**



15. The flush machine (Robinair or Mahle manufactured) will come with hoses, filter, and hardware. Pictures are of the Mahle flush kit as received.

The adapters to connect to the AC machine come with the flushing machine.

There are adapters for both R134a and Y1234a.



16. Only the R134a adapters fit the quick disconnects of the AC machine.

The **Y1234a** adapter fits the low side quick disconnect of the AC machine. However, **the high side must have the quick disconnect fitting removed (left) to install the brass adapter** for connection.

The O-ring seen in the picture, removed from the high side quick disconnect, must not be installed onto the brass adapter. This additional O-ring will not allow for full compression of the fittings when tightening resulting in a leak from the brass adapter.



17. High side brass swivel fitting adapter for Y1234a high side connection.



18. **Y1234a high side adapter installed** in place of the quick disconnect

AC Flush circuit yellow hose (top), brass swivel adapter, and AC Flush machine high side red hose (bottom).

Mahle



19. Connect the air conditioning service device (AC Recycling machine and flushing adapter) to the cable connections. Follow instructions from the flushing adapter instruction manual on proper hose connections to the vehicle.

It is best to leave the yellow hose loose at the flush machine, make your connection to the vehicle, then tighten the hose at the flush machine.

Robinair



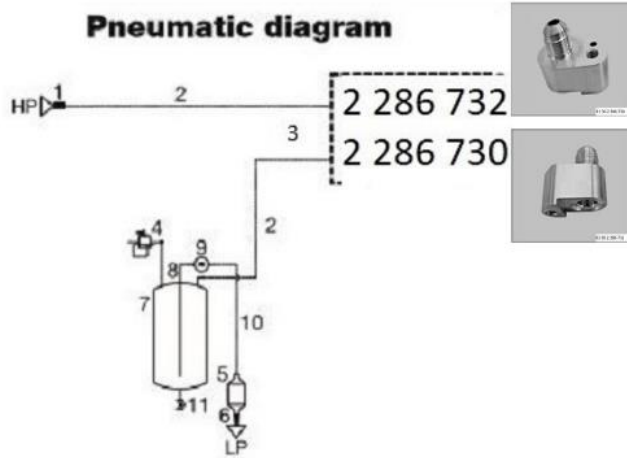

20. Once all hoses are connected, mark one, or both hoses, to ensure proper connection of the flushing equipment (i.e. Red high side, Blue low side).

You cannot flush the system backwards due to the orifice sizes on inlet/outlet of the expansion valve bypass.

1	HP outlet adapter fitting
2	High-flow connection hoses
3	Item to be flushed
4	Safety valve 18 bar / 261 psi
5	Filter 15 µm
6	LP fitting
7	6 liter fluid vessel
8	Connection hose between vessel and sight glass
9	Fluid indicator sight glass with cap
10	Connection hose between sight glass and filter
11	Auxiliary valve with cap

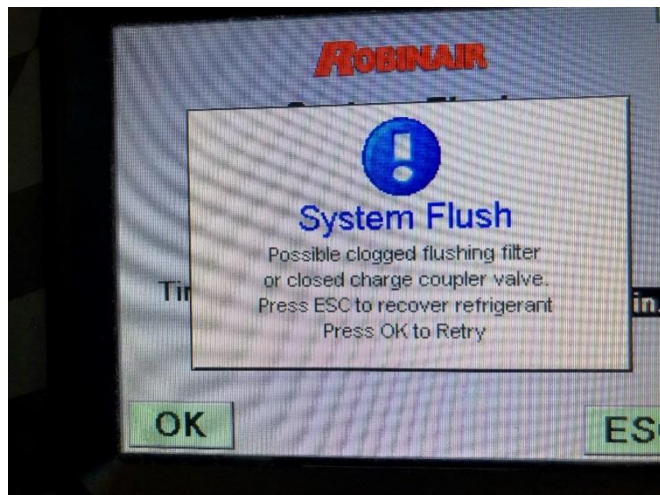

21. The filter on the flushing cannister must be replaced on a regular basis to ensure no contamination entering the AC machine.

- This filter should be replaced after flushing 5 vehicles maximum
- **TIP:** To track filter usage a permanent marker or a paint line can be placed on the filter every flush. After 5 lines it's time to replace.

If the filter is plugged, some AC machines (Robinair) will display an error message "System Flush not possible clogged flush filter".

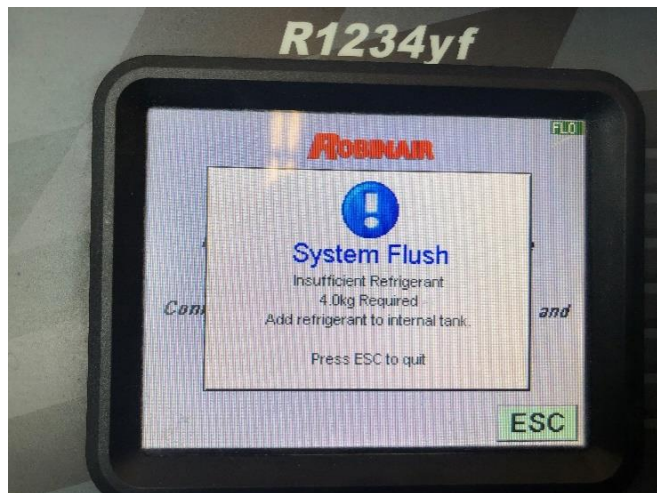

22. The flush procedure requires 4+ kg of refrigerant in the Internal Storage Vessel (ISV) tank within the AC flush machine.

If there is an insufficient amount of refrigerant in the ISV, the flush procedure will not start and will prompt an error message “Insufficient Refrigerant”. The amount of refrigerant allowed in the ISV when the AC flush machine transfers from the external tank is set in the machine’s “Settings” menu. You may have to go into the menu of the AC machine to set the ISV amount. Follow instructions of the AC flush machine manufacturer.

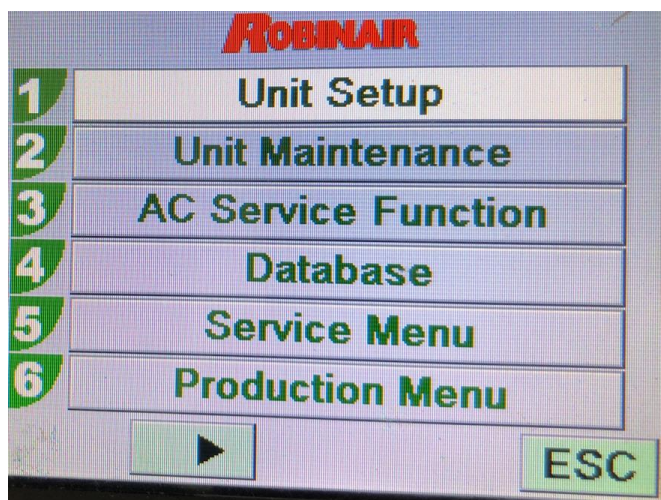

23. **For example-** on the Robinair AC1234-6 machine to change the amount of stored refrigerant in the ISV, go to-
UNIT SETUP
TANK FILL ADJUSTMENT
enter the amount required.

NOTE: On this Robinair AC machine there is 0.9 kg of refrigerant within the system that is not displayed in the ISV tank level. So, to get an actual 4 kg of refrigerant you would need to set the tank level to at least 4.9 kg for the flush procedure to run.

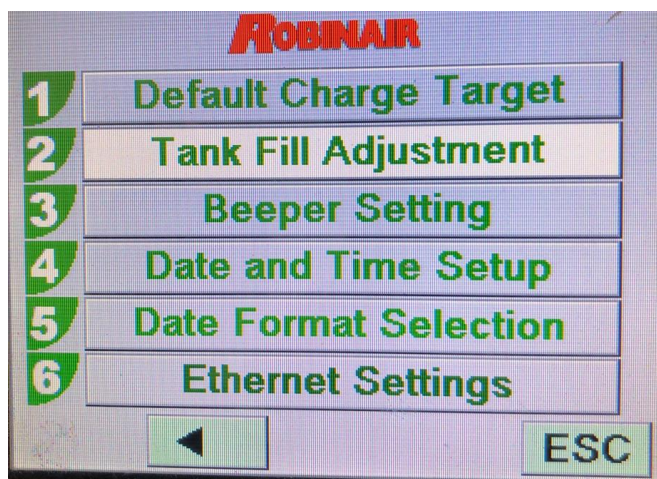



24. A 30-minute **first flush** is recommended. The default value on the AC flush machine may only be 10 minutes. You won't see an option to extend this flush time until **AFTER** the machine has performed its vacuum and pressure tests.

Observe the sight glass on the flush machine at beginning and end of flushing. There should be no debris visible at the end of flushing.

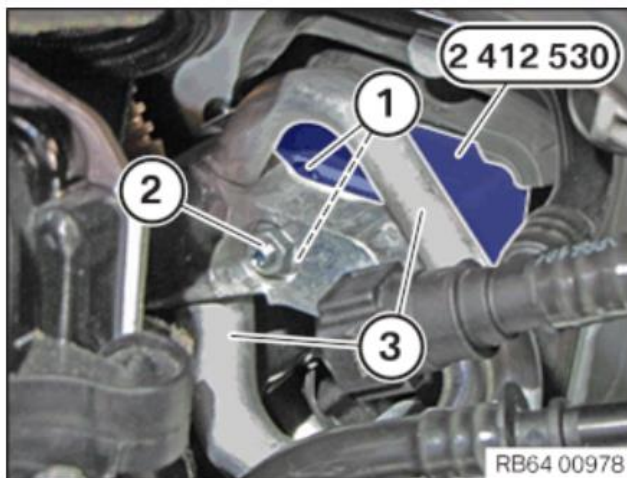

25. After first flush the block off adapter 83 30 2 420 896 must be removed from **EXPANSION VALVE #1**.

Then install flushing adapter **83 30 2 412 530** in place of expansion valve #1. The flushing adapter will have a hole on both inlet and outlet.

- Fasten with the M5 screws (1) of the expansion valve that has been previously removed
- **M5 Bolts Torque 5.5 Nm**

When mounting the refrigerant lines (3) onto the block off plate 1, secure them with the nut previously removed.

- **M6 nut Torque 13 Nm**

26. Expansion Valve #2 and #3 must be replaced and the flushing adapters removed. Replace all O-rings.

27. Follow Repair Instructions and perform **second flush of the AC system**.

28. Remove adapters from Expansion Valve #1 and the refrigerant shutoff valve.

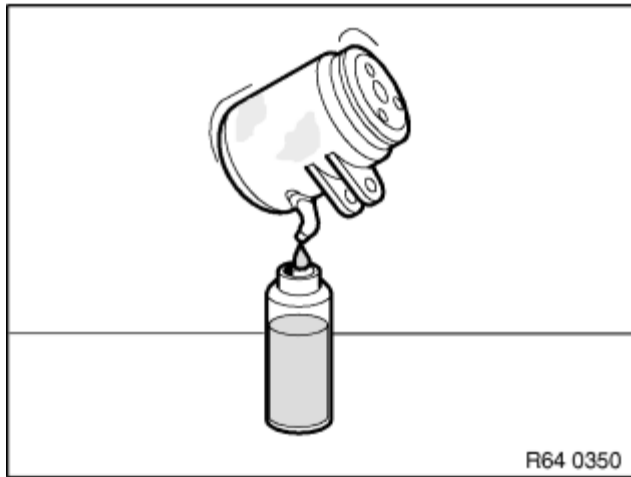

29. After flushing:

For G05 PHEV:

Install new

- air conditioning compressor (EKK)
- air conditioning condenser. (WCC)
- 1 electrical expansion valve on the evaporator (included in the repair kit)
- 1 shutoff valve (included in the repair kit)
- 2 expansion valves on the high-voltage battery (one expansion valve is included in the repair kit, the second expansion valve must be taken from the EPC)

For G20 PHEV:

Install new:

- air conditioning compressor
- air conditioning condenser. (WCC)
- 2 electrical expansion valves (1x on the evaporator, 1x on the high-voltage battery)

NOTE 1: For the **G05** PHEV there is a repair kit available that includes the EKK, Air conditioning condenser with dryer flask, Compressor to condenser pressure line, expansion valve shutoff valve and an electrical expansion valve.

For the **G20** refer to ETK for individual parts.

NOTE 2: if the refrigerant circuit has been flushed, it is not necessary to adjust the amount of refrigerant oil when a new air conditioning compressor is installed due to the 'factory oil fill' being sufficient for the entire system.

- Contact TeileClearing for compressors that are on the TC list
- Replace all O-rings where the system was opened
- Fill the air conditioning system with refrigerant
- Dye may be added to the oil fill to allow for expedited leak identification in case of a problem. Only use a minimal amount of dye concentrate per the manufacturer's recommendation (typical 2-3 drops)
- Make sure compressor run in test plan is completed with ISTA
- Reassess the vehicles AC operation

Repair is complete.

30. Procedure if no flushing equipment is available for the refrigerant circuit and contamination is visible in the components then the refrigerant lines must also be replaced.

Evacuate refrigerant circuit (if not done already).

- Install a new air conditioning compressor, expansion valve (3x), refrigerant shutoff valve (G05 PHEV only) and air conditioning condenser. (WCC) according to the repair instructions.
- For the **G05** PHEV there is a repair kit available that includes the EKK, Air conditioning condenser with dryer flask, Compressor to condenser pressure line, expansion valve shutoff valve and an electrical expansion valve. The second expansion valve for the high voltage battery must be ordered via ETK.

- The battery cooling grid may also have to be replaced, contact the Technical Hotline for support via TSARA.
- Observe oil fill capacity for replaced parts. The oil capacity for the compressor is printed either on a separate tag that comes in the parts box, or directly on the label on the compressor.
- See Repair instructions for 'opening and part exchange in refrigerant circuit' for oil to be added for additional parts that are to be replaced.
- Contact TeileClearing for compressors that are on the TC list.
- Replace all O-rings where the system was opened.
- Evacuate and fill the air conditioning system
- Dye may be added to the oil fill to allow for expedited leak identification in case of a problem. Only use a minimal amount of dye concentrate per the manufacturer's recommendation (typical 2-3 drops)
- Make sure compressor run in test plan is completed with ISTA
- Reassess the vehicles AC operation.

Repair is complete.



31. If you want to document time spent on this repair, please submit an **INFO ONLY TSARA** case.

If you require further technical support, please submit a **REPLY REQUESTED TSARA** case.

PARTS INFORMATION

Obtain and confirm the part numbers for your specific vehicle by entering the chassis number in either ETK or AIR which considers specific equipment and/or options.

G05 PHEV ONLY

Part Number	Description	Quantity
64 50 5 A5B 590	G05 PHEV ONLY - Repair kit for the Air Conditioning Compressor	1

NOTE: This G05 PHEV only repair kit includes the EKK, air conditioning condenser with dryer flask, compressor to condenser pressure line, expansion valve shutoff valve and an electrical expansion valve.

CLAIM INFORMATION

This Service Information Bulletin provides technical, diagnostic, and repair-related information.

Damage and/or issues caused by outside influences are not covered under the BMW limited warranties.

Eligible and Covered Work/Repairs

If the cause of the issue described in this bulletin is due to a defect materials or workmanship, then corresponding repair is covered under the terms of the BMW New Vehicle Limited Warranty for Passenger Cars and Light Trucks.

To submit a claim, please follow the established and applicable warranty policy and procedures (Labor/Part/Sublet) that apply to the repair being performed.

Refer to AIR for the corresponding Defect Code, flat rate labor operations (including diagnosis) and the flat rate unit (FRU) allowances.

Only one Main labor operation code can be claimed per repair visit.

Based on which one applies to your center, please refer to **SI B01 01 20** or **B01 07 20** for the applicable procedure for documenting, claiming, and explaining, on the RO and in the claim comments, your diagnosis work time (WT), job/repair work time (WT), and the vehicle repairs your center performed, unless otherwise required by State law.

FEEDBACK REGARDING THIS BULLETIN

Technical inquiries	Submit feedback at the top of this bulletin
Warranty inquiries	To submit feedback for the CLAIMS section of this bulletin: Submit an IDS ticket to the Warranty Department, or use the chat available in the Warranty Documentation Portal
Parts inquiries	Submit an IDS ticket to the Parts Department