



GROUP	MODEL
Service Campaign	2014-2017MY Forte & Forte Koup (YD)
NUMBER	DATE
SC238 (Rev 2, 10/06/2022)	August 2022

VOLUNTARY SERVICE CAMPAIGN

SUBJECT:

BRAKE TUBE/ LINE INSPECTION/REPLACEMENT & ANTI-CORROSION MATERIAL APPLICATION (SC238)

NOTICE

This bulletin has been revised to include additional information. New/revised sections of this bulletin are indicated by a black bar in the margin area.

This bulletin provides information to inspect and, if necessary, replace the brake tube(s)/line(s) for leakage and also apply additional anti-corrosion material to the underbody components on certain 2014-2017MY Forte and Forte Koup (YD) vehicles produced from November 7, 2012 through April 19, 2017 and originally sold or currently registered in one of the 28 states where heavy amounts of road salt are used.

The 28 states where heavy amounts of road salt are used are: AK, CT, DC, DE, IA, IL, IN, KS, KY, MA, MD, ME, MI, MN, MO, ND, NE, NH, NJ, NY, OH, PA, RI, SD, UT, VT, WI and WV.

Brake line corrosion can occur due to a combination of environment conditions and lack of proper underbody maintenance. Brake line corrosion can occur on vehicles in states where heavy amounts of road salt are used if the materials used for ice/snow removal are not regularly flushed from the underbody of the vehicle. If this condition occurs, customers may experience low brake fluid level that can result in gradually increasing soft brake pedal feel and/or Brake Fluid Warning Light illumination. Follow the procedure outlined in this publication to inspect the brake line for brake fluid leakage and replace the brake line if necessary. In addition, apply a cavity wax and undercoating spray in the indicated locations. Before conducting the procedure, verify that the vehicle is included in the list of affected VINs.

Note: Please remind all customers of the instructions in their Owner's Manual (shown below), to regularly have the underbody of their vehicles washed when road salt is being used in their area.

"Underbody maintenance"

"Corrosive materials used for ice and snow removal and dust control may collect on the underbody. If these materials are not removed, accelerated rusting can occur on underbody parts such as the fuel lines, frame, floor pan and exhaust system, even though they have been treated with rust protection. Thoroughly flush the vehicle underbody and wheel openings with lukewarm or cold water once a month, after off-road driving and at the end of each winter. Pay special attention to these areas because it is difficult to see all the mud and dirt. It will do more harm than good to wet down the road grime without removing it. The lower edges of doors, rocker panels, and frame members have drain holes that should not be allowed to clog with dirt; trapped water in these areas can cause rusting."

**BRAKE TUBE/LINE INSPECTION/REPLACEMENT
& ANTI-CORROSION MATERIAL APPLICATION (SC238)****NOTICE**

To assure complete customer satisfaction, always remember to refer to WebDCS Warranty Coverage (validation) Inquiry Screen (Service → Warranty Coverage → Warranty Coverage Inquiry) for a list of any additional campaigns that may need to be performed on the vehicle before returning it to the customer.

IMPORTANT

For Dealers and Customers Not Immediately affected By This Campaign.

This campaign is primarily being conducted regarding owners whose vehicles in the affected VIN range are owned and maintained in states where significant amounts of road salt are applied. However, the objective of this campaign is to improve customer satisfaction by applying additional anti-corrosion protection, regardless of their current location. As a result, additional customer vehicles not currently listed may need to be inspected and/or repaired as a result of this campaign. Possible situations and dealer responses include:

- (1) A customer who has not received an Owner Notification under this campaign and now resides in a salt belt state. Advise KMA and promptly conduct the campaign repair.
- (2) During normal maintenance or repairs for a vehicle located outside of the salt belt states, the dealer identifies that a vehicle has corrosion damage which appears to warrant a campaign repair. Contact the District Parts and Service Manager for approval before conducting the campaign repair.
- (3) A customer currently living outside a salt belt state alleges a potential corrosion condition or simply requests a repair or an inspection. Promptly conduct an inspection at no charge to the customer. If the dealer identifies that the vehicle has corrosion damage which appears to warrant a campaign repair, contact the District Parts and Service Manager for approval before conducting the campaign repair.

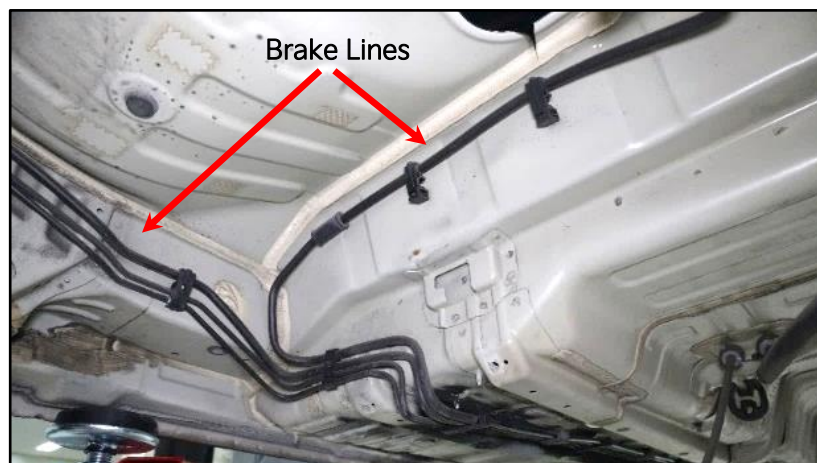

SUBJECT:

BRAKE TUBE/LINE INSPECTION/REPLACEMENT & ANTI-CORROSION MATERIAL APPLICATION (SC238)

Brake Line Inspection Procedure:

- 1a. Lift vehicle on hoist and remove the driver side undercover (A).

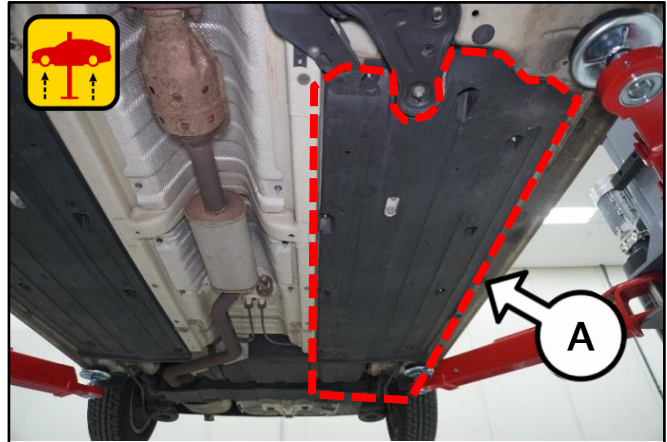

- 1b. Remove the protection cover (B).

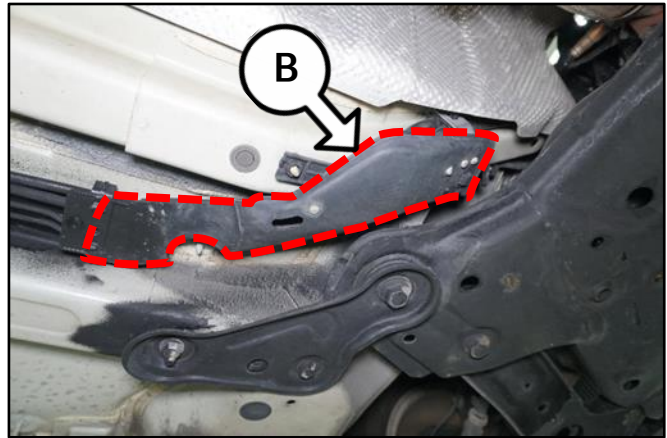

2. Inspect the entire length of the brake lines (L&R - Front to Back of the vehicle) for corrosion and/or fluid leakage, especially in the brake line retaining clip areas shown.



- 3a. Is there evidence of brake fluid leakage and/or corrosion?

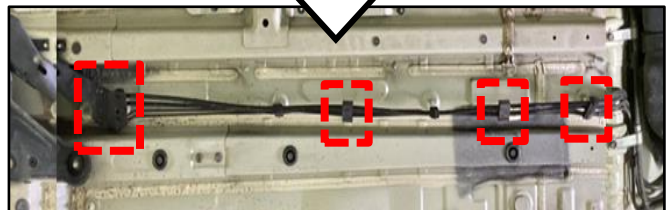

- 3b. • **No (OK):** Proceed to the 'Cavity Wax Application Procedure' on page 9.

- 3c. • **Yes (NG):** Proceed to the 'Replacement Procedure' to replace the brake line(s). (Sample of severe corrosion and brake fluid leak).



SUBJECT:

BRAKE TUBE/LINE INSPECTION/REPLACEMENT & ANTI-CORROSION MATERIAL APPLICATION (SC238)

Replacement Procedure:

1. Remove the center muffler assembly (B) by referring to "Engine Mechanical System → Intake and Exhaust System → Muffler → Repair procedures (Center Muffler)" in the applicable Shop Manual on KGIS.

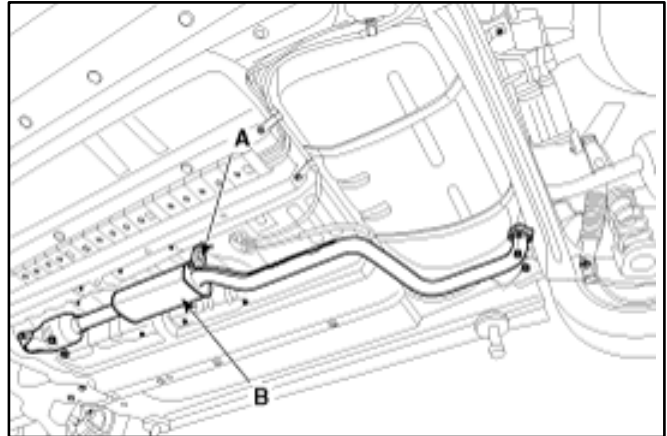

2. Remove the auxiliary canister (C) by referring to "Emission Control System → Evaporative Emission Control System → Canister → Repair procedures" in the applicable Shop Manual on KGIS.

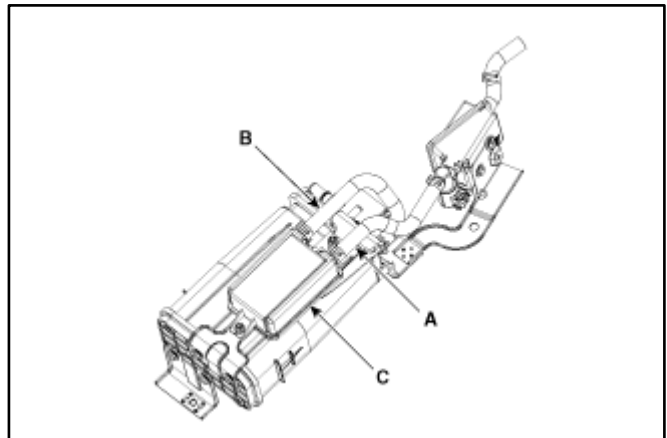

3. Remove the fuel tank by referring to "Engine Control/Fuel System → Fuel Delivery System → Fuel Tank → Repair procedures" in the applicable Shop Manual on KGIS.



CAUTION

Ensure to release the residual pressure in the fuel line.

SUBJECT:

BRAKE TUBE/LINE INSPECTION/REPLACEMENT & ANTI-CORROSION MATERIAL APPLICATION (SC238)

4. Remove the brake tube line by disconnecting the holder clips (K) in the locations shown.

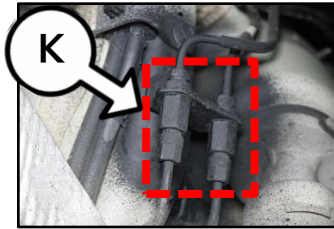

Tightening torque for Brake Tube Nuts:
9.4 - 12.3 lb.ft (12.7 - 16.7 N.m)

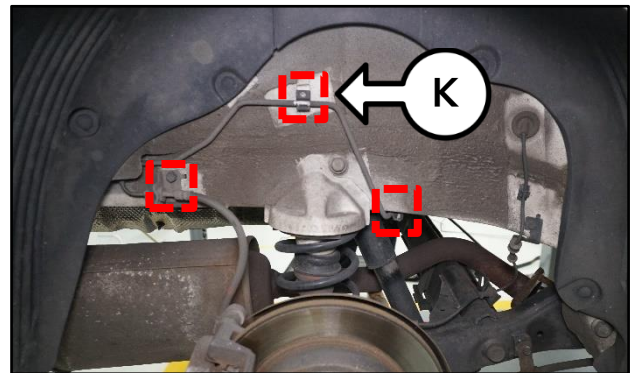
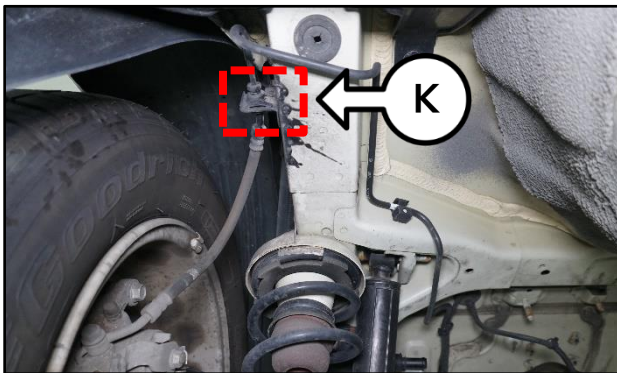
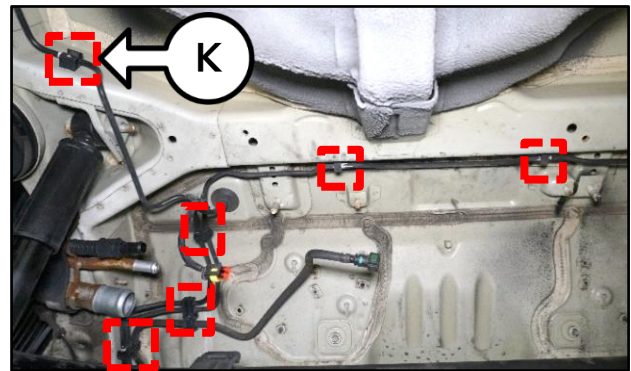
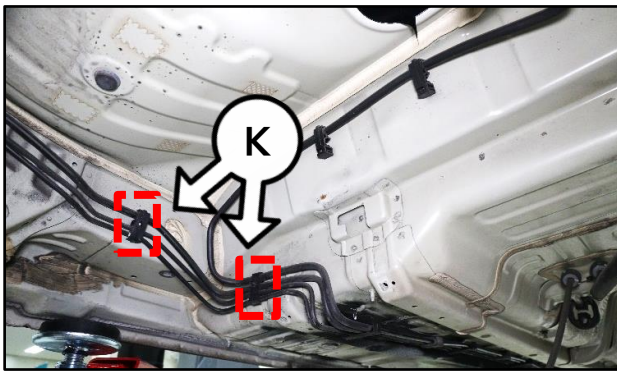
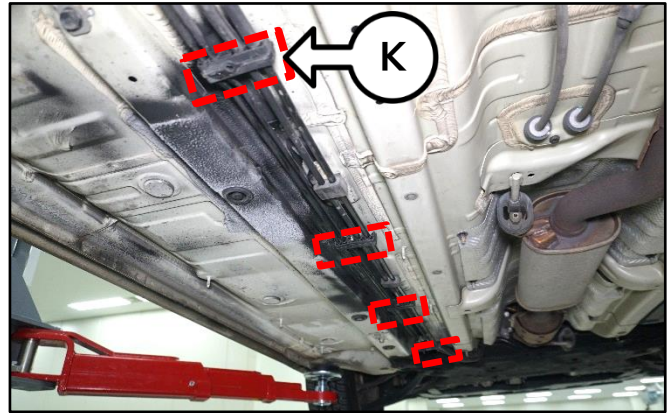

5. Separate the brake line from the fuel lines and remove the left and right side brake lines.
6. Install the new brake lines in the reverse order of removal.
7. Install all removed parts in reverse order of disassembly.
8. Proceed to the Application Procedure to apply additional cavity wax and undercoating material before lowering vehicle from hoist.
9. Bleed brake system and adjust brake fluid levels by referring to "Brake System → Brake System → Repair procedures → Brake System Bleeding" in the applicable Shop Manual on KGIS.

SUBJECT:

BRAKE TUBE/LINE INSPECTION/REPLACEMENT & ANTI-CORROSION MATERIAL APPLICATION (SC238)

Anti-Corrosion Material Application:

NOTICE

The procedure illustrated below is broken down into Preparation, Cleaning, Cavity Wax Application, and Undercoat Application for the areas listed below. Images shown in the procedure are for reference only purposes and will vary by model.

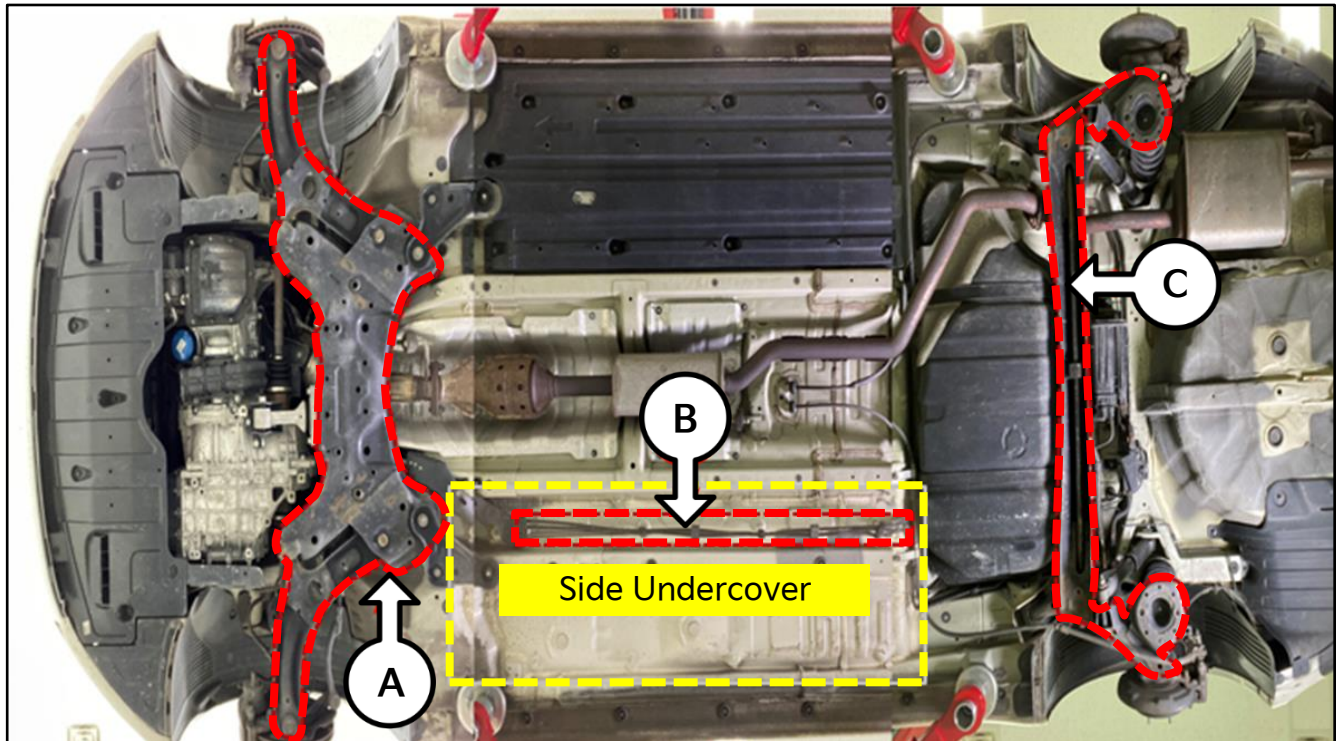

Affected Areas for Application of Anti-Corrosion Material

A: Sub Frame / Front Lower Arms

B: Fuel / Brake Tube

C: Torsion Axle Complete

Other: Two-way Brake Tube Connector / Flexible Brake Hose / Fuel Tank Band / Parking Cable Bracket

WARNING

Do not eat, drink, or smoke while using these products. Keep away from heat, sparks, open flames, hot surfaces, and other ignition sources. Avoid breathing mist, vapors, spray. Wash thoroughly after handling. Wear protective gloves, protective clothing, eye protection, face protection.

Use with adequate ventilation. Respiratory: Level of exposure needs to be determined. If required, use a particulate filter, a NIOSH-approved air purifying respirator with organic vapor cartridge or a supplied air respirator. Filters should be replaced when breathing becomes labored. Cartridges should be replaced when odors pass through. Refer to MSD sheets (Links: [Cavity Wax](#), [Undercoating](#)) for additional information and important warnings. All warnings provided by the MSD sheet are hereby incorporated by reference.

SUBJECT:

BRAKE TUBE/LINE INSPECTION/REPLACEMENT & ANTI-CORROSION MATERIAL APPLICATION (SC238)

Preparation:

If vehicle undercarriage has significant road salt residue, an undercarriage carwash is recommended. Prior to washing the undercarriage, document the vehicle's undercarriage condition by taking two (2) photos and submitting them with the warranty claim on form [WRTY146](#) as specified in [Warranty Bulletin 2022-31](#). After an undercarriage wash, allow vehicle to dry or use compressed air. These procedures should **ONLY** be performed in temperatures above 32°F (0°C). Ensure that all surfaces are completely dry and free of moisture before applying cavity wax or undercoating.

Cleaning:

1. On vehicles equipped with a splash shield, remove the splash shield prior to starting the procedure.
2. Remove any rust scales or contaminants from the following components by hammering with a small hammer, and removing any surface rust with a wire brush.

! CAUTION

- Do **NOT** strike with a hammer the fuel/brake lines or protector, parking brake cable, or wiring harnesses. Use a wire brush only.
- Use care when striking with a hammer to not cause dimpling or damage.

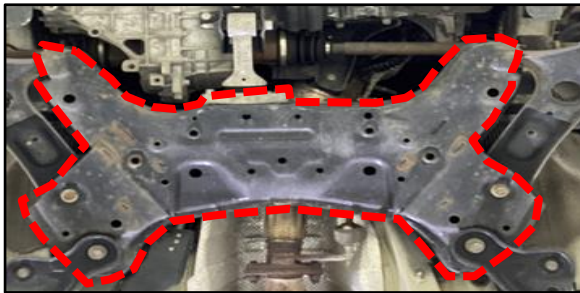

Sub-Frame

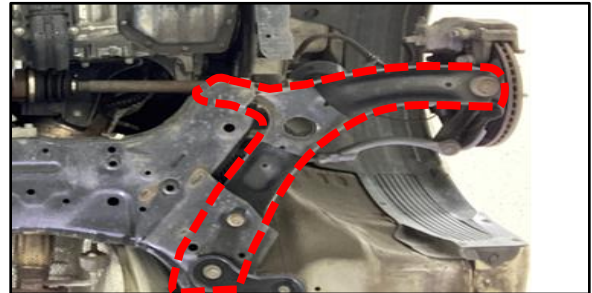

Front Lower Arms (LH/RH)

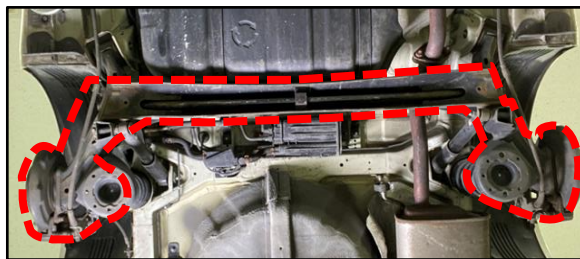

Torsion Axle Complete



Fuel Tank Bands



Parking Brake Cable Brackets

SUBJECT:

BRAKE TUBE/LINE INSPECTION/REPLACEMENT & ANTI-CORROSION MATERIAL APPLICATION (SC238)

3. After hammering and wire brushing is completed, use an air gun to blow compressed air into all service holes and areas of the chassis components noted below to remove any additional rust scales or contaminants.

NOTICE

When using compressed air to remove rust scale and contaminants, be sure to rotate the air nozzle inside the service holes to completely remove debris that may be lodged in cavities.

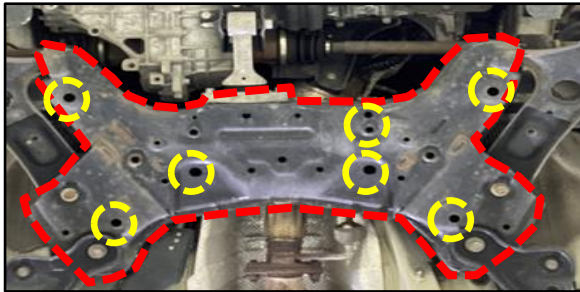

Sub-Frame

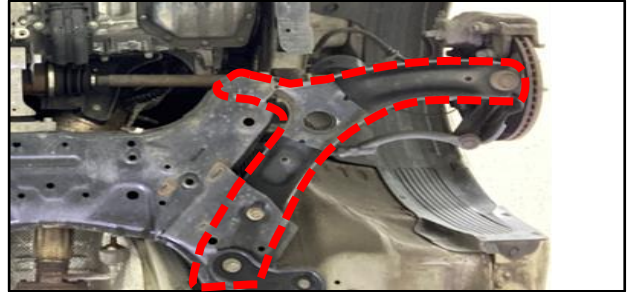

Front Lower Arms (LH/RH)



Torsion Axle Complete

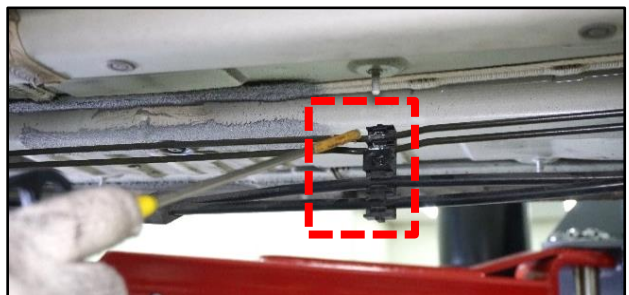

Fuel & Brake Tube Lines

Note: Be sure to remove all debris that may have collected between the fuel/brake lines.

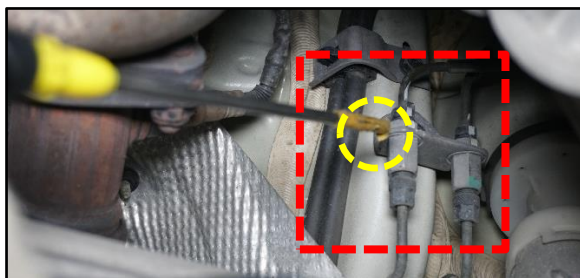

Two-way Brake Tube Connector



Flexible Brake Hose



Parking Brake Cable Brackets



Fuel Tank Bands



SUBJECT:

BRAKE TUBE/LINE INSPECTION/REPLACEMENT & ANTI-CORROSION MATERIAL APPLICATION (SC238)

Cavity Wax Application:

WARNING

Do not eat, drink, or smoke while using this product. Keep away from heat, sparks, open flames, hot surfaces, and other ignition sources. Avoid breathing mist, vapors, spray. Wash thoroughly after handling. Wear protective gloves, protective clothing, eye protection, face protection.

Use with adequate ventilation. Respiratory: Level of exposure needs to be determined. If required, use a particulate filter, a NIOSH-approved air purifying respirator with organic vapor cartridge or a supplied air respirator. Filters should be replaced when breathing becomes labored. Cartridges should be replaced when odors pass through. Refer to MSD sheets (Links: [Cavity Wax](#), [Undercoating](#)) for additional information and important warnings. All warnings provided by the MSD sheet are hereby incorporated by reference.

NOTICE

To prevent excessive vaporization of the cavity wax, use an inline air pressure regulator and adjust the pressure to the wax gun to 70-90 PSI max. (Labels on older cavity wax bottles may still call for 90-120 PSI; disregard and adjust pressure to 70-90 PSI max).

NOTICE

- This procedure should **ONLY** be performed in temperatures above 32°F (0°C). Ensure that all surfaces are completely dry and free of moisture before applying cavity wax or undercoating.
- Using expired product may result in a poor spray pattern and/or insufficient cavity wax application. Discard any such product (following all applicable local/state/federal regulations). An expiration date has been added to the cavity wax so that any expired wax can be easily identified and discarded. The undercoating has a manufacturing date code printed on the bottom of the can. Undercoating should be discarded two years after the manufacturing date. In case of questions, please contact the Kia Chemical Program through <https://www.kdealer.com>.

1. Using Quick Disconnect fittings suitable for the dealer's air supply system, install the in-line pressure regulator to a conveniently located wall air outlet and adjust the pressure to 70-90 PSI. Connect the air hose to the regulator, and connect the other end of the hose to the Kia Injection Gun (06700 10100), used to apply the cavity wax.
- 2a. Insert the wax injection gun nozzle deeply into all service holes.
- 2b. Then slowly pull out the nozzle while spraying the cavity wax inside of the components shown below.
Note: Rotate the nozzle while spraying to achieve an even coating of wax inside.



Click [here](#) to view a tutorial reference on wax application used in SC141.

SUBJECT:

BRAKE TUBE/LINE INSPECTION/REPLACEMENT & ANTI-CORROSION MATERIAL APPLICATION (SC238)

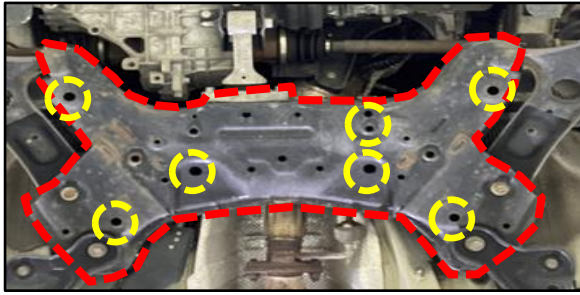

Sub-Frame

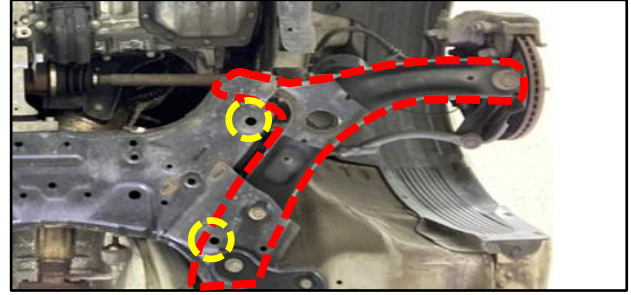

Front Lower Arms (LH/RH)



Torsion Axle Complete

- After applying cavity wax to components, use the borescope (1K545 4D200QQK) to check for proper wax coating through the component service holes.



- Power up and calibrate the display orientation direction by gripping the probe and turning as required. (Apply and align the 90-degree angle adapter, as needed, for picture quality.)

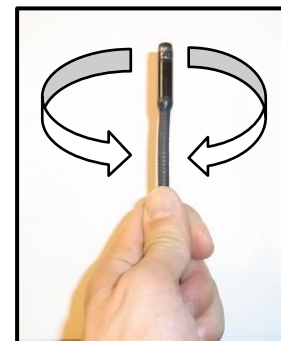
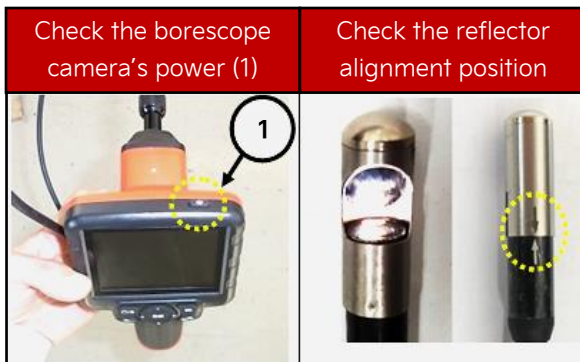

SUBJECT:

BRAKE TUBE/LINE INSPECTION/REPLACEMENT & ANTI-CORROSION MATERIAL APPLICATION (SC238)

5. Once the camera and display are properly oriented, bend the probe just behind the camera to help maintain orientation during inspection.

NOTICE

If it is difficult to view the inside of the arm with the camera due to flexibility of the scope wand, use the 90-degree lens attachment.

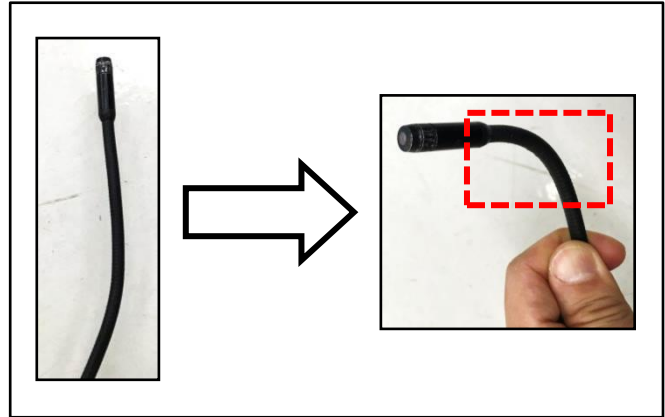

6. Insert the camera into hole as shown.

NOTICE

Always ensure the camera lens and 90-degree adaptor are cleaned with a fresh paper towel and rubbing alcohol prior to inspection and image capturing.

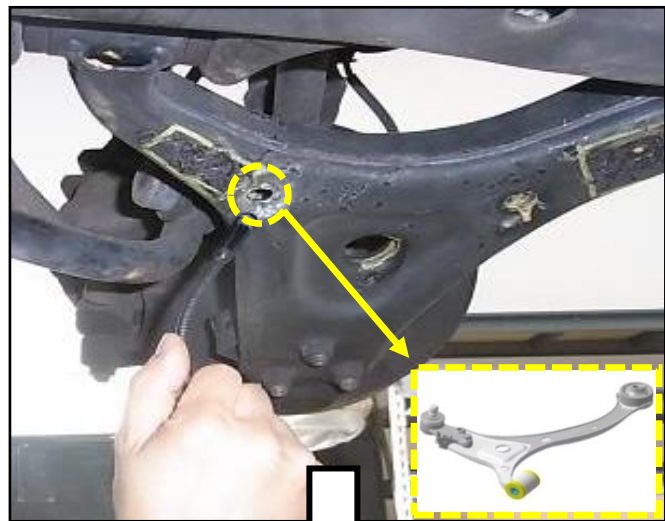

7. Rotate the camera in order to check all angles for proper wax application inside the inspected components, and to obtain your images that will be used for warranty claim submission.



BRAKE TUBE/LINE INSPECTION/REPLACEMENT & ANTI-CORROSION MATERIAL APPLICATION (SC238)

NOTICE

Images of wax application must be submitted per **Warranty Bulletin 2022-31**. Claim approval will be delayed if images are not submitted. Images to be submitted are as follows:

- Inside Front Lower Control Arm, LH & RH.
- Inside Front Cross Member.
- Inside Rear Lower Control Arm, LH & RH.
- Inside Rear Cross Member (Unless Cross Member is open, in which case an exterior picture will suffice).

Refer to **Appendix 2** for **WRTY146 form**.

Suggestion: **Appendix 3** shows one (optional) method of transferring photos for claim processing. Select the best method depending on equipment and availability at your dealership.

Before Wax Application



After Wax Application



Undercoating Spray Application:

WARNING

Do not eat, drink, or smoke while using this product. Keep away from heat, sparks, open flames, hot surfaces, and other ignition sources. Avoid breathing mist, vapors, spray. Wash thoroughly after handling. Wear protective gloves, protective clothing, eye protection, face protection.

Use with adequate ventilation. Respiratory: Level of exposure needs to be determined. If required, use a particulate filter, a NIOSH-approved air purifying respirator with organic vapor cartridge or a supplied air respirator. Filters should be replaced when breathing becomes labored. Cartridges should be replaced when odors pass through. Refer to MSD sheets (Links: [Cavity Wax](#), [Undercoating](#)) for additional information and important warnings. All warnings provided by the MSD sheet are hereby incorporated by reference.

1. Using undercoating spray, be sure to completely coat the Sub Frame, Front Lower Arms, Fuel/Brake Tube Line, and Torsion Axle Complete.

SUBJECT:

**BRAKE TUBE/LINE INSPECTION/REPLACEMENT
& ANTI-CORROSION MATERIAL APPLICATION (SC238)**

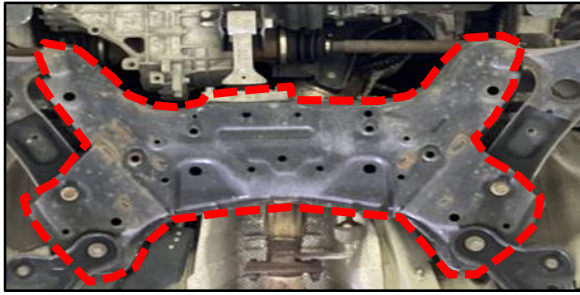

Sub-Frame

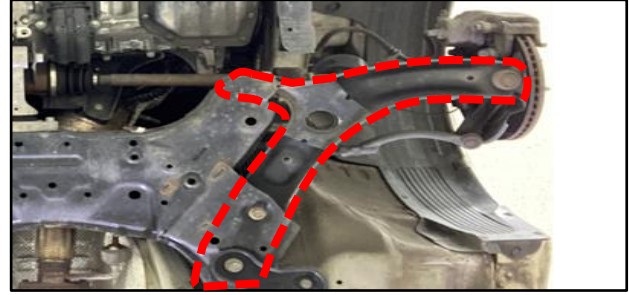

Front Lower Arms (LH/RH)



Torsion Axle Complete

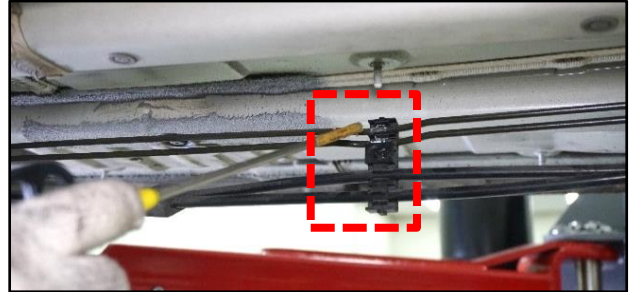

Fuel & Brake Tube Lines

NOTICE

Be sure to thoroughly spray undercoating on all sides of fuel and brake tube lines (above and below).

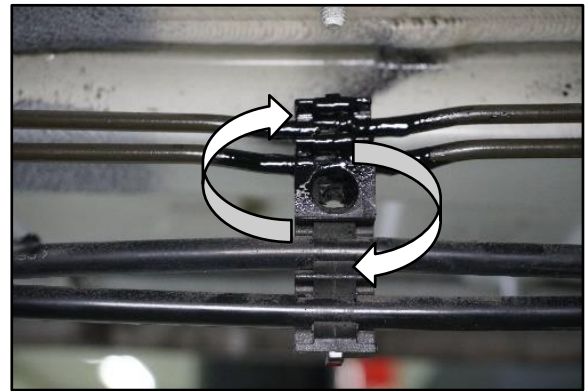

2. Spray undercoating on the Two-way Brake Tube Connector, Flexible Brake Hose, Fuel Tank Bands, and Parking Brake Cable Brackets.

CAUTION

Be careful NOT to spray undercoating onto the brake calipers or friction surfaces during application.



Two-way Brake Tube Connector

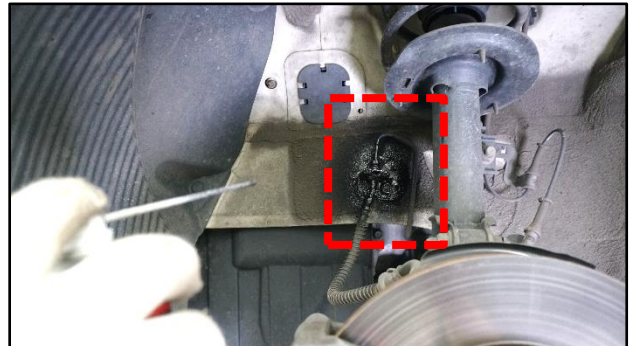

Flexible Brake Hose

SUBJECT:

BRAKE TUBE/LINE INSPECTION/REPLACEMENT & ANTI-CORROSION MATERIAL APPLICATION (SC238)



Parking Brake Cable Brackets

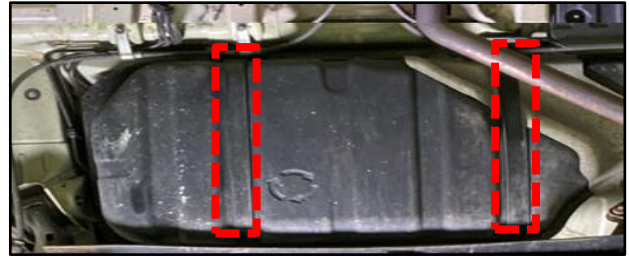

Fuel Tank Bands

3. Be sure to completely coat the four (4) brake hose anchor clips on both sides, front and rear of the vehicle.

NOTICE

Images of undercoating must be submitted per **Warranty Bulletin 2022-31**. Claim approval will be delayed if images are not submitted.

Images to be submitted are as follows:

- Outside/exterior of Front Lower Control Arm and Sub Frame after undercoating application. One combined photo showing both Control Arms and Sub Frame clearly and completely will suffice.

Refer to **Appendix 2** for **WRTY146 form**.

Suggestion: **Appendix 3** shows one (optional) method of transferring photos for claim processing. Select the best method depending on equipment and availability at your dealership.

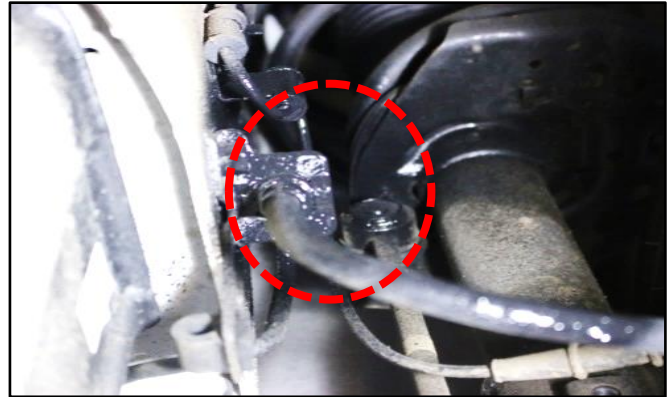

4. If previously removed, reinstall the splash shield.
5. Assemble the fuel and brake tube clips and side under cover in the reverse order of removal.
6. If brake tube line was replaced, bleed brake system and adjust brake fluid levels by referring to "Brake System → Brake System → Repair procedures → Brake System Bleeding" in the applicable Shop Manual on KGIS.

NOTICE

Allow cavity wax and underbody coating to cure for a least 1 hour prior to vehicle being driven, especially during rain or snow conditions.

SUBJECT:

BRAKE TUBE/LINE INSPECTION/REPLACEMENT & ANTI-CORROSION MATERIAL APPLICATION (SC238)

AFFECTED VEHICLE RANGE:

Model	Production Date Range
Forte (YD)	November 7, 2012 to April 19, 2017

REQUIRED TOOL:

Tool Name	Part Number	Figure	Comments
Wax Injection Gun	06700 10100		Initial supply was auto-shipped to Dealers for SC141. For replacements, contact Snap-On Business Solutions at (888) 542-1011
Wax Application Hose	06700 10110		
Borescope Kit	1K545 4D200QQK		Locally Sourced
Hammer	-		
Air Gun	-		
Brush	-		
Air Pressure Regulator	IRCR37121600		Initial supply was auto-shipped to Dealers for SC141. For replacements, contact Snap-On Business Solutions at (888) 542-1011
Respirator (Organic/ N95 Particulate)	SSC366150		
Cartridge for Respirator (6pk)	SSC100100		
Filter for Respirator (12pk)	SSC106000		





SUBJECT:

BRAKE TUBE/LINE INSPECTION/REPLACEMENT & ANTI-CORROSION MATERIAL APPLICATION (SC238)

REQUIRED PART:

Part Name	Part Number	Figure	Qty.	Comments
RR Brake Tube Kit (4DR/2DR)	58730 A7000QQK	See Below	1	4 Door/2 Door Vehicles
RR Brake Tube Kit (5DR)	58730 A7600QQK	See Below	1	5 Door Vehicles

Part Name	Part Number	Figure	Qty.	Comments
Kia Frame Rust Preventative	UM090 CH041		1	Limit one (1) can per vehicle (Order through Kia Chemicals)
Undercoating Spray	UM010 CH044		3	Limit three (3) cans per vehicle (Order through Kia Chemicals)
Brake Fluid DOT4	UM010 CH043		1	Refer to Shop Manual specifications on KGIS

WARRANTY INFORMATION:

N Code: N99 C Code: C99

Model	Claim Type	Causal P/N	Qty.	Repair Description	Labor Op Code	Op Time	Replacement P/N	Qty.
All	R	58735 A7600	0	(SC238) Inspection of Brake Tube Leakage + Application of Anti-Corrosion Material	220083R3	0.8 M/H	UM090 CH041	1
							UM010 CH044	3
4Dr/2Dr	R	58735 A7600	0	(SC238) Inspection of Leakage+ Brake Tube Replacement +Application of Anti-Corrosion Material	220083R4	2.6 M/H	58730 A7000QQK	1
UM090 CH041							1	
UM010 CH044							3	
UM010 CH043							1	
5Dr							58730 A7600QQK	1
UM090 CH041							1	
UM010 CH044							3	
UM010 CH043	1							

Refer to Warranty Bulletin 2022-31 for claim submission procedures.

NOTICE

VIN inquiry data for this repair is provided for tracking purposes only. Kia retailers should reference SC238 when accessing the WebDCS system.