

Subject: DRAIN MAINTENANCE FOR RETRACTABLE HARDTOP	Bulletin No.: 09-035/22
	Last Issued : 09/06/2022

BULLETIN NOTES

APPLICABLE MODEL(S)/VINS:

2016-2022 MX-5 RF

DESCRIPTION

Some vehicles may experience improper roof drainage and may flood the interior of the vehicle. This may be caused by clogging in the roof drainpipe and improper drainage cleaning.

Some customers may not be aware of the necessity of drainage cleaning and foreign matter (dust or fallen leaves) may accumulate in the drainpipe.

Explain the necessity of the cleaning and its procedure described in the owner's manual to the customer.

Excerpt from Owner's Manual (for customer explanation)

There are drainage outlets on the left and right of the lower side of the rear window.

If leaves or other foreign matter block the drainage outlets, water may enter the cabin. (Clean the drainage at least once every 6 months).

Remove leaves and other foreign matter accumulated in the drainage outlet.

Pour about 200 ml (200 cc) of water at once into each of the left and right drainage outlets to wash away small particles of foreign matter inside the drainage path.

CAUTION: Use washer fluid instead of pure water in cold climate. If pure water is used, it may freeze and block the drain path.

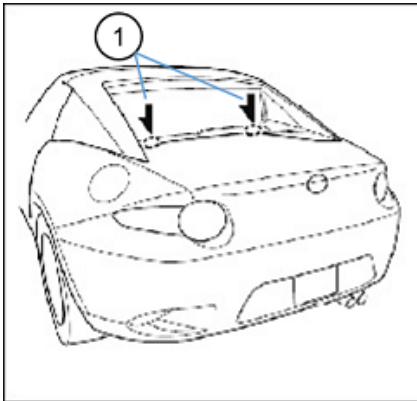

(1) Drain outlet

Customers having this concern should have their vehicle repaired using the following repair procedure.

CONSUMER NOTICE: The information and instructions in this bulletin are intended for use by skilled technicians. Mazda technicians utilize the proper tools/ equipment and take training to correctly and safely maintain Mazda vehicles. These instructions should not be performed by "do-it-yourselfers." Customers should not assume this bulletin applies to their vehicle or that their vehicle will develop the described concern. To determine if the information applies, customers should contact their nearest authorized Mazda dealership. Mazda North American Operations reserves the right to alter the specifications and contents of this bulletin without obligation or advance notice. All rights reserved. No part of this bulletin may be reproduced in any form or by any means, electronic or mechanical---including photocopying and recording and the use of any kind of information storage and retrieval system ---without permission in writing.

REPAIR PROCEDURE

1. Verify customer concern.
2. Inquire whether the drain is cleaned regularly according to the owner's manual. Particularly check the frequency of cleaning (once every 1-3 months) for customers who usually park in dusty places, or near trees where fallen leaves often adhere to the body.
3. Inspect the vehicle for small particles, leaves, etc. on the body, especially around the rear roof.
4. Make a determination from the customer's comments and vehicle condition whether further inspection is necessary.
 - If yes, go to step 5.
 - If no, advise the customer to clean the drain regularly and refer to step 6.
5. Further inspections (To be performed only if the customer agrees to the inspection). Pour 1.27 cups (300ml) of water into each drain outlet, within 10 seconds pour an additional 1.27 cups of water. Check the amount and condition of the water flow from the drainpipe on the underside.
 - If the amount of water decreases about 25 to 30 seconds after water is poured and changes to drops, go to step 7.
 - If the water flow is maintained for more than 30 seconds after water is poured, or if it starts dripping immediately after water is poured, it is considered abnormal. Refer to step 6 (Cleaning procedure).

CAUTION: Use washer fluid instead of pure water in cold climate. If pure water is used, it may freeze and block the drain path.

6. Clean the drainages (refer to the cleaning procedure below).

7. Customer explanation/recommendation

Explain to customer the following:

- a) Clean drainage outlet regularly in accordance with the description in the owner's manual.
- b) If proper maintenance is not performed, the drainpipe(s) may clog and water may enter the cabin.
- c) If customer parks their vehicle in dusty places, or near trees, clean the drainage(s) more frequently (once every 1-3 months) than the owner's manual describes as leaves often adhere to the body.
- d) When cleaning the drain, use 0.84 cups (200cc) of water. If the water flow is not smooth or only drips, the drain is most likely clogged. Advise the customer to consult a Mazda dealership for the overhaul cleaning.

CAUTION: Use washer fluid instead of pure water in cold climate. If pure water is used, it may freeze and block the drain path.

CONSUMER NOTICE: The information and instructions in this bulletin are intended for use by skilled technicians. Mazda technicians utilize the proper tools/ equipment and take training to correctly and safely maintain Mazda vehicles. These instructions should not be performed by "do-it-yourselfers." Customers should not assume this bulletin applies to their vehicle or that their vehicle will develop the described concern. To determine if the information applies, customers should contact their nearest authorized Mazda dealership. Mazda North American Operations reserves the right to alter the specifications and contents of this bulletin without obligation or advance notice. All rights reserved. No part of this bulletin may be reproduced in any form or by any means, electronic or mechanical--including photocopying and recording and the use of any kind of information storage and retrieval system ---without permission in writing.

Cleaning procedure

Parts used				
No	Name	Qty	Part No.	Memo
1	Resin Tube	1	-	For cleaning Diameter: 0.20in-0.22in (5mm-5.5 mm) Length: Approx. 15.75in (400mm)
2	Air blow gun	1	-	For cleaning
3	Tape	1	-	For fixing air duster and tubes
4	Flat screwdriver	1	-	For clip removal
5	Clip remover	1	-	

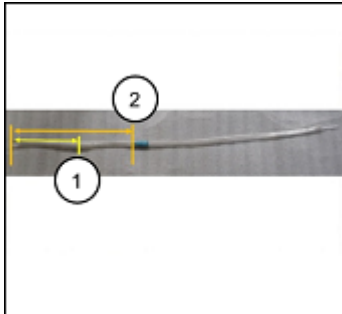
Before starting cleaning	NOTE:
Park vehicle on level ground.	<p>Prepare a tube thinner than the size of the drain grate</p>  <p>(1) Width of drain grating : 0.22in (5.5mm)</p>
Mark 3.54in (90mm) (1) and 6.30in (160mm) (2) from the end of the tube.	

CONSUMER NOTICE: The information and instructions in this bulletin are intended for use by skilled technicians. Mazda technicians utilize the proper tools/ equipment and take training to correctly and safely maintain Mazda vehicles. These instructions should not be performed by "do-it-yourselfers." Customers should not assume this bulletin applies to their vehicle or that their vehicle will develop the described concern. To determine if the information applies, customers should contact their nearest authorized Mazda dealership. Mazda North American Operations reserves the right to alter the specifications and contents of this bulletin without obligation or advance notice. All rights reserved. No part of this bulletin may be reproduced in any form or by any means, electronic or mechanical---including photocopying and recording and the use of any kind of information storage and retrieval system ---without permission in writing.

Connect the tube and air blow gun with tape.

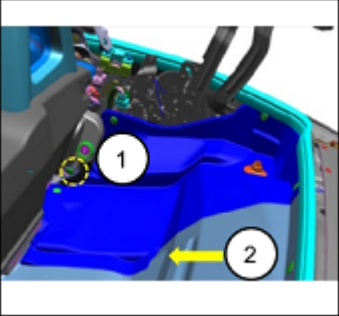

Procedure	Points and Aim of work
<p>1. Set the retractable hardtop in the following position. Set the rear roof (1) fully open and the front (2) fully closed to ensure sufficient space for cleaning work.</p> 	<p>NOTE: Set the hardtop using the following steps</p> <ol style="list-style-type: none"> 1. Operate the hardtop to grasp the fully open position of the rear roof. 2. While opening (or closing) the hardtop, stop the switch operation when the rear roof reaches the full open position. 3. Operate the switch to close the slightly open front roof, and stop the switch operation when the front roof reaches the fully closed position. <p>NOTE: If the rear roof moves lower than the fully open position during the switch operation, start over again.</p> <ol style="list-style-type: none"> 4. Confirm that the rear roof is fully open and the front roof is fully closed.
<p>2. Remove clip (1) from rear side trim</p>  <p>(2) Front of vehicle</p>	
<p>3. Remove clips (1) to (3) from the side shelf.</p>	

CONSUMER NOTICE: The information and instructions in this bulletin are intended for use by skilled technicians. Mazda technicians utilize the proper tools/ equipment and take training to correctly and safely maintain Mazda vehicles. These instructions should not be performed by "do-it-yourselfers." Customers should not assume this bulletin applies to their vehicle or that their vehicle will develop the described concern. To determine if the information applies, customers should contact their nearest authorized Mazda dealership. Mazda North American Operations reserves the right to alter the specifications and contents of this bulletin without obligation or advance notice. All rights reserved. No part of this bulletin may be reproduced in any form or by any means, electronic or mechanical--including photocopying and recording and the use of any kind of information storage and retrieval system ---without permission in writing.

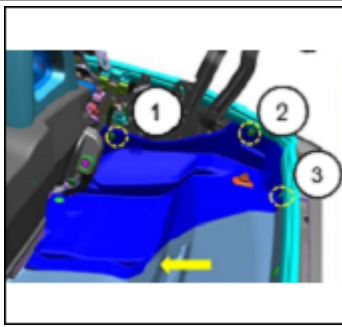

4. Remove rear side trim

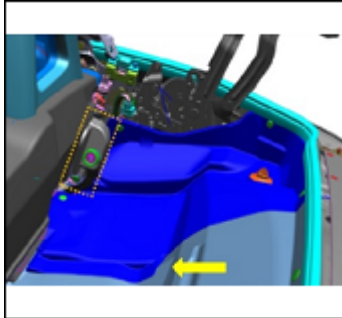

NOTE: The rear side trim and retractable hardtop drain hose are connected, do not pull hard as they cannot be separated.

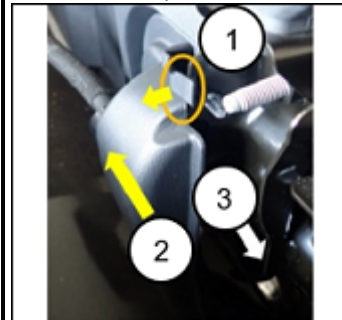

- (1) Pull up by nails
- (2) Slide in the direction of the arrow
- (3) Right outside of the vehicle

5. Remove the clip (1) on the side shelf

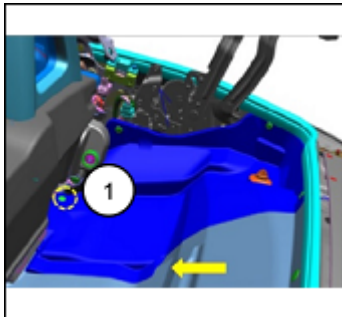

NOTE: Since the clip position is just below the rear side trim, remove the clip (1) while shifting the position of rear side trim.

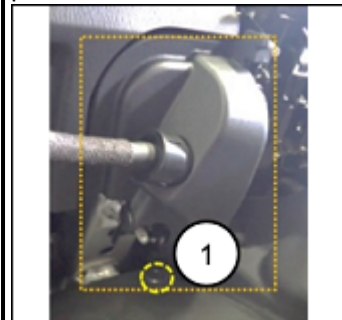

6. Push stopper rubber end face (1) under side shelf.

CONSUMER NOTICE: The information and instructions in this bulletin are intended for use by skilled technicians. Mazda technicians utilize the proper tools/ equipment and take training to correctly and safely maintain Mazda vehicles. These instructions should not be performed by "do-it-yourselfers." Customers should not assume this bulletin applies to their vehicle or that their vehicle will develop the described concern. To determine if the information applies, customers should contact their nearest authorized Mazda dealership. Mazda North American Operations reserves the right to alter the specifications and contents of this bulletin without obligation or advance notice. All rights reserved. No part of this bulletin may be reproduced in any form or by any means, electronic or mechanical--including photocopying and recording and the use of any kind of information storage and retrieval system ---without permission in writing.

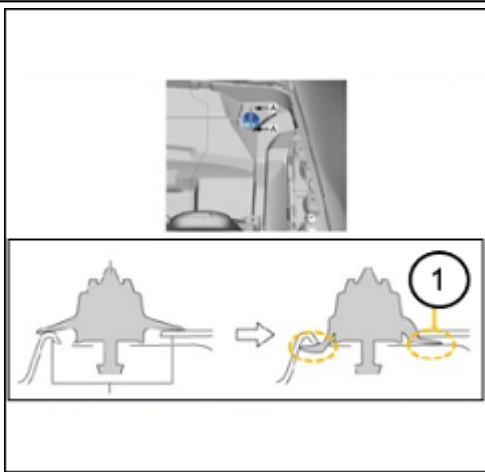

7. Move the side shelves and rear side trim (1) toward the center of the vehicle.

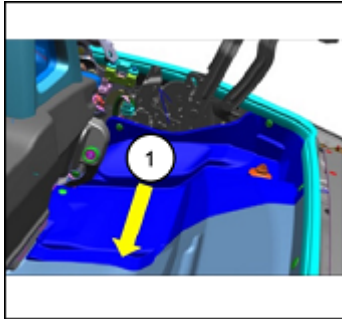

8. Remove the stopper rubber from the body panel.

9. If there are leaves or dust around the drain, remove them with tweezers, etc.



10. Clean in 2 steps, referring to the right.

NOTE: Overall structure of drain
There are two valves from the drain opening to the drainage area on the underside of the vehicle.

CONSUMER NOTICE: The information and instructions in this bulletin are intended for use by skilled technicians. Mazda technicians utilize the proper tools/ equipment and take training to correctly and safely maintain Mazda vehicles. These instructions should not be performed by "do-it-yourselfers." Customers should not assume this bulletin applies to their vehicle or that their vehicle will develop the described concern. To determine if the information applies, customers should contact their nearest authorized Mazda dealership. Mazda North American Operations reserves the right to alter the specifications and contents of this bulletin without obligation or advance notice. All rights reserved. No part of this bulletin may be reproduced in any form or by any means, electronic or mechanical---including photocopying and recording and the use of any kind of information storage and retrieval system ---without permission in writing.

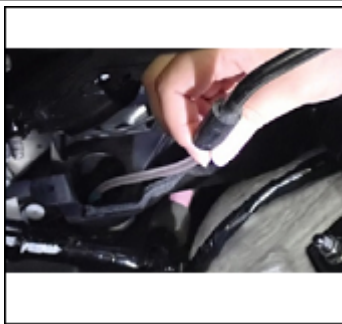

NOTE: Cover around the drain and tube with a waste cloth or something adequate when air-blowing, since water and dirt will be splashed.

Step 1: Insert the cleaning tube into the drain to the marked position (3.54in. or 90 mm).
Air blow for 10 seconds x 2 times while pouring .084 cups (200cc) of water down the drain.

Step 2: Insert the cleaning tube into the drain to the marked position 6.29in (160mm).
Air blow for 10 seconds x 2 times while pouring 0.84 cups (200 cc) of water down the drain.

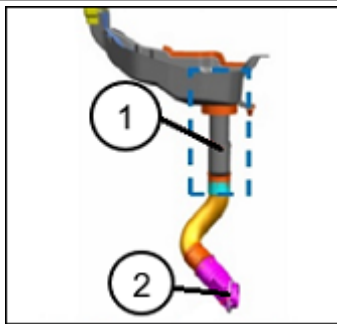

NOTE: The tube can be easily inserted by repeatedly rotating it clockwise/ counterclockwise.

Clean the inside of the drain in 2 steps.
Step 1: Remove the dust on the top of valve (2) with water and air by tube (1).

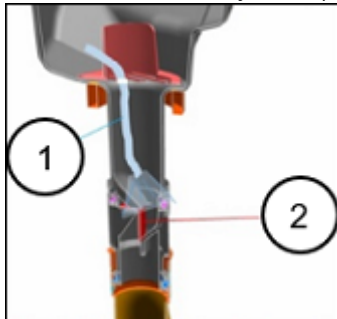

Step2 □ Remove the dust between valves (2) and (3) with water and air by tube (1)

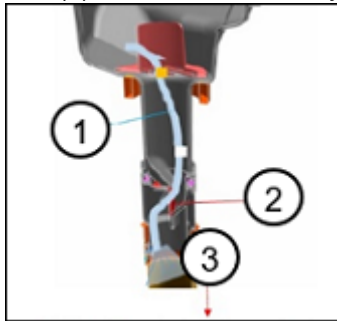

11. Fill the drain with 1.27 cups (300 ml or 300 cc) of water and confirm that the blockage has been cleared.
(The procedure is the same as the first inspection.)

12. Reassemble the side shelves and rear side trim.

NOTE:
Pay attention to the positioning pins.
Install the clips in the following order.

CONSUMER NOTICE: The information and instructions in this bulletin are intended for use by skilled technicians. Mazda technicians utilize the proper tools/ equipment and take training to correctly and safely maintain Mazda vehicles. These instructions should not be performed by "do-it-yourselfers." Customers should not assume this bulletin applies to their vehicle or that their vehicle will develop the described concern. To determine if the information applies, customers should contact their nearest authorized Mazda dealership. Mazda North American Operations reserves the right to alter the specifications and contents of this bulletin without obligation or advance notice. All rights reserved. No part of this bulletin may be reproduced in any form or by any means, electronic or mechanical--including photocopying and recording and the use of any kind of information storage and retrieval system ---without permission in writing.

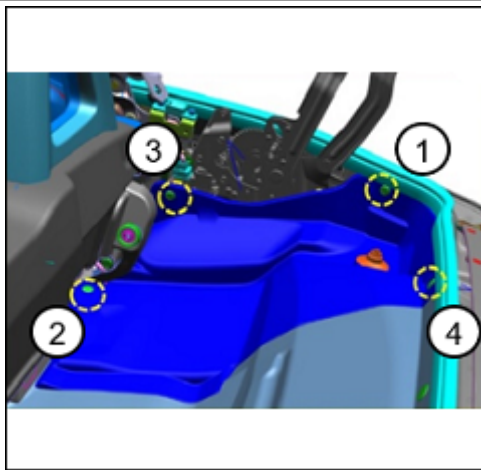

13. Attach the stopper rubber

14. Install clips on the rear side trim

15. Close the retractable hardtop

If the left or right door glass remains lowered, raise it with the power window switch.

WARRANTY INFORMATION

NOTE:

- This warranty information applies only to verified customer complaints on vehicles eligible for warranty repair.
- This repair will be covered as a one-time goodwill as the cause is considered as debris (outside influence) up to the terms of the New Vehicle Limited Warranty.
- Additional diagnostic time cannot be claimed for this repair.
- The washer fluid required for cleaning is included with the labor operation time.

Warranty Type	A
Symptom Code	77
Damage Code	93
Part Number Main Cause	7777-SP-W13
Quantity	0
Operation Number / Labor Hours:	XXW3XARX / 0.2 Hrs (Interview only) XXW3XBRX / 0.3 Hrs. (Interview + Check) XXW3XCRX / 1.2 Hrs. (Interview + Cleaning)

CONSUMER NOTICE: The information and instructions in this bulletin are intended for use by skilled technicians. Mazda technicians utilize the proper tools/ equipment and take training to correctly and safely maintain Mazda vehicles. These instructions should not be performed by "do-it-yourselfers." Customers should not assume this bulletin applies to their vehicle or that their vehicle will develop the described concern. To determine if the information applies, customers should contact their nearest authorized Mazda dealership. Mazda North American Operations reserves the right to alter the specifications and contents of this bulletin without obligation or advance notice. All rights reserved. No part of this bulletin may be reproduced in any form or by any means, electronic or mechanical---including photocopying and recording and the use of any kind of information storage and retrieval system ---without permission in writing.