

Service Alert

Mazda North American Operations
Irvine, CA 92618-2922



Subject: GEN 6 INFOTAINMENT CENTER DISPLAY REPAIR KIT (GHOST TOUCH, SPIDER CRACKING, SURFACE PEELING, WHITE DOTS)	Service Alert No.: SA-041/22
	Last Issued : 09/13/2022

BULLETIN NOTES

This bulletin supersedes the previously issued bulletin(s) listed below. The changes are noted in Red.

Previous TSBs:	Date(s) Issued:
SA-041/22	08/17/22, 06/22/22



APPLICABLE MODEL(S)/VINS

- 2016- 2017 Mazda2 (Mexico/Puerto Rico) (equipped with Center Display P/N D09H-61-1J0B or older)
- 2019-2021 Mazda2 (Mexico/Puerto Rico) with VINS lower than 3MDDJ*****409029 (produced before July 14, 2021) (equipped with Center Display P/N D23N-61-1J0B)
- 2022 Mazda2 (Mexico) with VINS lower than 3MDDJ*****452968 (produced before February 3, 2022) (equipped with Center Display P/N D23N-61-1J0B)
- 2014-2016 Mazda3
- 2016 Mazda6 (equipped with Center Display P/N GRT7-61-1J0 or GRT7-61-1J0A)
- 2017-2021 Mazda6
- 2016-2017 CX-3 (equipped with Center Display P/N D09H-61-1J0B or older)
- 2019-2022 CX-3 with VINS lower than JM1DK*****604871 (produced before April 28, 2022) (equipped with Center Display P/N D23N-61-1J0B)
- 2017-2020 CX-5 (equipped with Center Display P/N K123-61-1J0 or K123-61-1J0A)
- 2016-2017 MX-5 (equipped with Center Display P/N NA1P-61-1J0B or older)
- 2020-2022 MX-5 (equipped with Center Display P/N ND1F-61-1J0B or ND1F-61-1J0C)

CONSUMER NOTICE: The information and instructions in this bulletin are intended for use by skilled technicians. Mazda technicians utilize the proper tools/ equipment and take training to correctly and safely maintain Mazda vehicles. These instructions should not be performed by "do-it-yourselfers." Customers should not assume this bulletin applies to their vehicle or that their vehicle will develop the described concern. To determine if the information applies, customers should contact their nearest authorized Mazda dealership. Mazda North American Operations reserves the right to alter the specifications and contents of this bulletin without obligation or advance notice. All rights reserved. No part of this bulletin may be reproduced in any form or by any means, electronic or mechanical--including photocopying and recording and the use of any kind of information storage and retrieval system ---without permission in writing.

DESCRIPTION

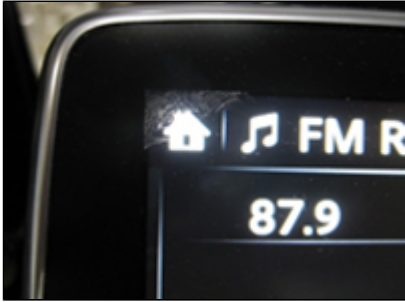
Some customers may complain about infotainment center display:

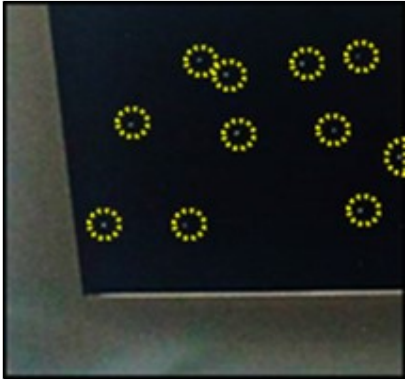
<ul style="list-style-type: none"> • Ghost Touch 	<p>(Touch screen operates by itself)</p>
<ul style="list-style-type: none"> • Spider Cracks 	
<ul style="list-style-type: none"> • Surface Peeling 	
<ul style="list-style-type: none"> • White dots 	

IMPORTANT NOTE: DO NOT replace the infotainment center display assembly. Low cost repair kits are available to repair the infotainment center display screen.

Customers having this concern should have their vehicle repaired using the following repair procedure.

CONSUMER NOTICE: The information and instructions in this bulletin are intended for use by skilled technicians. Mazda technicians utilize the proper tools/ equipment and take training to correctly and safely maintain Mazda vehicles. These instructions should not be performed by "do-it-yourselfers." Customers should not assume this bulletin applies to their vehicle or that their vehicle will develop the described concern. To determine if the information applies, customers should contact their nearest authorized Mazda dealership. Mazda North American Operations reserves the right to alter the specifications and contents of this bulletin without obligation or advance notice. All rights reserved. No part of this bulletin may be reproduced in any form or by any means, electronic or mechanical---including photocopying and recording and the use of any kind of information storage and retrieval system ---without permission in writing.

REPAIR PROCEDURE**IMPORTANT NOTE:** Repair kits will only fix the symptoms shown in the table below.**Index**

Model	Year	Symptom			
		Ghost Touch	Surface Peeling	Spider Cracking	White dots
Mazda2	2016- 2017 (Mexico/Puerto Rico)	Go to 09-036/ 22	Go to 09-036/ 22	Go to 09-036/ 22	Go to 09- 036/22
	2019-2021 (Mexico/Puerto Rico) with VINS lower than 3MDDJ*****409029 (produced before July 14, 2021)				
	2022 (Mexico) with VINS lower than 3MDDJ*****452968 (produced before February 3, 2022)				
Mazda3	2014-2016	Go to SSPB6	Go to Mazda3 Repair	Go to Mazda3 Repair	N/A
Mazda6	2016 equipped with Center Display P/N GRT7-61-1J0 or GRT7-61-1J0A	Go to TSB 09-021/22	Go toTSB 09- 021/22	Go toTSB 09- 021/22	N/A
	2017 with VINS lower than JM1GL*****156205 produced on or before December 29, 2017)				
	2017-2021 with VINS higher than JM1GL*****156205 produced after December 29, 2017)	Go to Mazda6 Repair	Go to Mazda6 Repair	Go to Mazda6 Repair	N/A
CX-3	2016-2017	Go to 09-036/ 22	Go to 09-036/ 22	Go to 09-036/ 22	Go to 09- 036/22
	2019-2022 with VINS lower than JM1DK*****604871 (produced before April 28, 2022)				
CX-5	2017-2020 with VINs lower than JM3KF*****869655 produced before August 25, 2020)	Go to TSB 09-003/22	Go to TSB 09-003/22	Go to CX-5 Repair	N/A
MX-5	2016-2017	Go to TSB 09-036/22	Go to TSB 09-036/22	Go to TSB 09- 036/22	Go to 09- 036/22
	2020-2022				

CONSUMER NOTICE: The information and instructions in this bulletin are intended for use by skilled technicians. Mazda technicians utilize the proper tools/ equipment and take training to correctly and safely maintain Mazda vehicles. These instructions should not be performed by "do-it-yourselfers." Customers should not assume this bulletin applies to their vehicle or that their vehicle will develop the described concern. To determine if the information applies, customers should contact their nearest authorized Mazda dealership. Mazda North American Operations reserves the right to alter the specifications and contents of this bulletin without obligation or advance notice. All rights reserved. No part of this bulletin may be reproduced in any form or by any means, electronic or mechanical--including photocopying and recording and the use of any kind of information storage and retrieval system ---without permission in writing.

1. Verify the customer concern.
2. Disassemble the center display and replace the lens (inner part) with a newly established part according to the following steps:
3. Print the [Parts Flash](#) table and provide to the parts counterperson.

NOTE: Wear the rubber gloves to protect the lens, cable and electronic circuit.

Repair parts set:

No.	Description	Qty.	Notes
(1)	Center Display Lens	1	Cushion materials for packaging are used to protect the lens surface when disassembled.
(2)	Rubber gloves	1	Anti-static

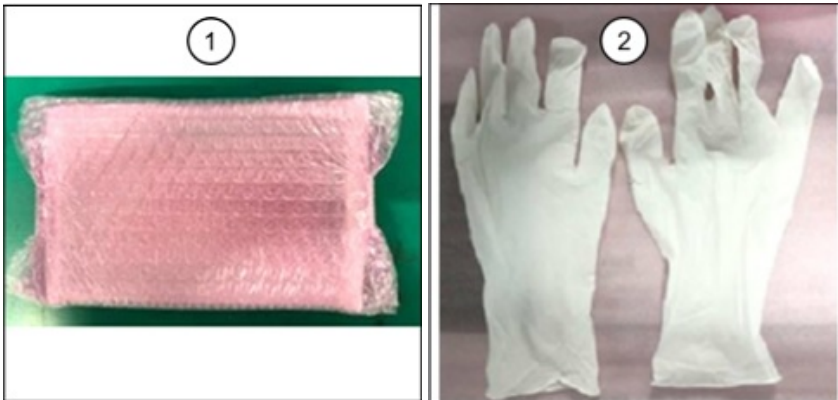

NOTE:

- Center display lens is packaged in bubble wrap and cushion material.
- Unwrap the package carefully so the cushion material can be used to protect the lens surface when disassembling the center display.
- The center display lens is equipped with cables (FPC: Flexible Printed Circuit), so be careful when handling it.

CONSUMER NOTICE: The information and instructions in this bulletin are intended for use by skilled technicians. Mazda technicians utilize the proper tools/ equipment and take training to correctly and safely maintain Mazda vehicles. These instructions should not be performed by "do-it-yourselfers." Customers should not assume this bulletin applies to their vehicle or that their vehicle will develop the described concern. To determine if the information applies, customers should contact their nearest authorized Mazda dealership. Mazda North American Operations reserves the right to alter the specifications and contents of this bulletin without obligation or advance notice. All rights reserved. No part of this bulletin may be reproduced in any form or by any means, electronic or mechanical---including photocopying and recording and the use of any kind of information storage and retrieval system ---without permission in writing.

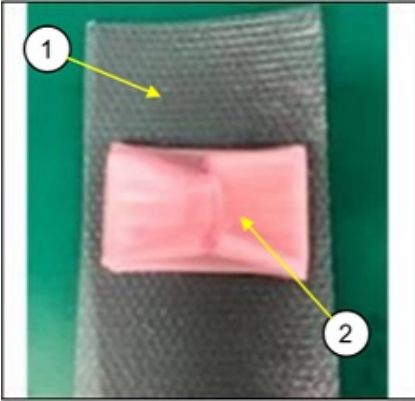

(1) Bubble wrap

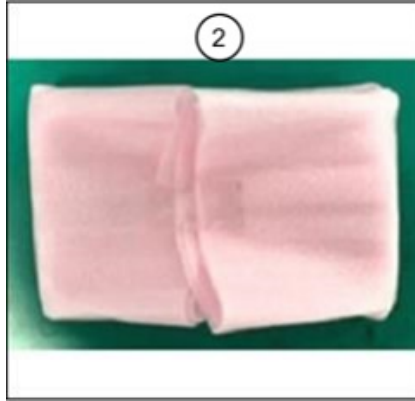

(2) Cushion material

CENTER DISPLAY DISASSEMBLY:

Remove the center display according to the instructions on MGSS:

- Mazda3 - [CENTER DISPLAY REMOVAL/INSTALLATION](#)
- Mazda6 - [CENTER DISPLAY REMOVAL/INSTALLATION](#)
- CX-5 - [CENTER DISPLAY REMOVAL/INSTALLATION](#)

CONSUMER NOTICE: The information and instructions in this bulletin are intended for use by skilled technicians. Mazda technicians utilize the proper tools/ equipment and take training to correctly and safely maintain Mazda vehicles. These instructions should not be performed by "do-it-yourselfers." Customers should not assume this bulletin applies to their vehicle or that their vehicle will develop the described concern. To determine if the information applies, customers should contact their nearest authorized Mazda dealership. Mazda North American Operations reserves the right to alter the specifications and contents of this bulletin without obligation or advance notice. All rights reserved. No part of this bulletin may be reproduced in any form or by any means, electronic or mechanical---including photocopying and recording and the use of any kind of information storage and retrieval system ---without permission in writing.

Mazda3 Repair

1. Remove the 4 screws (1), then remove the connectivity master unit (CMU) (2) from the center display (3).

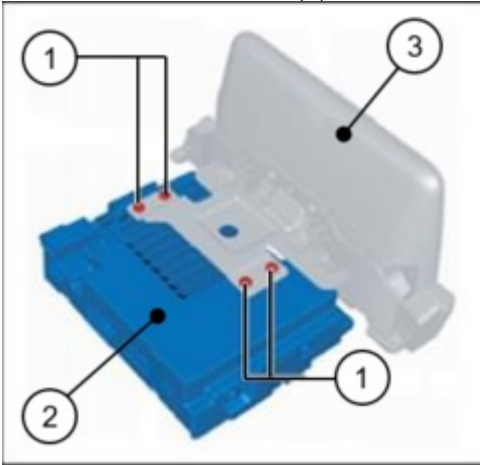

2. Place the cushion sheet (1) that wrapped lens before, on a clean, flat surface.

3. Put on the rubber gloves.

4. Place the center display (2) on the cushion sheet (1) with the display side facing downward.

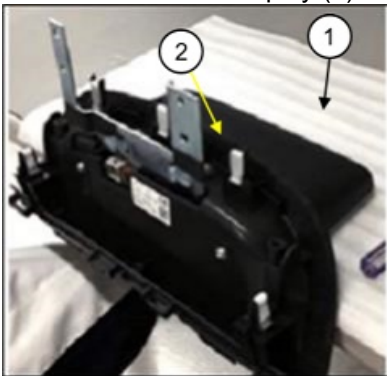

5. Remove the 4 screws from the center display cover panels.



CONSUMER NOTICE: The information and instructions in this bulletin are intended for use by skilled technicians. Mazda technicians utilize the proper tools/ equipment and take training to correctly and safely maintain Mazda vehicles. These instructions should not be performed by "do-it-yourselfers." Customers should not assume this bulletin applies to their vehicle or that their vehicle will develop the described concern. To determine if the information applies, customers should contact their nearest authorized Mazda dealership. Mazda North American Operations reserves the right to alter the specifications and contents of this bulletin without obligation or advance notice. All rights reserved. No part of this bulletin may be reproduced in any form or by any means, electronic or mechanical---including photocopying and recording and the use of any kind of information storage and retrieval system ---without permission in writing.

6. Remove the lower cover panel by pulling it up off the bracket, then lift off the back cover panel.



7. Remove the 4 screws from the bracket.

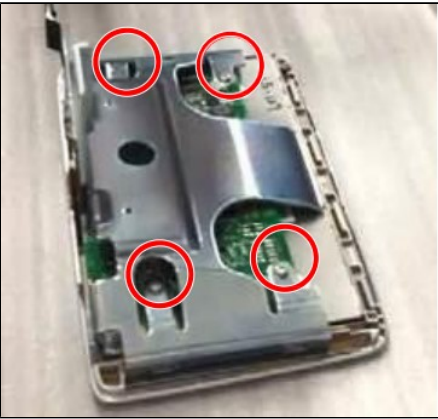

8. Unlock the bracket with a flat head screw driver by carefully prying out and upward on the bracket.

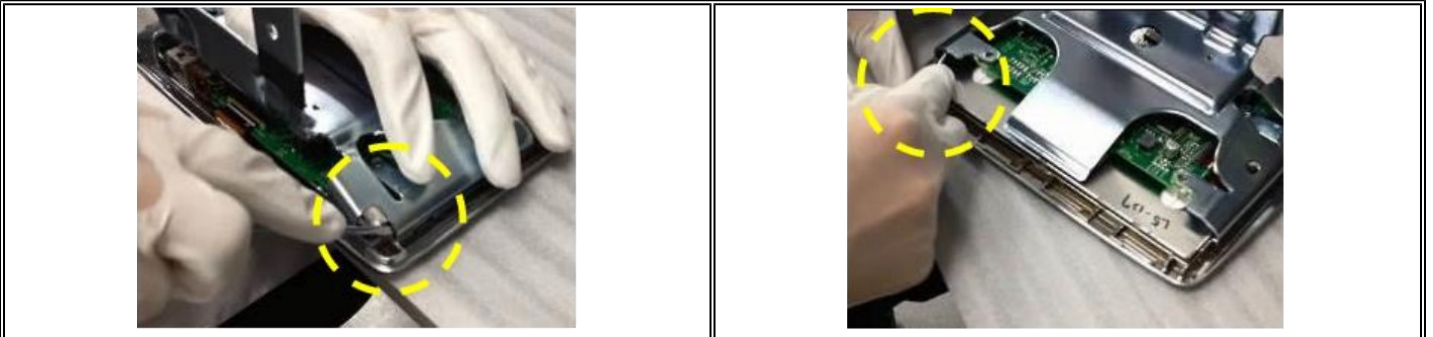

CAUTION: DO NOT pry on the printed circuit board.

CONSUMER NOTICE: The information and instructions in this bulletin are intended for use by skilled technicians. Mazda technicians utilize the proper tools/ equipment and take training to correctly and safely maintain Mazda vehicles. These instructions should not be performed by "do-it-yourselfers." Customers should not assume this bulletin applies to their vehicle or that their vehicle will develop the described concern. To determine if the information applies, customers should contact their nearest authorized Mazda dealership. Mazda North American Operations reserves the right to alter the specifications and contents of this bulletin without obligation or advance notice. All rights reserved. No part of this bulletin may be reproduced in any form or by any means, electronic or mechanical---including photocopying and recording and the use of any kind of information storage and retrieval system ---without permission in writing.

9. Remove the bracket.



10. Unlock and disconnect the printed wiring harness.

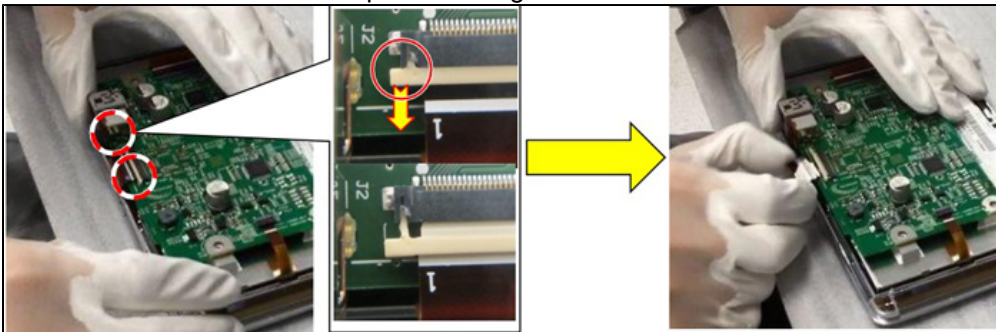

11. Remove the electric circuit board (1) from the display lens (2).

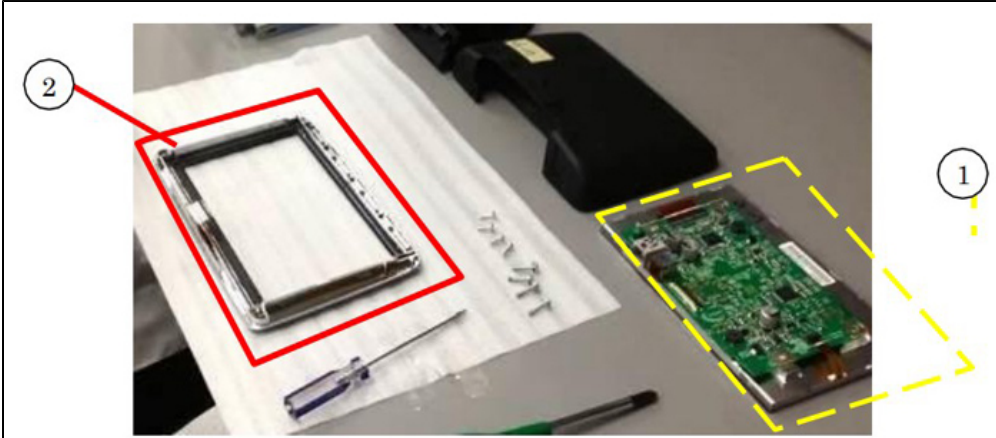

CAUTION: Be very careful handling the electric circuit board as it will be reused.

CONSUMER NOTICE: The information and instructions in this bulletin are intended for use by skilled technicians. Mazda technicians utilize the proper tools/ equipment and take training to correctly and safely maintain Mazda vehicles. These instructions should not be performed by "do-it-yourselfers." Customers should not assume this bulletin applies to their vehicle or that their vehicle will develop the described concern. To determine if the information applies, customers should contact their nearest authorized Mazda dealership. Mazda North American Operations reserves the right to alter the specifications and contents of this bulletin without obligation or advance notice. All rights reserved. No part of this bulletin may be reproduced in any form or by any means, electronic or mechanical---including photocopying and recording and the use of any kind of information storage and retrieval system ---without permission in writing.

12. Assemble the modified display lens with the removed electric circuit board.

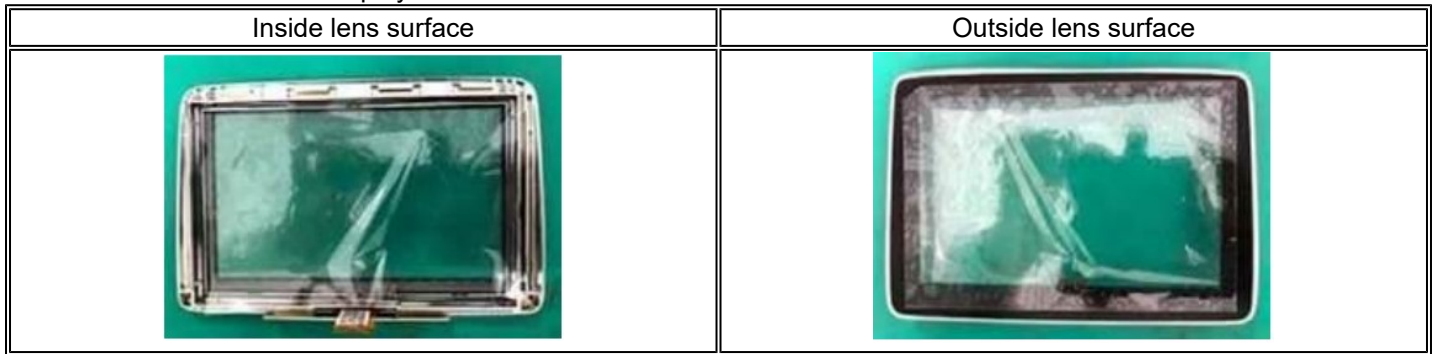

NOTE 1:

- Peel off the protection film from the inside lens surface when replacing.
- Peel off the protection film on the outside lens surface after installing the center display to the vehicle.

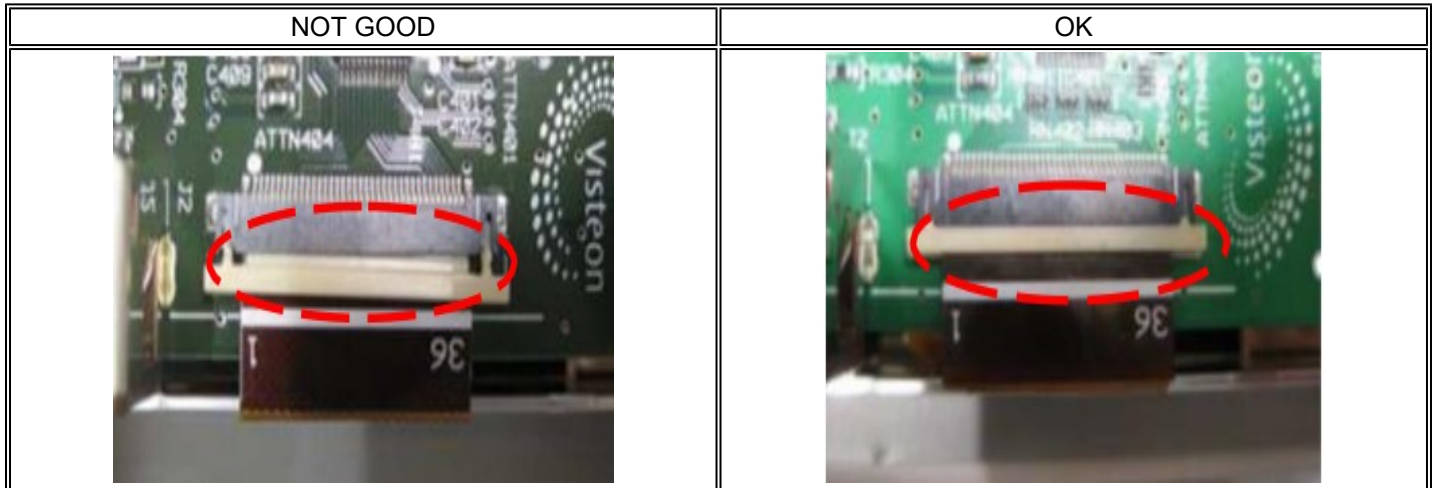

NOTE 2: Solidly connect the printed wiring harness to the connector in order to avoid the half insertion of the printed wiring harness.

13. Install the center display in the reverse order of removal.

NOTE: DO NOT tighten the screws too tightly, but tighten them so that they do not come loose.

14. Verify the repair.

CONSUMER NOTICE: The information and instructions in this bulletin are intended for use by skilled technicians. Mazda technicians utilize the proper tools/ equipment and take training to correctly and safely maintain Mazda vehicles. These instructions should not be performed by "do-it-yourselfers." Customers should not assume this bulletin applies to their vehicle or that their vehicle will develop the described concern. To determine if the information applies, customers should contact their nearest authorized Mazda dealership. Mazda North American Operations reserves the right to alter the specifications and contents of this bulletin without obligation or advance notice. All rights reserved. No part of this bulletin may be reproduced in any form or by any means, electronic or mechanical---including photocopying and recording and the use of any kind of information storage and retrieval system ---without permission in writing.

Mazda6 Repair

1. Check the Center Display Part Number (1-2).

Is the Part Number GRT7-61-1J0 or GRT7-61-1J0A?

- **Yes** - Go to next step.
- **No** - This service information does not apply. Replace the Center Display unit. Go to MGSS [CENTER DISPLAY REMOVAL/INSTALLATION](#)

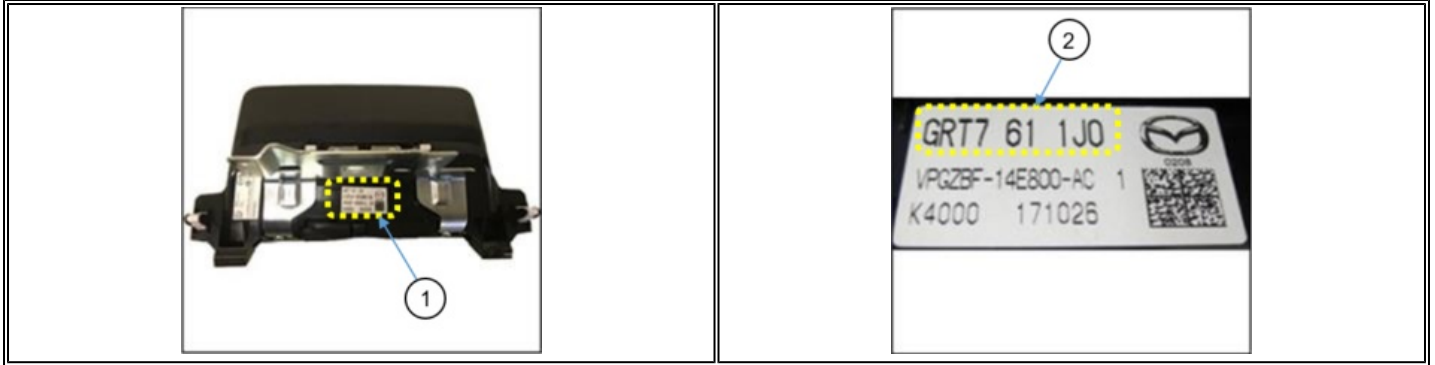

2. Remove the 4 screws (1), then remove the connectivity master unit (CMU) (2) from the center display (3).

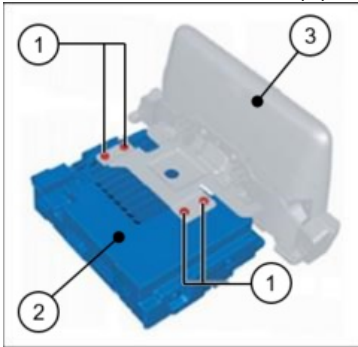

3. Place the cushion sheet (1) that the lens was wrapped on a working table.

4. Put on the rubber gloves.

5. Place the center display (2) on the cushion sheet (1) with the display side facing downward.



CONSUMER NOTICE: The information and instructions in this bulletin are intended for use by skilled technicians. Mazda technicians utilize the proper tools/ equipment and take training to correctly and safely maintain Mazda vehicles. These instructions should not be performed by "do-it-yourselfers." Customers should not assume this bulletin applies to their vehicle or that their vehicle will develop the described concern. To determine if the information applies, customers should contact their nearest authorized Mazda dealership. Mazda North American Operations reserves the right to alter the specifications and contents of this bulletin without obligation or advance notice. All rights reserved. No part of this bulletin may be reproduced in any form or by any means, electronic or mechanical---including photocopying and recording and the use of any kind of information storage and retrieval system ---without permission in writing.

6. Remove the 4 screws (1) that assemble the center display (2) and the bracket (3), then separate the bracket (3) and the cover panel (4).

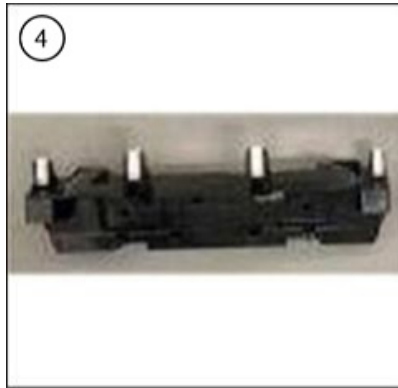
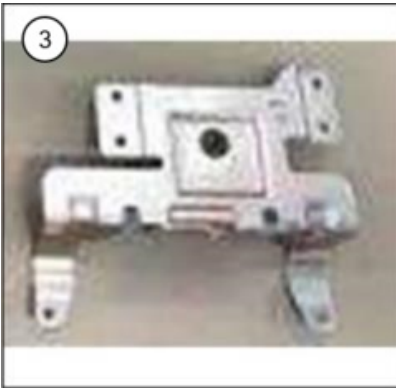
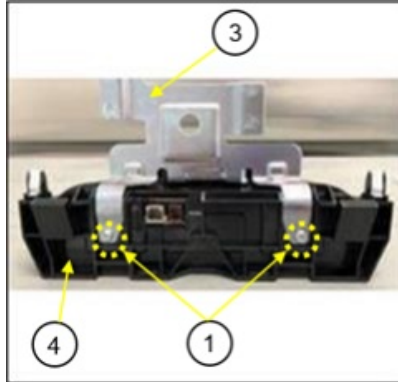
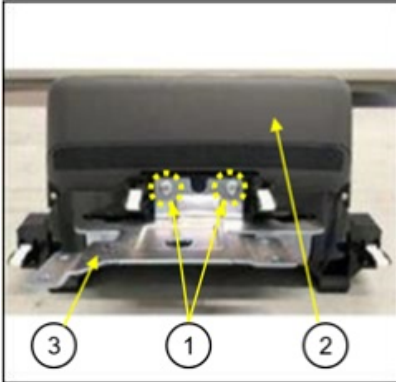

7. Remove the 2 screws (1) on the back of the center display.

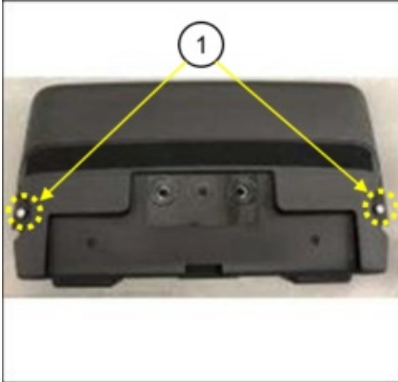

CONSUMER NOTICE: The information and instructions in this bulletin are intended for use by skilled technicians. Mazda technicians utilize the proper tools/ equipment and take training to correctly and safely maintain Mazda vehicles. These instructions should not be performed by "do-it-yourselfers." Customers should not assume this bulletin applies to their vehicle or that their vehicle will develop the described concern. To determine if the information applies, customers should contact their nearest authorized Mazda dealership. Mazda North American Operations reserves the right to alter the specifications and contents of this bulletin without obligation or advance notice. All rights reserved. No part of this bulletin may be reproduced in any form or by any means, electronic or mechanical---including photocopying and recording and the use of any kind of information storage and retrieval system ---without permission in writing.

8. Insert a tip of a flathead screwdriver (3) in the gap (2) between the lens and the rear cover.

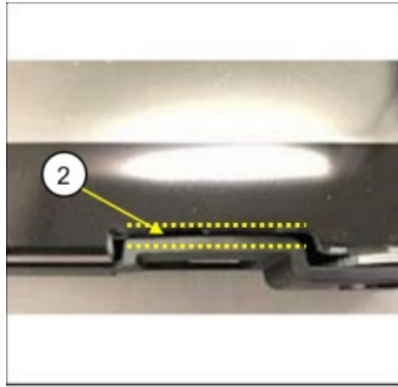

Detail of (1)

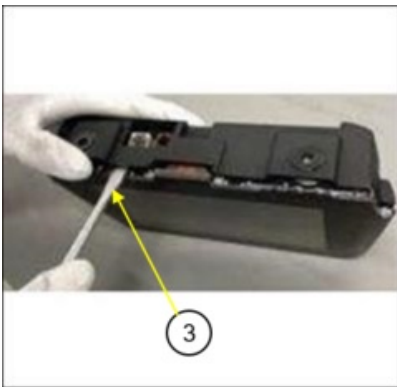

CONSUMER NOTICE: The information and instructions in this bulletin are intended for use by skilled technicians. Mazda technicians utilize the proper tools/ equipment and take training to correctly and safely maintain Mazda vehicles. These instructions should not be performed by "do-it-yourselfers." Customers should not assume this bulletin applies to their vehicle or that their vehicle will develop the described concern. To determine if the information applies, customers should contact their nearest authorized Mazda dealership. Mazda North American Operations reserves the right to alter the specifications and contents of this bulletin without obligation or advance notice. All rights reserved. No part of this bulletin may be reproduced in any form or by any means, electronic or mechanical---including photocopying and recording and the use of any kind of information storage and retrieval system ---without permission in writing.

9. Pull up the rear cover with a flathead screwdriver (1) while being careful to not touch the connector, then remove the rear cover.

CAUTION: Be careful not to damage the circuit board and the connectors when removing the rear cover.

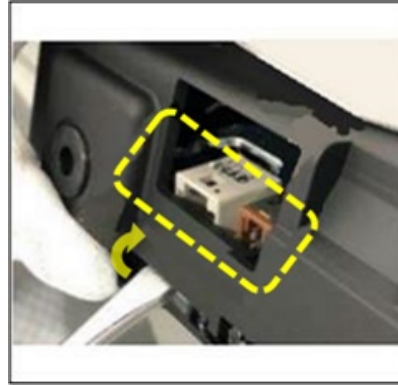
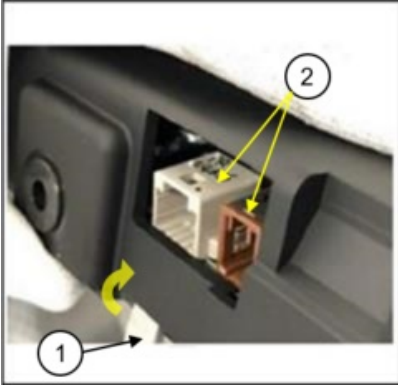

Pull the rear cover outward so that the cover does not touch the connectors.

Center display (joint with rear cover)

Rear cover (joint with center display)



CONSUMER NOTICE: The information and instructions in this bulletin are intended for use by skilled technicians. Mazda technicians utilize the proper tools/ equipment and take training to correctly and safely maintain Mazda vehicles. These instructions should not be performed by "do-it-yourselfers." Customers should not assume this bulletin applies to their vehicle or that their vehicle will develop the described concern. To determine if the information applies, customers should contact their nearest authorized Mazda dealership. Mazda North American Operations reserves the right to alter the specifications and contents of this bulletin without obligation or advance notice. All rights reserved. No part of this bulletin may be reproduced in any form or by any means, electronic or mechanical---including photocopying and recording and the use of any kind of information storage and retrieval system ---without permission in writing.

10. Remove the 4 screws (circled in yellow).



11. Push the locking tab (2) on the connector (1) to unlock it while pushing the circuit board, then remove the cable (FPC: Flexible Printed Circuit) (3).

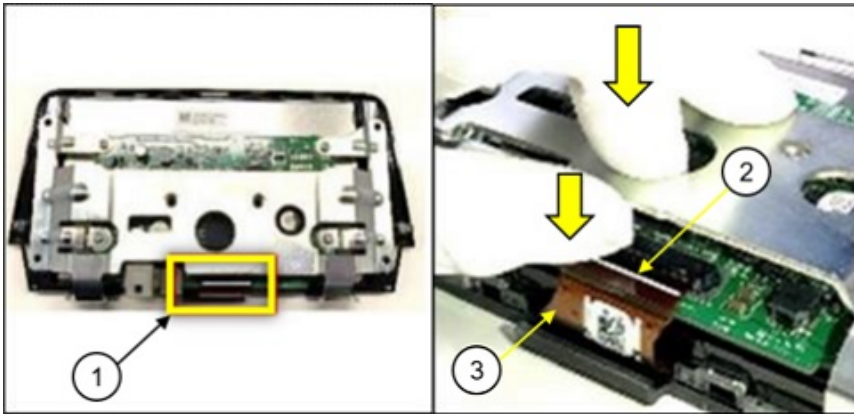

CONSUMER NOTICE: The information and instructions in this bulletin are intended for use by skilled technicians. Mazda technicians utilize the proper tools/ equipment and take training to correctly and safely maintain Mazda vehicles. These instructions should not be performed by "do-it-yourselfers." Customers should not assume this bulletin applies to their vehicle or that their vehicle will develop the described concern. To determine if the information applies, customers should contact their nearest authorized Mazda dealership. Mazda North American Operations reserves the right to alter the specifications and contents of this bulletin without obligation or advance notice. All rights reserved. No part of this bulletin may be reproduced in any form or by any means, electronic or mechanical---including photocopying and recording and the use of any kind of information storage and retrieval system ---without permission in writing.

NOTE: Pull out the cable by holding both side-edges of it to avoid damaging the cable.



12. Remove the center display from the lens.

13. Replace the lens with a modified one, reusing the center display

Replace the lens with a modified one.



Reuse the center display.



14. Assemble the center display in the reverse order of disassemble.

NOTE:

- DO NOT tighten the screws too tightly, but tighten them so that they do not come loose.
- When attaching the cable to the circuit board, be careful not to engage with the connector half-fit.

15. Install the center display in the reverse order of removal.

16. Verify the repair.

CONSUMER NOTICE: The information and instructions in this bulletin are intended for use by skilled technicians. Mazda technicians utilize the proper tools/ equipment and take training to correctly and safely maintain Mazda vehicles. These instructions should not be performed by "do-it-yourselfers." Customers should not assume this bulletin applies to their vehicle or that their vehicle will develop the described concern. To determine if the information applies, customers should contact their nearest authorized Mazda dealership. Mazda North American Operations reserves the right to alter the specifications and contents of this bulletin without obligation or advance notice. All rights reserved. No part of this bulletin may be reproduced in any form or by any means, electronic or mechanical---including photocopying and recording and the use of any kind of information storage and retrieval system ---without permission in writing.

CX-5 Repair

1. Check the Center Display Part Number (1-2).

Is the Part Number K123-61-1J0 or K123-61-1J0A?

- **Yes** - Go to next step.
- **No** - This service information does not apply. Replace the Center Display unit. Go to MGSS [CENTER DISPLAY REMOVAL/INSTALLATION](#)

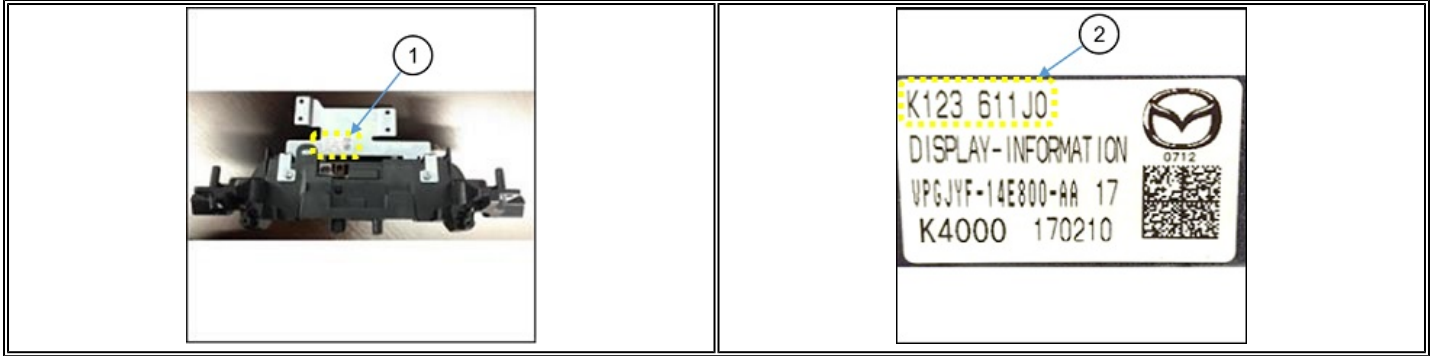

2. Remove the 4 four screws (1), then remove the connectivity master unit (CMU) (2) from the center display (3).

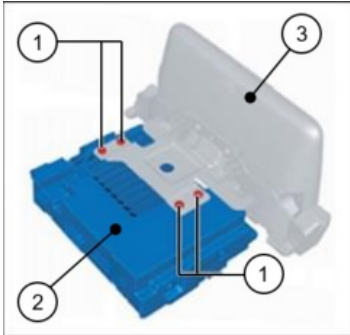

3. Place the cushion material (1) that the lens was wrapped in, on a workbench.

4. Put on the rubber gloves.

5. Place the center display (2) on the cushion material (1) with the display side facing downward.

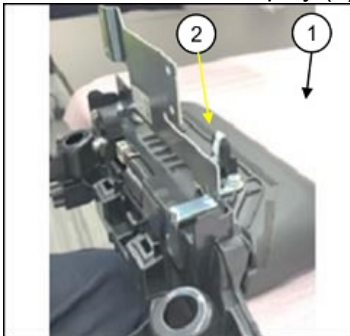

CONSUMER NOTICE: The information and instructions in this bulletin are intended for use by skilled technicians. Mazda technicians utilize the proper tools/ equipment and take training to correctly and safely maintain Mazda vehicles. These instructions should not be performed by "do-it-yourselfers." Customers should not assume this bulletin applies to their vehicle or that their vehicle will develop the described concern. To determine if the information applies, customers should contact their nearest authorized Mazda dealership. Mazda North American Operations reserves the right to alter the specifications and contents of this bulletin without obligation or advance notice. All rights reserved. No part of this bulletin may be reproduced in any form or by any means, electronic or mechanical--including photocopying and recording and the use of any kind of information storage and retrieval system ---without permission in writing.

6. Remove the 4 screws (1) that assemble the center display (2) and the bracket (3), then separate the bracket (3) and the cover panel (4).

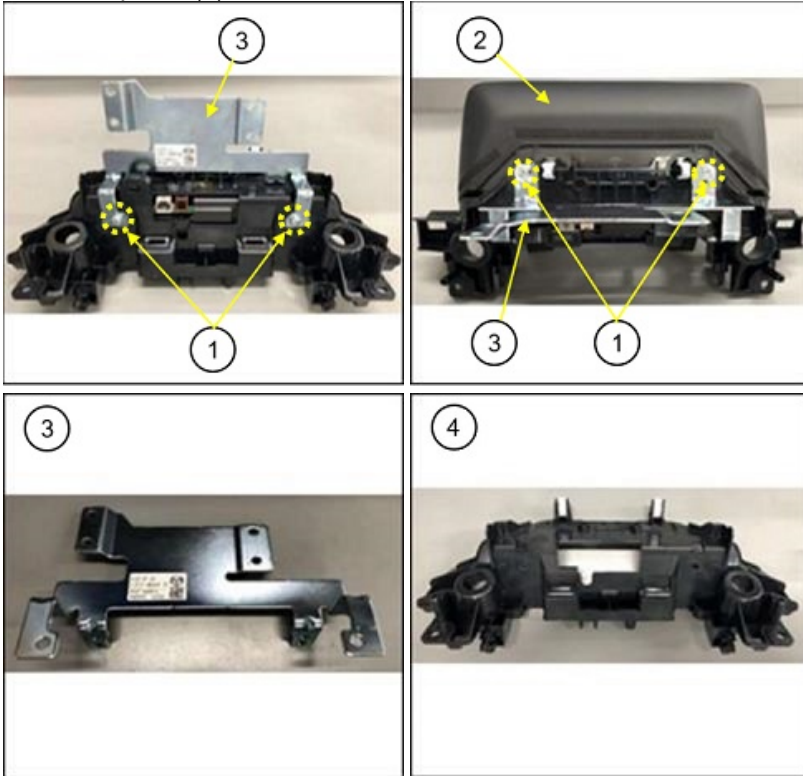

7. Remove the 2 screws (1) that assemble the center display and the rear cover (2).

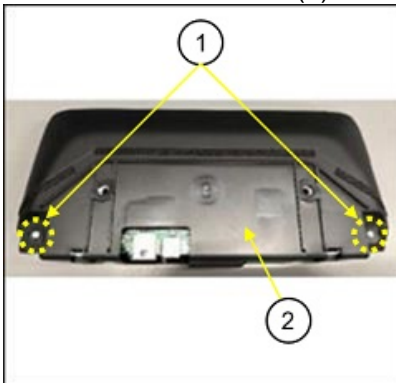

CONSUMER NOTICE: The information and instructions in this bulletin are intended for use by skilled technicians. Mazda technicians utilize the proper tools/ equipment and take training to correctly and safely maintain Mazda vehicles. These instructions should not be performed by "do-it-yourselfers." Customers should not assume this bulletin applies to their vehicle or that their vehicle will develop the described concern. To determine if the information applies, customers should contact their nearest authorized Mazda dealership. Mazda North American Operations reserves the right to alter the specifications and contents of this bulletin without obligation or advance notice. All rights reserved. No part of this bulletin may be reproduced in any form or by any means, electronic or mechanical---including photocopying and recording and the use of any kind of information storage and retrieval system ---without permission in writing.

8. Remove the rear cover according to the following steps.

- There are 3 fitting sections of the rear cover and the center display.
- The number in the image below is the order in which to unhook the ribs.

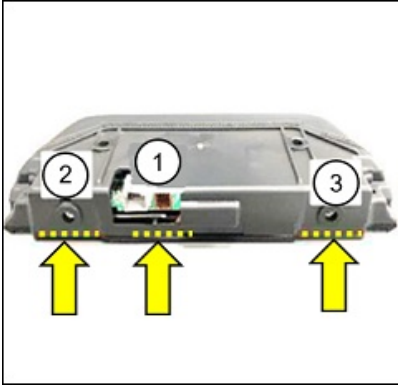

Rear cover



Center display



CONSUMER NOTICE: The information and instructions in this bulletin are intended for use by skilled technicians. Mazda technicians utilize the proper tools/ equipment and take training to correctly and safely maintain Mazda vehicles. These instructions should not be performed by "do-it-yourselfers." Customers should not assume this bulletin applies to their vehicle or that their vehicle will develop the described concern. To determine if the information applies, customers should contact their nearest authorized Mazda dealership. Mazda North American Operations reserves the right to alter the specifications and contents of this bulletin without obligation or advance notice. All rights reserved. No part of this bulletin may be reproduced in any form or by any means, electronic or mechanical---including photocopying and recording and the use of any kind of information storage and retrieval system ---without permission in writing.

a. Unhook rib (1) by inserting the tip of a flathead screwdriver in the gap (2) between the lens and the rear cover below connectors (4), then unhooking the rib (3).

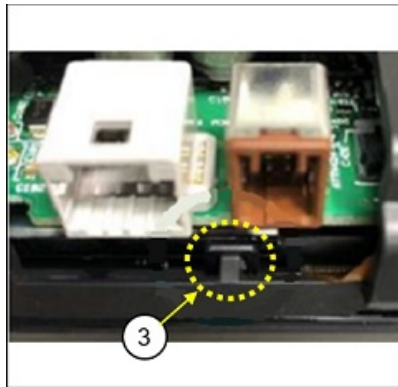
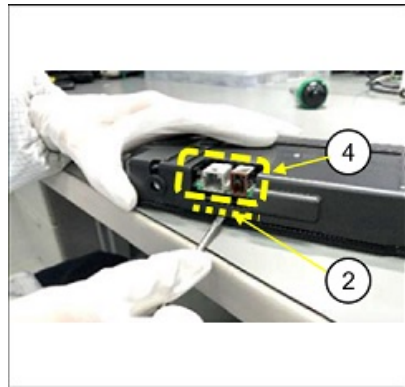
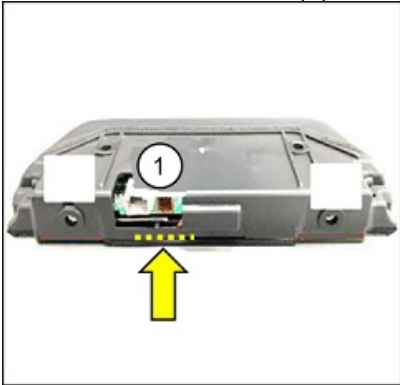

Rib (3) of the rear cover

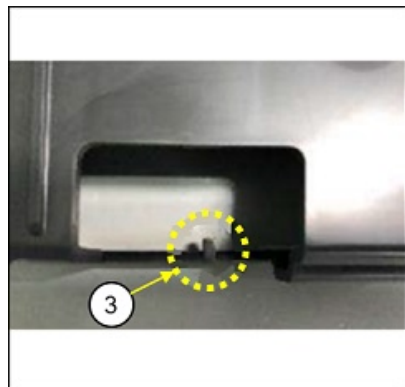

Rib (3) of the rear cover

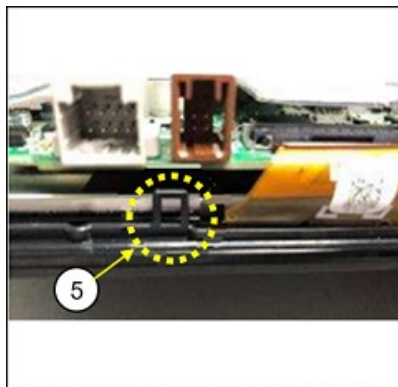

Hook (5) of the center display

CONSUMER NOTICE: The information and instructions in this bulletin are intended for use by skilled technicians. Mazda technicians utilize the proper tools/ equipment and take training to correctly and safely maintain Mazda vehicles. These instructions should not be performed by "do-it-yourselfers." Customers should not assume this bulletin applies to their vehicle or that their vehicle will develop the described concern. To determine if the information applies, customers should contact their nearest authorized Mazda dealership. Mazda North American Operations reserves the right to alter the specifications and contents of this bulletin without obligation or advance notice. All rights reserved. No part of this bulletin may be reproduced in any form or by any means, electronic or mechanical---including photocopying and recording and the use of any kind of information storage and retrieval system ---without permission in writing.

b. Unhook rib (2) by inserting the tip of a flathead screwdriver in the gap (2) between the lens and the rear cover, then unhooking the rib.

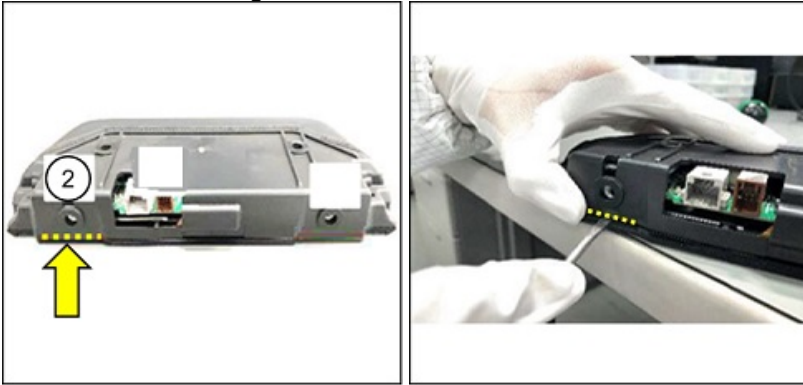

c. Unhook rib (3) by inserting the tip of a flathead screwdriver in the gap (3) between the lens and the rear cover, then unhooking the rib.

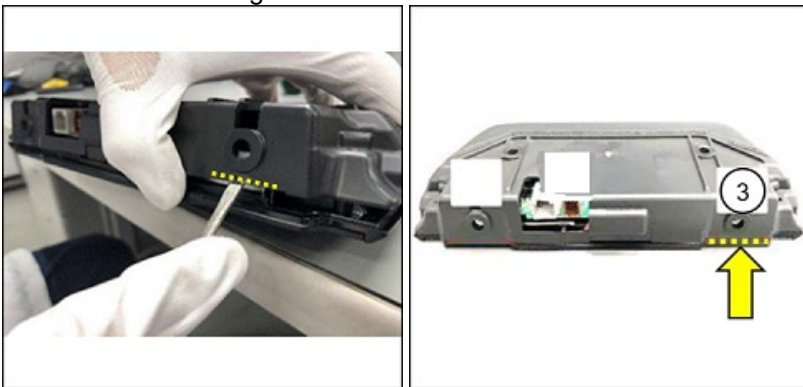

CONSUMER NOTICE: The information and instructions in this bulletin are intended for use by skilled technicians. Mazda technicians utilize the proper tools/ equipment and take training to correctly and safely maintain Mazda vehicles. These instructions should not be performed by "do-it-yourselfers." Customers should not assume this bulletin applies to their vehicle or that their vehicle will develop the described concern. To determine if the information applies, customers should contact their nearest authorized Mazda dealership. Mazda North American Operations reserves the right to alter the specifications and contents of this bulletin without obligation or advance notice. All rights reserved. No part of this bulletin may be reproduced in any form or by any means, electronic or mechanical---including photocopying and recording and the use of any kind of information storage and retrieval system ---without permission in writing.

9. Pull up the rear cover (1) carefully so that the rib (3) does not touch the connectors (2), then remove the rear cover.

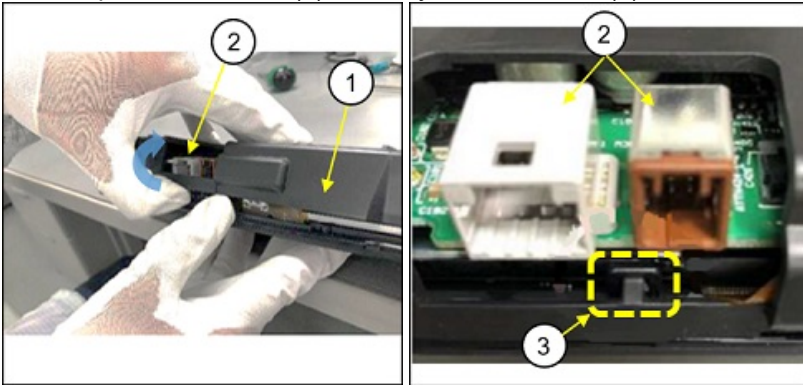

Rear cover



Center display



CONSUMER NOTICE: The information and instructions in this bulletin are intended for use by skilled technicians. Mazda technicians utilize the proper tools/ equipment and take training to correctly and safely maintain Mazda vehicles. These instructions should not be performed by "do-it-yourselfers." Customers should not assume this bulletin applies to their vehicle or that their vehicle will develop the described concern. To determine if the information applies, customers should contact their nearest authorized Mazda dealership. Mazda North American Operations reserves the right to alter the specifications and contents of this bulletin without obligation or advance notice. All rights reserved. No part of this bulletin may be reproduced in any form or by any means, electronic or mechanical---including photocopying and recording and the use of any kind of information storage and retrieval system ---without permission in writing.

10. Remove the 4 screws shown below.



Bracket



Center display



11. Remove the cable (FPC: Flexible Printed Circuit) in order (1), (2), (3) as shown in the image below.

NOTE: To unlock the connector, pull up the locking tab while holding the circuit board.

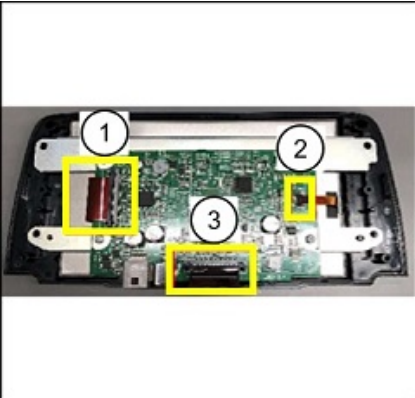

CONSUMER NOTICE: The information and instructions in this bulletin are intended for use by skilled technicians. Mazda technicians utilize the proper tools/ equipment and take training to correctly and safely maintain Mazda vehicles. These instructions should not be performed by "do-it-yourselfers." Customers should not assume this bulletin applies to their vehicle or that their vehicle will develop the described concern. To determine if the information applies, customers should contact their nearest authorized Mazda dealership. Mazda North American Operations reserves the right to alter the specifications and contents of this bulletin without obligation or advance notice. All rights reserved. No part of this bulletin may be reproduced in any form or by any means, electronic or mechanical---including photocopying and recording and the use of any kind of information storage and retrieval system ---without permission in writing.

ATTENTION: Pull out the cable by holding both side-edges to avoid damaging the cable.



Locked

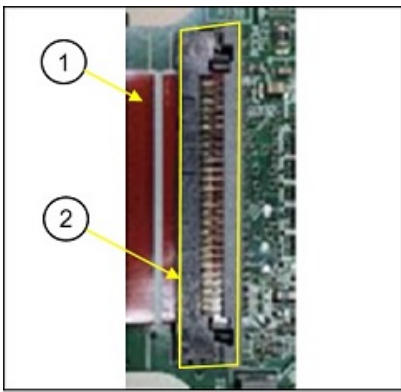

Unlocked

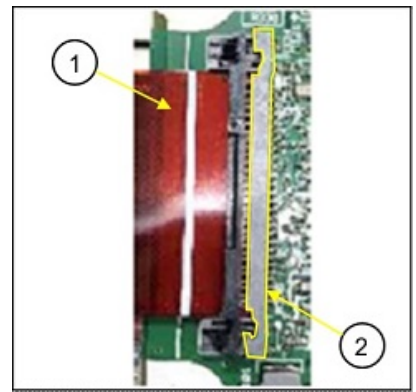

- (1) Cable
- (2) Locking tab

12. Remove the center display from the lens.

13. Replace the lens with a modified one, but reuse the center display

Lens



Center display

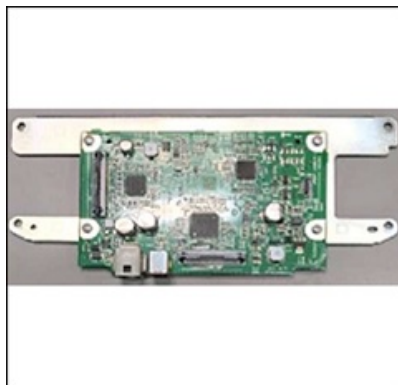

CONSUMER NOTICE: The information and instructions in this bulletin are intended for use by skilled technicians. Mazda technicians utilize the proper tools/ equipment and take training to correctly and safely maintain Mazda vehicles. These instructions should not be performed by "do-it-yourselfers." Customers should not assume this bulletin applies to their vehicle or that their vehicle will develop the described concern. To determine if the information applies, customers should contact their nearest authorized Mazda dealership. Mazda North American Operations reserves the right to alter the specifications and contents of this bulletin without obligation or advance notice. All rights reserved. No part of this bulletin may be reproduced in any form or by any means, electronic or mechanical---including photocopying and recording and the use of any kind of information storage and retrieval system ---without permission in writing.

14. Assemble the center display in the reverse order of disassembly.

NOTE:

- When attaching the cable to the circuit board, be sure the connection is secure.
- DO NOT use electric tools to tighten the screws. Overtightening the screws (circled in yellow in the following figures) may cause uneven brightness of the display. If uneven brightness occurs, loosen the screws and retighten them to the point to avoid coming loose.

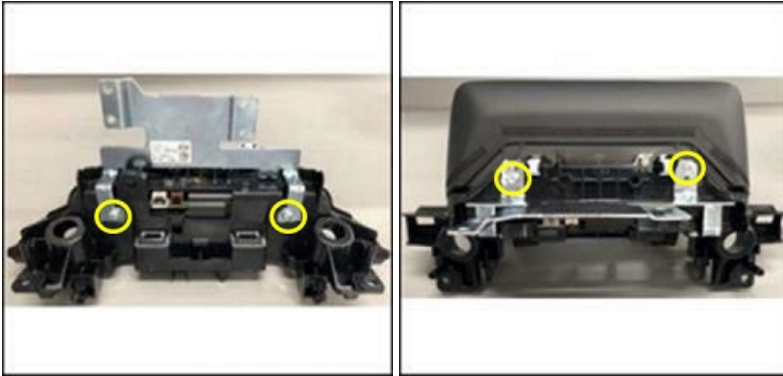

Example of the uneven brightness:

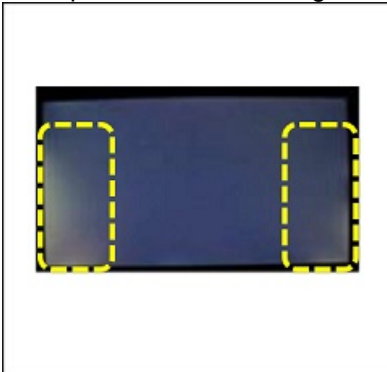

CONSUMER NOTICE: The information and instructions in this bulletin are intended for use by skilled technicians. Mazda technicians utilize the proper tools/ equipment and take training to correctly and safely maintain Mazda vehicles. These instructions should not be performed by "do-it-yourselfers." Customers should not assume this bulletin applies to their vehicle or that their vehicle will develop the described concern. To determine if the information applies, customers should contact their nearest authorized Mazda dealership. Mazda North American Operations reserves the right to alter the specifications and contents of this bulletin without obligation or advance notice. All rights reserved. No part of this bulletin may be reproduced in any form or by any means, electronic or mechanical---including photocopying and recording and the use of any kind of information storage and retrieval system ---without permission in writing.

15. Install the center display in the reverse order of removal.
16. Verify the repair.

PARTS INFORMATION

Year	Model	Parts Number	Description	Qty.	Note Check Vehicle Infotainment Center Display Part Label
2016-2017	Mazda2 (Mexico/Puerto Rico)	D0YP-61-1JZ	Center Display Lens Kit	1	Kit repairs P/N D09H-61-1J0B or older
2019-2021	Mazda2 (Mexico/Puerto Rico) with VINS lower than 3MDDJ*****409029 (produced before July 14, 2021)	D2YN-61-1JZA	Center Display Lens Kit	1	Kit repairs P/N D23N-61-1J0B only
2022	Mazda2 (Mexico) with VINS lower than 3MDDJ*****452968 (produced before February 3, 2022)				
2014-2016	Mazda3	BHY1-61-1JZ	Center Display Lens Kit	1	---
2016	Mazda6	GRY7-61-1JZ	Center Display Lens Kit	1	Kit repairs P/N GRT7-61-1J0 or GRT7-61-1J0A only Vehicles equipped with center display P/N GML8-611J0 do not apply to this service information.
2017-2021	Mazda6	GRY7-61-1JZ	Center Display Lens Kit	1	---
2016-2017	CX-3	D0YP-61-1JZ	Center Display Lens Kit	1	Kit repairs P/N D09H-61-1J0B or older
2019-2022	CX-3	D2YN-61-1JZA	Center Display Lens Kit	1	Kit repairs P/N D23N-61-1J0B only
2017-2020	CX-5	K1Y3-61-1JZ	Center Display Lens Kit	1	Kit repairs P/N K123-61-1J0 or K123-61-1J0A only Vehicles equipped with center display P/N K123-61-1J0B or later suffix are already modified and do not apply to

CONSUMER NOTICE: The information and instructions in this bulletin are intended for use by skilled technicians. Mazda technicians utilize the proper tools/ equipment and take training to correctly and safely maintain Mazda vehicles. These instructions should not be performed by "do-it-yourselfers." Customers should not assume this bulletin applies to their vehicle or that their vehicle will develop the described concern. To determine if the information applies, customers should contact their nearest authorized Mazda dealership. Mazda North American Operations reserves the right to alter the specifications and contents of this bulletin without obligation or advance notice. All rights reserved. No part of this bulletin may be reproduced in any form or by any means, electronic or mechanical--including photocopying and recording and the use of any kind of information storage and retrieval system ---without permission in writing.

					this service information.
2016-2017	MX-5	D0YP-61-1JZ	Center Display Lens Kit	1	Kit repairs P/N NA1P-61-1J0B or older
2020-2022	MX-5	D2YN-61-1JZA	Center Display Lens Kit	1	Kit repairs P/N ND1F-61-1J0B or ND1F-61-1J0C only

CONSUMER NOTICE: The information and instructions in this bulletin are intended for use by skilled technicians. Mazda technicians utilize the proper tools/ equipment and take training to correctly and safely maintain Mazda vehicles. These instructions should not be performed by "do-it-yourselfers." Customers should not assume this bulletin applies to their vehicle or that their vehicle will develop the described concern. To determine if the information applies, customers should contact their nearest authorized Mazda dealership. Mazda North American Operations reserves the right to alter the specifications and contents of this bulletin without obligation or advance notice. All rights reserved. No part of this bulletin may be reproduced in any form or by any means, electronic or mechanical---including photocopying and recording and the use of any kind of information storage and retrieval system ---without permission in writing.