

**Sports Exhaust System - Silver (OP8)/Black (OP9)**

Revision: This bulletin replaces bulletin Group 2 8/20, dated August 16, 2021.

Model Year: **As of 2019**

Vehicle Type: **Cayenne S (9YA) / Cayenne S Coupé (9YB)** including respective **Platinum Edition** variants

Engine Type: **DCA/DCAB** = V6/2.9 liter/324 kW (440 hp) = Cayenne S

Restrictions: **ONLY** approved for vehicles FROM a certain production date (week/year) (depending on exhaust variant (WITHOUT Petrol Particulate Filter (PPF) and body shape)!

- Vehicles **WITHOUT** PPF: from 34 / 2018
- Coupé vehicles: from 28 / 2019

Information: **Retrofitting**

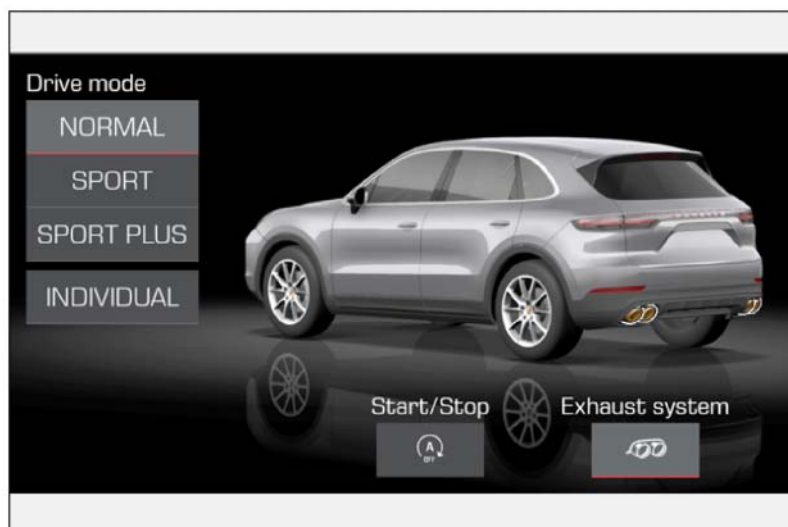

Figure 1

Notes: With the sports exhaust system, the signal for activating the flaps in the rear silencers comes from the respective current map in the DME control unit. The driving status and accelerator pedal position, for example, are decisive factors.

The sports exhaust system can be switched on and off separately using the Porsche Communication Management system (PCM ⇒ Figure 1). To do this, select the menu "Car", then "Drive" and then "Exhaust system".

The sports exhaust system is also active in the "SPORT" or "SPORT PLUS" driving modes.

The engine power and exhaust behavior of the vehicle are not affected.

The sports exhaust system is also available straight from the factory for new vehicles by requesting optional equipment "OP8 – Sports exhaust system (Brushed stainless steel tailpipe)" or "OP9 – Sports exhaust system (Black chrome-plated look tailpipe)".

Parts Info:	<b>9Y0.044.220</b>	⇒ Sports exhaust system – Tailpipe in Silver chrome-plated look, set
	<b>9Y0.044.220.A</b>	⇒ Sports exhaust system – Tailpipe in Black chrome-plated look, set

Parts list:

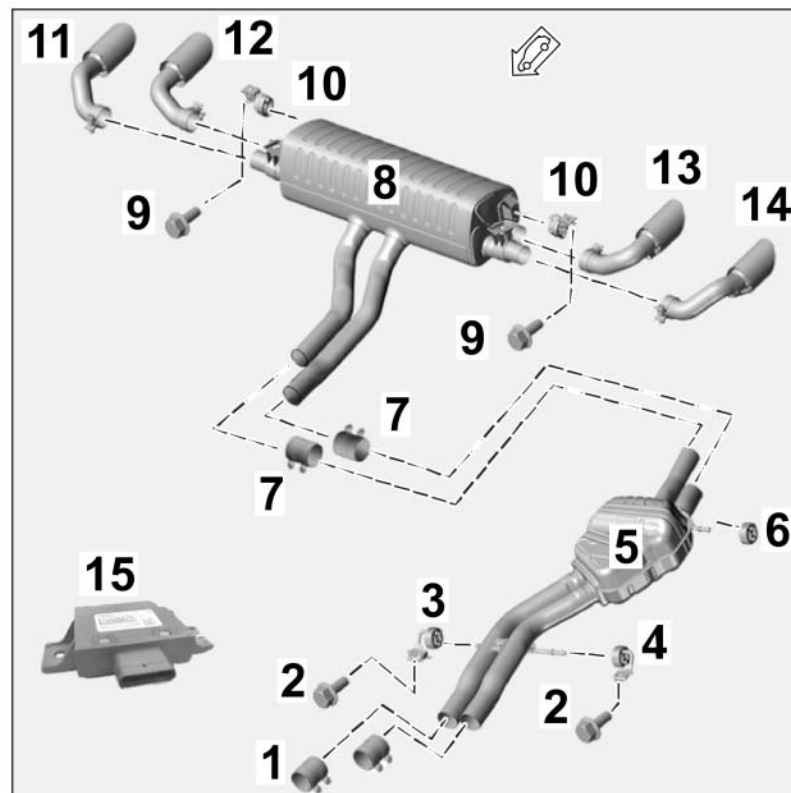

Figure 2

Exhaust system components (area: Center and rear) and electrics (⇒ Figure 2):

958.111.220.10	2 x	Clamping sleeve, Ø 65 x 88 ⇒ Figure 2-1-
N .106.978.01	2 x	Hexagon flange bolt, M10 x 30 ⇒ Figure 2-2-
PAB.253.144.01	1 x	Holder for center silencer, front right ⇒ Figure 2-3-
PAB.253.144.10	1 x	Holder for center silencer, front, left ⇒ Figure 2-4-
9Y0.253.088.C	1 x	Center silencer ASSY ⇒ Figure 2-5-
PAB.253.147.00	1 x	Center silencer retaining ring, rear left ⇒ Figure 2-6-

958.111.220.10	2 x	Clamping sleeve, Ø 65 x 88 ⇒ <i>Figure 2-7-</i>
9Y0.253.125.A	1 x	Rear silencer assembly ⇒ <i>Figure 2-8-</i>
N .106.421.01	2 x	Hexagon flange bolt, M8 x 25 ⇒ <i>Figure 2-9-</i>
PAB.253.144.03	2 x	Rear silencer holder ⇒ <i>Figure 2-10-</i>
N .038.549.4	8 x	Expansion rivet, A8 x 12 (air guide for tunnel, underbody panelling, not shown)
9Y0.253.824.BP <sup>1</sup>	1 x	Sports tailpipe, silver chrome-plated, outer right ⇒ <i>Figure 2-11-</i>
9Y0.253.824.BN <sup>1</sup>	1 x	Sports tailpipe, silver chrome-plated, inner right ⇒ <i>Figure 2-12-</i>
9Y0.253.823.BN <sup>1</sup>	1 x	Sports tailpipe, silver chrome-plated, inner left ⇒ <i>Figure 2-13-</i>
9Y0.253.823.BP <sup>1</sup>	1 x	Sports tailpipe, silver chrome-plated, outer left ⇒ <i>Figure 2-14-</i>
9Y0.253.824.BS <sup>1</sup>	1 x	Sports tailpipe, black chrome-plated, outer right (not shown)
9Y0.253.824.BR <sup>1</sup>	1 x	Sports tailpipe, black chrome-plated, inner right (not shown)
9Y0.253.823.BR <sup>1</sup>	1 x	Sports tailpipe, black chrome-plated, inner left (not shown)
9Y0.253.823.BS <sup>1</sup>	1 x	Sports tailpipe, black chrome-plated, outer left (not shown)
9Y0.907.159.AS	1 x	Engine noise control unit ⇒ <i>Figure 2-15-</i>

<sup>1</sup> **ONLY** contained in respective set!



Figure 3

Scope of electrical system – exhaust flaps and interior mechanism area (⇒ *Figure 3*):

9Y0.044.210.A	1 x	Wire harness assembly for exhaust flaps ⇒ <i>Figure 3-1-</i>
— — — <sup>2</sup>	1 x	Grommet (internal Ø 66.5 – left side) ⇒ <i>Figure 3-2-</i>
— — — <sup>2</sup>	1 x	Grommet (internal Ø 46 – right side) ⇒ <i>Figure 3-3-</i>
— — — <sup>2</sup>	1 x	Corrugated hose, 4.5 x 7.6 x 220 ⇒ <i>Figure 3-4-</i>
— — — <sup>2</sup>	1 x	Corrugated hose, 4.5 x 7.6 x 230 (not shown)
— — — <sup>2</sup>	2 x	Plug socket (4-pin) ⇒ <i>Figure 3-5-</i>
— — — <sup>2</sup>	2 x	15 A fuse (not shown)
N .020.902.2	20 x	Tie-wrap, 3.6 x 246 (not shown)
999.513.052.40	10 x	Tie-wrap, 4.8 x 188 (not shown)
PAB.886.373	5 x	Fixing clip for seat cushion ⇒ <i>Figure 3-6-</i>
N .912.052.01	8 x	Cheese head bolt with multiple-tooth internal M10 x 35 (front and rear seat) ⇒ <i>Figure 3-7-</i>
PAF.912.664	4 x	Hexagon flange bolt, M12 x 1.5 x 40 (rear seat) ⇒ <i>Figure 3-8-</i>

<sup>2</sup> Contained in the "Wire harness assembly for exhaust flaps (9Y0.044.210.A)" set!



### Information

**ONLY** in the event of repairs/replacement:

Items **WITHOUT** a part number in the parts list can be found/ordered from the Porsche Electronic Parts Catalog = PET.

Check model year and vehicle equipment (I-no.) in the standard catalog!

Materials:	000.043.172.00	1 x	Sealing cord
	— — —	1 x	Commercially available rust solvent, e.g. WD40
	— — —	1 x	Wrapping/insulating tape (commercially available)
	— — —	1 x	Auxiliary line (Tekalan or Teflon hose) approx. 1,500 mm long

Tools:	<b>VAS 6935 Pole terminal puller</b>	<b>Nr.90 Pos.3 - Torque wrench</b>
	<b>9900 - PIWIS Tester 3</b>	<b>Transmission and Engine Jack</b>
	Restraining strap for securing loads	Hand lamp
	<b>Nr.89 Pos.5 - Torque screwdriver</b>	

Three-mandrel pliers for hoses and sleeves (commercially available)

Installing:	1	Preparatory work
	1.1	Drive vehicle onto a lifting platform ( ⇒ <i>Workshop Manual '4X00IN Lifting the vehicle</i> ).

1.2 Connect battery charger ( ⇒ *Workshop Manual '2X00IN Trickle charging 12-volt lithium-ion battery*).

1.3 Expose plenum panel area (⇒ *Figure 6*)

- 1 – Filler neck for windscreen-washer reservoir
- 2 – Engine cover (design cover)
- 3 – Strut brace (installation position of engine sound control unit)

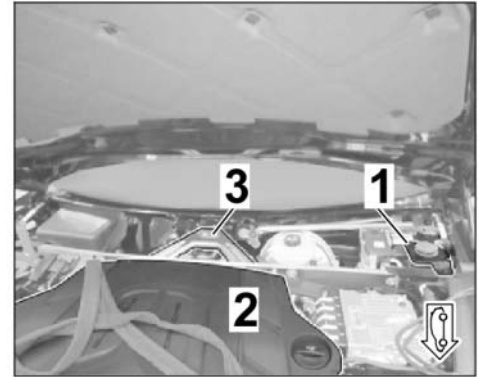

Figure 6

1.3.1 Remove the moulding for the windscreen ( ⇒ *Workshop Manual '666119 Removing and installing moulding for windscreen*).

1.3.2 Remove the wiper arms ( ⇒ *Workshop Manual '922519 Removing and installing the wiper arm*).

1.3.3 Remove the front lid seal ( ⇒ *Workshop Manual '553319 Removing and installing the front lid seal*).

1.3.4 Remove the cowl panel cover ( ⇒ *Workshop Manual '508719 Removing and installing the cowl panel cover*)

1.4 Removing the seats

1.4.1 Remove the luggage compartment cover in the boot.

1.4.2 Remove the rear seat padding (2/3-split folding rear seat) ( ⇒ *Workshop Manual '74491901 Removing and installing the padding for the rear seat surface (2/3-split folding rear seat)*).



### Heavy components

- **Risk of pinching**
- ⇒ **Wear personal protective gear.**
- ⇒ **Get someone to help if necessary.**

1.4.3 Loosen the 2/3-split folding rear seat ( ⇒ *Workshop Manual '724819 Removing and installing the rear seat*)



### Information

The help of another person is required for this step.

1.4.4 Carefully lift the 2/3-split folding rear seat out of the vehicle via the boot.

**⚠ CAUTION****Heavy components**

- **Risk of pinching**
- ⇒ **Wear personal protective gear.**
- ⇒ **Get someone to help if necessary.**

1.4.5 Loosen the (left) front seat ( ⇒ *Workshop Manual '720119 Removing and installing the front seat*)

**Information**

The help of another person is required for this step.

1.4.6 Carefully lift the front seat (left) from the vehicle to the rear via the boot.

1.5 Expose the A-pillar area (left side) ( ⇒ *Figure 7* )

- 1 – Front side-section trim panel
- 2 – Footrest
- 3 – Inner door sill trim (front)
- 4 – A-pillar trim panel (lower part)
- 5 – 1/3 rear seat

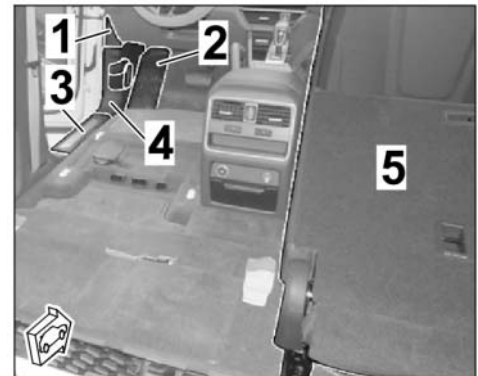

Figure 7

1.5.1 Remove the side trim panel on the front ( ⇒ *Workshop Manual '702419 Removing and installing the trim panel for the front side panel*).

1.5.2 Remove the footrest ( ⇒ *Workshop Manual '703519 Removing and installing the footrest*).

1.5.3 Remove the A-pillar trim panel (lower part) ( ⇒ *Workshop Manual '70571901 Removing and installing the A-pillar trim panel (lower part)*).

1.6 Expose the B-pillar area (left side) (⇒ *Figure 8*)

- 1 – B-pillar trim panel (upper part)
- 2 – B-pillar trim panel (lower part)
- 3 – (Inner) door sill trim
- 4 – C-pillar trim panel (lower part)
- 5 – Side trim panel of the boot (left side)
- 6 – Bulkhead cover

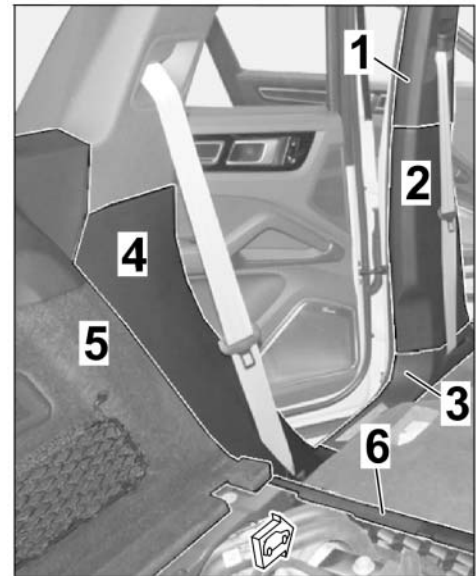

Figure 8

1.6.1 Loosen the B-pillar trim panel (upper part) and leave it hanging on the belt strap ( ⇒ *Workshop Manual '70671901 Removing and installing the B-pillar trim panel (upper part)*).

1.6.2 Remove the inner door sill trim ( ⇒ *Workshop Manual '680519 Removing and installing the inner door sill trim*)

1.6.3 Remove the B-pillar trim panel (lower part) ( ⇒ *Workshop Manual '70671903 Removing and installing the B-pillar trim panel (lower part)*).

1.7 Expose C-pillar/luggage compartment area

1.7.1 Remove the cover for the (rear) lock carrier ( ⇒ *Workshop Manual '703919 Removing and installing the cover for the front lock carrier*).

1.7.2 Remove the luggage compartment light side trim (left/right) ( ⇒ *Workshop Manual '964019 Removing and installing the luggage compartment light side trim*).

1.7.3 Remove the side trim panel for the luggage compartment (left/right) ( ⇒ *Workshop Manual '700319 Removing and installing the side trim panel for the rear luggage compartment*).

1.7.4 Remove C-pillar trim panel (lower part) on the left side ( ⇒ *Workshop Manual '70681901 Removing and installing C-pillar trim panel (lower part)*).

1.7.5 Push the 1/3 rear seat forward and remove the cover on the bulkhead.

**CAUTION**

**Hot components**

- Risk of burns
- ⇒ Let hot components cool down.
- ⇒ Wear personal protective gear.

- 1.8 Work in the exhaust system area
- 1 – Cover for rear underbody
  - 2 – Rear tunnel cover
  - 3 – Front underbody cover (rear section)
  - 4 – Tailpipe (left/right)

1.8.1 Remove rear underbody cover and rear tunnel cover (⇒ *Figure 9-1 and 2-*) ⇒ *Workshop Manual '519419 Removing and installing cover for rear underbody'*

1.8.2 Remove the tailpipe (left/right) (⇒ *Figure 9-4-*, ⇒ *Workshop Manual '263419 Removing and installing the tailpipe'*).

1.8.3 Secure catalytic converter exhaust pipe(s) on the transmission support using restraining strap for securing loads, for example, to prevent them from bending down.

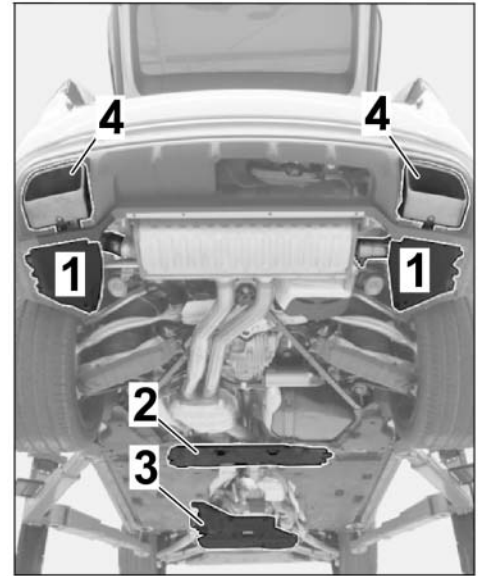

Figure 9

**⚠ CAUTION**

**Heavy components**

- Risk of pinching
- ⇒ Wear personal protective gear.
- ⇒ Get someone to help if necessary.

1.8.4 Remove exhaust system **WITHOUT** removing tunnel strut (⇒ *Workshop Manual '260119 Removing and installing exhaust system'*).

2 Replacing engine noise control unit

- 2.1 Check whether there is a tie-wrap on the side tab on the engine noise control unit. Remove the tie-wrap if necessary.
- 2.2 Disconnect plug connection for the standard engine noise control unit and remove engine noise control unit with holder.

2.3 Remove standard engine noise control unit from control unit holder (⇒ *Figure 10*).

- 1 – Control unit holder
- 2 – Engine noise control unit
- 3 – Wire harness for engine noise
- 4 – Line clip
- 5 – Dome strut
- 6 – Engine noise pulse sender (LHD position)

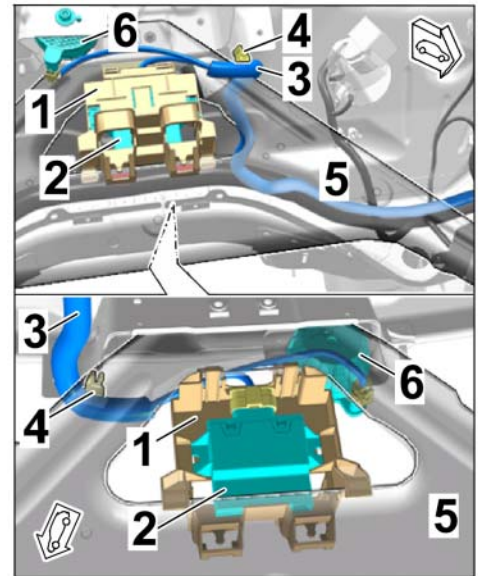

Figure 10

2.4 Insert new engine noise control unit at the underside in the control unit holder (⇒ *Figure 11 -LHD vehicle -*).

- 1 – Engine noise control unit
- 2 – Control unit holder.
- 3 – Locking/unlocking

2.5 Install the holder with the engine noise control unit to the strut brace (plenum panel area ⇒ *Figure 10*).

3 Routing and connecting wire harness for exhaust flaps

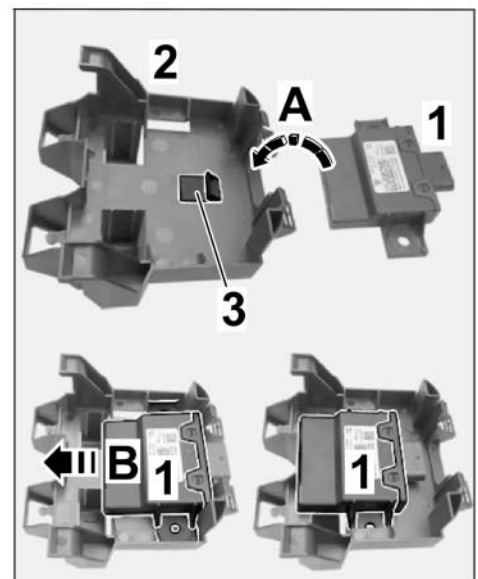
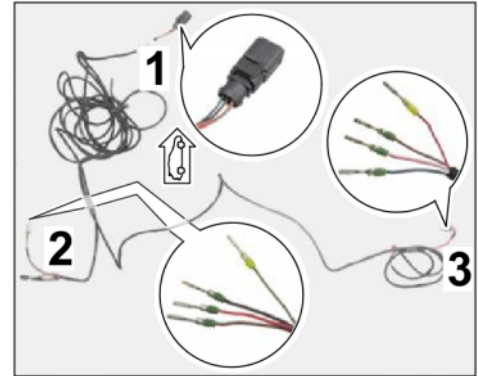

Figure 11

Connections for wire harness for exhaust flaps  
(⇒ *Figure 12*):

- 1 – Connector for connection point (preparation of exhaust flaps, 6-pin)
  - 2 – Branch for exhaust flap (left)
  - 3 – Branch for exhaust flap (right)
- 3.1 Make a plug-in connection (6-pin) between the connection point (preparation) and exhaust flaps



*Figure 12*

- 3.1.1 Expose the connection point (preparation = socket connector, 6-pin) in the passenger compartment of the vehicle, area of bulkhead grommet, A-pillar left (⇒ *Figure 13 -LHD vehicle -*).

- 1 – Foam preparation (socket connector, 6-pin)
- 2 – Grommet on bulkhead (LHD vehicle)
- 3 – Connector for wire harness for exhaust flaps (6-pin)

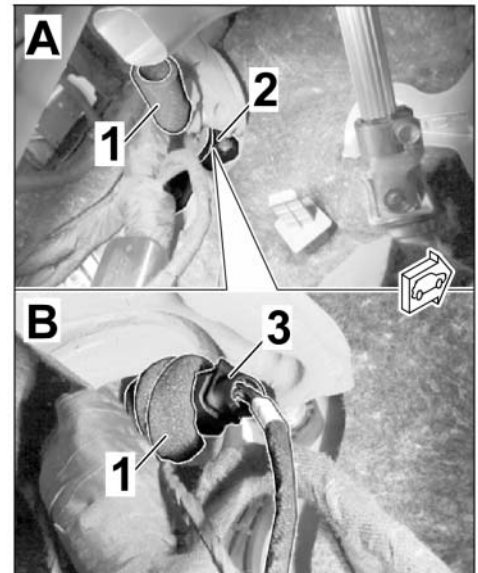

*Figure 13*

- 3.1.2 Push the foam preparation (socket connector, 6-pin) onto the line on the vehicle side.

- 3.1.3 Establish a connection between the plug connection preparation and the wire harness for the exhaust flaps (6-pin) ⇒ *Figure 13 -RHD vehicle -*).

- 3.1.4 Push the foam over the plug connection (6-pin).

- 3.2 Lay the wire harness for the exhaust flaps to the rear of the vehicle as follows

Route of the wire harness for exhaust flaps in the vehicle (⇒ *Figure 14*):

- 1 – Connection point (preparation)
- 2 – Grommet/stopper for luggage compartment floor (left)
- 3 – Grommet/stopper for luggage compartment floor (right)

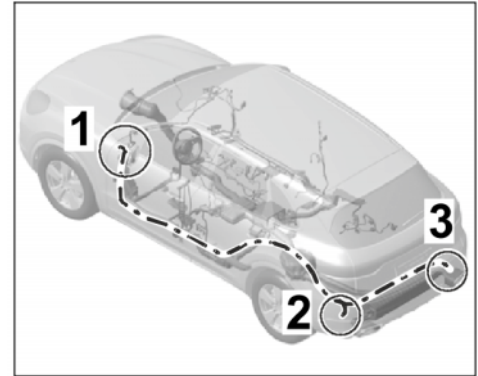
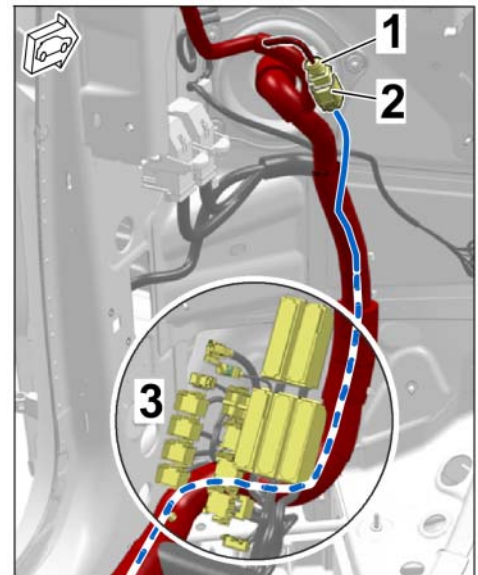

*Figure 14*

3.2.1 A-pillar area, left (⇒ *Figure 15*)

- 1 – Socket connector (6-pin, preparation)
- 2 – Pin connector (6-pin, wire harness for exhaust flaps)
- 3 – Fuses/relays (LHD vehicles)

- **LHD vehicles:** Connecting point (preparation = socket connector, 6-pin) → along wire harness A-pillar, left → beneath fuses/relays (**DO NOT** remove the relay carrier - at most loosen it.) → Door sill A-pillar, left

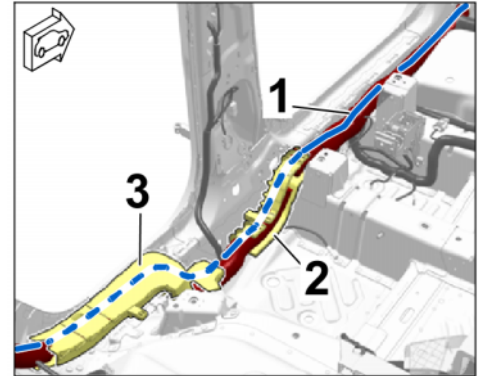

*Figure 15*

3.2.2 Door sill area, left (⇒ *Figure 16*)

- 1 – Wire harness for exhaust flaps
- 2 – Cable holder, door sill B-pillar area (left)
- 3 – Cable duct, rear door sill area (left)

- Door sill A-pillar, left → along wire harness for door sill, left (open cable ducts/holders if necessary) → wheel housing, rear left

*Figure 16*3.2.3 Wheel housing area, left (⇒ *Figure 17*)

- 1 – Cable duct, rear door sill area (left)
- 2 – Cable duct, rear wheel housing area (left)
- 3 – Fuse box in the boot (left)
- 4 – Grommet/stopper for luggage compartment floor, left (Ø 66.5 mm)
- 5 – Branch for exhaust flap, right side

- Door sill, left → above wheel housing, left → branch for exhaust flap (left) to grommet/stopper for luggage compartment floor, left (beneath fuse/relay carrier) → branch for exhaust flap, right of the rear end plate

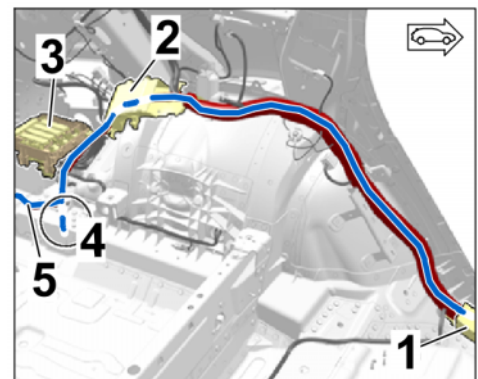
*Figure 17*

3.2.4 Rear end plate area and grommet/stopper for luggage compartment floor (⇒ *Figure 18*)

- 1 – Branch for exhaust flap (left)
- 2 – Branch for exhaust flap (right)
- 3 – Fuse box in the boot (left)
- 4 – Grommet/stopper for luggage compartment floor, left (Ø 66.5 mm)
- 5 – Grommet/stopper for luggage compartment floor, right (Ø 46 mm)

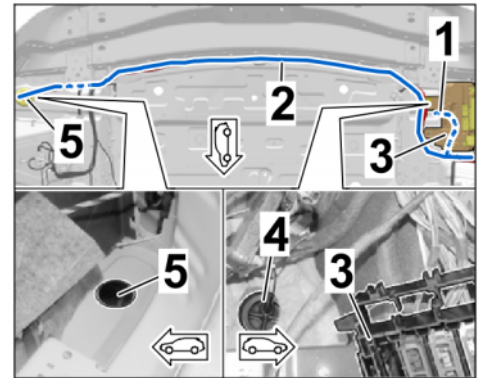

Figure 18

- Branch for exhaust flap (left) to grommet/stopper for luggage compartment floor, left (beneath fuse box in luggage compartment (left) → branch for exhaust flap on the right to rear closing panel → along rear closing panel (⇒ *Figure 18-top-*) → grommet/stopper for luggage compartment floor, right.

3.3 Lay the branch for the exhaust flap (left/right) to the underside of the vehicle

3.3.1 Loosen the fuse box with the holder in the luggage compartment, rear left, and turn it aside (⇒ *Figure 19*, ⇒ *Workshop Manual '978409 fuse box in the luggage compartment*).

- 1 – Fuse box with holder
- 2 – Grommet (left = Ø 66.5 mm)

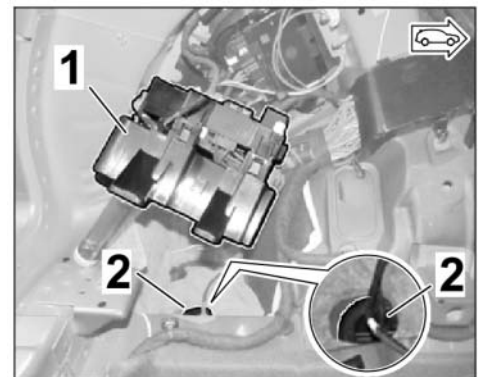

Figure 19

3.3.2 Loosen the heat shield on the underside of the vehicle in the area of the grommet (right/left) and stopper (right/let) and bend it down slightly.

3.3.3 Remove the stoppers in the luggage compartment floor (left = Ø 66.5 mm/right = Ø 46 mm). The stopper is replaced by a corresponding grommet (see parts package).

3.3.4 **ONLY** if a grommet with several lines is installed on the underside (including an exhaust flap branch (left/right of the standard rear silencer) ⇒ *Figure 20*):

- 1 – Sleeve
- 2 – Branch for exhaust flap
- 3 – Exhaust flap (standard rear silencer)

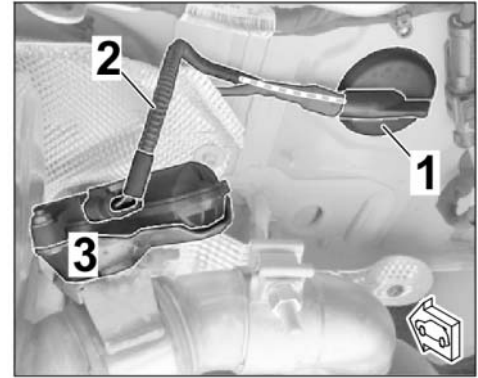

*Figure 20*

- Remove grommet(s) (left/right) with branches and guide it into the passenger compartment.
- Remove the connector housing from the respective exhaust flap branch (left/right of the standard rear silencer).
- Spread the grommet using a three mandrel pliers for hoses and grommets (commercially available) and remove adhesive residue from the grommet.
- **CAREFULLY** guide the exhaust flap standard branch through the grommet into the passenger compartment and wrap it with insulating tape and secure it .
- Guide the new branch for the exhaust flap (left/right) through the neck of the grommet (see also 3.3.6) **OR** through another hole in the grommet collar (⇒ *Figure 21*) **CAREFULLY** to the underside of the grommet.

- 1 – Sleeve
- 2 – Branch for exhaust flap (left/right)
- 3 – Additional electric line

3.3.5 **ONLY** if a grommet is installed with the exhaust flap branch (left/right of the standard rear silencer):

- Remove grommet(s) with branch connections to the exhaust flap (left/right) and guide it/them into the passenger compartment.
- Tie back the exhaust flap branch (left/right) with the connector and grommet on the wire harness on the vehicle side in the passenger compartment.

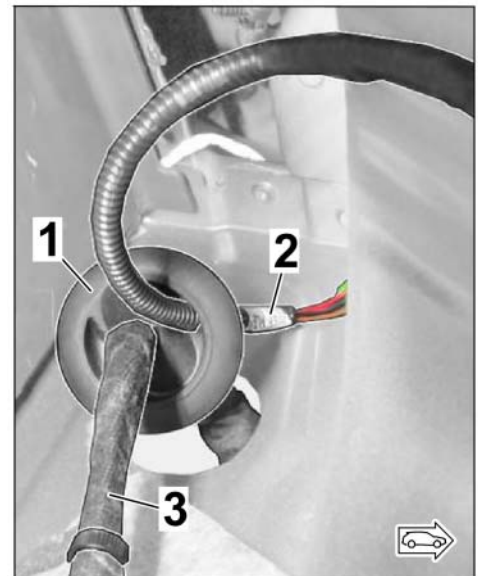

*Figure 21*

- Use a new grommet (left = Ø 66.5 mm/right = Ø 46 mm, see scope of parts) (see also 3.3.6).

3.3.6 **ONLY** if stopper (left = Ø 66.5 mm/right = Ø 46 mm) is installed:

- Remove the stoppers (left = Ø 66.5 mm/right = Ø 46 mm).
- Use a new grommet (left = Ø 66.5 mm/right = Ø 46 mm, see scope of parts).

3.3.7 Guide the new branch for the exhaust flap (left/right) through the new grommet (left = Ø 66.5 mm/right = Ø 46 mm ⇒ *Figure 22*) using three mandrel pliers and an auxiliary line (Tekalan or Teflon tube).

- 1 – Three mandrel pliers
- 2 – Grommet, right (Ø 46 mm)

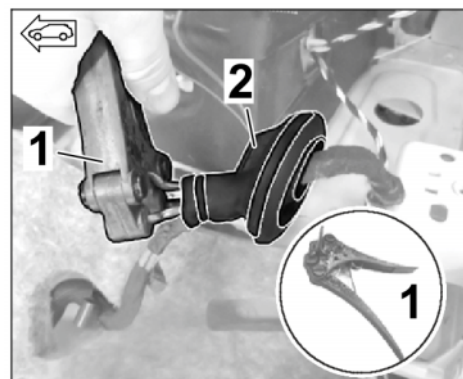

Figure 22

3.4 Installing the socket housing on the exhaust flap branch

3.4.1 Release the socket housing (4-pin, see parts list) (⇒ *Figure 23 -LHD vehicle -*).

- 1 – Fuse
- 2 – Plug socket (4-pin)

3.4.2 Connect the lines with female contacts and single-core seals (wire harness for exhaust flaps) in the socket housing (4-pin, see parts list) as follows:

- Left exhaust flap:

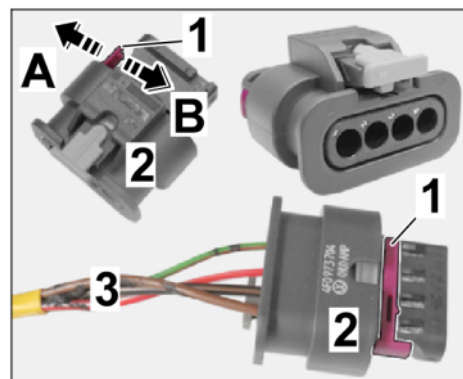

Figure 23

Plug socket (4-pin)	Line/function
Chamber 1	BN; 0.5 <sup>2</sup> = Terminal 31 (Ground)
Chamber 2	SW/BN; 0.75 <sup>2</sup> = Pulse Width Module (PWM)
Chamber 3	RT/WS; 0.5 <sup>2</sup> = Terminal 87 (power supply, fuse
Chamber 4	GN/RT; 0.35 <sup>2</sup> = Pulse Width Module out (PWM)

- Right exhaust flap:

Plug socket (4-pin)	Line/function
Chamber 1	BN; 0.5 <sup>2</sup> = Terminal 31 (Ground)
Chamber 2	SW/BL; 0.5 <sup>2</sup> = Pulse Width Module (PWM)
Chamber 3	RT/WS; 0.5 <sup>2</sup> = Terminal 87 (power supply, fuse)
Chamber 4	RT / SW; 0.35 <sup>2</sup> = Pulse Width Module out (PWM)

- 3.4.3 Lock the socket housing (4-pin, see parts list) (⇒ *Figure 23 -RHD vehicle -*).
- 3.4.4 Wrap cables (4 x) with insulating tape from a distance of approx. 30 mm from the connector (socket housing 4-pin) as far as the underbody.
- 3.4.5 Install corrugated hose 4.5 x 7.6 x X to each branch from a distance of approx. 30 mm from the connector (socket housing 4-pin) to the underbody (⇒ *Figure 24*).

- 1 – Corrugated hose, 4.5 x 7.6 x X
- 2 – Connector (socket housing 4-pin)
- 3 – Branch for exhaust flap (right)
- 4 – Tie-wrap
- X – approx. 30 mm

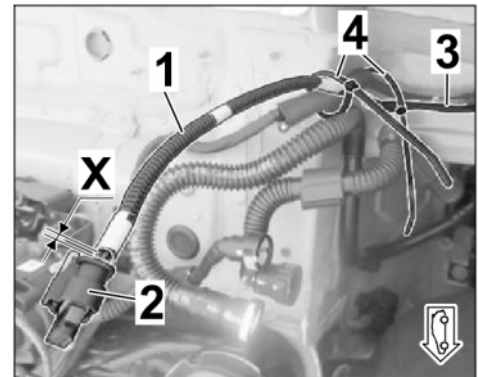

Figure 24

- Left side: Corrugated hose, 4.5 x 7.6 x 220
- Right side: Corrugated hose, 4.5 x 7.6 x 230

- 3.5 Check fuse assignment of exhaust flaps and engine sound pulse generator in the fuse box (left A-pillar footwell ⇒ *Figure 25*) (⇒ Cayenne Driver's Manual, section on 'Fuses')

- 1 – Fuse strip A
- 2 – Fuse strip D

- 3.5.1 Check that slot A4 is inserted into fuse strip A (exhaust flaps) and secure with a new fuse if necessary.

Fuse: **Nominal value 7.5 A**

- 3.5.2 Check that slot D3 is inserted into fuse strip D (structure-borne noise control unit, engine noise generator) and secure with a new fuse if necessary.



Figure 25

Fuse: **Nominal value 15 A**

## 4 Install new exhaust system

4.1 Install new center silencer with new clamping sleeve (Ø 65 x 88) (⇒ *Workshop Manual '2601119 Removing and installing exhaust system*).

- 1 – Clamping sleeve, Ø 65 x 88
- 2 – Center silencer holder, front left
- 3 – Center silencer holder, front right
- 4 – Center silencer
- 5 – Center silencer retaining ring
- 6 – Clamping sleeve, Ø 65 x 88
- 7 – Rear silencer
- 8 – Sports tailpipes, Black chrome-plated, left
- 9 – Sports tailpipes, Black chrome-plated, right

- Hexagon flange bolt, M10 x 30 (center silencer holder): **Tightening torque 49 Nm (36 ftlb.)**
- Clamping sleeve, Ø 65 x 88: **Tightening torque 30 Nm (22 ftlb.)**

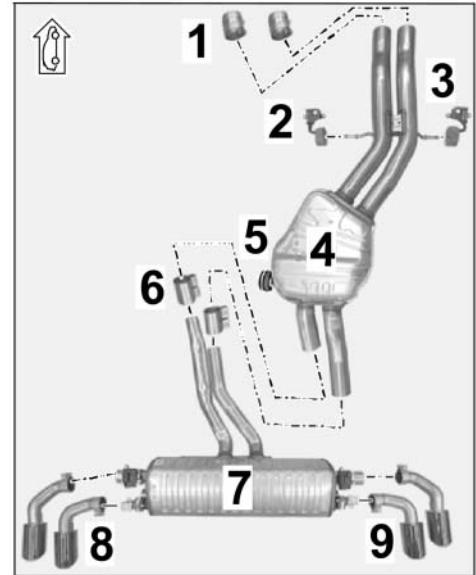

Figure 26

4.2 Install new rear silencer with a new clamping sleeve, Ø 65 x 88 (2 x) (⇒ *Workshop Manual '263355 Replacing rear silencer*).

- Hexagon flange bolt, M8 x 25 (rear silencer holder): **Tightening torque 23 Nm (17 ftlb.)**
- Clamping sleeve, Ø 65 x 88: **Tightening torque 30 Nm (22 ftlb.)**

4.3 Connect electric plug connections for servo motor for exhaust flap (left/right).

- 4.3.1 Pull the excess branch wire for the exhaust flap (left/right) towards the grommet in the floor of the vehicle.
- 4.3.2 Seal the line bushing for the exhaust flap in the grommets (left/right) from the inside and outside using sealing cord.

- 4.4 Install new sports tailpipes (silver or black) and align them with the rear apron ⇒ *Installation and Conversion Instructions '263400 (sports tailpipe, double inlet – silver (OP3)/black (OP6))*.

- 1 – Sports tailpipe – inner (right)  
2 – Sports tailpipe – outer (right)  
3 – Exhaust system cover (rear apron)

- 4.4.1 Check that the gap between the new sports tailpipes and exhaust system cover (rear apron – left and right side of vehicle) is symmetric and constant and adjust it if necessary.

⇒ *Figure 27-Z*: **Control value 21 mm +/- 1 mm**

- 4.4.2 Check spacing of inner/outer sports tailpipe (left and right side of vehicle) and make adjustments if necessary.

⇒ *Figure 27-Za*: **Control value 11 mm +/- 1 mm**

- 4.4.3 Tighten lens-head screw, M6 x 12 (underside of sports tailpipe cover).

**Tightening torque 8 Nm (6 ftlb.) +/- 1 Nm (+/- 0.5 ftlb.)**

- 4.5 Install all covers to the underbody of the vehicle.

## 5 Concluding work for vehicle interior/engine compartment (plenum panel)

- 5.1 Secure routed wire harness (for exhaust flaps) in the vehicle to existing lines/components with tie-wraps without tensile stress and so that no chafing occurs.
- 5.2 Install trim panels in the boot and C-pillar area.
- 5.3 Install trim panels in the B-pillar and A-pillar area (left side).
- 5.4 Installing the seat assembly
- 5.4.1 Carefully lift the front seat into the vehicle via the boot and install it with a new cheese head bolt ( ⇒ *Workshop Manual '720119 Removing and installing the front seat*).
- 5.4.2 Carefully lift the 2/3-split folding rear seat into the vehicle via the boot and install it with a new cheese head bolt ( ⇒ *Workshop Manual '724819 Removing and installing the rear seat*).
- 5.4.3 Install padding for rear seat surface (2/3-split folding rear seat) with new fixing clip ( ⇒ *Workshop Manual '74491901 Removing and installing padding for rear seat surface (2/3-split folding rear seat)*).

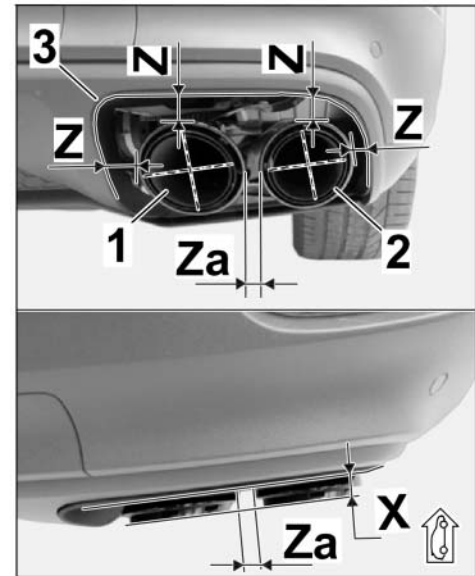

Figure 27

- 5.5 Complete the engine compartment (plenum panel) area.
  - 5.5.1 Install cowl panel cover ( ⇒ *Workshop Manual '508719 Removing and installing cowl panel cover'*)
  - 5.5.2 Install front lid seal ( ⇒ *Workshop Manual '553319 Removing and installing front lid seal'*).
  - 5.5.3 Install wiper arms ( ⇒ *Workshop Manual '922519 Removing and installing wiper arm'*).
  - 5.5.4 Install windscreen moulding ( ⇒ *Workshop Manual '666119 Removing and installing moulding for windscreen'*).

Coding: 6 Coding/programming sports exhaust system - Silver (OP8)/Black (OP9)

## NOTICE

### Voltage drop

- Risk of irreparable damage to control unit
  - Risk of damage to control unit
  - Fault entries in the control unit
  - Coding in the control unit is aborted
  - Malfunctions in control unit, even during programming
- ⇒ Switch off the ignition and remove the ignition key before disconnecting the control unit.
- ⇒ Ensure that the power supply is not interrupted during programming.
- ⇒ Connect a battery charger with a current rating of at least Nominal value 90 A to the vehicle battery.

### 6.1 Preparatory work – Coding

## NOTICE

Control unit programming will be aborted if the Internet connection is unstable.

- An unstable Internet connection can interrupt communication between PIWIS Tester III and the vehicle communication module (VCI). As a result, control unit programming may be aborted.
- ⇒ During control unit programming, always connect PIWIS Tester III to the vehicle communication module (VCI) via the USB cable.

6.1.1 9900 - PIWIS Tester 3 must be connected to the vehicle and switched on.

6.1.2 Switch on ignition **AND** hazard warning lights on the vehicle.

**Information**

The **9900 - PIWIS Tester III** instructions take precedence since the description may be different with later Tester releases.

The procedure described here has been structured in general terms; different text or additions may appear on the **9900 - PIWIS Tester III**.

- 6.1.3 Select the "Diagnostics" menu item on the PIWIS Tester.
- 6.1.4 If **9900 - PIWIS Tester 3** is connected correctly, a connection to the vehicle will be established: "Cayenne" model line is detected.
- 6.1.5 Press •F12" to go to the control unit search screen.
- 6.1.6 Confirm the question: "Create vehicle analysis log (VAL)?" with "Yes" = •F12" .
- 6.1.7 Select "KD-FAP" in the next menu item and press •F8" to start.

**Information**

The function is **ONLY** available when the Tester is online!

- 6.2 Enter the new vehicle equipment in the vehicle data using "PIWIS Online"
  - 6.2.1 Press •F7" in the control unit overview to switch to the "Additional menu".
  - 6.2.2 Select the function "Maintenance of vehicle data with PIWIS ONLINE".

A message appears informing you that the "Actual" (vehicle) data and "Required" (PIWIS Online) data will be compared.

Press •F12" to continue.
  - 6.2.3 Confirm the message "The vehicle data was compared with PIWIS Online. Significant differences were found" with •F12" .
  - 6.2.4 Look for the option "INTERIOR SOUND MEASURES (VW SILENCERS)" in the "Family" column.

Select the option "2HB – INTERIOR SOUND MEASURES (SHAKER)" from the drop-down menu in the "Value" column.
  - 6.2.5 Look for the option "EXHAUST TAILPIPE" in the "Family" column.

Select "OP8 – SPORTS EXHAUST SYSTEM – STAINLESS-STEEL TAILPIPES" or "OP9 – SPORTS EXHAUST SYSTEM – BLACK TAILPIPES" from the drop-down menu in the "Value" column, depending on the installed option.

Press •F12" to continue.
  - 6.2.6 A table containing the coding value and the columns "new value" and "old value" is displayed in the overview. Press •F8" to continue.

- 6.2.7 Data is then written/stored. The following messages appear one after the other:
- Transferring vehicle data to PIWIS Online.
  - Writing and transferring vehicle data to the vehicle.
  - Vehicle order was written successfully.
  - A check was performed in order to check whether control units have to be coded or programmed as a result of the changes that were made.
- 6.3 Code/program the new vehicle equipment.
- 6.3.1 Confirm the table containing a list of control units that must be coded/programmed by pressing •F12” .
- 6.3.2 Individual data records will be loaded, depending on the number of control units to be coded/programmed.
- Wait until the message "Creating backup documentation. Please wait..." and "Coding was completed successfully" appears. Press •F12” to continue.
- Repeat the process for other control units if necessary.
- 6.3.3 Wait until the message "Adaptation of the control units is complete." appears and check the coding status of the control units in the table that is displayed.
- Continue by pressing •F12” to return to the control unit overview.
- 6.4 Read out the fault memories of all systems, work through any existing faults and erase the fault memories. ⇒ *Workshop Manual '03351N Diagnostic maintenance: diagnostic system and maintenance inter...'*
- 6.5 Switch off ignition and disconnect **9900 - PIWIS Tester 3**.
- 6.6 Drive the vehicle off the lifting platform.
- 7 Perform "Sports exhaust system" function test
- 7.1 Start the engine.
- 7.2 Activate/deactivate the sports exhaust system, depending on vehicle equipment, using the following option:
- Porsche Communication Management: Select the menu "Car" → "Drive" → "Sports exhaust system".
  - Porsche Communication Management: Select "SPORT" or "SPORT PLUS"
- 7.3 Switching off ignition

26 01 31 20:	–Sports exhaust system (1 x) retrofitted–	Labor time: <b>609 TU</b>
Includes:	Replacing engine noise control unit; Routing and connecting electric wire harness for exhaust flaps; Replacing center and rear silencers; Installing and aligning new sports tailpipes (4 x); Coding sports exhaust system; Reading out fault memory and correcting and deleting faults.	
Without:	Test drive	

**Important Notice:** Technical Bulletins issued by Porsche Cars North America, Inc. are intended only for use by professional automotive technicians who have attended Porsche service training courses. They are written to inform those technicians of conditions that may occur on some Porsche vehicles, or to provide information that could assist in the proper servicing of a vehicle. Porsche special tools may be necessary in order to perform certain operations identified in these bulletins. Use of tools and procedures other than those Porsche recommends in these bulletins may be detrimental to the safe operation of your vehicle, and may endanger the people working on it. Properly trained Porsche technicians have the equipment, tools, safety instructions, and know-how to do the job properly and safely. Part numbers listed in these bulletins are for reference only. The work procedures updated electronically in the Porsche PIWIS diagnostic and testing device take precedence and, in the event of a discrepancy, the work procedures in the PIWIS Tester are the ones that must be followed.

© 2022 Porsche Cars North America, Inc.