

September 30, 2022

Version 4

Safety Recall: 2006–14 Ridgeline Rear Frame Repair

Supersedes 22-021, dated August 31, 2022, to revise the information highlighted yellow.

AFFECTED VEHICLES

Year	Model	Trim	VIN Range
2006–14	Ridgeline	ALL	Check the iN VIN status for eligibility.

REVISION SUMMARY

- Under PARTS INFORMATION “two” bullet points were added.
- Under REPAIR PROCEDURE A, step 15.1, a bullet point was added.
- Under REPAIR PROCEDURE A, step 17.9, an image was added.

BACKGROUND

In salt-belt states where de-icing agents are used to maintain the roadway, the de-icing agents, along with mud and dirt, could accumulate along the rear frame where the fuel tank is mounted. Over time, the accumulated de-icing agents/mud/dirt mixture could cause the fuel tank band mounts to corrode and separate from the frame. If this occurs, an unsecured fuel tank can become damaged from undercarriage impact, which can possibly result in fuel leakage.

CUSTOMER NOTIFICATION

Owners of affected vehicles will be sent a notification of this campaign.

Do an iN VIN status inquiry to make sure the vehicle is shown as eligible.

Some vehicles affected by this campaign may be in your new or used vehicle inventory.

Failure to repair a vehicle subject to a recall or campaign may subject your dealership to claims or lawsuits from the customer or anyone else harmed as a result of such failure. To see if a vehicle in inventory is affected by this safety recall, do a VIN status inquiry before selling it.

CORRECTIVE ACTION

Inspect the rear frame for rust and corrosion, if needed, install the kit.

CUSTOMER INFORMATION:The information in this bulletin is intended for use only by skilled technicians who have the proper tools, equipment, and training to correctly and safely maintain your vehicle. These procedures should not be attempted by “do-it-yourselfers,” and you should not assume this bulletin applies to your vehicle, or that your vehicle has the condition described. To determine whether this information applies, contact an authorized Honda automobile dealer.

PARTS INFORMATION

NOTE:

- For dealers experiencing insufficient space in storing the fuel tank straps replaced under this service bulletin, the fuel tank straps may be disposed of immediately. This only applies to the parts replaced under this service bulletin. The published retention policy remains in effect for all other parts.
- If you have questions about this exception or other parts retention issues, contact the WPI Administrator Office at 937-642-2737.

Part Name	Part Number	Quantity
Subframe Casting and Crossmember Kit	06730-SJC-315	1

REQUIRED MATERIALS

Part Name	Part Number	Quantity
3M Automotive Undercoating or Equivalent Commercially Available (One can repairs 9 vehicles)	08881	1
Brake Cleaner	08700-9200	1
Anti-corrosion Wax (One can repairs 2 vehicles)	07AAK-SJCA120	1

TOOLS INFORMATION

NOTE:

- One of each tool was auto-shipped to all salt-belt dealers. Non-salt-belt dealers who have an affected vehicle should contact the Special Tools Hotline at (800) 346-6327 to request tools.
- Non-salt belt dealers will be required to provide a VIN in order to receive the frame inspection tool. Based on the results of the inspection, the remaining tools will be allocated as availability allows.
- The Riv Nut M8 Installer is an existing required tool item under the number LEML722M8. Dealers should look for this tool before requesting one as availability is extremely limited.

Part Name	Part Number	Quantity
Frame Inspection	07AAJ-SJCA100	1
Digital Scale	07AAJ-SJCA200	1
Subframe Flush Kit	07AAK-SJCA100	1
Rivnut Installer M8	07AAE-SJCA100	1

WARRANTY CLAIM INFORMATION

Operation Number	Description	Flat Rate Time	Defect Code	Symptom Code	Template ID	Failed Part Number
8230D4	Rear frame inspection only (Includes photos).	0.4 hr	6LC00	LCD00	A22021A	50300-SJC-A01

Repair Procedure A

4170A7	Repair Procedure A (Includes inspection and photos)	2.2 hr	6LC00	LCD00	A22021B	50300-SJC-A01
--------	---	--------	-------	-------	---------	---------------

Repair Procedure A and B

4170A7	Repair Procedure A (Includes inspection and photos)	2.2 hr	6LC00	LCD00	A22021C	50300-SJC-A01
4170A7B	Repair Procedure B (One or both sides tank band) - Add	0.2 hr				
4170A7E	Additional photos for Repair Procedure B and/or C - Add	0.1 hr				

Repair Procedure A, B and C (One Side)

4170A7	Repair Procedure A (Includes inspection and photos)	2.2 hr	6LC00	LCD00	A22021D	50300-SJC-A01
4170A7B	Repair Procedure B (One or both sides tank band) - Add	0.2 hr				
4170A7C	Repair Procedure C (One side only) - Add	0.3 hr				
4170A7E	Additional photos required for Repair Procedure B and/or C - Add	0.1 hr				

Repair Procedure A, B and C (Both Sides)

4170A7	Repair Procedure A (Includes inspection and photos)	2.2 hr	6LC00	LCD00	A22021E	50300-SJC-A01
4170A7B	Repair Procedure B (One or both sides tank band) - Add	0.2 hr				
4170A7C	Repair Procedure C (One side only) - Add	0.3 hr				
4170A7D	Repair Procedure C (Additional side) - Add	0.3 hr				
4170A7E	Additional photos required for Repair Procedure B and/or C - Add	0.1 hr				

Repair Procedure A and C (One Side)

4170A7	Repair Procedure A (Includes inspection and photos)	2.2 hr	6LC00	LCD00	A22021F	50300-SJC-A01
4170A7C	Repair Procedure C (One side only) - Add	0.3 hr				
4170A7E	Additional photos required for Repair Procedure B and/or C - Add	0.1 hr				

Repair Procedure A and C (Both Sides)

4170A7	Repair Procedure A (Includes inspection and photos)	2.2 hr	6LC00	LCD00	A22021G	50300-SJC-A01
4170A7C	Repair Procedure C (One side only) - Add	0.3 hr				
4170A7D	Repair Procedure C (Additional side) - Add	0.3 hr				
4170A7E	Additional photos required for Repair Procedure B and/or C - Add	0.1 hr				

INSPECTION PROCEDURE

To watch inspection video [Click here](#).

1. Lift the vehicle on the hoist from the jacking points. Position the lift pads under the vehicle's front support points and rear support points.

NOTE: If the vehicle's support points are compromised due to corrosion, please use best shop practices to lift the vehicle.

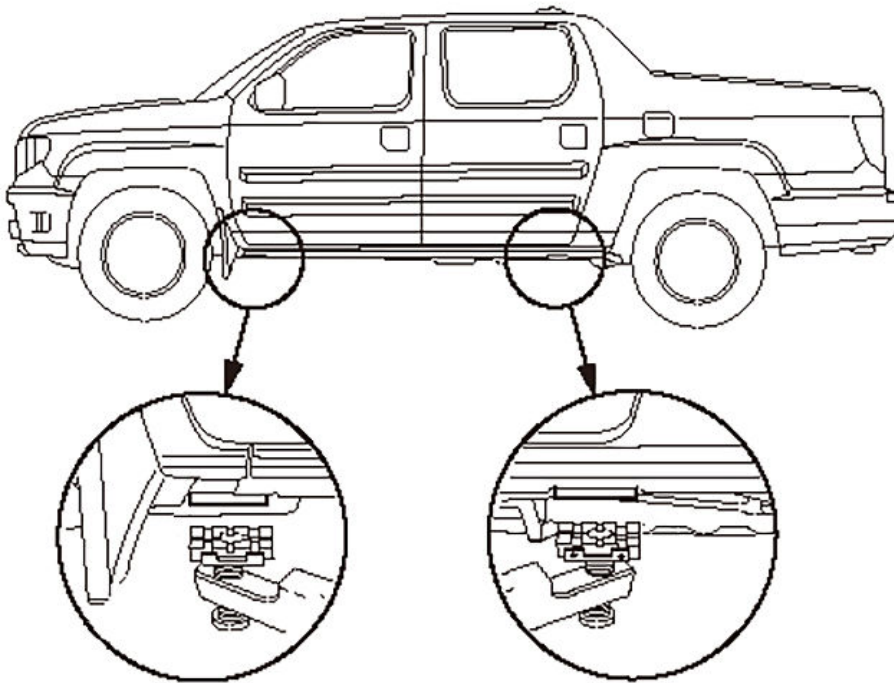

2. Use the frame inspection tool (07AAJ-SJCA100) to do a punch test on both the left and right rear frame rails in the following locations.
3. Place the punch on each of the indicated points on the rear frame rail indicated below with a red circle, then strike that point **3 times** with the frame inspection tool.

4. Make sure to check all **6 areas** on both sides of the frame rails.

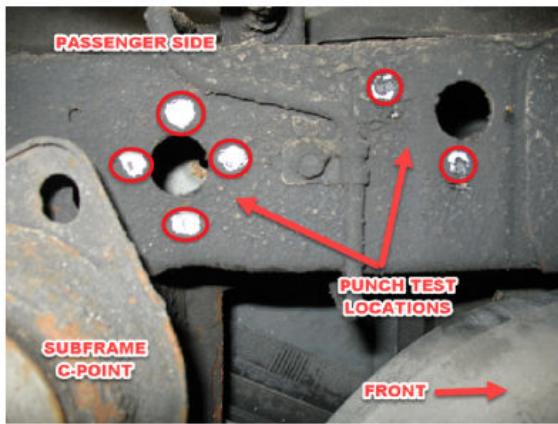
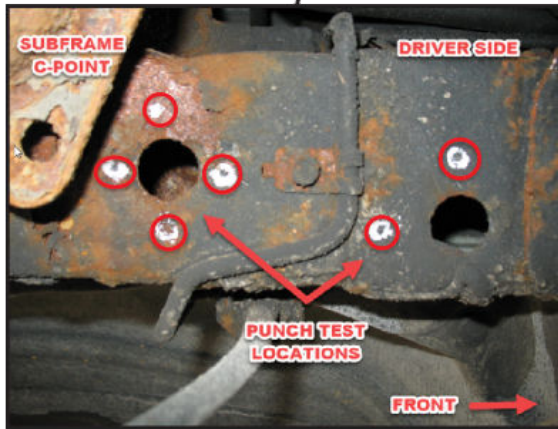
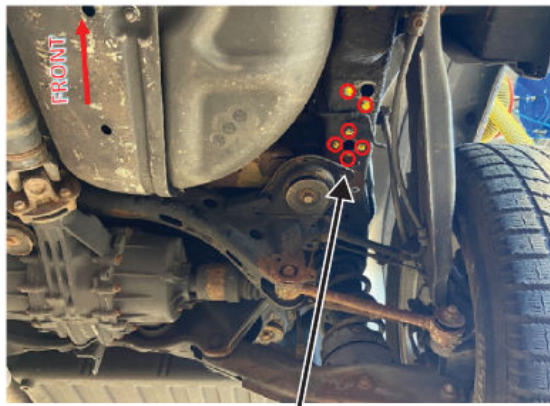

Did the punch pierce the rear frame rail at any of the inspection points?

YES – Inform your Service Manager and/or Shop Foreman that the vehicle has pierced through the rear frame rail. Take the required photos of the vehicle as shown in the PHOTOGRAPH REQUIREMENTS section below. You will need to submit the photo files along with the warranty claim. The vehicle is not eligible for the repair, and the Subframe Casting and Crossmember kit cannot be installed on the vehicle. Upload your photos to Tech Line using the Tech Line Image Uploader tool on the iN Then create a Tech Line Contact using iN and with the access code contact Tech Line by phone to confirm receipt of the photos and vehicle inspection details.

NO – Take the required photos of the vehicle as shown in the PHOTO REQUIREMENTS section below. Then go to REPAIR PROCEDURE A.

PHOTO REQUIREMENTS

A minimum of 4 (up to 8) photographs as shown below are required for the warranty claim submission. The file name must start with the keyword 'Photo'.

1. Photo of the VIN label on the left B-pillar.



2. Photo of the Odometer reading (not trip reading).



3. Photo of the left rear frame rail after the punch test.



4. Photo of the right rear frame rail after the punch test.



5. Photo of the fuel tank band attachment point (if REPAIR PROCEDURE B was completed).



6. Photo of the C-point subframe mount attachment point (if REPAIR PROCEDURE C was completed).



REPAIR PROCEDURE A

WASHING PROCEDURE [Click Here for Video](#)

The wash kit (07AAK-SJCA100) includes wash hoses/fittings, a quick-connect ball valve fitting, and bungee cords. All components are equipped with quick connect couplers so they can be easily connected/disconnected.

NOTE: If the vehicle's support points are compromised due to corrosion, please use best shop practices to lift the vehicle.

1. Insert the wash hose nozzle into the following locations as shown below.

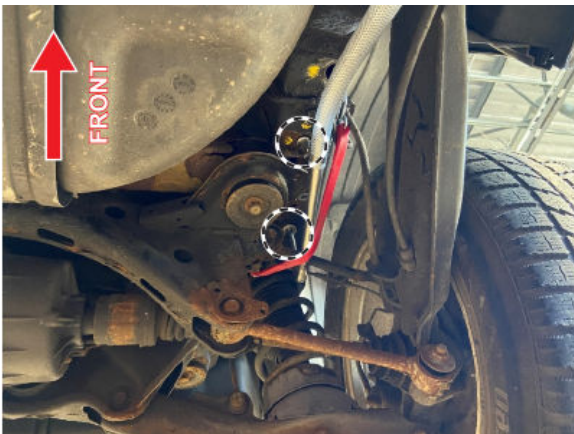

2. Secure the wash hose using the provided bungee cords as shown below.

NOTE: One end of the bungee cord is hooked on the brake hose bracket and the other end is hooked on the wheel speed sensor bracket.

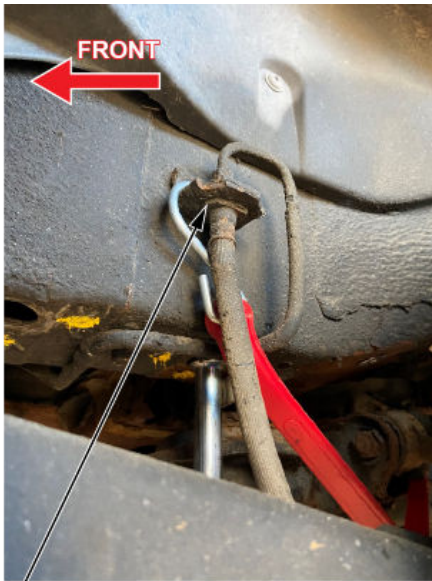

**BRAKE HOSE
BRACKET**



**WHEEL SPEED
SENSOR BRACKET**

3. RIGHT SIDE ONLY: Insert the additional black wash hose **530 mm (21 in)** into the frame opening located above over the exhaust silencer. Once inserted, push the hose in the direction shown below in red.

NOTE: The hose supplied should already be marked with a yellow indicator at **530 mm (21 in)** from the tip. However, if this mark is missing please measure **530 mm (21 in)** from the tip of the hose and mark this location with a piece of tape or permanent marker.



YELLOW MARKING

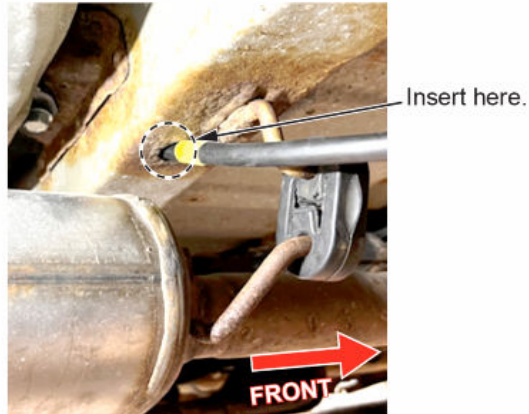

4. Position the quick connector fitting on the outside of the vehicle and secure it by placing the magnet on the outer sill.

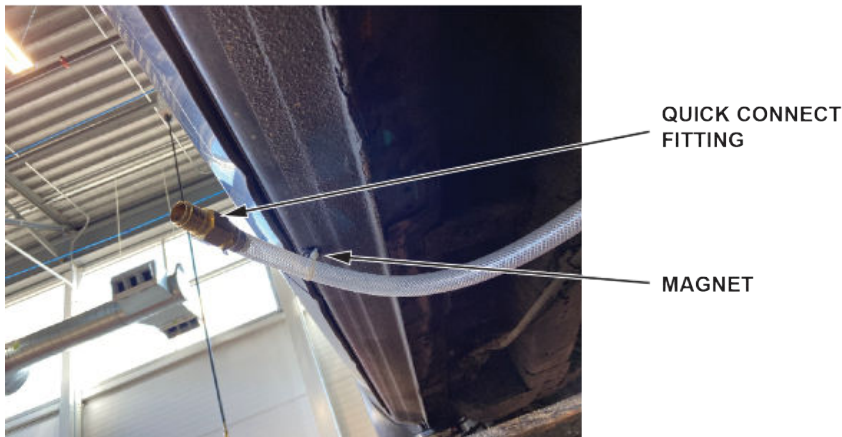

5. Wrap the second bungee cord around the wash hose(s) and place the hooks into any available vehicle frame openings.

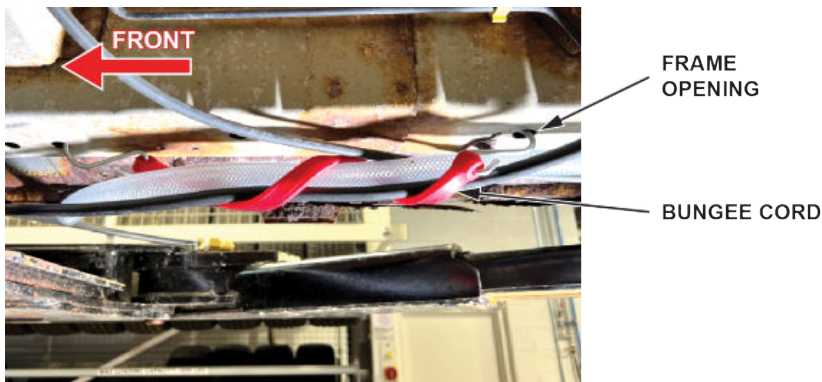

6. Repeat steps 1 through 5 on the opposite side.
7. Lower the vehicle.

NOTE: The wash tool was designed with magnets on the hoses so that the vehicle can be moved with the wash kit installed. If the shop doesn't have a drain or a hose nearby, move the vehicle to a location that does.
8. Attach a garden hose to the shop water connection and the supplied wash kit ball valve.
9. Connect the ball valve to the left side of the large clear wash hose and wash the rear frame for **5 minutes**.
10. Disconnect the ball valve and connect it to the right side, and wash the rear frame side of the vehicle for **5 minutes**.
11. Disconnect the ball valve and connect it to the smaller additional black hose, and wash it out for **2 minutes**.
12. Raise the vehicle and remove the wash kit and hoses.
13. remove the rear wheels.
14. Install the new fuel tank support bands. [Click Here for Video](#)

- 14.1. Remove the two exhaust hangers in front of the silencer from the body to gain additional clearance at the fuel tank.



- 14.2. Remove the 6 acorn nuts holding the heat shield onto the fuel tank support bands.



- 14.3. Remove the right side fuel tank support band rear bolt and discard the bolt.

NOTE:

- If the crossmember body crumbles and separates at any of the band rear bolt locations, refer to REPAIR PROCEDURE B for additional instructions.
- If the rear bolt does not come out, attempt to use heat to assist in removing the bolt. An induction heating tool is recommended. If the bolt spins freely and does not come out, refer to REPAIR PROCEDURE B for instructions.
- If REPAIR PROCEDURE B is not required fuel tank band repair plates can be discarded (Part #24 in reference table/image).

⚠ WARNING

DO NOT USE AN OPEN FLAME TOOL TO REMOVE ANY CORRODED BOLTS LOCATED IN CLOSE VICINITY TO THE FUEL TANK. An induction heating tool is recommended.



- 14.4. Remove the right side fuel tank support band front bolt and slide the support band out and discard the support band and bolt.

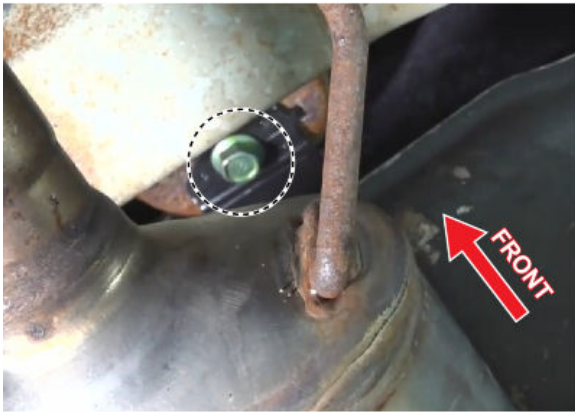

- 14.5. Slide the new right side fuel tank support band into position and install the new front support band bolt until snug.

NOTE:

Do not tighten the fuel tank support band front bolt to specification at this time.

- 14.6. Install the 3 acorn nuts onto the new right side fuel tank support band by hand. Do not tighten them to specification at this time.
- 14.7. Support the fuel tank with an underhoist stand.

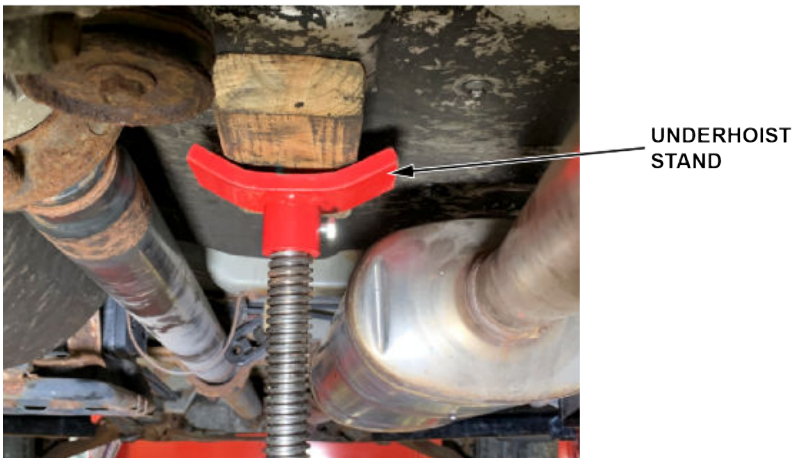

- 14.8. Remove the left side fuel tank support band rear bolt and discard the bolt.

NOTE:

- If the crossmember body crumbles and separates at any of the band rear bolt locations, refer to REPAIR PROCEDURE B for additional instructions• If the crossmember body crumbles and separates at any of the band rear bolt locations, refer to REPAIR PROCEDURE B for additional instructions.
- If the rear bolt does not come out, attempt to use heat to assist in removing the bolt. An induction heating tool is recommended. If the bolt spins freely and does not come out, refer to REPAIR PROCEDURE B for instructions.
- If REPAIR PROCEDURE B is not required fuel tank band repair plates can be discarded (Part #24 in reference table/image).

⚠ WARNING

DO NOT USE AN OPEN FLAME TOOL TO REMOVE ANY CORRODED BOLTS LOCATED IN CLOSE VICINITY TO THE FUEL TANK. An induction heating tool is recommended.

- 14.9. Remove the left side fuel tank support band front bolt and slide the support band out and discard the support band and bolt.

- 14.10. Using a ruler, measure 40 mm (1.5 in) from the tip of the wax canister spray tube and mark the wax canister spray tube at this point with a red permanent marker.



- 14.11. Make additional line marks at 130 mm (5 in) from the tip and at 5 additional marks at 50 mm (2 in) apart using a black permanent marker. There should now be 7 marks in total.

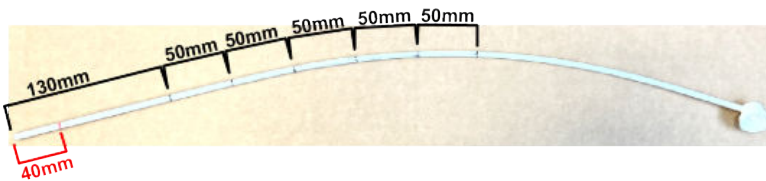

NOTE: Use a new canister spray tube for each vehicle.

- 14.12. If you have previously used this can of wax on another vehicle, weigh the can using the digital scale (T/N 07AAJ-SJCA200). [Click Here for Video](#)

Does the can weigh more than **140 g**?

Yes – There is a sufficient amount of wax, proceed to step 14.13.

No – There is an insufficient amount of wax, obtain a new can of wax.

NOTE:

- Weigh the can without the cap and canister spray tube.
- A new spray tube should be used for each new can, if you are using a used can make sure the nozzle is not blocked before applying wax.
- Used cans of wax must be weighed each time before applying the wax.
- A new can does not need to be weighed.

- 14.13. Insert the wax spray tube through the left side fuel tank support band front bolt hole outlined in green until it reaches the first red mark.

NOTE: Make sure the spray tube is inserted into the support band front bolt hole and not the hole adjacent to it.

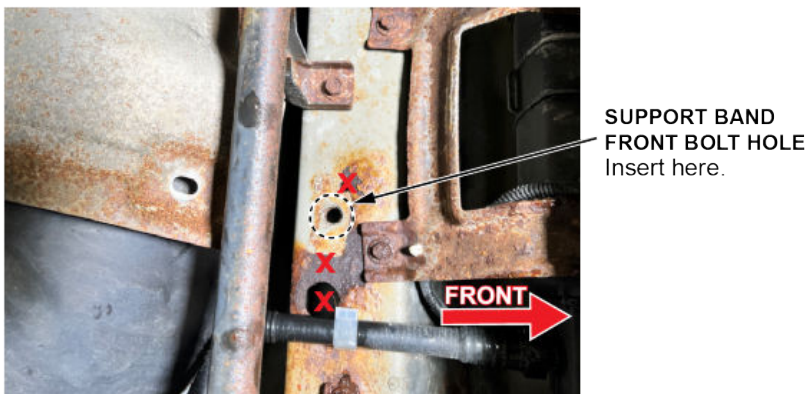

14.14.Spray the wax for **5 seconds** while rotating the tube in a circular motion.

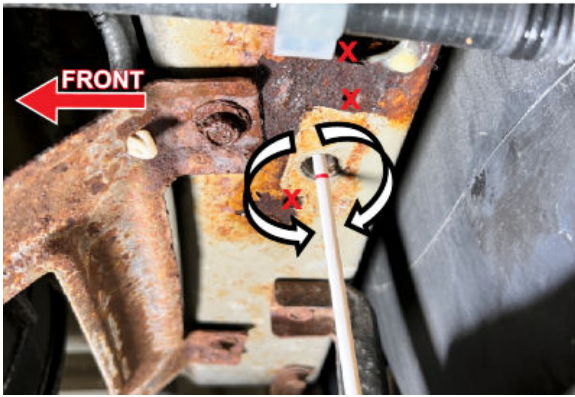

14.15.Remove the wax spray tube.

14.16.Slide the new left side fuel tank support band into position and install the new front support band bolt until snug.

NOTE: Do not tighten the fuel tank support band front bolt to specification at this time.

14.17Install the **3** acorn nuts onto the new left side fuel tank support band by hand. Do not tighten them to specification at this time.

15. Install new rear fuel tank cushions.

15.1. To gain access to the upper side of the fuel tank, slightly lower the fuel tank with the underhoist stand while still supporting the fuel tank. Remove the existing rear fuel tank cushions from the top of the tank.

NOTE:

- **Be careful not to separate the fuel filler neck when lowering the fuel tank as fuel may leak out.**
- The rubber cushions are secured with an adhesive and can be peeled off.
- Ensure that both rear cushions are removed, one from each of the rear sides.
- Discard the original cushions.

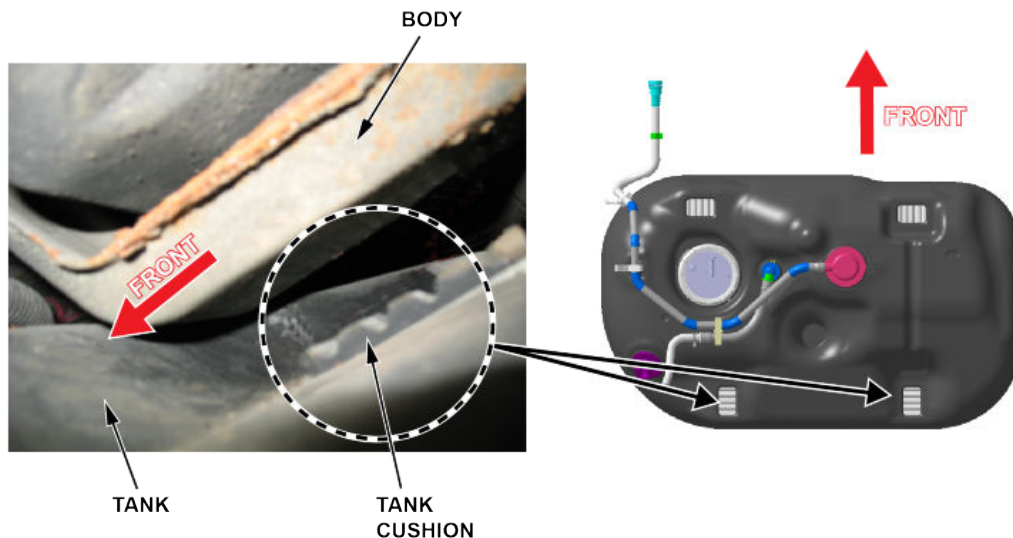

15.2. Install the new fuel tank cushions included in the parts kit by using the clips to secure them to the upper panel on both sides as indicated below.

NOTE: Ensure the new cushion is lined up with the groove in the fuel tank and flat edge is lined up with body panel flange.

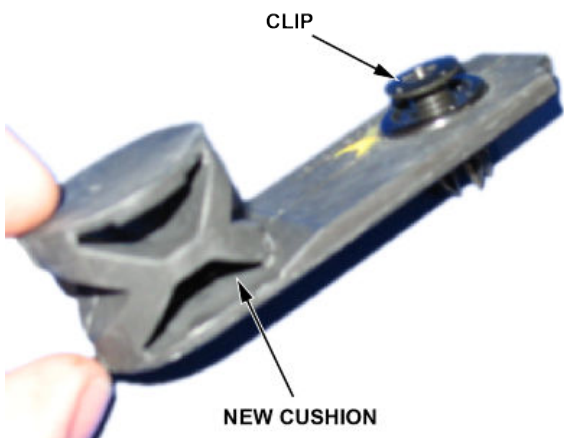

DRIVER'S SIDE



TANK CLIP HOLE

PASSENGER'S SIDE



CLIP HOLE TANK



Cushion aligns to body panel flange.

FUEL TANK CUSHION CLIP

16. Install supplied stickers on the openings of the crossbar.

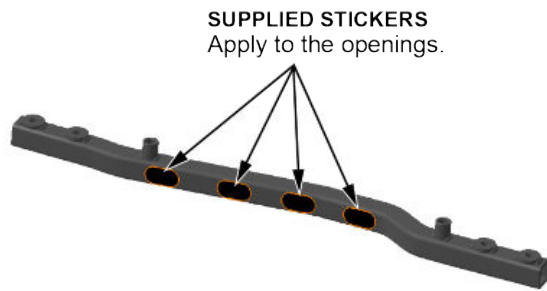

17. Install the new crossbar.

17.1. Raise the fuel tank using the under hoist stand.

17.2. Insert the new crossbar from the passenger side by holding the bar with the S-bend on the passenger side, the spacers facing down, and the "UP" engravings facing the rear of the vehicle.

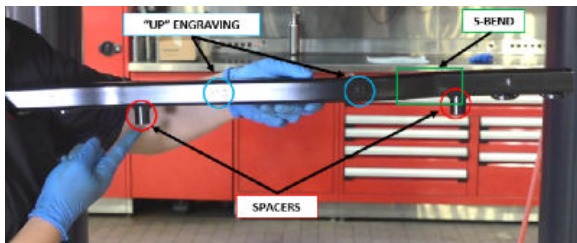

17.3. Insert the crossbar over the rear propeller shaft u-joint. Once the first crossbar spacer is over the u-joint, rotate the crossbar 180 degrees so that both spacers are facing up.



17.4. Slide the crossbar completely into position.

17.5. Make sure the fuel tank is in the correct position, confirm the fuel tank is not touching the body on the sides of the tank and that the new cushions are sitting in the indent in the fuel tank.

17.6. Install new rear fuel tank band bolts by hand; these are included in the parts kit and are longer than the ones you removed.

NOTE:

Tighten the bolts and then back them off half a turn. Do not tighten the bolts to specification at this time.

17.7. The fuel tank support bands are to be “sandwiched” between the crossbar and the C-Cross member as shown below.

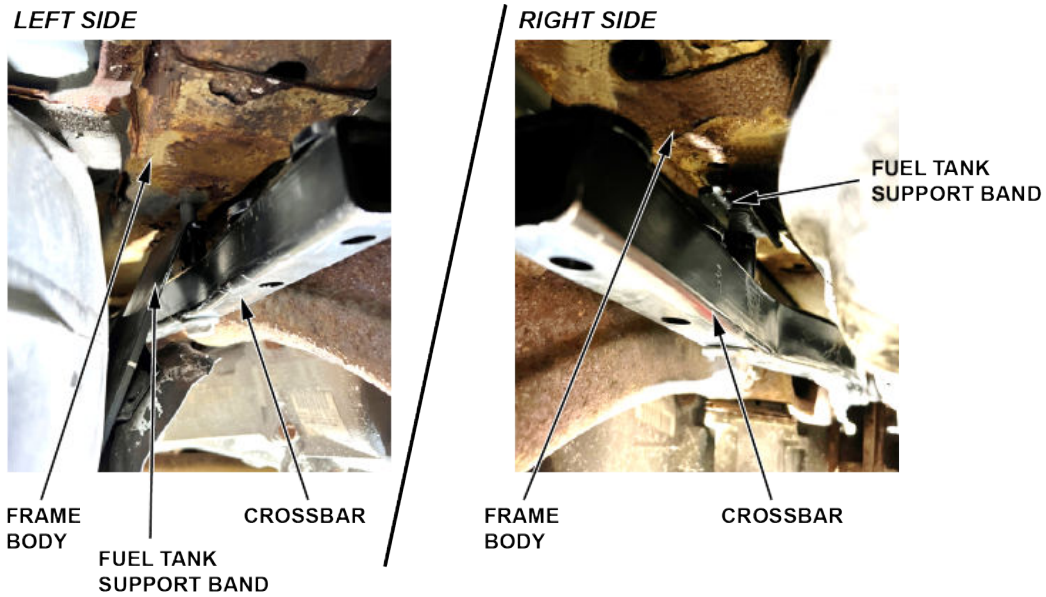

17.8. Remove the underhoist stand.

17.9. Check and ensure that the fuel filler neck tube is properly attached.

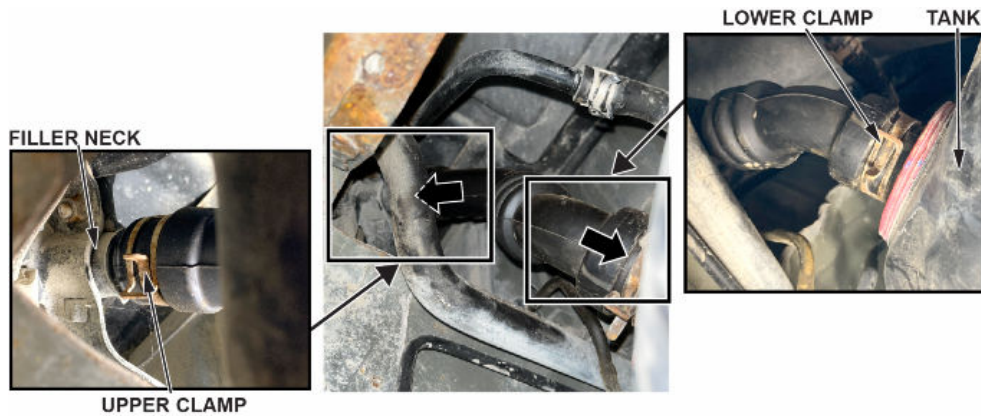

Subframe Casting Installation:

18. Prepare the frame rail on both sides for the underbody coating application which is to be applied later. [Click Here for Video](#)

18.1. Clean any loose dirt and/or rust from the lower surface of the frame rail where the new casting is going to mount to the body.

18.2. Clean the surface using a nylon brush. Use brake cleaner as needed and wipe dry afterwards.

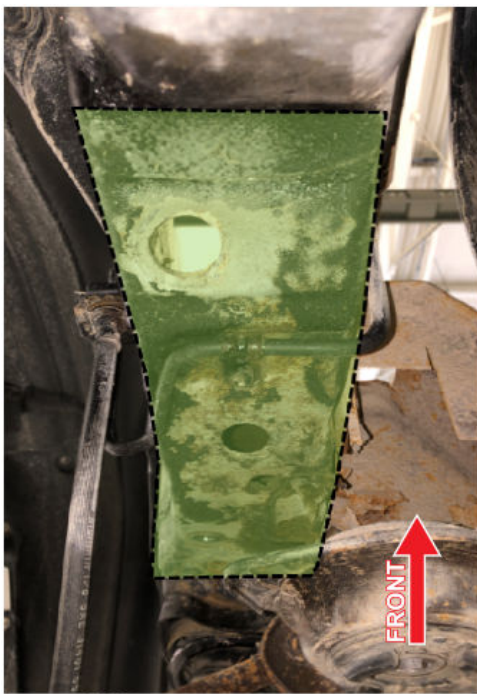

 = CLEANING AREA

19. Install the frame washer inserts and carriage bolts.

20. Assemble the frame insert washers, carriage bolts, and guide wires as shown below.

NOTE:

- Ensure the guide wires are fully attached to the bolts.
- Ensure the engraving "THIS SIDE UP" on the washer is facing up.

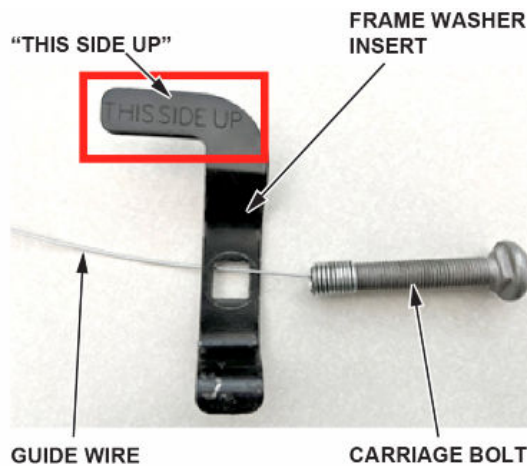

21. Insert the washers and carriage bolts into the existing frame holes shown below.

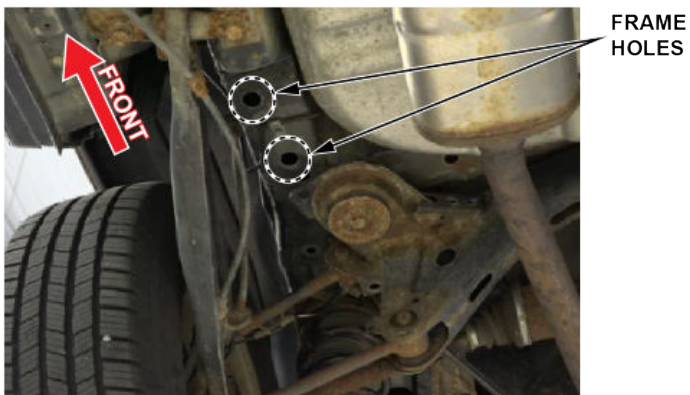

22. Use the guide wires to push the carriage bolts into the holes first and then insert the washers.

NOTE: Be sure the engraving "THIS SIDE UP" on the washer is facing up.

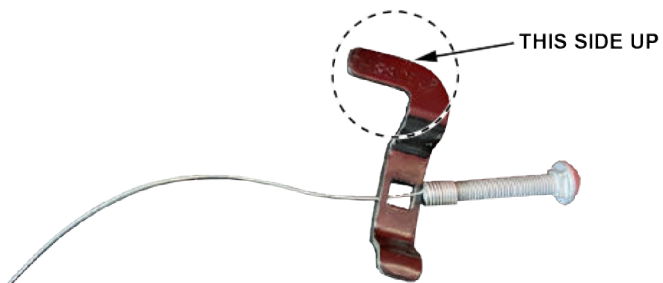

23. Once the washer is fully seated in the frame cavity, carefully pull the carriage bolt back down through the washer and the hole using the guide wire.

NOTE:

- The flat part of the washer must face down and sit on the floor of the frame cavity.
- Try to spin the carriage bolt in order to ensure the square shoulder is seated into the square hole of the washer.

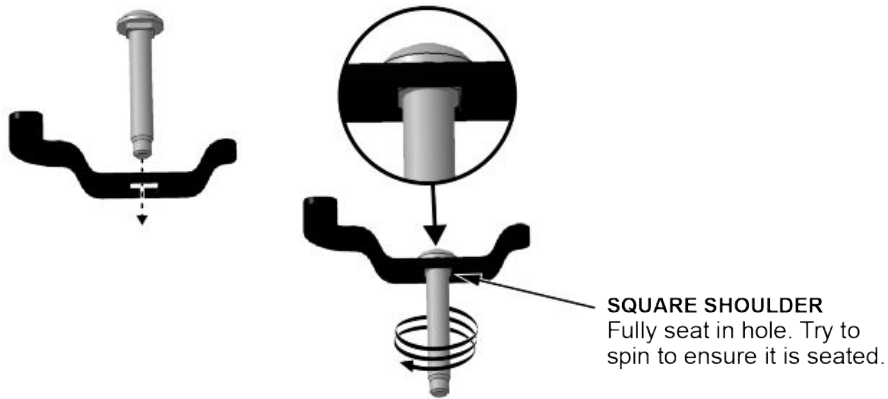

24. Remove the guide wires and set them aside for use on the other side.

25. Thread the black spacer nut (thicker) onto the front carriage bolt. Thread the silver spacer nut (thinner) onto the rear carriage bolt closer to the subframe mount.

NOTE: Do not use power tools to thread the nuts.

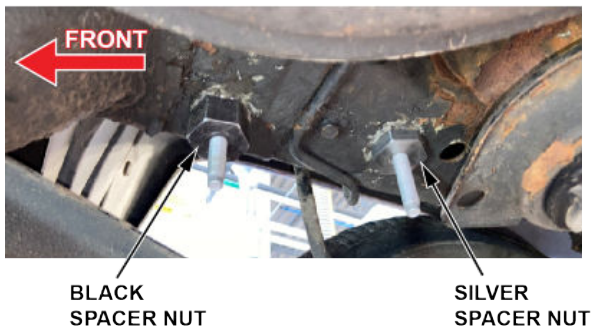

NOTE: Make sure the circular lip of the spacer nut faces up and aligns with the holes in the frame.

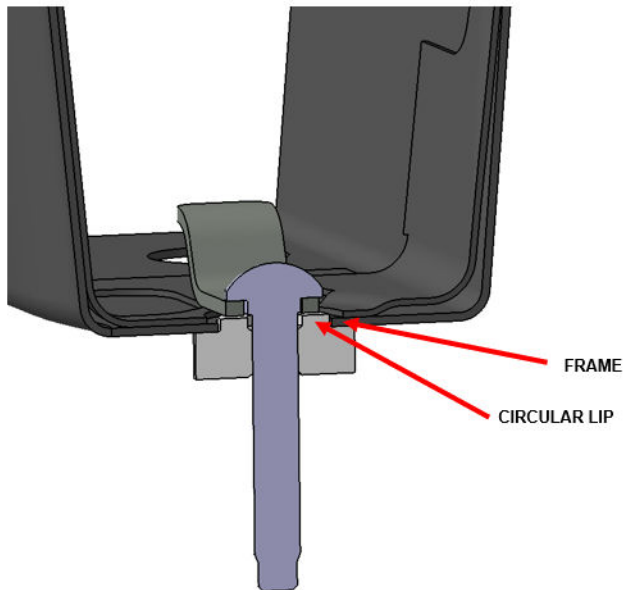

26. Tighten both nuts to **35 N.m (26 ft lb)**.
27. Repeat steps 19 through 26 on the opposite side of the vehicle.
28. Support the rear differential at the transfer flange using an underhoist stand.

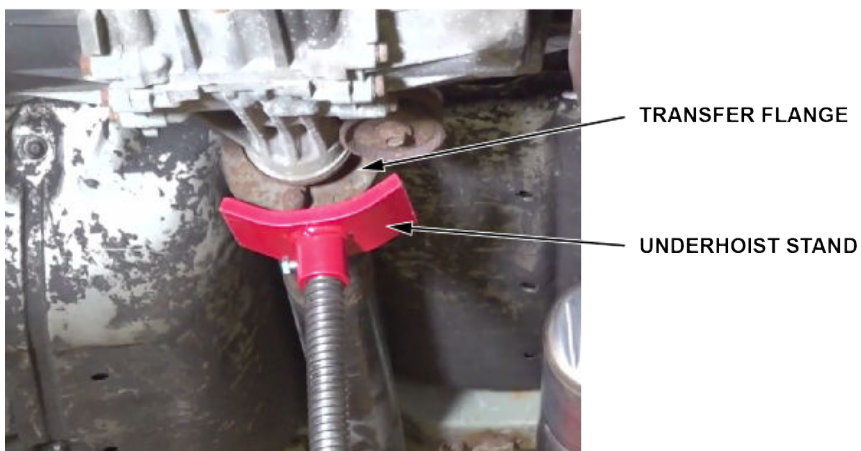

29. Remove both of the C-point subframe mounting bolts.

NOTE:

- Discard the original C-point subframe bolts and washers.
- If any of the bolts appears to be visually separated from the body, attempt to remove that bolt first.
- If the bolt does not come out, attempt to use heat to assist in removing the bolt. An induction heating tool is recommended.
- If the subframe bolt breaks or if the body breaks during removal, allowing the collar to spin, refer to REPAIR PROCEDURE C for additional instructions.

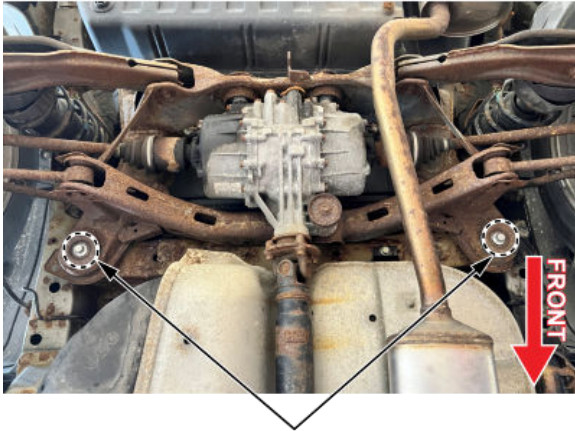

C-POINT SUBFRAME MOUNT BOLTS

30. Secure the supplied drill guide into the hole on the subframe casting using the supplied bolt.

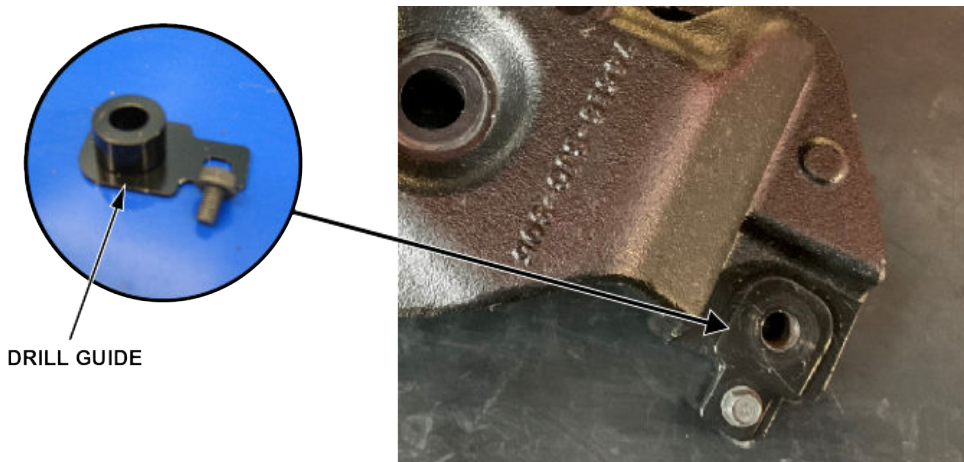

DRILL GUIDE

31. Install the subframe casting and hand tighten the new C-point subframe bolt and carriage bolt nuts. Do not torque the fasteners at this time.

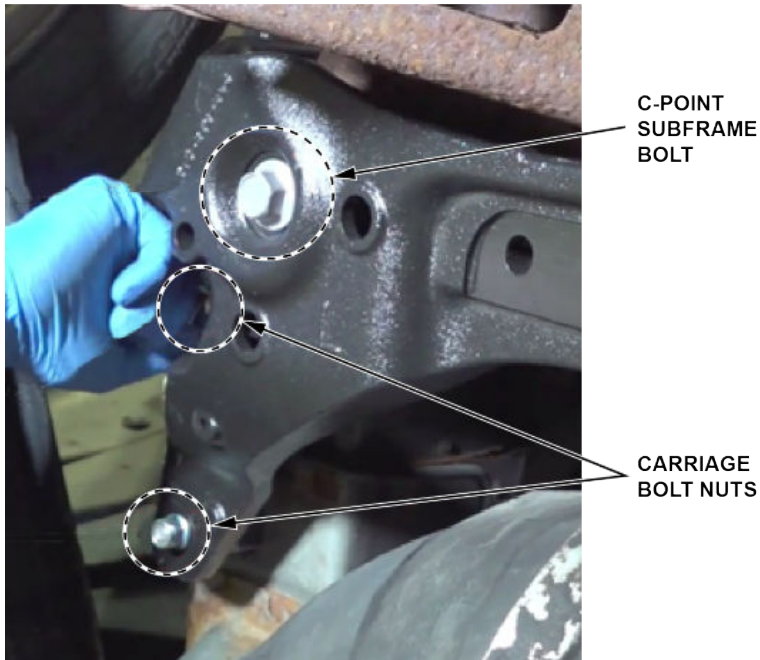

32. Install the crossbar end bolts by hand. Do not torque the bolts at this time.



33. Repeat steps 31 through 32 on the opposite side of the vehicle.

34. Tighten the following bolts on both sides of the vehicle in the sequence listed below.

1. Rear fuel tank band bolts (33 N.m, 24 lb-ft).
2. Carriage bolt nuts (33 N.m, 24 lb-ft).
3. C-point subframe bolts (95 N.m, 70 lb-ft).
4. Crossbar end bolts (33 N.m, 24 lb-ft).
5. Front fuel tank band bolts (65 N.m, 48 lb-ft).
6. Fuel tank heat shield acorn nuts (9.8 N.m, 7.2 lb-ft).

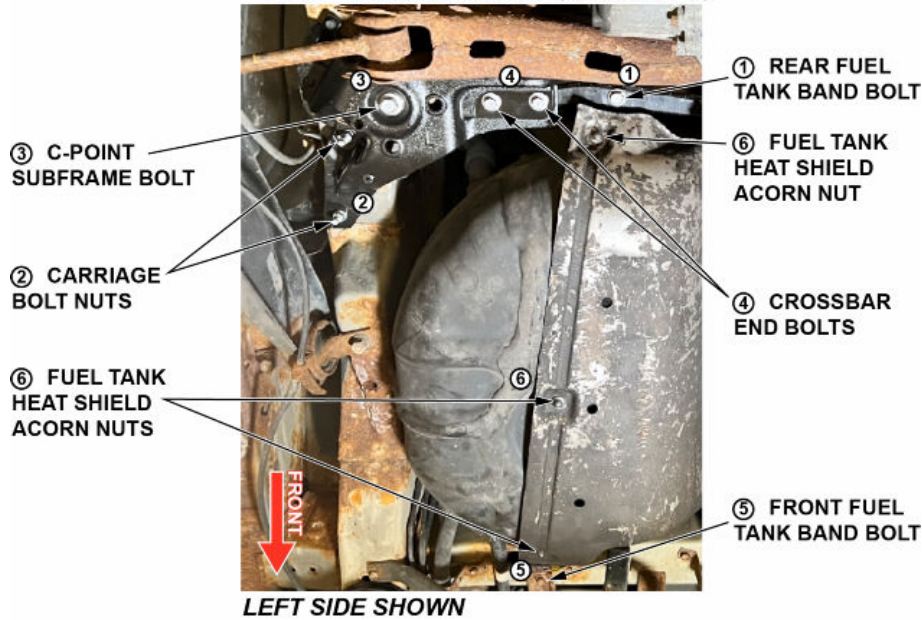

35. Remove the underhoist stand.

36. Install the rivnut.

36.1. Using the 7/16" drill bit included in the kit, drill through the hole through the body panel using the drill guide.

NOTE: Ensure the drill guide is installed prior to drilling.

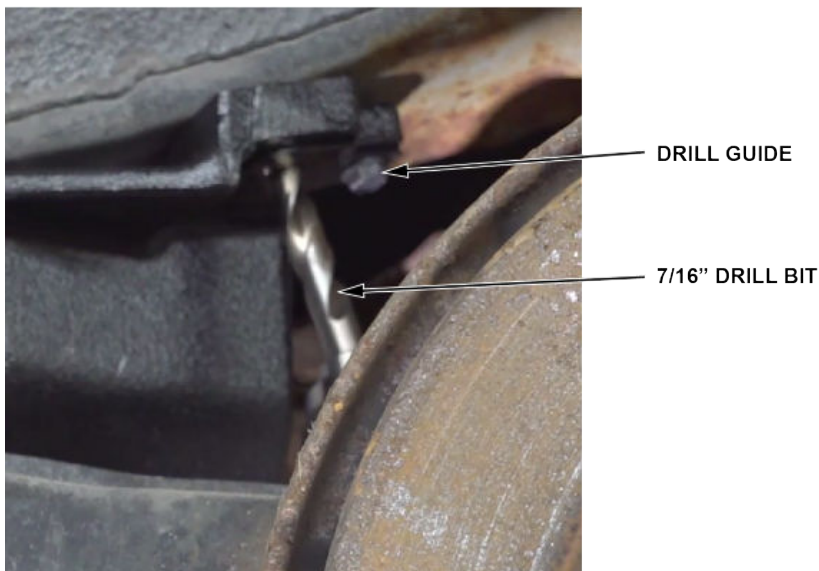

36.2. Remove the drill guide from the subframe casting.

36.3. Setup the special rivnut tool (T/N 07AAE-SJCA100).



36.4. Thread the rivnut onto the mandrel until the threads are flush with the tip of the rivnut.

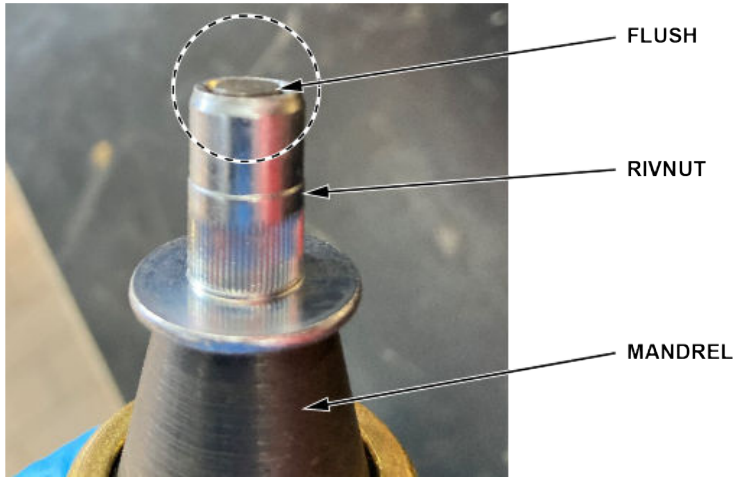

36.5. Tighten the cone of the tool until it contacts the rivnut flange.

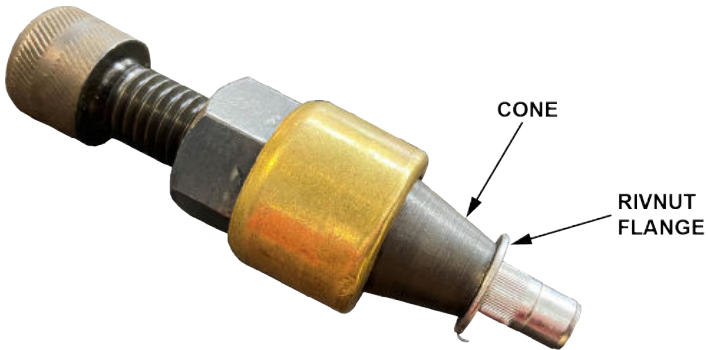

36.6. Insert the rivnut and tool into the hole which was drilled in the previous step.

36.7. Using the allen key, apply an upward force to ensure the rivnut is seated completely into the hole in the body panel.

NOTE: You can rest the allen key against the trailing arm or subframe.

36.8. Tighten the large nut on the rivnut tool using a **27mm** wrench until the nut becomes noticeably tight (Approximately **1 and 3/4** of a turn of the large nut on the rivnut tool).

NOTE:

- Make sure not to overtighten the large nut as it may result in damage to inner threads of the rivnut.
- Ensure the rivnut is seated completely into the hole prior to tightening the nut on the rivnut tool.

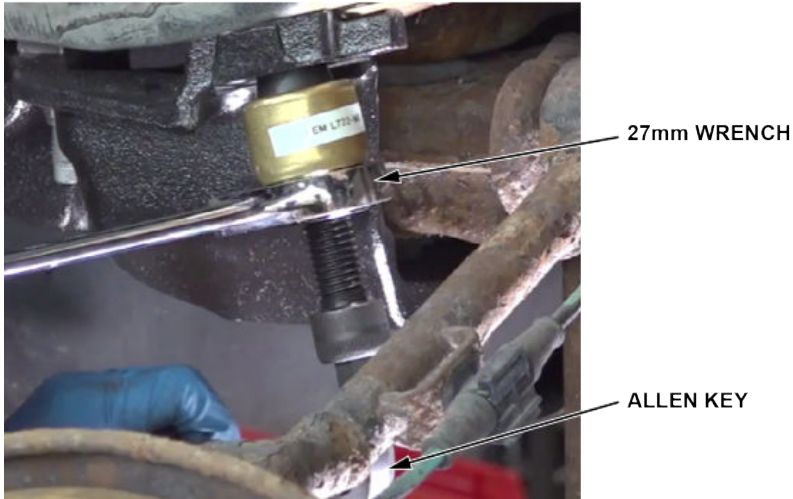

36.9. Loosen the **27mm** nut and remove the tool from the installed rivnut by turning the allen bolt counter-clockwise.

36.10. Install the drill guide back into the subframe casting using the supplied bolt.

36.11. Install the new bolt and tighten it to **20 N.m (15 ft lb)**.

NOTE: If the bolt continues to spin when attempting to torque it to specification, continue tightening the bolt as the rivnut may not have been completely seated during installation. Tightening the bolt will allow the rivnut to completely set into the frame allowing the bolt to reach it's torque specification.

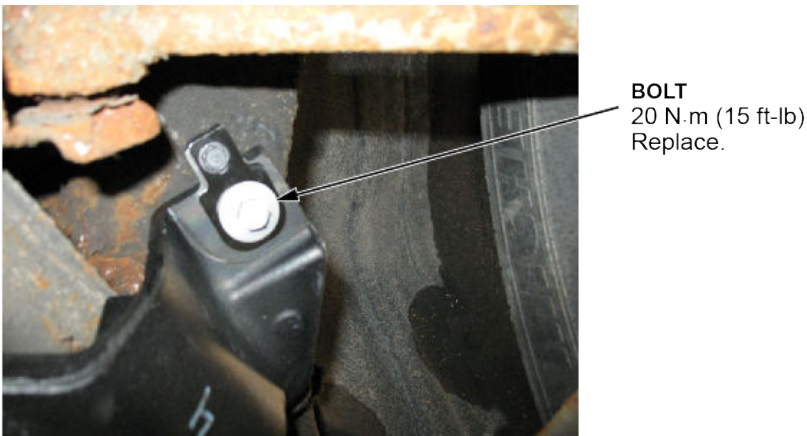

36.12. Repeat step 36 on the opposite side of the vehicle.

37. Install the exhaust hangers.

Wax Application Procedure

NOTE: An entire can of Noxudol® wax can be used for 2 vehicles. [Click Here for Video](#)

38. If you have previously used this can of wax on another vehicle, weigh the can using the digital scale (T/N 07AAJ-SJCA200).

Does the can weigh more than **200 g**?

Yes – There is a sufficient amount of wax, proceed to step 25 and wax one side.

No – There is an insufficient amount of wax, obtain a new can of wax.

NOTE:

- Weigh the can without the cap and canister spray tube.
- A new spray tube should be used for each new can, if you are using a used can make sure the nozzle is not blocked before applying wax.
- Used cans of wax must be weighed each time before applying the wax.
- A new can does not need to be weighed and can be used for both sides.

39. Insert the spray tube through the rear wash hole indicated below in red until you've reached the final black mark on the tube.

NOTE:

- Insert the tube from the wheel well horizontally and push it towards the front of the vehicle.
- If there is any resistance felt when inserting the spray tube, the tube may be wedging against the inner sides of the frame rail. Remove the spray tube and re-insert until there is no resistance felt.



Insert here.

40. Spray the wax for 5 seconds while swaying the tube side to side within the slot.

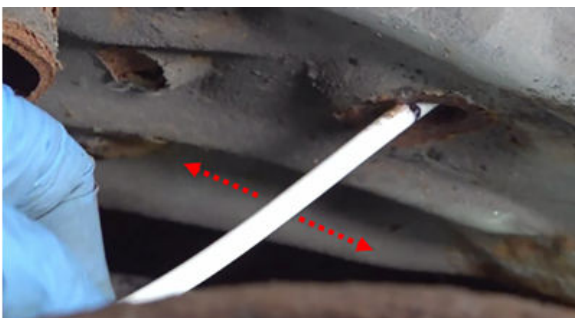

41. Pull the tube out **50mm** to the next mark and repeat step 40.

42. Repeat steps 40 and 41 until the last black mark on the tube has been reached which represents the 6th wax application. (6 sprays in total).

NOTE: DO NOT spray wax at the red mark.

43. If you were using a used can, weigh the can of wax again to determine if the wax can be used on the other side of the vehicle.

Does the can weigh more than **200 g**?

Yes – There is a sufficient amount of wax, proceed to step 30 and wax the other side.

No – There is an insufficient amount of wax, get a new can of wax.

44. Repeat steps 39 to 42 on the opposite side of the vehicle.

45. If this was the first time using this can of wax, using a permanent marker to mark the can with “1/2 can” so that it may be used on another vehicle.

Under-Body Coating (UBC) Application Procedure

46. Using aluminum foil, cover the rubber brake hose to protect it from any possible over-spray. [Click Here for Video](#)

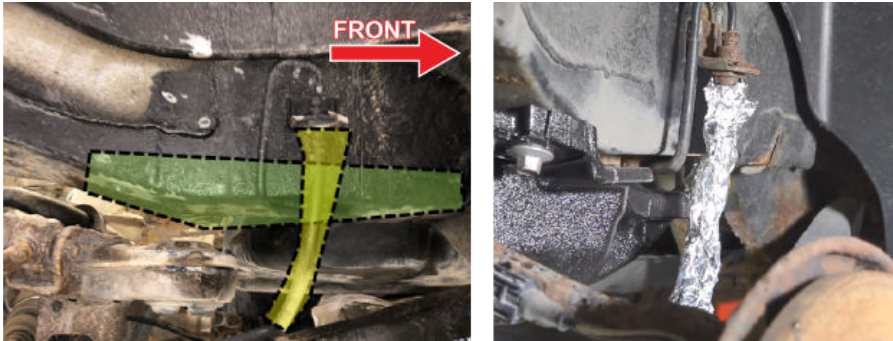

47. The UBC has to seal the contact surface between the casting and the frame rail. The coating will be applied around the casting as shown below in red. Clean these areas with compressed air.

48. Spray the UBC from both angles, the side and bottom of the frame rail, to achieve sufficient coverage between the casting and body panel.

NOTE: Make sure to follow manufacturers recommendation for mixing of the product prior to application.



49. Repeat steps 46 through 48 on the opposite side of the vehicle.

50. Remove the aluminum foil.

NOTE: Instruct customer to avoid driving the vehicle through a car wash for the next **2-3 days**.

51. Re-install both rear wheels and torque them to specification.

52. The repair is complete.

REPAIR PROCEDURE B

To watch fuel tank support band bolt procedure [Click Here](#).

NOTE: This repair should only be done if the fuel tank support band rear bolt spins freely or cannot be removed, or if the crossmember body crumbles and separates at any of the band rear bolt locations. Additionally, if the new fuel tank band rear bolt spins and cannot be torqued to specification this repair should be done.

1. Support the fuel tank using an underhoist stand between the propeller shaft and exhaust silencer.

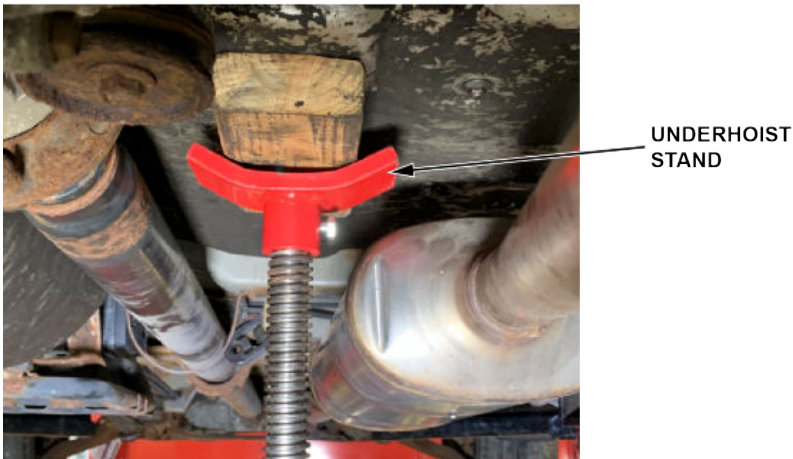

2. Using a body-saw or chisel, remove the crossmember body portion outlined in red from around the fuel tank support band rear mount.

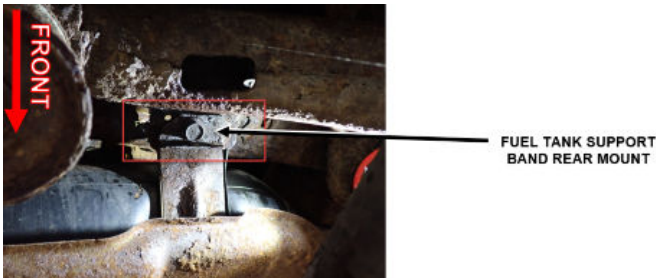

- Clear enough space to allow the tank band repair plate to fit within the frame.

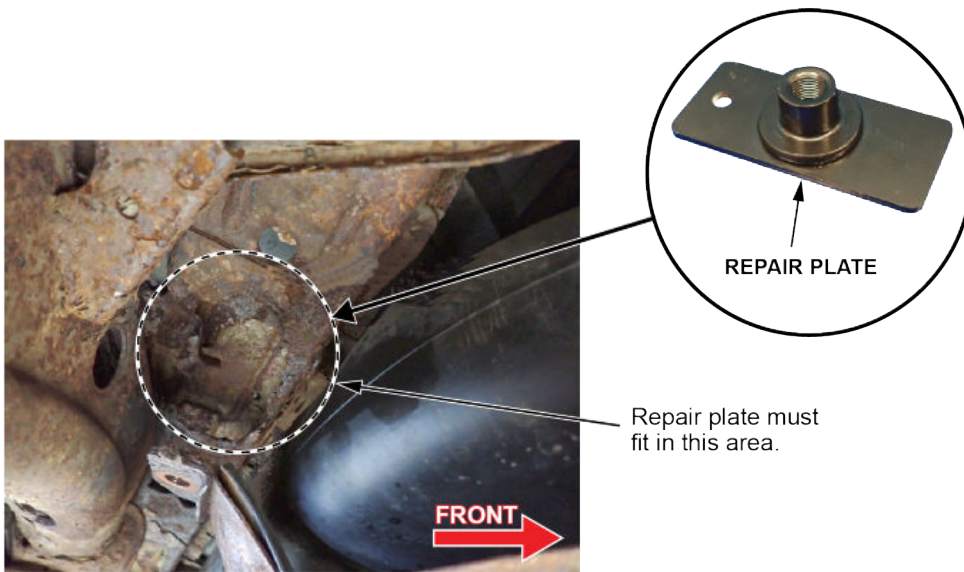

- If necessary, perform steps 1-3 for the other fuel tank support band mount. If not, remove the fuel tank support band and rear bolt.
NOTE: If the other fuel tank support band does not require the repair, the additional repair plate can be discarded.
- Remove the fuel tank support bands front bolts and slide the support bands out.
- Using a measuring tape or ruler, measure **40 mm (1.5 in)** from the tip of the wax canister spray tube and mark the wax canister spray tube at this point with a red permanent marker.



- Make additional line marks at **130 mm (5 in)** from the tip and at five additional marks **50 mm (2 in)** apart using a black permanent marker. There should now be seven marks in total.

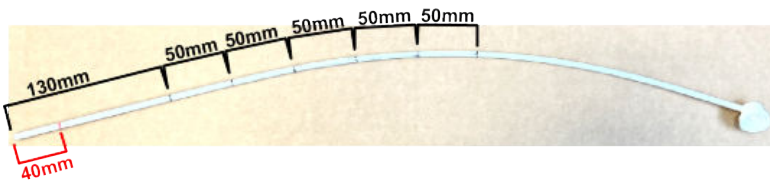

8. LEFT SIDE ONLY: Wax the fuel tank support band front bolt mount.

If you have previously used this can of wax on another vehicle, weigh the can using the digital scale (T/N 07AAJ-SJCA200).

Does the can weigh more than **140 g**?

Yes – There is a sufficient amount of wax go to step 9.

No – There is an insufficient amount of wax, get a new can of wax.

NOTE:

- Weigh the can without the cap and canister spray tube.
 - A new spray tube should be used for each new can of wax, if you are using a used can make sure the nozzle is not blocked before applying wax.
 - Used cans of wax must be weighed each time before applying the wax.
 - A new can does not need to be weighed.
9. Insert the wax spray tube through the left side fuel tank support band front bolt hole until it reaches the red mark.
- NOTE: Make sure the spray tube is inserted into the support band front bolt hole and not the hole next to it.



SUPPORT BAND
FRONT BOLT HOLE
Insert here.

10. Spray the wax for **5 seconds** while rotating the tube in a circular motion.

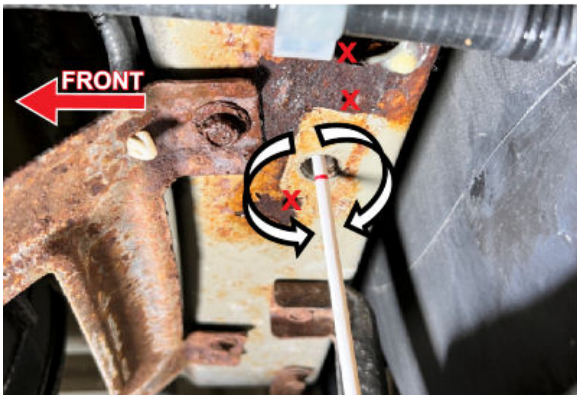

11. Remove the wax spray tube.
12. Install new rear fuel tank cushions.

13. To access to the upper side of the fuel tank, slightly lower the fuel tank with the underhoist stand while still supporting the fuel tank. Remove and discard the existing rear fuel tank cushions from the top of the tank.

NOTE:

- The rubber cushions are secured with an adhesive and can be peeled off.
- Make sure both rear cushions are removed, one from each of the rear sides.
- Discard the original cushions.

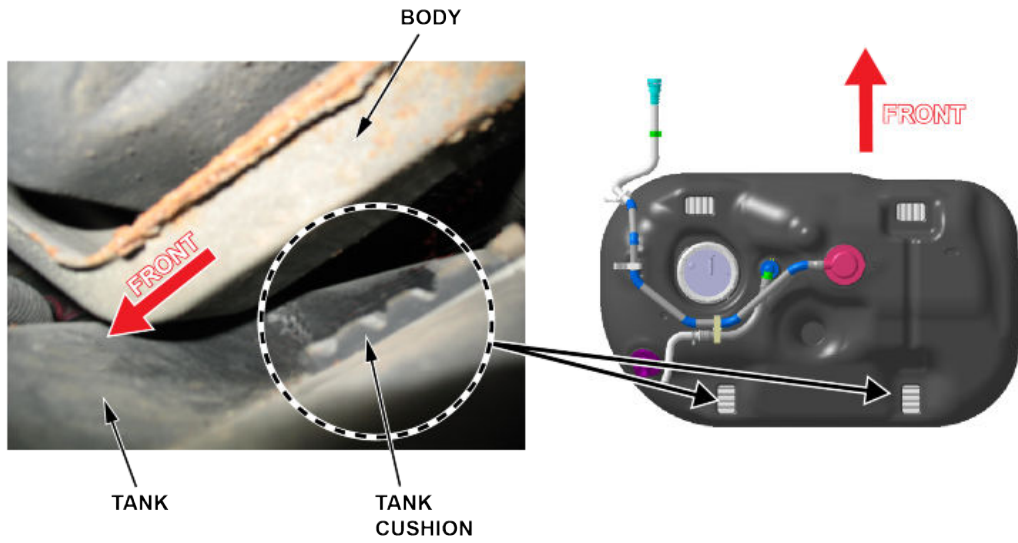

14. Install the new fuel tank cushions included in the parts kit by using the clips to secure them to the upper panel as indicated below.

NOTE: Make sure the new cushion is lined up with the groove in the fuel tank and the flat edge is lined up with body panel flange.

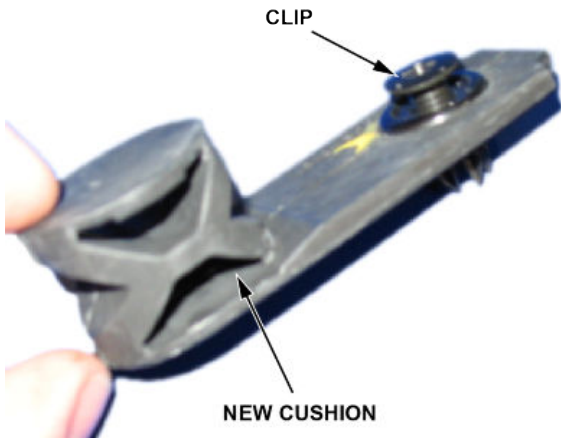

DRIVER'S SIDE

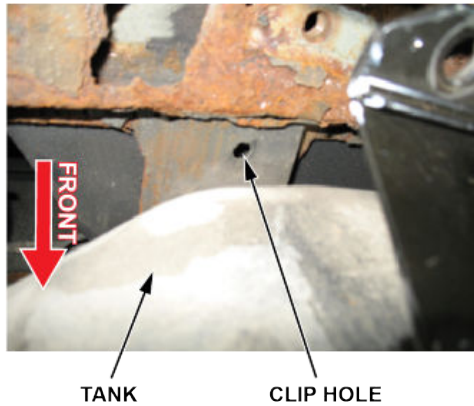

PASSENGER'S SIDE

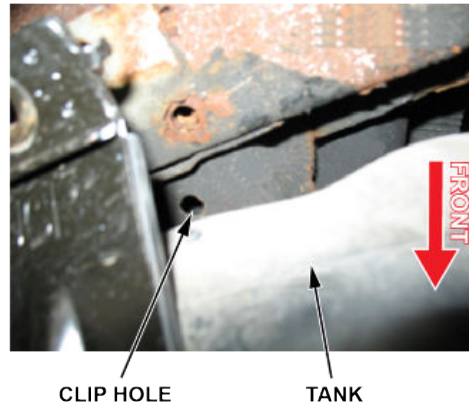

15. Slide the new fuel tank support bands into position and raise the fuel tank back into position using the underhoist stand.

16. Install the fuel tank support band front bolts.

NOTE: Do not tighten the bolts to specification at this time.

17. Loosely install the fuel tank heat shield acorn nuts. Do not tighten the nuts to specification at this time.

18. Install supplied stickers on the openings of the crossbar.

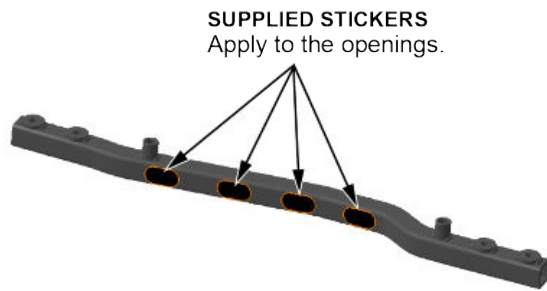

19. Install the new fuel tank brace crossbar.

19.1. Raise the fuel tank using the underhoist stand.

19.2. Insert the new crossbar from the passenger side by holding the bar with the S-bend on the passenger side, the spacers facing down, and the "UP" engraving facing the rear of the vehicle.

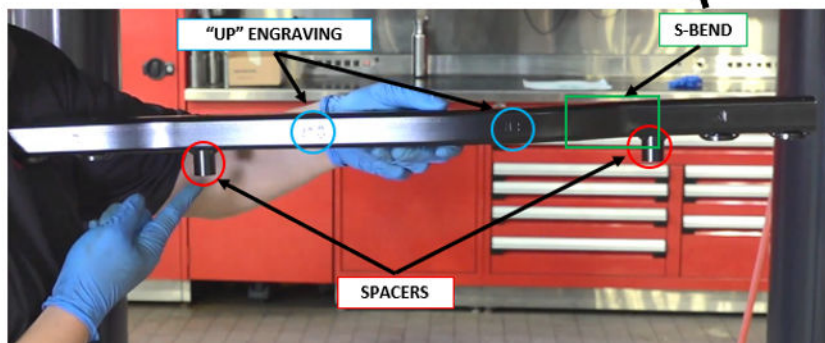

19.3. Insert the crossbar over the rear propeller shaft u-joint. Once the first crossbar spacer is over the u-joint, rotate the crossbar **180 degrees** so that both spacers are facing up.



19.4. Slide the crossbar completely into position.

19.5. Make sure the fuel tank is in the correct position, confirm the fuel tank is not touching the body on the sides of the tank and that the new cushions are sitting in the indent in the fuel tank.

19.6. Position the repair plates above the fuel tank support bands.

NOTE: The driver's side repair plate alignment hole faces inboard and the passenger side alignment hole faces outboard.

19.7. The fuel tank support bands are to be pressed between the crossbar and the repair plate as shown below.

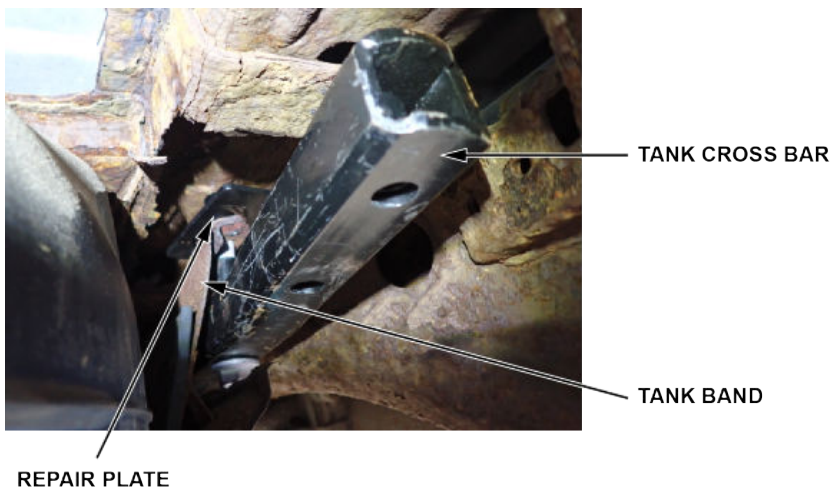

19.8. Install new rear fuel tank band bolts by hand; these are included in the parts kit and are longer than the ones you removed.

NOTE:

- Make sure the fuel tank band tab is set into the repair plate hole and the bolt is snug. This prevents the repair plate from spinning when tightening the bolt later.
- Tighten the bolts and then back them off half a turn. Do not tighten the bolts to specification at this time.

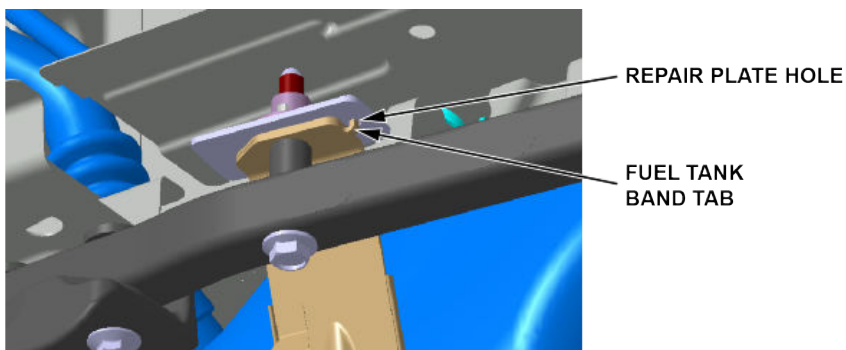

19.9. Remove the underhoist stand.

19.10 Make sure that the fuel filler neck tube is properly attached.



20. Proceed to Repair Procedure A Step 18, to continue the repair.

REPAIR PROCEDURE C

To watch C-point subframe mount procedure [Click Here](#).

NOTE:

- This repair should only be performed if the C-point subframe mount is partially or completely dislodged from the body or when the C-point subframe mount bolt spins and cannot be removed or torqued to specification.
 - This sequence should be done before installing the subframe casting.
 - Prepare the specific body panel area to allow for the repair plate addition.
1. Using an air chisel or air saw, remove a portion of the body panel as indicated in green to allow access to the bolt top end and its frame collar.

NOTE: Do not remove any body material from the area indicated in red. If this area is altered, the structural integrity of the vehicle will become compromised.

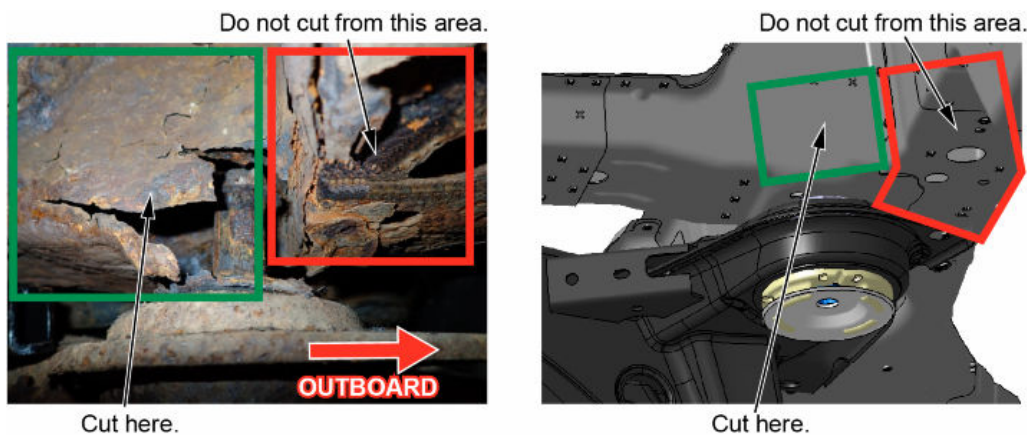

2. Once the collar is exposed, use Vice Grips to hold the collar and unscrew the bolt.

NOTE: Induction heat may be needed to assist in the removal.

WARNING: DO NOT USE AN OPEN FLAME TOOL TO REMOVE ANY CORRODED BOLTS LOCATED IN CLOSE VICINITY TO THE FUEL TANK. An induction heating tool is recommended.

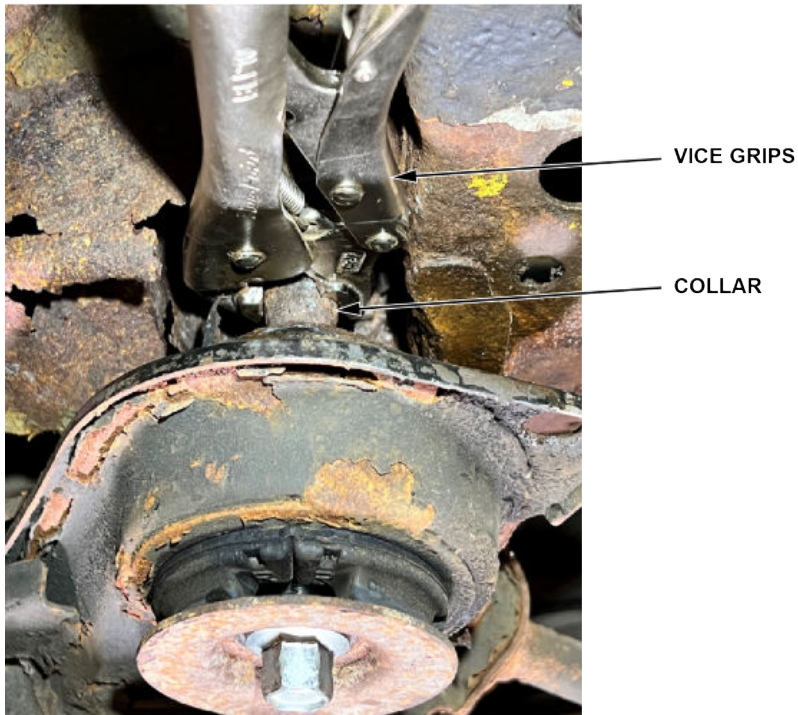

3. Install the new repair plate.

- 3.1. Once the old bolt and collar are removed, clean the area inside the frame of any debris.

NOTE:

- Make sure there is no debris on the top of the subframe bushing where the repair plate mates.
- Replace the rubber subframe mount insulator if it was cut/torn through.

- 3.2. Fit the C-point repair plate in the body.

NOTE: Orient the alignment hole on the repair plate towards the outside of the vehicle.

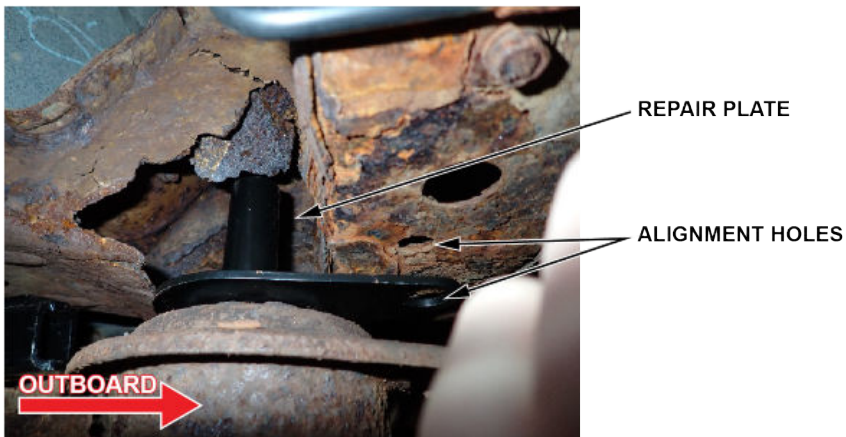

- 3.3. Remove any additional body material as needed to fit the repair plate using an air chisel or air saw.

4. Do steps 1- 3 on the other side if required.

NOTE: If the other subframe C-point does not require the repair, the additional repair plate should be discarded.

5. Go to REPAIR PROCEDURE A Step 30 to continue the repair.

NOTE:

- When tightening the C-point subframe mount bolt, use a ratchet extension or similar through the alignment holes on the subframe, the repair plate, and the body datum to keep the repair plate from spinning.
- You can clamp a vise grip on the ratchet extension to hold it in place.



BODY DATUM

REPAIR PLATE

SUBFRAME

EXTENSION

END