

# TECHNICAL INSTRUCTIONS

FOR

## SPECIAL SERVICE CAMPAIGN 22TC05

### Crankcase Case Vent

**Certain 2022 Model Year Camry  
Certain 2022 Model Year Camry Hybrid  
Certain 2021-2022 Model Year Rav4  
Certain 2021 Model Year Rav4 Hybrid  
Certain 2022 Model Year Avalon Hybrid  
Certain 2022 Model Year Highlander Hybrid  
Certain 2022 Model Year Sienna Hybrid**

**The repair quality of covered vehicles is extremely important to Toyota. All dealership technicians performing this special service campaign are required to successfully complete the most current version of the E-Learning course “Safety Recall and Service Campaign Essentials”. To ensure that all vehicles have the repair performed correctly; technicians performing this special service campaign repair are required to currently have completed all of the following courses:**

**-T151 – Engine Service and Repair**

**It is the dealership’s responsibility to select technicians that have completed the above courses to perform this campaign repair. Carefully review your resources, the technician skill level, and ability before assigning technicians to this repair. It is important to consider technician days off and vacation schedules to ensure there are properly trained technicians available to perform this repair at all times.**

## OPERATION FLOW CHART

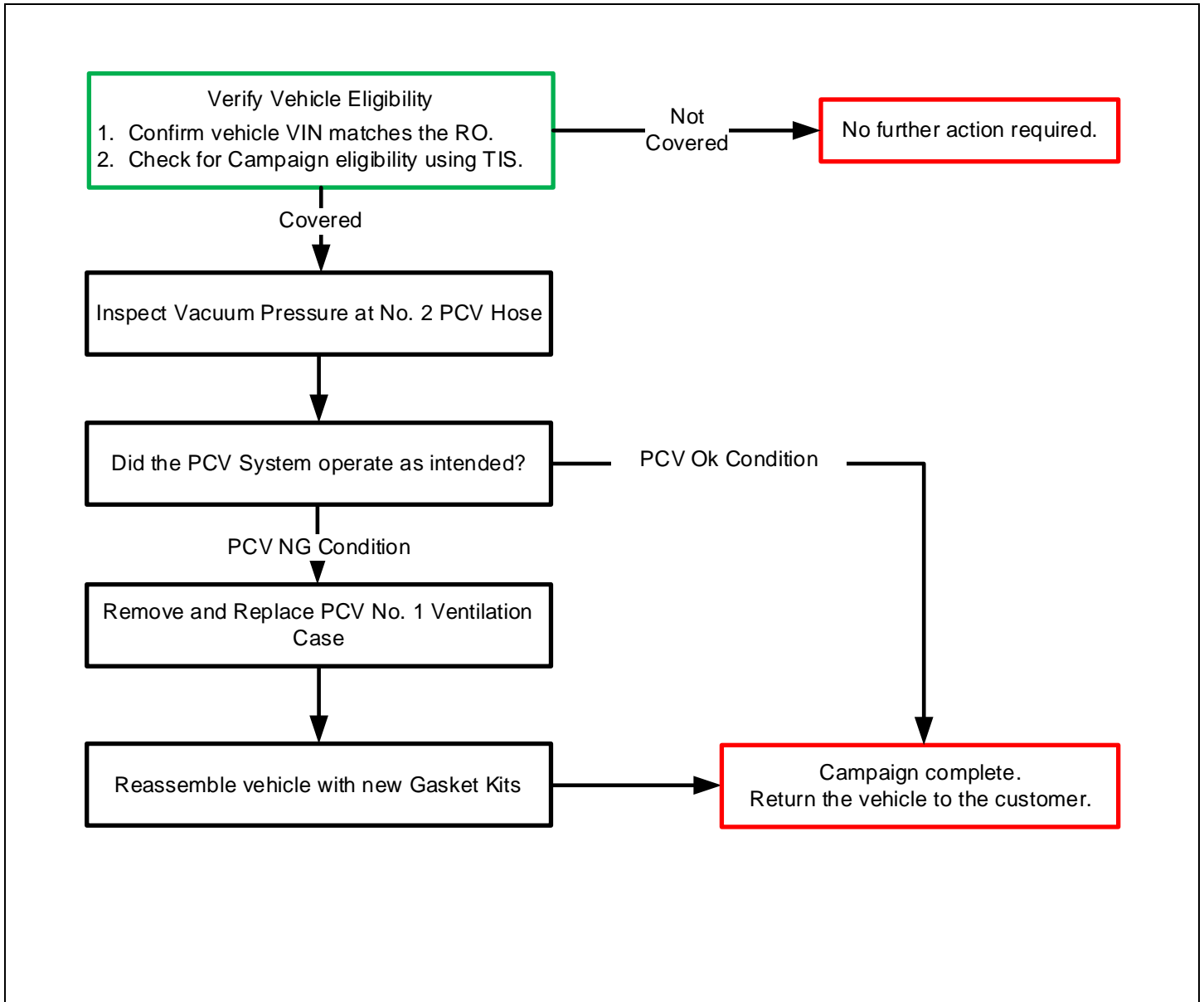

## I. IDENTIFICATION OF AFFECTED VEHICLES

### 1. CHECK VEHICLE FOR CAMPAIGN ELIGIBILITY

- Compare the vehicle's VIN to the VIN listed on the Repair Order to ensure they match.
- Check the TIS Vehicle Inquiry System to confirm the VIN is involved in this Campaign, and that it has not already been completed.

**Note:** TMNA warranty will not reimburse dealers for repairs completed on vehicles that are not affected or were previously completed, even by another dealer.

## II. PREPARATION

- A. PARTS** – Vehicles with an NG Operating Case Vent will require a combination of 2 part numbers. Each Vehicle will require No. 1 Ventilation Case Kit – 04002-08325 and 1 of the 2 gasket kits, see table below for applicability.

Model	Part Number	Quantity	Description
Fits all 22TC05 Vehicles	04002-08325	1	Crankcase Case Vent Kit*
*The kit above includes the following part.			
<b>Part Description</b>		<b>Quantity</b>	<b>Remarks</b>
No. 1 Ventilation Case		1	-

Model	Part Number	Quantity	Description
Avalon Hybrid, Camry Hybrid, Highlander Hybrid, Rav4 Hybrid, Sienna Hybrid	04002-08225	1	Gasket Kit for: Camry Hybrid, Rav4 Hybrid, Avalon Hybrid, Highlander Hybrid & Sienna Hybrid Vehicles (Hybrid)
*The kit above includes the following parts.			
<b>Part Description</b>		<b>Quantity</b>	<b>Remarks</b>
Oil Separator Gasket		3	-
Intake Manifold Gasket		1	-
EGR Inlet Gasket		1	-
EGR Valve Adapter Gasket		1	-
Throttle Body Gasket		1	Local Part No.: 22271-F0020

Model	Part Number	Quantity	Description
Camry, Rav4	04002-08125	1	Gasket Kit for: Camry & Rav4 Vehicles (Conventional Gasoline)
*The kit above includes the following parts.			
<b>Part Description</b>		<b>Quantity</b>	<b>Remarks</b>
Oil Separator Gasket		3	
Intake Manifold Gasket		1	
EGR Inlet Gasket		1	
EGR Valve Adapter Gasket		1	
Throttle Body Gasket		1	Local Part No.: 22271-F0010

Warranty will only reimburse dealers for the part numbers listed. Any other part numbers will not be accepted on the campaign claim.

## B. Tools and Equipment

- Standard Hand Tools
- Socket Wrench 8mm
- Mirror
- Techstream
- Deep Socket Wrench 8mm
- Camera
- Torque Wrench
- "TORX" Socket Wrench E-type E8

## C. Materials

- Protective Tape
- Tape
- Marker Pen
- Protective Gloves
- Balloon
- Cloth
- Plastic Bag (if balloon is not available)

## III. BACKGROUND

The subject vehicles may have been equipped with an engine containing an incorrectly manufactured Crankcase Case Vent. If the engine is equipped with an incorrectly manufactured Crankcase Case Vent, the vehicle may not comply with certain Federal emissions regulations.

NO. 1 VENTILATION  
CASE

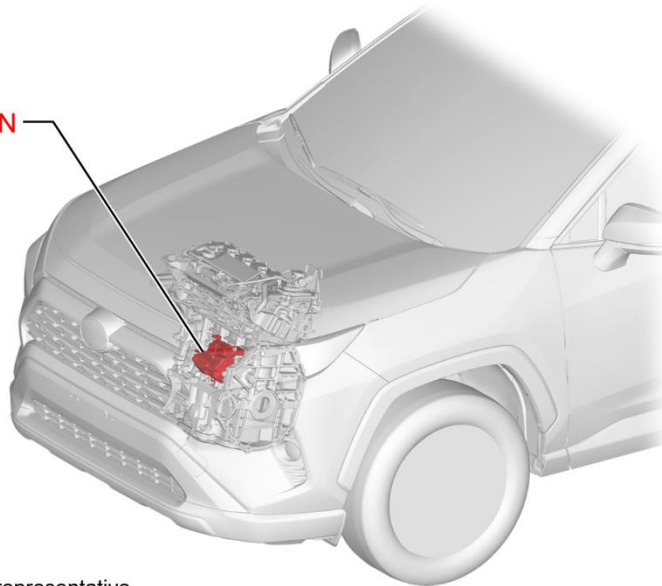

\*RAV4 HYBRID is shown as a representative.

S220300269001aS

## IV. WORK PROCEDURE TABLE OF CONTENTS

COMPONENTS .....	SECTION V
INSPECT VACUUM PRESSURE OF NO. 2 PCV HOSE .....	SECTION VI
REMOVE NO. 1 VENTILATION CASE .....	SECTION VII
INSTALL <b>NEW</b> NO. 1 VENTILATION CASE .....	SECTION VIII
APPENDIX .....	SECTION IX





## VI. INSPECT VACUUM PRESSURE OF NO. 2 PCV HOSE

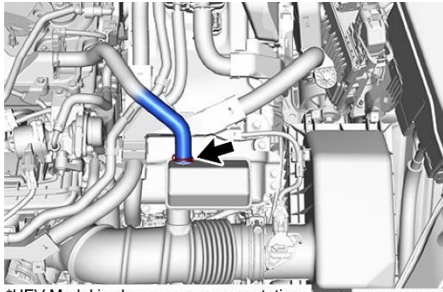

### 1. Disconnect No. 2 PCV Hose

- Use Squeezing motion on clip handles to slide clip up No. 2 PCV hose and remove hose from air cleaner hose.

### 2. Install Balloon for Testing

- Use tape (painters tape, masking tape, electrical tape, etc.) to seal port on air cleaner hose.

**NOTE:** It is important that tape seals the port completely. A port that allows un metered air to enter the engine may set a malfunction indicator light (MIL).

- Attach a balloon over No. 2 PCV hose. Use clip to secure balloon tightly over No. 2 PCV hose. If a balloon is not available, a small plastic bag be used in place of a balloon.

**NOTE:** It is important that the balloon or plastic bag seals tightly around No. 2 PCV hose. If there is not a tight seal around the hose, the inspection will not be performed correctly.

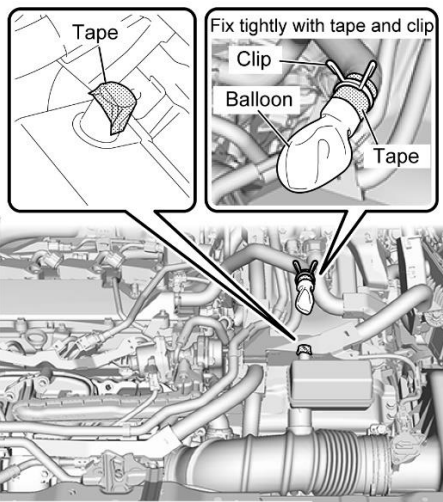

### 3. Vacuum Pressure Test – Gasoline and Hybrid Engines

- Start the vehicles engine and allow the vehicle to idle for 15-20 seconds.



***Do NOT allow the engine to idle for more than 20 seconds. Damage will occur to the engine oil seals.***

**Note:** For hybrid vehicles, engines can be started by depressing the accelerator pedal quickly 2-3 times or using inspection mode.

[Refer to TIS for instructions on General / INTRODUCTION / REPAIR INSTRUCTION / INSPECTION MODE PROCEDURE](#)

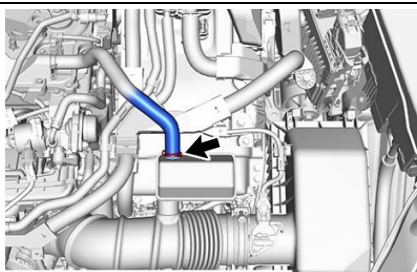

- Stop the vehicles engine after 15-20 seconds of idle and observe the condition of the balloon.
- Use the inspection results chart below (page 8) to determine next steps.



- Remove tape from air cleaner port previously taped.

- Remove the balloon assembly or bag from PCV hose NO. 2 and reinstall hose on air cleaner port. Slide spring clip over hose port connection.

## PCV Vacuum Pressure Test Inspection Results

Example Condition		Next Steps
<p><b>OK Condition –</b> Balloon or bag experiences some shrinkage due to vacuum (Or no visible change).</p>		<ul style="list-style-type: none"> <li>• Confirm No. 2 PCV hose has been reinstalled on air cleaner hose fitting.</li> <li>• Campaign complete. Return vehicle to customer.</li> </ul>
<p><b>NG Condition -</b> Balloon or bag experiences inflation / expansion from positive pressure.</p>		<ul style="list-style-type: none"> <li>• Take picture of inflated Balloon with RO number visible in picture. <b>*Picture may be required for MAC release. Refer to MAC report for additional details</b></li> <li>• Continue to Section VII – Remove No. 1 Ventilation Case.</li> </ul>

### VII. REMOVE NO. 1 VENTILATION CASE



#### 1. CHECK FOR DTC'S

- a) Perform a Health Check to check for Diagnostic Trouble Codes.

**NOTE:** This campaign covers only the replacement of No. 1 ventilation case and associated parts. It does not cover the diagnosis or replacement of any other parts on the vehicle.

#### 2. RECORD CUSTOMER SETTINGS

- a) When the battery cable is disconnected, the settings for the audio, air conditioning etc., may be reset. Make a note of the settings before disconnecting the cable from the negative (-) battery terminal.

#### 3. DISCONNECT CABLE FROM BATTERY NEGATIVE TERMINAL



#### 4. REMOVE FOLLOWING COMPONENTS

[All Models]

- No. 1 engine cover sub-assembly
- Air cleaner cap with air cleaner hose
- Air cleaner filter element sub-assembly

[AVALON HYBRID, CAMRY, CAMRY HYBRID]

- Cool air intake duct seal
- Inlet air cleaner assembly

[RAV4]

- Inlet air cleaner assembly

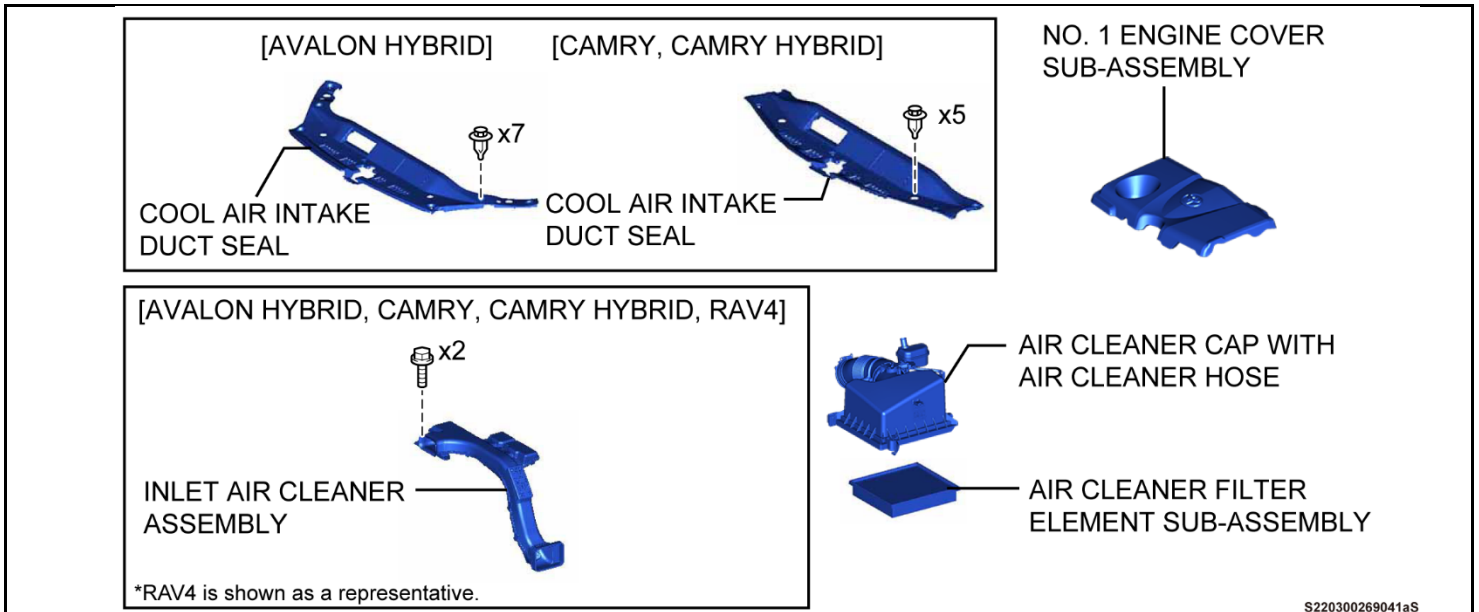

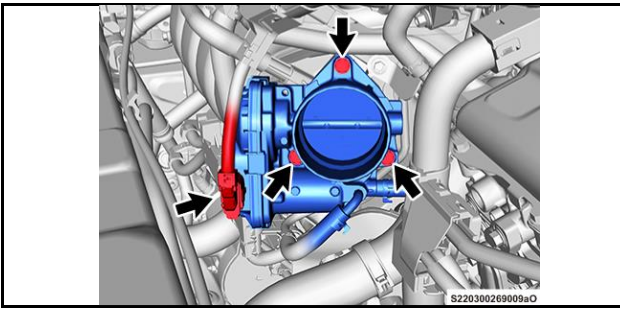

- 5. SEPARATE THROTTLE BODY ASSEMBLY**
- Disconnect the throttle body assembly connector.
  - Using an 8 mm deep socket wrench, remove the 3 bolts and disconnect the throttle body assembly from the intake manifold.

**STOP** *Do NOT disconnect the water by-pass hose*

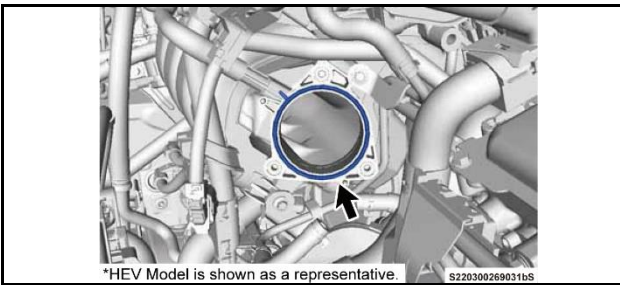

- Remove the throttle body gasket from the intake manifold.
- NOTE:** The shape of throttle body gasket differs between gasoline and hybrid vehicles.
- Cut the removed throttle body gasket to avoid confusion with new part and or reinstallation on the vehicle.

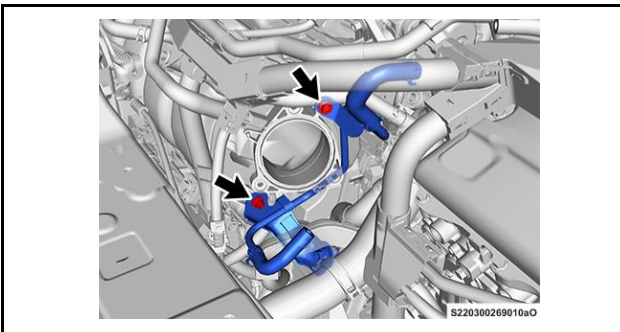

**6. SEPARATE NO. 2 WATER BY-PASS PIPE**

- For Hybrid Vehicles:
  - Using an 8 mm socket wrench, remove the 2 bolts and separate the No. 2 water by-pass pipe from the intake manifold.

**STOP** *Do NOT disconnect the water by-pass hose from metal pipe.*

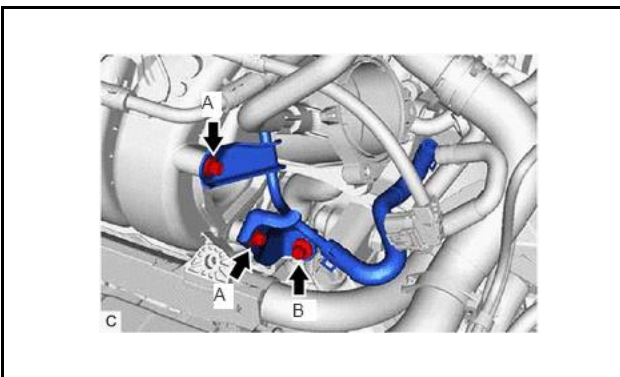

- For Conventional Gasoline Vehicles:
  - Using an 8 mm socket wrench, remove the 2 bolts (A) and disconnect the No. 2 water by-pass pipe from the intake manifold.
  - Remove the bolt (B) and No. 2 water by-pass pipe from the cylinder block assembly.

**STOP** *Do NOT disconnect the water by-pass hose from metal pipe.*

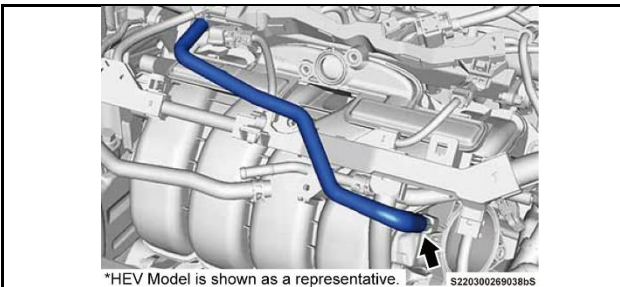

**7. DISCONNECT NO. 2 FUEL VAPOR FEED HOSE**

- Disconnect the No. 2 fuel vapor feed hose from the intake manifold.

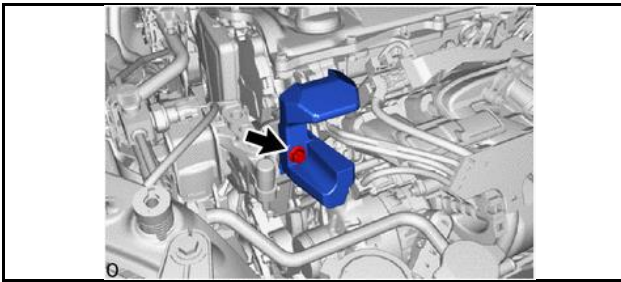

## 8. REMOVE FUEL DELIVERY GUARD

- a) Remove the bolt and fuel delivery guard from the engine mounting bracket RH.

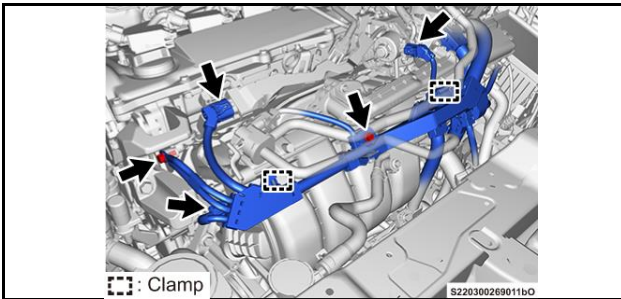

## 9. DISCONNECT ENGINE WIRE

- a) For Hybrid Vehicles:
  - 1) Disconnect the 3 connectors.
  - 2) Remove the 2 bolts.
  - 3) Disengage the 2 wire harness clamps and disconnect the engine wire.

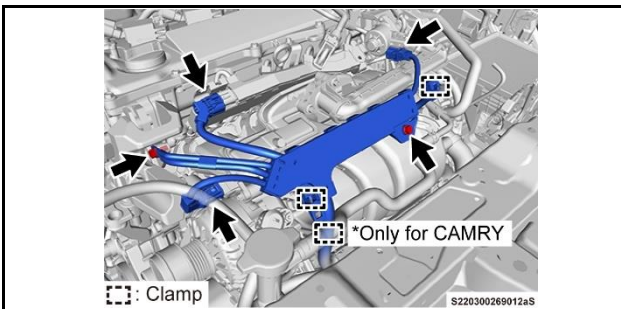

- b) For Conventional Gasoline Vehicles:
  - 1) Disengage the hose clamp and disconnect the No. 5 water by-pass hose. (Only for CAMRY)
  - 2) Disconnect the 3 connectors.
  - 3) Remove the 2 bolts.
  - 4) Disengage the 2 wire harness clamps and disconnect the engine wire.

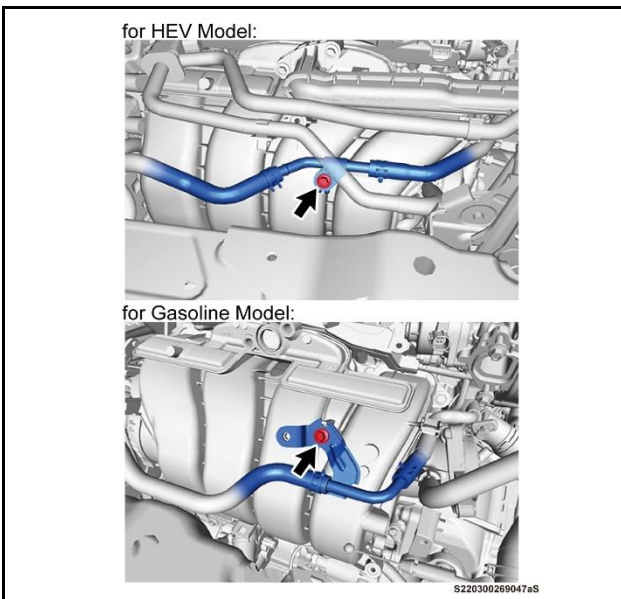

## 10. SEPARATE NO. 3 WATER BY-PASS PIPE

- a) Using an 8 mm socket wrench, remove the bolt and disconnect the No. 3 water by-pass pipe from the intake manifold.

**STOP** *Do NOT disconnect the water by-pass hose from by-pass pipe.*

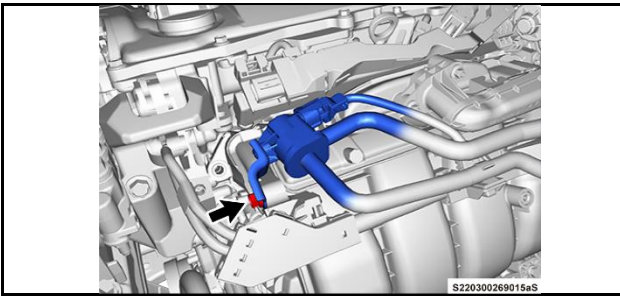

## 11. SEPARATE PURGE VALVE (PURGE VSV)

For Hybrid Vehicles:

- a) Remove the bolt and purge valve (purge VSV) from the purge VSV bracket.

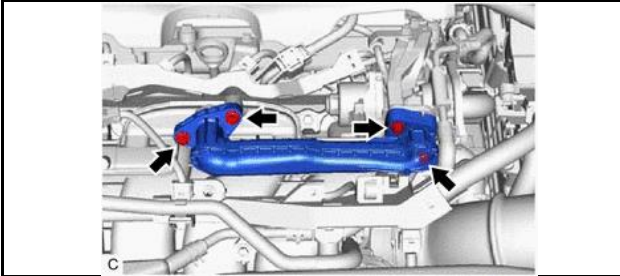

## 12. REMOVE NO. 1 EGR PIPE SUB-ASSEMBLY

- a) Using an 8 mm socket wrench, remove the 4 bolts and No. 1 EGR pipe assembly from the intake manifold and EGR valve.



- b) Remove the EGR valve adapter gasket from the No. 1 EGR pipe assembly.

- c) Cut the removed EGR valve adapter gasket to avoid confusion with new part and or reinstallation on the vehicle.

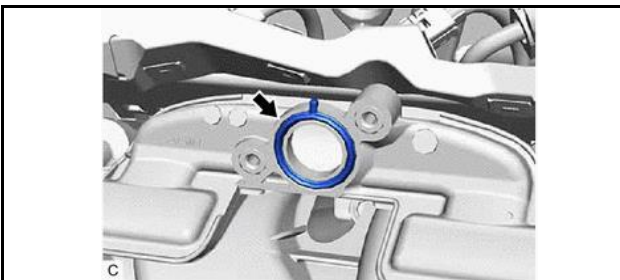

- d) Remove the EGR inlet gasket from the intake manifold.

- e) Cut the removed EGR inlet gasket to avoid confusion with new part and or reinstallation on the vehicle.

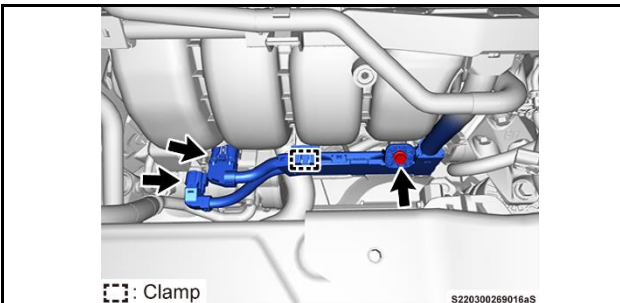

## 13. DISCONNECT ENGINE WIRE

- a) Disconnect the 2 connectors.
- b) Remove the bolt.
- c) Disengage the wire harness clamp and disconnect the engine wire from the intake manifold.

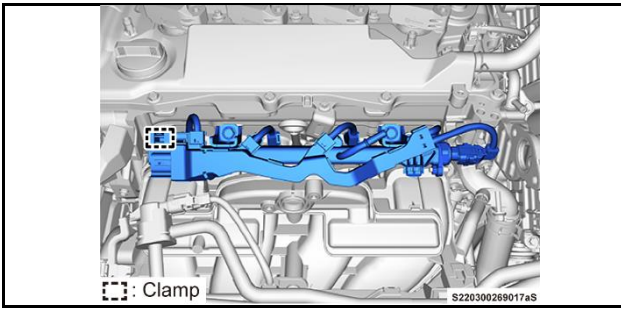

#### 14. DISCONNECT NO. 5 ENGINE WIRE

- a) Disengage the wire harness clamp and disconnect the No. 5 engine wire.

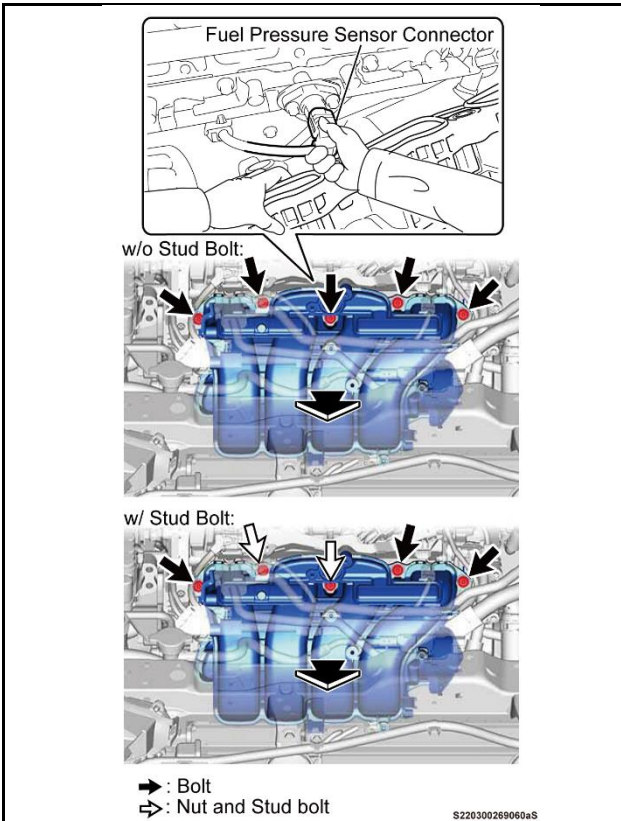

#### 15. REMOVE INTAKE MANIFOLD

- a) Without Stud Bolt:
  - 1) Remove the 5 bolts.
- b) With Stud Bolt:
  - 1) Remove the 3 bolts and 2 nuts.
  - 2) Using an E8 "TORX" socket wrench, remove the 2 stud bolts.
- c) Pull the intake manifold toward the vehicle front and then disconnect the fuel pressure sensor connector.
  - **NOTE:** The fuel pressure sensor connector may be damaged by contacting the intake manifold during removal, disconnect the fuel pressure sensor connector before removing the intake manifold.
  - **NOTE:** The O-ring of PCV valve may be damaged if the intake manifold is removed diagonally, pull the intake manifold straight toward you to avoid damaging PCV.

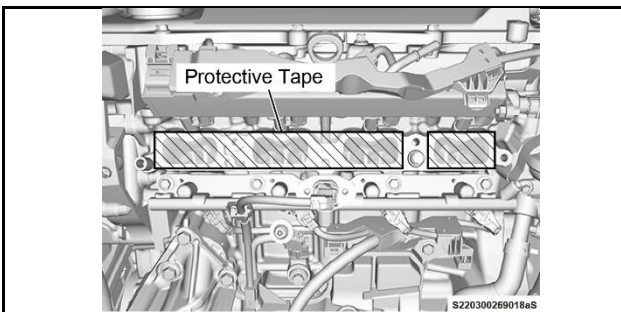

- d) Clean the opening of the cylinder head where the intake ports are located.
- e) To prevent contamination from foreign material, apply protective tape (painters tape or masking tape) to the opening of the cylinder head intake ports.

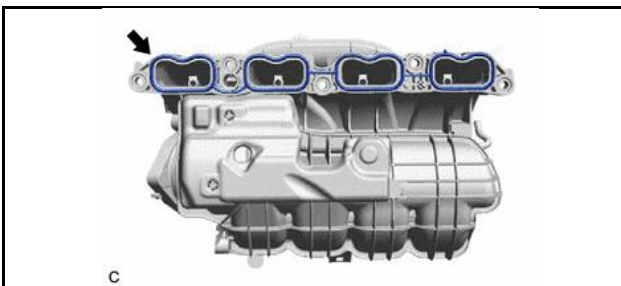

- f) Remove the No. 1 intake manifold to head gasket from the intake manifold.
- g) Cut the removed intake manifold gaskets to avoid confusion with new part and or reinstallation on the vehicle.

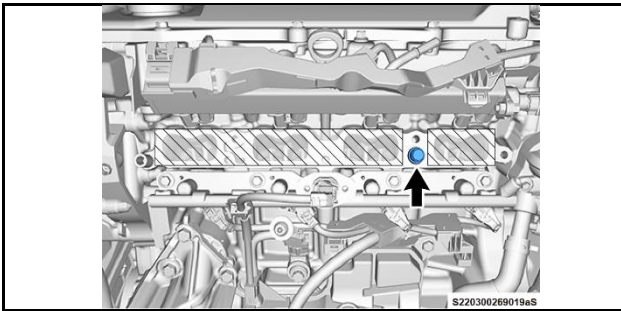

If the O-ring is damaged, replace the PCV valve (ventilation valve sub-assembly).



## 16. INSPECT PCV VALVE (VENTILATION VALVE)

- a) Confirm that the PCV valve is installed to the cylinder head.
- b) Check the condition of O-ring of the PCV valve.

**NOTE:** If the condition of O-ring is abnormal (crushed or deformed), replace the PCV valve.

**NOTE:** It is possible for the PCV valve to be unintentionally removed during intake manifold removal:

- 1) Remove the PCV valve from the intake manifold.
- 2) Check the condition of O-ring of the PCV valve.
- 3) If the condition of O-ring is abnormal (crushed or deformed), replace the PCV valve.
- 4) Apply a light coat of engine oil to the O-ring on the PCV valve.
- 5) Reinstall the PCV valve to the cylinder head.

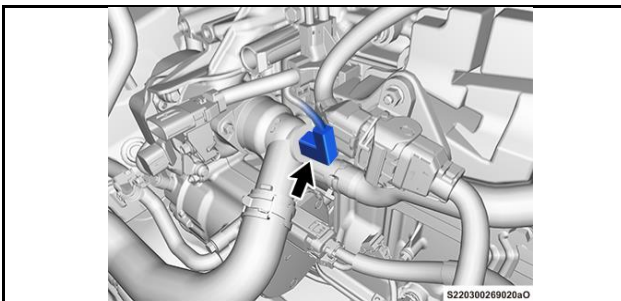

## 17. DISCONNECT WATER INLET WITH THERMOSTAT CONNECTOR

- a) Disconnect the water inlet thermostat connector.

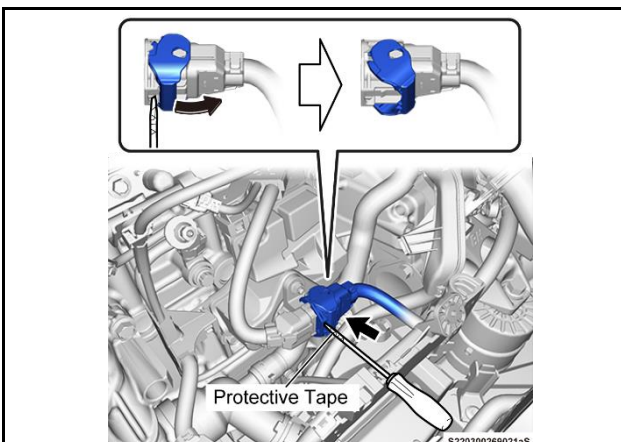

## 18. SEPARATE WIRE HARNESS CLAMP BRACKET (NO. 6 ENGINE WIRE)

- a) Using a thin flat-blade screwdriver with its tip wrapped with protective tape, disengage the tab and disconnect the connector by moving the locking tab to the right.

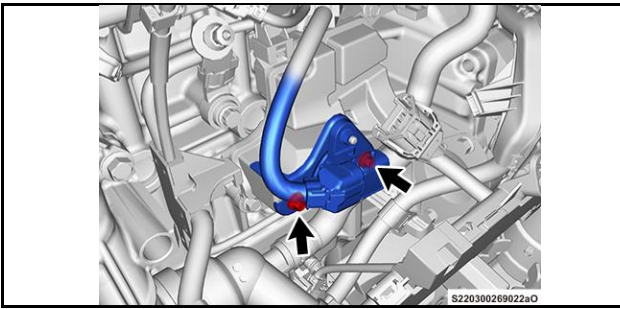

- b) Using an 8 mm socket wrench, remove the 2 bolts and wire harness clamp bracket with engine wire from the No. 1 ventilation case.

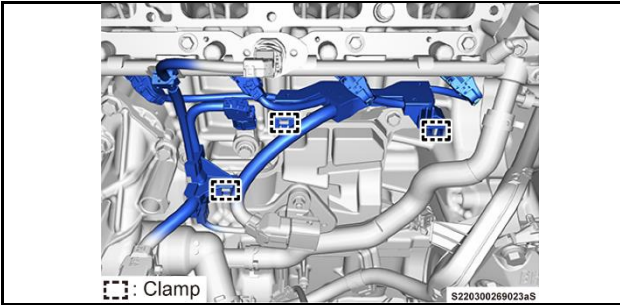

## 19. DISCONNECT NO. 6 ENGINE WIRE AND SENSOR WIRE

- a) Disengage the 3 wire harness clamps and disconnect the No. 6 engine wire and sensor wire.

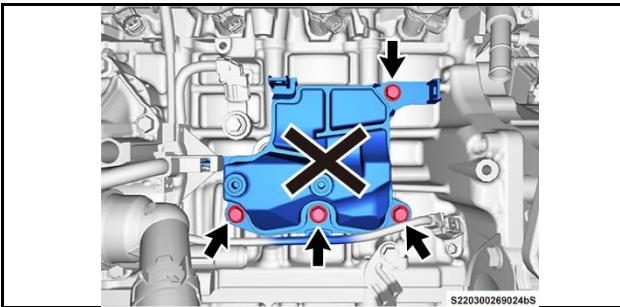

## 20. REMOVE NO. 1 VENTILATION CASE

- a) Prior to removal of the ventilation case, mark the part with an X or similar mark to indicate this is the old ventilation case.
- b) Remove the 4 bolts and the ventilation case from the side of the cylinder block.

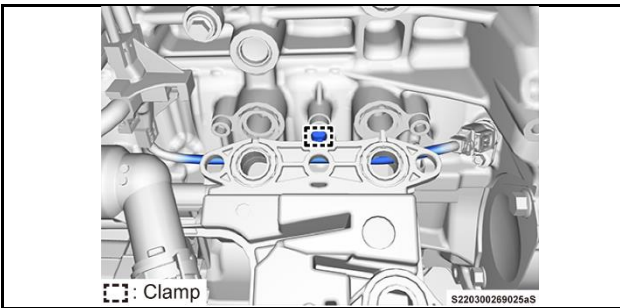

- c) Disengage the clamp and disconnect the sensor wire from the ventilation case.

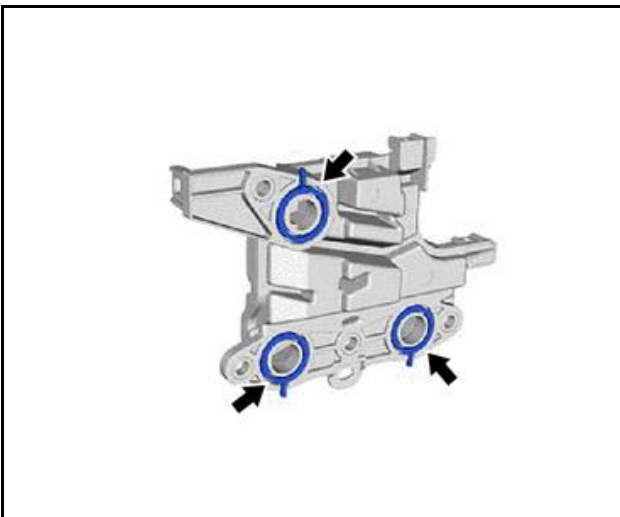

- d) Remove the 3 oil separator gaskets from the No. 1 ventilation case.

**NOTE:** It is possible for the oil separator gaskets to fall off the ventilation case during removal. Ensure all 3 gaskets are located and removed from the engine bay area.

- e) Cut the removed oil separator gaskets to avoid confusion with new part and or reinstallation on the vehicle.
- f) Store the removed ventilation case in a container for removed components to prevent reinstallation.

## VIII. INSTALL NEW NO. 1 VENTILATION CASE

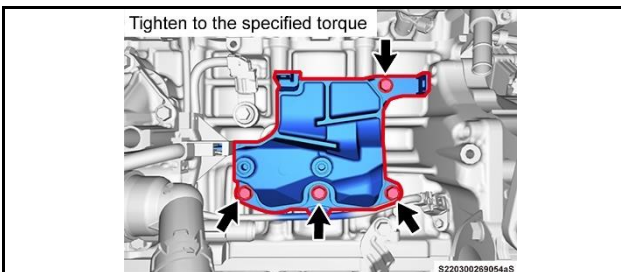
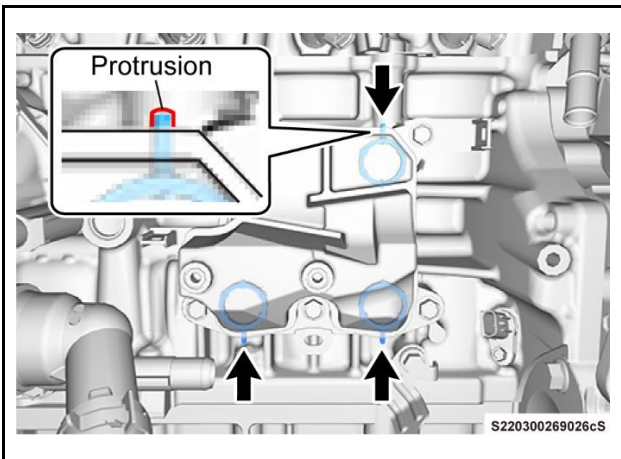
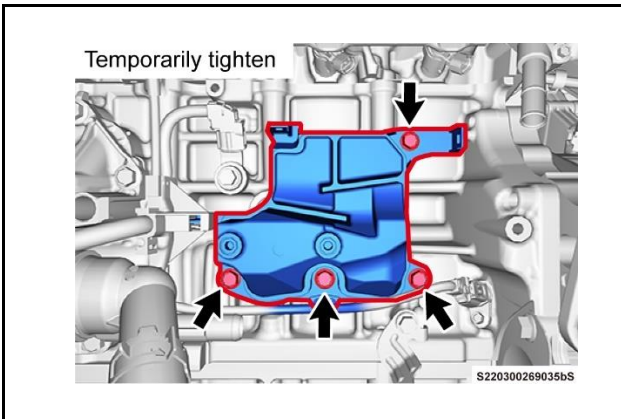
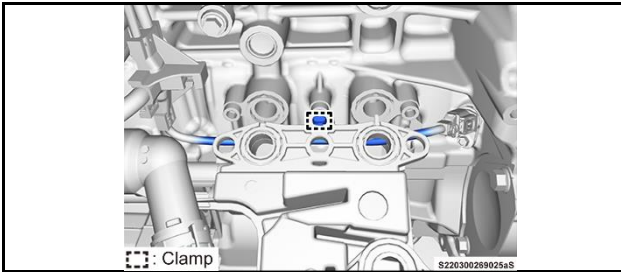
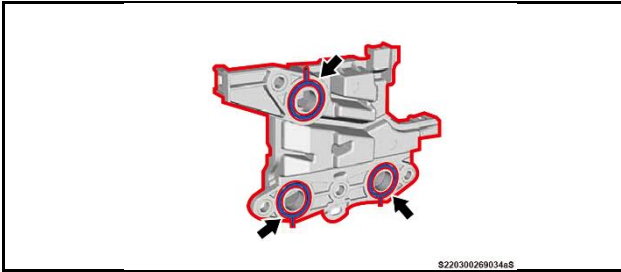

### 1. INSTALL NEW NO. 1 VENTILATION CASE

- Install 3 new oil separator gaskets to the new No. 1 ventilation case.
- Engage the clamp to reconnect the sensor wire to the ventilation case.
- Temporarily install the new ventilation case to the cylinder block sub-assembly with the 4 bolts.



**Do NOT allow the sensor wire to be caught between the ventilation case and the cylinder block. If the wire is caught between the ventilation case and engine block, damage may occur to the wire.**

- Use a mirror to confirm that the oil separator gasket protrusions are present between the ventilation case and cylinder block.
  - Check all 3 gasket protrusions.
- NOTE:** If gasket protrusion is not visible, it is possible that oil separator gasket fell off during ventilation case installation.



**Do NOT move to next step until gasket protrusion is visible for all 3 gaskets.**

- Tighten the 4 ventilation case bolts to the following torque specification.  
**Specified torque:**  
**21 N\*m (214 kgf\*cm, 15 ft.\*lbf)**



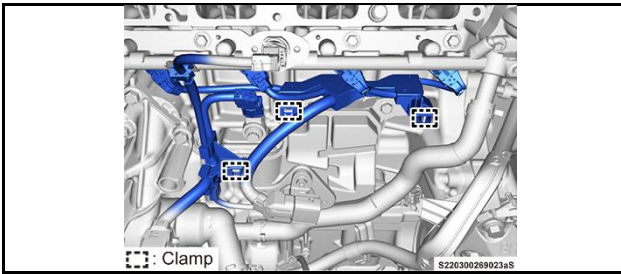

## 2. RECONNECT NO. 6 ENGINE WIRE AND SENSOR WIRE

- a) Re-engage the 3 wire harness clamps to secure the No. 6 engine and sensor wire harness.

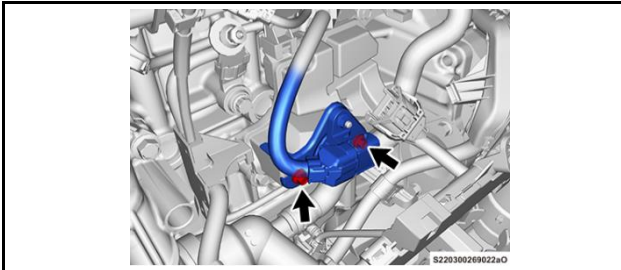

## 3. REINSTALL WIRE HARNESS CLAMP BRACKET (NO. 6 ENGINE WIRE)

- a) Using an 8 mm socket wrench, reinstall the wire harness clamp bracket with engine wire to the No. 1 ventilation case with the 2 bolts.

**Specified torque:**

**10 N\*m (102 kgf\*cm, 7 ft.\*lbf)**

- b) Re-engage the claw and reconnect the connector.

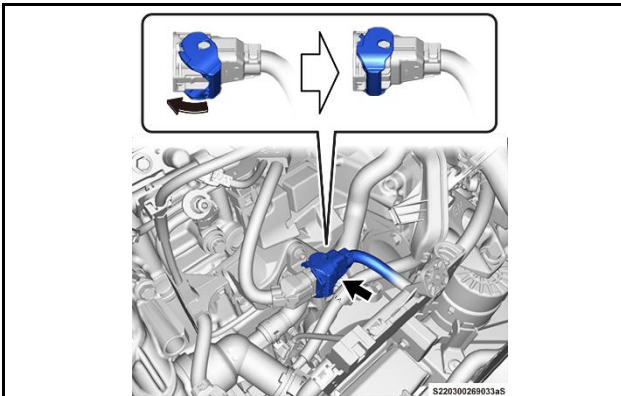

## 4. RECONNECT WATER INLET THERMOSTAT CONNECTOR

- a) Reconnect the water inlet thermostat connector.

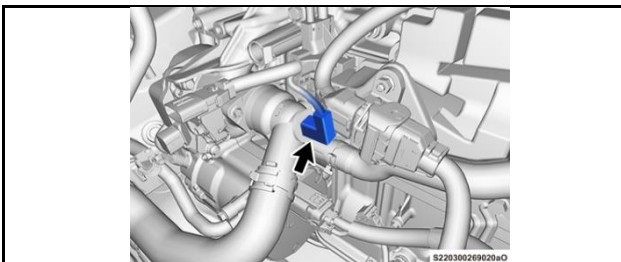

## 5. REINSTALL INTAKE MANIFOLD AND NO. 2 WATER BY-PASS PIPE

- a) Install new intake manifold gaskets in the intake manifold gasket moldings.

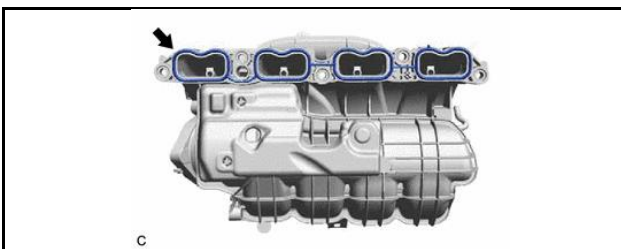

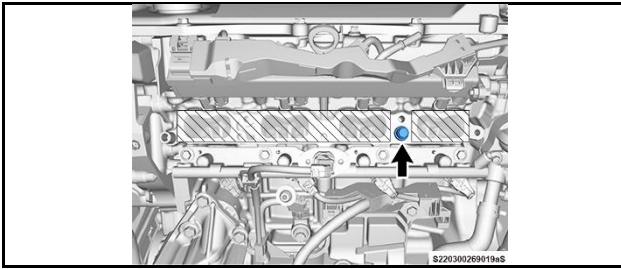

b) Apply a light coat of engine oil to the O-ring on the PCV valve.

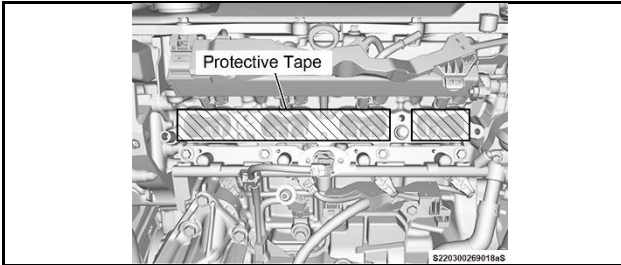

c) Remove the protective tape previously applied over intake ports of cylinder head.

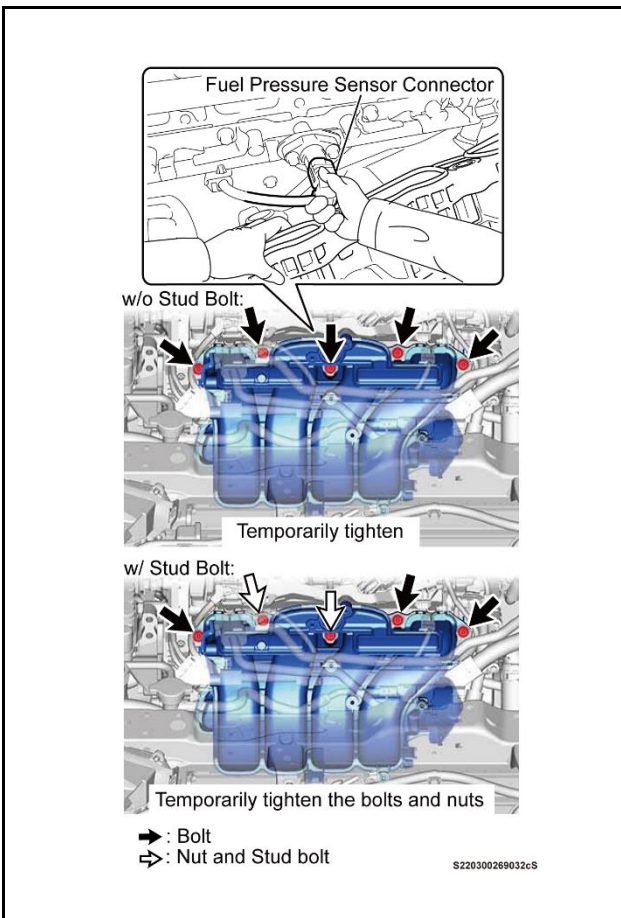

**NOTE:** It is possible to damage the fuel pressure sensor connector while installing the intake manifold. Do not connect fuel pressure sensor connector until after intake manifold is in position near cylinder head.

d) Position the intake manifold so that the fuel pressure sensor connector can be seen before fully installing the intake manifold as shown in the illustration.

e) Connect the fuel pressure sensor connector.

f) Without Stud Bolt:

1) Temporarily reinstall the intake manifold to the cylinder head sub-assembly with the 5 bolts.

g) With Stud Bolt:

1) Temporarily reinstall the intake manifold to the cylinder head sub-assembly.

2) Using an E8 "TORX" socket wrench, reinstall the 2 stud bolts.

**Specified torque:**

**6.5 N\*m (66 kgf\*cm, 58 in.\*lbf)**

3) Temporarily install the 3 bolts and 2 nuts.

h) For Hybrid Vehicles:

1) Using an 8 mm socket wrench, temporarily reinstall the No. 2 water by-pass pipe to the intake manifold with the 2 bolts.

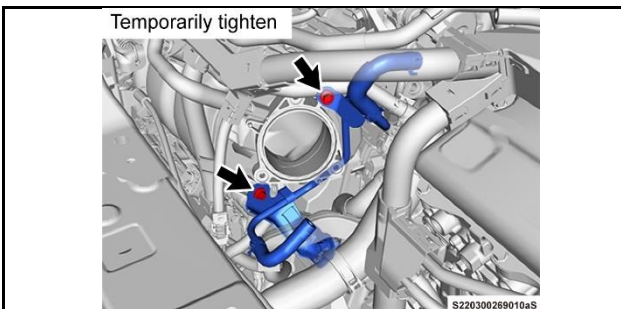

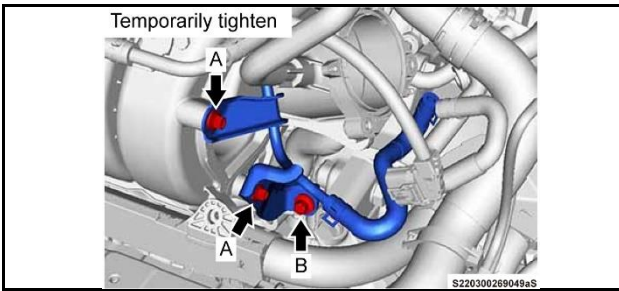

- i) For Conventional Gasoline Vehicles:
- 1) Temporarily reinstall the No. 2 water by-pass pipe to the cylinder block with the bolt (B).
  - 2) Using an 8 mm socket wrench, temporarily reinstall the No. 2 water by-pass pipe to the intake manifold with the 2 bolts (A).

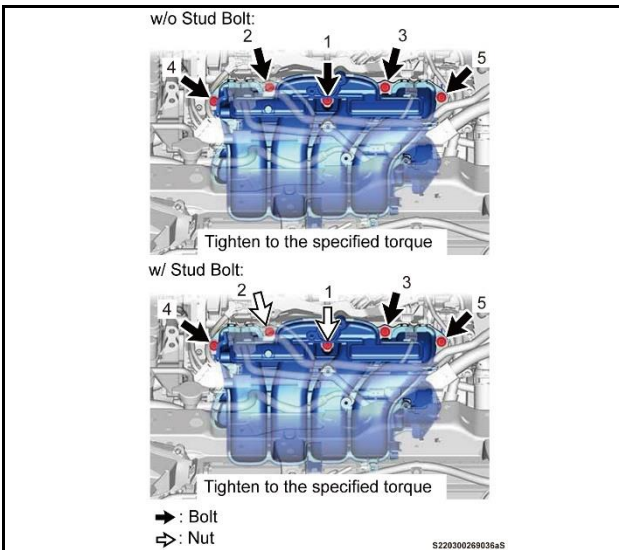

- j) Without Stud Bolt:
- 1) Tighten the 5 bolts in the order shown in the illustration.

**Specified torque:**  
**24 N\*m (245 kgf\*cm, 18 ft.\*lbf)**

- k) With Stud Bolt:

- 1) Tighten the 3 bolts and 2 nuts in the order shown in the illustration.

**Specified torque:**  
**24 N\*m (245 kgf\*cm, 18 ft.\*lbf)**

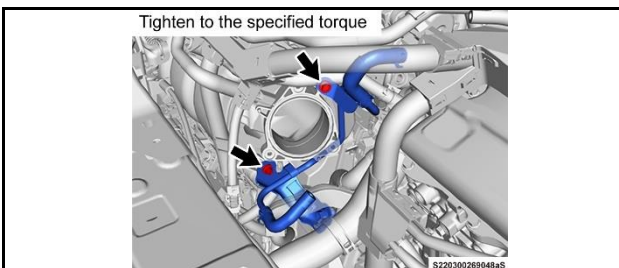

- l) For Hybrid Vehicles:

- 1) Using the 8 mm socket wrench, tighten the 2 bolts.

**Specified torque:**  
**10 N\*m (102 kgf\*cm, 7 ft.\*lbf)**

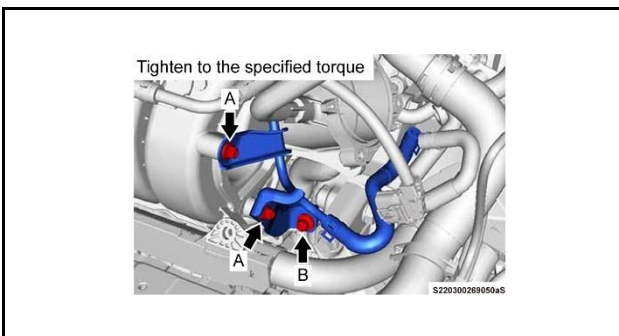

- m) For Conventional Gasoline Vehicles:

- 1) Tighten the bolt (B).

**Specified torque:**  
**21 N\*m (214 kgf\*cm, 15 ft.\*lbf)**

- 2) Using the 8 mm socket wrench, tighten the 2 bolts (A).

**Specified torque:**  
**10 N\*m (102 kgf\*cm, 7 ft.\*lbf)**

## 6. RECONNECT NO. 5 ENGINE WIRE

- a) Re-engage the wire harness clamp to reconnect the No. 5 engine wire.

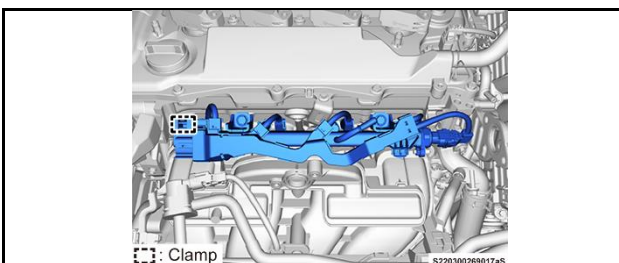

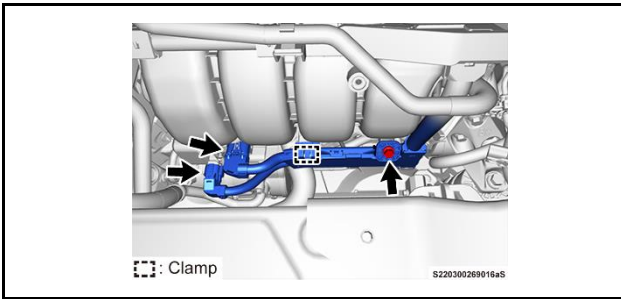

## 7. RECONNECT ENGINE WIRE

- a) Re-engage the wire harness clamp to reconnect the engine wire to the intake manifold.

- b) Reinstall the bolt.

**Specified torque:**

**10 N\*m (102 kgf\*cm, 7 ft.\*lbf)**

- c) Reconnect the 2 connectors.

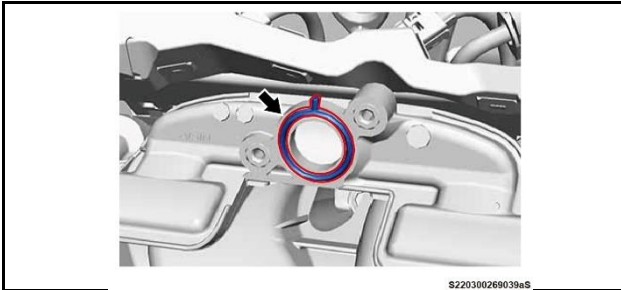

## 8. REINSTALL NO. 1 EGR PIPE SUB-ASSEMBLY

- a) Install new EGR inlet gasket to the intake manifold.

- b) Install new EGR valve adapter gasket to the No. 1 EGR pipe.

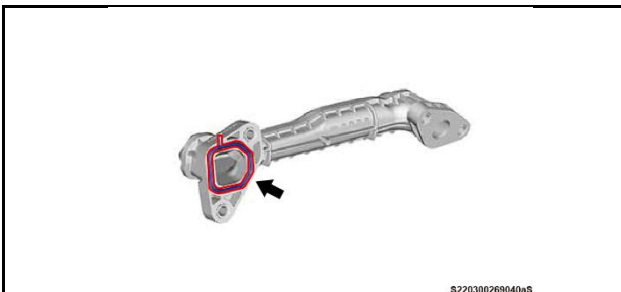

- c) Using an 8 mm socket wrench, reinstall the No. 1 EGR pipe to the intake manifold and EGR valve with the 4 bolts.

**Specified torque:**

**10 N\*m (102 kgf\*cm, 7 ft.\*lbf)**

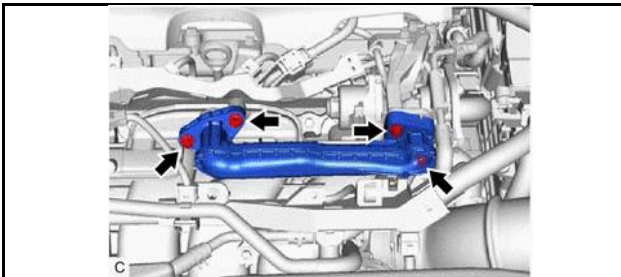

## 9. REINSTALL PURGE VALVE

For Hybrid Vehicles

- a) Reinstall the purge valve to the purge bracket with the bolt.

**Specified torque:**

**10 N\*m (102 kgf\*cm, 7 ft.\*lbf)**

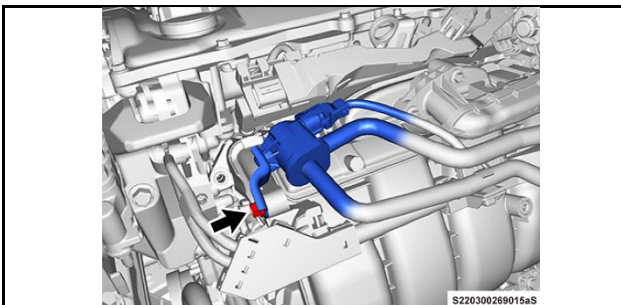

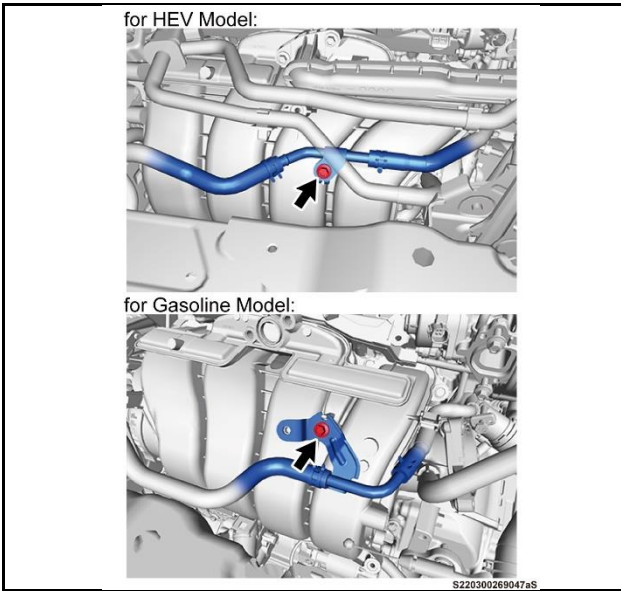

## 10. REINSTALL NO. 3 WATER BY-PASS PIPE

- a) Using an 8 mm socket wrench, reconnect the No. 3 water by-pass pipe to the intake manifold with the bolt.

**Specified torque:**

**10 N\*m (102 kgf\*cm, 7 ft.\*lbf)**

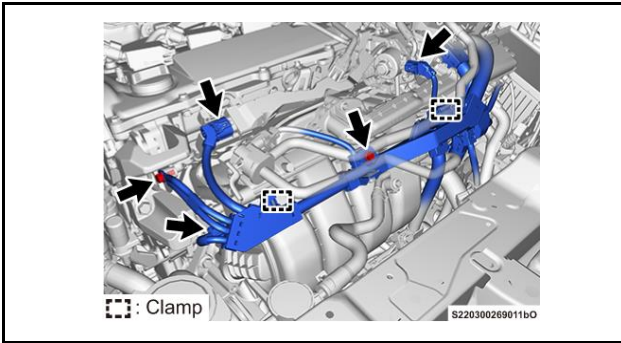

## 11. RECONNECT ENGINE WIRE

- a) For Hybrid Vehicles:

- 1) Re-engage the 2 wire harness clamps to reconnect the engine wire.
- 2) Reinstall the 2 bolts.

**Specified torque:**

**10 N\*m (102 kgf\*cm, 7 ft.\*lbf)**

- 3) Reconnect the 3 connectors.

- b) For Conventional Gasoline Vehicles:

- 1) Re-engage the 2 wire harness clamps to reconnect the engine wire.
- 2) Reinstall the 2 bolts.

**Specified torque:**

**10 N\*m (102 kgf\*cm, 7 ft.\*lbf)**

- 3) Reconnect the 3 connectors.

- 4) Re-engage the hose clamp to the reconnect No. 5 water by-pass hose. (Only for CAMRY)

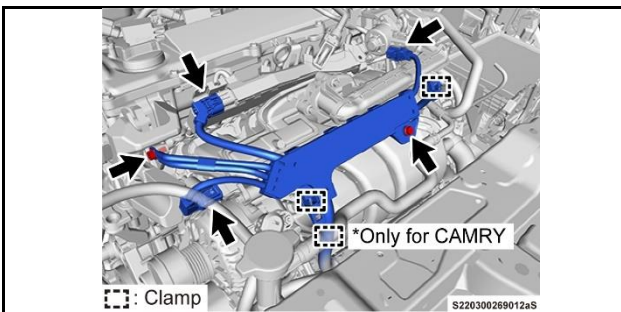

## 12. REINSTALL FUEL DELIVERY GUARD

- a) Reinstall the fuel delivery guard to the engine mounting bracket RH with the bolt.

**Specified torque:**

**40 N\*m (408 kgf\*cm, 30 ft.\*lbf)**

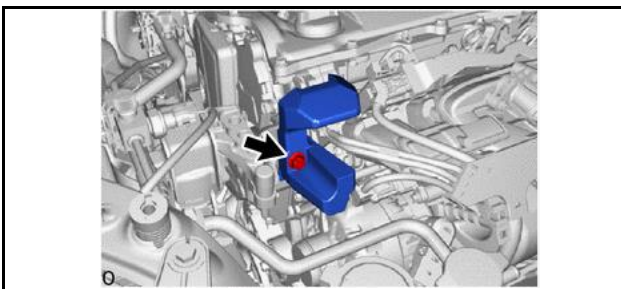

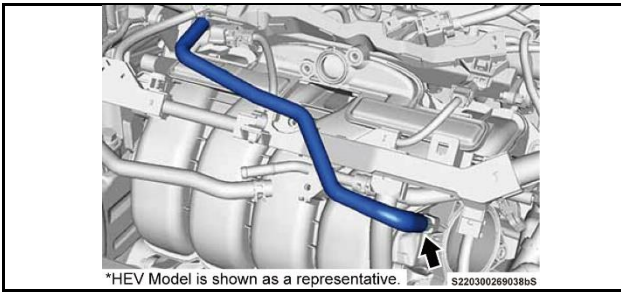

### 13. RECONNECT NO. 2 FUEL VAPOR FEED HOSE

- a) Reconnect the No. 2 fuel vapor feed hose to the intake manifold.

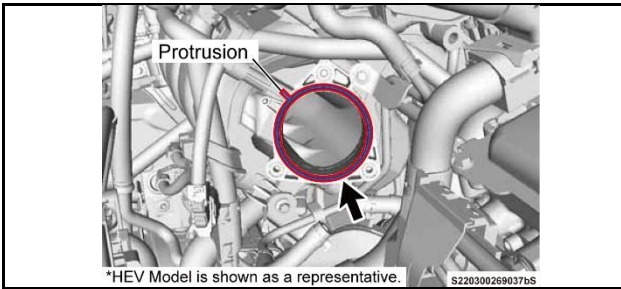

### 14. INSTALL THROTTLE BODY ASSEMBLY

- a) Install new throttle body gasket to the intake manifold with the protrusion of the throttle body gasket oriented as shown in the illustration.

**NOTE:** The shape of throttle body gasket differs between gasoline vehicles and hybrid vehicles.

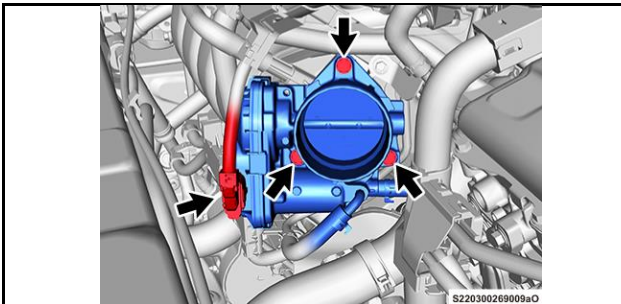

- b) Using an 8 mm deep socket wrench, install the throttle body assembly to the intake manifold with the 3 bolts.

**Specified torque:**

**10 N\*m (102 kgf\*cm, 7 ft.\*lbf)**

- c) Reconnect the throttle body assembly connector.

## 15. REINSTALL FOLLOWING COMPONENTS

[All Models]

- No. 1 engine cover sub-assembly
- Air cleaner cap with air cleaner hose
- Air cleaner filter element sub-assembly

[AVALON HYBRID, CAMRY, CAMRY HYBRID]

- Cool air intake duct seal
- Inlet air cleaner assembly

[RAV4]

- Inlet air cleaner assembly

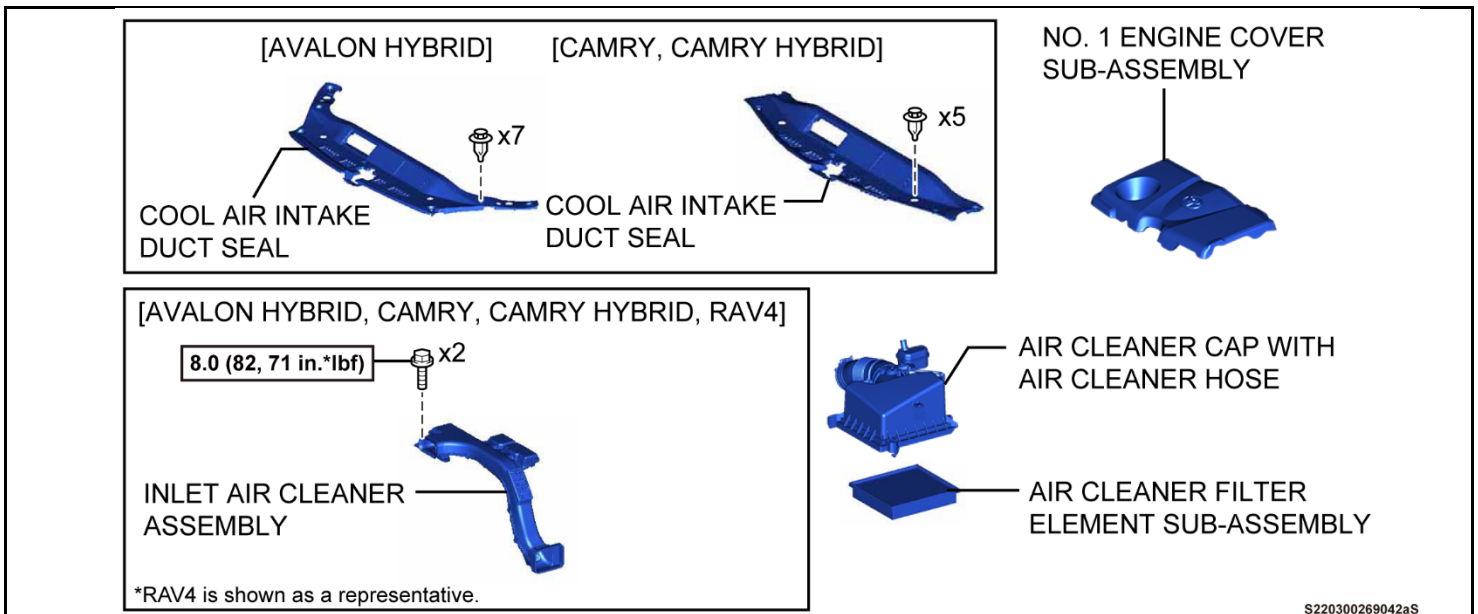

## 16. CONNECT NEGATIVE BATTERY TERMINAL CONNECTION

## 17. PERFORM SYSTEM INITIALIZATIONS

## 18. CHECK FOR DTC'S

### ◀ VERIFY REPAIR QUALITY ▶

- Confirm that all parts listed in the Components Diagrams have been properly installed on the vehicle
- Start vehicle and confirm that no indicator lights are illuminated
- With engine running, confirm no oil leaks are present in engine bay from PCV ventilation case area.

## IX. APPENDIX

### A. PARTS DISPOSAL

In accordance with Federal law, please make sure all parts (original parts) removed from the vehicle are disposed of in a manner in which they will not be reused, ***unless requested for parts recovery return.***

### CAMPAIGN DESIGNATION DECODER

