

**** TECHNICAL INFORMATION NOTICE ****

DATE: August 19, 2022
TO: Mitsubishi Motors US & Puerto Rico Dealer Service and Parts Managers
RE: Accessory Parts Precaution During Handling Prior and During Installation
TIN NO.: TIN-22-54-005

AFFECTED VEHICLES: Outlander - MZ590914EX Dynamic Shield
 Eclipse Cross - MZ590976EX Dynamic Shield

PURPOSE:

Prevent accessory illuminators from being damaged while handling/during installation and also focus on installing the accessory illuminators properly by following the installation instructions below. The two accessory parts listed above have been updated with caution points and handling instructions that pertain to the illuminator to prevent potential damage. If the installation instructions are not followed properly, damage may occur preventing the illuminators from illuminating.

Possible Cause(s):

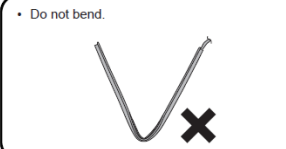
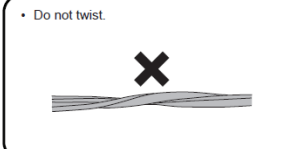
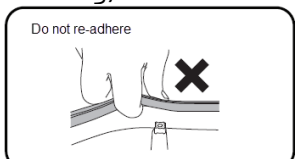
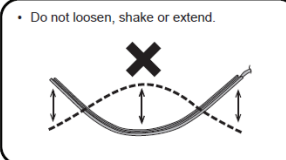
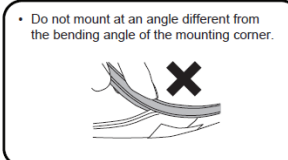
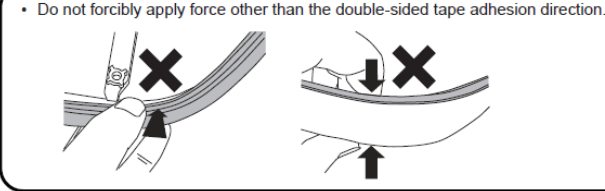
<p>When handling the dynamic shield illumination illuminators, note the following:</p> <ul style="list-style-type: none"> • Do not bend more than necessary • Do not twist more than necessary • Do not loosen more than necessary • Do not shake • Do not extend/stretch • Do not mount at an angle different from the bending angle of the mounting corner • Do not apply force other than the double-sided tape adhesion direction • Do not detach adhesive to re-adhere (pulling/stretching) 	<p>• Do not bend.</p> 	<p>• Do not twist.</p> 
	<p>• Do not loosen, shake or extend.</p> 	<p>• Do not mount at an angle different from the bending angle of the mounting corner.</p> 
<p>• Do not forcibly apply force other than the double-sided tape adhesion direction.</p> 		

Accessory Install Instructions Procedures (illuminator installation)

Applicable to **Eclipse Cross and Outlander**

- The caution note below shall be applied when temporarily fixing illumination on to garnish and during final adhesion onto garnish
- Make sure to check the position
- Do not bend while pressing LH & RH Illuminator with your fingers
- Do not install at a different angle than the bending angle of the corners of the front bumper side lower and upper garnishes

[Good]

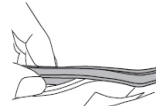

[No Good]



Outlander MZ590914EX Dynamic Shield - Please carefully review accessory installation instructions

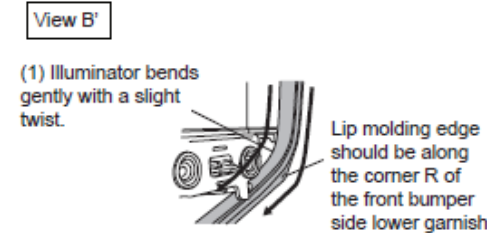
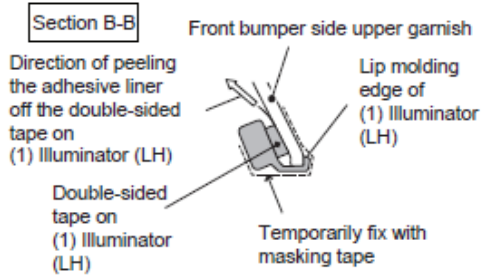
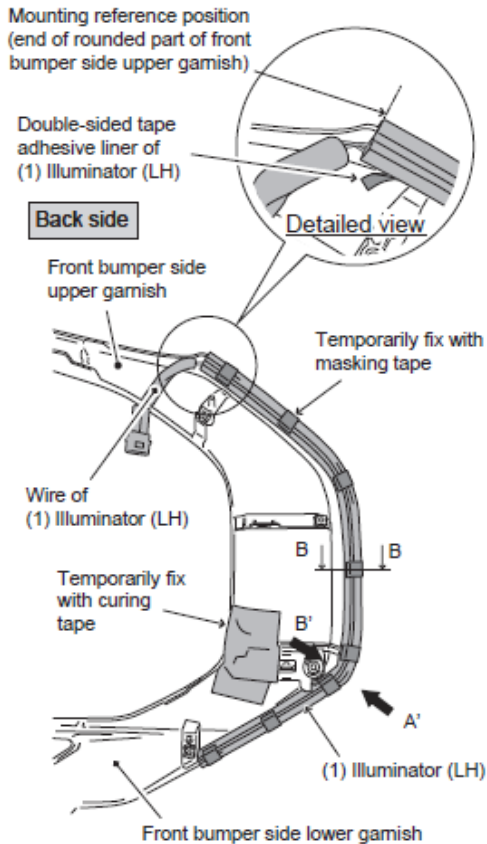

- 1) Temporarily fix the front bumper side lower and upper garnish together with curing tape. (Left and right sides to hold parts together)
- 2) Temporarily put (1) Illuminator (LH) on the front bumper side lower and upper garnishes without removing the double-sided tape adhesive liners and check the position.
 - Align the wire end of (1) Illuminator (LH) with the mounting reference positions (refer to the detailed view on the upper left).

Note

Make sure that the lip molding edges of (1) Illuminator (LH) and (2) Illuminator (RH) are not pulled inwards and are evenly installed.

[Good] Lip molding edge

[No good] Be careful of opening

- 3) Remove (1) Illuminator (LH). Degrease the mounting part of (1) Illuminator (LH) on the front bumper side lower and upper garnishes.
- 4) Peel off some of the double-sided tape adhesive liner on (1) Illuminator (LH) at both ends, and fold the adhesive liner ends outward. (Refer to the detailed view on the upper left).
- 5) Put (1) Illuminator (LH) on the front bumper side lower and upper garnishes fix with masking tape as shown on the left.

Note

If the work instructions are not followed, the lip molding edge of (1) Illuminator (LH) or (2) Illuminator (RH) may be pulled open after the installation is completed.

- 6) Attach (1) Illuminator (LH) along the edges of the front bumper side lower and upper garnishes while peeling off the double-sided tape adhesive liner little by little.

Note

Peel off the double-sided tape adhesive liners, being careful not to let (1) Illuminator (LH) or (2) Illuminator (RH) pulled inward of the front bumper side lower and upper garnishes. If (1) Illuminator (LH) or (2) Illuminator (RH) is pulled inward, the lip molding edge of the illuminator will be pulled open.

[Good] Double-sided tape adhesive liner peeling direction

[No good] Opening

Lip molding edge

Be careful of moving inward

- 7) Attach (1) Illuminator (LH) By pressing the double-sided tape by hand and assure good adhesion throughout.

Caution

When attaching, be careful not to apply any force other than perpendicular to the surface of the double-sided tape. The illuminators may not turn on.

- 8) Repeat same steps 1) thru 7) on RH side
- After installation:
- Check for proper fitment
 - Check for good adhesion
 - Check for damage

Eclipse Cross MZ590976EX Dynamic Shield - Please carefully review accessory installation instructions

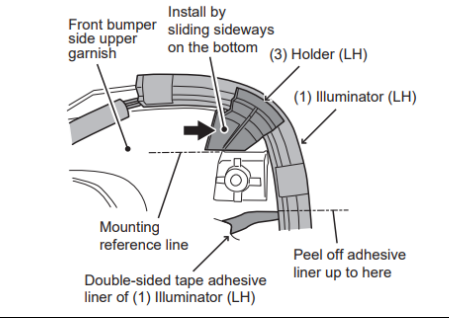
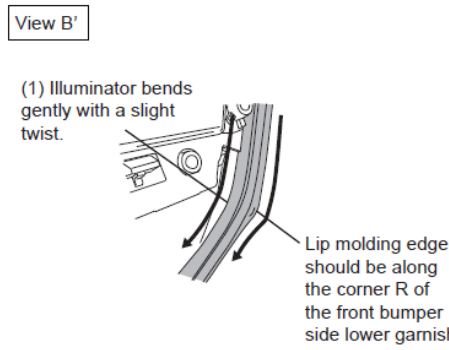
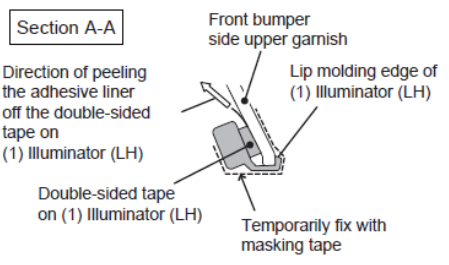
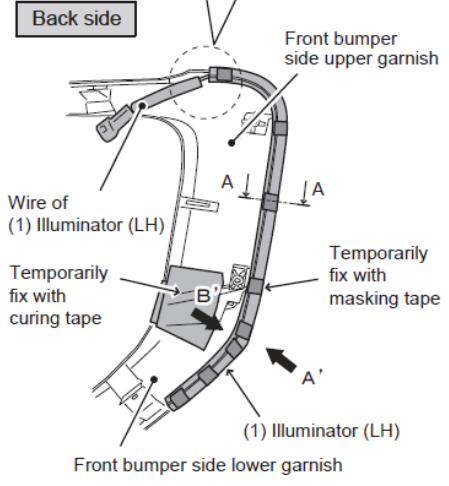
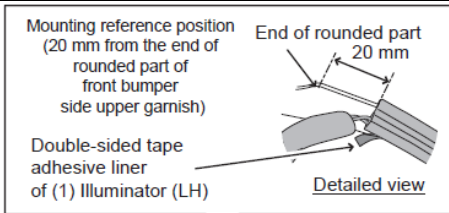

- 1) Temporary fix the LH front bumper side lower and upper garnishes with curing tape so that they are held together as a unit.
- 2) Temporarily put (1) Illuminator (LH) on the front bumper side lower and upper garnishes without removing the double-sided tape adhesive liners and check the position.
 - o Align the wire end of (1) Illuminator (LH) with the mounting reference position (see the detailed view on the upper left).

Note

Make sure that the lip molding edges of (1) Illuminator (LH) and (2) Illuminator (RH) are not pulled inwards and are evenly installed.

- 3) Remove (1) Illuminator (LH). Degrease the mounting part of (1) Illuminator (LH) on the front bumper side lower and upper garnishes.
- 4) Peel off some of the double-sided tape adhesive on (1) Illuminator (LH) at both ends, and fold the adhesive liner ends outward. (See the detailed view on the upper left)
- 5) Put (1) Illuminator (LH) on the front bumper side lower and upper garnish at the position confirmed in step 2). Temporarily fix with masking tape as shown on the left.

Note

If the work instructions are not followed, the lip molding edge of (1) Illuminator (LH) or (2) Illuminator (RH) may be pulled open after the installation is completed.

- 6) Peel off the double sided tape adhesive liner on the electric wire side on the back of the (1) Illuminator (LH) to the position shown on the left. At that time, align the positions of (1) Illuminator (LH), and peel off the adhesive liners while firmly pressing.

Note

Peel off the double-sided tape adhesive liners, being careful not to let (1) Illuminator (LH) or (2) Illuminator (RH) pulled inward of the front bumper side lower and upper garnishes. If (1) Illuminator (LH) or (2) Illuminator (RH) is pulled inward, the lip molding edge of the illuminator will be pulled open.

- 7) Peel off the double -sided tape adhesive liner from (3) Holder (LH) and install (3) Holder (LH) as shown on the bottom left corner.
- 8) Attach (1) Illuminator (LH) along the edges of the front bumper side lower and upper garnishes while peeling off the double-sided tape adhesive liner little by little.

Note

Make sure that the lip molding edges of (1) Illuminator (LH) and (2) Illuminator (RH) are not pulled inwards and are evenly installed.

- 9) Attach (1) Illuminator (LH) By pressing the double-sided tape by hand and assure good adhesion throughout.

Caution

When attaching, be careful not to apply any force other than perpendicular to the surface of the double-sided tape. The illuminators may not turn on.

- 10) Repeat same steps 1) thru 9) on RH side
 After installation:
- Check for proper fitment
 - Check for good adhesion
 - Check for damage