

WNEO – Replacing Driver Assistance Systems Holder (Workshop Campaign)

Revision: **CRITICAL WARNING** -This campaign includes steps where control unit(s) in the vehicle will be programmed with the PIWIS Tester. The vehicle voltage must be maintained between 13.5 volts and 14.5 volts during this programming. Failure to maintain this voltage could result in damaged control unit(s). Damage caused by inadequate voltage during programming is not a warrantable defect. The technician must verify the actual vehicle voltage in the PIWIS Tester before starting the campaign and also document the actual voltage on the repair order.

Model Year: **As of 2021 up to 2022**

Vehicle Type: **Taycan 4 Cross Turismo (Y1B) / Taycan 4S Cross Turismo (Y1B)
Taycan Turbo Cross Turismo (Y1B) / Taycan Turbo S Cross Turismo (Y1B)**

Concerns: **Holder for driver assistance systems**

Information: **There is a possibility that the holder for the driver assistance systems of the front module does not comply with specifications on the affected vehicles.**
In case of an impact load to the front bumper in the vehicle longitudinally, it cannot be ruled out that it can cause the holder to break in some cases.

Action required: Replace driver assistance systems holder.

Affected Vehicles: Only the vehicles assigned to the campaign (see also PCSS Vehicle Information).

Parts Info: The parts required for the measure can be found in the campaign scope assigned to the respective vehicle.

Installation

Position:

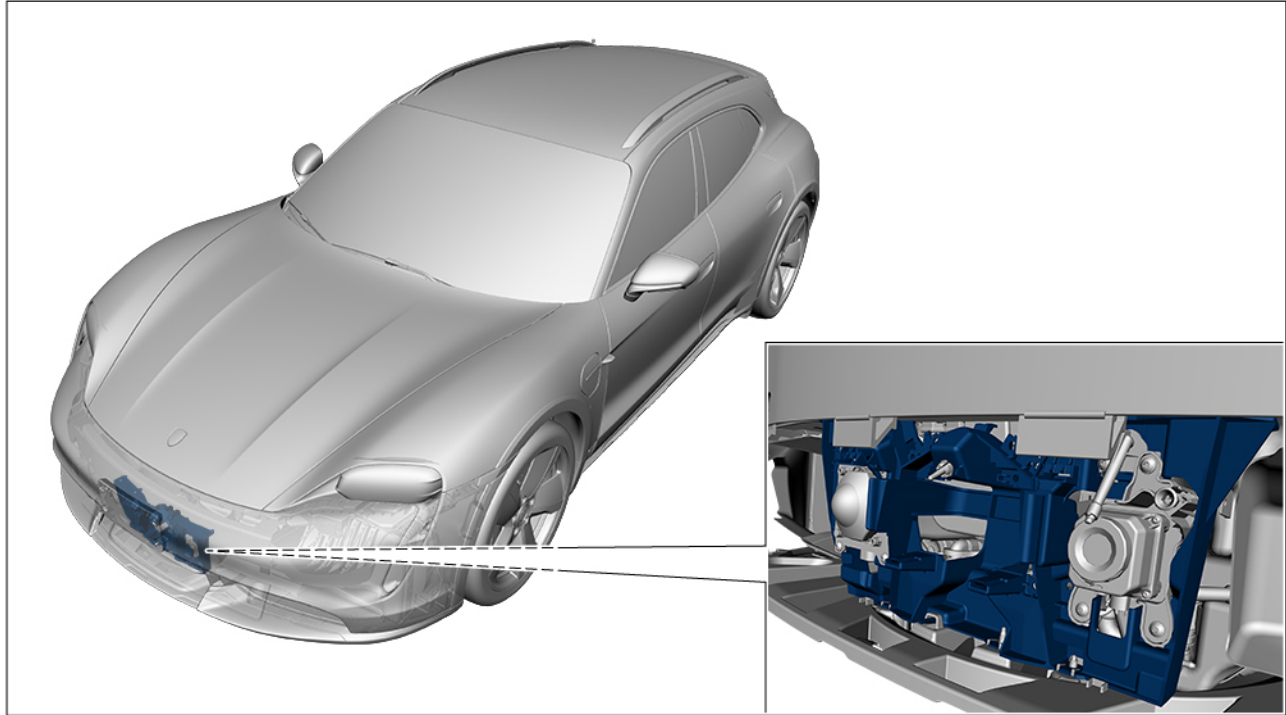

Driver assistance systems holder (replace)

Required tools

Tool:

- Battery charger with a current rating of **at least 90 A** and - if required - **also with a current and voltage controlled charge map** for lithium starter batteries, e.g. **VAS 5908 90A battery charger**.
- **9900 - PIWIS Tester 3**
- Torque wrench, 40-200 Nm (30-148 ftlb.), e.g. **V.A.G 1332A - Torque wrench, 40-200 Nm (30-148 ftlb.)**
- Headlight beam setter, e.g. **VAS 5208A headlight beam setter** or **VAS 621 001 headlight beamsetter**

Additional tools required for vehicles with Night View Assist (M No. 9R1)

- **VAS 6430/1A - Adjustment device with reflector**
- **VAS 6430/6 - Night View Assist calibration unit**
- **VAS 6350A - Calibration unit**

Additional tools required for vehicles with adaptive cruise control ACC (M No. 3V2 or 3V9)

- **VAS 6430/1A - Adjustment device with reflector**
- **VAS 6430/3 - Mirror for adjustment device**

Preliminary work

- Work Procedure: 1 Remove front underbody cover. ⇒ *Workshop Manual '519219 Removing and installing front underbody cover'*
- 2 Remove front bumper. ⇒ *Workshop Manual '631519 Removing and installing front bumper'*
- 3 Remove outside temperature sensor. ⇒ *Workshop Manual '916819 Removing and installing outside temperature sensor'*
- 4 **If available:** Remove control unit for distance measuring sensor. ⇒ *Workshop Manual '278519 Removing and installing control unit for distance measuring sensor'*
- 5 **If available:** Remove camera for night vision system. ⇒ *Workshop Manual '908019 Removing and installing camera for night vision system'*

Replacing driver assistance systems holder

- Work Procedure: 1 Loosen and unscrew screws ⇒ *Pedestrian protection -1-* on pedestrian protection ⇒ *Pedestrian protection -2-*.

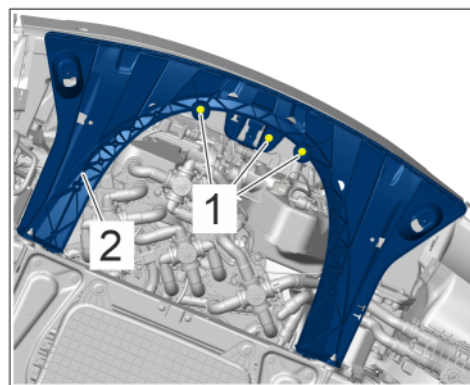

Pedestrian protection

- 2 **If the vehicle has a night vision camera:** Release and pull hose for cleaning system ⇒ *Hose for cleaning system -3-* on cleaning nozzle ⇒ *Hose for cleaning system -4-*.

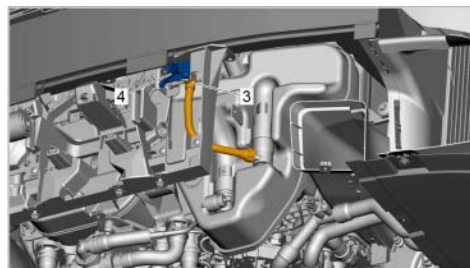

Hose for cleaning system

3 Loosen screws \Rightarrow *Removing driver assistance systems holder -5-* and remove the driver assistance systems holder.

4 **If the vehicle has a night vision camera:**

4.1 Loosen and unscrew remaining screw \Rightarrow *Cleaning nozzle -6-* on the cleaning nozzle \Rightarrow *Cleaning nozzle -4-* and remove the cleaning nozzle.

4.2 Insert cleaning nozzle \Rightarrow *Cleaning nozzle -4-* into the **new** holder for driver assistance systems and fasten with left screw \Rightarrow *Cleaning nozzle -6-*.

Tightening torque 4Nm Nm (3 ftlb.) (3ftlb.)

5 Insert **new** driver assistance systems holder and fasten with screws \Rightarrow *Installing driver assistance systems holder -5-*.

Tightening torque 8Nm Nm (5.9 ftlb.) (6 ftlb.)

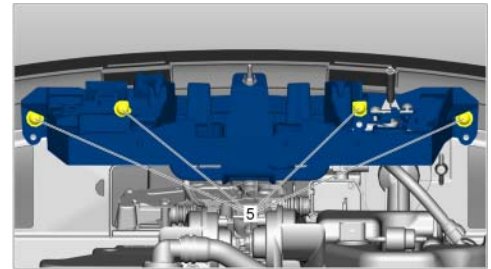

Removing driver assistance systems holder

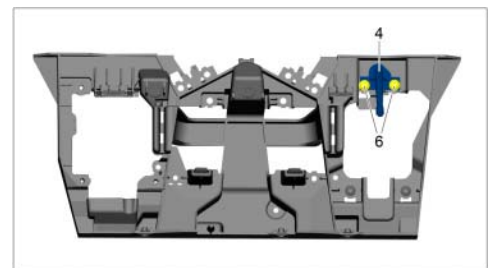

Cleaning nozzle

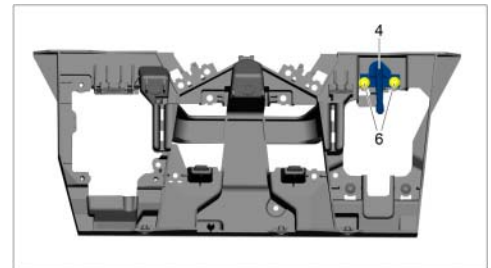

Cleaning nozzle

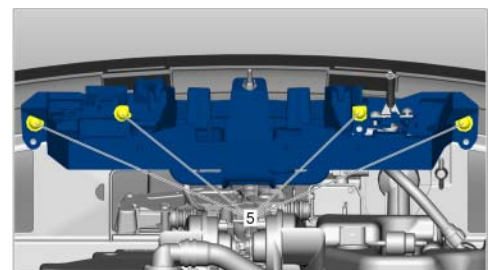

Installing driver assistance systems holder

- 6 **If the vehicle has a night vision camera:** Connect and lock hose for cleaning system ⇒ *Hose for cleaning system -3-* on cleaning nozzle ⇒ *Hose for cleaning system -4-*.
- 7 Fit and tighten screws ⇒ *Pedestrian protection -1-* for pedestrian protection ⇒ *Pedestrian protection -2-*.

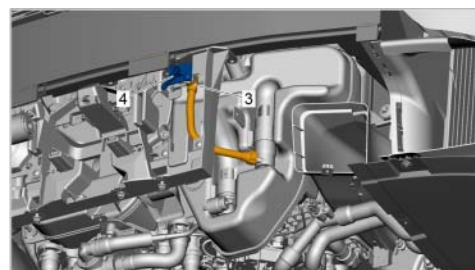

Hose for cleaning system

Tightening torque 6Nm Nm (4.4 ftlb.) (4.5 ftlb.)

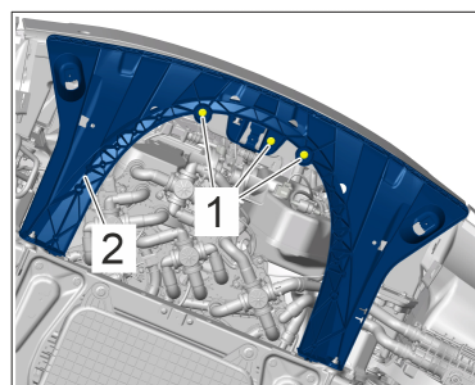

Pedestrian protection

Concluding work

- Work Procedure: 1 **If available:** Install camera for night vision system. ⇒ *Workshop Manual '908019 Removing and installing camera for night vision system'*
- 2 **If available:** Installing control unit for distance measuring sensor. ⇒ *Workshop Manual '278519 Removing and installing control unit for distance measuring sensor'*
- 3 Install outside temperature sensor. ⇒ *Workshop Manual '916819 Removing and installing outside temperature sensor'*
- 4 Install front bumper. ⇒ *Workshop Manual '631519 Removing and installing front bumper'*



Information

Adjust the headlights before installing the front trim (engine compartment); see Step 6.

- 5 Install front underbody cover. ⇒ *Workshop Manual '519219 Removing and installing front underbody cover'*
- 6 Adjust headlights. ⇒ *Workshop Manual '941516 Adjusting headlights'*

- 7 **If available:** Adjust control unit for distance measuring sensor. ⇒ *Workshop Manual '278515 Adjusting control unit for distance measuring sensor'*
- 8 **If available:** Calibrate camera for night vision system.
For instructions, see: ⇒ *Workshop Manual '908055 Replacing camera for night vision system'*
- 9 Enter the campaign in the Warranty and Maintenance booklet.

Warranty processing



Information

The specified working time was determined specifically for carrying out this campaign and includes all necessary preliminary and subsequent work.

The working time may differ from the working times published in the Labor Operation List in the PCSS.



Information

Every vehicle is assigned just one campaign scope.

⇒ To find out which scope is assigned to the vehicle, see PCSS Vehicle Information.

Scope 1:

Replacing driver assistance systems holder

Vehicle with:

- Adaptive cruise control (ACC) (M No. 3V2 or 3V9)

and

- Night View Assist (M No. 9R1)

Labor time:

Replacing driver assistance systems holder

Labor time: **386 TU**

Includes:

- Removing and installing driver assistance systems holder
- Connecting and disconnecting battery charger
- Connect and disconnect PIWIS Tester
- Adjusting headlights
- Removing, installing and adjusting control unit for distance measuring sensor
- Removing, installing and calibrating camera for night vision system
- Select and erasing fault memories

Required parts:

PAD907390E	Driver assistance system holder	1 piece
⇒ Damage Code WNEO 066 000 2		

Scope 2: **Replacing driver assistance systems holder**

Vehicle with:

- Adaptive cruise control (ACC) (M No. 3V2 or 3V9)

Labor time:		
Replacing driver assistance systems holder		Labor time: 340 TU
Includes:	Removing and installing driver assistance systems holder Connecting and disconnecting battery charger Connect and disconnect PIWIS Tester Adjusting headlights Removing, installing and adjusting control unit for distance measuring sensor Select and erasing fault memories	
Required parts:		
PAD907390E	Driver assistance system holder	1 piece
⇒ Damage Code WNEO 066 000 2		

Scope 3: **Replacing driver assistance systems holder**

Vehicle with:

- Night View Assist (M No. 9R1)

Labor time:		
Replacing driver assistance systems holder		Labor time: 343 TU
Includes:	Removing and installing driver assistance systems holder Connecting and disconnecting battery charger Connect and disconnect PIWIS Tester Adjusting headlights Removing, installing and calibrating camera for night vision system Select and erasing fault memories	
Required parts:		

PAD907390E	Driver assistance system holder	1 piece
------------	---------------------------------	---------

⇒ Damage Code WNEO 066 000 2

Scope 4: **Replacing driver assistance systems holder**

Vehicles **without**:

- Adaptive cruise control (ACC) (M No. 3V2 or 3V9)

and without

- Night View Assist (M No. 9R1)

Labor time:

Replacing driver assistance systems holder

Labor time: **270 TU**

Includes: Removing and installing driver assistance systems holder

Connecting and disconnecting battery charger

Connect and disconnect PIWIS Tester

Adjusting headlights

Select and erasing fault memories

Required parts:

PAD907390D	Driver assistance system holder	1 piece
------------	---------------------------------	---------

⇒ Damage Code WNEO 066 000 2

Important Notice: Technical Bulletins issued by Porsche Cars North America, Inc. are intended only for use by professional automotive technicians who have attended Porsche service training courses. They are written to inform those technicians of conditions that may occur on some Porsche vehicles, or to provide information that could assist in the proper servicing of a vehicle. Porsche special tools may be necessary in order to perform certain operations identified in these bulletins. Use of tools and procedures other than those Porsche recommends in these bulletins may be detrimental to the safe operation of your vehicle, and may endanger the people working on it. Properly trained Porsche technicians have the equipment, tools, safety instructions, and know-how to do the job properly and safely. Part numbers listed in these bulletins are for reference only. The work procedures updated electronically in the Porsche PIWIS diagnostic and testing device take precedence and, in the event of a discrepancy, the work procedures in the PIWIS Tester are the ones that must be followed.

© 2022 Porsche Cars North America, Inc.