



SIB 64 08 21

2022-06-21

AC Temperature Fluctuation or Loss of Cooling N63 S63 N74

AC TEMPERATURE FLUCTUATION OR LOSS OF COOLING N63 S63 N74

This Service Information Bulletin (Revision 1) replaces B64 08 21 dated September 2021

Whats New:

- Procedure: Tool number correction

MODEL

F90 (M5 Sedan)	F91 (M8 Convertible)	F92 (M8 Coupe)	F93 (M8 Coupe)
F95 (X5 M)	F96 (X6 M)	G05 (X5 SAV)	G05 (X6 SAC)
G07 (X7 SAV)	G12 (7 Series Sedan)	G14 (8 Series Coupe)	G15 (8 Series Convertible)
G16 (8 Series Gran Coupe)	G30 (5 Series Sedan)	G32 (6 Series Gran Turismo)	

Vehicles equipped with N63, S63 V8 engines or N74 V12 engine.

SITUATION

Please refer to the attached pdf (B64 08 21)

Supporting Materials

[picture_as_pdf B640821_REV01.pdf](#)

Service Information Bulletin

Heating and Air Conditioning

June 21,2022

B64 08 21

AC TEMPERATURE FLUCTUATION OR LOSS OF COOLING N63 S63 N74

This Service Information Bulletin (Revision 1) replaces B64 08 21 dated September 2021

Whats New:

- Procedure: Tool number correction

MODEL

F90 (M5 Sedan)	F91 (M8 Convertible)	F92 (M8 Coupe)	F93 (M8 Coupe)
F95 (X5 M)	F96 (X6 M)	G05 (X5 SAV)	G05 (X6 SAC)
G07 (X7 SAV)	G12 (7 Series Sedan)	G14 (8 Series Coupe)	G15 (8 Series Convertible)
G16 (8 Series Gran Coupe)	G30 (5 Series Sedan)	G32 (6 Series Gran Turismo)	

Vehicles equipped with N63, S63 V8 engines or N74 V12 engine.

SITUATION

The air conditioning cycles from cold to warm air while driving or while at a stand still.

The vent outlet temperatures vary by 25 degrees Fahrenheit or more (38 F to 60 F +) without changing any climate control settings.

In some cases the air conditioning may have stopped blowing cold air altogether.

CAUSE

The control valve within the air conditioning compressor is obstructed by debris (fine particles).

CORRECTION

Perform the following checks in order to identify one or more of the following root causes.

- Locate and repair leaks
- Recharge system
 - For information on R-1234yf refrigerant refer to [SI B64 03 16](#)
 - For information servicing vehicles with R-1234yf refrigerant refer to [SI B04 02 16](#).
- Replace air conditioning compressor
- Flush/Rinse air conditioning system to clean out debris
 - Use 'Rinse' instead of 'Flush' when searching in ISTA
 - When blowing thru lines to remove foreign particles it is recommended to use refrigerant with the AC flushing system. If the AC flushing system is not available then the lines can be blown thru using compressed Nitrogen (preferred due to low moisture content) or compressed air that has gone thru a water filter/separator (acceptable)

PROCEDURE

Perform the following checks to identify the root cause:

1. Reproduce the situation described above.

For maximum AC operation with minimal outside humidity influence test system with the following settings:

- Windows and sunroof closed.
- Fresh air on Recirc (recirculation) mode.
- Stratified air set between middle and maximum cold (blue).
- Climate set to AUTO
- MAX AC

2. Check the drive belt of the compressor.
3. If drive belt is okay then check if the pulley of the air conditioning compressor is able to spin freely when not energized.
 - If the belt pulley is not moving freely the air conditioning compressor is faulty and should be replaced. Replace the air conditioning compressor according to the repair instructions.
 - If belt pulley is moving freely then connect the diagnosis tester and perform a vehicle test. Follow test plans for any stored climate control related fault codes.
4. Read out the temperature value of the evaporator temperature sensor via ISTA. The path in ISTA is as follows:

Service functions -> Heating and air conditioning functions -> Temperature sensors -> Test module for heating and air conditioning functions: Run temperature sensors. If the temperature value is **plausible**: the air conditioning compressor is not faulty. **Continue diagnosis.**

If temperature value is **implausible** (Never gets cold or goes below freezing):

Check AC system pressures.

Check if there is sufficient refrigerant in the AC system.

Carry out leak detection, locate and repair leak.

5. If there is sufficient refrigerant in the refrigerant circuit then the control valve in the air conditioning compressor is likely obstructed.

Proceed with

- step 6 **Procedure if flushing equipment is available** for the refrigerant circuit
- or**
- step 23 **Procedure if NO flushing equipment is available** for the refrigerant circuit

6. **Procedure if flushing equipment is available for the refrigerant circuit-** Observe repair instructions
 - 64 50 770 "Flush refrigerant circuit"
 - Important: Follow Repair Instructions 64 50 775
 - Evacuate refrigerant circuit (if not done already)

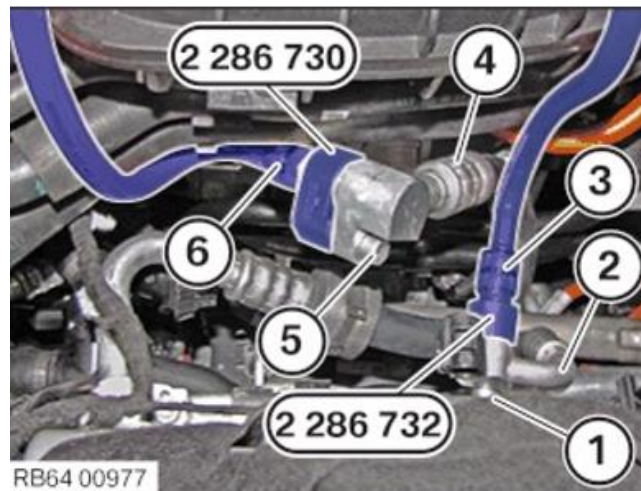

7. Remove and then bypass the air conditioning compressor with two flushing adapters.
 - Mount the special tool **2 286 732** onto the high-pressure line (2) of the air conditioning compressor and secure with the M8 screw (1) that is on the vehicle.
 - Mount the special tool **2 286 730** onto the low-pressure line (4) of the air conditioning compressor and secure with the M8 screw (5) that is on the vehicle.
 - **M8 Bolts Torque 19 Nm.** Two persons, one holding the adapter and the other tightening to torque simplifies the process.
 - These adapters are connected via a jumper hose such as **83 30 2 285 575**

These two special tools are part of the BMW i basic adapter set **83 30 2 413 236**.

If servicing a **G05 hybrid vehicle a second special tool 83 30 2 286 732 is also required** so you will need two 83 30 2 413 236 kits. Refer to Repair Instructions

NOTE: These pictures are for example purposes. Some parts may differ in certain details depending on model.

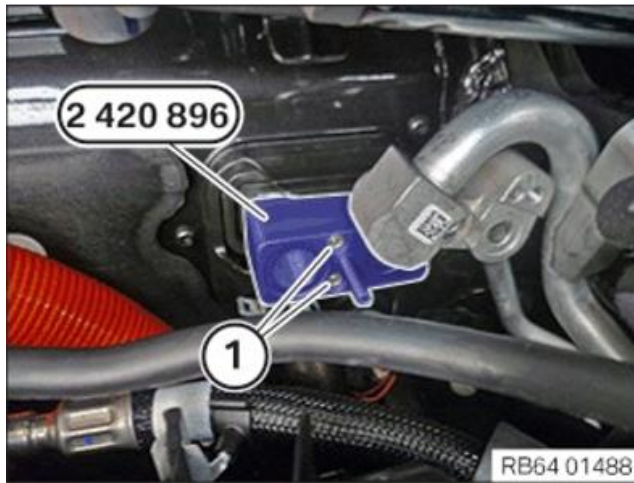

8. Remove and then bypass the expansion valve with flushing adapter **83 30 2 412 530**.
- The flushing adapter will have a hole on both inlet and outlet as seen on the left.
 - There are identical shaped block off plates available for pressure testing which have no holes and will not allow for flushing. Do not use a solid adapter such as part number **2 420 896** if the evaporator is to be flushed!
 - Fasten with the M5 screws (1) of the expansion valve that has been previously removed.
 - **M5 Bolts Torque 5.5 Nm**
 - Attach the refrigerant lines to the special tool and secure with the M6 screw that has been previously removed.
 - **M6 Bolts Torque 13 Nm**
 - To reach the expansion valve by laying across the engine compartment you could use the padded board special i8 Tool **81 49 2 288 435** and foam pad fender covers **81 47 2 409 091**

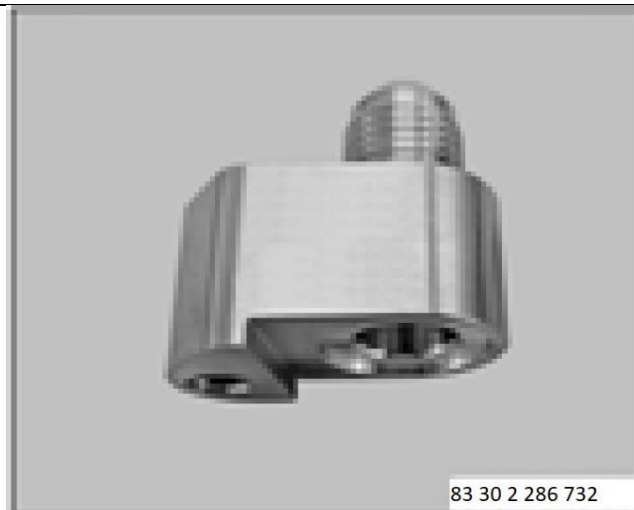

9. The condenser must be bypassed since it is a non-flushable component. Disconnect condenser hoses and bypass with flushing adapter **83 30 2 286 732** or **83 30 2 412 932** based on thread size and **83 30 2 414 998**. Connect the two adapters with connecting hose **83 30 2 285 575**

This step may not yet be included in all ISTA repair instructions. This adds one additional vehicle AC hose to the flush circuit



10. There are plastic push tabs that must be depressed to release the AC condenser from the cooling module. This is on the driver's side.



11. There are plastic push tabs that must be depressed to release the AC condenser from the cooling module. This is on the passenger's side.



12. The flush machine (Robinair or Mahle manufactured) will come with hoses, filter, and hardware. Pictures are of the Mahle flush kit as received.

The adapters to connect to the AC machine come with the flushing machine.

There are adapters for both R134a and Y1234a.



13. Only the R134a adapters fit the quick disconnects of the AC machine.

The **Y1234a** adapter fits the low side quick disconnect of the AC machine, however **the high side must have the quick disconnect fitting removed (left) in order to install the brass adapter** for connection. The O-ring seen in the picture, removed from the high side quick disconnect, must not be installed onto the brass adapter. This additional O-ring will not allow for full compression of the fittings when tightening resulting in a leak from the brass adapter.



14. High side brass swivel fitting adapter for Y1234a high side connection.



15. Y1234a high side adapter installed in place of the quick disconnect

AC Flush circuit yellow hose (top), brass swivel adapter, and AC Flush machine high side red hose (bottom).

Mahle



16. Connect the air conditioning service device (AC Recycling machine and flushing adapter) to the cable connections. Follow instructions from the flushing adapter instruction manual on proper hose connections to the vehicle.

It is best to leave the yellow hose loose at the flush machine, make your connection to the vehicle, then tighten the hose at the flush machine.

Robinair



Pneumatic diagram

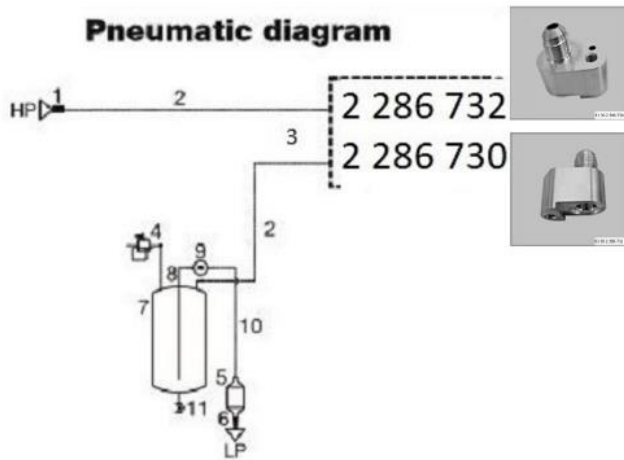

1	HP outlet adapter fitting
2	High-flow connection hoses
3	Item to be flushed
4	Safety valve 18 bar / 261 psi
5	Filter 15 µm
6	LP fitting
7	6 liter fluid vessel
8	Connection hose between vessel and sight glass
9	Fluid indicator sight glass with cap
10	Connection hose between sight glass and filter
11	Auxiliary valve with cap

17. Once all hoses are connected, mark one or both of the hoses to ensure proper connection of the flushing equipment. (i.e. Red hi side, Blue low side) You cannot flush the system backwards due to the orifice sizes on inlet/outlet of the expansion valve bypass.

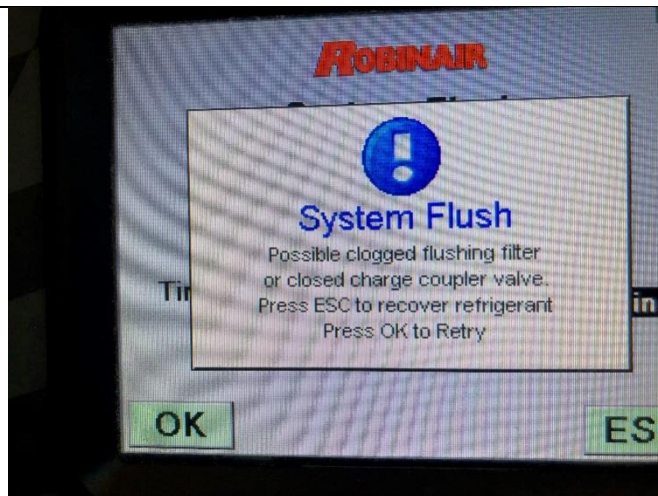

18. The filter on the flushing cannister must be replaced on a regular basis to ensure no contamination entering the AC machine.

- This filter should be replaced after flushing 5 vehicles maximum.
- **TIP:** To track filter usage a permanent marker or a paint line can be placed on the filter every flush. After 5 lines it's time to replace.
- If the filter is plugged some AC machines (Robinair) will display an error message "System Flush not possible clogged flush filter"



19. The flush procedure requires 4+ kg of refrigerant in the Internal Storage Vessel (ISV) tank within the AC flush machine. If there is an insufficient amount of refrigerant in the ISV the flush procedure will not start and will prompt an error message “Insufficient Refrigerant”. The amount of refrigerant allowed in the ISV when the AC flush machine transfers from the external tank is set in the machines settings menu. You may have to go into the menu of the AC machine to set the ISV amount. Follow instructions of the AC flush machine manufacturer.

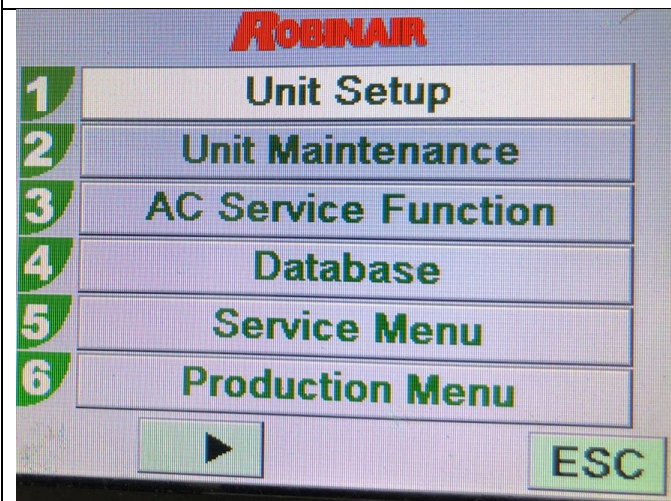

20. **For example** on the Robinair AC1234-6 machine to change the amount of stored refrigerant in the ISV go to UNIT SETUP
TANK FILL ADJUSTMENT
enter the amount required.
NOTE: On this Robinair AC machine there is 0.9 kg of refrigerant within the system that is not displayed in the ISV tank level. So to get an actual 4 kg of refrigerant you would need to set the tank level to at least 4.9 kg for the flush procedure to run.

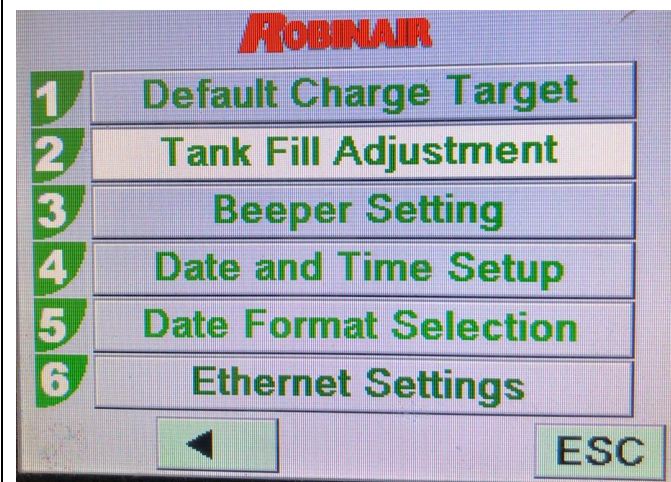



21. A 30-minute flush is recommended. The default value on the AC flush machine may only be 10 minutes. You won't see an option to extend this flush time until **AFTER** the machine has performed its vacuum and pressure tests.

Observe the sight glass on the flush machine at beginning and end of flushing. There should be no debris visible at the end of flushing.



22. After flushing

- Install a new air conditioning compressor, expansion valve and air conditioning condenser. according to the repair instructions.
NOTE: if the refrigerant circuit has been flushed it is not necessary to adjust the amount of refrigerant oil when a new air conditioning compressor is installed due to the 'factory oil fill' being sufficient for the entire system.
- Contact Teileclearing for compressors that are on the TC list.
- Remove flushing adapter and replace expansion valve.
- Replace all O-rings where the system was opened.
- Fill the air conditioning system with refrigerant.
- Dye may be added to the fill to allow for expedited leak identification in case of a problem. Only use a minimal amount of dye concentrate per the manufacturer's

	<p>recommendation (typical 2-3 drops)</p> <ul style="list-style-type: none"> • Make sure compressor run in test plan is completed with ISTA. • Reassess the vehicles AC operation. <p><u>Repair is complete.</u></p>
<p>23. Procedure if no flushing equipment is available for the refrigerant circuit. Evacuate refrigerant circuit (if not done already). Then replace the air conditioning compressor, expansion valve and air conditioning condenser.</p> <p>Observe oil fill capacity for replaced parts. The oil capacity for the compressor is printed either on a separate tag that comes in the parts box, or directly on the label on the compressor.</p> <ul style="list-style-type: none"> • See Repair instructions for 'opening and part exchange in refrigerant circuit' for oil to be added for additional parts that are to be replaced. • Contact Teileclearing for compressors that are on the TC list. • use compressed Nitrogen/air to blow out the lines/evaporator. • Replace all O-rings where the system was opened. • Evacuate and fill the air conditioning system • Dye may be added to the fill to allow for expedited leak identification in case of a problem. Only use a minimal amount of dye concentrate per the manufacturer's recommendation (typical 2-3 drops) • Make sure compressor run in test plan is completed with ISTA • Reassess the vehicles AC operation. <p><u>Repair is complete.</u></p>	
	<p>24. If you want to document time spent on this repair please submit an INFO ONLY TSARA case</p> <p>If you require further technical support please submit a REPLY REQUESTED TSARA case.</p>

PARTS INFORMATION

Obtain and confirm the part numbers for your specific vehicle by entering the chassis number in either ETK or AIR which takes into account specific equipment and/or options.

WARRANTY INFORMATION

This Service Information Bulletin provides technical, diagnostic, and repair-related information.

Damage and/or issues caused by outside influences are not covered under the BMW limited warranties.

Eligible and Covered Work/Repairs

When used to repair a verified defect in materials or workmanship, the repair procedure information provided in this bulletin is covered under the terms of the BMW New Vehicle Limited Warranty for Passenger Cars and Light Trucks.

To submit a claim, please follow the established and applicable warranty policy and procedures (Labor/Part/Sublet) that apply to the repair being performed.

Refer to AIR for the corresponding Defect Code, flat rate labor operations (including diagnosis) and the flat rate unit (FRU) allowances.

Only one Main labor operation code can be claimed per repair visit.

Based on which one applies to your center, please refer to **SI B01 01 20** or **B01 07 20** for claiming your diagnosis work time, job/repair work time (WT), RO/Claim WT and/or repair explanation procedures, unless otherwise required by State law.

FEEDBACK REGARDING THIS BULLETIN

Technical Feedback	To submit feedback for the technical topics of this bulletin: Submit your feedback in the rating box at the top of this bulletin
Warranty Feedback	To submit feedback for the CLAIMS section of this bulletin: Submit an IDS ticket to the Warranty Department, or use the chat available in the Warranty Documentation Portal
Parts Feedback	To submit feedback for the PARTS section of this bulletin: Submit an IDS ticket to the Parts Department