

Trailer hitch (I-no. 1D6)

Revision: This bulletin replaces Group 6, #29/18, dated January 8, 2021.

Model Year: **As of 2018**

Information: **Retrofitting**

Note: The new Cayenne can be retrofitted with a trailer hitch (). Note the following special features:

- Permissible tongue weight of 140 kg
- Totally versatile wading depth
- Convenient loading and safe parking is assured by removing the ball hitch/bar (mechanical trailer hitch – 1D6)
- Plug socket preparation for USA version
- Payload following installation, restricted by higher vehicle kerb weight!
- Gross vehicle weight and axle load must not be exceeded!
- Vehicles with painted wheel arch extensions (6GH/6GJ/6GK or SportDesign package) require **NEW** wheel arch extensions (rear), which must be ordered separately!
- Vehicles with SportDesign package Carbon (2D3 or PD1/PD2/PD3) require a **NEW** rear panel, which must be ordered separately.

The trailer hitches for the respective market are also available straight from the factory for new vehicles by requesting optional equipment "1D6" = mechanical trailer hitch .

Parts Info: **ONLY** for vehicles up to production date 16.08.2020:

9Y0.044.840.01 ⇒ Trailer hitch, mechanical – USA (1D6)

ONLY for vehicles as of production date 17.08.2020:

9Y0.044.840.04 ⇒ Trailer hitch, mechanical – USA (1D6)

ONLY for vehicles with Comfort Access (4F2/4F6 – Powerlift tailgate with virtual pedal): Also order the following:

WHT.005.450 8 x ⇒ Tie-wrap

ONLY for vehicles with SportDesign package Carbon (2D3 or PD1 / PD2 / PD3): Also order the following, depending on country/market:

9Y0.807.834.H.03G 1 x ⇒ Rear panel - open, shiny carbon, black – USA

ONLY for vehicles with painted wheel arch extensions (6GH/ 6GJ/ 6GK or SportDesign package) in accordance with country/market - also order the following:

- 9Y0.854.731.J.G2X** 1 x ⇒ Wheel cover, rear left; ready-primed - USA (6GH)
9Y0.854.732.J.G2X 1 x ⇒ Wheel cover, rear right; ready-primed - USA (6GH)

Parts list:

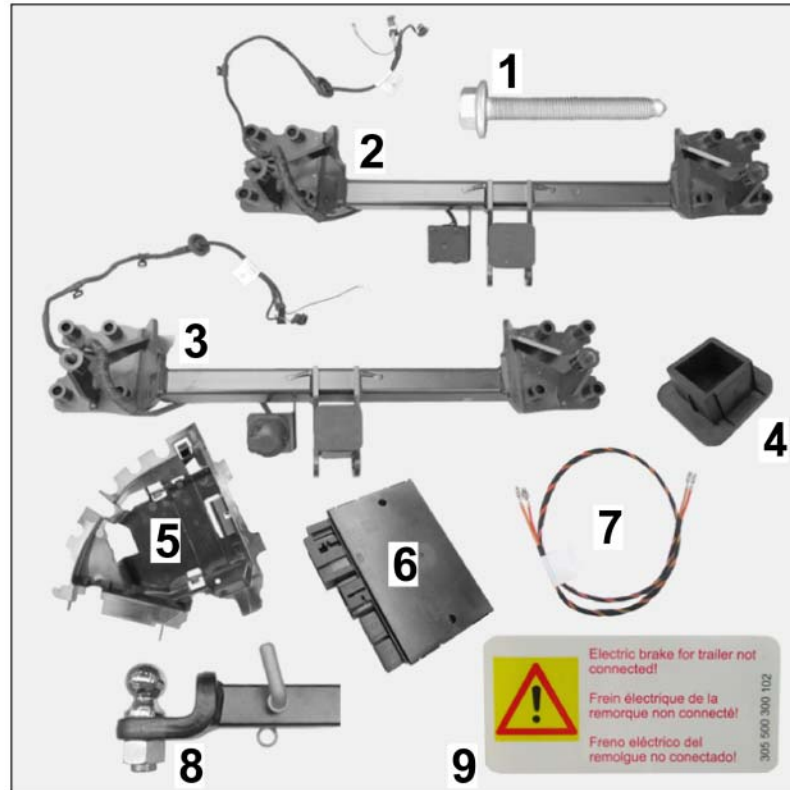

Figure 1

Parts included with trailer hitch – mechanical – USA/Canada (1D6 ⇒ Figure 1):

- | | | |
|-----------------------------|------|--|
| PAF.910.398.02 | 8 x | Hexagon-head bolt, M12 x 1.5 x 90 ⇒ Figure 1 -1- |
| 9Y0.803.881.A | 1 x | Trailer hitch incl. wire harness – USA/Canada (1D6) ⇒ Figure 1 -2- |
| 955.722.030.00 ¹ | 1 x | Stopper for trailer hitch ⇒ Figure 1 -4- |
| 9Y0.907.297 | 1 x | Trailer hitch control unit bracket ⇒ Figure 1 -5- |
| 9A7.907.383.01 | 1 x | Trailer hitch control unit ⇒ Figure 1 -6- |
| PAB.907.383.A | 1 x | Trailer hitch control unit (not shown) |
| — — — | 1 x | Wiring harness for power supply (terminal 30) ⇒ Figure 1 -7- |
| 955.044.000.28 | 1 x | Ball hitch –removable– USA/Canada ⇒ Figure 1 -8- |
| — — — | 1 x | "Electric Brake" sticker – identification ⇒ Figure 1 -9- |
| — — — | 10 x | Tie-wrap, 150 mm (not shown) |

¹ Already installed on the trailer hitch!

Notes: Further information/Technical values, instructions for using the trailer hitch and "Driving with a trailer":
 ⇒Cayenne Driver's Manual – "Trailer Hitch", "More Safety and More Driving Pleasure"

Tools:	Nr.88 - Torque angle torque wrench 9900 - PIWIS Tester 3 Saw or vibrating knife Tap, M12 x 1.5 Side cutters Plastic wedge Knife	VAS 6933 Disassembly tool Steel drill bit, Ø up to 8.0 mm Drill Round/flat file Flat scraper Electric torch
--------	---	---

- Installing:
- 1 Preparatory work
 - 1.1 Connect battery charger (⇒ *Workshop Manual '2X00IN Trickle charging 12-volt lithium-ion battery*).
 - 1.2 Raise the vehicle (⇒ *Workshop Manual '4X00IN Lifting the vehicle*)
 - 1.3 Remove rear bumper (⇒ *Workshop Manual '635019 Removing and installing rear bumper*)
 - 1.4 Expose connector B (6-pin)/connector C (10-pin) on trailer hitch preparation near the fuse box in the luggage compartment (⇒ *Figure 2*).
 - 1 – Connector B (6-pin)/connector C (10-pin)
 - 2 – Ground pin MB25
 - 3 – Fuse box in luggage compartment, left

Carefully remove foam.
 - 1.5 **ONLY** for –mechanical– trailer hitch (1D6):
 Expose connection point (connector, 2-pin) for brake booster preparation in the luggage compartment area at the left.
 - 1.6 Check that the bolt threads and contact surfaces for securing the trailer hitch are not dirty. Clean them and re-cut the threads using an M12 x 1.5 tap if necessary.

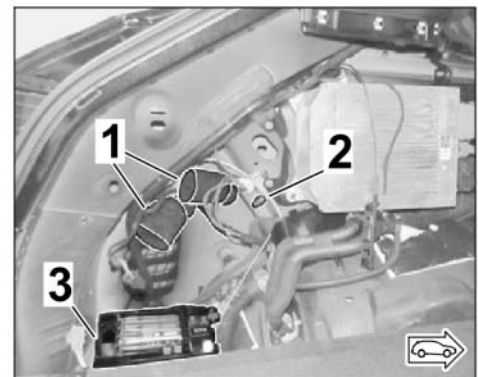

Figure 2

NOTICE

Incorrect line routing

- Risk of damage to lines and hoses
- Malfunction and fault memory entry on control unit

- ⇒ Avoid small bending radii when routing lines.
- ⇒ File down edges and burrs in the routing area or mask them with adhesive tape.
- ⇒ Maintain a sufficient distance from components exposed to high temperatures while driving.

- 1.7 **ONLY** for vehicles with Comfort Access (4F2/4F6) – Powerlift tailgate with virtual pedal:
Convert "Virtual pedal" antenna line in the rear apron

- 1 – "Virtual pedal" antenna line
- 2 – Control unit for "Virtual pedal" antenna line
- 3 – Positions of tie-wraps on adhesive pads
- 4 – Tie-wrap with adhesive pad
- 5 – New line routing for "Virtual pedal" antenna line

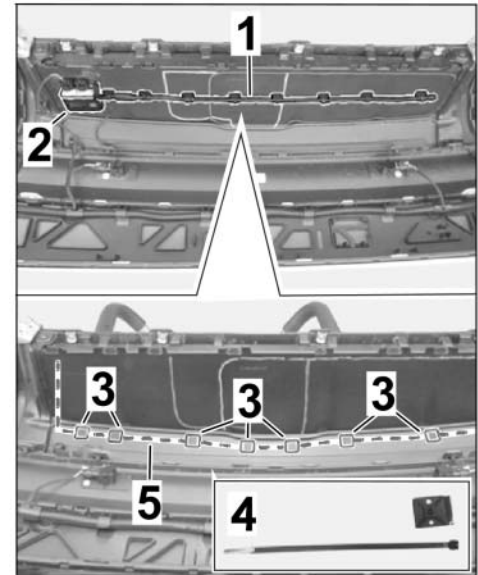

Figure 3

- 1.7.1 Carefully remove "Virtual pedal" antenna line with holder and tie-wraps (7 x) from the inside of the rear apron (⇒ *Figure 3-1-*).
- 1.7.2 Carefully cut open tie-wraps on adhesive pads and remove tie-wraps (7 x) from antenna line.
- 1.7.3 Clean bonding area in the new antenna line routing area to remove any dust and grease (⇒ *Figure 3-3-*).
- 1.7.4 Stick on new adhesive pads (7 x) with tie-wraps at the markings.
- 1.7.5 Secure "Virtual pedal" antenna line in new tie-wraps (7 x) and cut off excess length of tie-wraps.

- 1.8 **ONLY** for vehicles **WITH** SportDesign package Carbon (2D3 or PD1 / PD2 / PD3):
Replace rear panel – closed (carbon gloss, black) with new rear panel – open (carbon gloss, black) (⇒ *Workshop Manual '63561940 Removing and installing rear panel (moulding)*)



Information

Mask the sawing area to prevent damage.

- 1.9 **ONLY** for vehicles **WITHOUT** SportDesign package Carbon (2D3 or PD1/PD2/PD3):
Make a cut-out for the (removable/pivoting) ball hitch in the rear apron.

1.9.1 Remove rear panel (moulding) in black matt (2JB) or stainless steel (2JX) on the bottom of the rear apron (⇒ *Workshop Manual '63561940 Removing and installing rear panel (moulding)*).

1.9.2 Mark the cut-out for the ball hitch (removable – USA) at the impression on the inside of the rear apron (⇒ *Figure 4 -top-*).

- 1 – Red = Marking for cut-out for removable ball hitch
- 2 – Yellow = not applicable
- 3 – Not applicable

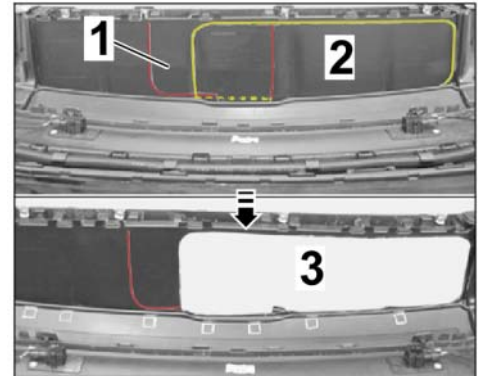

Figure 4

1.9.3 Carefully make the cut-out at the marking (⇒ *Figure 4 -bottom-*).

1.9.4 De-burr cut edges with a knife or file.

1.9.5 Install rear panel (moulding) in black matt (2JB) or stainless steel (2JX) on the bottom of the rear apron (⇒ *Workshop Manual '63561940 Removing and installing rear panel (moulding)*).

2 Install trailer hitch

2.1 Secure trailer hitch to the vehicle

2.1.1 Install the trailer hitch using 8 new bolts (M12 x 1.5 x 90) at the left and right and tighten hand-tight.

- 1 – Trailer hitch (Non-US version shown)
- 2 – Screw, M12 x 1.5 x 90

2.1.2 Align bolt guides for the trailer hitch (8 x) symmetrically with respect to the 8 bolt heads (M12 x 1.5 x 90) (⇒ *Figure 5 -inset-*).

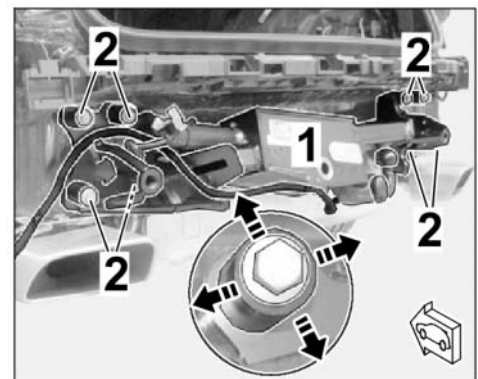

Figure 5

2.1.3 Tighten trailer hitch fully.
tightening torque 110 Nm(81.1 ftlb.)

2.2 Route electric wire harness for trailer hitch in the passenger compartment (see also ⇒ *Workshop Manual '972419 Removing and installing wire harness for trailer hitch*)

2.2.1 Remove dummy plug (Ø 40 mm) from side panel on the vehicle at the left and guide wire harness for trailer hitch into the luggage compartment.

- 1 – Wire harness for trailer hitch
- 2 – Rubber sleeve (wire harness)
- 3 – Tie-wrap

2.2.2 Insert rubber sleeve (wire harness) into the bore (Ø 40 mm) on the body.

2.2.3 Install tie-wraps for wire harness (2 x) on threaded bolts on the outside of the vehicle (⇒ *Figure 6*).

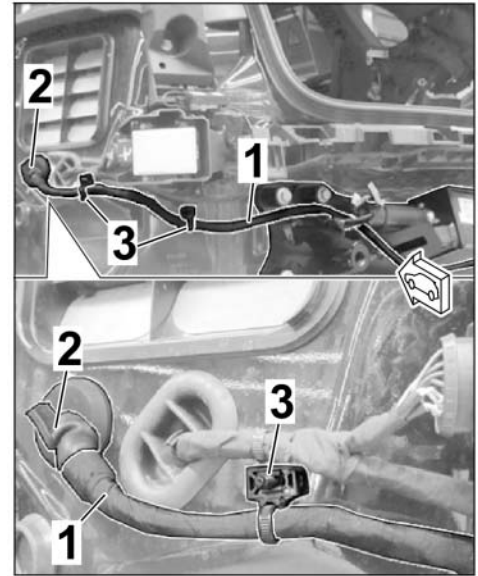

Figure 6

2.3 Check pin assignment in connector B on the vehicle side (6-pin; trailer hitch preparation ⇒ *Figure 7*).

- 1 – Connector B (6-pin; trailer hitch preparation)
- 2 – Connector B, chamber 1
- 3 – Connector B, chamber 6
- 4 – Fuse holder H (strip B – white)

Are chambers 1 (swivel motor) and 6 (charge line) - both on terminal 30 - used?

- Yes: Continue with Step 2.4
- No: Carry out the following work.

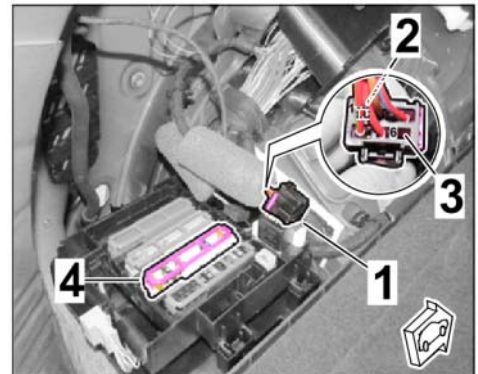

Figure 7

2.3.1 Remove fuse holder H (strip B – white) from the fuse box in the luggage compartment (⇒ *Workshop Manual '978409 Loosening and securing fuse box in the luggage compartment'* ⇒ *Figure 8-top-*).

- 1 – Fuse holder H (strip B – white)
- 2 – Cover on underside
- 3 – Latch on fuse holder
- 4 – RD/GN line 2.5²

2.3.2 Release fuse holder H (strip B – white) and connect the lines (RD/GN and RD/YE) as follows (⇒ *Figure 8-bottom-*):

- Chamber 6: RD/GN line 2.5² ⇒ Preparation for connector B, chamber 1 (swivel motor)
- Chamber 7: RD/YE line 2.5² ⇒ Preparation for connector B, chamber 6 (charge line)

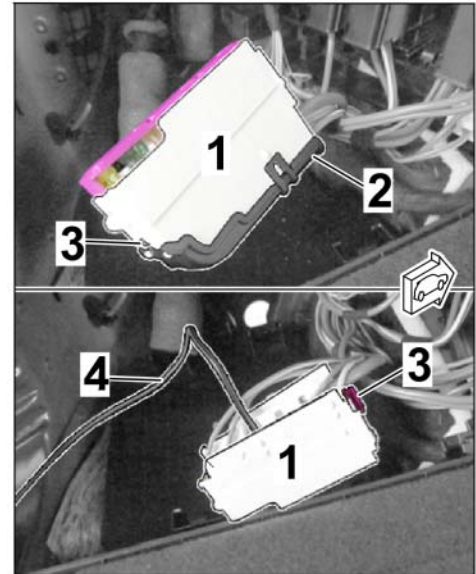

Figure 8

2.3.3 Lock connector housing strip B (color: white) and Install it into the fuse holder.

2.3.4 Install fuse holder H (strip B – white) in the fuse box in the luggage compartment (⇒ *Workshop Manual '978409 Loosening and securing fuse box in the luggage compartment'*).

2.3.5 Route RD/GN and RD/YE lines to connector B (preparation). (⇒ *Figure 9*).

- 1 – RD/GN and RD/YE lines
- 2 – Connector B (preparation)
- 3 – Fuse box in luggage compartment

Release connector B, connect lines RD/GN and RD/YE as described in Step 2.3.2 (⇒ *Figure 9-inset-*).

Lock connector B.

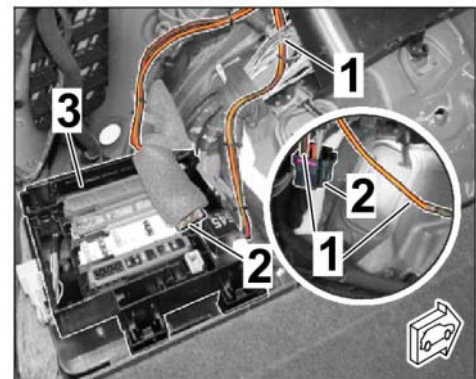

Figure 9

2.4 Install trailer hitch control unit in the luggage compartment area (left side panel)

- 1 – Trailer hitch control unit bracket
- 2 – Connector A – wire harness for trailer hitch
- 3 – Ground line 2.5² – BN
- 4 – Ground pin MB25

2.4.1 Disconnect any lines and hoses in the installation area.

2.4.2 Insert pins (2 x on underside of control unit bracket) into the body (⇒ *Figure 10-A* -)

2.4.3 Clip trailer hitch control unit bracket at the top into the web plate on the body (⇒ *Figure 10-B* -).

2.4.4 Guide connector A (wire harness for trailer hitch) and connector B/C (trailer hitch preparation) into the control unit bracket.

2.4.5 Install trailer hitch control unit into the bracket (⇒ *Figure 11*).

- 1 – Trailer hitch control unit
- 2 – Bracket

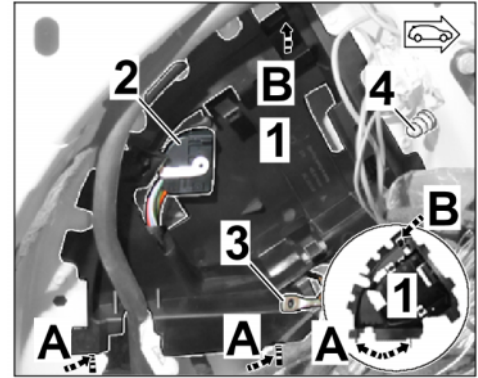

Figure 10

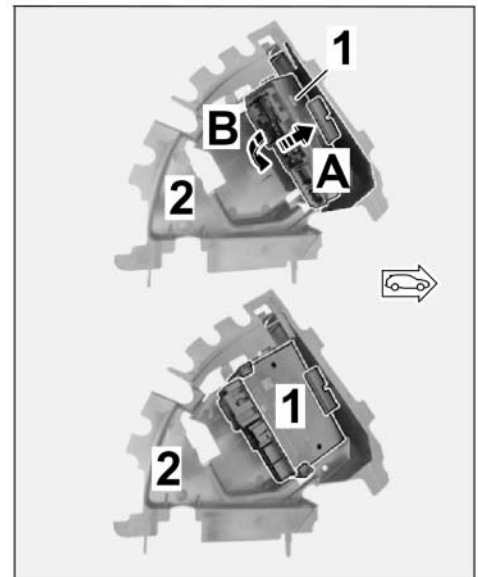

Figure 11

2.5 Install cable ring eyelet A6 at the ground pin MB25 (⇒ *Figure 12-2-*).

- 1 – Ground line BN 2.5²
- 2 – Ground pin MB25
- 3 – Connector A (wire harness for trailer hitch)
- 4 – Connector B (preparation)
- 5 – Connector C (preparation)
- 6 – Trailer hitch control unit

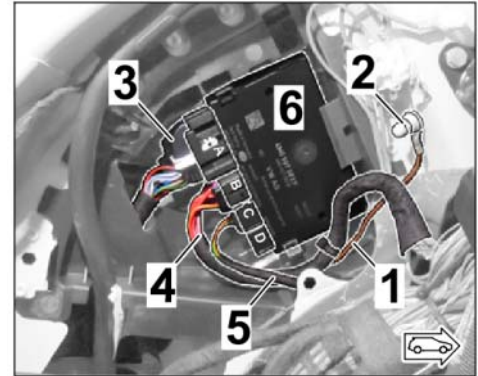

Figure 12

2.6 Connect plug connections for connector A/B/C to the trailer hitch control unit (⇒ *Figure 12*).

2.7 **ONLY** for –mechanical– trailer hitch (1D6):

2.7.1 Connect plug connection (2-pin ⇒ *Figure 13*) for brake booster preparation in the luggage compartment area at the left.

- 1 – Connector (2-pin) – brake booster preparation
- 2 – Connector A
- 3 – Ground line BN 2.5²

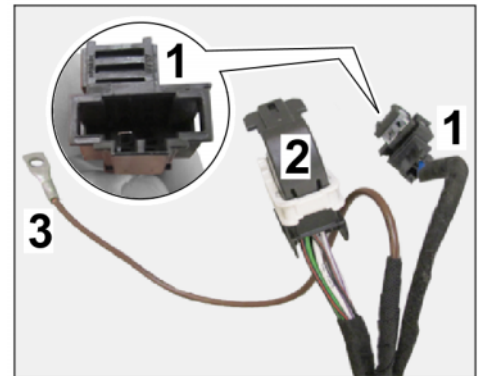

Figure 13

Install connection point at a suitable location using a clip.

2.7.2 Affix sticker showing the warning "Electric Brake for Trailer not connected" on a clean surface at a clearly visible position next to the "Ball Position" sticker or the dashboard (⇒ *Figure 14*).

- 1 – "Electric Brake for Trailer not connected" warning sticker
- 2 – "Ball Position" sticker

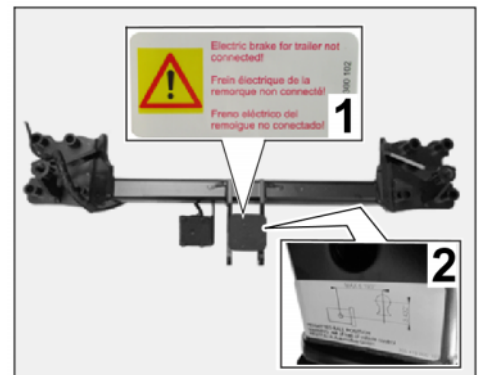

Figure 14

2.8 Check fuse assignment in fuse holder H (strip B – white ⇒ *Figure 15*) and insert missing fuses if necessary:

- Fuse slot 5 = trailer hitch (right light) = 25 A
- Fuse slot 6 = trailer hitch (swivel motor) = 30 A
- Fuse slot 7 = trailer hitch (attaching trailer & electric release) = 15 A
- Fuse slot 9 = trailer hitch (plug socket) = 15 A



Figure 15

NOTICE

Incorrect line routing

- Risk of damage to lines and hoses
 - Malfunction and fault memory entry on control unit
- ⇒ Avoid small bending radii when routing lines.
- ⇒ File down edges and burrs in the routing area or mask them with adhesive tape.
- ⇒ Maintain a sufficient distance from components exposed to high temperatures while driving.

3 Concluding work

- 3.1 Install side trim panel for luggage compartment ⇒ *Workshop Manual '700319 Removing and installing side trim panel for rear luggage compartment'*.
- 3.2 Install rear apron (⇒ *Workshop Manual '635519 Removing and installing rear apron'*)
- 3.3 Lower the vehicle (⇒ *Workshop Manual '4X00IN Lifting the vehicle'*)

Coding:

NOTICE

Voltage drop

- Risk of irreparable damage to control unit
 - Risk of damage to control unit
 - Fault entries in the control unit
 - Coding in the control unit is aborted
 - Malfunctions in control unit, even during programming
- ⇒ Switch off the ignition and remove the ignition key before disconnecting the control unit.
- ⇒ Ensure that the power supply is not interrupted during programming.

⇒ Connect a battery charger with a current rating of at least Nominal value 90 A to the vehicle battery.

4 Coding/programming trailer hitch (1D6)

4.1 Preparatory work – Coding

NOTICE

Control unit programming will be aborted if the Internet connection is unstable.

- An unstable Internet connection can interrupt communication between PIWIS Tester III and the vehicle communication module (VCI). As a result, control unit programming may be aborted.

⇒ During control unit programming, always connect PIWIS Tester III to the vehicle communication module (VCI) via the USB cable.

4.1.1 **9900 - PIWIS Tester 3** must be connected to the vehicle and switched on.

4.1.2 Switch on ignition **AND** hazard warning lights on the vehicle.



Information

The **9900 - PIWIS Tester III** instructions take precedence since the description may be different with later Tester releases.

The procedure described here has been structured in general terms; different text or additions may appear on the **9900 - PIWIS Tester III**.

4.1.3 Select the "Diagnostics" menu item on the PIWIS Tester.

4.1.4 If **9900 - PIWIS Tester 3** is connected correctly, a connection to the vehicle will be established: "Cayenne" model line is detected.

4.1.5 Press •F12" to go to the control unit search screen.

4.1.6 Confirm the question: "Create vehicle analysis log (VAL)?" with "Yes" = •F12" .



Information

The function is **ONLY** available when the Tester is online!

4.2 Enter the new vehicle equipment in the vehicle data using "PIWIS Online"

4.2.1 Press •F7" in the control unit overview to switch to the "Additional menu".

4.2.2 Select the function "Maintenance of vehicle data with PIWIS ONLINE".

A message appears informing you that the "Actual" (vehicle) data and "Required" (PIWIS Online) data will be compared.

Press •F12" to continue.

- 4.2.3 Confirm the message "The vehicle data was compared with PIWIS Online. Significant differences were found" with •F12" .
- 4.2.4 Look for the option "TRAILER HITCH" in the "Family" column.
Select the available option from the drop-down menu in the "Value" column, depending on the option installed:
- 1D6 – TRAILER HITCH WITHOUT TOW BALL (USA)
- Press •F12" to continue.
- 4.2.5 A table containing the coding value and the columns "new value" and "old value" is displayed in the overview. Press •F8" to continue.
- 4.2.6 Data is then written/stored. The following messages appear one after the other:
- Transferring vehicle data to PIWIS Online.
 - Writing and transferring vehicle data to the vehicle.
 - Vehicle order was written successfully.
 - A check was performed in order to check whether control units have to be coded or programmed as a result of the changes that were made.
- 4.3 Code/program the new vehicle equipment.
- 4.3.1 Confirm the table containing a list of control units that must be coded/programmed by pressing •F12" .
- 4.3.2 Individual data records will be loaded, depending on the number of control units to be coded/programmed.
Wait until the message "Creating backup documentation. Please wait..." and "Coding was completed successfully" appears. Press •F12" to continue.
Repeat the process for other control units if necessary.
- 4.3.3 Wait until the message "Adaptation of the control units is complete." appears and check the coding status of the control units in the table that is displayed.
Continue by pressing •F12" to return to the control unit overview.
- 4.4 **ONLY** for vehicles with Lane Change Assist (7Y1/7Y2/7Y3 or 7Y8):
Calibrate control unit for Lane Change Assist (⇒ *Workshop Manual '917025 Calibrating Lane Change Assist*)
- 4.5 Read out the fault memories of all systems, work through any existing faults and erase the fault memories. ⇒ *Workshop Manual '0335IN Diagnostic maintenance: diagnostic system and maintenance inter...'*
- 4.6 Create another vehicle analysis log (VAL) in the "Control unit overview" menu item.
- 4.7 Switch off ignition and disconnect **9900 - PIWIS Tester 3**.
- 4.8 Drive the vehicle off the lifting platform.

- 66 90 23 00: –Retrofitting –mechanical– trailer hitch–
Includes: Removing and installing rear apron and left side trim panel for rear luggage compartment;
Removing rear bumper and installing trailer hitch;
Making cut-out for removable ball hitch in rear apron;
Coding/programming new vehicle equipment.
Labor time: **238 TU**
- 91 70 25 53: **ONLY** for vehicles with Lane Change Assist/Lane Keep Assist (6I3/ 7Y1):
Programming Lane Change Assist control unit
Includes: Calibrating calibration plate on the vehicle.
Labor time: **47 TU**
- 51 01 71 05: **ONLY** for vehicles with painted wheel arch extensions (6GH/ 6GJ/ 6GK or SportDesign package):
Body paint finish prepared
Includes: Order-related Painting of new parts, Step 1 plastic part
Labor time: **130 TU**

Important Notice: Technical Bulletins issued by Porsche Cars North America, Inc. are intended only for use by professional automotive technicians who have attended Porsche service training courses. They are written to inform those technicians of conditions that may occur on some Porsche vehicles, or to provide information that could assist in the proper servicing of a vehicle. Porsche special tools may be necessary in order to perform certain operations identified in these bulletins. Use of tools and procedures other than those Porsche recommends in these bulletins may be detrimental to the safe operation of your vehicle, and may endanger the people working on it. Properly trained Porsche technicians have the equipment, tools, safety instructions, and know-how to do the job properly and safely. Part numbers listed in these bulletins are for reference only. The work procedures updated electronically in the Porsche PIWIS diagnostic and testing device take precedence and, in the event of a discrepancy, the work procedures in the PIWIS Tester are the ones that must be followed.

© 2022 Porsche Cars North America, Inc.