



Technical Service Bulletin

GROUP EV SYSTEM	NUMBER 22-EV-001H
DATE APRIL 2022	MODEL(S) Kona Electric (OS EV)

SUBJECT: KONA EV MOTOR RUMBLE NOISE

Description: This bulletin outlines the necessary inspection and repair procedures for certain 2019-2020MY Kona EV (OS EV) vehicles, exhibiting abnormal rumbling noise from the electric traction motor.

Applicable Vehicles: Certain 2019-2020MY Kona Electric (OS EV) vehicles produced until 1/19/2021.

Parts Required: (NOTE: Be sure to check production date of the subject vehicle):

MODEL	PART NAME	PART NUMBER	NOTE
Kona Electric (OS EV)	MOTOR/ROLL MOUNT BRACKET AND BOLT KIT-A	36930-0E700FFF	Vehicle produced before 5/13/19
	MOTOR/ROLL MOUNT BRACKET AND BOLT KIT-B	36930-0E710FFF	Vehicle produced 5/13/19 or later

Warranty Information:

MODEL	OP CODE	OPERATION	CAUSAL PART	OP CODE	NATURE CODE	CAUSE CODE
Kona Electric (OS EV)	36930F00	KIT REPLACEMENT (2 TEST DRIVES)	44500-18EA1	3.2 M/H	Q55	ZZ1
	36930F01	KIT INSPECTION AND REPLACEMENT + MOTOR/REDUCTION GEAR REINSTALLATION (3 TEST DRIVES)		8.8 M/H		
	36930F02	KIT INSPECTION AND REPLACEMENT + MOTOR REPLACEMENT (3 TEST DRIVES)		8.8 M/H		
	36930F03	KIT INSPECTION AND REPLACEMENT + REDUCTION GEAR REPLACEMENT (3 TEST DRIVES)		8.8 M/H		
	36930F04	KIT INSPECTION AND REPLACEMENT + MOTOR/REDUCTION GEAR REPLACEMENT (3 TEST DRIVES)		8.8 M/H		

NOTE: Normal Warranty Applies.

Troubleshoot Flow Diagram:

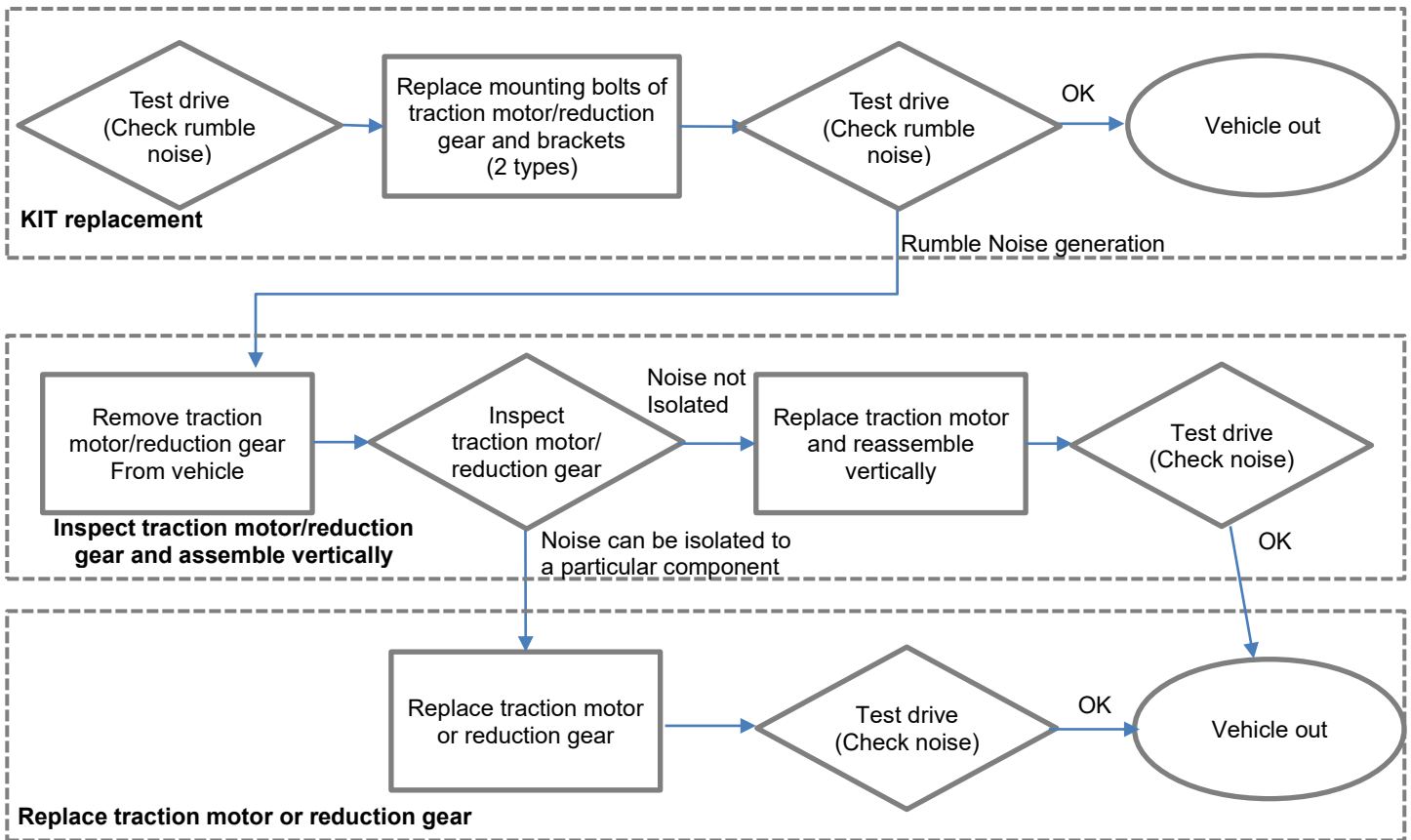

NOTICE

- Always attach noise records as claim evidence. Claims without noise records may not be accepted.

NOTICE

- Refer to the shop manual for high voltage safety precautions.
- Disconnect the battery's negative (-) terminal before servicing.
- Perform the high voltage cut-off work before servicing.

Service Procedure:

1. Test drive the vehicle. Creep in “D” and slowly accelerate/decelerate within speeds of 25-50 MPH, inspect for rumble noise generation from the traction motor and may especially be noticeable on deceleration.
2. If rumble is generated, place the car on a lift and proceed to disconnect the high voltage system.

⚠ WARNING

- Refer to the shop manual section for high voltage precautions:
Motor System > High Voltage Battery Handling Guide
- When working on the high voltage system, make sure that you are familiar and comply with the “Safety Precautions, Cautions and Warnings.” If you do not comply with the safety procedures, serious injury or death may occur.

3. Disconnect the service interlock connector (A).

NOTICE

Be sure to wait for at least 3 minutes before proceeding to the next step.

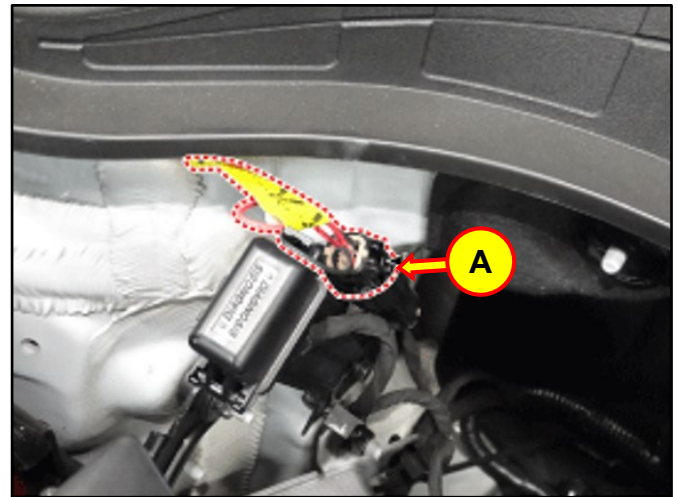

4. If service interlock connector is unable to be disconnected, proceed to service procedure steps 5-9. Otherwise, proceed with step 10.
5. Turn OFF the ignition switch and disconnect the negative (-) cable of the 12V battery.

6. Remove the trunk luggage board cover (B).

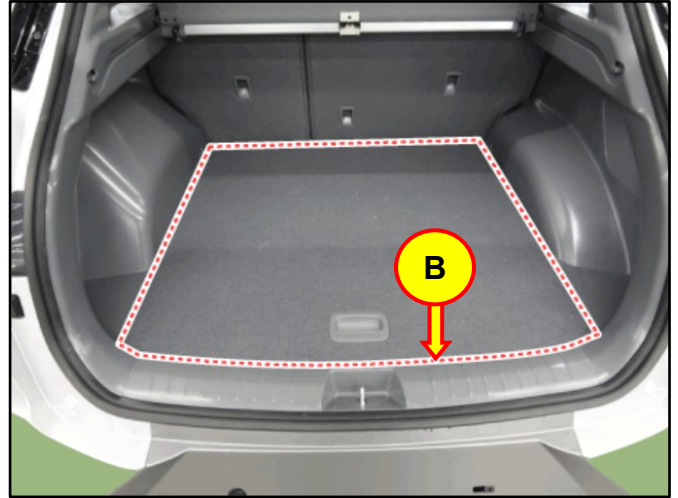

7. Remove the rear seat.

Refer the shop manual section for complete service procedure:

Body (Interior and Exterior) > Rear Seat

8. Remove the service plug service cover (C).

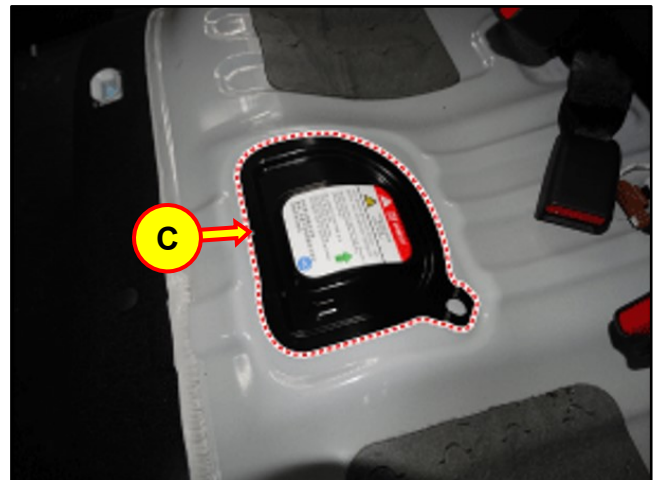

9. Remove the service plug (D).

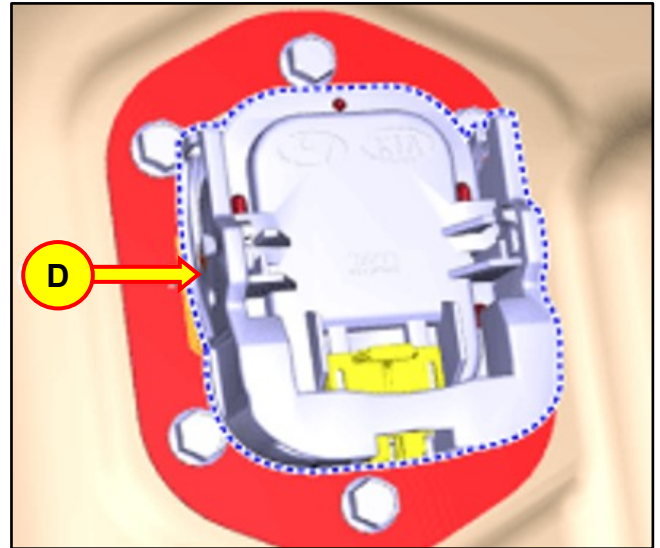

A. Roll Mount Replacement

10. Place the vehicle on a lift and remove the under cover.

Refer the shop manual section for complete service procedure:

Motor System > Motor Assembly >

11. Support the reduction gear assembly with a jack.



- Replace the roll mount.

Tightening Torque:

Bolt E: 79.6 – 94.1 lb-ft (107.9 – 127.5 Nm)

Bolt F: 47.0 – 61.5 lb-ft (63.8 – 83.4 Nm)

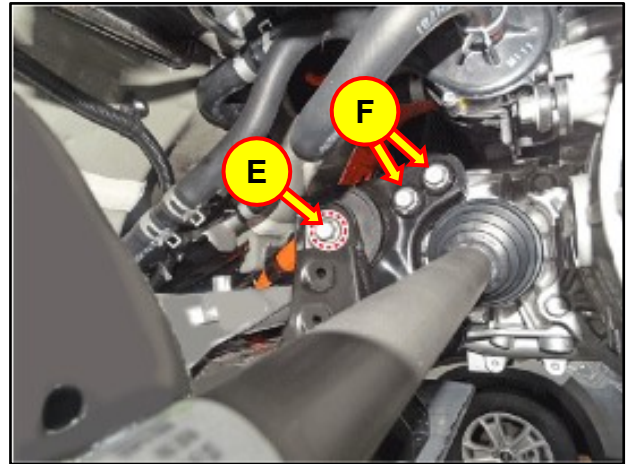
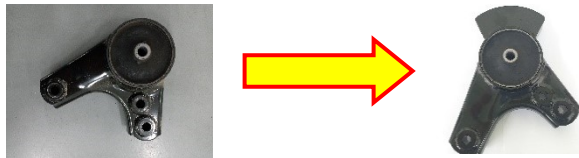

B. Motor Mounting Support Bracket Replacment

- Support the motor with a jack.

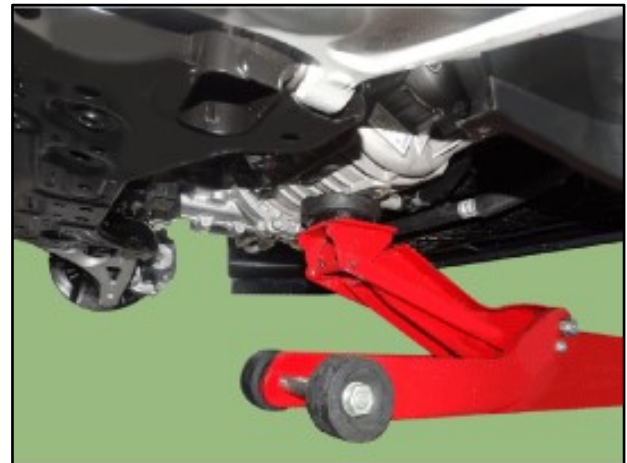

- Remove the motor mounting support bracket, outlined in the figure.

Tightening Torque:

Nut G: 57.9 – 72.4 lb-ft (78.5 – 98.1 Nm)

Nut H: 43.4 – 54.3 lb-ft (58.9 – 73.6 Nm)

Bolt I: 43.4 – 54.3 lb-ft (58.9 – 73.6 Nm)

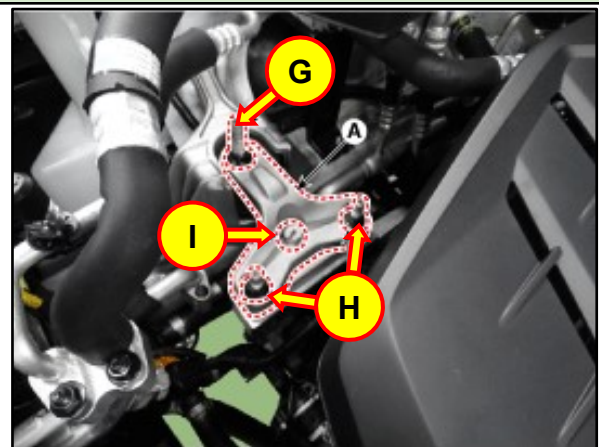

- Remove the motor support bracket (J).



- Remove the mass (K) from the new motor support bracket.

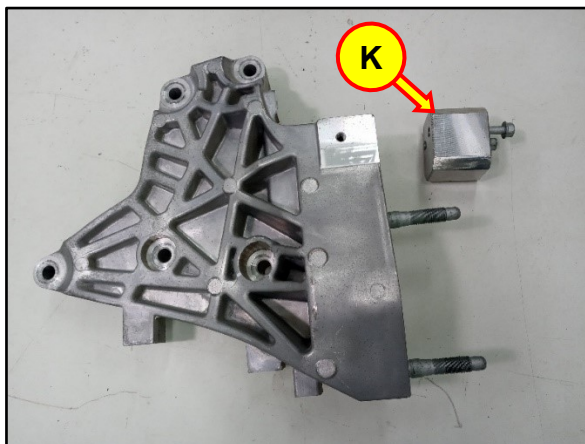

- Replace the motor support bracket with a new one.

NOTICE

First, tighten the top side bolt that is outlined in the figure. After inserting the bracket into the lower side, pretighten the bolt.



- Assemble the mass (K) to the motor mount's top side. Ensure the protrusion faces towards the engine compartment.

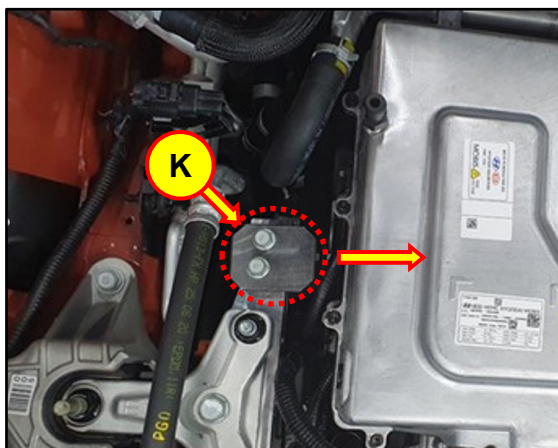

C. Motor Mounting Bolt Replacement

1. Remove the high voltage junction box (L) following the repair procedures in the shop manual.

Battery Control System > High Voltage Distributing System > High Voltage Junction Box

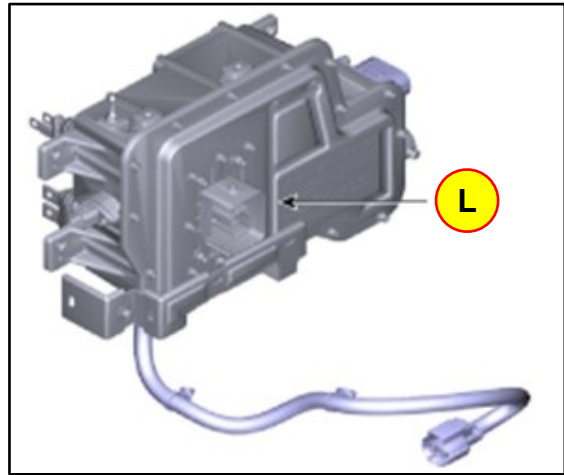

Be sure to comply with the specified (On Board Charger) OBC and Electronic Power Control Unit (EPCU) torque values for the mounting bolts.

Tightening Torque:

Bolt (A): 2.9 – 4.3 lb-ft (3.9 – 5.9 Nm)

Bolt (B): 6.5 – 7.2 lb-ft (8.8 – 9.8 Nm)

NOTICE

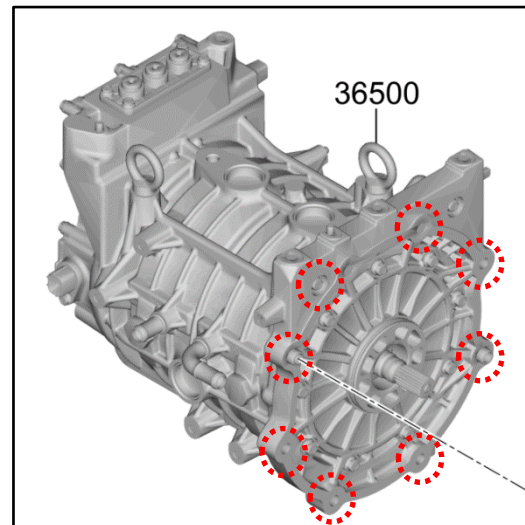
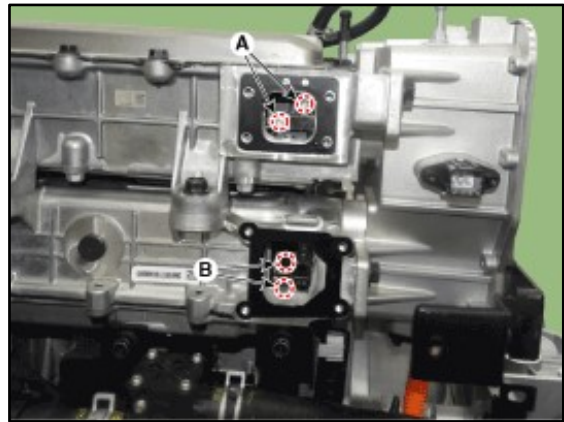

Tighten the bolts at a right angle to avoid striping the threads.

2. Loosen the 8 mounting bolts of the traction motor and reduction gear regardless of order.

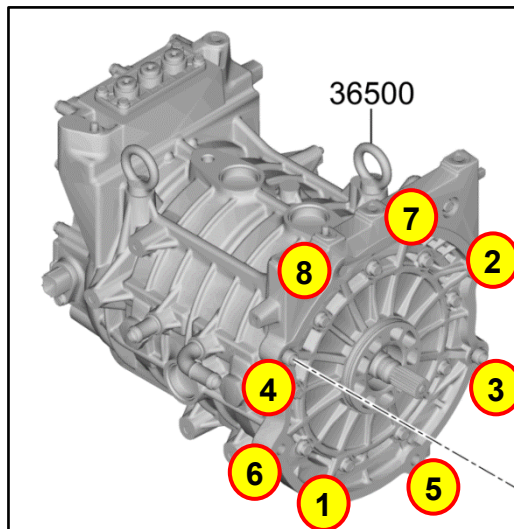

- The tightening order of the traction motor and reduction gear mounting bolts is shown in the figure to the right.

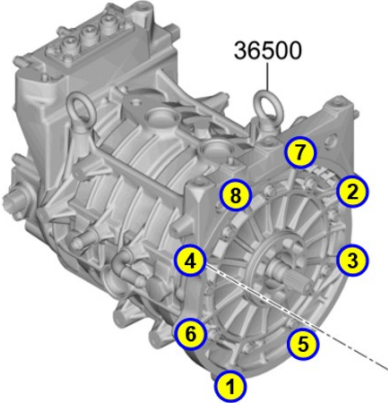

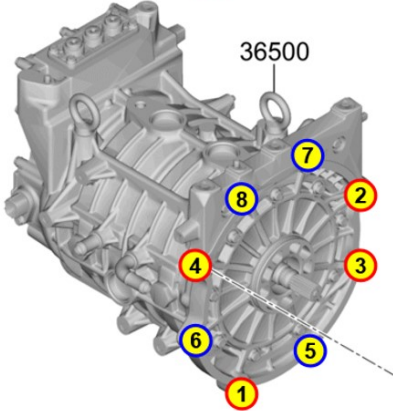
KIT A specification: Vehicles Produced before 5/13/19	KIT A Specification: Vehicles Produced 5/13/19 or later
<p>- 50mm bolts: 8ea </p> 	<p>- 50mm bolts: 4ea  - 75mm bolts: 4ea </p> 

- Replace the mounting bolts one by one following the tightening order.

Tightening Torque:

65.8 – 71.6 lb-ft (89.3 – 97.1 Nm)

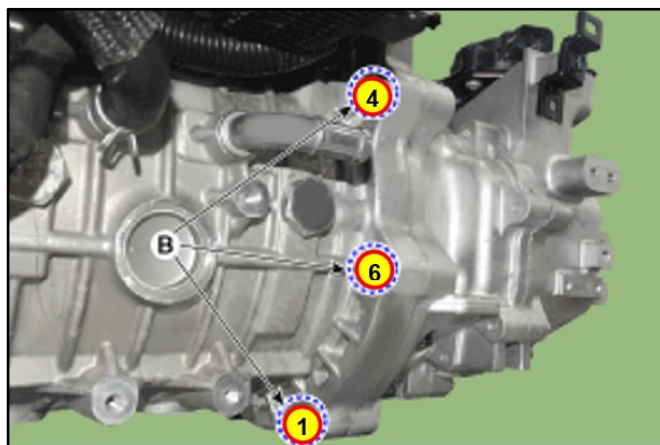

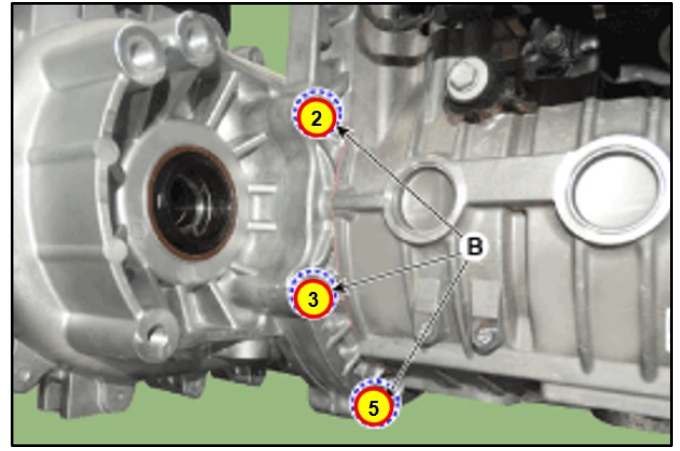
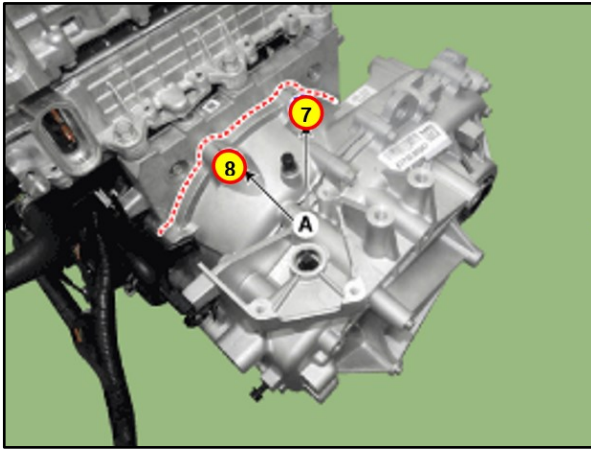

5. Reinstall the removed parts in reverse order of removal.
6. Test drive the vehicle and inspect for rumble noise.
7.
 - If rumble noise is resolved the service procedure is complete.
 - If the rumble noise is not acceptable, perform the additional work following the procedures below.

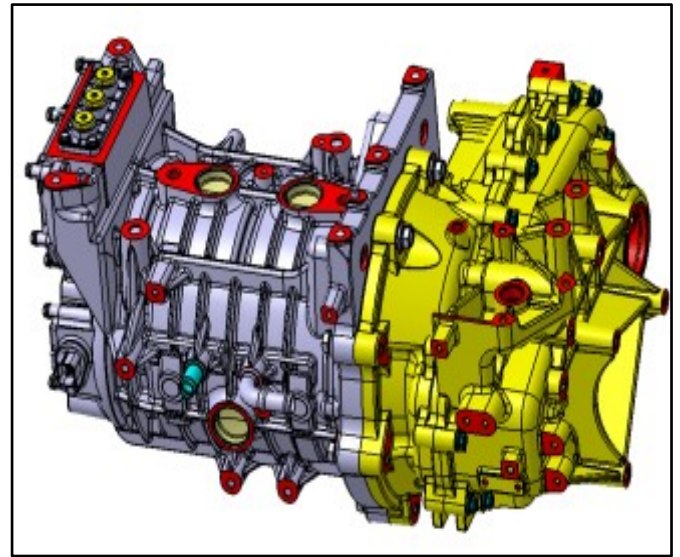

D. Removal of the Traction Motor/Reduction Gear

1. Place the car on a lift and proceed to disconnect the high voltage system.

⚠ WARNING

- Refer to the shop manual section for high voltage precautions:
Motor System > High Voltage Battery Handling Guide
- When working on the high voltage system, make sure that you are familiar and comply with the "Safety Precautions, Cautions and Warnings." If you do not comply with the safety procedures, serious injury or death may occur.

2. Disconnect the service interlock connector (M).

NOTICE

Be sure to wait for at least 3 minutes before proceeding to the next step.

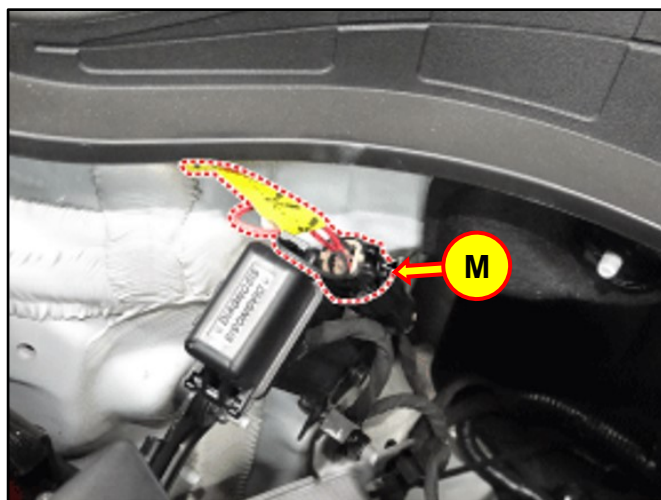

4. If service interlock connector is unable to be disconnected, proceed to service procedure steps 5-9. Otherwise, proceed with step 10.
5. Turn OFF the ignition switch and disconnect the negative (-) cable of the 12V battery.
6. Remove the trunk luggage board cover (N).

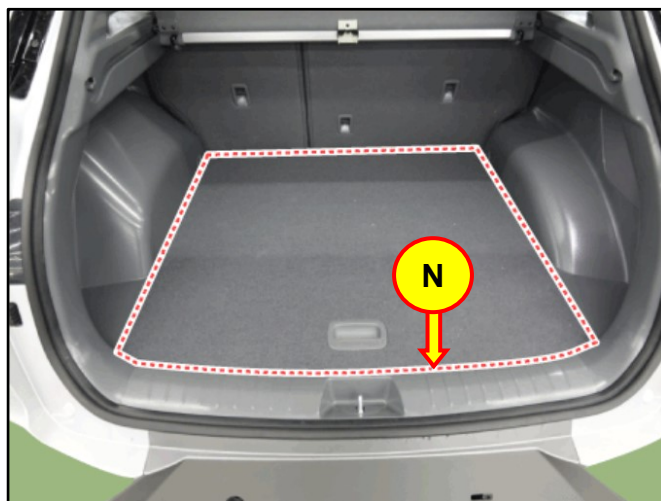

7. Remove the rear seat.

Refer the shop manual section for complete service procedure:

Body (Interior and Exterior) > Rear Seat

8. Remove the service plug service cover (O).

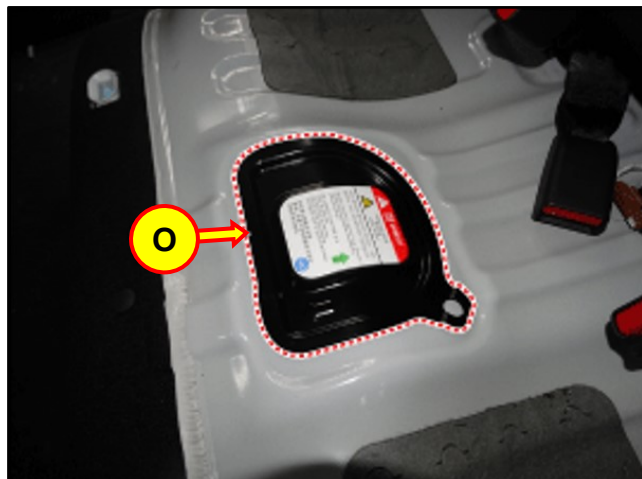

9. Remove the service plug (P).

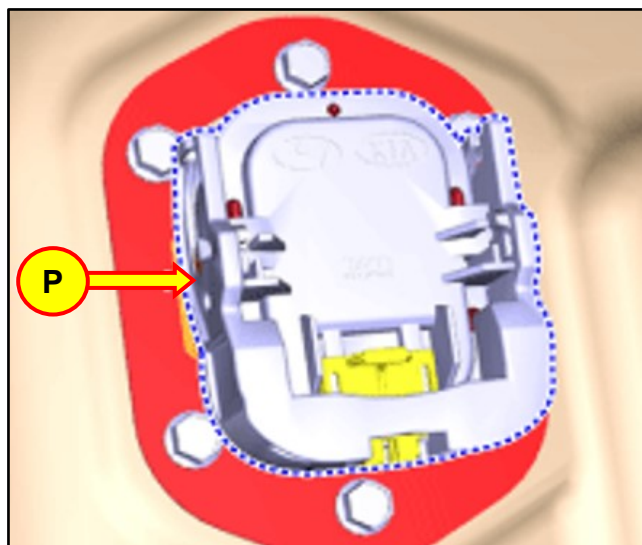

10. Remove the under cover.

Refer the shop manual section for complete service procedure:

Motor System > Motor Assembly > Under Cover.

11. Drain the engine coolant.

Refer the shop manual section for complete service procedure:

Cooling System > Electric & High Voltage Battery Cooling System > Coolant

12. Recover the A/C refrigerant.

Refer the shop manual section for complete service procedure:

Heating, Ventilation And Air Conditioning > Air Conditioning System

13. Remove the 12V auxiliary battery and tray.

Refer the shop manual section for complete service procedure:

Vehicle Control System > Electric Power Control Unit (EPCU) > Auxiliary 12V Battery

14. Slightly loosen the front wheel nuts.

15. Remove the front wheel and tire (Q).

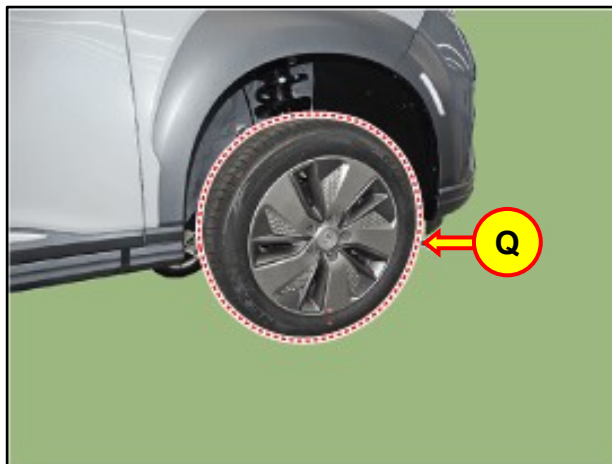

16. Remove the caulking nut (R) from the front hub.

Tightening Torque:

202.6 – 217.1 lb-ft (274.7 – 294.3 Nm)

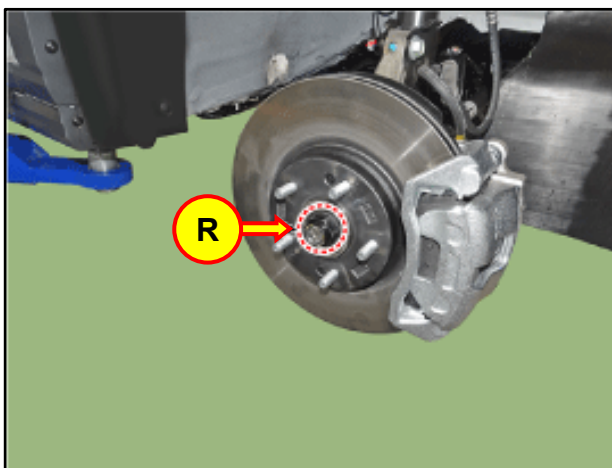

17. Remove the tie rod end ball joint using SST: 09568-1S100.

- Remove the split pin and castle nut (S).
- Remove the tie rod end ball joint (T) using SST: 09568-1S100

Tightening Torque:

57.9 – 72.4 lb-ft (78.5 – 98.1 Nm)

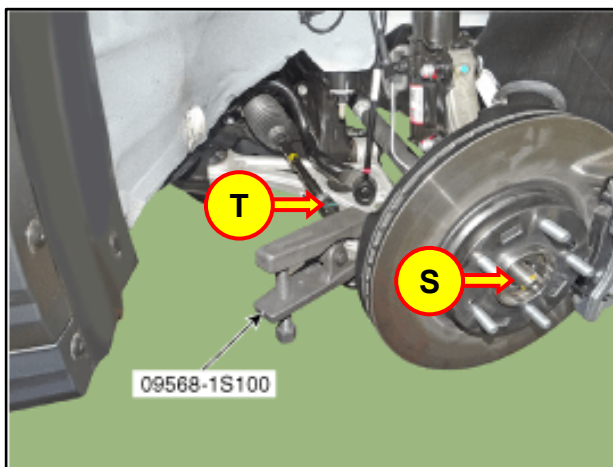

18. Remove the lower arm ball joint using SST: 09568-1S100
- Remove the snap pin and castle nut (U).
 - Remove the lower arm ball joint (V) using SST: 09568-1S100.

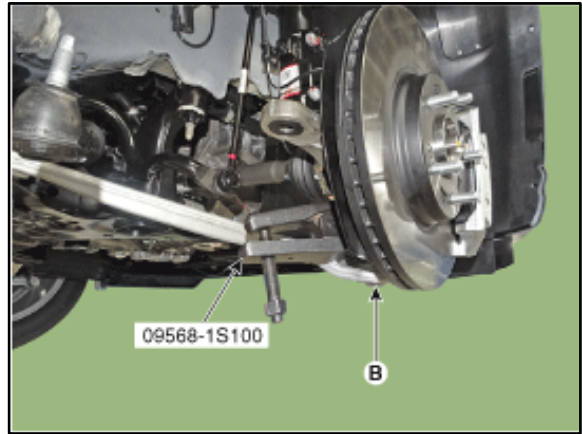

19. Remove the front drive shaft assembly (both sides).

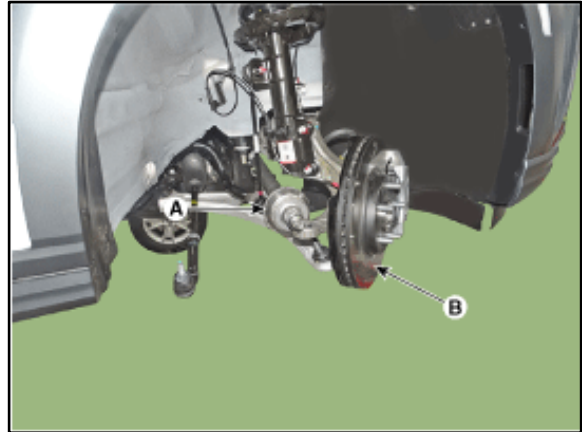

20. Disconnect the radiator upper hose (W).



21. Disconnect the radiator lower hose (X).

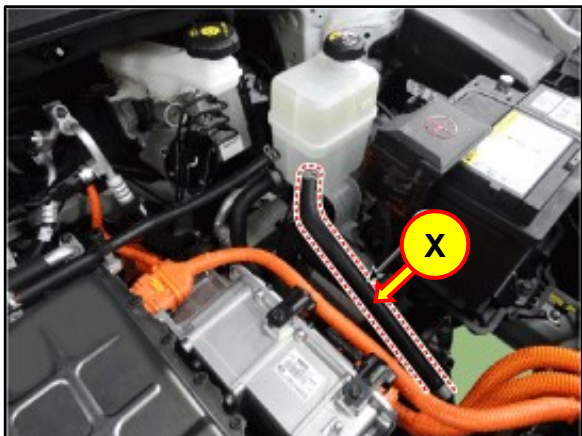

22. Disconnect the 3-way valve quick connector (Y).

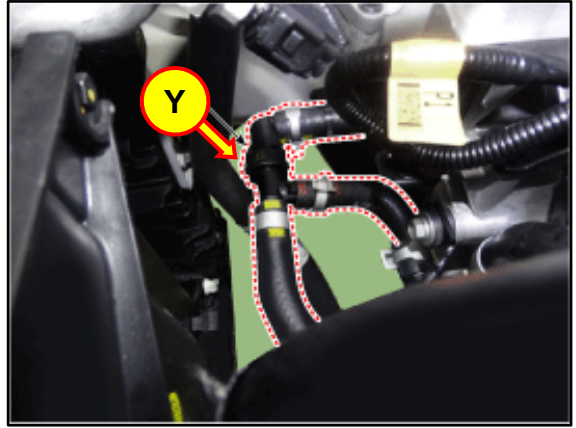

23. Disconnect the 3-way valve outlet hose (Z) at the battery side.



24. Disconnect the air conditioner pressure transducer connector (AA) and remove the air conditioner pipe (AB).

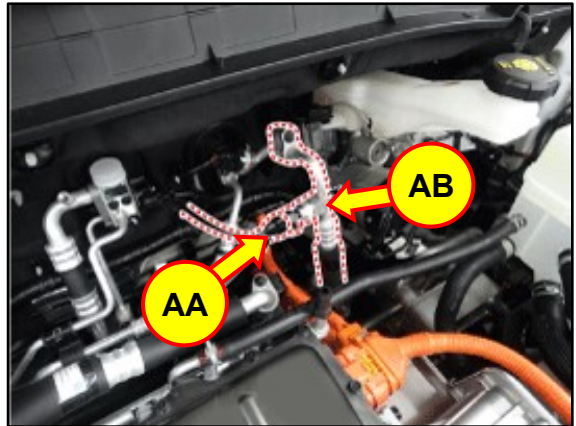

25. Remove the air conditioner pipe (AC).

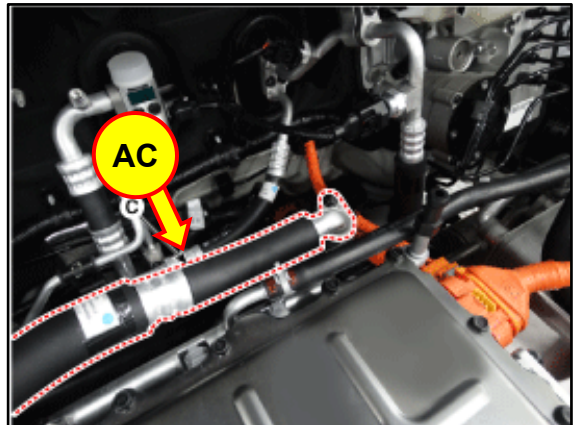

26. Remove the air conditioner pipe (AD).

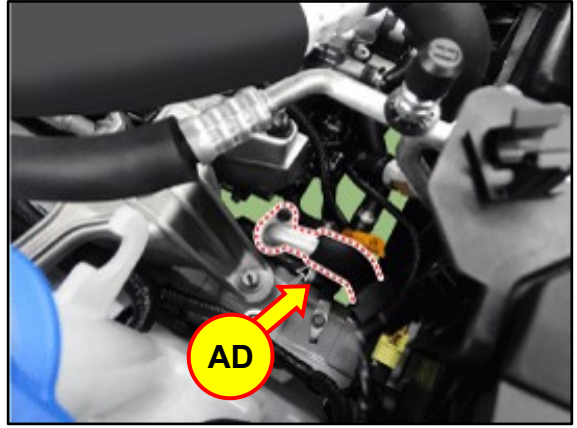

27. Remove the OBC cable bracket (AE) and then disconnect the connector (AF).

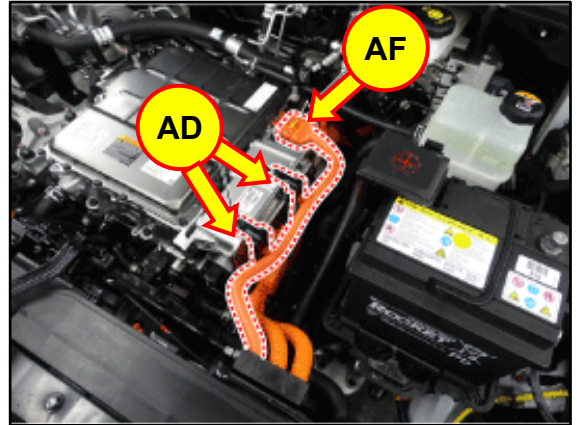

28. Disconnect the slow charger (high voltage junction box) cable connector (AG).

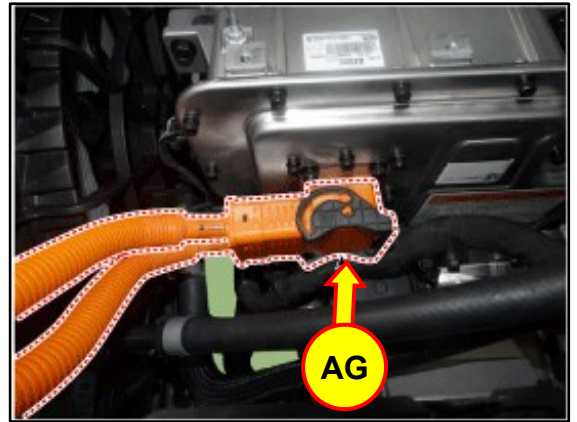

29. Disconnect the PTC (Positive Temperature Coefficient) high voltage cable connector (AH).

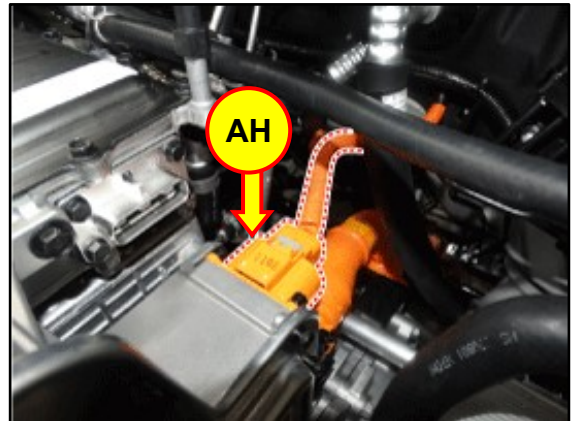

30. After disconnecting the high voltage cable (AI) of the high voltage battery assembly, remove the bracket (AJ).

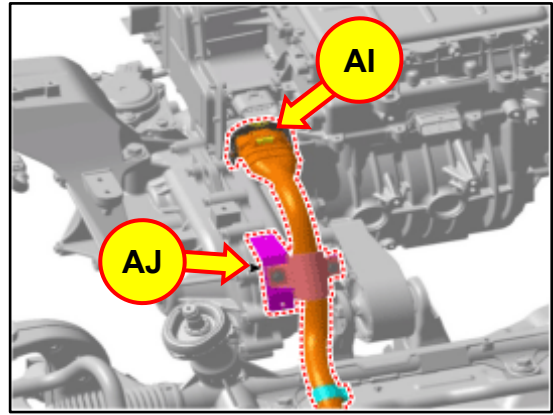

31. Disconnect the wiring harness from the PE room and disconnect the battery sensor connector (AK).

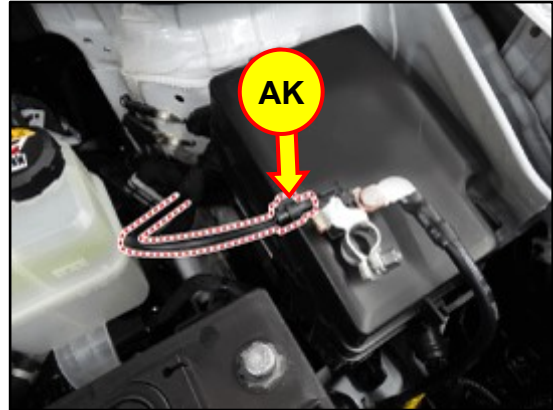

32. Remove the fuse box cover (AL).

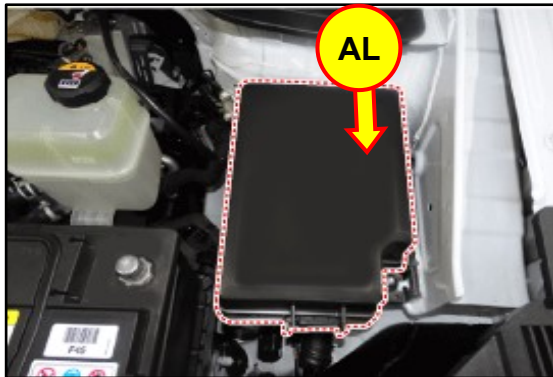

33. Disconnect the fuse box main wiring connector (AM).

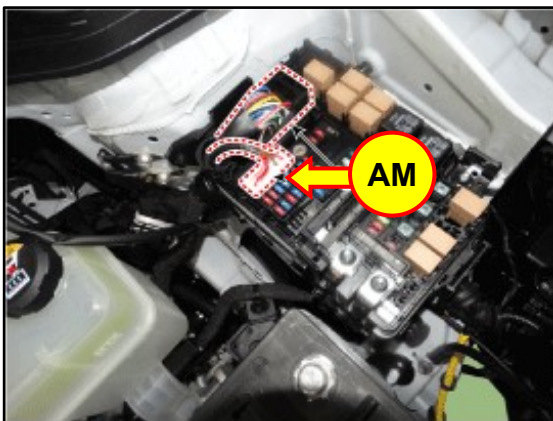

34. Disconnect the fuse box wiring cable (AN).

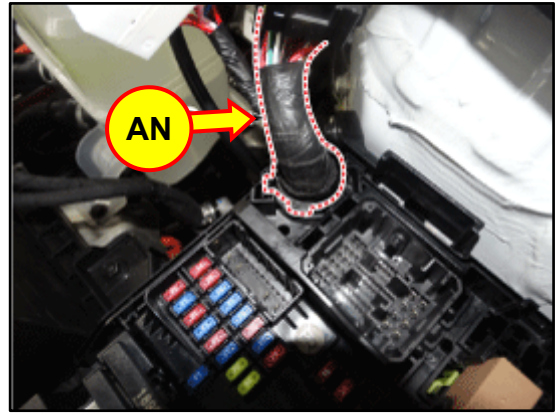

34. Disconnect the inlet water temperature sensor connector (AO).

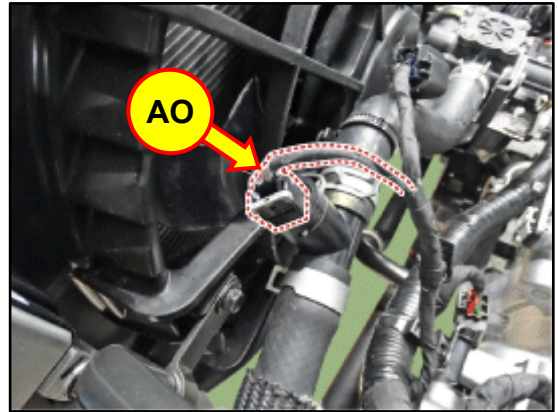

35. Disconnect the 3-way valve (For Electrical Devices) inlet hose (AP).

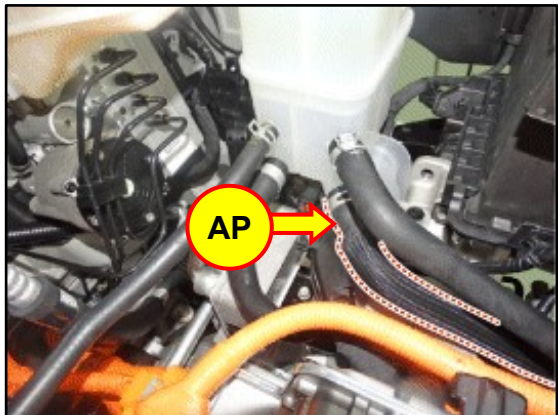

36. Loosen the 3-way valve mounting bolts (AQ).

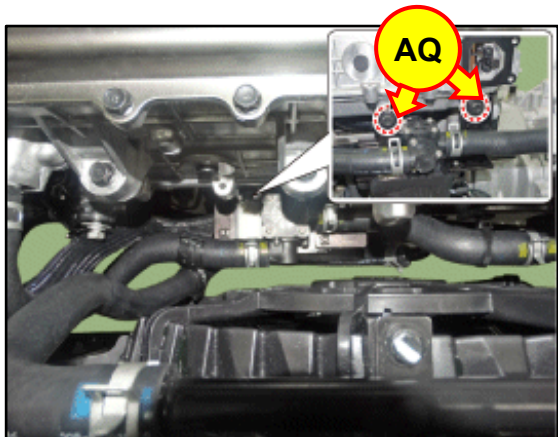

37. Remove the reservoir tank (AR).

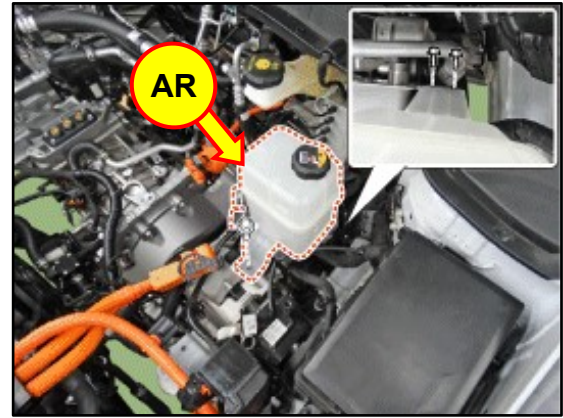

38. Remove the main wiring protector (AS).

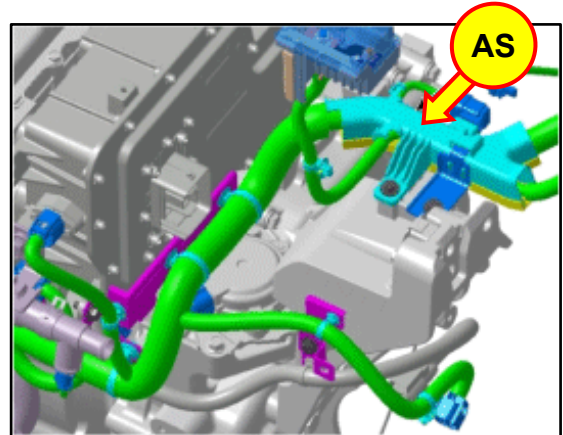

39. Remove the reduction gear chassis ground cable (AT).

Tightening Torque:

19.5 – 23.9 lb-ft (26.5 – 32.4 Nm)

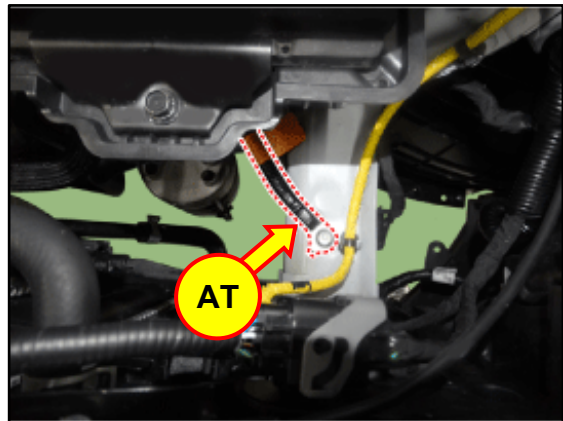

40. Remove the traction motor chassis ground cable (AU).

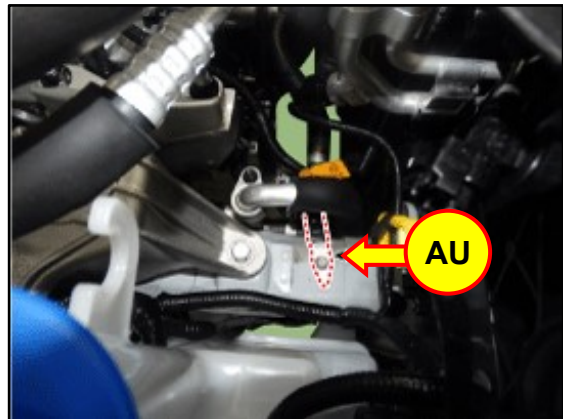

41. Disconnect the EWP outlet hose (AV) at the battery side.



42. Remove the rear roll mounting bracket, outlined in the figure.

Tightening Torque:

Bolt (B): 79.6 – 94.1 lb-ft (107.9 – 127.5 Nm)

Bolt (C): 47 – 61.5 lb-ft (63.8 – 83.4 Nm)



43. Loosen the refrigerant pipe mounting bolt (AW).

Tightening Torque:

5.8 – 8.7 lb-ft (7.8 – 11.8 Nm)

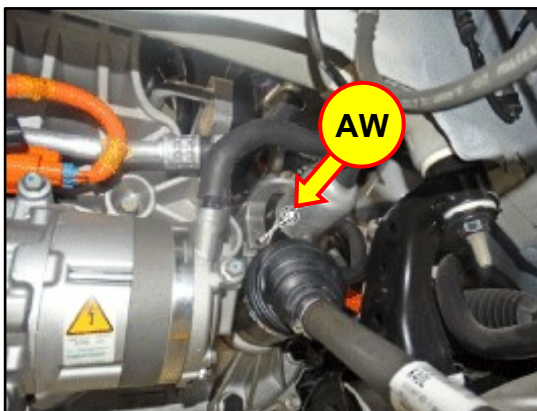

44. Loosen the refrigerant pipe mounting nut (AX), then remove the refrigerant pipe (AY).

Tightening Torque:

5.8 – 8.7 lb-ft (7.8 – 11.8 Nm)

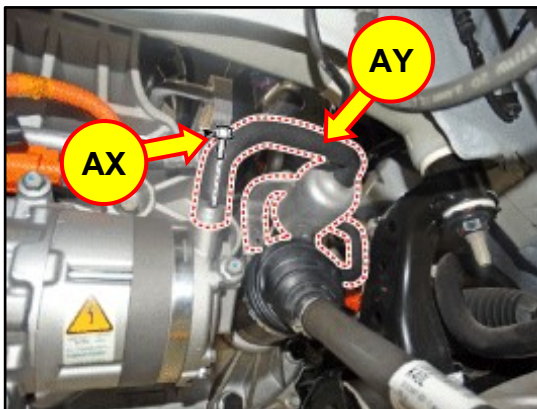

45. Safely support the traction motor and reduction gear assembly with a floor jack.



46. Remove the traction motor mounting support bracket, outlined in the figure.

Tightening Torque:

Nut (B): 57.9 – 72.4 lb-ft (78.5 – 98.1 Nm)
 Bolt (C): 43.4 – 54.4 lb-ft (58.9 – 73.6 Nm)
 Nut (D): 43.4 – 54.4 lb-ft (58.9 – 73.6 Nm)

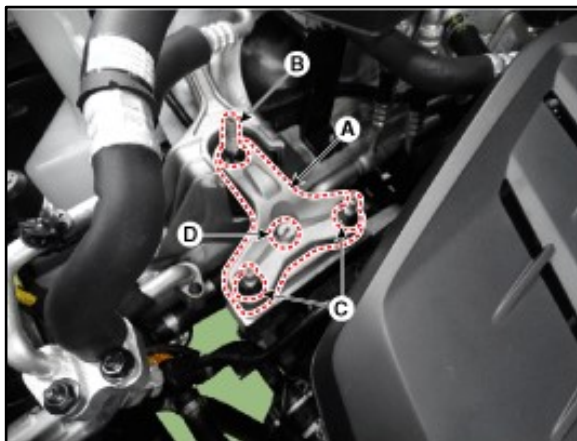

47. Loosen the reduction gear mounting bolts (AZ).

Tightening Torque:

79.6 – 94.1 lb-ft (107.9 – 127.5 Nm)

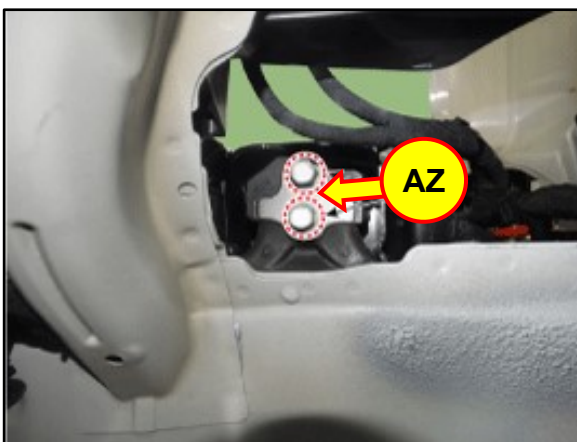

48. Lift up the vehicle to remove the traction motor and reduction gear assembly.



49. Disconnect the water outlet hose (BA).

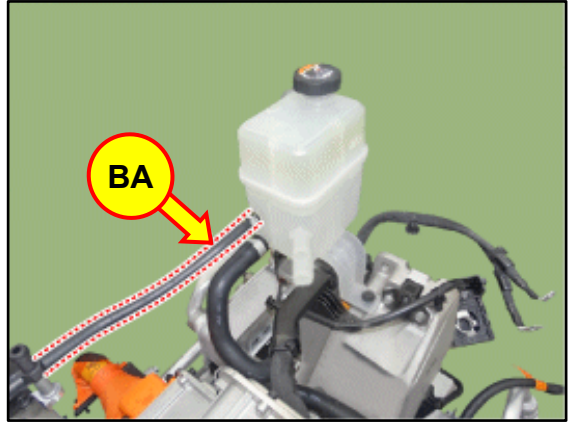

50. Disconnect the compressor high voltage cable connector (BB).

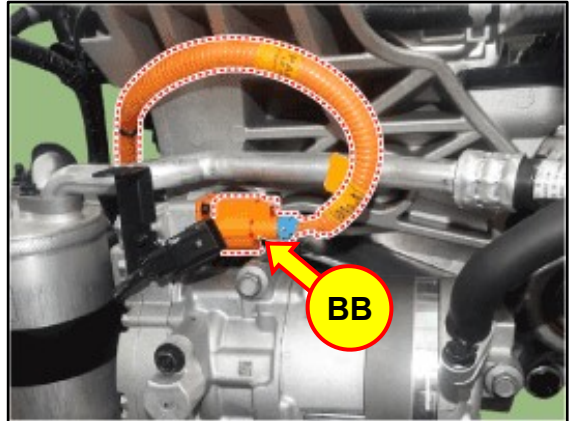

51. Remove the OBC side cover (BC) and the EPCU side cover (BD).

Tightening Torque:

2.9 – 4.3 lb-ft (3.9 – 5.9 Nm)

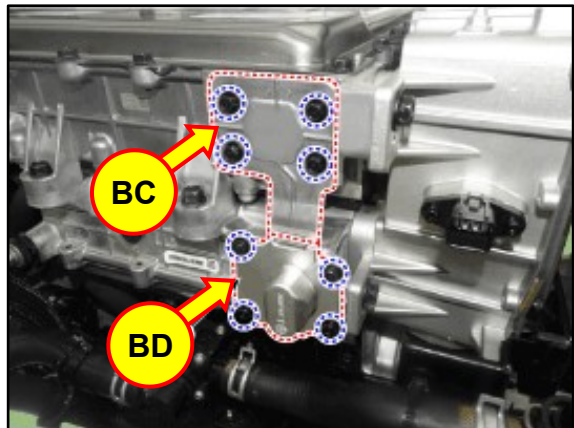

52. Loosen the ODC mounting bolts (BE) and the EPCU mounting bolts (BF).

Tightening Torque:

Bolt (A): 2.9 – 4.3 lb-ft (3.9 – 5.9 Nm)

Bolt (B): 6.5 – 7.2 lb-ft (8.8 – 9.8 Nm)

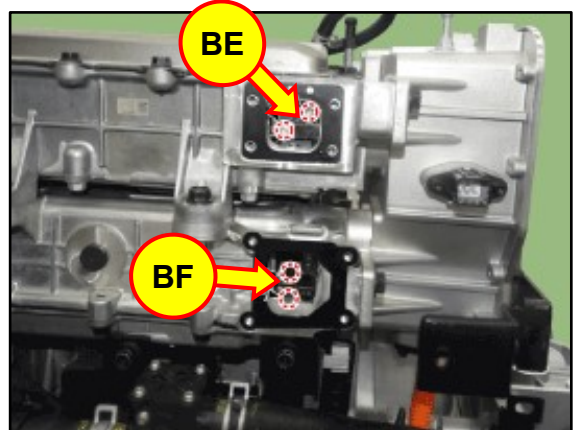

53. Loosen the mounting bolts (BG), then remove the high voltage junction box (BH).

Tightening Torque:

11.6 – 17.4 lb-ft (15.7 – 23.5 Nm)

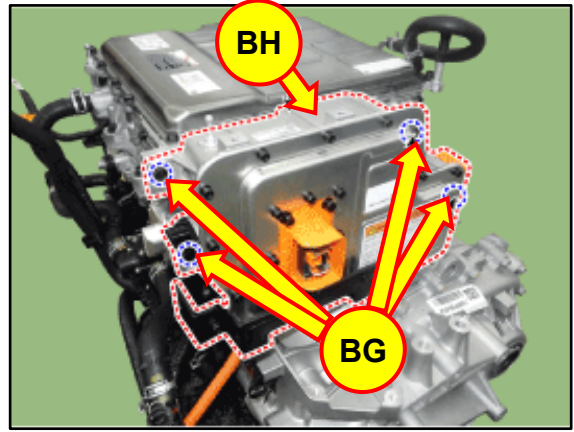

54. Loosen the refrigerant pipe mounting bolt (BI).

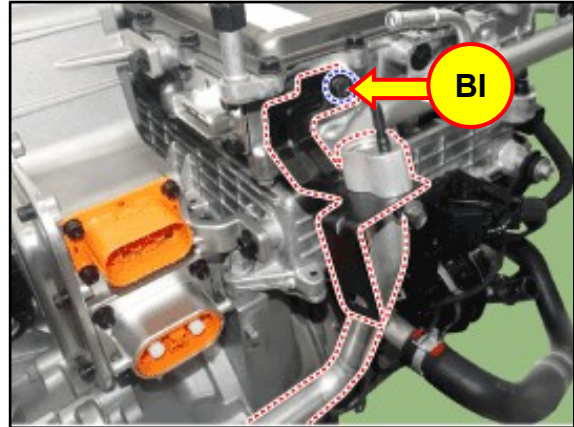

55. Disconnect the traction motor inlet hose (BJ).

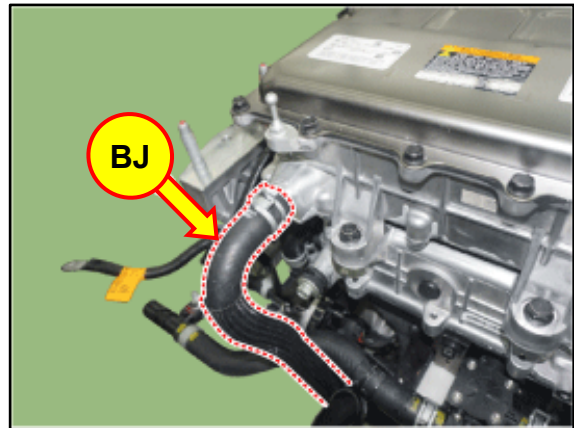

56. Disconnect the coolant hose (BK), then remove the coolant pipe (BL).

Tightening Torque:

5.8 – 7.2 lb-ft (7.8 – 9.8 Nm)

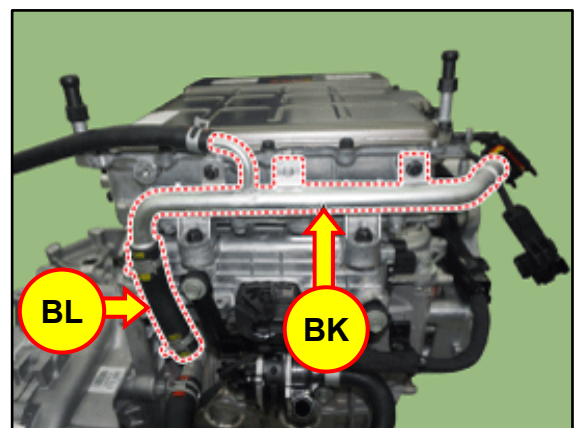

57. Disconnect the control board signal connector (BM).

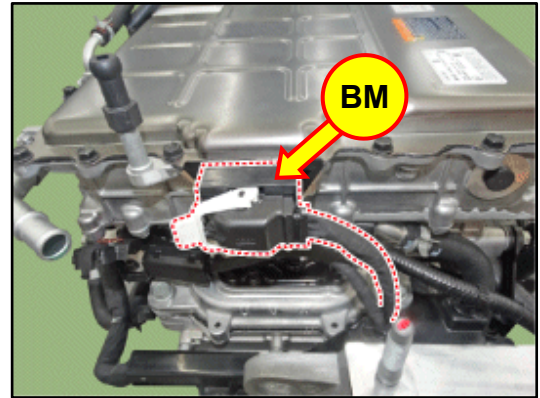

58. Loosen the OBC mounting bolts, then remove the OBC (BN).

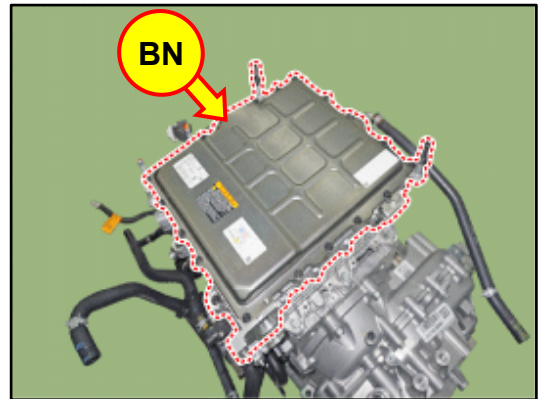

59. Loosen the mounting bolt (BO), then disconnect the EPCU (+) cable (BP).

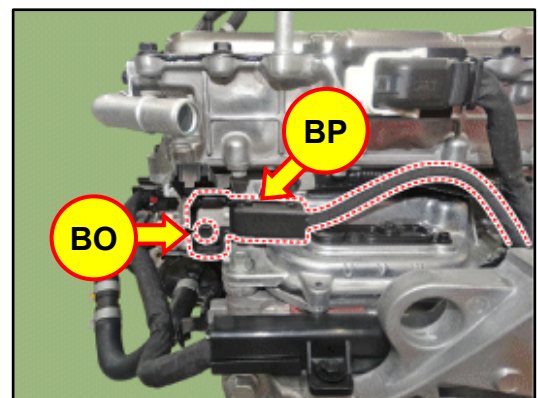

60. Disconnect the Low Voltage (-) cable (BQ) and the EWP (Electric Water Pump) outlet hose (BR).

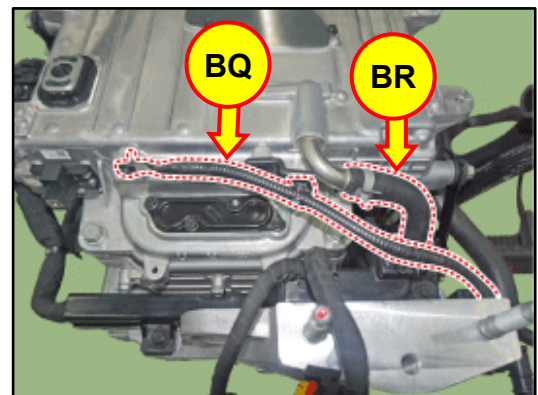

61. Disconnect the EWP connector (BS)

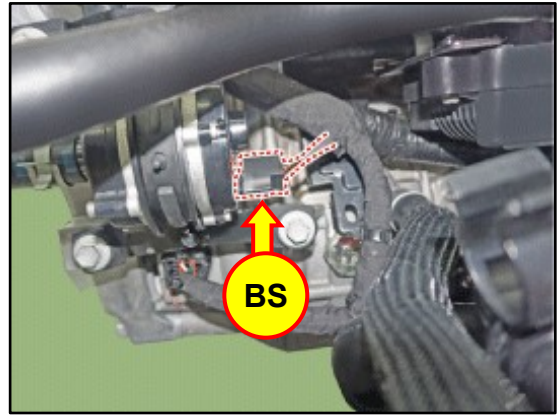

62. Disconnect the EWP inlet hose (BT).

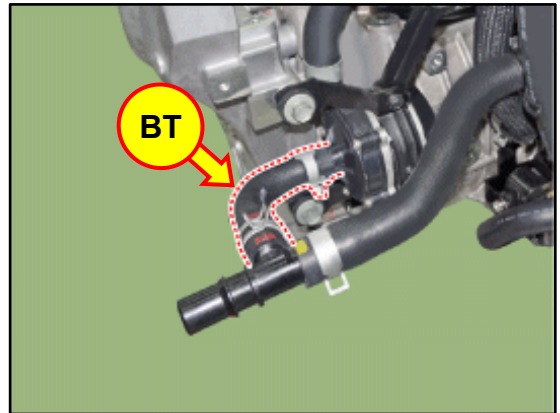

63. Disconnect the EPCU connector (BV).

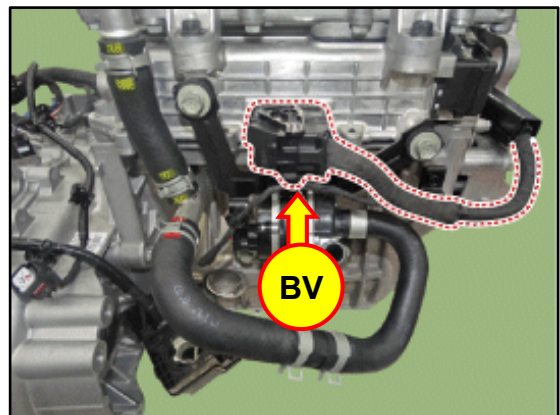

64. Loosen the EWP mounting bolts (BW) and remove the EWP with the bracket.

Tightening Torque:

13.0 – 15.9 lb-ft (17.7 – 21.6 Nm)

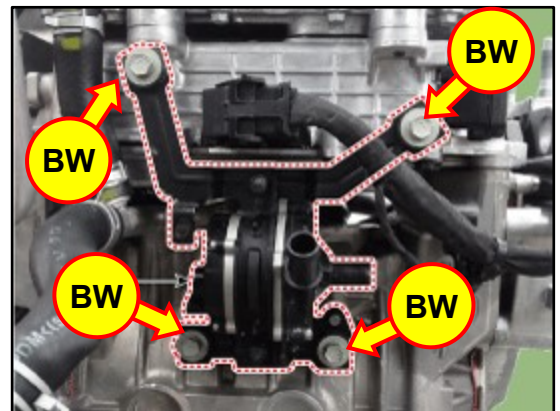

65. Loosen the mounting bolts and then remove the 3-phase cover assembly (BX).

Tightening Torque:

2.3 – 4.3 lb-ft (3.9 – 5.9 Nm)

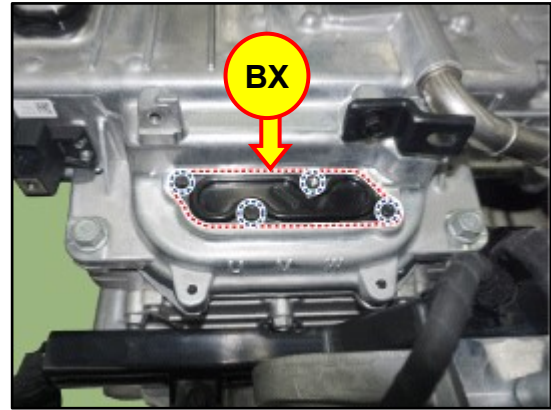

66. Loosen the EPCU mounting bolts, then remove the EPCU (BY).

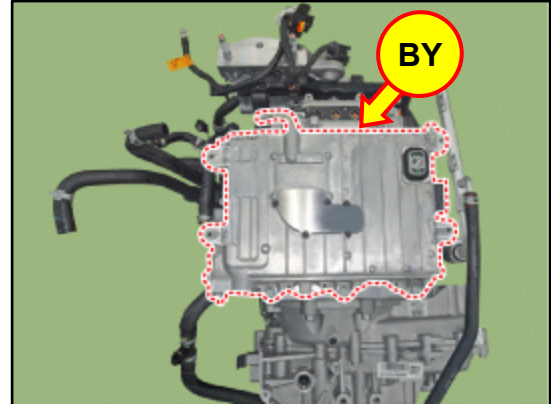

67. Loosen the water pipe mounting bolts (BZ), then remove the water pipe (CA) with the 3-way valve.

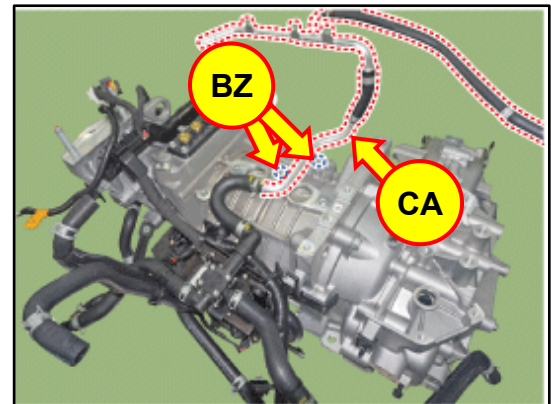

68. Remove the main wiring and protector from the traction motor and reduction gear assembly.

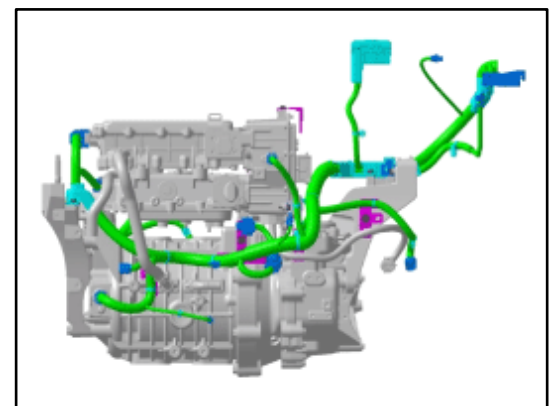

69. Loosen the refrigerant accumulator pipe bracket mounting bolt (CB).

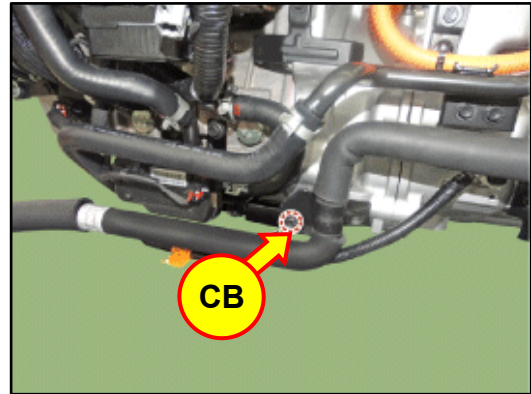

70. Disconnect the traction motor inlet hose (CC).

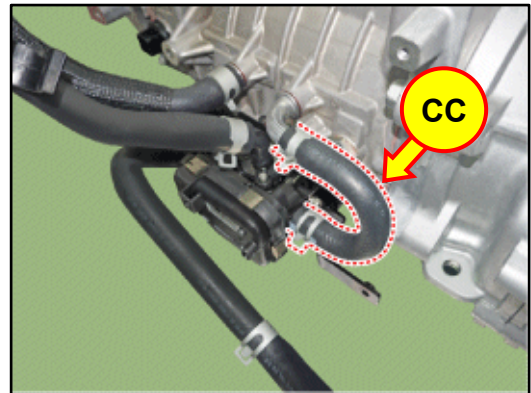

71. Loosen the heat pump 3-way valve mounting bolts, then remove the heat pump 3-way valve (CD).

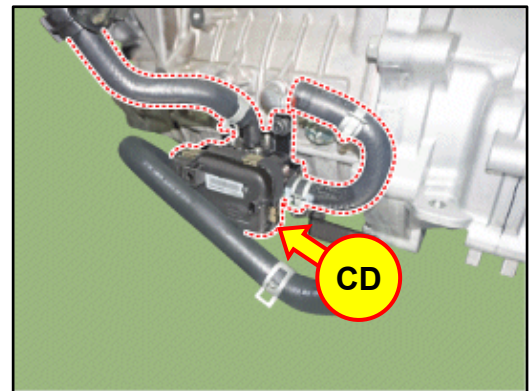

72. Remove the traction motor support bracket (CE).

Tightening Torque:

65.8 – 71.6 lb-ft (89.3 – 97.1 Nm)

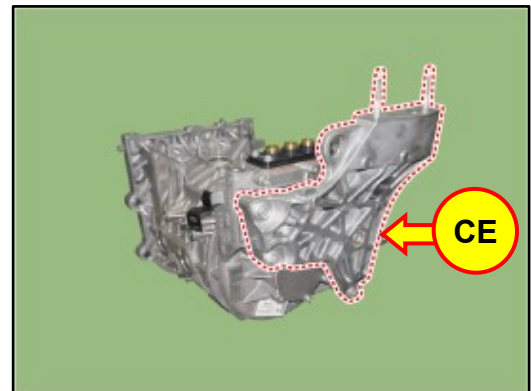

73. Loosen the reduction gear's upper mounting bolts (CF).

Tightening Torque:

65.8 – 71.6 lb-ft (89.3 – 97.1 Nm)

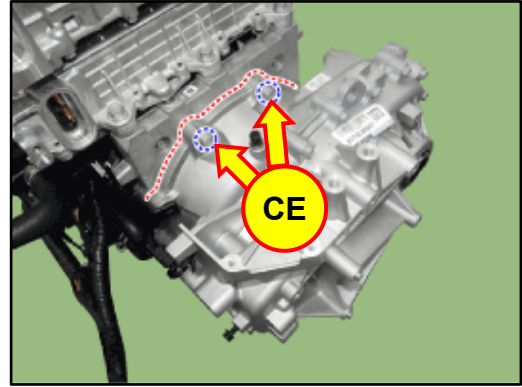

74. Loosen the lower reduction gear bolts (CF) and remove the traction motor assembly from the reduction gear.

Tightening Torque:

65.8 – 71.7 lb-ft (89.3 – 97.1 Nm)

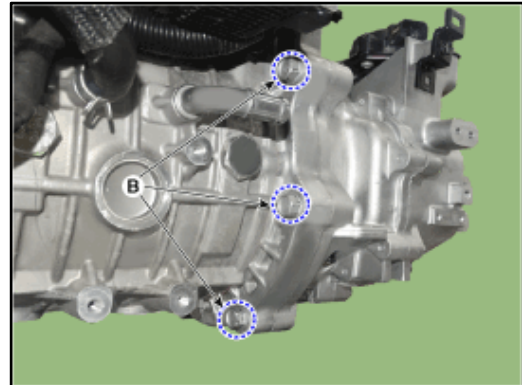
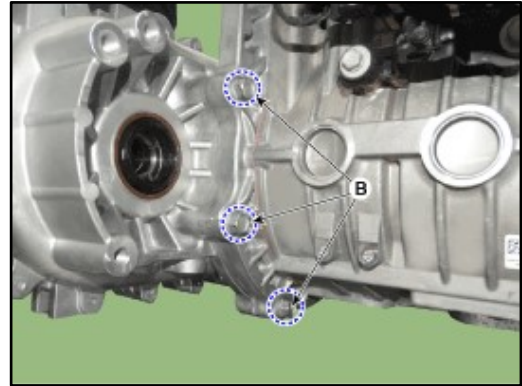

E. Traction Motor and Reduction Gear Noise Inspection Preparation

1. Place a plug in the drive shaft hole to prevent reduction gear oil from being spilled.

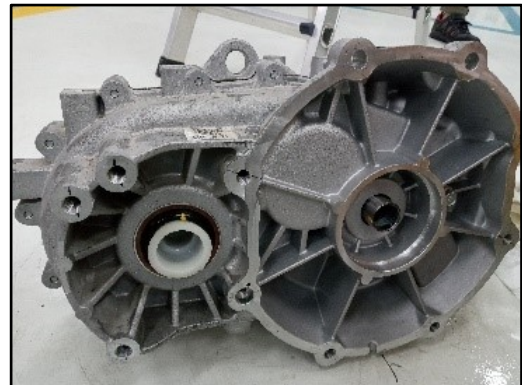

- Secure the traction motor in place so it does not move around during inspection.

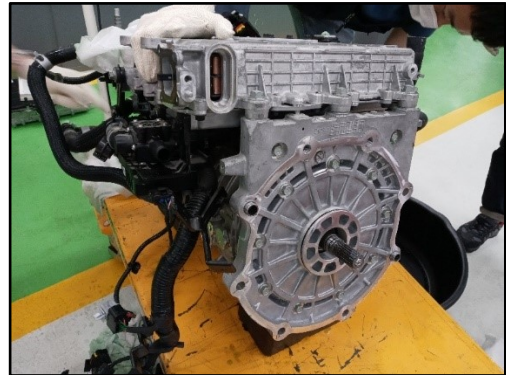

F. Traction Motor Noise Inspection

- Connect a 5mm hexagonal tip to the taper plug at the end of the traction motor shaft and carefully rotate it counterclockwise with a power tool.

NOTICE

- During the beginning of rotation, slowly rotate the shaft by hand and by power tool until inertial forces are overcome.
- If the initial torque is strong, the taper may be damaged.
- Do not use an air impact wrench.



- When motor shaft reaches a constant speed after rotating it for about 5 seconds or more, remove the tool and inspect for noises being generated in the motor shaft.
- If noise is generated from the traction motor, replace it.

G. Reduction Gear Noise Inspection

- After removing the inhibitor switch (SBW), use a 12mm socket wrench to **shift the gear into "N"**.
 - "N" Range: Counterclockwise
 - "P" Range: Clockwise



2. Inspect by rotating the reduction gear input shaft by hand.
 - Normal: No noise or severe vibration occurs during rotation:
 - Replace the Traction Motor.
 - Replace the reduction gear if abnormal noise or vibration is clearly identified.

H. Reduction Gear Vertical Reassembly

1. After inspecting for noise and replacing the part generating noise or vibrations, reassemble the traction motor and reduction gear following the procedures below.

NOTICE

If no noise is heard during traction motor / reduction gear inspection, replace the Traction Motor only.

2. Stand the traction motor vertically.
3. Stand the motor shaft upwards from the ground, then reassemble the reduction gear.



- Tighten the improved bolts in the specified order as shown on the figure to the right.

Tightening Torque:

65.8 – 71.6 lb-ft (89.3 – 97.1 Nm)

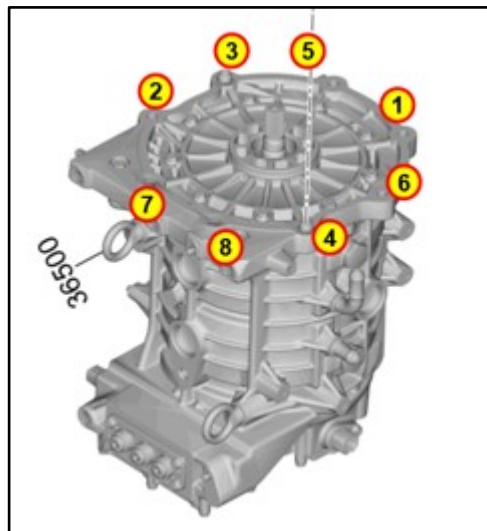

KIT A specification: Vehicles Produced before 5/13/19	KIT A Specification: Vehicles Produced after 5/13/19
<p>- 50mm bolts: 8ea ●</p>	<p>- 50mm bolts: 4ea ● - 75mm bolts: 4ea ●</p>

- Reinstall parts in reverse order of disassembly.
- The service procedure is complete.