



Service Bulletin

Bulletin No.: 12-06-01-003D

Date: May, 2022

INFORMATION

Subject: Information for Repairing Engine Front Cover Oil Leak, Sealing Surface Preparation and Applying RTV Sealant

Models: 2006-2022 GM Passenger Cars and Trucks (Including Export Vehicles) Equipped with V6 Engine – RPO LAU, LF1, LFW, LFX, LFY, LLT, LP1, LY7, LF3 or LF4

This bulletin has been revised to add the 2020-2022 Model Years. Please discard Corporate Bulletin Number 12-06-01-003C.

Abrasive Pads - Bristle Discs - Surface Conditioning Discs - Wire Wheels

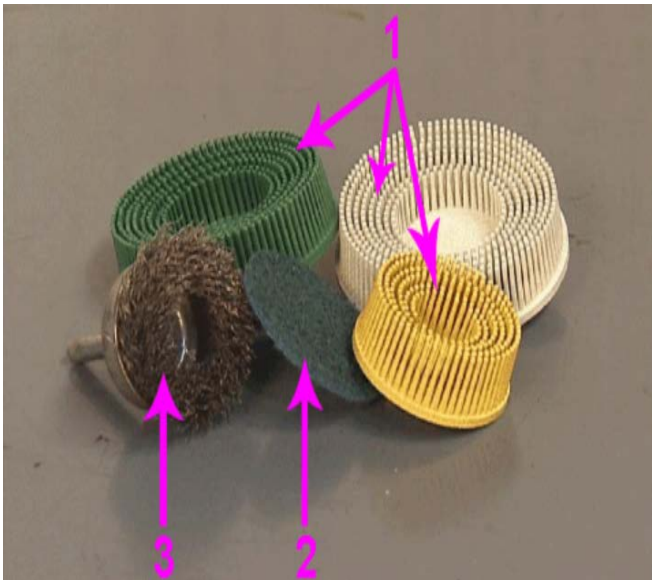

2833722

Notice: DO NOT use bristle discs (1), abrasive pads (2), wire wheels (3) or surface conditioning discs to clean the sealing surfaces of engine components.

Abrasive pads and bristle discs are embedded with abrasive material. The bristle discs wear down as they clean, continually exposing fresh abrasive to the surface of the component. These types of devices should not be used because they produce a very fine grit that the oil filter is unable to remove from the oil. THIS GRIT IS ABRASIVE AND IS KNOWN TO CAUSE INTERNAL ENGINE DAMAGE.

- Abrasive pads, wire wheels and bristle discs can remove enough metal to affect the engine front cover, cylinder head, engine block, oil pan rail, and intake manifold runner surface flatness, which can then result in engine coolant leaks, engine oil leaks and air leaks. It takes about 15 seconds to remove 0.203mm (0.008in) of metal with an abrasive pad.
- Abrasive pads, wire wheels and bristle discs used with high speed grinders produce airborne debris that can travel throughout the shop contaminating other work being performed outside of the immediate work area.
- When cleaning engine gasket sealing surfaces and/or cleaning parts from an engine that are to be reused, surface conditioning discs, typically constructed of woven fiber or molded bristles that contain abrasives, such as a high amount of aluminum oxide, should NOT be used. The use of such surface conditioning discs dislodges aluminum oxide from the disk and metal component particles, which can lead to premature engine bearing failure. The presence of aluminum oxide in engine oil has been shown to cause premature engine bearing failure. In some cases, this failure occurs in as little as 1,600km (1,000mi) or less after the repair has been made.
- Surface conditioning discs may grind the component material and embed it into the disc. This can result when more aggressive grinding of the gasket surface takes place.

Separating Components That Use RTV Sealant

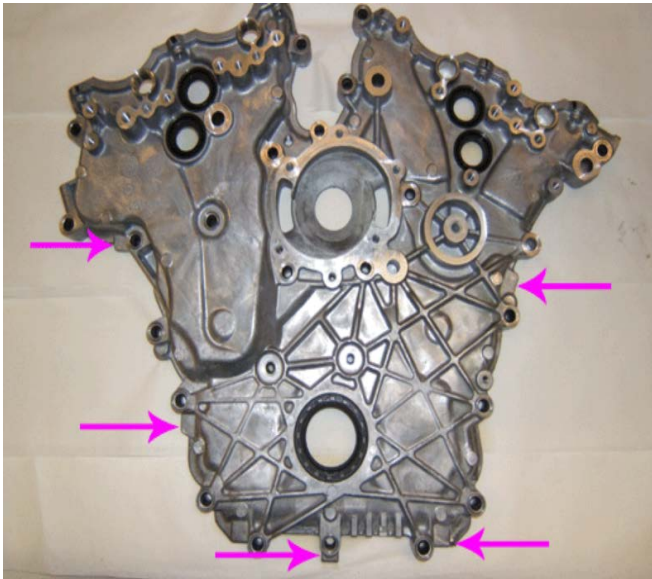

2834479

- Use the incorporated pry points to separate the engine front cover from the engine block.
- The pry points are positioned so that other vital engine components are not damaged when the pry points are used.
- Do not try to separate RTV sealed components by prying against other engine components.

Recommended Cleaning Devices and Method for Removing and Applying RTV Sealant

General Motors strongly recommends using a plastic razor blade, plastic gasket scraper, a wood scraper or a non-metallic scraper to remove all sealer/gasket material on the surface of engine components that are to be reused. Do not use any other method or technique to remove the sealant or the gasket material from a part.

- Do not gouge or scratch any engine sealing surface during the cleaning process.
- It is not necessary to remove every speck of the old sealer.
- To remove the old RTV sealant from the sealing surface, spray GM Low VOC Cleaner, P/N 19287401 (in Canada, P/N 88901247) or an equivalent, on the mating surfaces and allow it to soak in for 5 minutes to loosen the old gasket material. Use care to avoid getting GM Low VOC Cleaner in any area other than the mating surface to be cleaned.

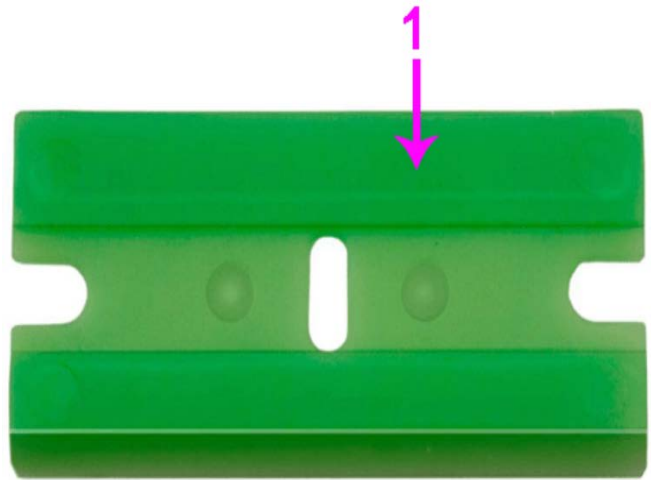

2832454

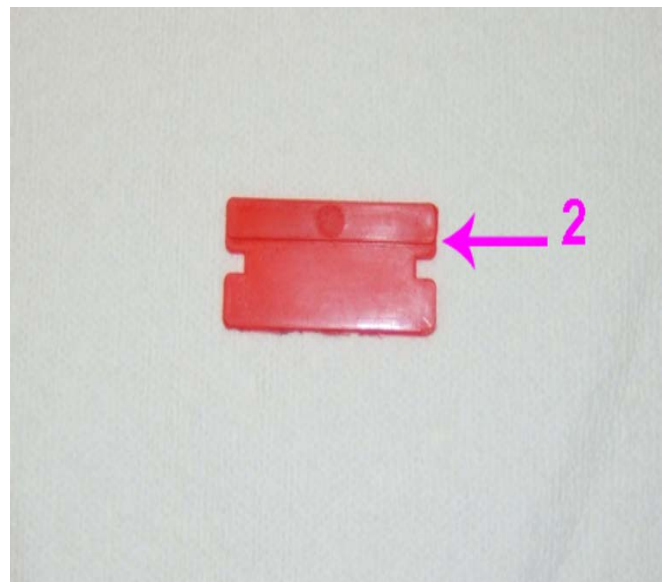

2833177

- Use a plastic razor blade (1), that mounts in a scraper device or a hand held plastic razor blade (2), to remove old RTV sealant from a sealing surface. Use a new blade for each corresponding engine component surface. Hold the blade as parallel to the flat surface as possible.

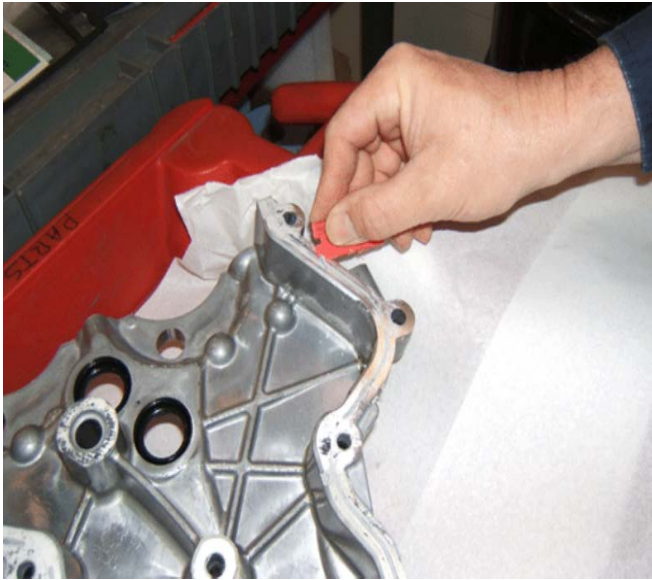

2834507

- Position and work the blade back and forth in the grooved areas of the component to loosen and remove the old RTV.

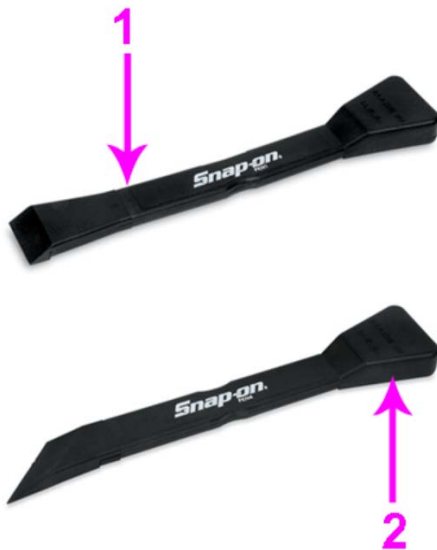

2832527

- When using a plastic gasket scraper with a straight blade (1) to remove old RTV sealant from a sealing surface, hold the scraper as parallel to the flat surface as possible.
- Use a plastic gasket scraper with an angle blade (2) and work the blade back and forth in the grooved areas of the component to loosen and remove the old RTV.
- Clean the engine front cover in solvent.
- Dry the engine front cover with compressed air.

Notice: After the final cleaning with GM Low VOC Cleaner and before reassembly, DO NOT touch the cleaned surfaces with your hand. Oils from your skin WILL CONTAMINATE the surface and prevent proper bonding of the new RTV sealant.

- To properly clean the sealing surfaces prior to reassembly, spray GM Low VOC Cleaner, on a folded lint free shop cloth. Wipe the mating surfaces on the engine and front cover and rotate the shop cloth until there are no more visible signs of contamination on the cloth.
- After the final cleaning of the parts, allow 5 minutes for the components to dry before applying new RTV sealant.



2833110

- Use a Tube Grip® dispensing device (1) or an equivalent to apply the new RTV sealant for the following reasons:
 - A precise application of the RTV sealant bead to the component, in the specified amount.
 - The dispensing device will squeeze 35 % more material out of the tube, reducing waste.
 - Using the device will eliminate most cleanup.

Engine Front Cover - Removal - Surface Preparation - Removing and Applying RTV Sealant - Installation

1. Drain the engine coolant. Refer to Cooling System Draining and Filling in SI.

Notice: It is essential that this Step is performed as outlined in order to reduce the possibility of the REMAINING engine coolant entering the oil pan when the front cover is being removed.

2. Position a suitable container under the water pump to collect any remaining engine coolant. Remove the water pump. Refer to *Water Pump Removal* in SI.
3. Remove the engine front cover. Refer to *Engine Front Cover Replacement* in SI.

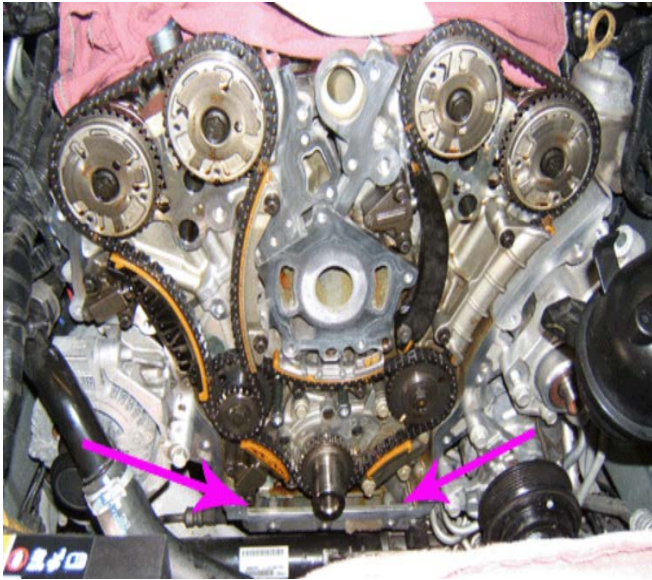

2833996

4. Insert a piece of cardboard at the front of the oil pan in the area shown to prevent any contaminants and debris from falling into the oil pan.

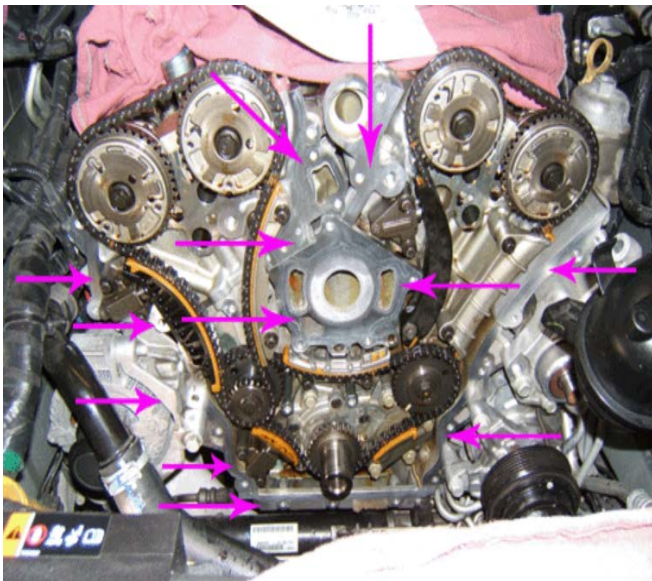

2834020

5. Using the tool or tools as outlined in this bulletin, carefully clean the front cover sealing surfaces on the **engine**.
6. Clean out any debris from the bolt holes for the front cover fasteners in the **engine**.

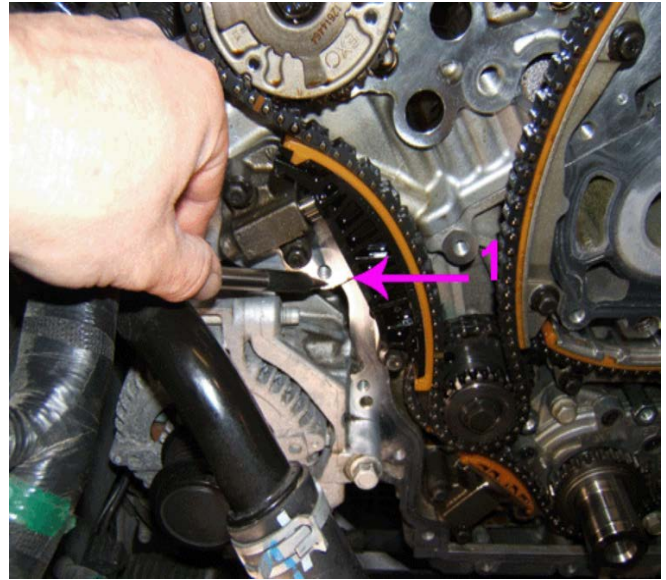

2834570

7. Clean out any debris from the T-joint (1) where the left side of the cylinder head meets the engine block.

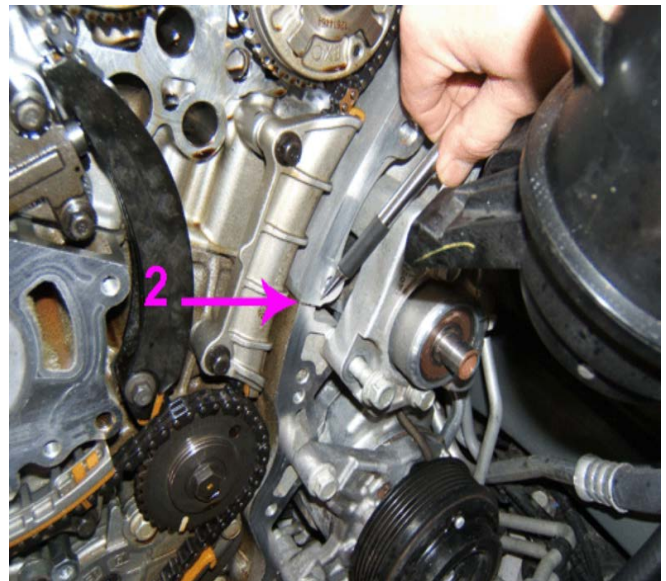

2834612

8. Clean out any debris from the T-joint (2) where the right side of the cylinder head meets the engine block.

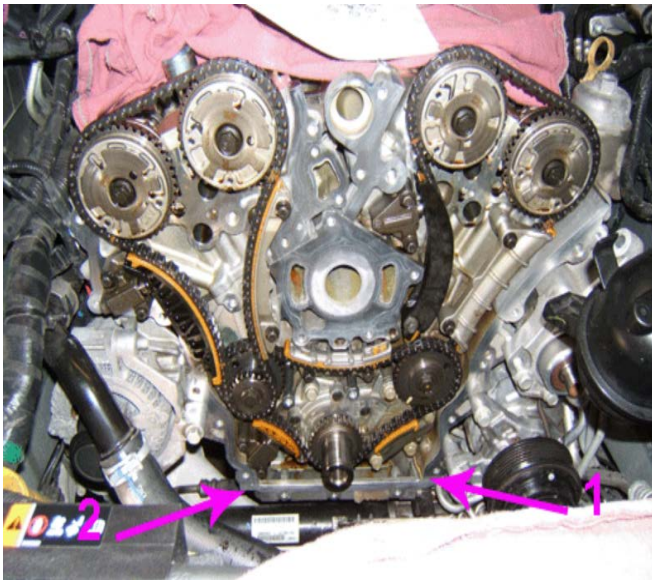

2834622

9. Clean out any debris from the T-joint (2) where the left side of the oil pan meets the engine block.

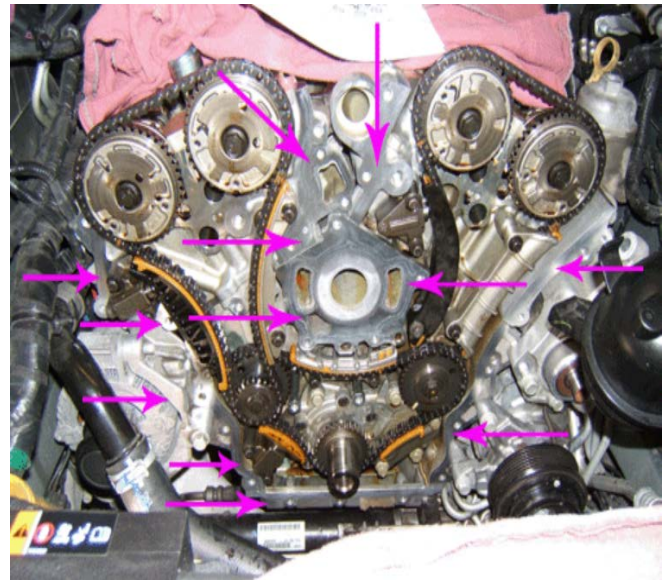

2834020

12. Wipe the front cover mating surfaces on the **engine** with a folded lint free shop cloth. Rotate the shop cloth until there are no more visible signs of contamination on the cloth.
13. Spray GM Low VOC Cleaner, or an equivalent, on the mating surfaces of the front cover and allow it to soak in for 5 minutes.

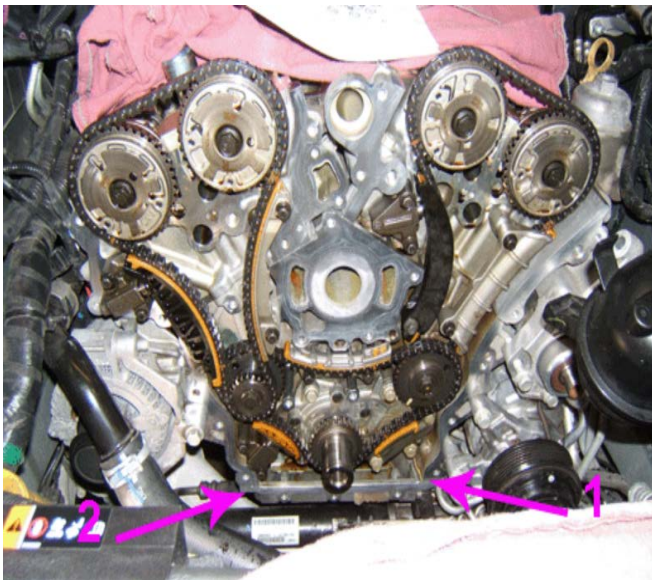

2834622

10. Clean out any debris from the T-joint (1) where the right side of the oil pan meets the engine block.
11. Spray GM Low VOC Cleaner, P/N◆19287401 (in Canada, P/N 88901247) or an equivalent, on the mating surfaces of the **engine** side for the front cover and allow it to soak in for 5 minutes.

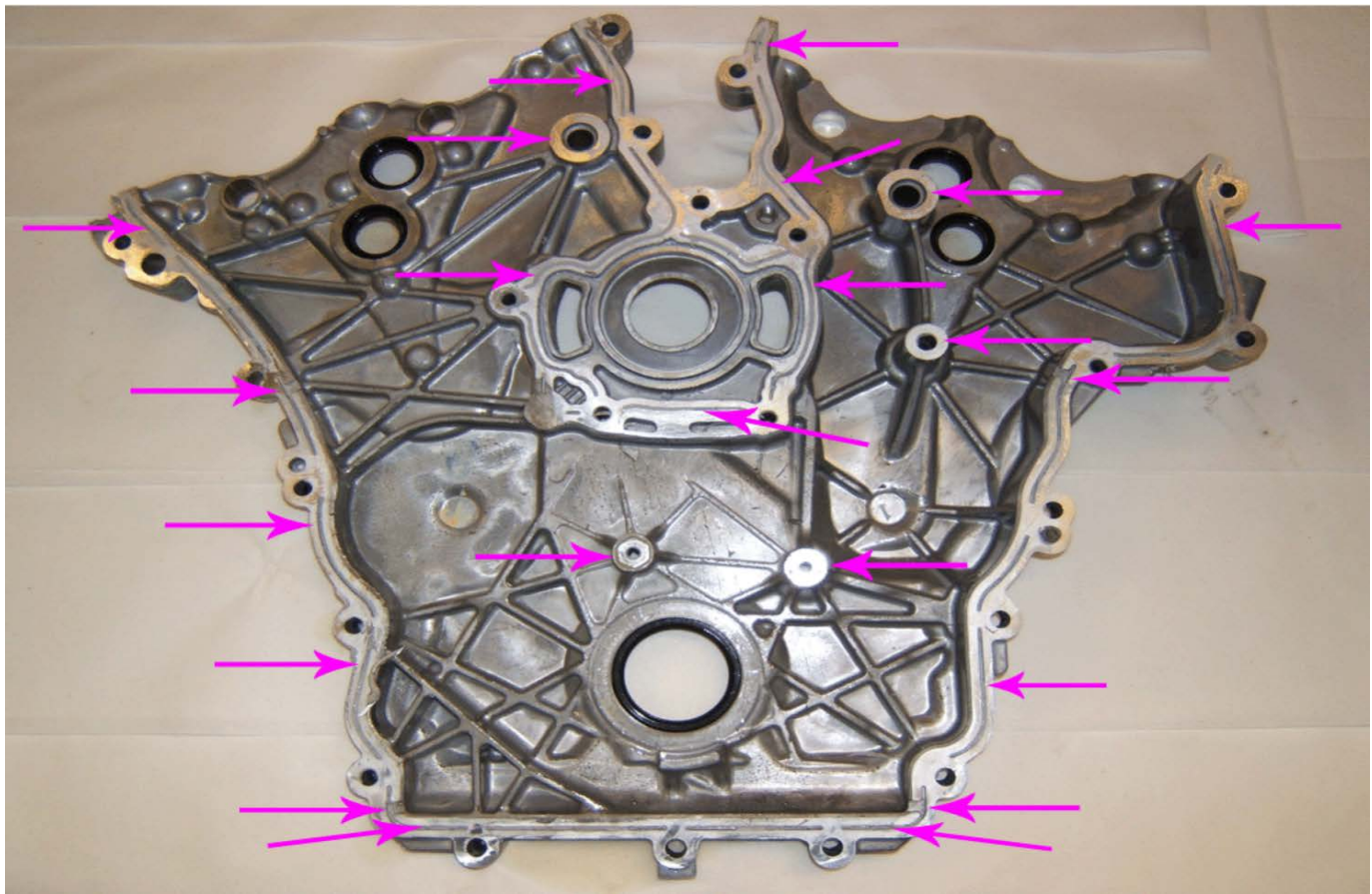

2834958

14. Carefully clean the front cover sealing surfaces and grooves.
15. Clean out any debris from the bolt holes for the front cover fasteners.
16. Drain and wipe the remaining oil from the front cover.
17. Dry the front cover with compressed air.

18. Inspect the exterior of the front cover for the following conditions:
 - Damage to the camshaft position actuator valve oil seal bores (1).
 - Damage to any bolt holes (2).
 - Damage and/or corrosion to the engine coolant passage (3).
 - Dents or damage to the exterior (4).
 - Damage to the crankshaft front oil seal bore (5).
 - Gouges or damage to the water pump sealing surfaces (6).
 - Damage to the water pump bolt hole threads (7).

⇒ If any of the above conditions are found, repair or replace the front cover as necessary.

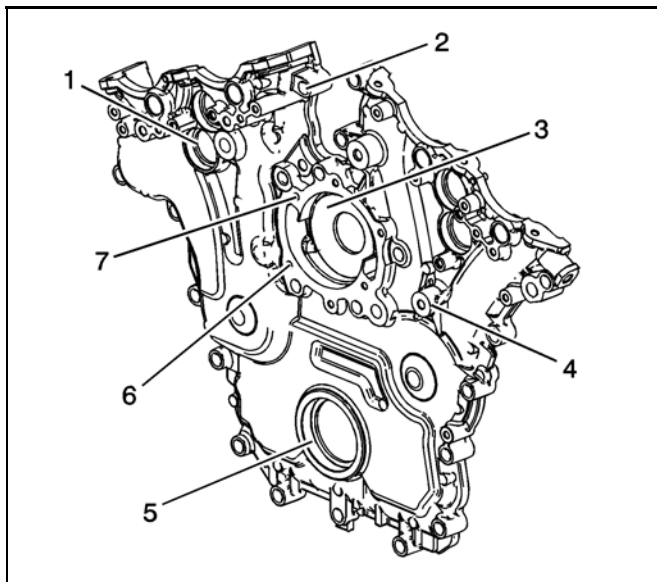

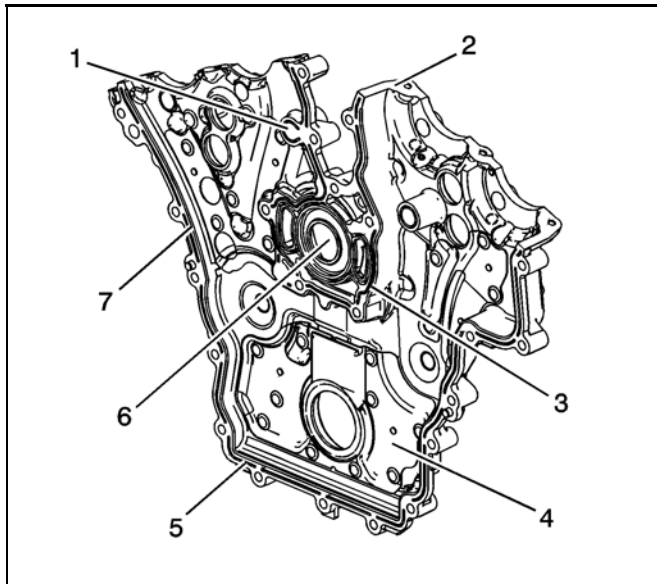

1408427

19. Inspect the interior of the front cover for the following conditions:
- Damage to any bolt holes (1).
 - Gouges or damage to the cover sealing surfaces to the engine block (7), oil pan (5) and camshaft covers (2).
 - Gouges or damage to the water pump seal area (3).
 - Loose or damaged deadener plates (4).
 - Damage and/or corrosion to the engine coolant passage (6).
 - Damage to the crankshaft front oil seal bore.
 - Gouges or damage to the O-ring sealing areas.
- ⇒ If any of the above conditions are found, repair or replace the front cover as necessary.



2835832

- Notice: Wear Gloves. After the final cleaning with GM Low VOC Cleaner and before reassembly, DO NOT touch the cleaned surfaces with your bare hand. The oils from your skin WILL CONTAMINATE the surfaces and prevent proper bonding of the new RTV sealant.**
20. Clean the sealing surface prior to reassembly by spraying GM Low VOC Cleaner, on a folded lint free shop cloth. Wipe the mating surfaces and rotate the shop cloth until there are no more visible signs of contamination on the cloth.
 21. After the final cleaning of the parts, allow 5 minutes for the components to dry before applying new RTV sealant.
 22. Remove the cardboard from the front of the oil pan.

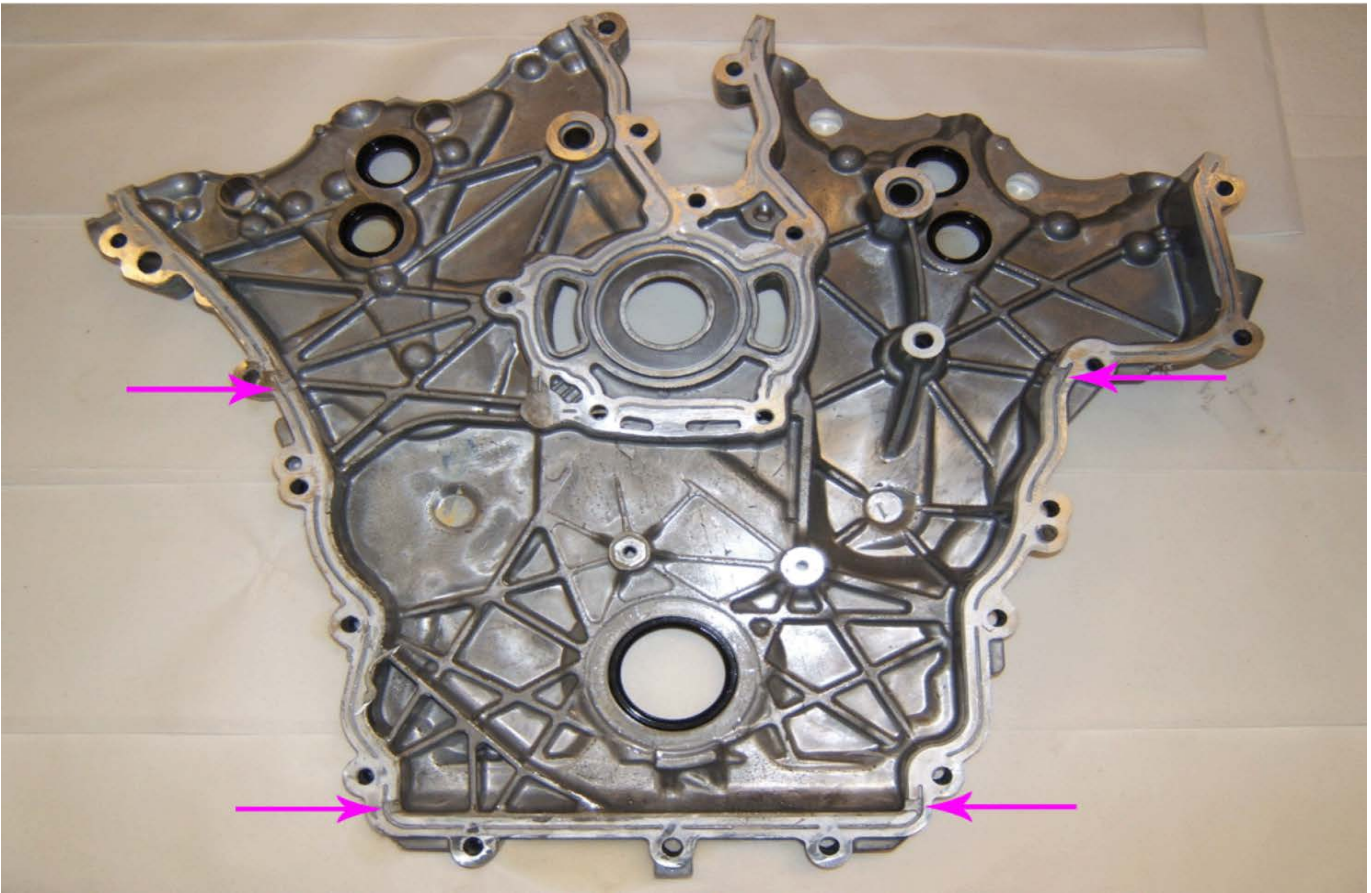

2834933

Notice: THIS STEP IS ESSENTIAL.

Oil leaks at the T-joints are one of the most common conditions encountered.

23. Apply a 5 mm bead of RTV sealant to the T-joints on the front cover in order to ensure that there is enough sealant to extend into the joint.

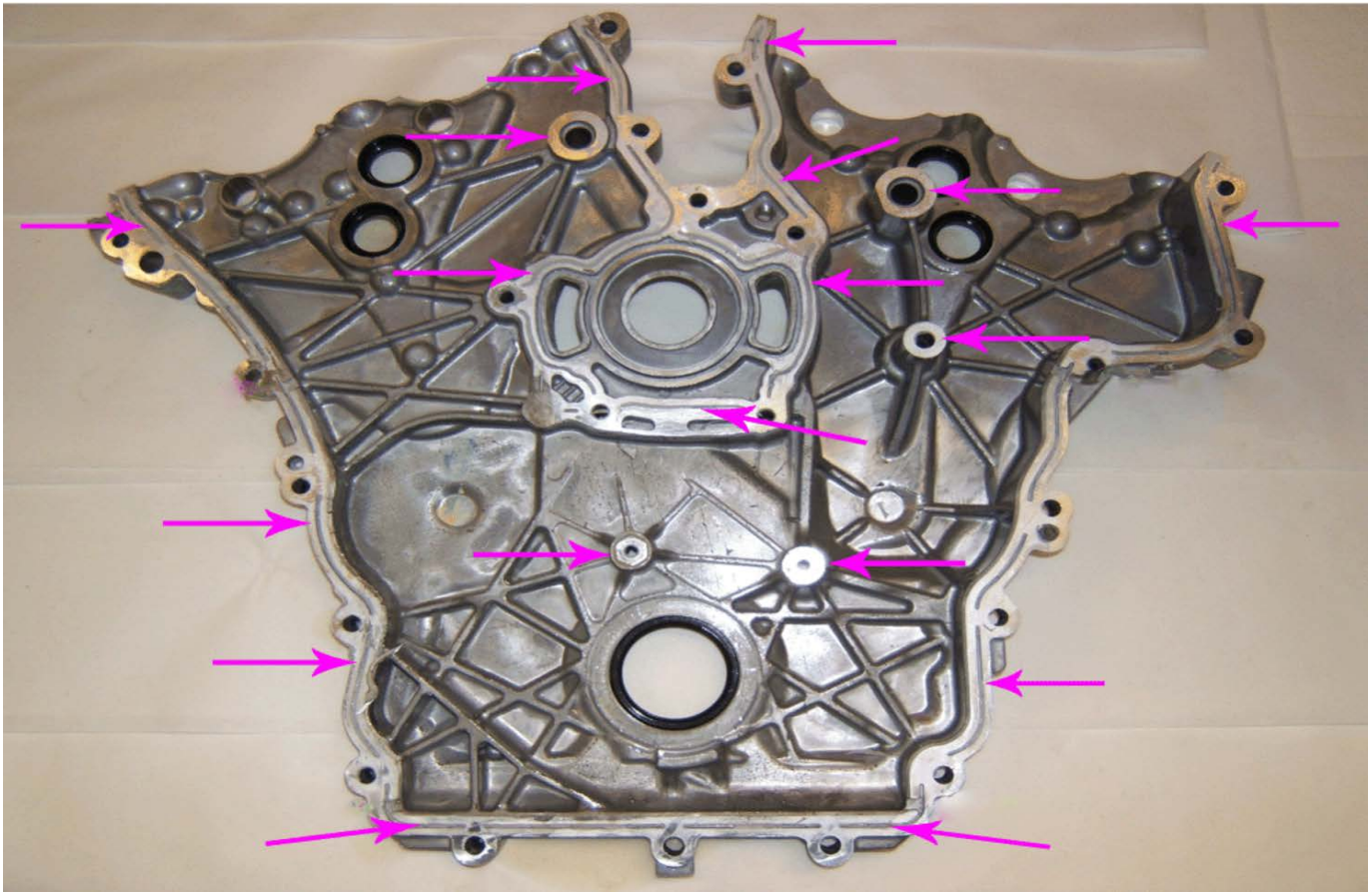

2835399

24. Apply a 3 mm bead of RTV sealant to the remaining front cover sealing surfaces.

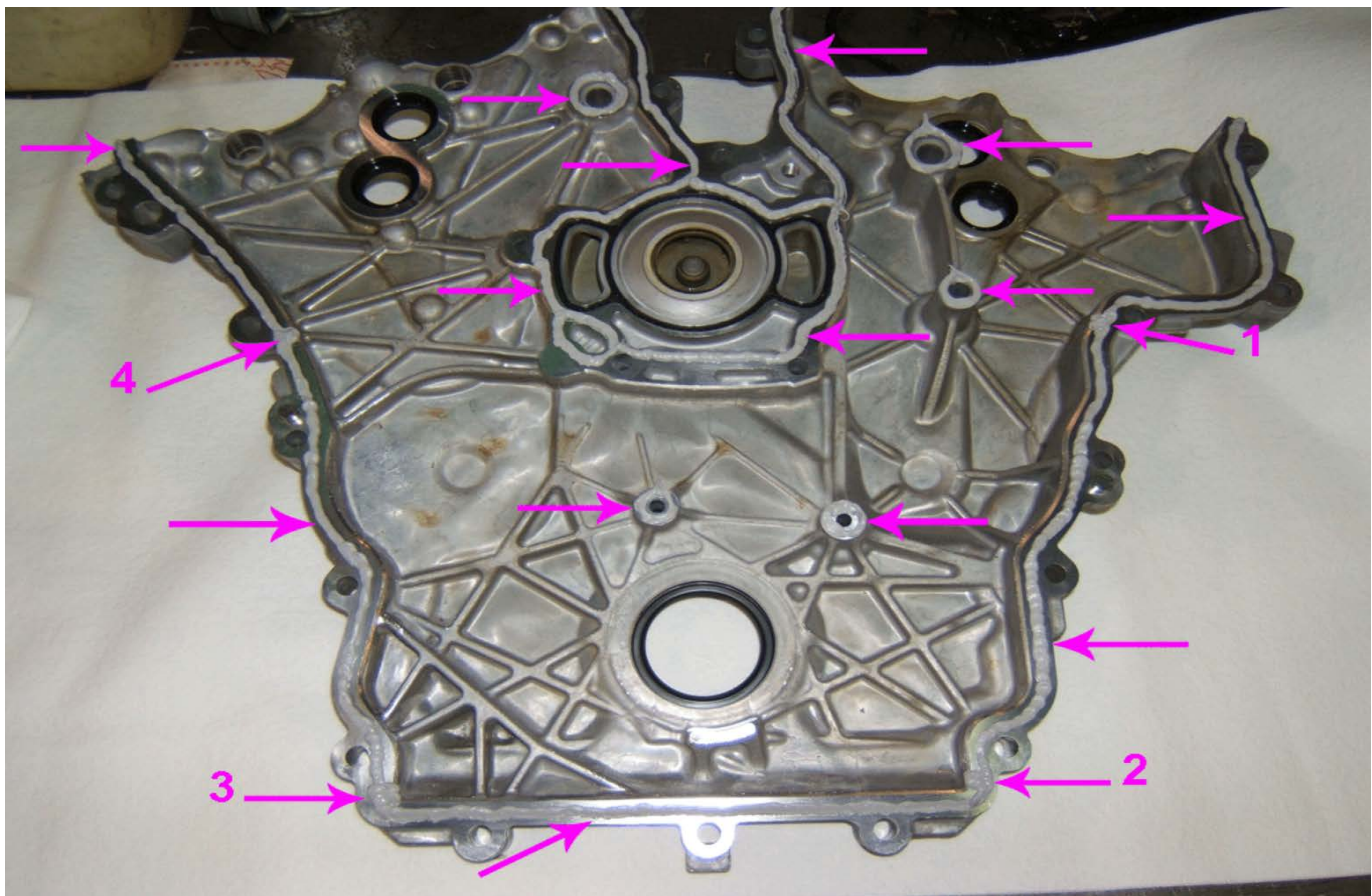

2835122

25. This is a typical view of the proper application of the RTV sealant to the front cover, with a 5 mm bead of RTV sealant to the T-joints (1, 2, 3, 4) and a 3 mm bead of RTV sealant to the rest of the sealing surfaces.

Notice: The front cover must be installed BEFORE the RTV sealant is allowed to “skin over” or the sealant will not adhere.

26. Install the front cover to the engine. Refer to *Engine Front Cover Replacement* in SI.

27. Install the water pump. Refer to *Water Pump Installation* in SI.

28. Complete the repair. Refer to *Engine Front Cover Replacement* in SI.

Trademark Attribution

Snap-On® is a Registered Trademark of Snap-On Incorporated

Tube Grip® is a Registered Trademark of Valco Cincinnati Inc.