

<b>Subject:</b>  <b>CX-50 SERVICE CAUTIONS FOR NEW AND REVISED FEATURES</b>	<b>Service Alert No.: SA-011/22</b>
	<b>Last Issued : 03/10/2022</b>

## BULLETIN NOTES

### APPLICABLE MODEL(S)/VINS

2023 CX-50

### DESCRIPTION

The CX-50 has new and revised features that are different from previous models, and may be difficult to understand. This Service Alert provides valuable information to support potential dealer and customer concerns.

### Index

[PDI fuse](#)  
[Key Transmitter and Auxiliary Key](#)  
[i-stop](#)  
[i-stop LN3 Battery Charging](#)  
[Smart Brake Support \[Rear\] \(SBS-R\)](#)  
[Driver Monitoring \(DM\)](#)  
[Driver Attention Alert \(DAA\)](#)  
[Connected Vehicle Enrollment](#)  
[Connected Vehicle Maintenance Mode](#)  
[Mazda Connected Vehicle Viewer \(MCVV\)](#)  
[Mazda intelligent Drive Select \(Mi-Drive\)](#)  
[Wireless Apple Carplay™ / Android Auto™](#)  
[Wireless Qi Charger](#)  
[Remote Power Window](#)  
[Panorama Sunroof](#)  
[Electric Parking Brake \(EPB\)](#)  
[Front Radar Sensor](#)  
[Front Wiper Service Caution](#)  
[MAZDA CONNECT Power Function](#)  
[Power Door Locks](#)  
[Walk-Away Auto Lock Function](#)  
[Transmitter Battery Saving Function](#)  
[Keyless Entry Using Auxiliary Key](#)  
[Rear Door Child Safety Locks Operation](#)

**CONSUMER NOTICE:** The information and instructions in this bulletin are intended for use by skilled technicians. Mazda technicians utilize the proper tools/ equipment and take training to correctly and safely maintain Mazda vehicles. These instructions should not be performed by "do-it-yourselfers." Customers should not assume this bulletin applies to their vehicle or that their vehicle will develop the described concern. To determine if the information applies, customers should contact their nearest authorized Mazda dealership. Mazda North American Operations reserves the right to alter the specifications and contents of this bulletin without obligation or advance notice. All rights reserved. No part of this bulletin may be reproduced in any form or by any means, electronic or mechanical--including photocopying and recording and the use of any kind of information storage and retrieval system ---without permission in writing.

[Theft-Deterrent System](#)  
[Link Seat & Climate Control Temperatures](#)  
[Web-Based Training Courses](#)

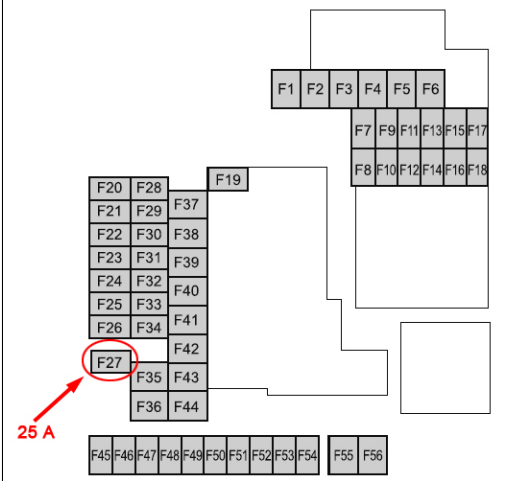
Item	Service Information
<p><b>Fuse to be Installed at PDI</b></p> <p>Fuse F27 (25A) is removed from the engine compartment fuse block and is stored on the engine compartment fuse block lid.</p> <p><b>NOTE:</b></p> <ul style="list-style-type: none"> <li>• Make sure the fuse is fully installed into position and flush with all of the other fuses.</li> <li>• Check for the Connected Vehicle signal after installing fuse F27. The connectivity signal bar looks like a vertical stack bar on the bottom right corner of the screen and should be white as shown below to be working properly. This bar is not displayed on the "Home" screen, but on the "Entertainment" or "Navigation" menu.</li> </ul> 	<p>Fuse Block (Engine Compartment)</p> 
<p><b>Key Transmitter and Auxiliary Key</b></p> <p>Vehicles arrive at the dealer with auxiliary keys and key transmitters located in the front cup holders.</p>	<p style="text-align: right;"><a href="#">SA-030/21</a></p> <p>See Owner's Manual -&gt; Before Driving -&gt; <a href="#">Keys</a> -&gt; Auxiliary Key</p>

**CONSUMER NOTICE:** The information and instructions in this bulletin are intended for use by skilled technicians. Mazda technicians utilize the proper tools/ equipment and take training to correctly and safely maintain Mazda vehicles. These instructions should not be performed by "do-it-yourselfers." Customers should not assume this bulletin applies to their vehicle or that their vehicle will develop the described concern. To determine if the information applies, customers should contact their nearest authorized Mazda dealership. Mazda North American Operations reserves the right to alter the specifications and contents of this bulletin without obligation or advance notice. All rights reserved. No part of this bulletin may be reproduced in any form or by any means, electronic or mechanical--including photocopying and recording and the use of any kind of information storage and retrieval system ---without permission in writing.



**NOTE:**

- Key machine software update coming soon to support the CX-50.

Except CX-50, 5 digit key code	CX-50, 4 digit key code and a plastic bar code tag

- Discard the plastic bar code tag during PDI. The plastic bar code tag is used during vehicle production and is not needed by the customer.

**CONSUMER NOTICE:** The information and instructions in this bulletin are intended for use by skilled technicians. Mazda technicians utilize the proper tools/ equipment and take training to correctly and safely maintain Mazda vehicles. These instructions should not be performed by "do-it-yourselfers." Customers should not assume this bulletin applies to their vehicle or that their vehicle will develop the described concern. To determine if the information applies, customers should contact their nearest authorized Mazda dealership. Mazda North American Operations reserves the right to alter the specifications and contents of this bulletin without obligation or advance notice. All rights reserved. No part of this bulletin may be reproduced in any form or by any means, electronic or mechanical--including photocopying and recording and the use of any kind of information storage and retrieval system ---without permission in writing.

- If additional auxiliary metal keys are needed, the key machine will require a 5-digit code. Just add "5" as the 1st digit to make the 4-digit to 5-digit.

The auxiliary keys need to be inserted into the key transmitters during PDI.

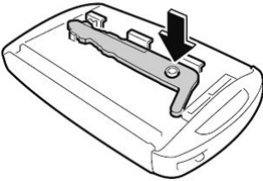
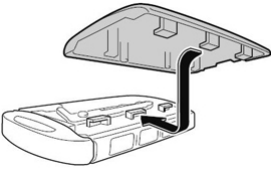
<p>Remove the transmitter lower cover by sliding the knob in the direction shown and then sliding the cover in the opposite direction.</p>	
<p>Insert the auxiliary key.</p>	
<p>Install the transmitter lower cover by inserting the tabs of the lower cover into the slots of the transmitter.</p>	

Transmitter Note:



- If one transmitter is lost, inform the customer to take cautions not to lose the 2nd transmitter.
- If both transmitters are lost, the vehicle will be disabled and MDARS will need to be used to program new transmitters.
- Replacement battery type is CR2032 (3V, 225mAh), which is different than previous 6th generation transmitter battery type CR2025 (3V, 160mAh). If the wrong battery is installed, the transmitter might not work properly (malfunction).

**CONSUMER NOTICE:** The information and instructions in this bulletin are intended for use by skilled technicians. Mazda technicians utilize the proper tools/ equipment and take training to correctly and safely maintain Mazda vehicles. These instructions should not be performed by "do-it-yourselfers." Customers should not assume this bulletin applies to their vehicle or that their vehicle will develop the described concern. To determine if the information applies, customers should contact their nearest authorized Mazda dealership. Mazda North American Operations reserves the right to alter the specifications and contents of this bulletin without obligation or advance notice. All rights reserved. No part of this bulletin may be reproduced in any form or by any means, electronic or mechanical---including photocopying and recording and the use of any kind of information storage and retrieval system ---without permission in writing.

**i-stop\***

The i-stop function automatically stops the engine when the vehicle is stopped at a traffic light or stuck in traffic, and then restarts the engine automatically to resume driving. The system provides improved fuel economy, reduced exhaust gas emissions, and eliminates idling noise while the engine is stopped.

**i-stop OFF Switch**

When pressing the switch, the i-stop function is disabled and the i-stop OFF switch indicator light turns on (1). If the switch is pressed again, the i-stop function is enabled and the i-stop OFF switch indicator light turns off.

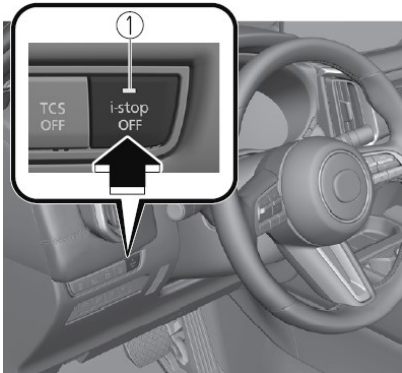
**NOTE**

- If the engine is stopped with the i-stop function stopped, the i-stop function becomes operational again when the engine is started the next time.
- New LN3 Battery for vehicles equipped with i-stop.
- Battery disconnect/reconnect - Perform the battery condition initial setting (i-stop setting). Go to MGSS [BATTERY CONDITION INITIALIZATION SETTING \(i-stop SETTING\)](#)

\* if equipped

Owner's Manual -> When Driving -> Start/ Stop Engine -> [i-stop](#)

MGSS Service Highlights -> i-stop -> [i-stop CONTROL](#)

**Indicator Light****Green**

The i-stop indicator light (green) notifies the driver that the engine is stopped by i-stop control.

**Amber Flashing**

If the i-stop control inhibits i-stop operation, the i-stop warning light (amber) flashes to inform the driver.

- DTC stored

**Amber Solid**

If the i-stop control inhibits i-stop operation, the i-stop warning light (amber) turns ON solid to inform the driver.

- Ignition switched ON (check of i-stop control system)
- Engine stalls due to driver's operation while engine is stopped by i-stop control
- Communication error to PCM and instrument cluster

**i-stop\* LN3 Battery Charging**

Temporary LN3 Battery Charging Procedure until DCA-8000 software update is available.

**DCA-8000**

1. Main Menu - Select In-Vehicle Charge

**CONSUMER NOTICE:** The information and instructions in this bulletin are intended for use by skilled technicians. Mazda technicians utilize the proper tools/ equipment and take training to correctly and safely maintain Mazda vehicles. These instructions should not be performed by "do-it-yourselfers." Customers should not assume this bulletin applies to their vehicle or that their vehicle will develop the described concern. To determine if the information applies, customers should contact their nearest authorized Mazda dealership. Mazda North American Operations reserves the right to alter the specifications and contents of this bulletin without obligation or advance notice. All rights reserved. No part of this bulletin may be reproduced in any form or by any means, electronic or mechanical--including photocopying and recording and the use of any kind of information storage and retrieval system ---without permission in writing.



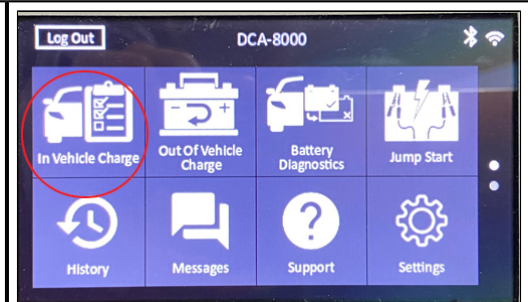

## 2. Scan or enter VIN manually



## 3. Change Cranking Units to CCA

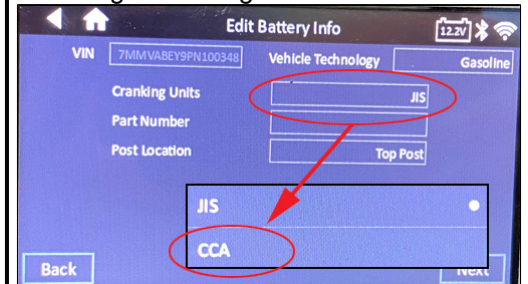

## 4. Edit Battery Info, then Select Continue

- Battery Type - I-ELOOP
- Cranking Units - CCA
- Cranking Rating - 622
- Post Location - Top Post
- Capacity Units - Rated Ah
- Capacity Rating - 72

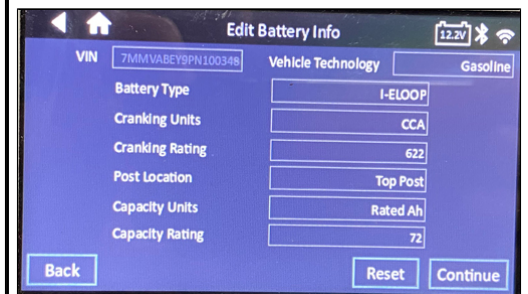

**CONSUMER NOTICE:** The information and instructions in this bulletin are intended for use by skilled technicians. Mazda technicians utilize the proper tools/ equipment and take training to correctly and safely maintain Mazda vehicles. These instructions should not be performed by "do-it-yourselfers." Customers should not assume this bulletin applies to their vehicle or that their vehicle will develop the described concern. To determine if the information applies, customers should contact their nearest authorized Mazda dealership. Mazda North American Operations reserves the right to alter the specifications and contents of this bulletin without obligation or advance notice. All rights reserved. No part of this bulletin may be reproduced in any form or by any means, electronic or mechanical--including photocopying and recording and the use of any kind of information storage and retrieval system ---without permission in writing.

5. DCA-8000 will test battery before charging begins

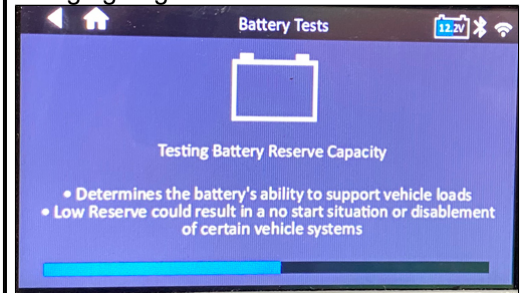

**Smart Brake Support [Rear] (SBS-R)\***

The Smart Brake Support [Rear] (SBS-R) system is designed to apply the brakes automatically to reduce the damage from a possible collision if the driver fails to confirm the safety at the rear while reversing resulting in an increased possibility of a collision with vehicles or obstructions at the rear of the vehicle.

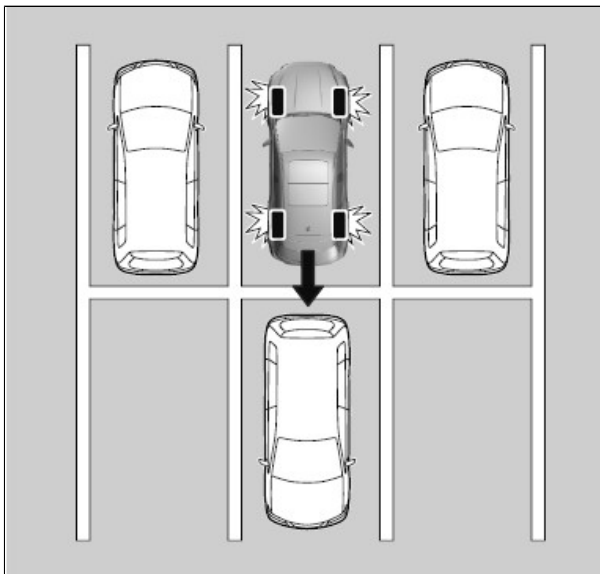

MGSS Service Highlights -> i-  
ACTIVSENSE SYSTEM -> **SMART  
BRAKE SUPPORT [REAR] (SBS-R)**

Owner's Manual -> When Driving -> i-  
ACTIVSENSE -> **Smart Brake Support  
(SBS)** -> Reverse drive detection

**Driver Monitoring (DM) System\***

System determines that the driver is not paying attention to the road using the driver monitoring camera and it determines that there is the possibility of a collision with an obstruction, the Smart Brake Support (SBS) activates the collision warning earlier than normal. (Vehicle with Driver Monitoring (DM))

Owner's Manual -> MAZDA CONNECT  
OWNER'S MANUAL -> Settings -> **Safety  
Setting** -> Driver Monitoring

**CONSUMER NOTICE:** The information and instructions in this bulletin are intended for use by skilled technicians. Mazda technicians utilize the proper tools/ equipment and take training to correctly and safely maintain Mazda vehicles. These instructions should not be performed by "do-it-yourselfers." Customers should not assume this bulletin applies to their vehicle or that their vehicle will develop the described concern. To determine if the information applies, customers should contact their nearest authorized Mazda dealership. Mazda North American Operations reserves the right to alter the specifications and contents of this bulletin without obligation or advance notice. All rights reserved. No part of this bulletin may be reproduced in any form or by any means, electronic or mechanical--including photocopying and recording and the use of any kind of information storage and retrieval system ---without permission in writing.

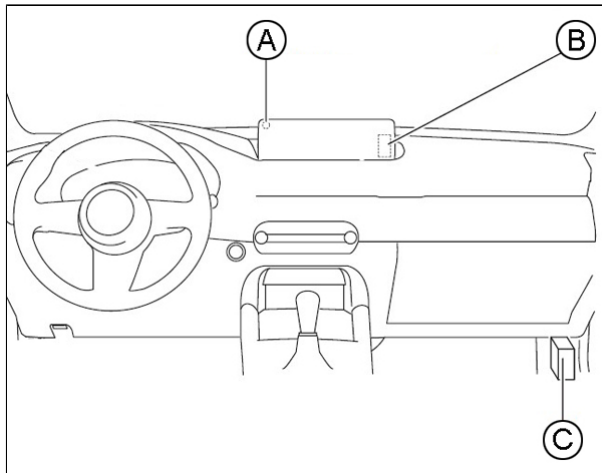

A - Driver Monitoring Camera  
 B - Driver Monitoring Camera LED  
 C - Driver Monitoring Unit

### Driver Attention Alert (DAA)\*

The DAA is a system which detects driver fatigue and decreased attentiveness, and encourages the driver to take a rest. When the vehicle is driven inside traffic lane lines at about 65 to 140 km/h (41 to 86 mph), the DAA estimates the amount of accumulated fatigue and decreased attentiveness of the driver based on the information from the Forward Sensing Camera (FSC) (A) and other vehicle information, and encourages the driver to take a rest using an indication on the multi-information display and a warning sound. Use the DAA on expressways or highways

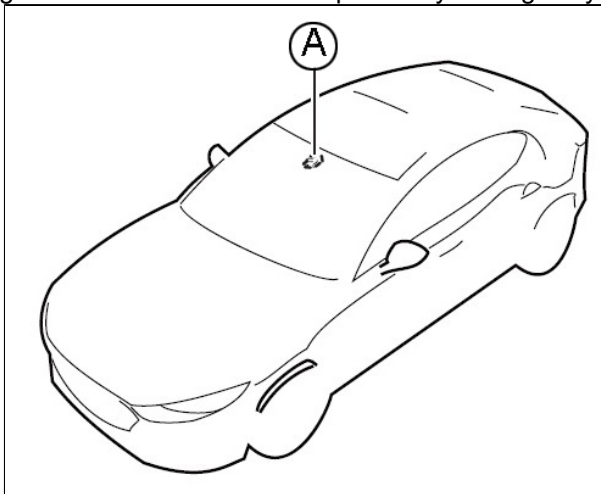

Owner's Manual -> When Driving -> i-  
 ACTIVSENSE -> [Driver Attention Alert \(DAA\)](#)

MGSS Service Highlights -> i-  
 ACTIVSENSE SYSTEM -> [DRIVER ATTENTION ALERT SYSTEM](#)

**CONSUMER NOTICE:** The information and instructions in this bulletin are intended for use by skilled technicians. Mazda technicians utilize the proper tools/ equipment and take training to correctly and safely maintain Mazda vehicles. These instructions should not be performed by "do-it-yourselfers." Customers should not assume this bulletin applies to their vehicle or that their vehicle will develop the described concern. To determine if the information applies, customers should contact their nearest authorized Mazda dealership. Mazda North American Operations reserves the right to alter the specifications and contents of this bulletin without obligation or advance notice. All rights reserved. No part of this bulletin may be reproduced in any form or by any means, electronic or mechanical--including photocopying and recording and the use of any kind of information storage and retrieval system ---without permission in writing.



**Connected Vehicle Enrollment**

Vehicles produced before March 3, 2022

MyMazda App Connected Vehicle enrollment. Door jam VIN label scan fails using an Android Smartphone.

This is caused by the door Jam VIN label bar code having limited white space on both sides.

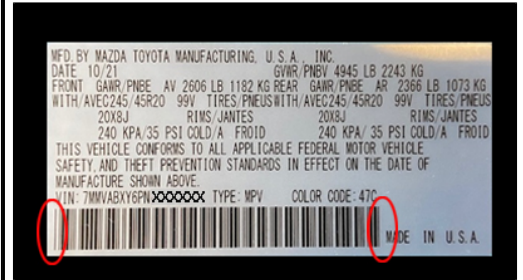

**NOTE:** This is not an issue on vehicles with light exterior colors such as white.

*Temporary Workaround*

- Add VIN manually
- Add white tape to left side of label

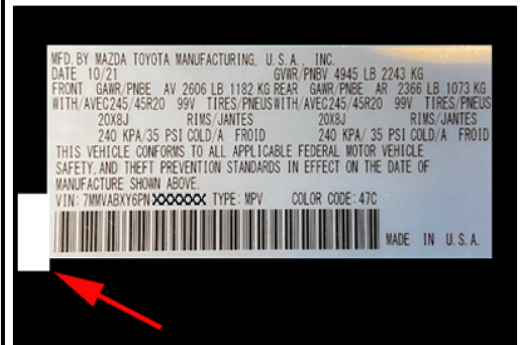

**Connected Vehicle Maintenance Mode**

When vehicle is being serviced, switch to Restricted Transmitting Mode.

- Restricts MyMazda App remote functions.
- Prevents error messages being sent to the customer during vehicle service.

Cancel Restricted Transmitting Mode after completing vehicle service.

Go to [MGSS SERVICE CAUTIONS FOR VEHICLES WITH TELEMATICS COMMUNICATION SYSTEM \[\(US\)\]](#).

**Mazda Connected Vehicle Viewer (MCSV)**

The Mazda Connected Vehicle Viewer (MCSV) enhances the Mazda

[MAZDA CONNECTED VEHICLE VIEWER USER GUIDE \(MCSV\)](#)

**CONSUMER NOTICE:** The information and instructions in this bulletin are intended for use by skilled technicians. Mazda technicians utilize the proper tools/ equipment and take training to correctly and safely maintain Mazda vehicles. These instructions should not be performed by "do-it-yourselfers." Customers should not assume this bulletin applies to their vehicle or that their vehicle will develop the described concern. To determine if the information applies, customers should contact their nearest authorized Mazda dealership. Mazda North American Operations reserves the right to alter the specifications and contents of this bulletin without obligation or advance notice. All rights reserved. No part of this bulletin may be reproduced in any form or by any means, electronic or mechanical--including photocopying and recording and the use of any kind of information storage and retrieval system ---without permission in writing.

ownership experience by providing Mazda Service Advisors, Technicians and Call Center Associates access to real-time vehicle status information alerts for applicable Mazda connected vehicles.

This powerful tool allows you to proactively understand and diagnose customer concerns and resolve potential issues, demonstrating how well you know the customer's vehicle while establishing your readiness and willingness to assist.

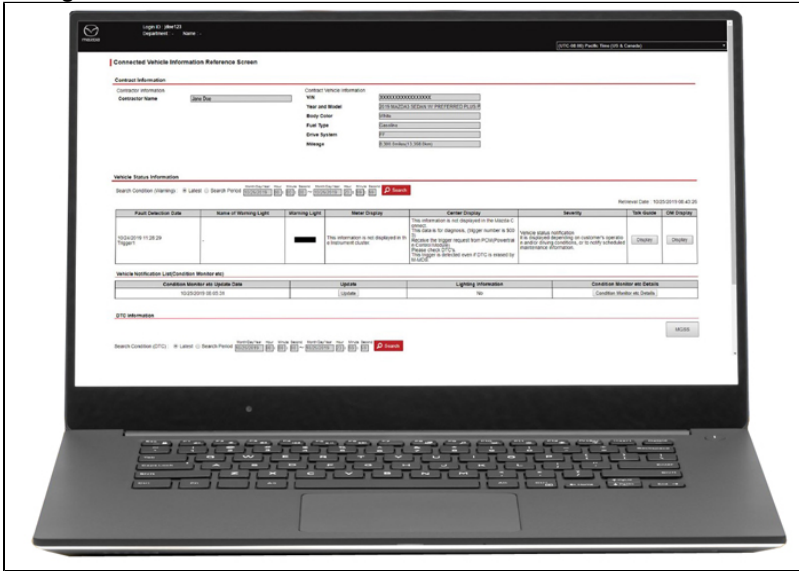

**Mazda intelligent Drive Select (Mi-Drive)\***

Mi-drive is a system that switches the drive modes depending on the driving conditions, road conditions and vehicle conditions. The mode can be switched from normal to sport, off-road or towing.

The following drive modes can be switched according to the conditions.

MGSS Service Highlights -> Engine -> [Mazda intelligent Drive Select \(Mi-Drive\) SYSTEM](#)

See Owner's Manual -> When Driving -> Mazda intelligent Drive Select (Mi-Drive) -> [Mazda intelligent Drive Select \(Mi-Drive\) \(AWD\)](#)

**CONSUMER NOTICE:** The information and instructions in this bulletin are intended for use by skilled technicians. Mazda technicians utilize the proper tools/ equipment and take training to correctly and safely maintain Mazda vehicles. These instructions should not be performed by "do-it-yourselfers." Customers should not assume this bulletin applies to their vehicle or that their vehicle will develop the described concern. To determine if the information applies, customers should contact their nearest authorized Mazda dealership. Mazda North American Operations reserves the right to alter the specifications and contents of this bulletin without obligation or advance notice. All rights reserved. No part of this bulletin may be reproduced in any form or by any means, electronic or mechanical--including photocopying and recording and the use of any kind of information storage and retrieval system ---without permission in writing.

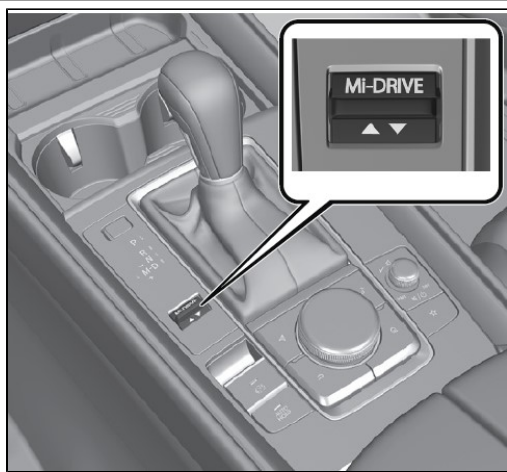

**Normal mode**

- This mode is suitable for normal driving or gentle acceleration.

**Sport mode**

- This mode enhances vehicle responsiveness when the accelerator pedal is depressed. This provides additional quick acceleration which may be needed to safely make maneuvers such as lane changes, merging onto freeways, or passing other vehicles.

**Off-road mode**

- This mode helps prevent drive-wheel spinning during off-road driving and improves driving performance. Use this mode to drive the vehicle on slippery roads such as muddy, sandy, or deep-snowy roads.

**Towing mode**

- This mode suppresses the reduction of driving performance due to increased weight during trailer towing and promotes vehicle stability. Use this mode when towing a trailer.

\* if equipped

**Wireless Apple Carplay™ / Android Auto™**

Infotainment Touch Screen enabled during Wireless Apple Carplay™ / Android Auto™ operation.

Owner's Manual -> MAZDA CONNECT OWNER'S MANUAL -> [Touch Panel Operation](#)

Owner's Manual -> MAZDA CONNECT OWNER'S MANUAL -> [Apple Carplay™ / Android Auto™](#)

**CONSUMER NOTICE:** The information and instructions in this bulletin are intended for use by skilled technicians. Mazda technicians utilize the proper tools/ equipment and take training to correctly and safely maintain Mazda vehicles. These instructions should not be performed by "do-it-yourselfers." Customers should not assume this bulletin applies to their vehicle or that their vehicle will develop the described concern. To determine if the information applies, customers should contact their nearest authorized Mazda dealership. Mazda North American Operations reserves the right to alter the specifications and contents of this bulletin without obligation or advance notice. All rights reserved. No part of this bulletin may be reproduced in any form or by any means, electronic or mechanical--including photocopying and recording and the use of any kind of information storage and retrieval system ---without permission in writing.

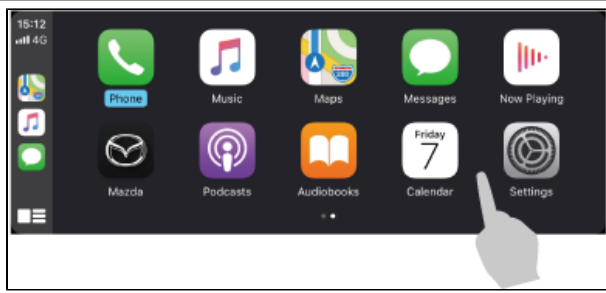

**Wireless Qi Charger\***

You can charge mobile devices such as Smartphones which comply with the Qi Wireless Charging standard.  
 Only use mobile devices that have a maximum power consumption of 5 W, or 15 W or below. The maximum power consumption differs depending on the mobile device.

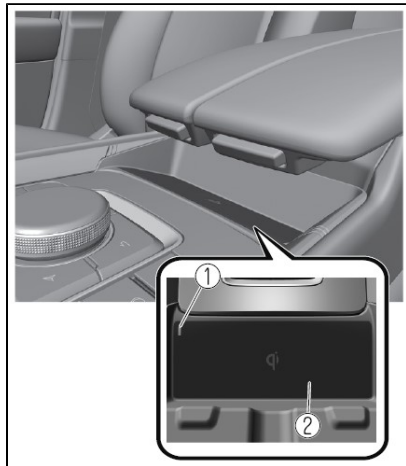

- 1. LED indicator
- 2. Charging area

- The LED indicator turns on in **amber** or **green** when charging starts.
- For details on the LED indicator, refer to the LED indicator table.
- Charging starts when all the doors and liftgate are closed.



\* if equipped

See Owner's Manual -> Interior Features -> Interior Equipment -> [Wireless Charger \(Qi\)](#)

Illumination / flash pattern	Infotainment Icon indication	Status
Does not turn on	---	Indicates that charging is turned off.
Turns on white		Indicates that charging is possible.
Turns on amber		Indicates normal charging.
Turns on green		Indicates fast charging*.
Flashes white		Indicates that the charging conditions are not met.
Flashes red		Indicates that charging is not possible because a high temperature is detected.

Indicates

**CONSUMER NOTICE:** The information and instructions in this bulletin are intended for use by skilled technicians. Mazda technicians utilize the proper tools/ equipment and take training to correctly and safely maintain Mazda vehicles. These instructions should not be performed by "do-it-yourselfers." Customers should not assume this bulletin applies to their vehicle or that their vehicle will develop the described concern. To determine if the information applies, customers should contact their nearest authorized Mazda dealership. Mazda North American Operations reserves the right to alter the specifications and contents of this bulletin without obligation or advance notice. All rights reserved. No part of this bulletin may be reproduced in any form or by any means, electronic or mechanical--including photocopying and recording and the use of any kind of information storage and retrieval system ---without permission in writing.

			<p>that charging is not possible because foreign matter is detected.</p>
<p><b>Remote Power Window Operation</b></p> <p>The windows can be opened for ventilating the cabin before getting in the vehicle. Press the unlock button on the key quickly and briefly 3 times and then immediately afterwards, press and hold the unlock button to open the windows.</p>  <p>To stop the windows from opening, release the button. If the operation is performed from the beginning again, the windows open.</p>	<p>Turns on red</p>		<p>Indicates that there is a problem with Wireless Charger (Qi) and it needs to be repaired. Consult an Authorized Mazda Dealer.</p>
<p><b>Panorama Sunroof*</b></p>	<p>See Owner's Manual -&gt; Before Driving -&gt; Power Windows -&gt; <a href="#">Remote Power Window Operation</a></p> <p>See Owner's Manual -&gt; Before Driving -&gt; Windows -&gt; <a href="#">Panorama Sunroof</a></p>		

**CONSUMER NOTICE:** The information and instructions in this bulletin are intended for use by skilled technicians. Mazda technicians utilize the proper tools/ equipment and take training to correctly and safely maintain Mazda vehicles. These instructions should not be performed by "do-it-yourselfers." Customers should not assume this bulletin applies to their vehicle or that their vehicle will develop the described concern. To determine if the information applies, customers should contact their nearest authorized Mazda dealership. Mazda North American Operations reserves the right to alter the specifications and contents of this bulletin without obligation or advance notice. All rights reserved. No part of this bulletin may be reproduced in any form or by any means, electronic or mechanical--including photocopying and recording and the use of any kind of information storage and retrieval system ---without permission in writing.





The panorama sunroof can be opened or closed when operating the overhead tilt/slide switch (1) in the front roof console.

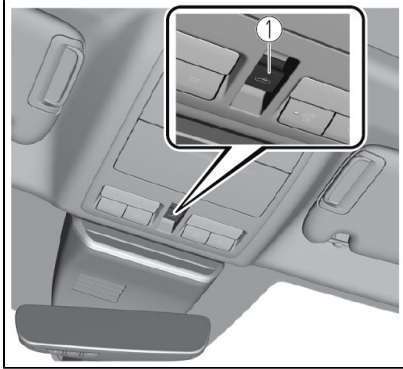

## Electric Parking Brake (EPB)

### *Parking Brake Auto Operation Change*

When the ignition is switched OFF, the parking brake will be applied automatically. The EPB indicator light in the instrument cluster and the EPB switch indicator light (1) turn ON.



See Owner's Manual -> When Driving -> Brake -> [EPB Auto operation](#) -> Releasing the parking brake automatically

**CONSUMER NOTICE:** The information and instructions in this bulletin are intended for use by skilled technicians. Mazda technicians utilize the proper tools/ equipment and take training to correctly and safely maintain Mazda vehicles. These instructions should not be performed by "do-it-yourselfers." Customers should not assume this bulletin applies to their vehicle or that their vehicle will develop the described concern. To determine if the information applies, customers should contact their nearest authorized Mazda dealership. Mazda North American Operations reserves the right to alter the specifications and contents of this bulletin without obligation or advance notice. All rights reserved. No part of this bulletin may be reproduced in any form or by any means, electronic or mechanical--including photocopying and recording and the use of any kind of information storage and retrieval system ---without permission in writing.

**Canceling the Parking Brake Auto Operation**

The parking brake auto operation can be canceled using the procedure in the Owner's Manual.

**NOTE: When the ignition is cycled back ON, the parking brake auto operation is restored.**

**Parking Brake Automatic Release**

If the selector lever is shifted from the P position to a position other than P with the parking brake applied and all of the following conditions met, the parking brake is released automatically. When the parking brake is released, the EPB indicator light in the instrument cluster and the EPB switch indicator light turn off.

Engine is running
Driver's door is closed
Shift interlock release is enabled
The brake pedal is being depressed

**Front Radar Sensor**

The location of the front radar sensor has changed. It is now located below the front grill instead of behind the Mazda emblem in the grill.



MGSS FRONT RADAR SENSOR REMOVAL/INSTALLATION

**Front Wiper Service Caution**

The wiper arm park position is located under the hood. When servicing front wipers, front wiper service mode is required or damage to wiper arms may occur (see Service Information). If the wiper arms are replaced, M-MDS is needed for wiper arm adjustment

See Owner's Manual -> Maintenance and Care > [Replacing Windshield Wiper Blades](#)

MGSS: [WINDSHIELD WIPER BLADE AND RUBBER REMOVAL/INSTALLATION](#)

**CONSUMER NOTICE:** The information and instructions in this bulletin are intended for use by skilled technicians. Mazda technicians utilize the proper tools/ equipment and take training to correctly and safely maintain Mazda vehicles. These instructions should not be performed by "do-it-yourselfers." Customers should not assume this bulletin applies to their vehicle or that their vehicle will develop the described concern. To determine if the information applies, customers should contact their nearest authorized Mazda dealership. Mazda North American Operations reserves the right to alter the specifications and contents of this bulletin without obligation or advance notice. All rights reserved. No part of this bulletin may be reproduced in any form or by any means, electronic or mechanical--including photocopying and recording and the use of any kind of information storage and retrieval system ---without permission in writing.

(see Service Information).  
DO NOT use the wiper arms as markers when in dealer inventory.

**MAZDA CONNECT Power Off Function**

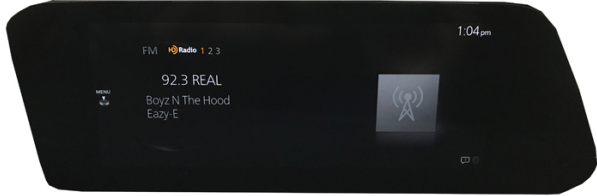

- Audio Mute: Short press the volume knob (press again to cancel)
- Power Off: Press and hold the volume knob (press and hold again to Power On)

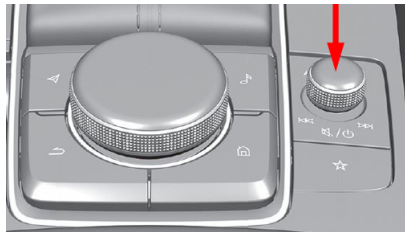

See Owner's Manual -> MAZDA CONNECT OWNER'S MANUAL -> Basic Operations -> [Commander Switch Operation](#) -> Power off/on

**Power Door Locks**

The doors cannot be unlocked using the outside door handle touch sensor. The door handle touch sensor system may not operate normally under the following conditions:

- The front passenger (without key) grabs and holds the outside door handle before the driver (with key) touches the drivers outside door handle unlock touch sensor.
- The driver touches the sensing area of the door lock touch sensor and the sensing area of the door release touch sensor at the same time.

See Owner's Manual -> Before Driving -> Doors and Locks -> [Locking, Unlocking with Touch Sensor, Door Handle](#)

Good	No Good

**CONSUMER NOTICE:** The information and instructions in this bulletin are intended for use by skilled technicians. Mazda technicians utilize the proper tools/ equipment and take training to correctly and safely maintain Mazda vehicles. These instructions should not be performed by "do-it-yourselfers." Customers should not assume this bulletin applies to their vehicle or that their vehicle will develop the described concern. To determine if the information applies, customers should contact their nearest authorized Mazda dealership. Mazda North American Operations reserves the right to alter the specifications and contents of this bulletin without obligation or advance notice. All rights reserved. No part of this bulletin may be reproduced in any form or by any means, electronic or mechanical--including photocopying and recording and the use of any kind of information storage and retrieval system ---without permission in writing.

**Walk-Away Auto Lock Function**

A beep sound is heard when all doors and the liftgate are closed while the transmitter is being carried. All the doors, fuel-filler lid, and liftgate are locked automatically when the transmitter is out of the operational range. Also, the hazard warning lights flash once. (Even if the driver is in the operational range, all the doors, fuel-filler lid, and liftgate are locked automatically after about 30 seconds.) If the driver is out of the operational range before the doors and the liftgate are completely closed or another transmitter is left in the vehicle, the walk-away auto lock function will not work. Always make sure that all doors and the liftgate are closed and locked before leaving the vehicle. The walk-away auto lock function does not close the power windows.

**Operational Range**

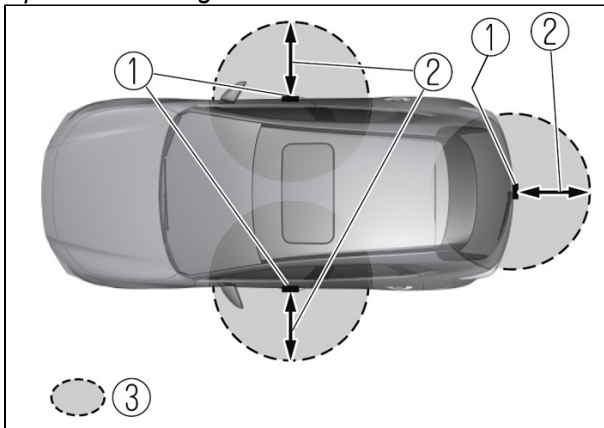

- 1. Exterior Antenna
- 2. 31 in (80 cm)
- 3. Operational range

See Owner's Manual -> MAZDA CONNECT OWNER'S MANUAL -> Settings -> Vehicle Settings - [Keyless Auto-Lock](#)

**Scenarios Where Walk-Away Lock Function May Not Work**

Scenario	Reason	Solution
Key transmitter is outside of antenna range while any of the doors have not been closed.	By the time all the doors are closed, the key transmitter is already out of operational range, causing walk-away lock to not function.	Always make sure the key transmitter holder is in operational range and is the last person to leave after all doors/trunk/liftgate

**CONSUMER NOTICE:** The information and instructions in this bulletin are intended for use by skilled technicians. Mazda technicians utilize the proper tools/ equipment and take training to correctly and safely maintain Mazda vehicles. These instructions should not be performed by "do-it-yourselfers." Customers should not assume this bulletin applies to their vehicle or that their vehicle will develop the described concern. To determine if the information applies, customers should contact their nearest authorized Mazda dealership. Mazda North American Operations reserves the right to alter the specifications and contents of this bulletin without obligation or advance notice. All rights reserved. No part of this bulletin may be reproduced in any form or by any means, electronic or mechanical--including photocopying and recording and the use of any kind of information storage and retrieval system ---without permission in writing.

<p>Key transmitter holder exits driver's door then opens rear left door to retrieve items.</p>	<ul style="list-style-type: none"> <li>Depending on the key transmitter holder's distance to the antenna when he/she is closing the driver side rear door, the walk-away lock may or may not function.</li> <li>If standing closer to the rear bumper area when closing the rear door, the key transmitter may be out of the operational range, causing walk-away lock to not function.</li> <li>If standing closer to the B-pillar when closing the rear door, the walk-away lock should function correctly.</li> </ul>	<p>are closed.</p> <p>Be mindful of the key holder's position in relation to the door exterior antenna (31 in).</p>
<p>Key transmitter holder moves out of operational range too quickly.</p>	<ul style="list-style-type: none"> <li>If the key transmitter holder is in a hurry to get out of the car and leaves the operational range too quickly before the audio beep, the walkaway lock function may not work.</li> <li>The key transmitter holder opens the driver's door, gets out, and walks away at a fast pace while shutting the door. It is possible</li> </ul>	<p>Slow down and make sure the audio beep sounds before leaving the operational range, the audio beep sound will always sound to alert the key transmitter holder that the key was detected for walk-away door lock function.</p>

**CONSUMER NOTICE:** The information and instructions in this bulletin are intended for use by skilled technicians. Mazda technicians utilize the proper tools/ equipment and take training to correctly and safely maintain Mazda vehicles. These instructions should not be performed by "do-it-yourselfers." Customers should not assume this bulletin applies to their vehicle or that their vehicle will develop the described concern. To determine if the information applies, customers should contact their nearest authorized Mazda dealership. Mazda North American Operations reserves the right to alter the specifications and contents of this bulletin without obligation or advance notice. All rights reserved. No part of this bulletin may be reproduced in any form or by any means, electronic or mechanical--including photocopying and recording and the use of any kind of information storage and retrieval system ---without permission in writing.



	<p>that by the time the door is completely shut, the key transmitter holder is already out of operational range because she/he is moving away too fast, causing walk-away lock to not function.</p>	
--	---	--

<p><b>Transmitter Battery Saving Function (Key Fob)</b></p> <p>The CX-50 has a "power saving" function built into the keyless entry system where <b>some</b> key fob functions are disabled. This feature could accidentally be enabled and some concerns with the vehicle may be:</p> <ul style="list-style-type: none"> <li>• Engine does not start.</li> <li>• Engine does not start unless you hold the fob to the start/stop button.</li> <li>• Doors do not unlock using the door handle, but unlock with the remote.</li> <li>• Doors do not lock using the door handle, but lock with the remote.</li> <li>• Transmitter indicator light does not turn on/flash.</li> </ul>	<p><b>See Owner's Manual -&gt; Before Driving -&gt; Keys -&gt; Transmitter -&gt; Power saving function</b></p>
---	--

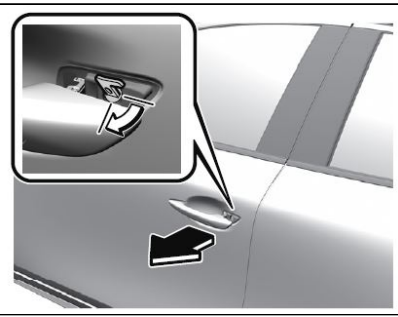
<p><b>Keyless Entry Using Auxiliary Key</b></p> <p>If the vehicle battery is discharged and/or the key battery is dead, vehicle entry is possible using the auxiliary key.</p> 	<p>See Owner's Manual -&gt; Before Driving -&gt; Keys -&gt; Auxiliary Key</p> <p>Then refer to Owner's Manual -&gt; Before Driving -&gt; Doors and Locks -&gt; <a href="#">Unlocking with Auxiliary Key</a></p>
---	---

<p><b>Rear Door Child Safety Locks Operation</b></p> <p>The auxiliary key is required to enable (lock) and disable (unlock) the rear</p>	<p>See Owner's Manual -&gt; Before Driving -&gt; Doors and Locks -&gt; <a href="#">Rear Door Child Safety Locks</a></p>
--	---

**CONSUMER NOTICE:** The information and instructions in this bulletin are intended for use by skilled technicians. Mazda technicians utilize the proper tools/ equipment and take training to correctly and safely maintain Mazda vehicles. These instructions should not be performed by "do-it-yourselfers." Customers should not assume this bulletin applies to their vehicle or that their vehicle will develop the described concern. To determine if the information applies, customers should contact their nearest authorized Mazda dealership. Mazda North American Operations reserves the right to alter the specifications and contents of this bulletin without obligation or advance notice. All rights reserved. No part of this bulletin may be reproduced in any form or by any means, electronic or mechanical--including photocopying and recording and the use of any kind of information storage and retrieval system ---without permission in writing.

door child safety locks.

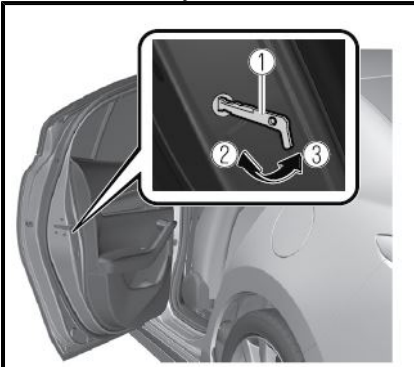

1. Auxiliary Key

2. Lock

3. Unlock

**Theft-Deterrent System**



The CX-50 is not equipped with a Theft-Deterrent System.

**CAUTION:** DO NOT use MDARS to enable:

- Burglar Alarm
- Intrusion Sensor

The CX-50 does not have the necessary Theft-Deterrent System hardware to function if enabled using MDARS, and MDARS cannot disable the Theft-Deterrent System after it has been enabled.

The following DTC's may be stored if the burglar alarm or intrusion sensor are enabled:

- B109F:87 - Intrusion Sensor Module
- B2002:87 - On Board Charger DC/DC Low Voltage Side

Contact Hotline if the Theft-Deterrent System has been accidentally enabled.

**CONSUMER NOTICE:** The information and instructions in this bulletin are intended for use by skilled technicians. Mazda technicians utilize the proper tools/ equipment and take training to correctly and safely maintain Mazda vehicles. These instructions should not be performed by "do-it-yourselfers." Customers should not assume this bulletin applies to their vehicle or that their vehicle will develop the described concern. To determine if the information applies, customers should contact their nearest authorized Mazda dealership. Mazda North American Operations reserves the right to alter the specifications and contents of this bulletin without obligation or advance notice. All rights reserved. No part of this bulletin may be reproduced in any form or by any means, electronic or mechanical--including photocopying and recording and the use of any kind of information storage and retrieval system ---without permission in writing.

Burglar Alarm	Not Run	Run
Intrusion Sensor	Not Run	Run
Ambient Lighting	Not Run	Run
Welcome Lamp	Not Run	Run
Power Supply_IG	Not Run	Run
Power Supply_TNS	Not Run	Run
LED HL_Position	Not Run	Run
LED HL_DRL	Not Run	Run
Registration for Remote Engine Starter(RES)	Not Run	Run

**Seat Warmer, Seat Ventilation and Heated Steering Wheel Auto Mode\***

The driver and front passenger's seater warmers\*, seat ventilation and the heated steering wheel\* can be set to be automatically controlled (turned on and off) by the climate control system, depending on the set temperature.

**Auto Mode**

1. Go to MAZDA CONNECT home screen and select "Settings"
2. Select "Vehicle Settings".
3. Enable "Link Seat & Climate Control Temperatures".
4. Press the climate control AUTO switch.

Link Seat & Climate Control Temperatures Setting



Owner's Manual -> MAZDA CONNECT OWNER'S MANUAL -> Settings - [Vehicle Settings](#) -> Link Seat & Climate Control Temperatures / Occupant Comfort

Owner's Manual -> Essential Safety Equipment -> Seats -> [Seat Warmer](#) / [Heated Steering Wheel](#) -> [Seat Ventilation](#)

Climate Control Auto Switch



\* if equipped

**CONSUMER NOTICE:** The information and instructions in this bulletin are intended for use by skilled technicians. Mazda technicians utilize the proper tools/ equipment and take training to correctly and safely maintain Mazda vehicles. These instructions should not be performed by "do-it-yourselfers." Customers should not assume this bulletin applies to their vehicle or that their vehicle will develop the described concern. To determine if the information applies, customers should contact their nearest authorized Mazda dealership. Mazda North American Operations reserves the right to alter the specifications and contents of this bulletin without obligation or advance notice. All rights reserved. No part of this bulletin may be reproduced in any form or by any means, electronic or mechanical--including photocopying and recording and the use of any kind of information storage and retrieval system ---without permission in writing.

2023 CX-50 [Web-Based Training Courses](#)

Course	Description
90054	2023 CX-50 VIRTUAL LEARNING
40080	CX-50 Technical Overview IDL

**CONSUMER NOTICE:** The information and instructions in this bulletin are intended for use by skilled technicians. Mazda technicians utilize the proper tools/ equipment and take training to correctly and safely maintain Mazda vehicles. These instructions should not be performed by "do-it-yourselfers." Customers should not assume this bulletin applies to their vehicle or that their vehicle will develop the described concern. To determine if the information applies, customers should contact their nearest authorized Mazda dealership. Mazda North American Operations reserves the right to alter the specifications and contents of this bulletin without obligation or advance notice. All rights reserved. No part of this bulletin may be reproduced in any form or by any means, electronic or mechanical---including photocopying and recording and the use of any kind of information storage and retrieval system ---without permission in writing.