



S.A.T.	264 Rev.1
area	MV n°

Service Bulletin

Service Bulletin - Technisches Rundschreiben - Circulaire Technique - Circular Tecnica

Date: **28 September 2021**

Subject: **Timing gear fixing washer**

Product: **Brutale 800 ROSSO / RR / SCS / RC
Dragster ROSSO / RR / SCS / RC
F3 800 / 675
Turismo Veloce Base / Lusso / SCS
Superveloce Serie Oro / Base**

For identification of the VINs involved, please refer to the list attached at the end of this document. This Service bulletin cancels and replaces the previous Service bulletin n° 264.

As a result of continuous monitoring of the quality of our product, it has been found that a technical update is required on the vehicles specified above (details later in this SB).

We kindly ask you to perform the update before delivering the vehicle to the final customer.

For motorbikes already sold, we ask you to update the vehicle at the earliest opportunity.

Element to be modified/added	Type of operation to be performed	Reason for update
Timing gear fixing washer	the washer on the bikes involved must be replaced with the modified unit supplied in the kit	The washer may not ensure the correct tightening of the timing chain sprocket/phonic wheel assembly.

REQUEST FOR WARRANTY REFUND FOR LABOR (PHASE 1):

To obtain a refund for the labour, in addition to the complete motorcycle data, it is necessary to send a Warranty claim using the following information:

- Warranty type = 2 options available:
 - New motorcycles in stock NOT REGISTERED = **GX**
 - Motorcycles sold with activated warranty = **GS**
- Special warranty number: **2847** (to be used for both GX and GS claims)
- Operation code:
- Labour time:

Brutale \ Dragster 800 ROSSO :	0.5h
Brutale \ Dragster 800 RR / SCS:	0.6h
F3 800 / 675:	0.7h
Turismo Veloce Base / Lusso / SCS:	0.5h
Superveloce Serie Oro / Base:	0.7h

- Problem code: **D999**
- Problem date: **date of insertion of warranty claim**
- It is also mandatory to include the reference "**CT 264 Rev.1**" in the warranty claim's notes.
- Spare part codes: kit code **W000W1486**, that includes:

M625-0077 timing pinion washer	1Pc.
8000B2617 generator cover gasket	1Pc.

WARRANTY CLAIM (STEP 2):

After the validation of the warranty claim by the MV Agusta Technical Assistance Service, you will automatically receive the spare parts selected to update your vehicle.

Once the update has been carried out, it will be necessary to complete the Warranty Request procedure by entering the repair date: the insertion of the repair date in the warranty request is valid as certification of the reclamation of the motorcycle by the dealer and also allows the payment of labour concerning the work performed.

NOTE: we remind you that according to the new features and warranty management procedures, the insertion of the repair date is essential and mandatory as per technical communication no. 004/17.

Tools needed for performing the operations:

- Torx 30
- Hexagonal key 10 - 15
- Strong threadlocker Loctite® 270
- Liquid gasket Threebond® 1207 B

EXECUTION OF THE UPDATE: Replacing the timing gear fixing washer

1. If present, remove the superstructures to access the generator cover on the left side of the motorbike (refer to the relative workshop manuals for the procedures related to the various models).

2. Remove the 8 screws securing the alternator cover and remove the generator cover; it will not be necessary to disconnect the generator. Support the generator cover properly and protect it from impacts with other components. When removing the generator cover, take care to keep the pin code **8000B2635** in position:

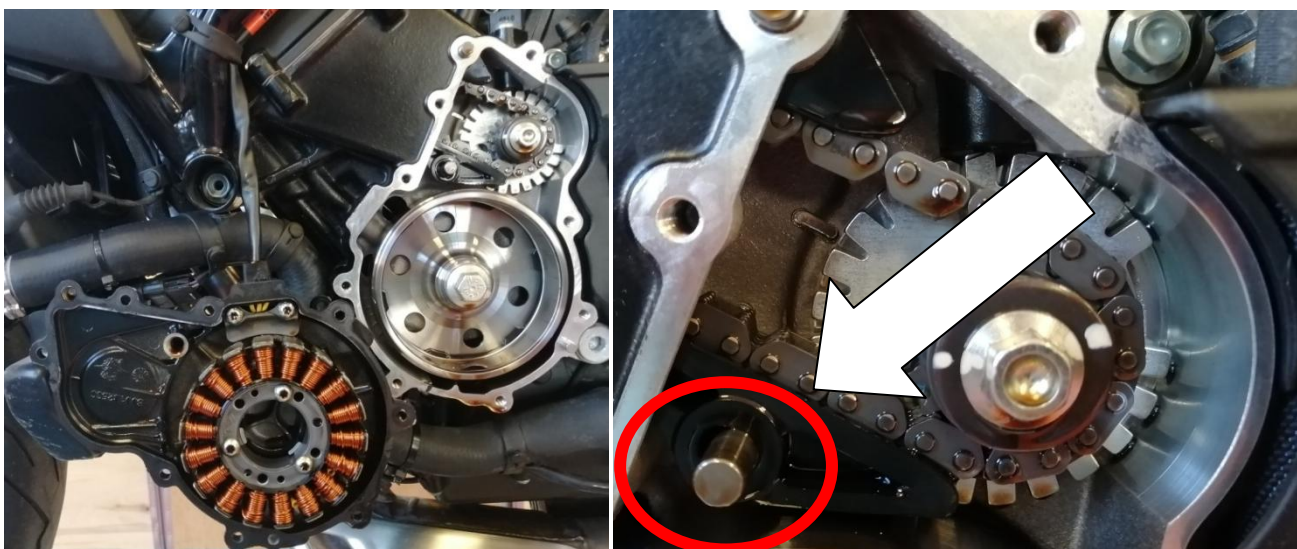

NOTE: The old generator cover gasket must NOT be reused.

3. Use a 15 mm hexagonal key on the flywheel fixing screw to block the rotation of the engine and use a 10 mm hexagonal key to remove the timing gear's fixing screw cod. **8A00B2683**

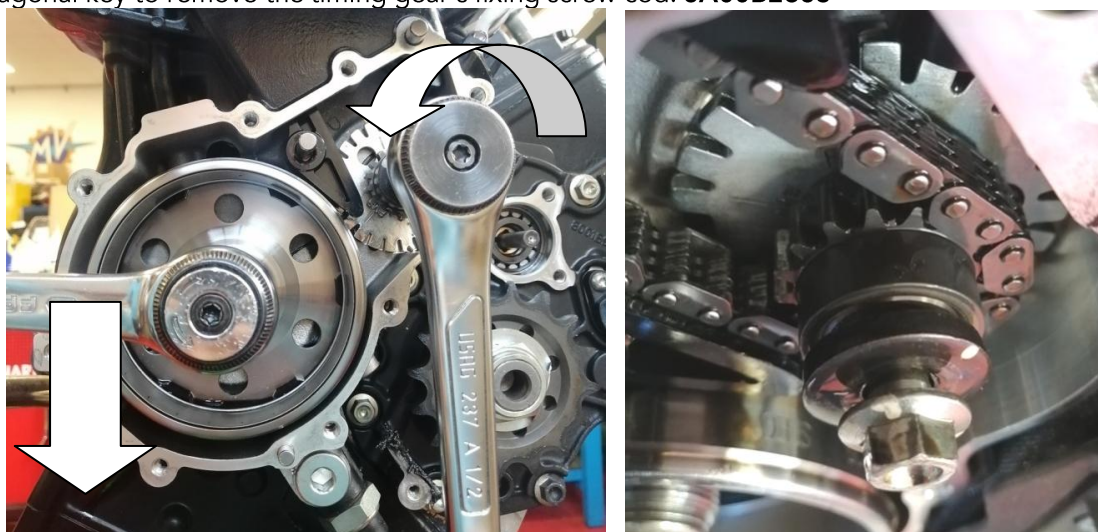

4. Remove washer code **8000B6497**; **NOTE: The old washer must NOT be reused.**

5. **Carefully** check the condition of the timing key, in particular that there is **no damage to it and no angular play on the phonic wheel**; if there is NO damage and/or play, proceed to the next point.

If any damage, play or abnormal movement is found on the phonic wheel, contact MV Agusta Technical Service.

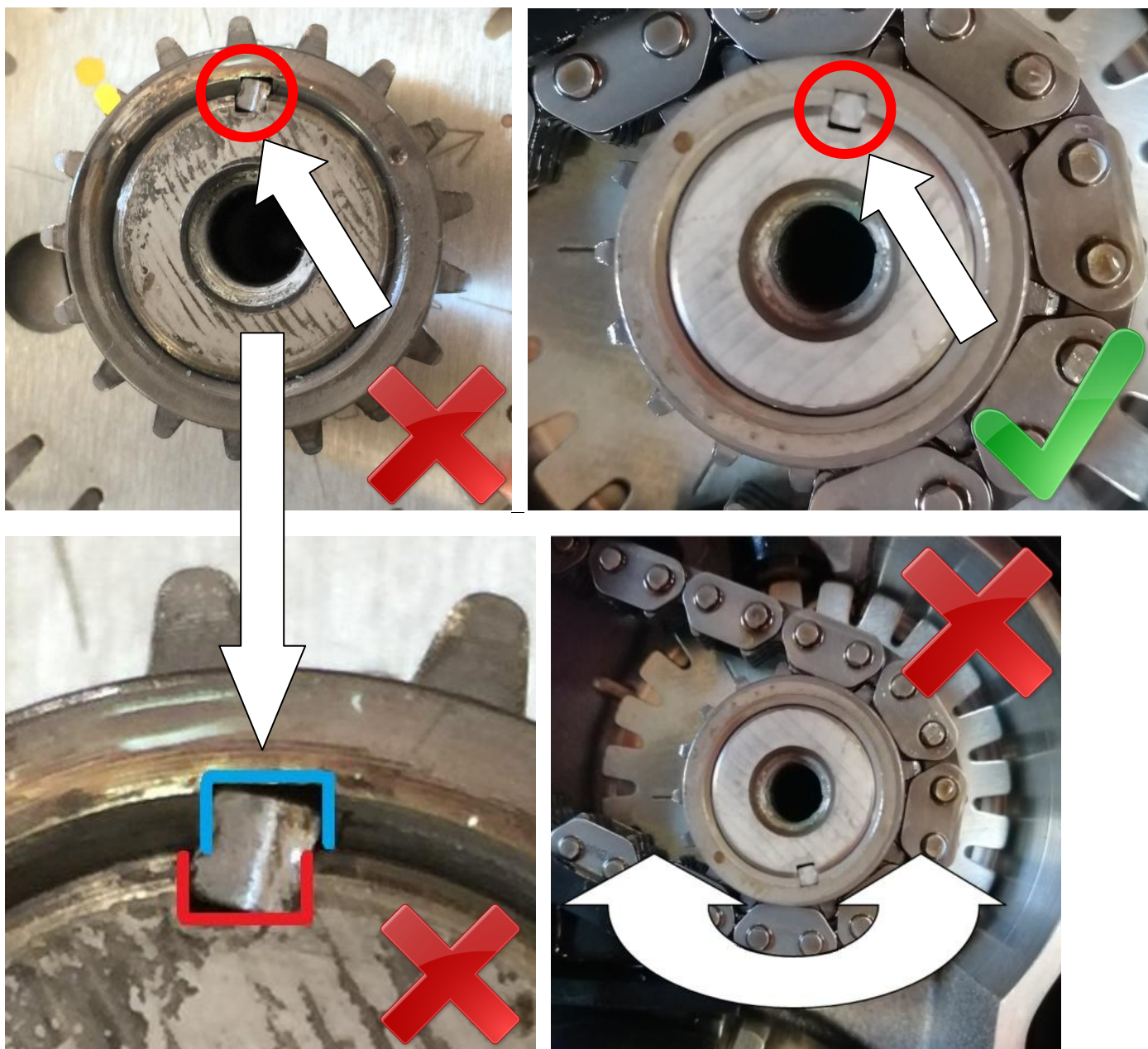

6. Take the new machined washer code **M625-0077** from kit code **W000W1486** :



7. Clean the threads of the distribution pinion fixing screw code **8A00B2683** from any residues of threadlocker.

8. Re-install the screw code **8A00B2683** using the new washer code **M625-0077** with the machined part facing engine side and applying strong threadlocker **Loctite® 270**, tighten at a torque of **25 Nm**.

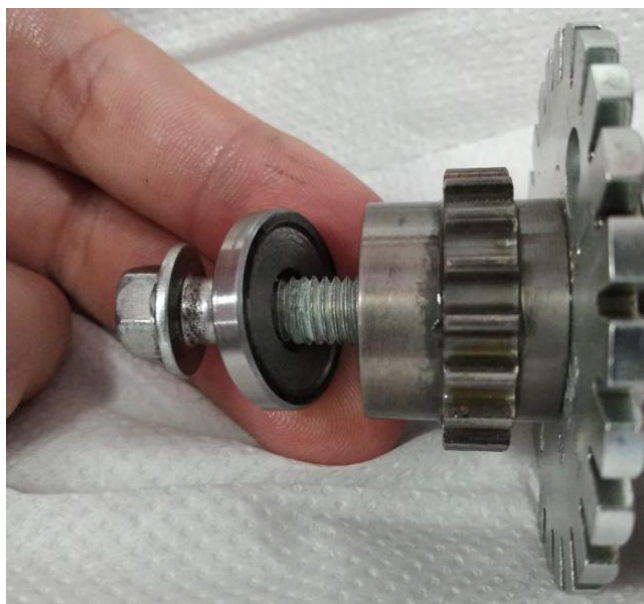
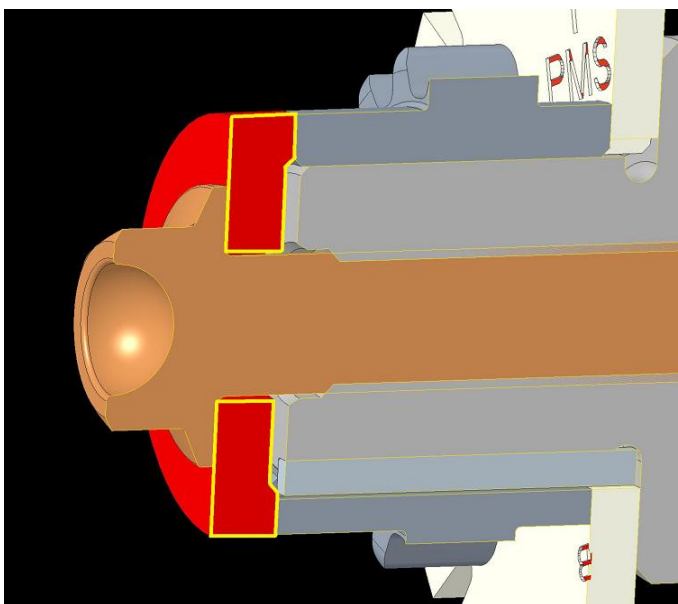

9. Carefully clean the surface where the generator cover is applied on the crankcase, removing any traces of sealant; then apply a light coat of **Threebond® 1207 B** liquid gasket:

- at the two junction cuts of the crankcase
- around the rubber gasket on the generator cover, at the generator cable outlet.

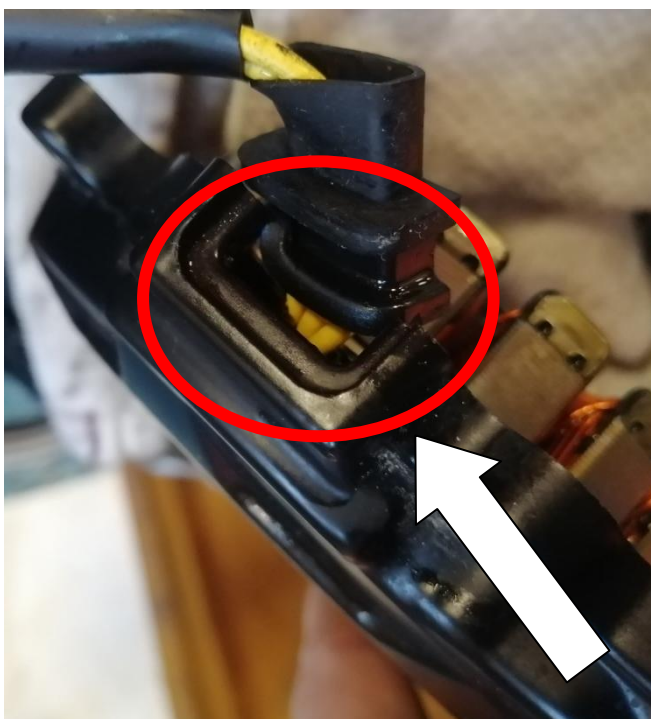
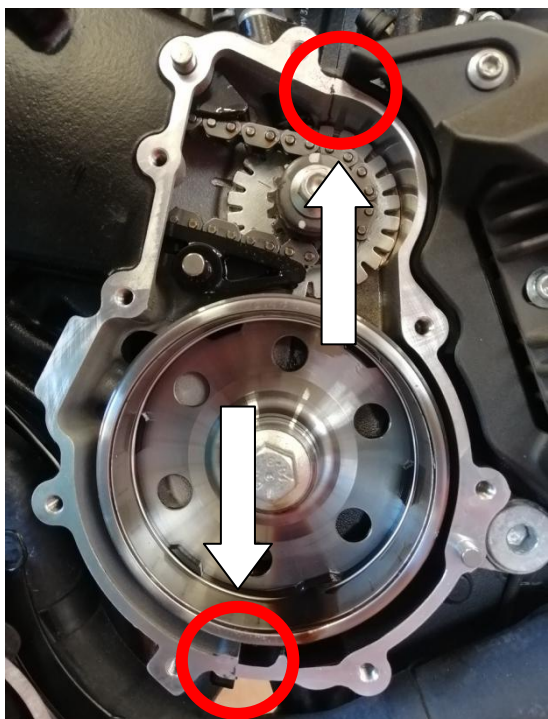

10. Take the new generator cover gasket code **8000B2617** supplied in the kit, apply it and refit the generator cover, tightening the screws to a torque of **10 Nm**.

11. Reposition any previously removed superstructures (refer to the related workshop manuals for model-specific procedures).

12. Check the oil level and start the engine by completing a fan cycle to check for oil leaks from disassembled parts.

Thanking you in advance for your cooperation, we remain at your disposal for any technical / commercial support.

Best regards,
MV AGUSTA MOTOR S.p.A.
Technical Assistance Service

VIN involved in the update:

ZCGNKGNU7MV001521	ZCGF110ABMV001382	ZCGB111BAMV005421	ZCGNKGNU6MV001509	ZCGB111BAMV005428
ZCGNKGNUXMV001500	ZCGF110ABMV001399	ZCGT310ABLV002812	ZCGB111BAMV005387	ZCGB111BAMV005427
ZCGNKGNU5MV001503	ZCGF110ABMV001384	ZCGB110BAMV005442	ZCGRHGNT5LV002933	ZCGB111BAMV005440
ZCGNKGNU1MV001501	ZCGF110ABMV001393	ZCGT310ABLV002811	ZCGB111BAMV005384	ZCG1F10AAMV001533
ZCGNKGNU5MV001517	ZCGF110ABMV001386	ZCGB111BAMV005398	ZCGB111BAMV005389	ZCGB111BAMV005432
ZCGNKGNU2MV001524	ZCGF110ABMV001381	ZCGT310ABLV002900	ZCGB111BAMV005386	ZCGB111BAMV005426
ZCGNKGNU0MV001523	ZCGF110ABMV001397	ZCGB111BAMV005424	ZCGT310ABLV002925	ZCGGKGLU3MV001527
ZCGNKGNU6MV001512	ZCGNKGNU7MV001504	ZCGB110BAMV005441	ZCGT310ABLV002931	ZCG1F10AAMV001534
ZCGNKGNU4MV001511	ZCGF110ACMV001408	ZCGT310ABLV002814	ZCGT310ABLV002929	ZCGB111BAMV005431
ZCGNKGNU6MV001493	ZCGF110ACMV001406	ZCGT310ABLV002902	ZCGB111BAMV005400	ZCGGKGLU3MV001530
ZCGNKGNU4MV001525	ZCGT310AALV002876	ZCGT310ABLV002901	ZCGB110BAMV005452	ZCGGKGLU5MV001528
ZCGPJGNU6MV005409	ZCGF110ACMV001409	ZCGT310ABLV002817	ZCGPJGNU4MV005392	ZCGB111BAMV005435
ZCGNKGNU8MV001494	ZCGNKGNU0MV001506	ZCGRHGNT5LV002818	ZCGB110BAMV005446	ZCGGKGLU7MV001529
ZCGNKGNU9MV001522	ZCGT310AALV002884	ZCGT310ABLV002815	ZCGB111BAMV005391	ZCGGKGLU5MV001531
ZCGNKGNU9MV001519	ZCGNKGNU3MV001404	ZCGRHGNT7LV002819	ZCGB111BAMV005394	ZCGB111BAMV005437
ZCGNKGNU3MV001502	ZCGRHGNTXLV002877	ZCGT310ABLV002816	ZCGB111BAMV005395	ZCG1F10AAMV001535
ZCGNKGNU1MV001496	ZCGRHGNT3LV002879	ZCGRHGNT0LV002824	ZCGB110BAMV005453	ZCGT310AAMV002936
ZCGNKGNUXMV001514	ZCGF110ACMV001407	ZCGT310ABLV002910	ZCGB110BAMV005449	ZCGT310AAMV002938
ZCGNKGNU4MV001492	ZCGNKGNU9MV001505	ZCGT310ABLV002923	ZCGB110BAMV005444	ZCGT310AAMV002940
ZCGNKGNU3MV001497	ZCGRHGNT1LV002878	ZCGT310ABLV002904	ZCGB110BAMV005448	ZCGT310AAMV002939
ZCGPJGNU4MV005411	ZCGRHGNT1LV002881	ZCGRHGNT2LV002825	ZCGB110BAMV005451	ZCGT310ABMV002984
ZCGNKGNU7MV001499	ZCGNKGNU4MV001508	ZCGT310ABLV002907	ZCGPJGNU3MV005397	ZCGT310ABMV002979
ZCGPJGNU3MV005416	ZCGNKGNU2MV001507	ZCGT310ABLV002920	ZCGB111BAMV005396	ZCGT310AAMV002945
ZCGNKGNU5MV001520	ZCGT310AALV002885	ZCGT310ABLV002912	ZCGPJGNU6MV005393	ZCGT310ABMV002980
ZCGPJGNU5MV005417	ZCGNKGNUXMV001402	ZCGT310ABLV002908	ZCGB110BAMV005447	ZCGT310AAMV002946
ZCGNKGNU5MV001498	ZCGNKGNU1MV001403	ZCGT310ABLV002911	ZCGB110BAMV005445	ZCGT310AAMV002947
ZCGNKGNU3MV001516	ZCGRHGNTXLV002880	ZCGT310ABLV002915	ZCGB110BAMV005450	ZCGT310ABMV002987
ZCGNKGNU6MV001526	ZCGT310AALV002883	ZCGT310ABLV002903	ZCGB111BAMV005404	ZCGT310AAMV002944
ZCGPJGNU2MV005410	ZCGRHGNT3LV002882	ZCGRHGNT0LV002919	ZCGB111BAMV005408	ZCGT310AAMV002937
ZCGNKGNU8MV001513	ZCGT310ABLV002810	ZCGT310ABLV002906	ZCGB111BAMV005415	ZCGT310ABMV002981
ZCGNKGNUXMV001495	ZCGT310ABLV002823	ZCGRHGNT9LV002918	ZCGB111BAMV005405	ZCGT310AAMV002942
ZCGNKGNU7MV001518	ZCGT310ABLV002899	ZCGT310ABLV002909	ZCGB111BAMV005406	ZCGT310ABMV002978
ZCGNKGNU1MV001515	ZCGT310AALV002892	ZCGT310ABLV002917	ZCGB111BAMV005419	ZCGT310ABMV002986
ZCGF110ABMV001394	ZCGT310ABLV002807	ZCGT310ABLV002914	ZCGB111BAMV005401	ZCGT310ABMV002982
ZCGF110ABMV001380	ZCGT310ABLV002898	ZCGT310ABLV002905	ZCGB111BAMV005407	ZCGT310AAMV002935
ZCGF110ABMV001391	ZCGT310ABLV002813	ZCGT310ABLV002913	ZCGB111BAMV005402	ZCGT310ABMV002988
ZCGF110ABMV001390	ZCGT310ABLV002921	ZCGT310ABLV002916	ZCGB111BAMV005414	ZCGT310AAMV002934
ZCGF110ABMV001389	ZCGB111BAMV005382	ZCGT310ABLV002922	ZCGB111BAMV005418	ZCGT310AAMV002941
ZCGF110ABMV001388	ZCGB110BAMV005454	ZCGT310ABLV002924	ZCGB111BAMV005403	ZCGT310ABMV002985
ZCGF110ABMV001387	ZCGB111BAMV005381	ZCGT310ABLV002926	ZCGB111BAMV005420	ZCGT310AAMV002948
ZCGF110ABMV001385	ZCGB111BAMV005423	ZCGB111BAMV005383	ZCGPJGNU6MV005412	ZCGT310ABMV002983
ZCGNKGNU8MV001401	ZCGB111BAMV005422	ZCGB111BAMV005385	ZCGB111BAMV005430	ZCGT310AAMV002943
ZCGF110ABMV001379	ZCGT310AALV002886	ZCGT310ABLV002930	ZCGB110BAMV005455	ZCGT310ABMV002977
ZCGF110ABMV001383	ZCGT310ABLV002809	ZCGT310ABLV002928	ZCGF120AAMV001532	ZCGT310ABMV002959
ZCGF110ABMV001395	ZCGB110BAMV005443	ZCGNKGNU2MV001510	ZCGB111BAMV005429	ZCGT310ABMV002956
ZCGF110ABMV001396	ZCGB111BAMV005425	ZCGT310ABLV002927	ZCGB111BAMV005436	ZCGT310ABMV002953
ZCGF110ABMV001398	ZCGT310ABLV002808	ZCGB111BAMV005388	ZCGB111BAMV005439	ZCGT310ABMV002974
ZCGF110ABMV001392	ZCGB111BAMV005413	ZCGB111BAMV005390	ZCGB111BAMV005434	ZCGT310ABMV002976
ZCGNKGNU6MV001400	ZCGB111BAMV005399	ZCGRHGNT3LV002932	ZCGB111BAMV005433	ZCGT310ABMV002969

ZCGT310ABMV002952	ZCGF110ACMV001549	ZCGF110ACMV001614	ZCGF110AAMV001679	ZCGB110AAMV005493
ZCGT310ABMV002990	ZCGF110ACMV001548	ZCGNKGNU0MV001604	ZCGGKGNU9MV001660	ZCG1B20AAMV005495
ZCGT310ABMV002975	ZCGF110ACMV001560	ZCGF120AAMV001626	ZCGF110AAMV001651	ZCGJGNT5MV005480
ZCGT310ABMV002957	ZCGF110ACMV001568	ZCGF110ACMV001618	ZCGF110AAMV001681	ZCGB110AAMV005486
ZCGT310ABMV002966	ZCGF110ACMV001562	ZCGF120AAMV001624	ZCGF110AAMV001683	ZCGB111AAMV005501
ZCGT310ABMV002989	ZCGB111BAMV005438	ZCGF110ACMV001613	ZCGGKGNU9MV001657	ZCGB111AAMV005499
ZCGT310ABMV002954	ZCGF110ACMV001570	ZCGF110ACMV001617	ZCGGKGNU7MV001690	ZCG1B20AAMV005490
ZCGT310ABMV002951	ZCGF110ACMV001577	ZCGF110ACMV001615	ZCGGKGNU0MV001689	ZCGB110AAMV005483
ZCGT310ABMV002958	ZCGF110ACMV001581	ZCGF110ACMV001616	ZCGGKGNU2MV001659	ZCG1B20AAMV005491
ZCGT310ABMV002971	ZCGF110ACMV001572	ZCGF120AAMV001622	ZCGF110AAMV001664	ZCGB110AAMV005485
ZCGT310ABMV002964	ZCGF110ACMV001575	ZCGF110ACMV001620	ZCGGKGNU4MV001694	ZCGB111AAMV005497
ZCGT310ABMV002949	ZCGF110ACMV001574	ZCGF110ACMV001610	ZCGGKGNU9MV001691	ZCG1B20AAMV005488
ZCGT310ABMV002950	ZCGF110ACMV001573	ZCGNKGNU9MV001603	ZCGGKGNU0MV001692	ZCGB110AAMV005484
ZCGT310ABMV002973	ZCGF110ACMV001576	ZCGF110AAMV001642	ZCGGKGNU3MV001721	ZCGB111AAMV005500
ZCGT310ABMV002955	ZCGF110ACMV001583	ZCG1F10AAMV001641	ZCGGKGNU2MV001693	ZCGJGNT7MV005481
ZCGT310ABMV002967	ZCGF110ACMV001582	ZCGF110AAMV001650	ZCGF110AAMV001696	ZCG1B20AAMV005492
ZCGT310ABMV002970	ZCGF110ACMV001585	ZCGF110AAMV001646	ZCGF110AAMV001695	ZCG1B20AAMV005489
ZCGT310ABMV002965	ZCGF110ACMV001580	ZCGGKGLU8MV001636	ZCGF110AAMV001697	ZCGB111AAMV005513
ZCGT310ABMV002972	ZCGF110ACMV001584	ZCG1F10AAMV001638	ZCGGKGNU2MV001662	ZCGB111AAMV005517
ZCGT310ABMV002968	ZCGF110ACMV001569	ZCGGKGLU2MV001633	ZCGF110AAMV001663	ZCGB111AAMV005525
ZCGF110ACMV001539	ZCGF110ACMV001571	ZCGGKGLU7MV001630	ZCGGKGNU0MV001661	ZCGB111AAMV005514
ZCGF110ACMV001538	ZCGF110ACMV001578	ZCGGKGLU4MV001634	ZCGB110AAMV005456	ZCGB111AAMV005518
ZCGF110ACMV001537	ZCGF110ACMV001579	ZCG1F10AAMV001639	ZCGB110AAMV005464	ZCGB111AAMV005522
ZCGF110ACMV001541	ZCGF110ACMV001586	ZCGGKGLU0MV001629	ZCGB110AAMV005457	ZCGB111AAMV005505
ZCGT310ABMV002961	ZCGF110ACMV001587	ZCGF110AAMV001643	ZCGB110AAMV005458	ZCGB111AAMV005511
ZCGF110ACMV001540	ZCGNKGNU8MV001589	ZCGGKGLU9MV001631	ZCGB110AAMV005459	ZCGB111AAMV005506
ZCGT310ABMV002963	ZCG1F10AAMV001536	ZCGF110AAMV001649	ZCGB110AAMV005472	ZCGB111AAMV005509
ZCGT310ABMV002962	ZCGF110ACMV001588	ZCG1F10AAMV001637	ZCGB110AAMV005461	ZCGB111AAMV005527
ZCGT310ABMV002991	ZCGNKGNU4MV001590	ZCGF110AAMV001644	ZCGB110AAMV005462	ZCGB111AAMV005521
ZCGT310ABMV002960	ZCGF110ACMV001592	ZCGGKGLU6MV001635	ZCGB110AAMV005470	ZCGB111AAMV005516
ZCGF110ACMV001556	ZCGF110ACMV001591	ZCGGKGLU7MV001627	ZCGB110AAMV005477	ZCGB111AAMV005523
ZCGF110ACMV001567	ZCGF110ACMV001606	ZCGF110AAMV001645	ZCGB110AAMV005478	ZCGB111AAMV005507
ZCGF110ACMV001557	ZCGF110ACMV001596	ZCGGKGLU0MV001632	ZCGB110AAMV005463	ZCGB111AAMV005520
ZCGF110ACMV001553	ZCGF110ACMV001598	ZCGF110AAMV001648	ZCGB110AAMV005465	ZCGB111AAMV005504
ZCGF110ACMV001565	ZCGF110ACMV001593	ZCGF110AAMV001647	ZCGB110AAMV005471	ZCGB111AAMV005510
ZCGF110ACMV001550	ZCGF110ACMV001595	ZCG1F10AAMV001640	ZCGB110AAMV005460	ZCGB111AAMV005512
ZCGF110ACMV001546	ZCGF110ACMV001607	ZCGGKGLU9MV001628	ZCGB110AAMV005474	ZCGB111AAMV005515
ZCGF110ACMV001564	ZCGF110ACMV001599	ZCGF110AAMV001685	ZCGB110AAMV005476	ZCGB111AAMV005508
ZCGF110ACMV001559	ZCGF110ACMV001597	ZCGGKGNU7MV001687	ZCGB110AAMV005467	ZCGB111AAMV005519
ZCGF110ACMV001543	ZCGF110ACMV001600	ZCGGKGNU1MV001653	ZCGB110AAMV005469	ZCGB111AAMV005524
ZCGF110ACMV001558	ZCGF110ACMV001594	ZCGGKGNU5MV001655	ZCGB110AAMV005468	ZCGB111AAMV005526
ZCGF110ACMV001545	ZCGF110ACMV001605	ZCGGKGNU7MV001656	ZCGB110AAMV005479	ZCGB111AAMV005561
ZCGF110ACMV001563	ZCGF110ACMV001611	ZCGF110AAMV001684	ZCGB110AAMV005473	ZCGB111AAMV005546
ZCGF110ACMV001561	ZCGF120AAMV001623	ZCGF110AAMV001652	ZCGB110AAMV005466	ZCGB111AAMV005530
ZCGF110ACMV001552	ZCGF120AAMV001625	ZCGF110AAMV001682	ZCGB110AAMV005475	ZCGB111AAMV005550
ZCGF110ACMV001551	ZCGF110ACMV001609	ZCGF110AAMV001677	ZCGB111AAMV005498	ZCGB111AAMV005535
ZCGF110ACMV001542	ZCGF110ACMV001619	ZCGGKGNU3MV001654	ZCG1B20AAMV005487	ZCGB111AAMV005548
ZCGF110ACMV001554	ZCGNKGNU7MV001602	ZCGGKGNU9MV001688	ZCGB111AAMV005503	ZCGB111AAMV005533
ZCGF110ACMV001547	ZCGF110ACMV001621	ZCGF110AAMV001678	ZCG1B20AAMV005494	ZCGB111AAMV005531
ZCGF110ACMV001544	ZCGF110ACMV001608	ZCGGKGNU0MV001658	ZCGB111AAMV005502	ZCGB111AAMV005540
ZCGF110ACMV001566	ZCGNKGNU5MV001601	ZCGF110AAMV001686	ZCGJGNT9MV005482	ZCGB111AAMV005538
ZCGF110ACMV001555	ZCGF110ACMV001612	ZCGF110AAMV001680	ZCGB111AAMV005496	ZCGB111AAMV005542

ZCGB111AAMV005541	ZCGB110BAMV005654	ZCGB111BAMV005627	ZCGF110ABMV001752	ZCGF110ABMV001762
ZCGB111AAMV005532	ZCGB111BAMV005635	ZCGB111BAMV005609	ZCGF110ABMV001734	ZCGF110ABMV001801
ZCGB111AAMV005543	ZCGB111BAMV005634	ZCGB111BAMV005608	ZCGF110ABMV001743	ZCGF110ABMV001790
ZCGB111AAMV005534	ZCGB110BAMV005652	ZCGB111BAMV005611	ZCGF110ABMV001747	ZCGF110ABMV001788
ZCGB111AAMV005536	ZCGB110BAMV005651	ZCGB111BAMV005613	ZCGF110ABMV001748	ZCGNKGNU9MV001780
ZCGB111AAMV005549	ZCGB110BAMV005663	ZCGB111BAMV005614	ZCGF110ABMV001750	ZCGF110ABMV001799
ZCGB111AAMV005528	ZCGB110BAMV005657	ZCGPJGNU6MV005619	ZCGF110ABMV001745	ZCGF110ABMV001792
ZCGB111AAMV005547	ZCGB110BAMV005655	ZCGB111BAMV005618	ZCGF110ABMV001746	ZCGNKGNU0MV001781
ZCGB111AAMV005539	ZCGB111BAMV005636	ZCGB111BAMV005607	ZCGF110ABMV001751	ZCGF110ABMV001793
ZCGB111AAMV005545	ZCGB111BAMV005638	ZCGPJGNU7MV005628	ZCGF110ABMV001736	ZCGF110ABMV001794
ZCGB111AAMV005544	ZCGB111BAMV005629	ZCGB110BAMV005661	ZCGF110ABMV001735	ZCGF110ABMV001797
ZCGB111AAMV005537	ZCGB111BAMV005630	ZCGB111BAMV005617	ZCGF110ABMV001738	ZCGF110ABMV001789
ZCGB111AAMV005529	ZCGB111BAMV005631	ZCGB111BAMV005626	ZCGF110ABMV001732	ZCGF110ABMV001796
ZCGB111AAMV005570	ZCGB110BAMV005659	ZCGJJGNU2MV005557	ZCGF110ABMV001737	ZCGNKGNU0MV001778
ZCGB111AAMV005567	ZCGB110BAMV005658	ZCGB111BAMV005616	ZCGF110ABMV001731	ZCGF110ABMV001784
ZCGB111AAMV005571	ZCGB111BAMV005640	ZCGB111BAMV005606	ZCGF110ABMV001733	ZCGF110ABMV001787
ZCGB111AAMV005573	ZCGB111BAMV005646	ZCGJJGNU4MV005558	ZCGF110ABMV001725	ZCGNKGNU2MV001782
ZCGB111AAMV005569	ZCGJJGNU0MV005556	ZCGJJGNU6MV005559	ZCGF110ABMV001739	ZCGF110ABMV001795
ZCGB111AAMV005562	ZCGB111BAMV005643	ZCGB111BAMV005605	ZCGF110ABMV001744	ZCGF110ABMV001791
ZCGB110BAMV005649	ZCGB111BAMV005599	ZCGB111BAMV005595	ZCGF110ABMV001742	ZCGNKGNU4MV001783
ZCGJJGNUXMV005581	ZCGB111BAMV005623	ZCGF110ABMV001723	ZCGJJGNU2MV005560	ZCGF110ABMV001800
ZCGJJGNU1MV005579	ZCGPJGNU2MV005648	ZCGF110ABMV001728	ZCGF110ABMV001753	ZCGNKGNU2MV001779
ZCGB111AAMV005566	ZCGB111BAMV005624	ZCGB111BAMV005586	ZCGF110ABMV001758	ZCGF110ABMV001785
ZCGB111AAMV005576	ZCGJJGNU7MV005554	ZCGB111BAMV005583	ZCGF110ABMV001759	ZCGF110ABMV001786
ZCGB111AAMV005564	ZCGB111BAMV005625	ZCGB111BAMV005588	ZCGNKGNU5MV001775	ZCGF110ABMV001798
ZCGB111AAMV005565	ZCGB111BAMV005621	ZCGB111BAMV005596	ZCGNKGNU8MV001768	ZCGF110ABMV001803
ZCGB111AAMV005574	ZCGB111BAMV005642	ZCGF110ABMV001724	ZCGF110ABMV001764	ZCGF110ABMV001805
ZCGJJGNU8MV005580	ZCGB111BAMV005603	ZCGB111BAMV005597	ZCGF110ABMV001756	ZCGF110ABMV001806
ZCGB111AAMV005575	ZCGB111BAMV005601	ZCGF110ABMV001726	ZCGF110ABMV001757	ZCGF110ABMV001808
ZCGB110BAMV005650	ZCGB111BAMV005600	ZCGF110ABMV001727	ZCGNKGNUXMV001772	ZCGNKGNU5MV001811
ZCGB111AAMV005577	ZCGB111BAMV005620	ZCGF110ABMV001722	ZCGNKGNU7MV001776	ZCGF110ABMV001810
ZCGB111AAMV005572	ZCGB111BAMV005644	ZCGB111BAMV005594	ZCGNKGNU6MV001770	ZCGF110ABMV001809
ZCGJJGNUXMV005578	ZCGB111BAMV005641	ZCGB111BAMV005593	ZCGF110ABMV001760	ZCGNKGNU7MV001812
ZCGJJGNU1MV005551	ZCGB111BAMV005602	ZCGB111BAMV005584	ZCGNKGNUXMV001769	ZCGF110ABMV001807
ZCGJJGNU3MV005552	ZCGB111BAMV005645	ZCGF110ABMV001729	ZCGNKGNU8MV001771	ZCGF110ABMV001802
ZCGJJGNU8MV005563	ZCGJJGNU9MV005555	ZCGB111BAMV005589	ZCGF110ABMV001767	ZCGF110ABMV001804
ZCGB111AAMV005568	ZCGB111BAMV005622	ZCGB111BAMV005587	ZCGNKGNU9MV001777	ZCGNKGNUXMV001819
ZCGB111BAMV005637	ZCGPJGNU0MV005647	ZCGF110ABMV001730	ZCGF110ABMV001766	ZCGNKGNU8MV001821
ZCGB110BAMV005656	ZCGB111BAMV005598	ZCGB111BAMV005592	ZCGF110ABMV001763	ZCGNKGNU6MV001820
ZCGB110BAMV005653	ZCGJJGNU5MV005553	ZCGB111BAMV005585	ZCGF110ABMV001755	ZCGNKGNU4MV001816
ZCGB110BAMV005662	ZCGB111BAMV005604	ZCGB111BAMV005591	ZCGF110ABMV001754	ZCGNKGNU6MV001817
ZCGB111BAMV005633	ZCGB111BAMV005582	ZCGB111BAMV005590	ZCGF110ABMV001765	ZCGNKGNU0MV001814
ZCGB110BAMV005660	ZCGB111BAMV005615	ZCGF110ABMV001740	ZCGNKGNU1MV001773	ZCGNKGNU2MV001815
ZCGB111BAMV005632	ZCGB111BAMV005612	ZCGF110ABMV001749	ZCGNKGNU3MV001774	ZCGNKGNU9MV001813
ZCGB111BAMV005639	ZCGB111BAMV005610	ZCGF110ABMV001741	ZCGF110ABMV001761	ZCGNKGNU8MV001818