

**PORSCHE Rear Seat Entertainment (AHY)**

Restriction: **ONLY** for vehicles with PORSCHE Rear Seat Entertainment equipment (9WU) produced starting 06-2021 (week-year).

Model Year: **As of 2021**

Information: **Retrofitting**



**Information**



*Figure 1*

Information: PORSCHE Rear Seat Entertainment (PRSE) is a high-resolution, anti-glare 10.1-inch touchscreen, (resolution: 1920 × 1080 pixels) including folding mounting arm.

The touchscreen is installed on the back of the backrest on the driver and/or passenger seat (⇒ *Figure 1*). The PORSCHE Rear Seat Entertainment system displays can be tilted.

System optimizations can be performed by updating "Over-the-air". To do this, see operating instructions.

Wireless PORSCHE Bluetooth® headphones, which are ideal for the PORSCHE Rear Seat Entertainment system, can also be ordered.

PORSCHE Rear Seat Entertainment is also available ex-works for new vehicles by requesting optional equipment "AHY – PORSCHE Rear Seat Entertainment (USA)".

Parts Info: **9Y0.088.812** ⇒ PORSCHE Rear Seat Entertainment, set

The following optional equipment can also be ordered:

**9Y0.088.630.A** 2 x ⇒ PORSCHE Bluetooth headphones

Parts List:



Figure 2

9Y0.919.617 <sup>1</sup>	2 x	PORSCHE Rear Seat Entertainment – "Bring Your Own Content BYOC" ⇒ <i>Figure 2-1-</i>
— — — <sup>1</sup>	1 x	Quick Start Guide (operating instructions) "PORSCHE Rear Seat Entertainment – "Bring Your Own Content BYOC" ⇒ <i>Figure 2-2-</i>
9Y0.088.630.A	2 x	PORSCHE Bluetooth headphones, incl. USB-C charging cable ⇒ <i>Figure 2-3-</i>
— — —	2 x	PORSCHE Bluetooth headphones Quick Reference Guide (not shown)

<sup>1</sup> Included ONLY in set 9Y0.088.812!

Technical details:

Using in the vehicle:

- Playback of smart device app content (e.g. films) on the PORSCHE Rear Seat Entertainment System via Apple® AirPlay, GOOGLE® Chromecast, screen synchronization (e.g. Samsung® Smart View or Apple® Screen synchronization)
- Playback of Netflix content via integrated browser
- Playback of content (e.g. films) via the HDMI-in interface (HDMI cable **NOT** included in scope of delivery!)
- Sound output via Bluetooth® headphones or jack plugs (3.5 mm)
- Charging electronic devices via USB type C™ interface
- Over-the-air updates for system optimizations

Technical requirements:

- Smart device with at least iOS® 12 or Android® 9.0 operating system
- WiFi connection between smart device and PORSCHE Rear Seat Entertainment System
- App compatibility with one of the functions specified above

Further information:

- Availability of services and functions may differ in certain countries
- An Internet/WiFi connection can be established as a hotspot (tethering) using the Connect Plus module or by using a Notebook/Tablet computer
- Not all functions are available via hotspot (tethering), depending on smartphone manufacturer
- Some apps restrict the wireless transfer of content
- Playback/transfer of content protected by Digital Rights Management (DRM) may sometimes require a subscription to a paid streaming service
- No playback of iTunes content



**Information**

- Please pass all this information on to the customer as well.
- Please pass the documents included in the scope of delivery to the customer.

Materials:

— — —	1 x	Cleaning cloth (commercially available)
— — —	1 x	Isopropanol (commercially available)

Tools:

Disassembly tool for radio (HAZET 4655-1)  
Hand lamp

Installing:

- 1 Installing new screen
  - 1.1 Connect battery charger. ⇒ *Workshop Manual '2X00IN Battery trickle charging'*.

**NOTICE****Display unit installed/removed/operated incorrectly**

- Risk of damage to the surface/leather on front seat or display unit
  - Risk of damage to the display unit screen
- ⇒ Do not use sharp-edged tools for installing/removing the display unit.
- ⇒ During installing/removal: Do not press the display.

1.2 Fold out the mounting arm on the back of the screen. ⇒ *Figure 3*

- 1 – Mounting arm
- 2 – Screen

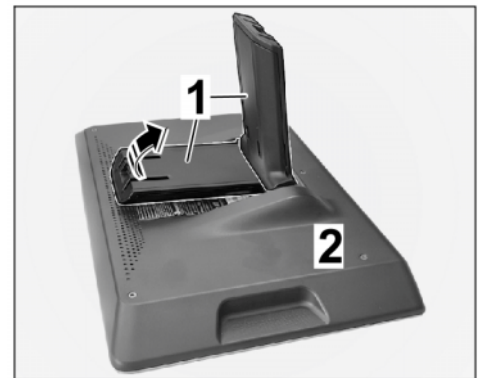
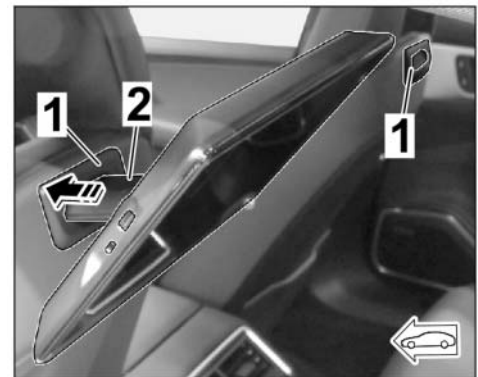

*Figure 3*

1.3 Align mounting arm with screen attached with the opening (back of front seat backrest) and carefully guide it into the opening. ⇒ *Figure 4*

- 1 – Opening (back of front seat backrest)
- 2 – Mounting arm for screen

1.4 Grasp the frame on both sides of the screen and push it forward carefully until you feel slight resistance. ⇒ *Figure 4 -Arrow-*



*Figure 4*

- 1.5 Insert braces (disassembly tool for radio HAZET 4655-1) into the clips on the screen mounting arm. ⇒ *Figure 5 -top-*
- 1 – Disassembly tool for radio HAZET 4655-1
  - 2 – Mounting arm clips
  - 3 – Screen
- 1.6 Pull the mounting arm and clamps (disassembly tool for radio HAZET 4655-1) to the rear of the screen. ⇒ *Figure 5 -arrow B-*  
At the same time, carefully press the screen and mounting arm forward (front-seat backrest) until you hear it lock into place. ⇒ *Figure 5 -arrow C-*
- 1.7 Check that the screen is seated firmly on the front seat backrest by carefully pulling and pressing it.

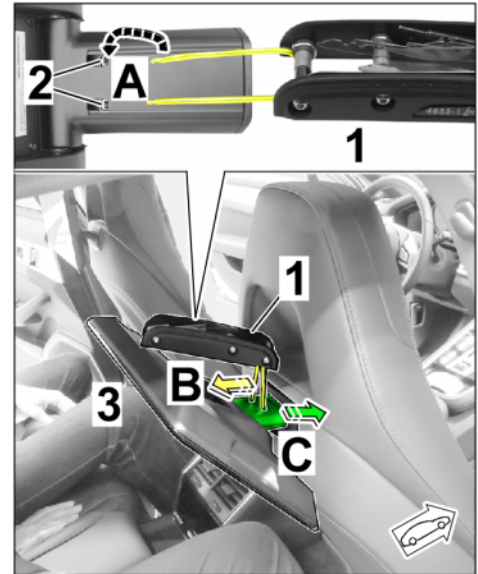

Figure 5

- Configuration: 2 Configuring new screen
- connections and On/Off button for PRSE ⇒ *Figure 6*
  - 1 – Touchscreen
  - 2 – On/Off button/Quick menu
  - 3 – Headphone connection
  - 4 – USB connection
  - 5 – HDMI connection

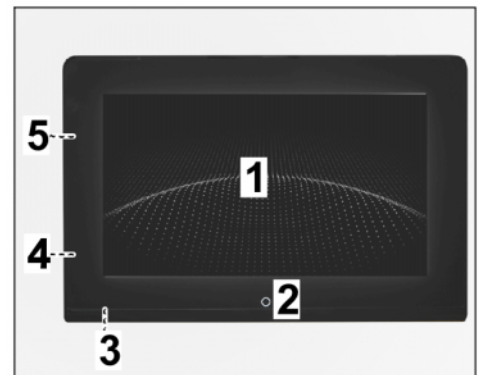
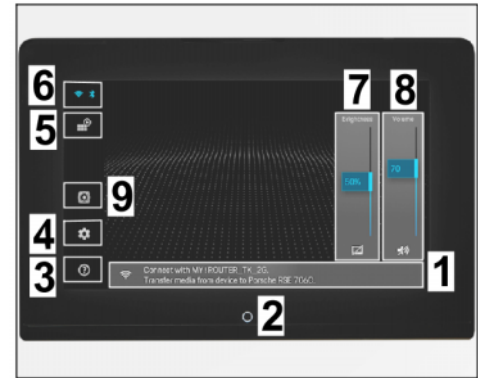

Figure 6

– Menu items and adjustment options for PRSE

⇒ *Figure 7*

- 1 – Status line/connection assistant
- 2 – On/Off button/Quick menu
- 3 – Help
- 4 – adjustments
- 5 – Source selection
- 6 – WiFi/Bluetooth – status/setting
- 7 – Brightness/display off
- 8 – Volume/mute
- 9 – Sound output (vehicle speakers)<sup>2</sup>



*Figure 7*

<sup>2</sup> ... Functions still hidden at present. These functions may be available with a later software update.

#### 2.1 Switching on the new screen

2.1.1 Press the On button at the bottom of the screen for approx. 2 seconds. ⇒ *Figure 6 -2-*

2.1.2 The system boots up.



#### Information

When you switch on the display for the first time, the default language is preset to "English".

#### 2.2 Setting the system language

2.2.1 Select Settings ⇒ "Language" menu item. ⇒ *Figure 8*

- 1 – adjustments
- 2 – "Settings" menu
- 3 – Language

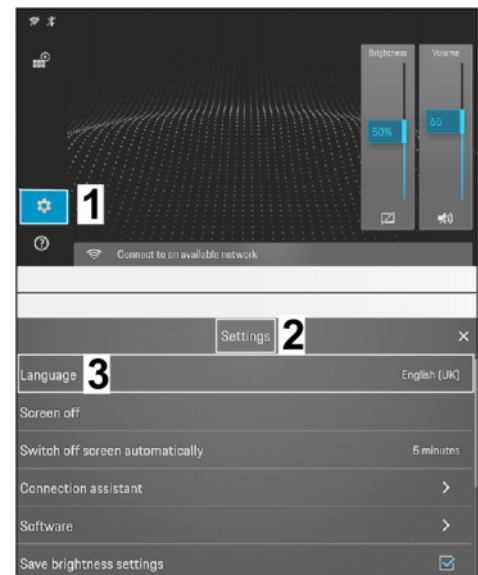

*Figure 8*

2.2.2 Select the desired system language from the list of available languages. ⇒ *Figure 9*

- 1 - "Language" menu
- 2 - Scroll bar
- 3 - Visible range of available languages

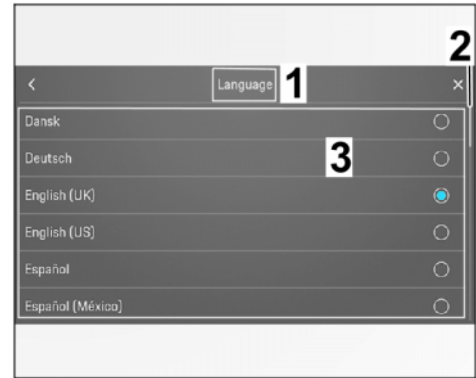

Figure 9

2.2.3 New language is adopted.  
The display switches back to the "Settings" menu item.



**Information**

Have access data required for the network ready.

2.3 Configuring WiFi network

2.3.1 Select WiFi/Bluetooth connection. ⇒ *Figure 10-2-*

- 1 - Status line
- 2 - WiFi/Bluetooth connection
- 3 - "Connection" menu
- 4 - "WiFi" menu item
- 5 - Search for available networks
- 6 - Available networks

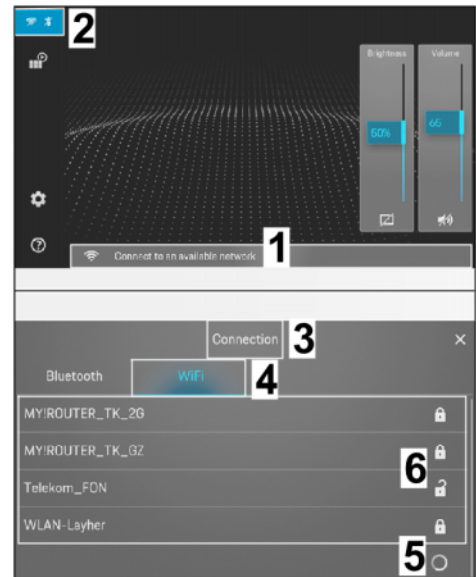

Figure 10

2.3.2 Select the "WiFi" menu item in the "connection" menu. ⇒ *Figure 10 -4-*

2.3.3 Start the search for available networks. ⇒ *Figure 10-bottom-*

2.3.4 Select the desired network, enter a password and confirm with "OK". ⇒ *Figure 11 -top-*

- 1 – Name of selected network
- 2 – Input form
- 3 – WiFi icon – status "Connected"
- 4 – Status line

2.3.5 When a connection to a WiFi network is displayed:

- WiFi icon at the left edge of the screen has a colored background ⇒ *Figure 11-3-*
- Network name is displayed in the status line ⇒ *Figure 11-4-*

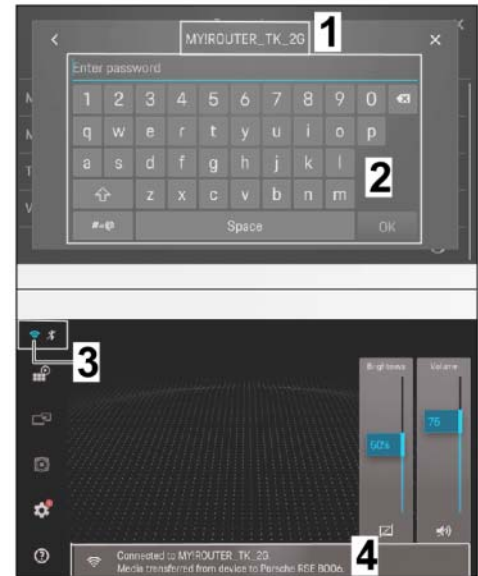

Figure 11

Software: 3 Checking software version and updating if necessary

3.1 Displaying software/device information

3.1.1 Select Settings ⇒ "Software" menu item. ⇒ *Figure 12*

- 1 – adjustments
- 2 – "Settings" menu
- 3 – Software

If new software is available, it will be displayed with a red circle next to the "Software" menu item.



Figure 12



3.1.2 Select the "Software information" menu item. ⇒ *Figure 13-2-*

- 1 – "Software" menu
- 2 – Software information
- 3 – Software/device information

3.1.3 The following software/device information is displayed: ⇒ *Figure 13-3-*

- Software version
- Rear Seat Entertainment version
- MCU version ⇒ Micro Controller Unit Version
- Assigned location ⇒ installed position in the vehicle (left or right-hand seat) ⇒ for the "Sound via vehicle speakers" function
- Bluetooth Name
- Memory used ⇒ current: 100% maximum
- Run time ⇒ Starts as soon as the Rear Seat Entertainment system is live (e.g. unlocking the vehicle). Reset: Voltage for Rear Seat Entertainment to "Zero" (Check vehicle systems run-on time!)
- IP address
- Serial number of device

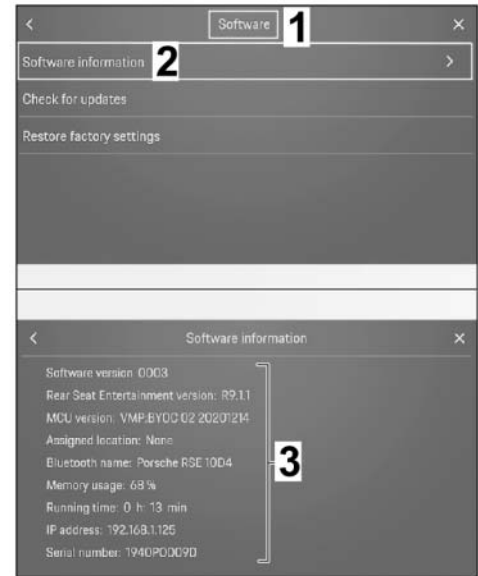

Figure 13

3.2 Check to see if a new software version is available on the server.

3.2.1 Select Settings ⇒ "Software" menu item. ⇒ *Figure 14*

- 1 – adjustments
- 2 – "Settings" menu
- 3 – Software

If new software is available, it will be displayed with a red circle next to the "Software" menu item. ⇒ *Figure 14-3-*



*Figure 14*

3.2.2 Select the "Check for Updates" menu item. ⇒ *Figure 15.*

- 1 – "Software" menu
- 2 – Searching for updates
- 3 – There are no updates available.

- No update available: Continue with Step 4. ⇒ *Figure 15-3-*
- Update available. Continue with the next step.

3.3 Updating software online



#### Information

It can take a few minutes to download, depending on the speed of the WiFi connection!



*Figure 15*

### 3.3.1 Downloading software update

Software update ⇒ "Do you want to download the file now?" ⇒ Confirm (OK)/Reject (Downloading). ⇒

*Figure 16 -top-*

- 1 – "Software Update" menu
  - 2 – Confirm (OK)
  - 3 – Cancel (Undo)
  - 4 – Cancelling the download
  - 5 – Display of download progress as a percentage
- OK.: Download starts automatically in the new window. ⇒ *Figure 16 -bottom-*
  - Cancel (Undo): Switch to the previous menu. Perform download software update later.

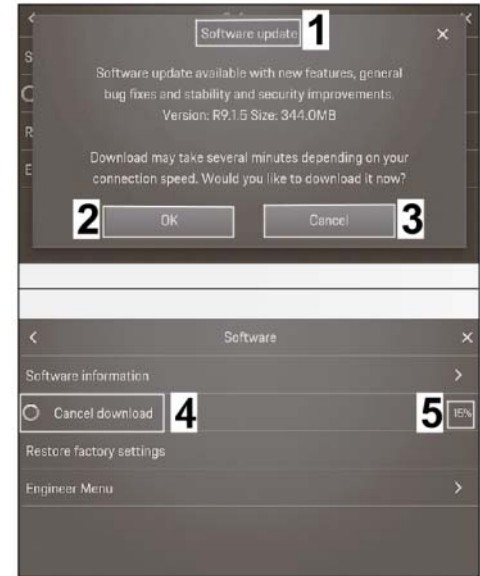

*Figure 16*

#### NOTICE

##### Voltage drop

- Coding/saving process is aborted
  - The display unit malfunctions
- ⇒ Make sure that the power supply is not interrupted when coding/saving data.
- ⇒ Connect a battery charger with a current rating of at least Nominal value 40 A to the vehicle battery.

## 3.3.2 Installing software update

Software ⇒ Install update ⇒  
Question "Do you want to install  
now" ⇒ Confirm (OK)/Cancel (Later)

- 1 – "Software" menu
- 2 – Installing update
- 3 – OK (confirm)
- 4 – Later (cancel)

Check whether a battery charger is  
connected.

**Information**

The system is not functional while  
you are updating the system!

- **YES:** Confirm installation with  
'OK'.
- **NO:** Connect battery charger.  
⇒ *Workshop Manual '2X00IN Battery trickle charging'*.



Figure 17

## 3.3.3 The following information is displayed when carrying out the update:

- "The system will start when installation is complete!"
- Following update: "System starting, please wait..." "
- Information following update: "Installation successful. Software updated." and confirm the content of the update with "OK".

Headphones: 4 **ONLY** if PORSCHE Bluetooth headphones are present:  
Connect headphones to PRSE (coupling; see also ⇒ Quick Reference guide for PORSCHE Bluetooth headphones)

## 4.1 Activating "Bluetooth" connection mode on PORSCHE Bluetooth headphones

**Information**

When you switch on the headphones for the first time, they automatically start in  
connection mode.

4.1.1 Press and hold the On button (⇒ *Figure 18-3-*) on the PORSCHE Bluetooth headphones for longer than 3 seconds. The signal for "Switched on" can be heard in the headphones.

- L** – Left side
- R** – Right side
- 1** – Charging headphones (Type C – socket)
- 2** – LED light: Red = Charging, Red/Blue alternating = connection mode
- 3** – Button: On/Off/Playback/Break
- 4** – Rocker switch: Fast forward / rewind and volume control

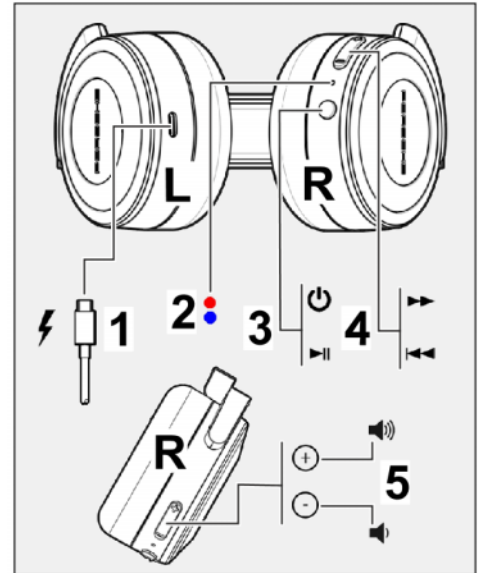

Figure 18

4.1.2 Press (⇒ *Figure 18-3-*) longer than 5 seconds to start connection mode. LED light flashes alternately "red/blue". ⇒ *Figure 18*

4.2 Deactivate Bluetooth on the PRSE

4.2.1 Select "WiFi/Bluetooth" connection. ⇒ *Figure 19-2-*

- 1** – Status line
- 2** – Settings for "WiFi / Bluetooth"
- 3** – "Connection" menu
- 4** – "Bluetooth" menu item

4.2.2 Select "Bluetooth" in the menu. ⇒ *Figure 19-4-*

4.3 Connecting PORSCHE Bluetooth headphones to PRSE

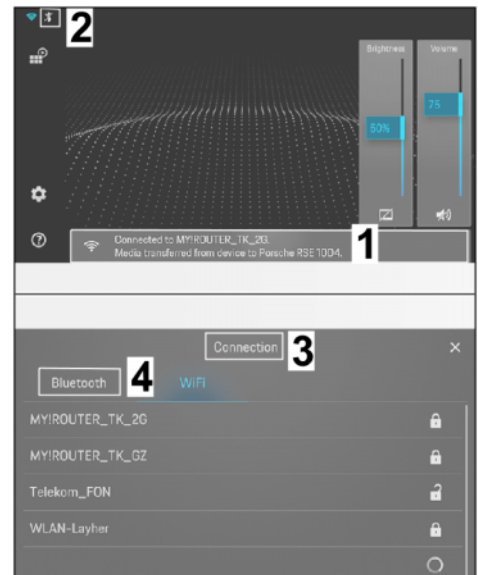

Figure 19

4.3.1 Confirm the question/Information with "OK". Switch off the display again beforehand by ticking it if necessary. ⇒ *Figure 20-top-*

- 1 – Information on "connection mode"
- 2 – Display information selection
- 3 – Device search



Figure 20

4.3.2 Select the relevant headphones from the list of available headphones. ⇒ *Figure 21 -2-*

- 1 – "Connection" menu
- 2 – List of available headphones
- 3 – Headphones – status: Connected

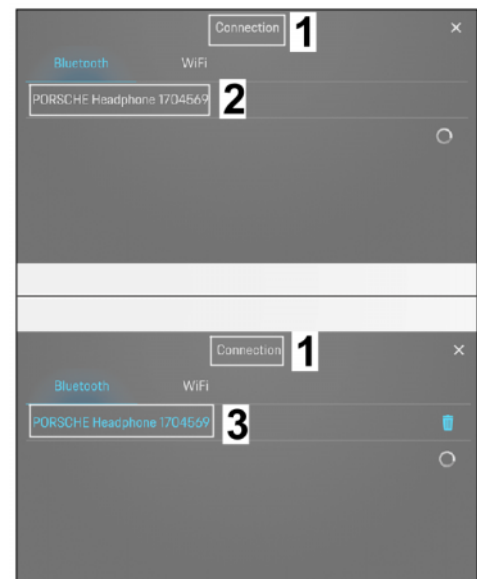
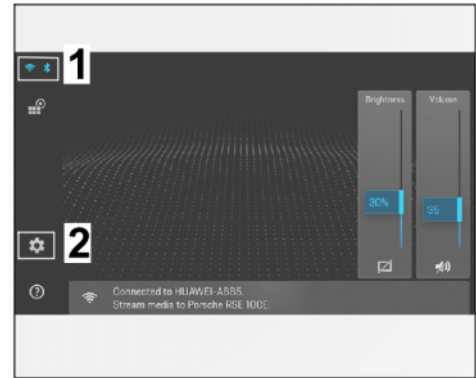

Figure 21

4.3.3 When connected successfully:  
Change font color to "blue". ⇒  
*Figure 21 -bottom-*

- 1 – WiFi/Bluetooth connection  
– status: active
- 2 – adjustments

The "Bluetooth" icon is also displayed in blue in the Start screen.  
⇒ *Figure 22*



*Figure 22*

Configuration: 5 Change screen color display

Change the color in the displays to "Red style" in accordance with the color in the instrument cluster.

5.1 Select Settings ⇒ "Software" menu item.  
⇒ *Figure 23*

- 1 – adjustments
- 2 – "Settings" menu
- 3 – Software

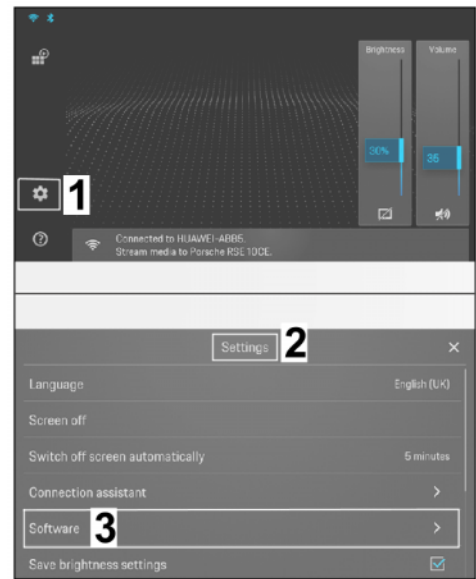

*Figure 23*

- 5.2 Press the "Software Information" menu until another "Engineer Menu" line is displayed at the bottom. ⇒ *Figure 24*

- 1 – "Software" menu
- 2 – Software information
- 3 – Engineer Menu



Figure 24

- 5.3 Select the "Engineer Menu" ⇒ scroll down until "Red style" is displayed. ⇒ *Figure 25 -top-*

- 1 – "Engineer Menu" menu
- 2 – Red style
- 3 – Start screen in "Red style"

- 5.4 Tick the "Red style" menu item. The colors on the screen change from "blue" to "red". ⇒ *Figure 25 -bottom-*

## 6 Concluding work

- 6.1 Switch off both screens.
- 6.2 Disconnect the battery charger. ⇒ *Workshop Manual '2X00IN Battery trickle charging'.*
- 6.3 Place documents supplied in the glove box in the vehicle.

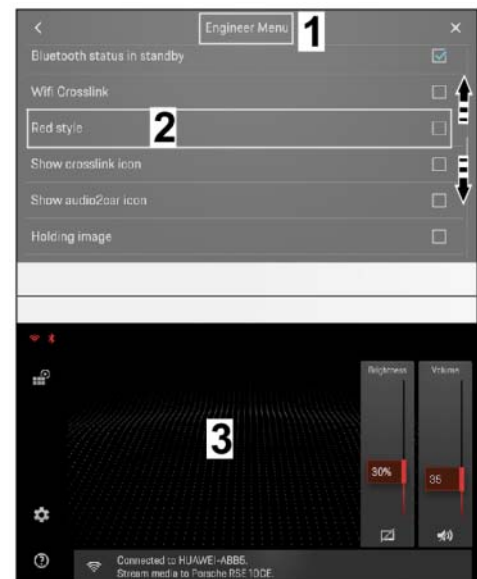

Figure 25



91 94 24 42: –Porsche Rear Seat Entertainment (2 screens) installed–  
Includes: Installing the display units on the seats and configuring new display units.

Labor time: **49 TU**

**Important Notice:** Technical Bulletins issued by Porsche Cars North America, Inc. are intended only for use by professional automotive technicians who have attended Porsche service training courses. They are written to inform those technicians of conditions that may occur on some Porsche vehicles, or to provide information that could assist in the proper servicing of a vehicle. Porsche special tools may be necessary in order to perform certain operations identified in these bulletins. Use of tools and procedures other than those Porsche recommends in these bulletins may be detrimental to the safe operation of your vehicle, and may endanger the people working on it. Properly trained Porsche technicians have the equipment, tools, safety instructions, and know-how to do the job properly and safely. Part numbers listed in these bulletins are for reference only. The work procedures updated electronically in the Porsche PIWIS diagnostic and testing device take precedence and, in the event of a discrepancy, the work procedures in the PIWIS Tester are the ones that must be followed.

© 2021 Porsche Cars North America, Inc.