



SIB 64 06 13

2021-11-01

## A/C COOLING: INTERMITTENT REDUCTION OF AIR FLOW

This Service Information Bulletin (Revision 11) supersedes SI B64 06 13 **dated December 2020**.

**What's New:**

- Model F87 added

**MODEL**

|                      |                            |                             |                             |
|----------------------|----------------------------|-----------------------------|-----------------------------|
| F22 (2 Series Coupe) | F23 (2 Series Convertible) | F30 (3 Series Sedan)        | F31 (3 Series Sports Wagon) |
| F32 (4 Series Coupe) | F33 (4 Series Convertible) | F34 (3 Series Gran Turismo) | F36 (4 Series Gran Coupe)   |
| F80 (M3 Sedan)       | F82 (M4 Coupe)             | F83 (M4 Convertible)        | F87 (M2 Coupe).             |

Produced from July 5, 2012 thru the respective end of production.

**SITUATION**

Customer may complain of reduced air flow when the air conditioning system is operated for an extended time, usually longer than 30 minutes.

**CAUSE**

The evaporator starts to freeze up. This can have multiple causes:

- The vehicle is being driven with windows and/or sunroof open in high humidity
- System is set to fresh air instead of recirculating mode in high humidity
- Due to the position of the evaporator temperature sensor in earlier vehicles

**CORRECTION**

Advise the customer on some climate control system settings to reduce this from occurring by reducing the introduction of humid outside air:

- Once a comfortable interior temperature has been reached, close the windows and sunroof when driving for long periods of time in high humidity with the air conditioning system on
- If driving with the "Max AC" mode active, we recommend that the climate control system be set to the recirculation mode
- Instrument panel center vents' stratified air temperature set between middle and max cold (blue)

Additionally, these steps can be performed:

1. Install a new evaporator temperature sensor adapter (to reposition the sensor) **for vehicles produced prior to September 30, 2013**

2. Perform a conversion to raise the minimum evaporator temperature ("Activate conversion to raise the minimum evaporator temperature") using ISTA/P **for vehicles produced from October 1, 2013**. This will add TEMP into the vehicle order (VO).

In the rare case that the evaporator continues to experience freezing after the above countermeasures have been performed (e.g., in very high humidity areas), modify the evaporator temperature sensor input by:

3. Installing an 800-ohm (1/4 watt) resistor in-line between the evaporator temperature sensor and the IHKA control panel (**all production dates**).

**NOTE:** This will 'move' the entire temperature operating range of the system up a few degrees. **Advise the customer that by making this modification, the air conditioning system will no longer achieve the same maximum low temperature out of the vents as seen prior to this installation.**

## PROCEDURE

### 1. Repair procedure for vehicles produced to September 30, 2013:

Use Repair Instructions REP 64 11 943



1. Remove the passenger's side footwell cover trim (the bottom instrument panel trim).

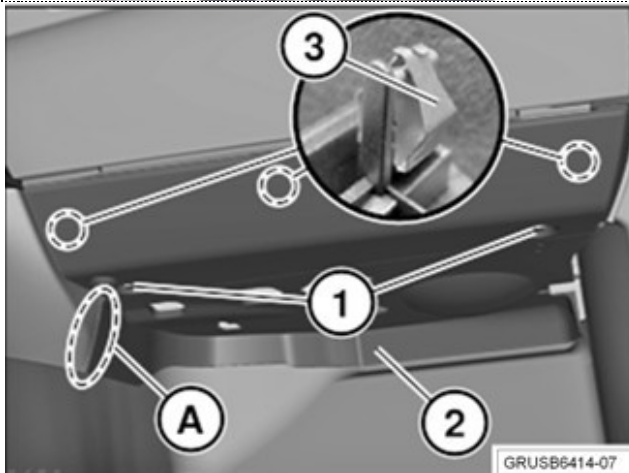

2. Remove both screws at connection (1).

**Note:** With the knee airbag, also remove both nuts (1).

Tightening torque is 5 Nm.

Release the trim panel (2) at clamps (3).

Feed out the trim panel (2) in area (A) toward the bottom.

Lower the trim panel (2) slightly and disconnect the plug connections behind it.

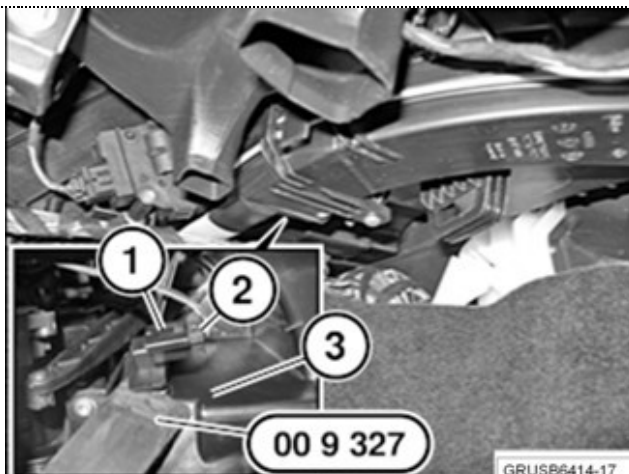

3. Disconnect the plug connection (2). Unclip the evaporator temperature sensor (1) with special tool 00 9 327 from the heating and air conditioning unit (3) and remove.

Installation note:

Ensure the evaporator temperature sensor (2) is correctly seated.

4. The IHKA housing (removed for clarity)

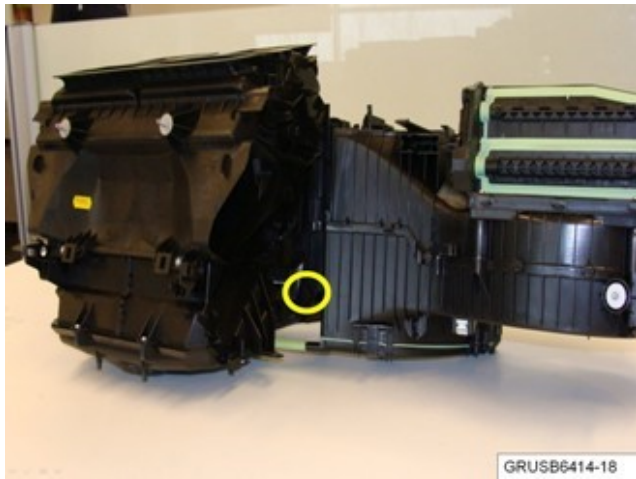

shown is viewed from the passenger's side.

The circle shows the approximate location of the evaporator temperature sensor.

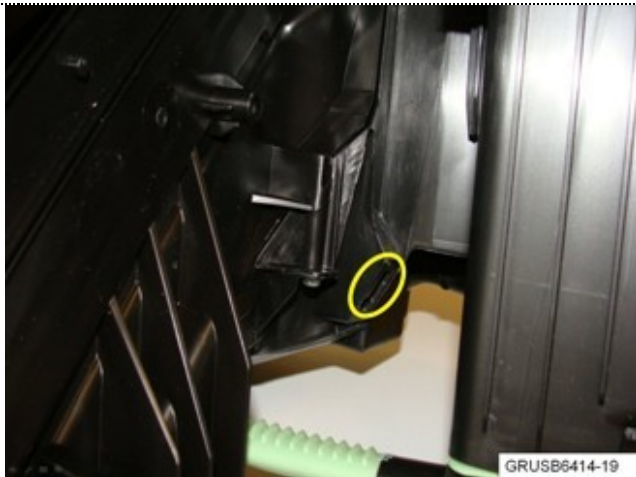

5. The close-up picture shows the exact location (circle) of the sensor opening. The following steps will be performed from the lower passenger's footwell area at the bottom of the IHKA housing.

**Note:** As a reference point, the evaporator temperature sensor is located just above the white ribbed rubber water drain hose, when viewed from below.

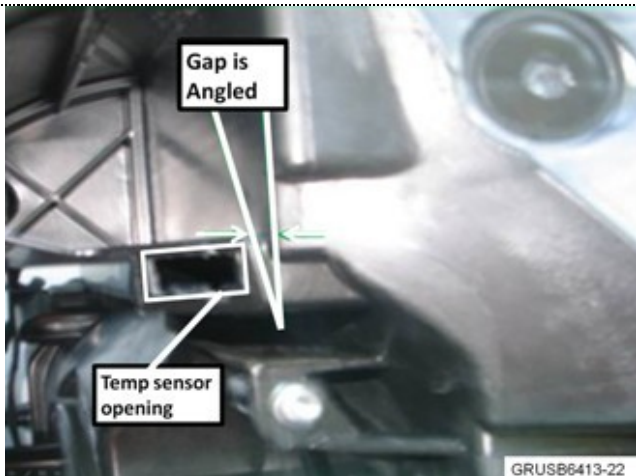

6. Locate the evaporator temperature sensor opening (sensor removed for clarity).

Check the gap between the sensor opening and the evaporator case.

If the sensor opening contact surface is slightly angled as shown, this housing is **NOT** affected by this repair procedure. In this case, proceed with normal A/C diagnostic procedures.

If no gap exists proceed to the next step.

7. Check for a marking on the electrical connector.

If a mark is seen or **NO** gap exists, the IHKA housing must be modified.

**Do not replace any parts. The repair procedure includes installing a new adapter to correct the gap.**

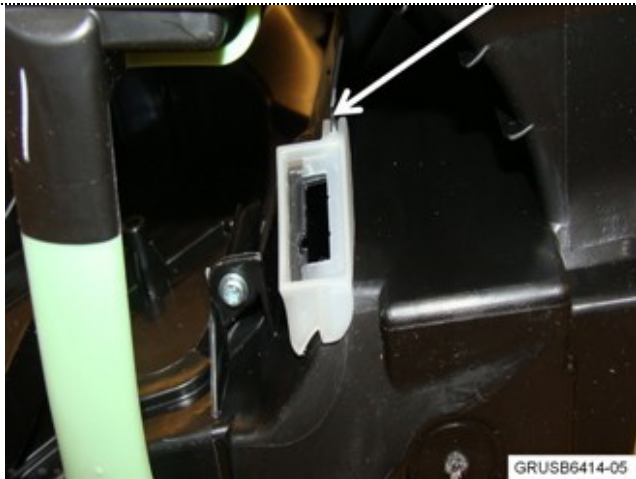
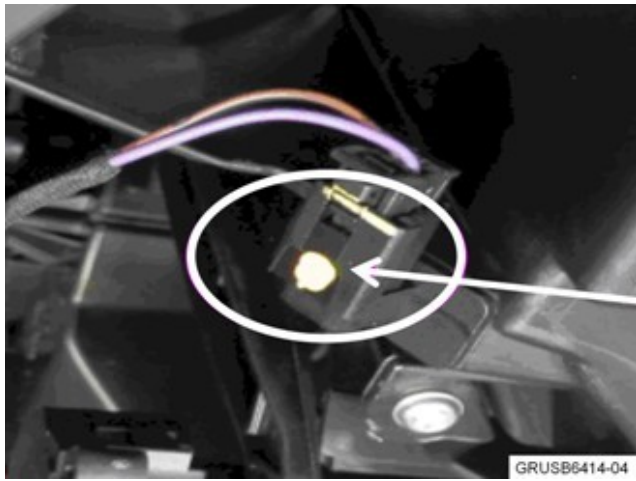

8. Insert the new adapter firmly into the sensor opening, as shown.

**Note:** The arrow shows the slot in the adapter that is properly fitted into the raised rib of the housing.

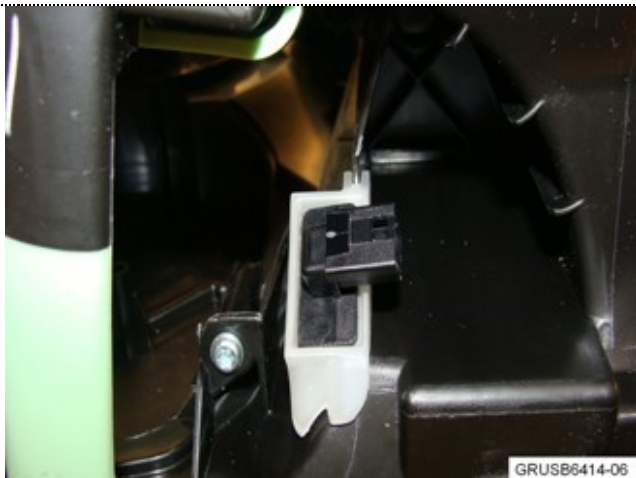

9. Insert the temperature sensor through the opening in the adapter and push in firmly.

**Note:** The temperature sensor is keyed and will only fit one way.

**Installation note:**

Ensure the evaporator temperature sensor is correctly seated.

Install all removed parts in the reverse order of their removal.

**2. Repair procedure for vehicles produced from October 1, 2013:**

Perform a conversion in ISTA/P "Activate conversion to raise the minimum evaporator temperature".

**3. Additional repair procedure (all production dates):**



In the rare case, in very high humidity areas, that the evaporator continues to experience freezing after the above countermeasures have been performed, modify the evaporator temperature sensor input by installing an 800-ohm (1/4 watt) resistor in-line between the evaporator temperature sensor and the IHKA control panel.

The resistor must be obtained locally and is not available via BMW parts.

A single resistor or two resistors in series that total between 750-850 ohms is acceptable.



Removal of the glove box and knee airbag makes access to the wiring harness easier for installation of the resistor.

REP 51 16 366 Removing and installing right glove box with housing

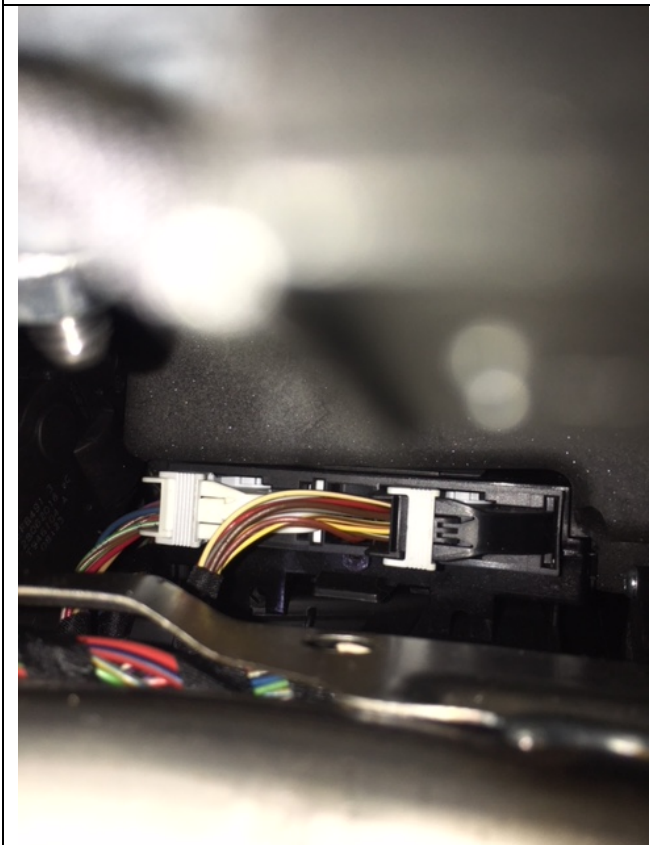

Remove the IHKA panel to access the harness ELO style electrical connectors.

REP 61 31 321 Removing and installing radio and A/C control panel

Unplug IHKA control panel connector x4711.

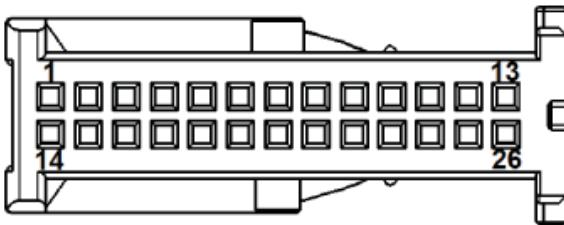
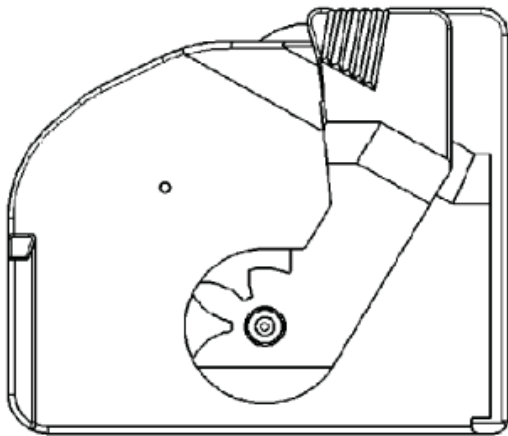

Remove the outer plastic housing from the internal wire holder to identify the wire you will be modifying.

On this example vehicle (F30) the wire (pin 22) is violet colored.

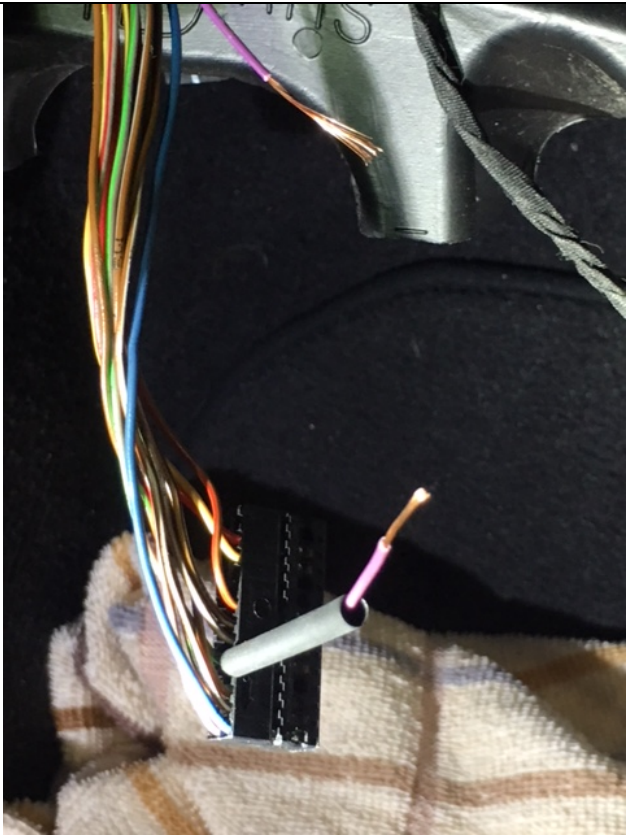
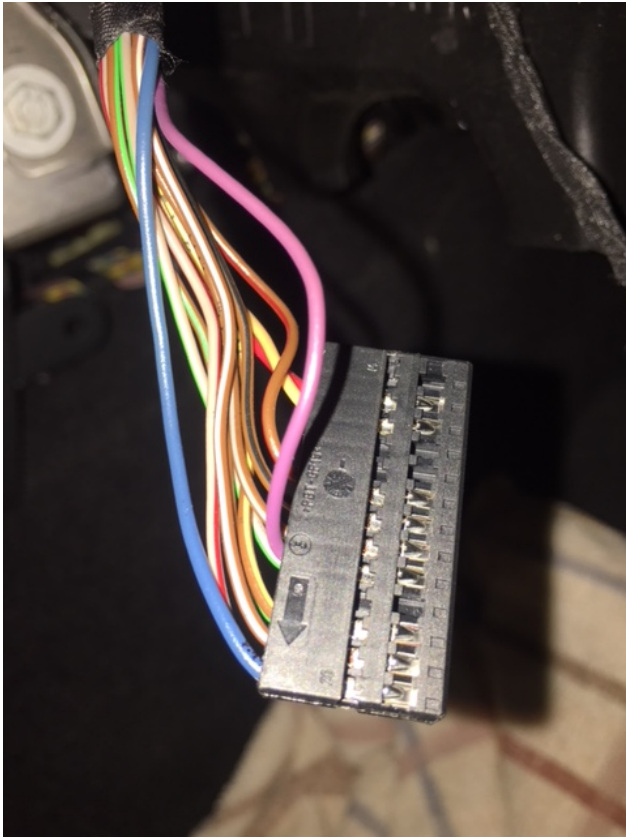

Reference wiring diagrams to identify evaporator Temperature sensor (B4) wire.

The evaporator temperature sensor signal wire goes to pin 22 at IHKA control panel connector x4711.

For this F30 the wiring can be found in schematic Temperature Control SP0000058999.

Install resistor inline on pin 22 for the evaporator temperature sensor line at the IHKA.

Make sure to place the heat shrink tubing over the wire before you install the resistor.

The resistor can either be soldered or crimped onto the wire.

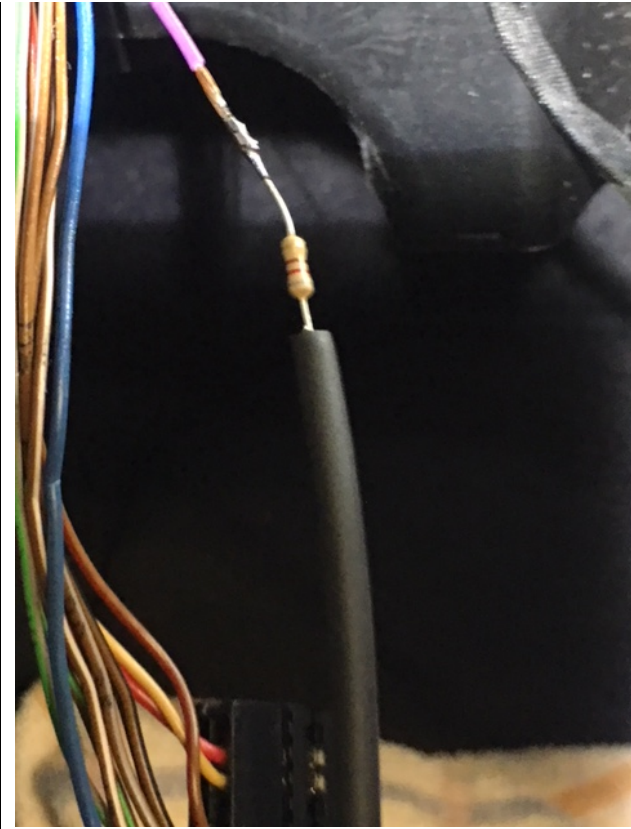

The resistor should be installed within heat shrink wrap.

The resistor must be attached to the harness either with plastic wire-ties or electrical tape.

After reassembly, clear the fault memory.





**PARTS INFORMATION**

Obtain and confirm the part numbers for your specific vehicle by entering the chassis number in either ETK or AIR which takes into account specific equipment and/or options.

| Part Number     | Description                           | Quantity |
|-----------------|---------------------------------------|----------|
| 64 11 9 350 495 | Evaporator temperature sensor adapter | 1        |

**WARRANTY INFORMATION**

Covered under the terms of the BMW New Vehicle Limited Warranty for Passenger Cars and Light Trucks.

**Install a new evaporator temperature sensor adapter for vehicles produced prior to September 30, 2013 (I)**

|                        |   |  |
|------------------------|---|--|
| <b>Defect Code:</b>    | <b>6411794000</b>   | <b>Evaporator temperature sensor, front poorly adjusted / outside of tolerance</b> |
| :                      |   |  |
| <b>Labor Operation</b> | <b>Description</b>  | <b>Labor Allowance</b>   |
| 64 99 000              | Work time to check IHKA housing and install the evaporator temperature sensor adapter (Main work)                                   | 4 FRU  |
| Or:                    |   |  |
| 64 99 000              | Work time to check IHKA housing and install the evaporator temperature sensor adapter (Plus work - vehicle already in the workshop) | 2 FRU  |

Only one Main work flat rate labor operation code can be claimed per workshop visit.

Or, to:

**Perform a conversion to raise the minimum evaporator temperature for vehicles produced on or after October 1, 2013 (II)**

During this workshop visit, the affected vehicle may also show one or more programming and encoding Technical Campaign repairs open, the programming and encoding procedure may only be invoiced one time.

**Select one of these open Technical Campaigns to perform and submit for updating the vehicle to the required I-level or higher.**

**Please be sure to also perform any additional work (before and/or after) as required by the open campaign(s) on the vehicle. Close any other remaining open programming and encoding Campaign repairs as outlined in the corresponding Service Information Bulletin.**

Only if the above situation does not apply, the BMW conversion solution is then:

Covered under the terms of the BMW New Vehicle Limited Warranty for Passenger Cars and Light Trucks or the BMW Certified Pre-Owned Program as described below.

| <b>Defect Code:</b>    | <b>6400315900</b>   | <b>Cooling mode too low / small</b> |
|------------------------|---|-------------------------------------|
| :                      |   |                                     |
| <b>Labor Operation</b> | <b>Description</b>  | <b>Labor Allowance</b>              |
| 00 00 006              | Performing vehicle test (with vehicle diagnosis system – checking faults) (Main work)         | Refer to AIR                        |
| Or:                    |   |                                     |
| 00 00 556              | Performing vehicle test (with vehicle diagnosis system – checking faults) (Plus work)         | Refer to AIR                        |
| And:                   |   |                                     |
| 61 21 528              | Support voltage of the vehicle electrical system / recharge vehicle electrical system battery | Refer to AIR                        |
| And:                   |   |                                     |
| 61 00 730              | Programming/encoding control unit(s)  | Refer to AIR                        |

If you are using a Main labor code for another repair, use the Plus code labor operation 00 00 556 instead of 00 00 006.

And, additionally for the:

**e-Vehicles**

| <b>Labor Operation</b> | <b>Description</b>   | <b>Labor Allowance</b> |
|------------------------|--|------------------------|
| 61 25 910              | Recharging high-voltage battery unit (to high voltage charging socket) | Refer to AIR           |

And, only if necessary:

**Install resistor (800-ohm 1/4 watt) in the evaporator temperature sensor line, all production dates (III)**

Covered under the terms of the BMW New Vehicle Limited Warranty for Passenger Cars and Light Trucks.

|                        |  |  |
|------------------------|--|--|
| <b>Defect Code:</b>    | <b>6411794000</b>  | <b>Evaporator temperature sensor, front poorly adjusted / outside of tolerance</b> |
| :                      |  |  |
| <b>Labor Operation</b> | <b>Description</b>   | <b>Labor Allowance</b>   |
| 51 16 366              | Remove and install the right-hand glove compartment with housing (Main work)   | Refer to AIR   |
| Or:                    |  |  |
| 51 16 866              | Remove and install the right-hand glove compartment with housing (Plus work - vehicle already in the workshop)             | Refer to AIR   |
| And:                   |  |  |
| 61 31 821              | Removing and installing radio and A/C control panel  | Refer to AIR   |
| And:                   |  |  |
| 61 99 000              | Job/repair work time to retrofit/install resistor inline the wiring for the evaporator temperature sensor line at the IHKA | 4 FRU  |

If you are using a Main labor code for another repair, use the Plus code labor operation 51 16 866 instead of 51 16 366.

Refer to AIR for the corresponding flat rate unit (FRU) allowances.

Work time labor operation code 61 99 000 is not considered a Main labor operation

For the above and for any addition work that is performed, as applicable to your center, please refer to **SI B01 01 20 or B01 07 20** for claiming your diagnosis work time, job/repair work time (WT), RO/Claim WT and/or repair explanation procedures.

**Programming and Encoding Vehicle Control Units (II) (RO and Claim Comments Required)**

The programming procedure automatically reprograms and encodes all vehicle control modules which do not have the latest software I-level. If one or more control module failures occur during this programming procedure:

Please claim this consequential control module-related repair work (including performing the IRAP Control Unit Recovery procedure first as required, refer to the SIB in AIR) under the defect code listed in this bulletin with the applicable AIR labor operations.

Please explain this additional work (The why and what) on the repair order and in the claim comments section.

For control module failures that occurred prior to performing this programming procedure:

When covered under an applicable limited warranty, claim the applicable test plan and the corresponding control module-related repair work using the applicable defect code and labor operations in AIR (including diagnosis).

**QUESTIONS REGARDING THIS BULLETIN**

|                     |  |
|---------------------|--|
| Technical inquiries | Submit feedback at the top of this bulletin  |
| Warranty inquiries  | Submit an IDS ticket to the Warranty Department or use the chat available in the Warranty Documentation Portal |
|                     |  |

Parts inquiries

Submit an IDS ticket to the Parts Department