	<b>GROUP</b> <b>Emissions Service Campaign</b>	<b>MODEL</b> <b>2016-2018MY Sorento (UMa) w/2.0L T-GDI</b>
	<b>NUMBER</b> <b>SC201 (Rev 1, 06/04/2021)</b>	<b>DATE</b> <b>April 2021</b>
<b>VOLUNTARY EMISSIONS SERVICE CAMPAIGN</b>		
<b>2.0L T-GDI AUXILIARY CANISTER KIT INSTALLATION (SC201)</b>		

**\* NOTICE**

This bulletin has been revised to include additional information. New/revised sections of this bulletin are indicated by a black bar in the margin area.

This bulletin provides the procedure for the installation of an add-on auxiliary canister on some 2016-2018MY Sorento (UMa) vehicles equipped with the 2.0L T-GDI engine, produced from October 29, 2014 through November 29, 2017. This is to improve evaporative system and ensure compliance with Federal and California emission regulation standards. Before conducting the procedure, verify that the vehicle is included in the list of affected VINs.



**\* NOTICE**

To assure complete customer satisfaction, always remember to refer to WebDCS Warranty Coverage (validation) Inquiry Screen (Service → Warranty Coverage → Warranty Coverage Inquiry) for a list of any additional campaigns that may need to be performed on the vehicle before returning it to the customer.

Printed TSB copy is for reference only; information may be updated at any time. Always refer to KGIS for the latest information.

- Circulate To:   
 General Manager   
 Service Manager   
 Parts Manager  
 Service Advisors   
 Technicians   
 Body Shop Manager   
 Fleet Repair

**Installation Procedure:**

1a. Raise vehicle on hoist.

1b. Remove the left rear bottom body cover (A).

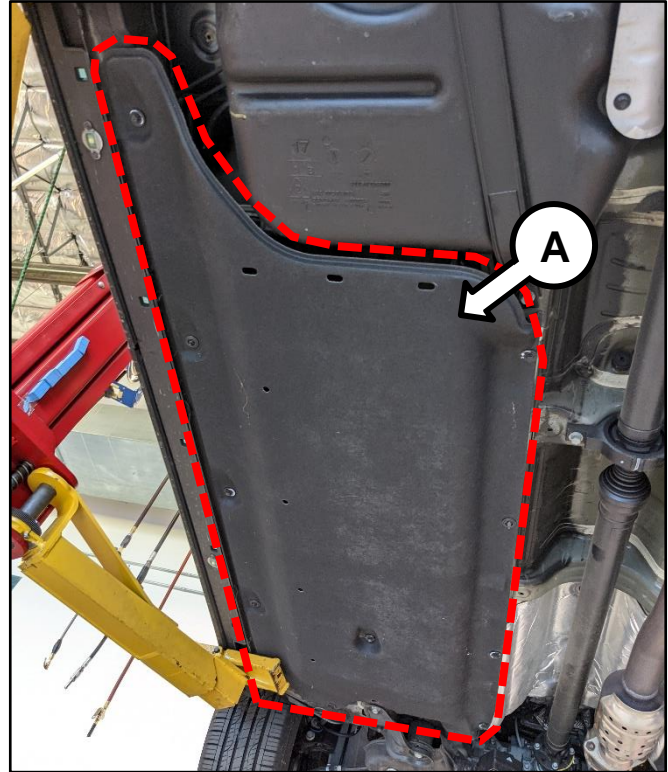

2a. Disconnect the two (2) vapor tube quick-connector and ventilation tube quick-connectors (B).

2b. Remove the three (3) canister (C) retaining bolts (D).

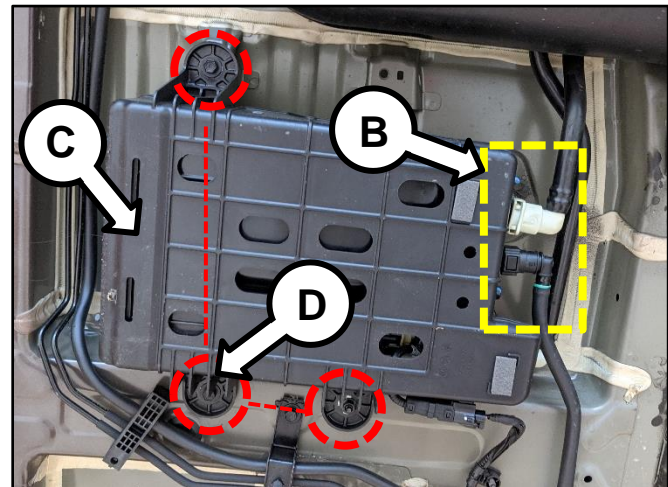

2d. Remove the canister (C) from the vehicle and place on a work bench.

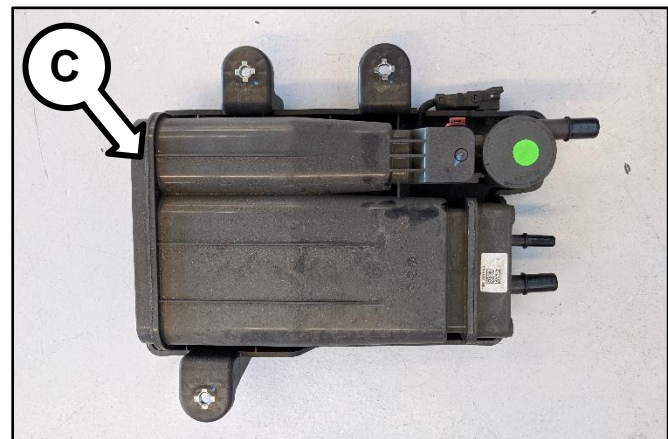

SUBJECT:

## 2.0L T-GDI AUXILIARY CANISTER KIT INSTALLATION (SC201)

3. Disconnect the air filter wire connector (E) from the canister.

Note: Image shown is for reference use only.

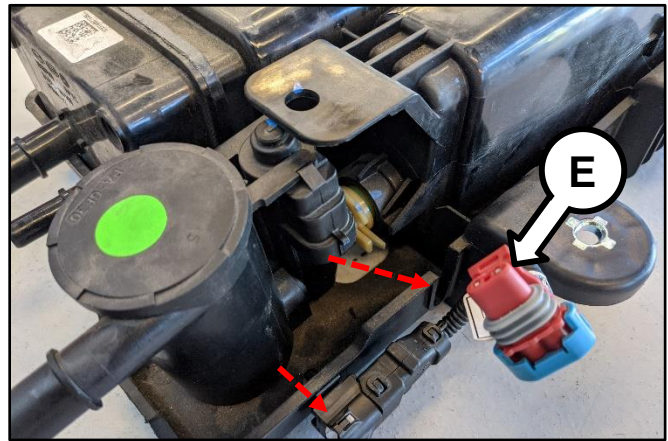

Note: Carefully push out the retaining clip (F) to release the wire connector harness from the canister.

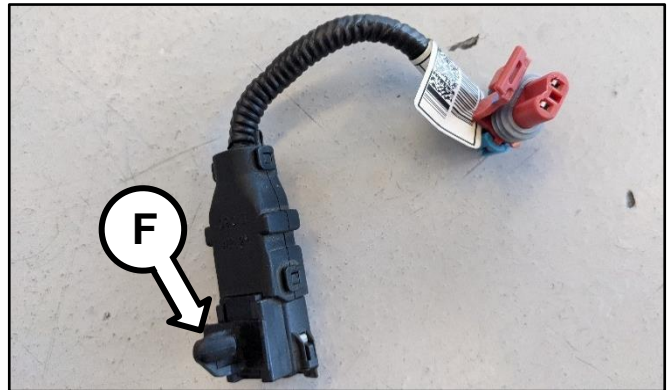

4. Turn the air filter (G) 45 degrees clockwise and pull away to remove it from the canister.

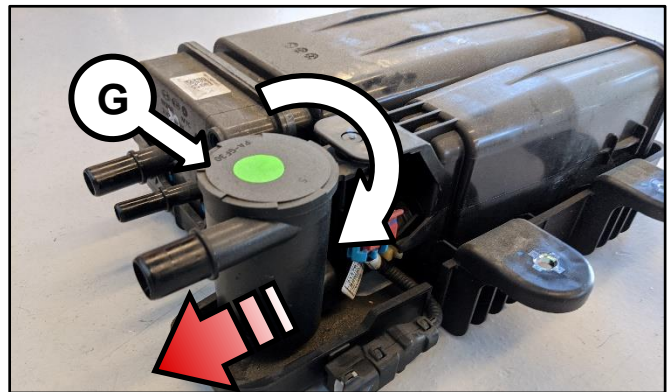



- 5a. Install the new additional auxiliary canister (H) to the main canister in the same reverse order of removal.

**\* NOTICE**

Ensure the correct **black** O-ring is installed on the auxiliary canister before installing to canister.

- Kit P/N 31410 B8999QQK: **Replace** green O-ring with black O-ring supplied in kit.
- Kit P/N 31410 B8990QQK: Black O-ring is already installed on canister.

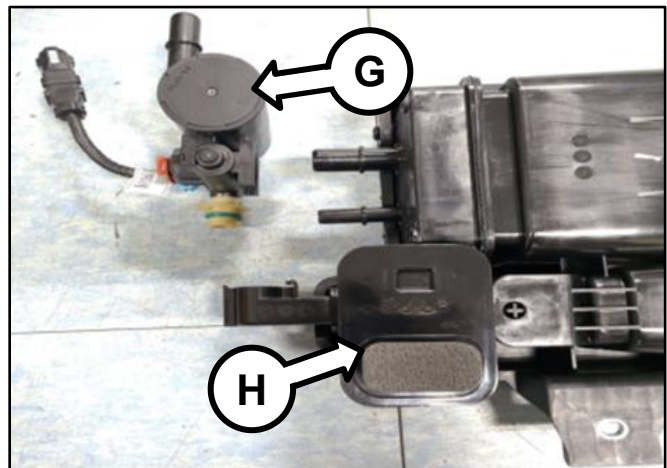
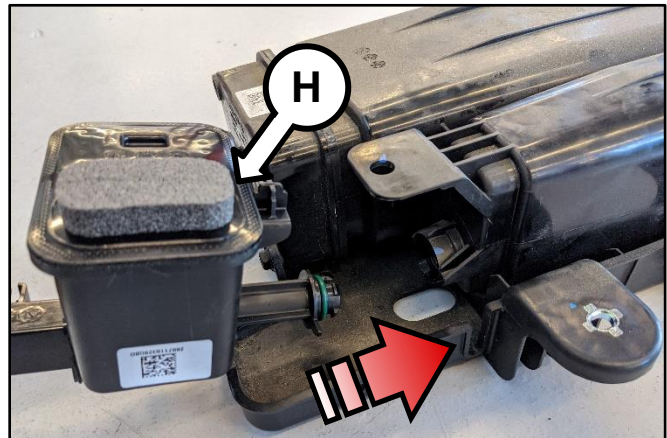
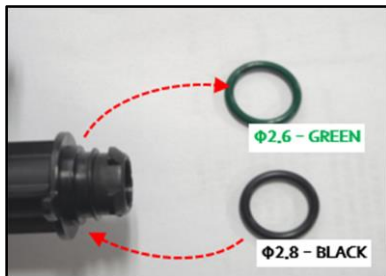

- 5b. Install the removed air filter (G) onto the new auxiliary canister.

**\* NOTICE**

Insert the O-ring and position as shown below.

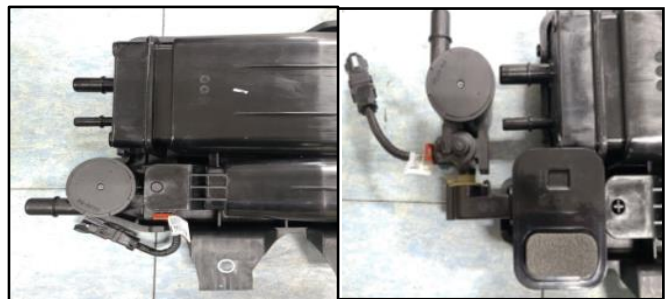
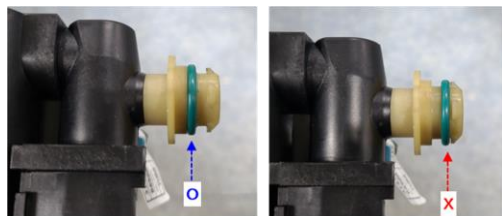

Before

After

- 5c. Re-connect the air filter harness (E) from step 3.

**\* NOTICE**

The wire harness retaining clip (F) from step 3 will no longer be re-attached.

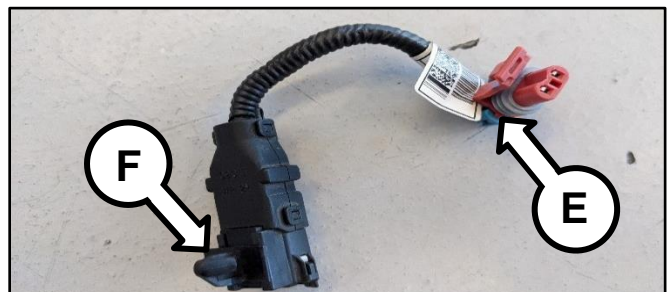

SUBJECT:

## 2.0L T-GDI AUXILIARY CANISTER KIT INSTALLATION (SC201)

6. **On the vehicle:** Cut off 230mm length from the existing ventilation hose (I).

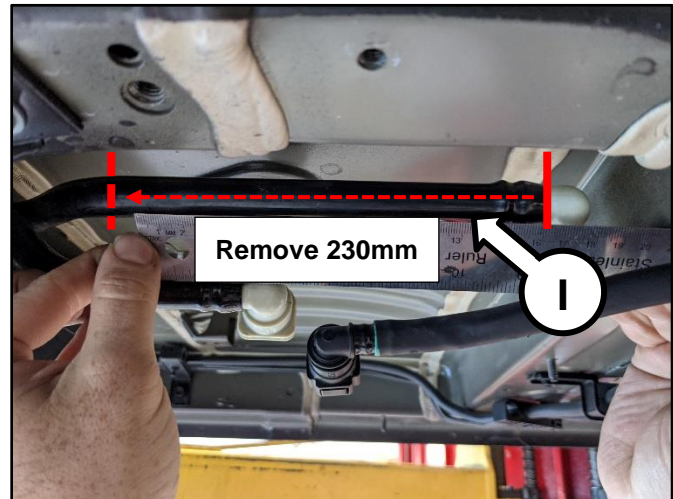

7. Re-install the re-assembled canister back onto the vehicle in the reverse order of removal. Be sure to tighten the three (3) canister retaining bolts (D).

**Note:** Do Not attempt to connect the Fuel Filter ventilation hose (I) at this time.

Note: Image is for reference use only.

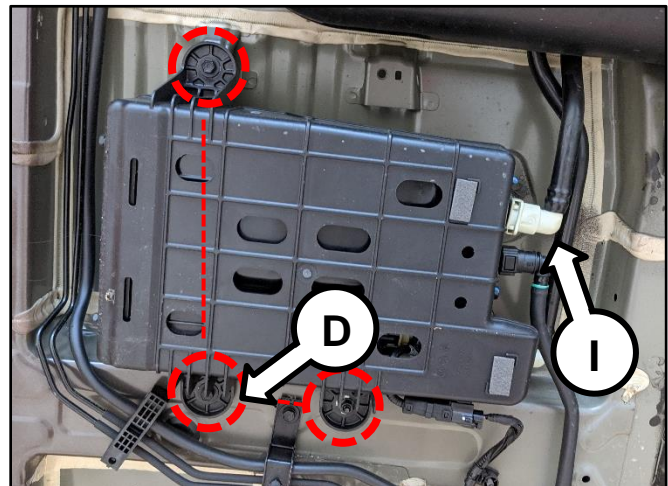

8. Insert the supplied ventilation hose (J) with “yellow” marker over the ventilation hose (I) at least 10mm.

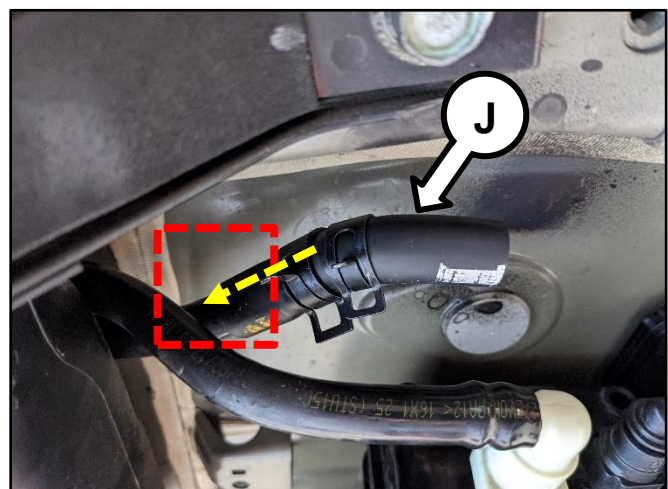



SUBJECT: 2.0L T-GDI AUXILIARY CANISTER KIT INSTALLATION (SC201)

- 9. Insert the other end of the supplied hose (J) with the “white” marker to the fuel filter and secure with provided hose clamps as shown.

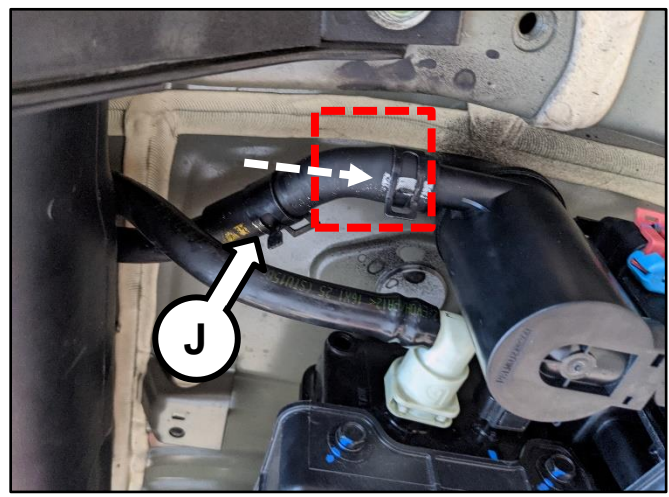

- 10. Connect the CCV connector and ensure to route the harness over the hose as shown.

Note: Use a zip tie to secure in place.

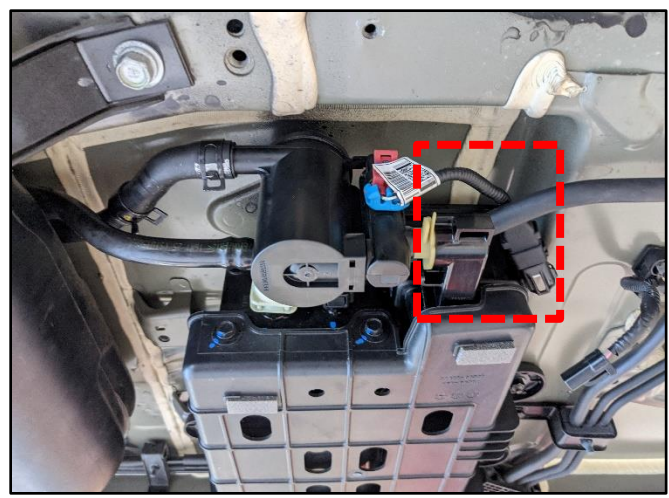

- 11. Locate the vehicle body side member on the RH side of the air filter.

**\* NOTICE**  
Be sure to clean the surface of the side member thoroughly with degreaser and clean cloth.

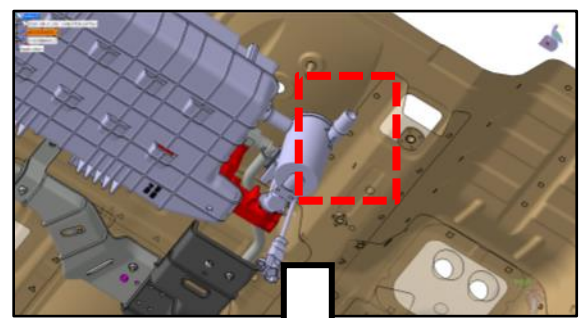

- 12. Peel off the adhesive cover from the pad and adhere the pad (K) to the vehicle body side member (L) to the right of the air filter in the area shown.

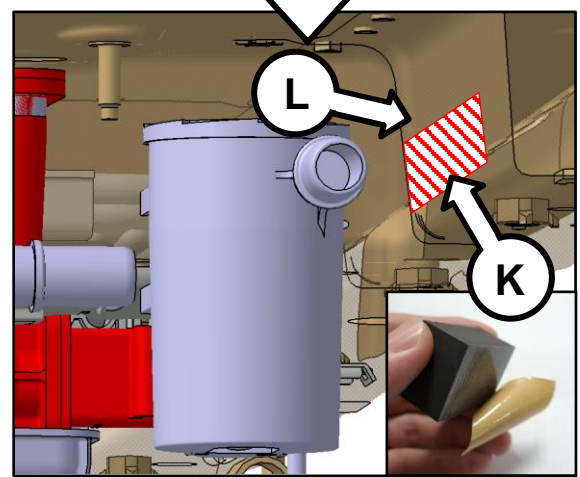

**SUBJECT: 2.0L T-GDI AUXILIARY CANISTER KIT INSTALLATION (SC201)**

**Perform KDS EVAP Leakage Test:**

S/W Management ↶

• EVAP Leakage Test

Purpose	To check the evaporative system and fuel leakage when evaporative system related repair is done or component is replaced.
Enable Condition	<ol style="list-style-type: none"> <li>1. Engine Idle</li> <li>2. No DTC</li> <li>3. Fuel Level : 20-70%</li> <li>4. Battery voltage greater than 11V</li> <li>5. 2 Min after the engine start</li> <li>6. Coolant Temperature : 80°C(176°F)</li> </ol>
Concerned Component	Purge Control Solenoid Valve(PCSV), Canister Close Valve(CCV), Fuel Tank Pressure Sensor(FTPS), Evap. Line
Concerned DTC	P0441, P0442, P0455, P0456, P2422
Fail Safe	Warning Lamp On
Etc	Wait at least 5 min. before re-performing Evap. leakage test.

! Do not touch any system buttons while performing this function.

S/W Management

■ Evap. Leakage Test

• [ Evap. Leakage Test ]

This test is used for functional check of the evaporative system and leakage check.

**Information**

Test completed !

No leak detected.

! Do not touch any system buttons while performing this function.



**SUBJECT: 2.0L T-GDI AUXILIARY CANISTER KIT INSTALLATION (SC201)**

**ATTENTION: THE PROOF OF CORRECTION CARD AND CAMPAIGN COMPLETION STICKER ARE RESTRICTED ONLY TO DEALERS IN THE FOLLOWING STATES:**

California, Connecticut, District of Columbia, Maine, Maryland, Massachusetts, New Jersey, New York, Oregon, Pennsylvania, Rhode Island, Vermont, and Washington. See Parts Information below to order the Proof of Correction Card and Campaign Completion Label from the PDC.

**VEHICLE EMISSION RECALL - PROOF OF CORRECTION CARD**

A Vehicle Emission Recall - Proof of Correction card must be filled out for all vehicles registered in California, Connecticut, Maine, Maryland, Massachusetts, New Jersey, Oregon, Pennsylvania, Rhode Island, Vermont, Washington, New York and Delaware. Residents of these states, who own an affected vehicle, will be required to possess a Vehicle Emission Recall - Proof of Correction card as evidence of voluntary service campaign completion, when they apply for vehicle registration renewal.

**WHAT TO DO WITH THE CARD:**

The Vehicle Emission Recall - Proof of Correction card must be completed by the Dealership's Service Manager using a permanent ink pen. A fine point pen is recommended. When filling in the information, copy the information directly from the vehicle, not the repair order. **ALL INFORMATION MUST BE PRINTED AND NEAT.**

**NOTE: DO NOT COMPLETE THE CARD UNLESS THE SERVICE CAMPAIGN WORK IS COMPLETED.**

The copy of the card shown below indicates the areas to be filled in. Each area must be filled in. The completed card should be given to the owner of the vehicle upon completion of the Campaign and placement of the **Campaign Completion Label** outlined below.

**FILLING OUT AND APPLYING THE CAMPAIGN COMPLETION LABEL (CA and S.177 STATES ONLY):**

The dealer must fill in the Dealer Code and Date information fields on the Campaign Completion Label. Once complete, affix the campaign completion label under the hood of the vehicle, as shown below.

**CA and S.177 States Only:** Apply **SC201** Campaign Completion Label onto the body in the area next to the shock tower, as shown. **NOTE: Be sure to clean the mounting surface to ensure proper label adhesion.**









SUBJECT:

## 2.0L T-GDI AUXILIARY CANISTER KIT INSTALLATION (SC201)

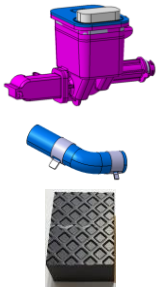
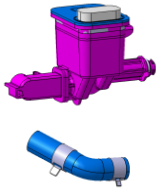
Model	Production Date Range
Sorento (UMa)	October 29, 2014 to November 29, 2017

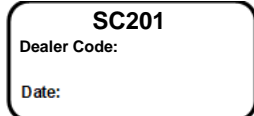
## REQUIRED PART:

Part Name	Description	Part Number	Figure	Qty.
Auxiliary Canister Assy (Kit) <b>Option 1*</b>	Auxiliary Canister (w/black O-ring), Hose, and Pad	31410 B8990QQK		1
Auxiliary Canister Assy (Kit) <b>Option 2*</b>	Auxiliary Canister and Hose	31410 B8999QQK		1
	O-ring (black) and Pad	31121 B8999QQK		
Campaign Completion Label	Label	UT160 SC201**		1
Vehicle Emission Recall Proof of Correction Card	Card	UT161 SC201**		1

**\*Order Auxiliary Canister Assembly (Option 2) kit when ordering. If no Option 2 kits are available, an Option 1 kit may be shipped instead.**

**\*\*Completion Label and Proof of Correction Card only required for vehicles registered in CA, CT, DE, MA, MD, ME, NJ, NY, OR, PA, RI, VT, and WA "States" only.**



**SUBJECT:** 2.0L T-GDI AUXILIARY CANISTER KIT INSTALLATION (SC201)

**WARRANTY INFORMATION:**

**N Code: N99 C Code: C99**

Claim Type	Causal P/N	Qty.	Repair Description	Labor Op Code	Op Time	Replacement P/N	Qty.
R	31420 B8500	0	(SC201) Auxiliary Canister Installation w/ Option 1 kit	210A02R0	0.6 M/H	31410 B8990QQK	1
			(SC201) Auxiliary Canister Installation w/ Option 2 kit	210A02R1	0.6 M/H	31410 B8999QQK 31121 B8999QQK	1

**Refer to Warranty Bulletin 2021-10 for claim submission procedures.**

**\* NOTICE**

**VIN inquiry data for this repair is provided for tracking purposes only. Kia retailers should reference SC201 when accessing the WebDCS system.**