



Technical Journal

TITLE:

Creaking noise, front seat rails

REF NO: US34354.4.0 en-US	ISSUING DEPARTMENT: Technical Service	CAR MARKET: United States and Canada	
PARTNER: 3 US 7510 Volvo Car USA		ISSUE DATE: 2021-03-03	STATUS DATE: 2021-03-08
FUNC GROUP: 8522	FUNC DESC: front seat excl. upholstery	Page 1 of 11	

“Right first time in Time”

Attachment

File Name	File Size
TJI-TJI-514359-1_1_1_en-US.pdf	0.1746 MB

Rows beginning with * are modified

Note! If using a printed copy of this Technical Journal, first check for the latest online version.

DESCRIPTION:

If a front seat makes a creaking noise when a person moves in it or when driving, see method under Service.

* New ending breakpoint. After the breakpoint the guiding pins have a hard plastic sleeve solution. Therefore isolating the metal pins to the edge of the corresponding body holes. This new design can not be used on earlier cars.

CSC Customer Symptom Codes

Code	Description
ZD	Front seat/Squeak/rattle

DTC Diagnostic Trouble Codes



Vehicle Type

Type	Eng	Eng Desc	Sales	Body	Gear	Steer	Model Year	Plant	Chassis range	Struc Week Range
536							2019-2021		0000329-0558100	201746-202108

SERVICE:

Use attached method.

When the new tape is in place, apply grease on top of it. Preferred grease, p/n 1161246. If not available, use any kind of grease. Also use torque order as in attached instruction.

Warranty claim info:

To get warranty claim accepted for a job described in this TJ, please use the attached VST OP number.

VST Operation Number

VST Operation Number	Description
98720-2	Creaking noise, front seats acc. TJ34354

VEHICLE REPORT:

Yes, please submit a Vehicle Report if the service solution described in this TJ has no effect. Use concern area "Vehicle Report" and sub concern area "Support not needed", use function group 8522.

To view TJ attachments continue to next page. This TJ has one attachment.

Volvo Car Customer Service

TJ Instruction VCC-514359-1

Title	Front seat	Page	1 (9)
Action	Product fix	Operation number:	98720-2

Issue	Date	Reason
1	2018-12	First issue
2	2019-06	Technical content change
3	2020-02	Technical content change

Affected vehicles

Model year	Model
2019, 2020,2021	XC40

Materials

Materials	Qty.	Part No.	Notes
Isopropanol	0.1		
Tape	2.0	32288832	
High-pressure paste	0.01	1161246	

Equipment

Designation	Part No.
Putty knife (panel)	

Orientation view

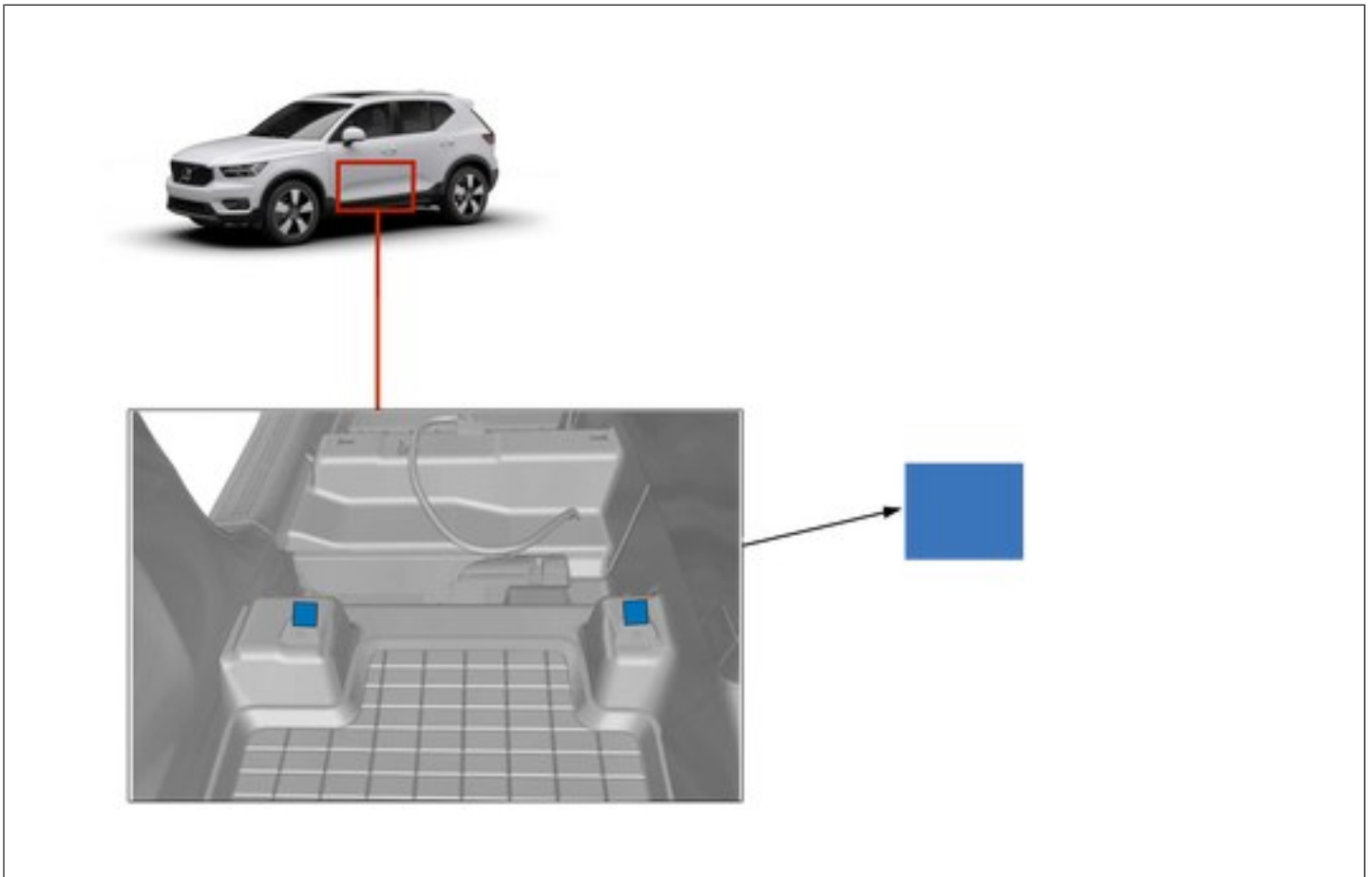

Color symbols

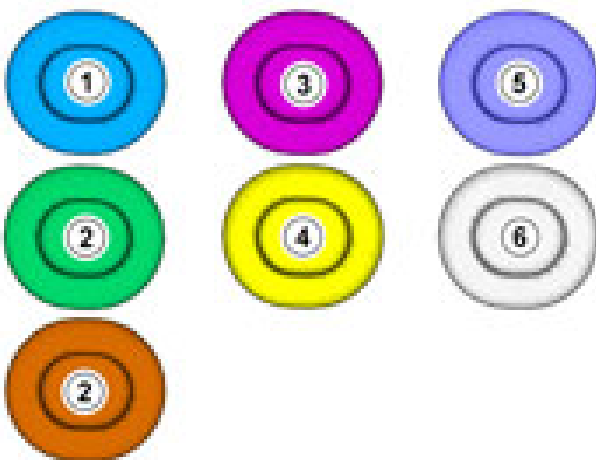

Note! This colour chart displays (in colour print and electronic version) the importance of the different colours used in the images of the method steps.

- 1 . Used for focused component, the component with which you will do something.
- 2 . Used as extra colors when you need to show or differentiate additional parts.
- 3 . Used for attachments that are to be removed/installed. May be screws, clips, connectors, etc.
- 4 . Used when the component is not fully removed from the vehicle but only hung to the side.
- 5 . Used for standard tools and special tools.
- 6 . Used as background color for vehicle components.

Removal

Note! Perform this action only on the side in need of adjustment

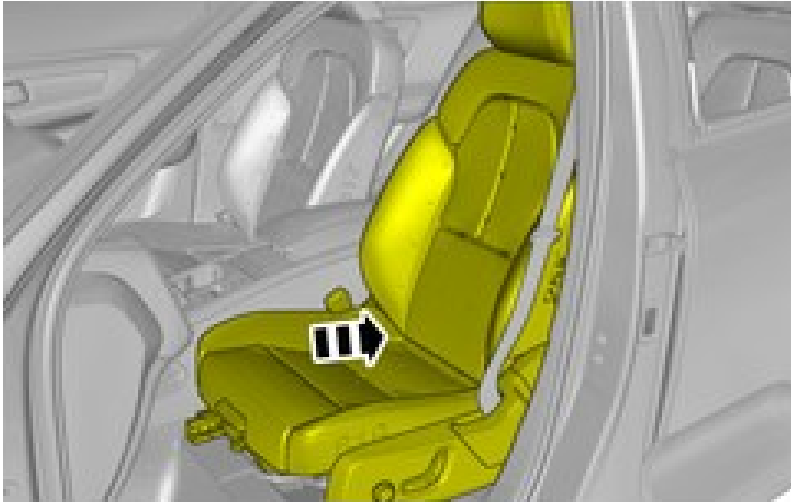

Remove the screws.



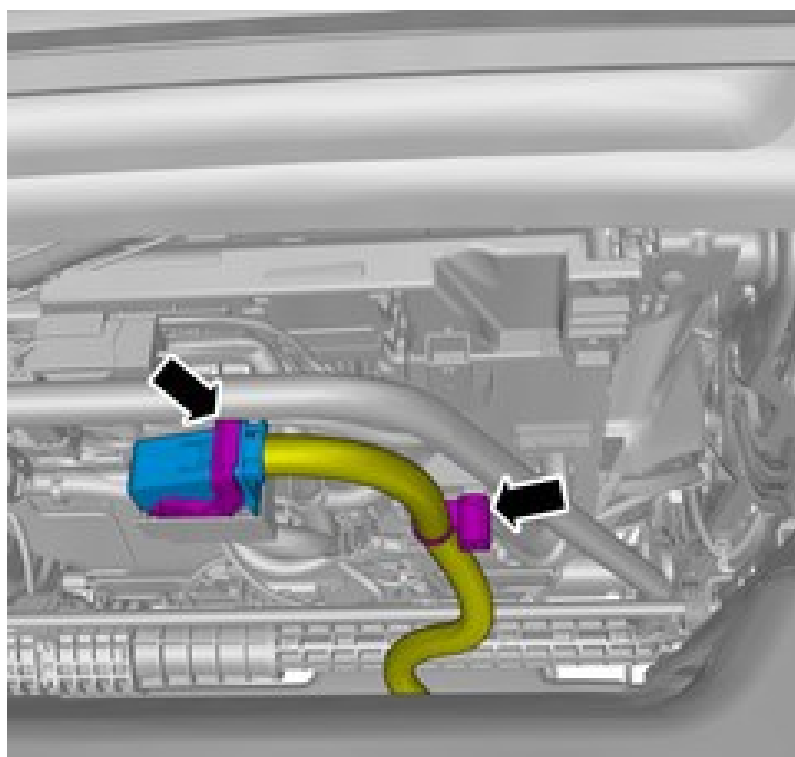
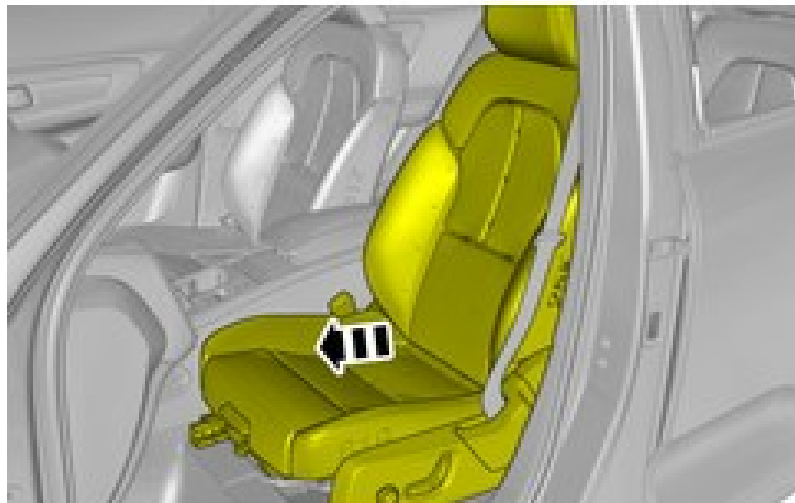

Caution! The number of connectors, cables and cable ties may vary depending on the vehicle specification.

Disconnect the connector.

Loosen the fastener.

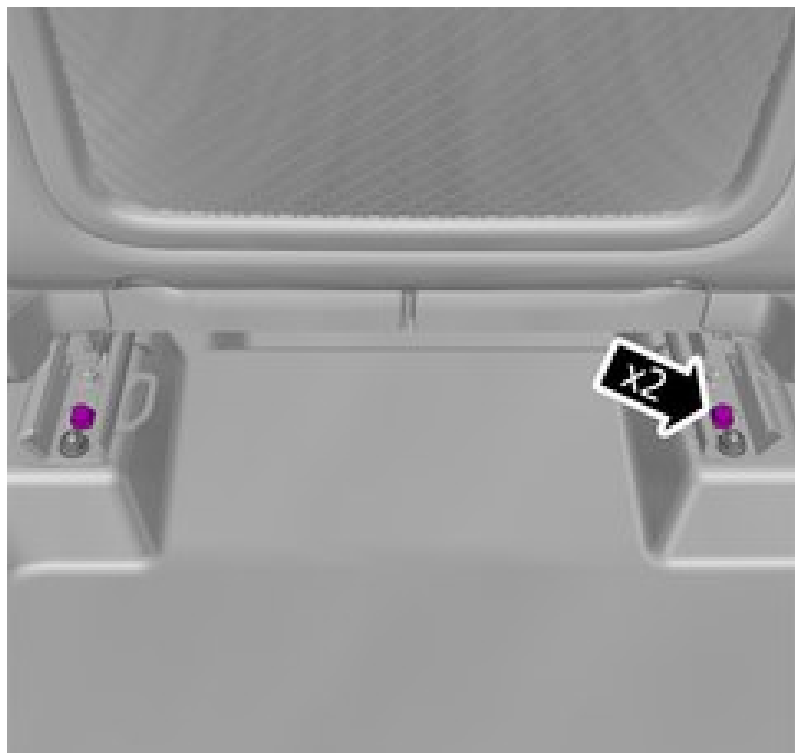

Remove the screws.

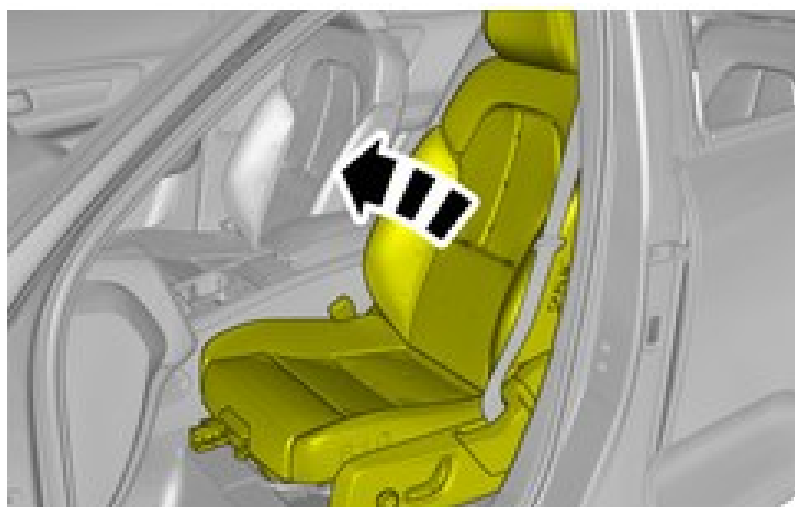

Move front seat forward.

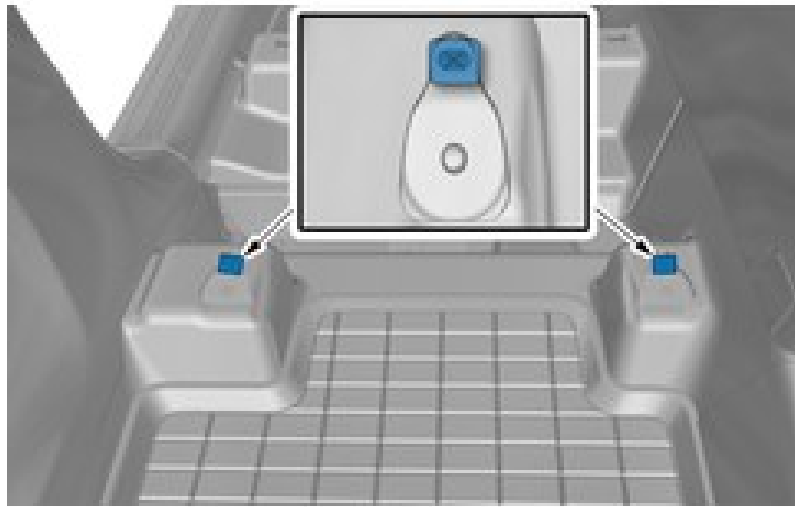

Remove the tape.

Use: Putty knife (panel)

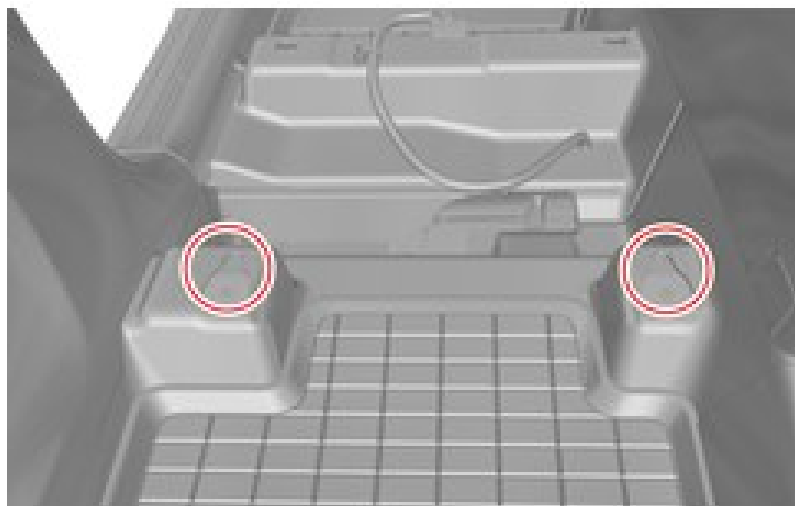

Clean the surfaces.

Use: Isopropanol ,

Installation

Note! Make sure to follow the sequence indicated.

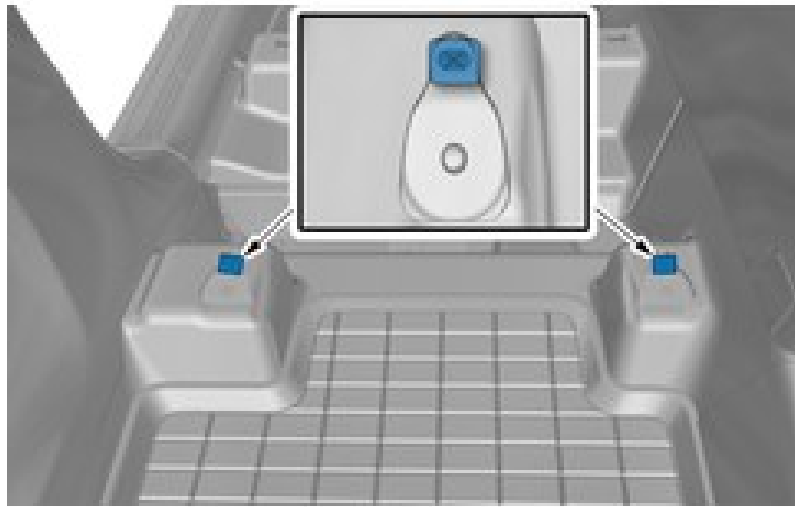

Apply the stated Material on the marked surface.

Use: Tape , 32288832

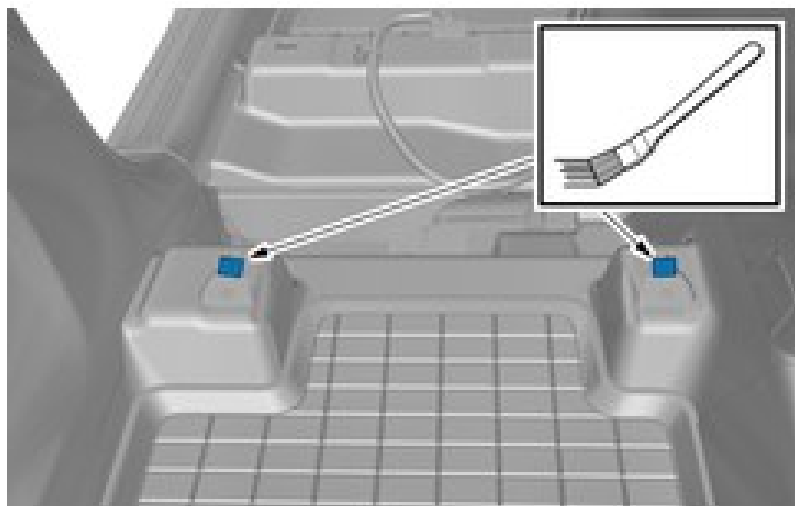

Apply the stated Material on the marked surface.

Use: High-pressure paste , 1161246

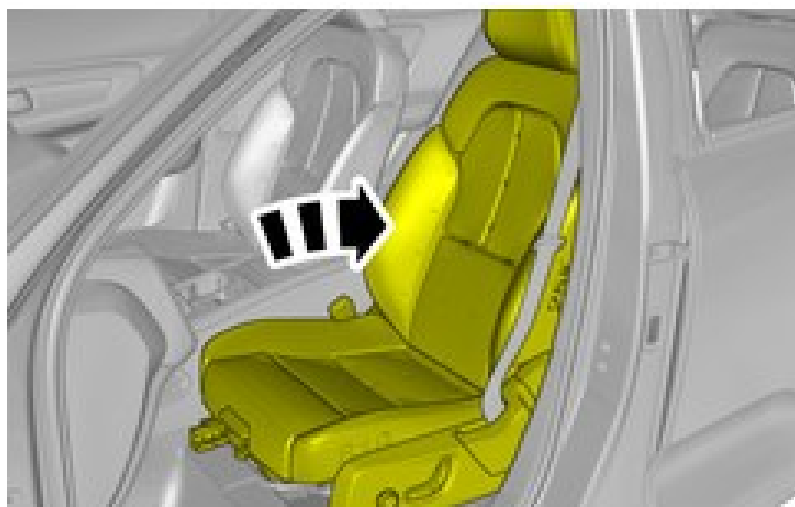

Reinstall the front seat.

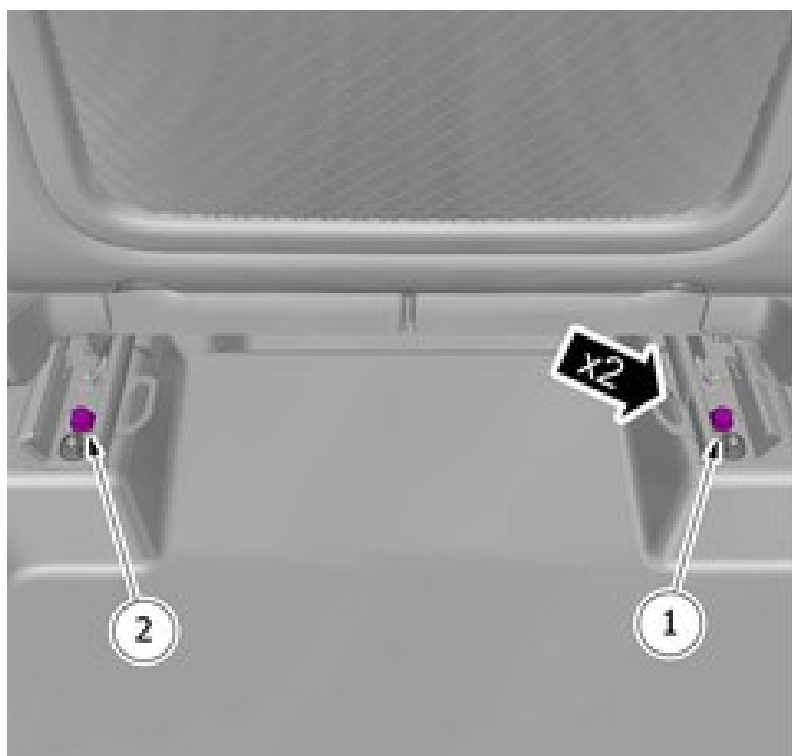

Torque the rear screws.

A figure in a circle denotes the order in which the different stages in the picture are to be carried out.

Torque:

Front seat to body , 40 Nm

Always follow the instruction for tightening torque value.

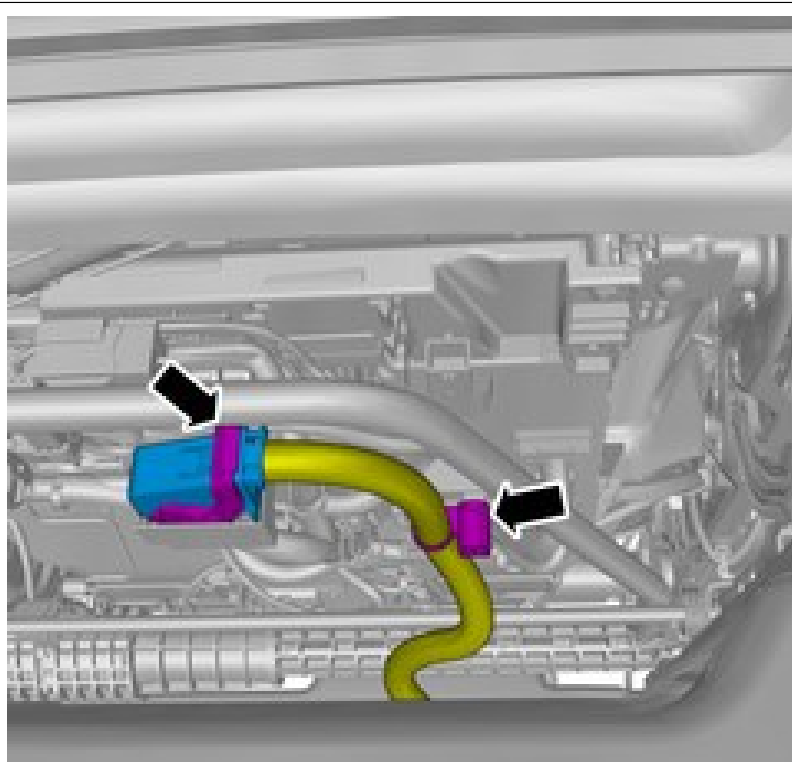

Connect the connector.

Install fastener.

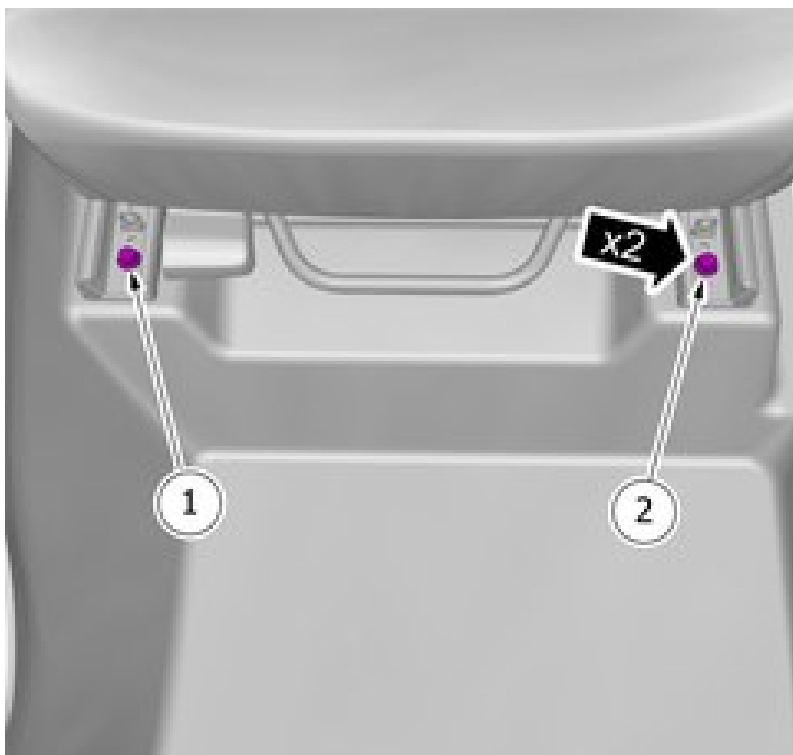
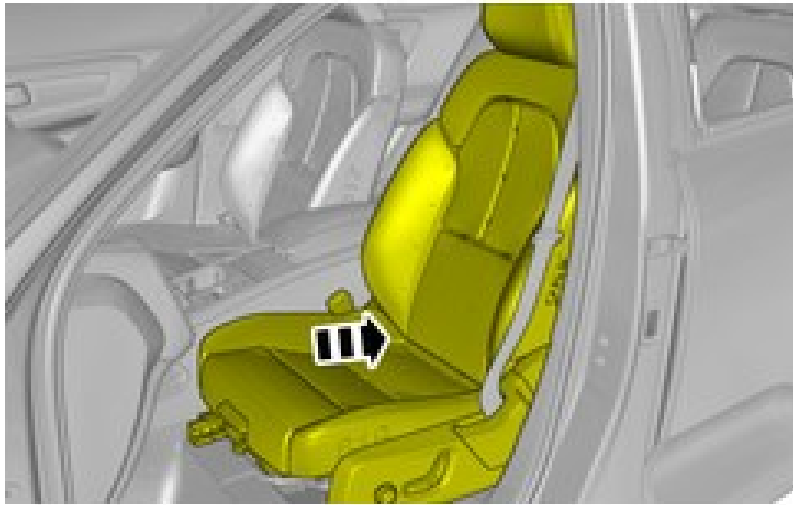

Torque the front screws.

A figure in a circle denotes the order in which the different stages in the picture are to be carried out.

Torque:

Front seat to body , 40 Nm

Always follow the instruction for tightening torque value.