



# SERVICE BULLETIN

Classification:	Reference:	Date:
AT19-002E	NTB19-040E	March 19, 2021

## DTC P0741/4/6, P0776, P0841, P0965, P2857/8/9, P17F0/1/2/4 AND/OR P285A STORED, AND MAY HAVE HESITATION AND/OR REDUCED POWER

This bulletin has been amended. See AMENDMENT HISTORY on the last page.  
Please discard previous versions of this bulletin.

**APPLIED VEHICLES:** 2018-2021 Kicks (P15)  
2020-2021 Versa Sedan (N18)

**APPLIED TRANSMISSION:** CVT

### IF YOU CONFIRM

One or more of the following DTCs is stored:

- P0741 – TORQUE CONVERTER
- P0744 – TORQUE CONVERTER
- P0746 – PC SOLENOID A
- P0776 – PC SOLENOID B
- P0841 – FLUID PRESS SEN/SW A
- P0965 – PC SOLENOID B
- P2857 – CLUTCH A PRESSURE
- P2858 – CLUTCH B PRESSURE
- P2859 – CLUTCH A PRESSURE
- P285A – CLUTCH B PRESSURE
- P17F0 – CVT JUDDER (T/M INSPECTION)
- P17F1 – CVT JUDDER (C/V INSPECTION)
- P17F2 – CVT JUDDER (T/C INSPECTION)
- P17F4 – AUXILIARY GEARBOX (CLUTCH JUDDER)

**NOTE:** The vehicle may also hesitate and/or have reduced power.

### ACTION

1. Refer to the **Repair Flow Chart** on page 2 for CVT repair.
2. Perform Additional Service when replacing a control valve (valve body) on page 19 or when replacing a CVT assembly on page 18.

**IMPORTANT:** The purpose of ACTION (above) is to give you a quick idea of the work you will be performing. You **MUST** closely follow the entire SERVICE PROCEDURE as it contains information that is essential to successfully completing this repair.

Nissan Bulletins are intended for use by qualified technicians, not 'do-it-yourselfers'. Qualified technicians are properly trained individuals who have the equipment, tools, safety instruction, and know-how to do a job properly and safely. NOTE: If you believe that a described condition may apply to a particular vehicle, DO NOT assume that it does. See your Nissan dealer to determine if this applies to your vehicle.

## Repair Flow Chart

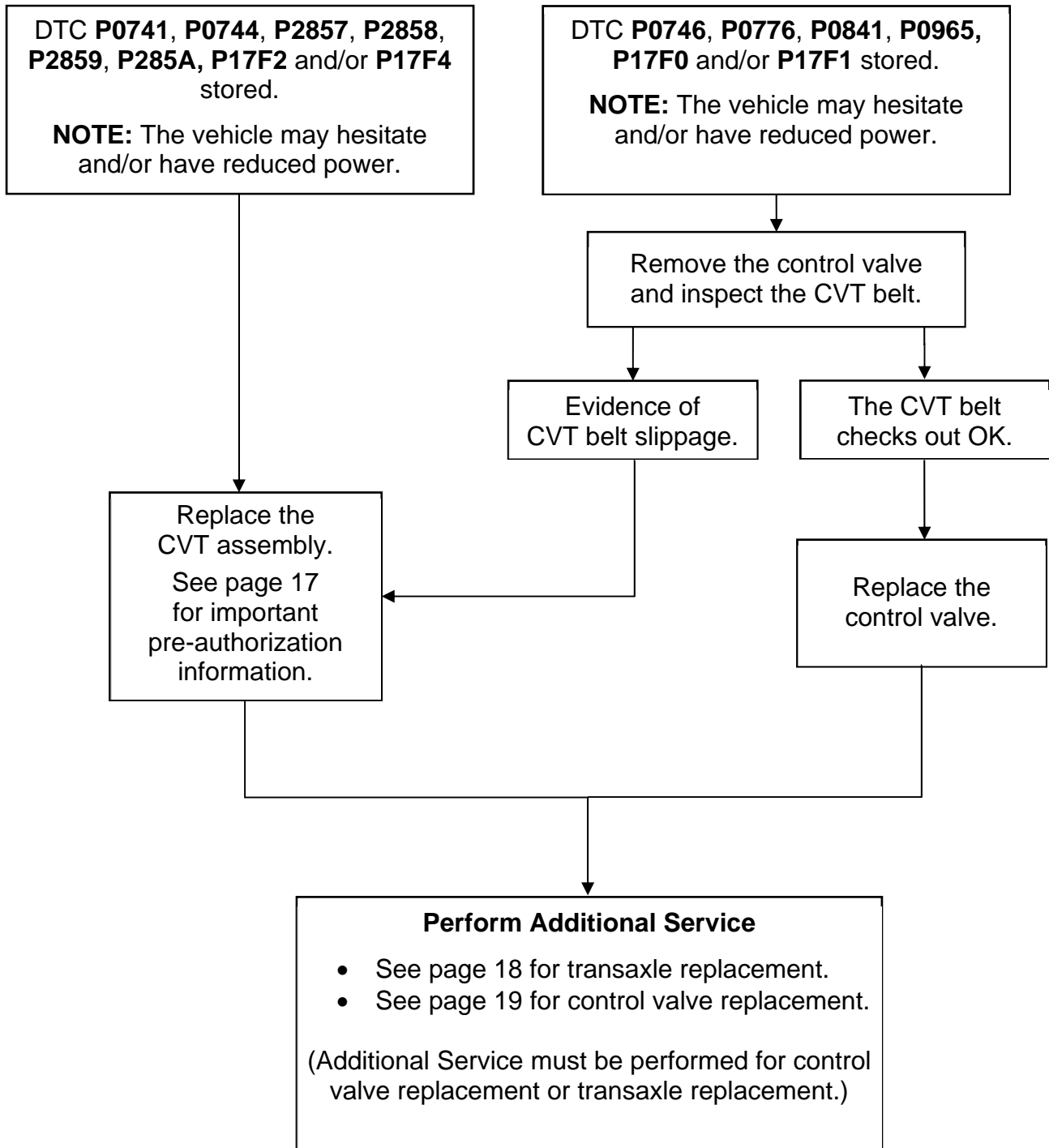

## SERVICE PROCEDURE

### Control Valve Removal

#### CAUTION:

- Never allow any chemicals or fluids other than NS-3 CVT fluid or suitable cleaners to enter the CVT assembly.
- Never allow any foreign debris, dust, dirt, etc. to enter the CVT assembly.

1. Write down all audio presets.

Presets	1	2	3	4	5	6
AM						
FM 1						
FM 2						
SAT 1						
SAT 2/3						
Bass	Treble	Balance	Fade	Speed Sen. Vol.		

2. Place the vehicle on a lift.
3. Before lifting the vehicle, place the transmission gear selector in Neutral.
4. Disconnect both battery cables, negative cable first.
5. Raise the vehicle, and then drain the CVT fluid by removing the drain plug.
  - Remove the engine under cover if needed.

**WARNING:** Use caution when looking into the drain hole as there is the risk of fluid entering the eye.

6. Remove the oil pan mounting bolts, and then remove the oil pan and oil pan gasket.
  - Do not discard the bolts. These will be reused during assembly.

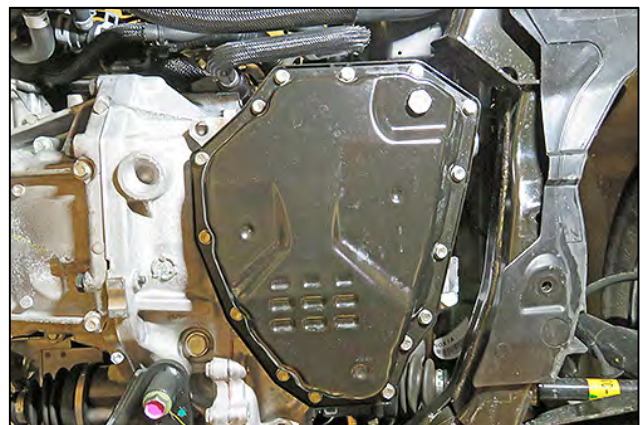

Figure 1

# Exploded View

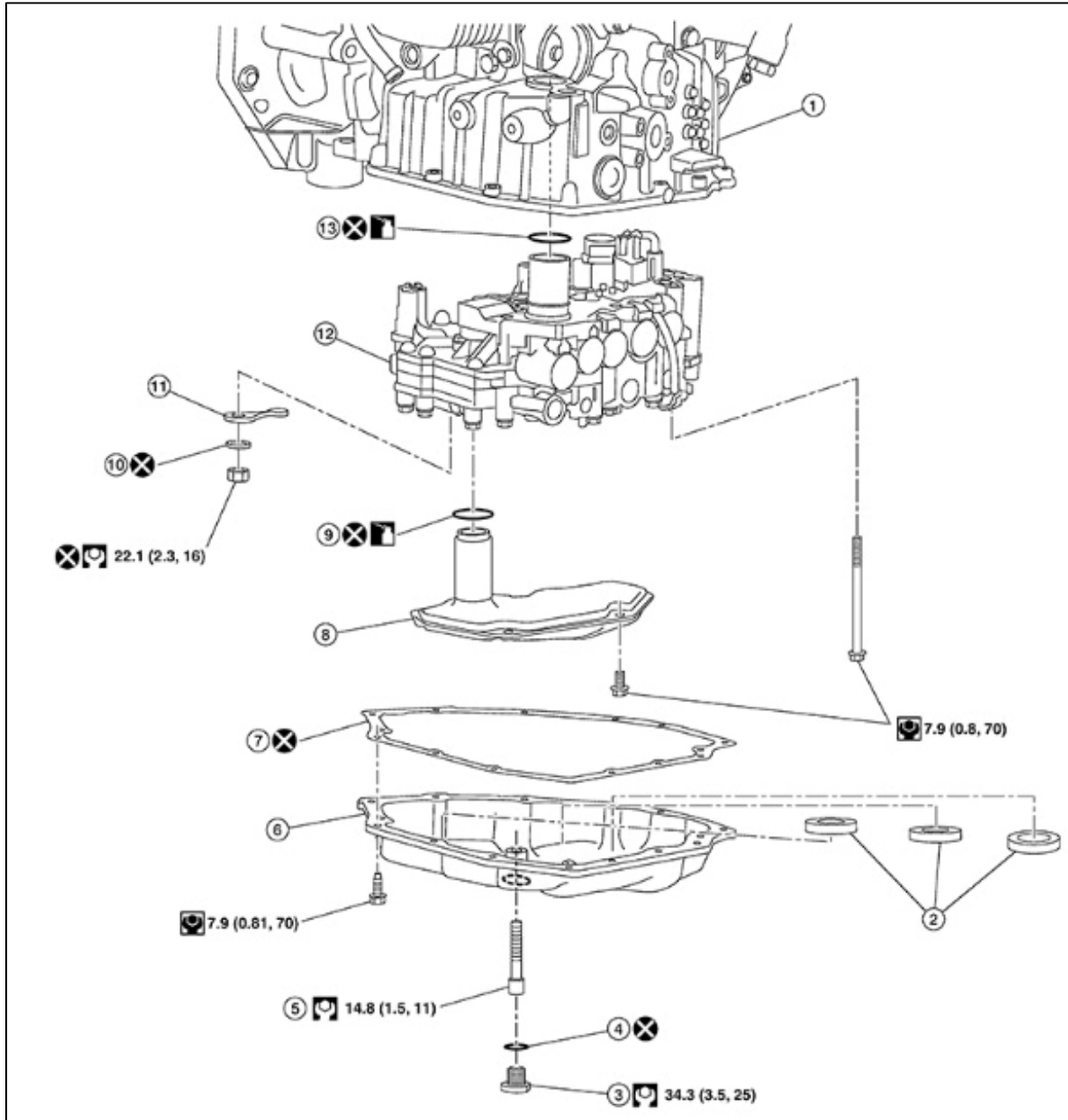

Figure 2

- 1. Transaxle assembly
- 4. Drain plug gasket
- 7. Oil pan gasket
- 10. Washer
- 13. O-ring

- 2. Magnet
- 5. Overflow tube
- 8. Strainer
- 11. Manual plate

- 3. Drain plug
- 6. Oil pan
- 9. O-ring
- 12. Control valve

: Always replace after every disassembly.

: N•m (kg-m, ft-lb)

: N•m (kg-m, in-lb)

7. Remove the three (3) strainer bolts, and then remove the strainer from the control valve.
  - These bolts will be reused.

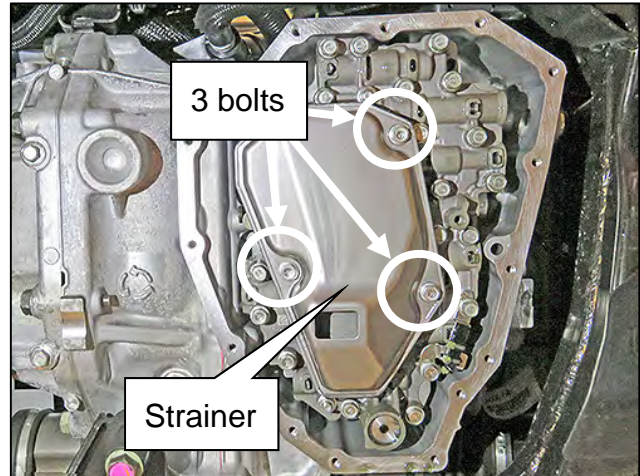

Figure 3

8. Remove the nut and washer, and then remove the manual plate shown in Figure 4.

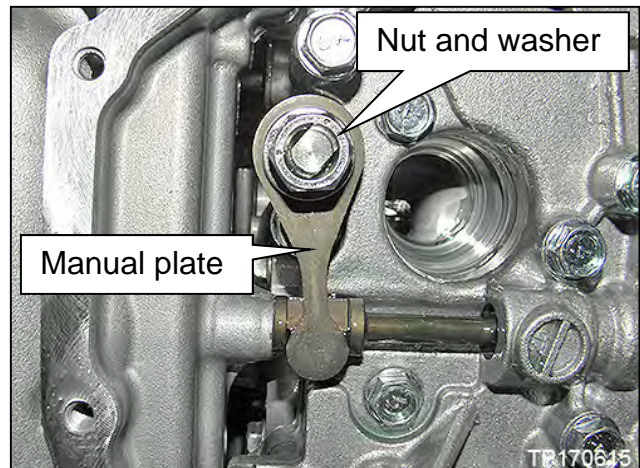

Figure 4

- Use a screwdriver to hold the manual plate (Figure 5). This will prevent the shaft from rotating while removing the nut.

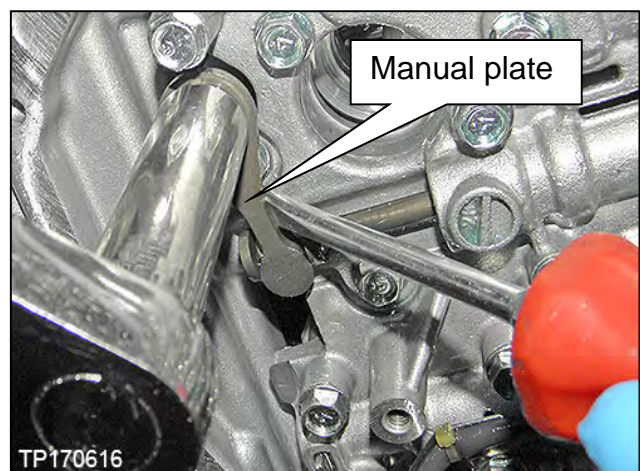

Figure 5



9. Clean around the CVT unit harness connector to prevent foreign materials from entering into the CVT case.
10. Unlock and disconnect the CVT unit harness connector.

11. Remove ONLY the eleven (11) control valve bolts with markings as shown in Figure 6.
  - Remove the bolts with a single dot over the “7”.
  - The bolts removed will be reused.
12. Press the CVT unit harness connector down into the CVT case, and then remove the control valve from the transaxle case.

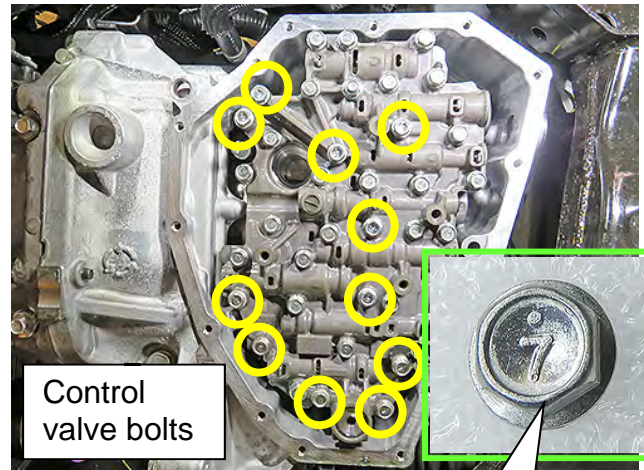

Figure 6

Correct bolt

**CAUTION:** Do not damage the CVT unit harness connector.

## CVT Belt Visual Inspection

13. Secure the front right tire with a suitable strap.
  - This will assist in making the belt turn during the borescope belt inspection step.
14. Mark the front left tire with a suitable marking.
  - This will assure all 360° of the belt is inspected.



Figure 7

15. Using the steps on pages 8-12, inspect the entirety of the two sides of the belt that come in contact with the pulleys (see Figure 8):

### IMPORTANT:

- Reference the pictures on pages 13-16 for comparison.
- Use borescope J-51951 with mirror attachment.
- Be sure to remove the protective film from the mirror before the first use.
- Clean the camera lens and mirror before each inspection. Use 90% isopropyl alcohol and a lens swab from Lens Swab packet J-51963 listed in the Parts Information section on page 20.
- Before inspecting, make sure the batteries in the camera handle and LCD monitor are charged.

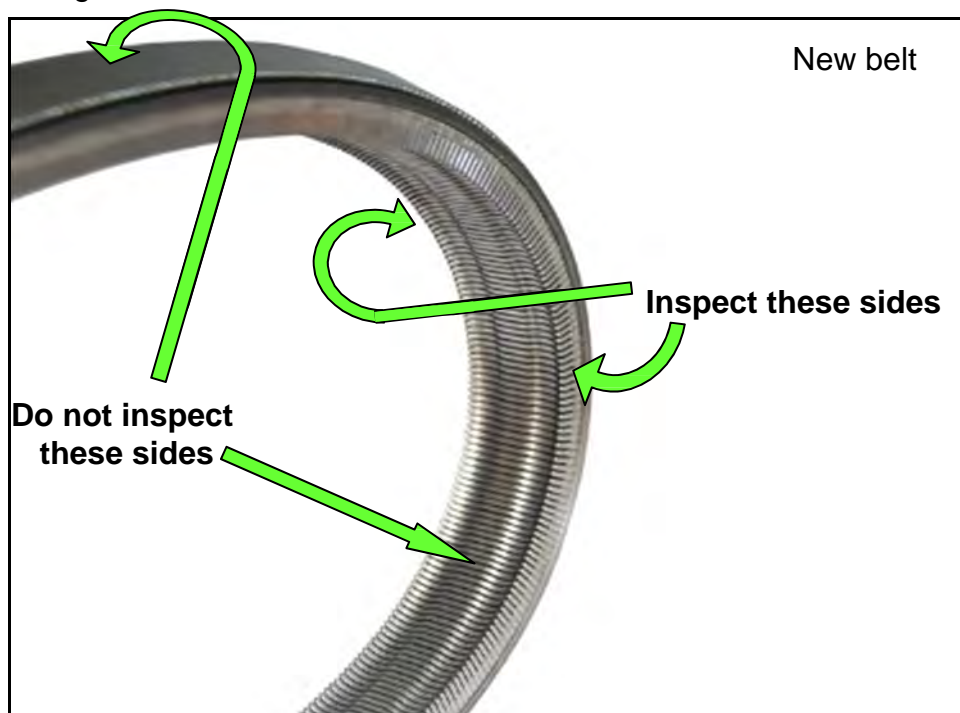

Figure 8

16. Install the Clutch Engagement Tool (J-52273) to the CVT case with two bolts, where shown in Figure 9.

- Bolt torque not to exceed: 2.26 N•m (0.23 kg-m, **20 in-lb.**)

**CAUTION:**

- Do not over torque the bolts. The threads are easily damaged.
- Make sure an O-ring is installed to the Clutch Engagement Tool (J-52273) before installation.

**NOTE:** The O-ring for the Clutch Engagement Tool comes with the attachment. To obtain only the O-ring, refer to the Parts Information section on page 20.

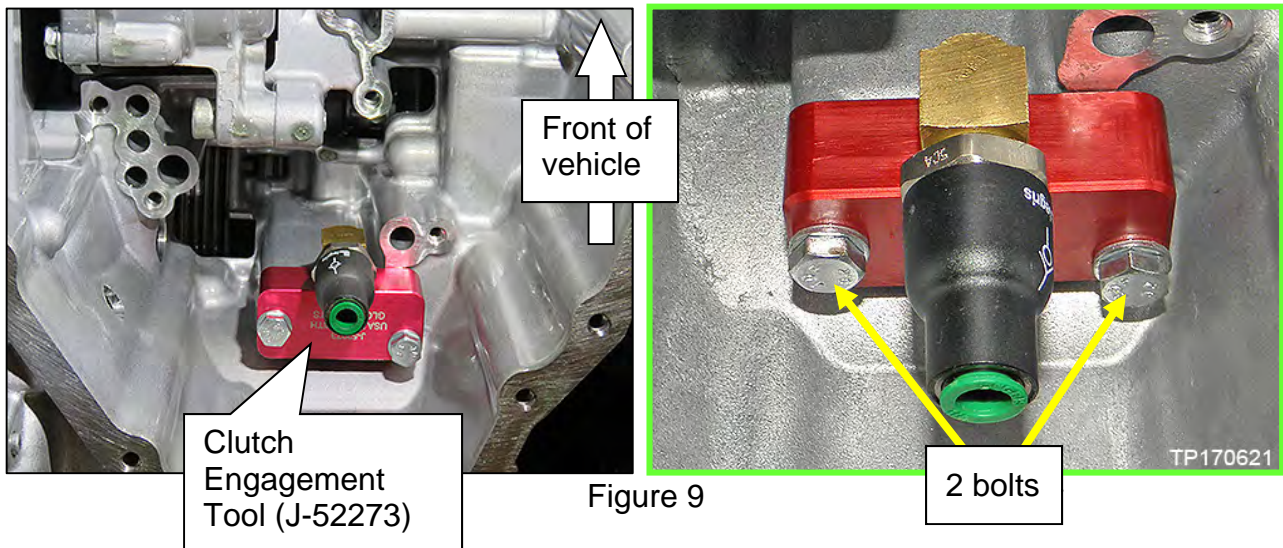

17. Connect the hand pump from the Evap Pressure Test Kit (J-42909) to the Clutch Engagement Tool (J-52273) and pump to 20 PSI.

**IMPORTANT:**

- Proper pressure has been achieved when the CVT belt moves while the left front wheel is rotated and the vehicle is in NEUTRAL with the right front wheel secured.
- Do NOT over pressurize the system as internal damage to the CVT could result.
- The hand pump should be removed from the Clutch Engagement Tool (J-52273) quick connect once the clutch has been engaged and the belt is observed moving with tire rotation.
  - Pressure will be retained.

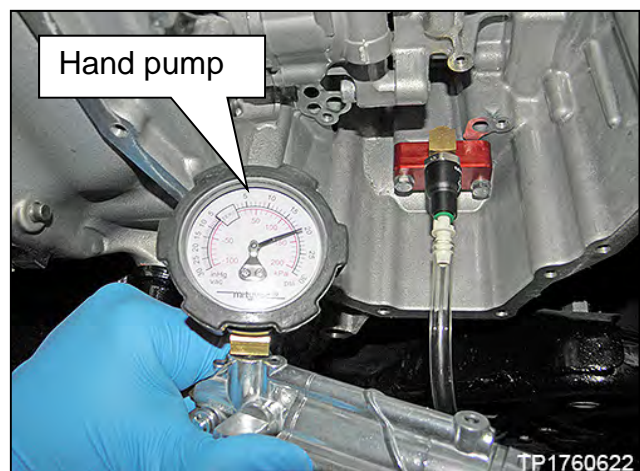



- 18. Insert the borescope where shown in Figure 11 as follows:
  - a. Face the mirror of the borescope toward the driver's side of the vehicle (CVT side cover).
  - b. View the side of the belt that contacts the pulley.

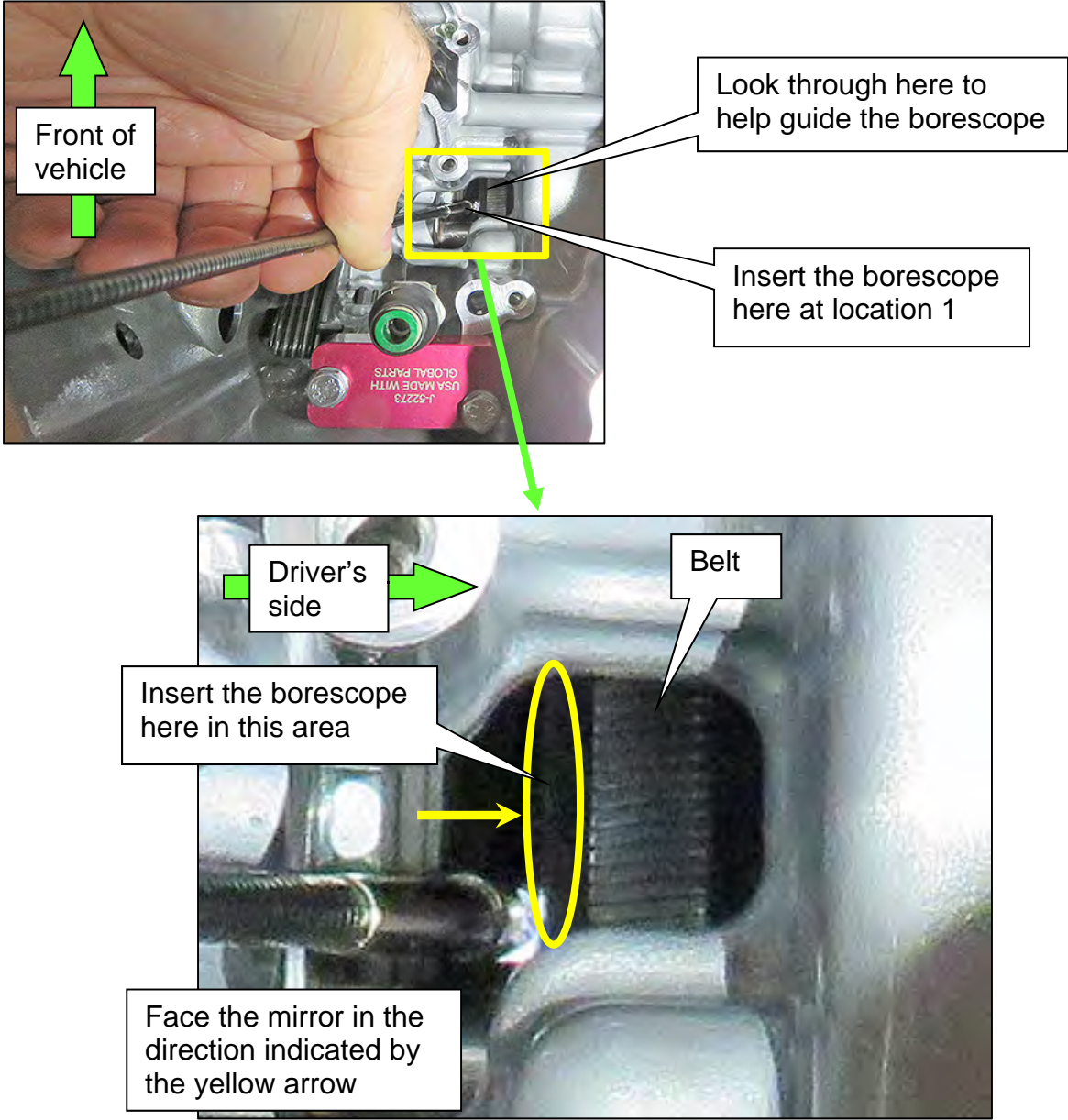

Figure 11

- c. Using the mark applied to the left front tire for reference, slowly and carefully rotate the front left tire one full turn in either direction to view all of the belt.
- Holding the borescope (camera flexible tube) with one hand allows rotation of the tire with the other hand (see Figure 12).



Figure 12

- If no evidence of belt slip is found, proceed to step 19 on page 11.
- If evidence of belt slip is identified as shown on pages 13-16, skip to step 22 on page 17.
- If the belt does not move when rotating the front left tire, return to step 17 on page 8.

- 19. Inspect the other side of the belt as follows:
  - a. Face the mirror of the borescope toward passenger side (engine side).
  - b. Insert the borescope in the second location where shown in Figure 13.
  - c. View the side of the belt that contacts the pulley.

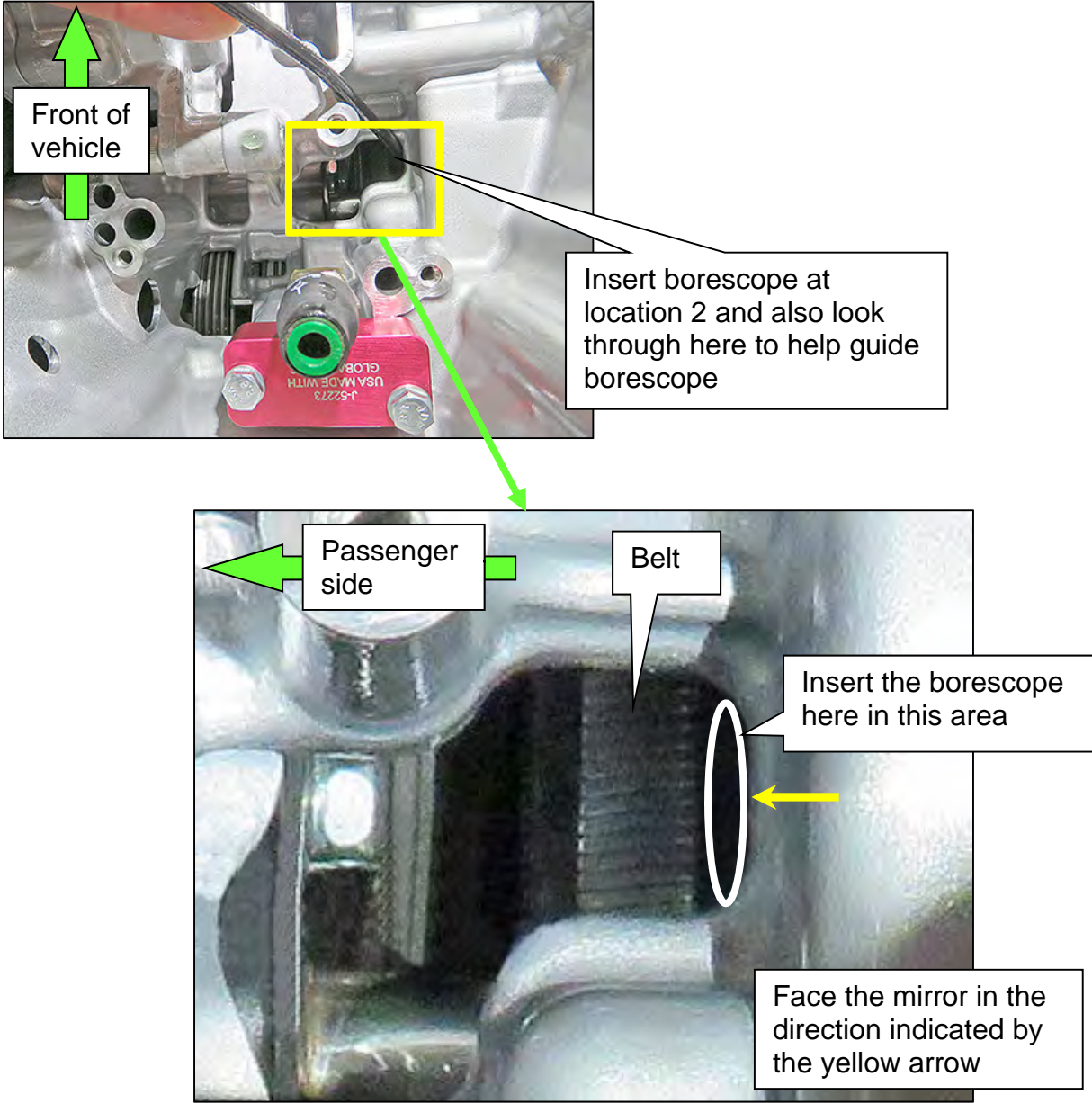

Figure 13

- d. Using the mark applied to the left front tire for reference, slowly and carefully rotate the front left tire one full turn in either direction to view all of the belt.
  - Holding the borescope (camera flexible tube) with one hand allows rotation of the tire with the other hand (see Figure 12).

**IMPORTANT:** If the belt does not move when rotating the front left tire, supply additional air with hand pump (J-45664) to re-engage the clutch as necessary.

- Look for evidence of belt slip as shown on pages 13-16.

20. Remove the Clutch Engagement Tool (J-52273) from the CVT.

**CAUTION:** The remaining CVT fluid may spray when the Clutch Engagement Tool is removed. Place a rag over the Clutch Engagement tool and SLOWLY loosen the two bolts until the audible depressurization is noted.

Proceed to step 21 on page 17.



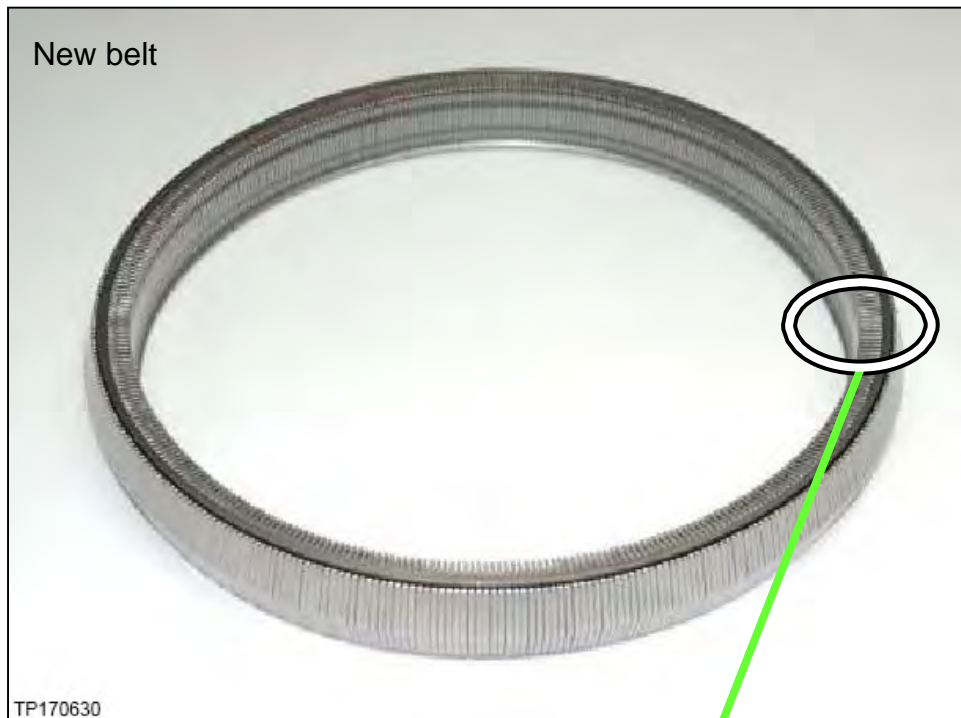

Figure 14

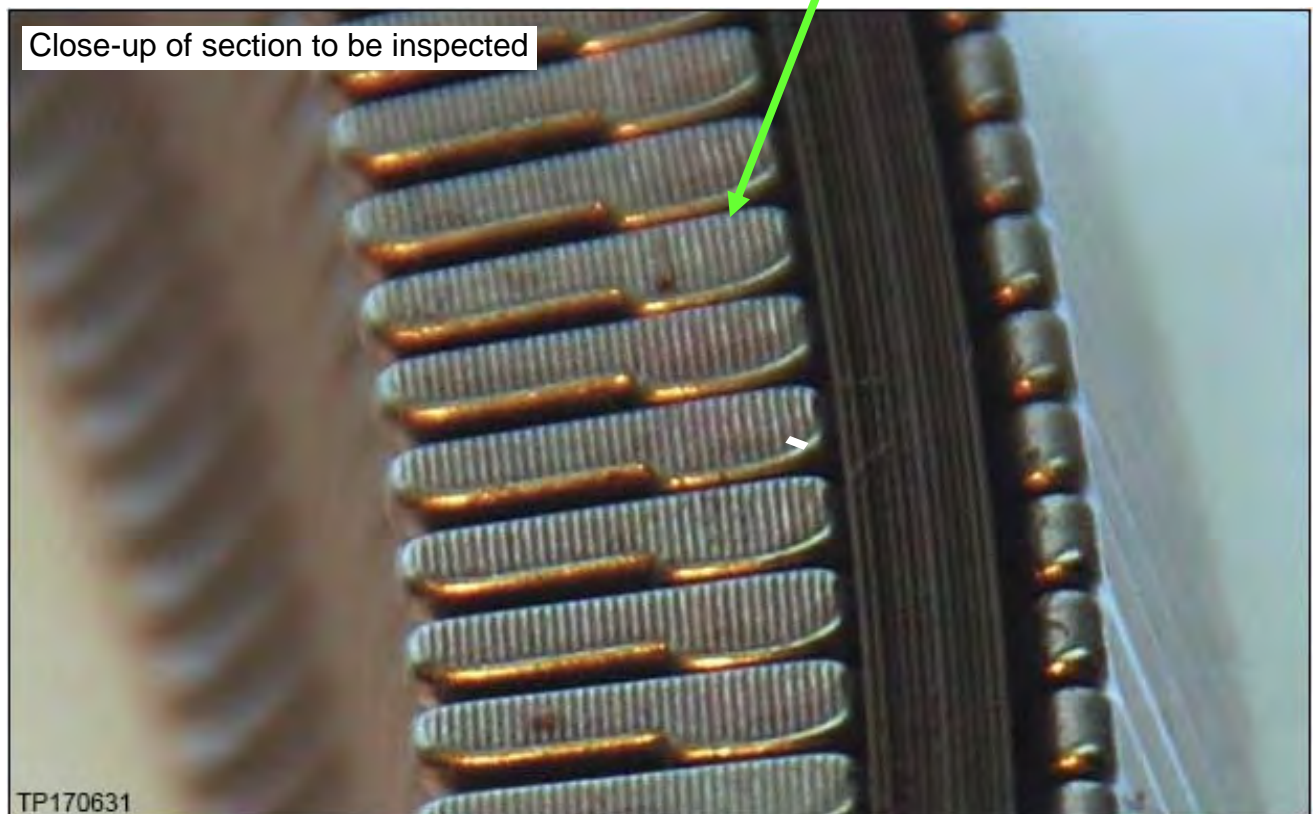

Figure 15

Pictures in Figure 16 and Figure 17 were taken with borescope J-51951.

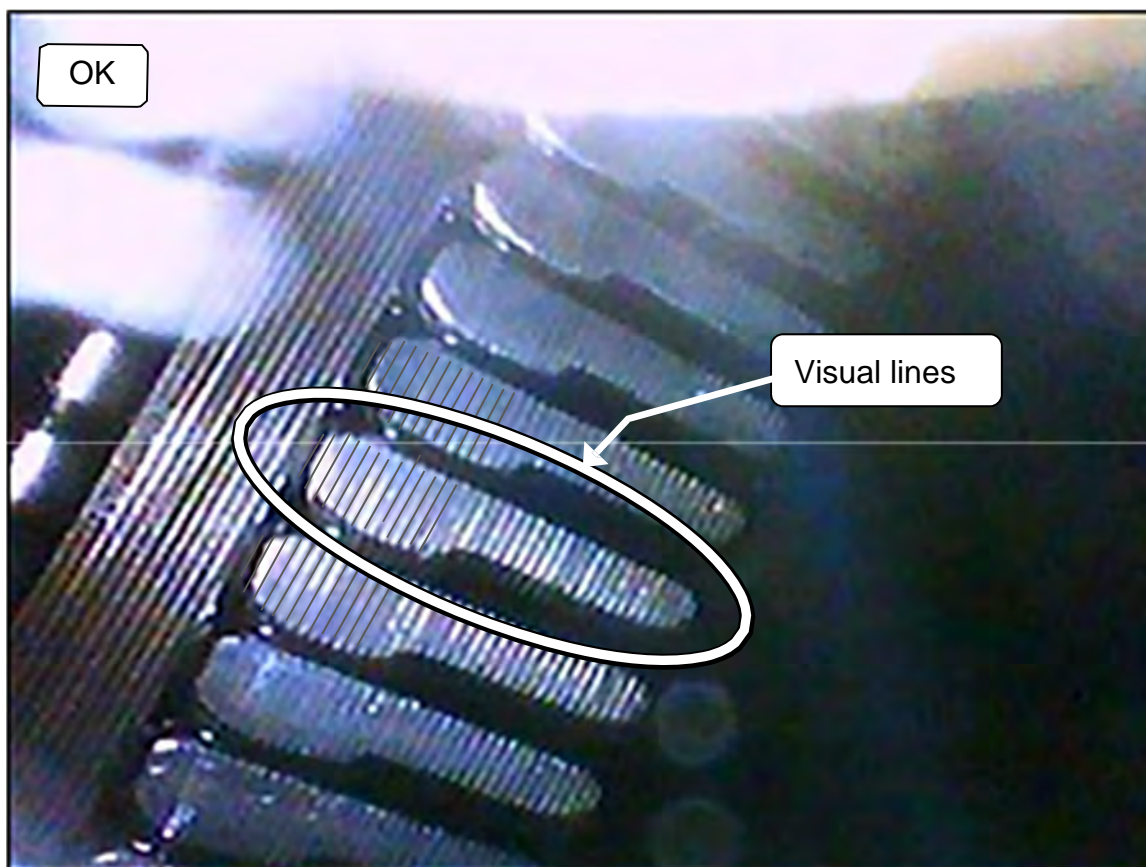

Figure 16

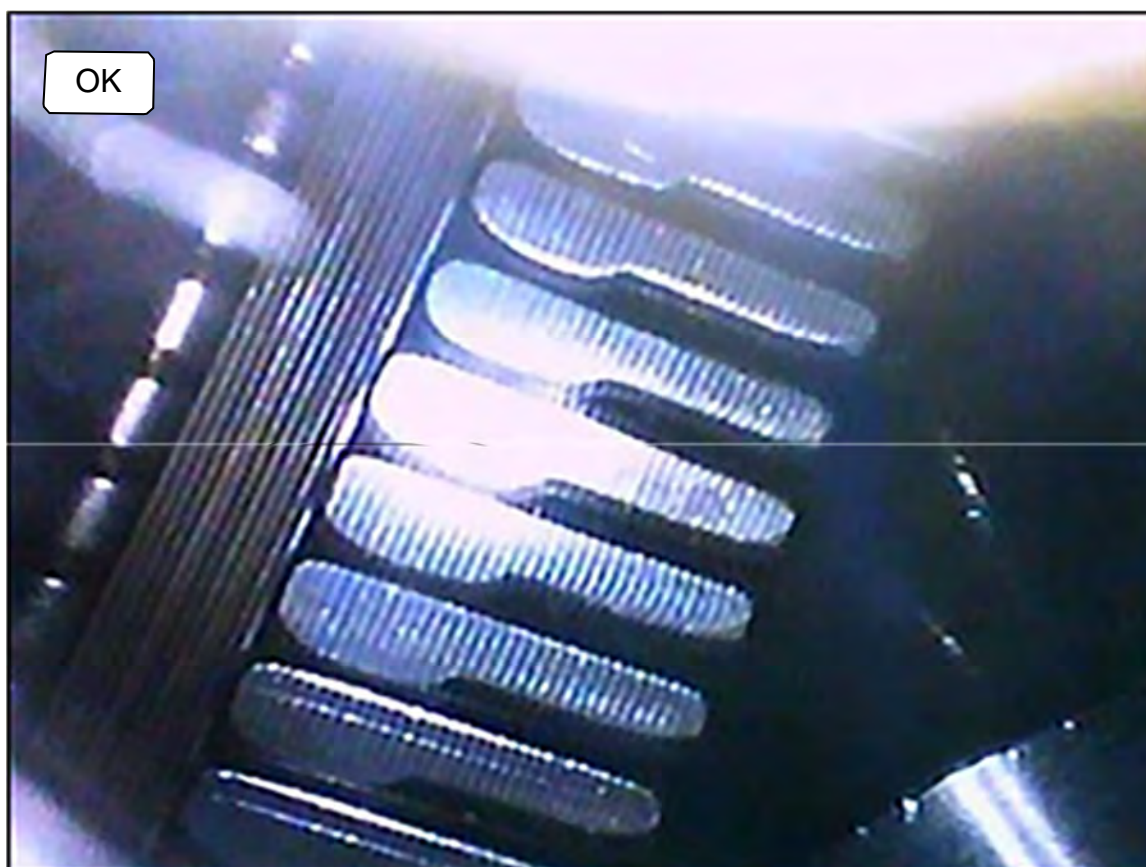

Figure 17



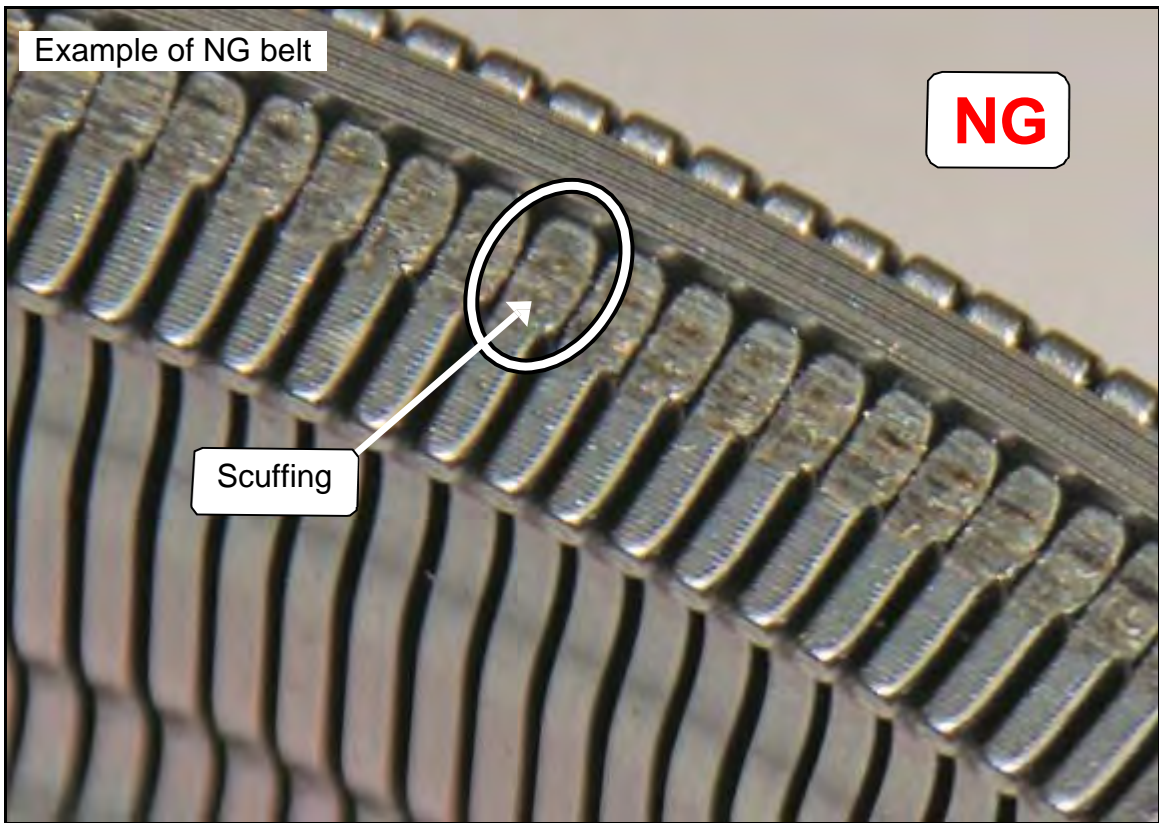

Figure 18

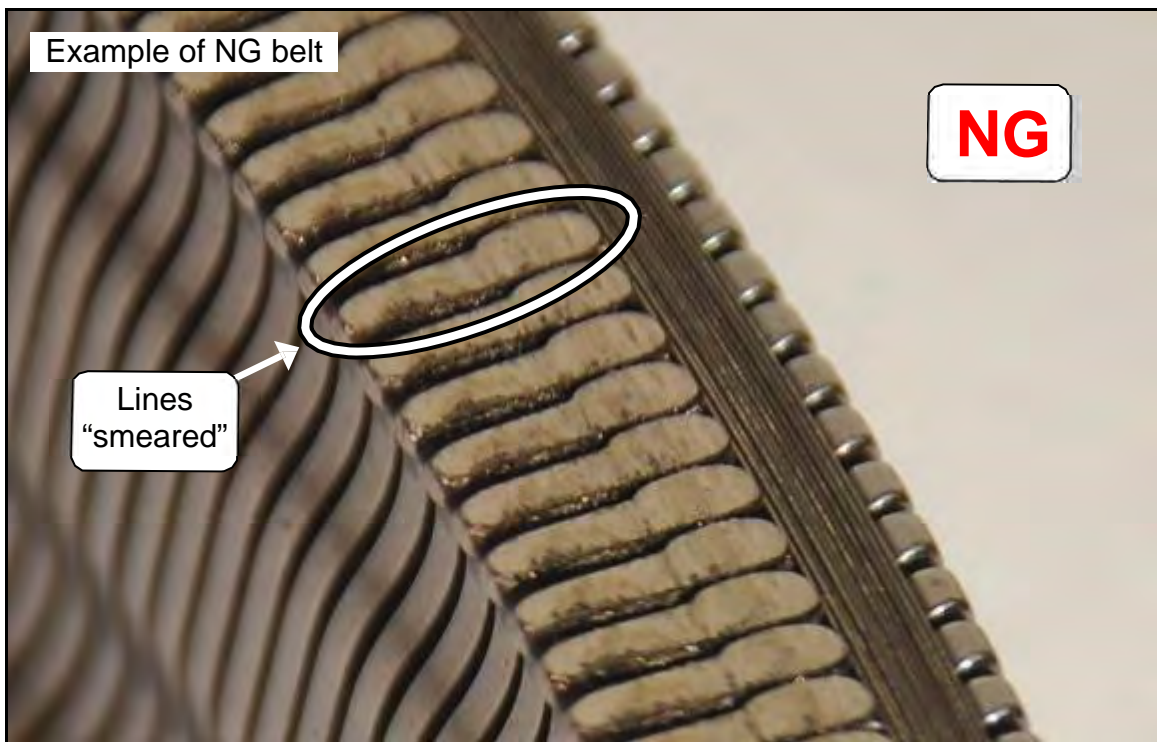

Figure 19

Pictures in Figure 20 - Figure 22 were taken with borescope J-51951

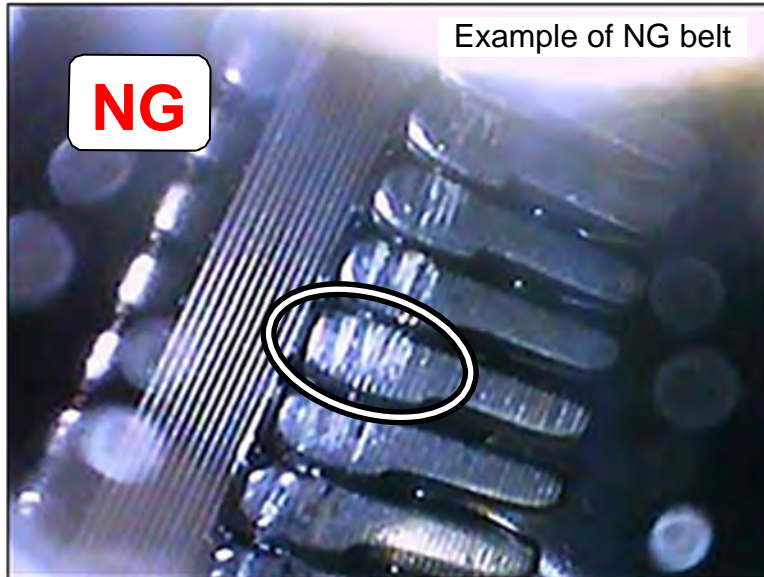

Figure 20

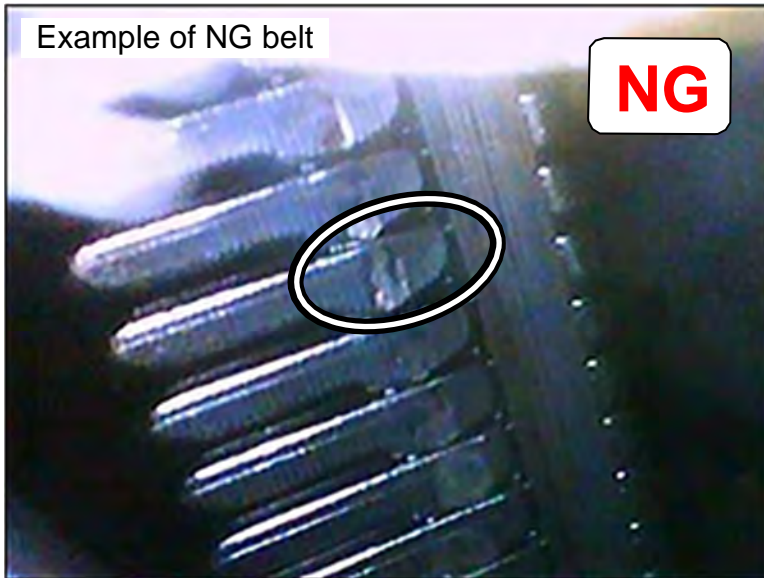

Figure 21

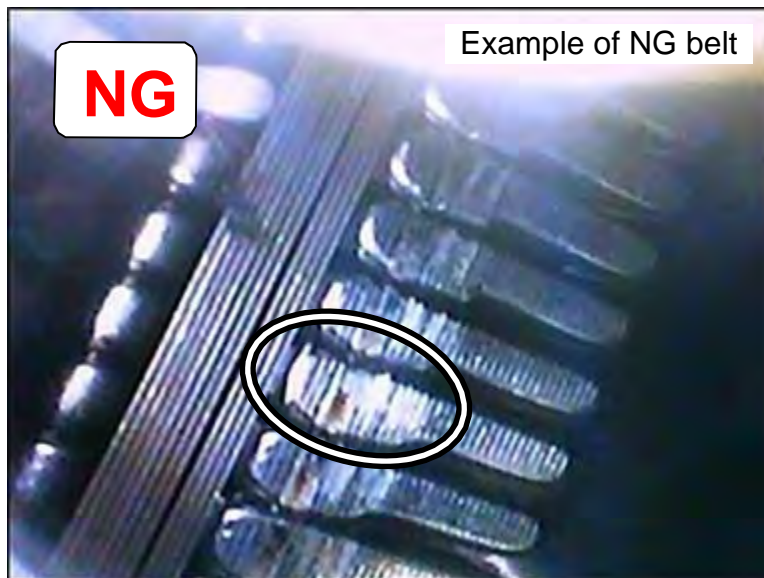

Figure 22



21. Was belt damage found?
  - **NO:** Skip to step 31 and install a new control valve.  
**NOTE:** If no belt damage is present, only the control valve (valve body) will be replaced.
  - **YES:** Proceed to step 22.
22. Re-install the original (removed) control valve, oil pan gasket and oil pan, hand tight.

### CVT Assembly Replacement Approval Procedures

23. Complete the PCC CVT Preauthorization Form in ASIST.

24. If CVT replacement is required based on the inspection results from steps 18 and 19, use borescope J-51951 to record a continuous video, 15 seconds or less, of the most severe evidence of belt slip and the VIN on the F.M.V.S.S. certification label (VIN label). See Figure 23.



Figure 23

**NOTE:** This required video must be attached to the Powertrain Call Center CVT Preauthorization Form (in ASIST) prior to calling for authorization. Failure to submit a continuous video will cause immediate denial of request for replacement.

- Before starting to record, make sure the camera handle's AA batteries are charged and the LCD monitor's battery is charged.
  - The video will show a backward or reversed image when the mirror end is used; this is okay.
  - The required video must show clear evidence of belt slippage and be 15 seconds or less.
25. Call the PCC for authorization at 800-973-9992 (opt 2).

26. Replace the CVT.
  - For the procedure to replace the CVT refer to the ESM: **TRANSMISSION & DRIVELINE > TRANSAXLE & TRANSMISSION > CVT: RE0F11B > UNIT REMOVAL AND INSTALLATION > TRANSMISSION ASSEMBLY.**
27. Connect both battery cables, negative cable last.
28. Fill the Transmission with CVT fluid.
29. Reset/reinitialize systems as needed.
  - For a listing of systems that require reset/initialization after reconnecting the 12V battery refer to the ESM: **ELECTRICAL & POWER CONTROL > POWER SUPPLY, GROUND & CIRCUIT ELEMENTS > BASIC INSPECTION > INSPECTION AND ADJUSTMENT > ADDITIONAL SERVICE WHEN REMOVING BATTERY NEGATIVE TERMINAL.**
  - This list often includes items such as radio, power windows, clock, sunroof, etc.
30. Perform Additional Service when Replacing Transaxle.
  - For a list of additional services, refer to the ESM: **TRANSMISSION & DRIVELINE > TRANSAXLE & TRANSMISSION > CVT: RE0F11B > BASIC INSPECTION > ADDITIONAL SERVICE WHEN REPLACING TRANSAXLE ASSEMBLY.**

## New Control Valve and Strainer Installation

31. Install a new control valve from the Parts Information section on page 20.
  - For the procedure to install the control valve refer to the ESM: **TRANSMISSION & DRIVELINE > TRANSAXLE & TRANSMISSION > CVT: RE0F11B > REMOVAL AND INSTALLATION > OIL PAN, CONTROL VALVE.**

32. Install a new strainer from the Parts Information section on page 20.

- Bolt torque:  
7.9 N•m (0.81 kg-m, **70 in-lbs.**)

33. Remove the magnets from the oil pan.

34. Clean the magnets.

35. Clean the CVT oil pan.

36. Reinstall the magnets to the oil pan in their original positions.

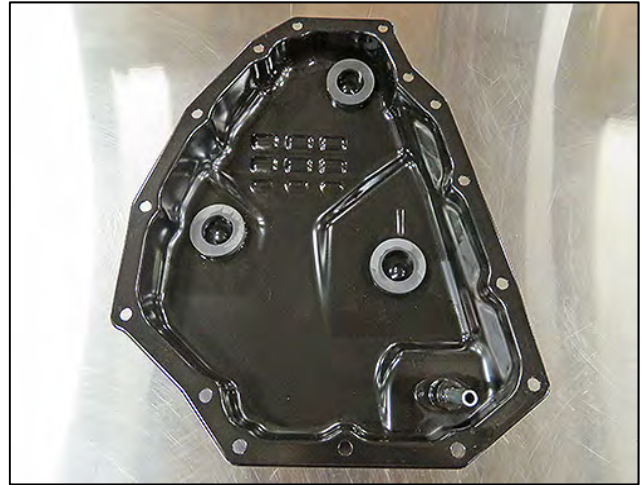

Figure 24

37. Install the original oil pan with a new oil pan gasket using the original bolts.

- Bolt torque: 7.9 N•m (0.81 kg-m, **70 in-lbs.**)

38. Install the oil pan drain plug with a new drain plug gasket.

39. Connect both battery cables, negative cable last.

40. Fill the transmission with CVT fluid.

41. Reset/reinitialize systems as needed.

- For a listing of systems that require reset/initialization after reconnecting the 12V battery refer to the ESM: **ELECTRICAL & POWER CONTROL > POWER SUPPLY, GROUND & CIRCUIT ELEMENTS > BASIC INSPECTION > INSPECTION AND ADJUSTMENT > ADDITIONAL SERVICE WHEN REMOVING BATTERY NEGATIVE TERMINAL.**
- This list often includes items such as radio, power windows, clock, sunroof, etc.

## ADDITIONAL SERVICE REQUIRED

42. Perform Additional Service when replacing the control valve.

- For Additional Service Required Refer to the ESM: **TRANSMISSION & DRIVELINE > TRANSAXLE & TRANSMISSION > CVT: RE0F11B > BASIC INSPECTION > ADDITIONAL SERVICE WHEN REPLACING CONTROL VALVE.**

## PARTS INFORMATION

DESCRIPTION	PART NUMBER	QUANTITY
Kit - Control Valve	3170E-50X5A	1
Kit - Control Valve includes:		
Valve Assembly - Control (Control Valve)		1
Gasket - Oil Pan		1
Strainer		1
Manual Plate Nut	08911-2401A	1
Manual Plate Spring Washer	08915-1401A	1
CVT Assembly (1)	(5)	1
Nissan NS-3 CVT Fluid (2) (3)	999MP-CV0NS3	As needed
Additional Engagement Tool O - Rings (4)	J-52273-1	As needed
Washer-Drain (CVT Oil Pan Drain Plug Gasket)	11026-31X00	1
Lens Swab packet	J-51963	(6)

- (1) If the CVT is being replaced, no other parts in the table above, except NS-3 CVT fluid or equivalent, are needed.
- (2) Nissan NS-3 CVT Fluid can be ordered through the Nissan Maintenance Advantage program: Phone: 877-NIS-NMA1 (877-647-6621) or Website: Order via link on dealer portal [www.NNAnet.com](http://www.NNAnet.com) and click on the "Maintenance Advantage" link.
- (3) For warranty repairs, Nissan NS-3 CVT Fluid **must** be used. For customer pay repairs, Nissan NS-3 CVT Fluid or equivalent is recommended.
- (4) Engagement tool will initially come with 10 O-rings. Additional O-rings are available from Tech•Mate online: [www.nissantechmate.com](http://www.nissantechmate.com) or by phone: 1-800-662-2001.
- (5) Refer to the Electronic Parts Catalog for the correct part number.
- (6) Shop supplies.



## CLAIMS INFORMATION

### If DTC P0741, P0744, P2857, P2858, P2859, P285A, P17F2 and P17F4 stored

Submit a Primary Part (PP) type line claim using the following claims coding:

DESCRIPTION	PFP	OP CODE	SYM	DIA	FRT
Replace CVT Assembly	(1)	JD01AA JD023A	ZE	32	(2)
CVT Trouble Diagnosis		JX22AA			0.5

- (1) Reference the Electronic Parts Catalog and use the CVT Assembly as the Primary Failed Part (PFP).
- (2) Reference the current Nissan Warranty Flat Rate Manual and use the indicated Flat Rate Time (FRT).

### If belt inspection shows signs of belt slip (NG)

Submit a Primary Part (PP) type line claim using the following claims coding:

DESCRIPTION	PFP	OP CODE	SYM	DIA	FRT
Replace CVT Assembly	(1)	JD01AA JD023A	ZE	32	(2)
CVT Belt Inspect - NG		JX36AA			1.1

- (1) Reference the Electronic Parts Catalog and use the CVT Assembly as the Primary Failed Part (PFP).
- (2) Reference the current Nissan Warranty Flat Rate Manual and use the indicated Flat Rate Time (FRT).

### If belt condition shows no signs of belt slip (OK)

DESCRIPTION	PFP	OP CODE	SYM	DIA	FRT
CVT Belt Inspect - OK	(1)	JX37AA	ZE	32	0.4
Replace Control Valve (Valve Body)		JD48AA			(2)

- (1) Reference the Electronic Parts Catalog and use the Control Valve Assembly as the Primary Failed Part (PFP).
- (2) Reference the current Nissan Warranty Flat Rate Manual and use the indicated Flat Rate Time (FRT).

## AMENDMENT HISTORY

<b>PUBLISHED DATE</b>	<b>REFERENCE</b>	<b>DESCRIPTION</b>
May 6, 2019	NTB19-040	Original bulletin published
August 16, 2019	NTB19-040A	PARTS INFORMATION revised, and references to DTCs P0744, P0746, P0841, P0965, P2857, P2858, P2859, P285A added
November 14, 2019	NTB19-040B	APPLIED VEHICLES and PARTS INFORMATION revised. DTC P0741 added, and changes made on pages 3 and 19
April 13, 2020	NTB19-040C	APPLIED VEHICLES and PARTS INFORMATION revised
August 27, 2020	NTB19-040D	DTCs added to page 1 and Repair Flow Chart
March 19, 2021	NTB19-040E	Updated Applied Vehicles to include 2021